



Partial Discharge Tests using the Cigré II method

Casale, M. Di Lorenzo del; Schifani, R.; Holbøll, Joachim

Published in:

I E E E Transactions on Dielectrics and Electrical Insulation

Link to article, DOI:

[10.1109/94.839351](https://doi.org/10.1109/94.839351)

Publication date:

2000

Document Version

Publisher's PDF, also known as Version of record

[Link back to DTU Orbit](#)

Citation (APA):

Casale, M. D. L. D., Schifani, R., & Holbøll, J. (2000). Partial Discharge Tests using the Cigré II method. *I E E E Transactions on Dielectrics and Electrical Insulation*, 7(1), 133-140. <https://doi.org/10.1109/94.839351>

General rights

Copyright and moral rights for the publications made accessible in the public portal are retained by the authors and/or other copyright owners and it is a condition of accessing publications that users recognise and abide by the legal requirements associated with these rights.

- Users may download and print one copy of any publication from the public portal for the purpose of private study or research.
- You may not further distribute the material or use it for any profit-making activity or commercial gain
- You may freely distribute the URL identifying the publication in the public portal

If you believe that this document breaches copyright please contact us providing details, and we will remove access to the work immediately and investigate your claim.

Partial Discharge Tests Using CIGRE Method II

M. Di Lorenzo del Casale, R. Schifani

Dipartimento di Ingegneria Elettrica
Università di Palermo
Palermo, Italy

and J. T. Holbøll

Electric Power Engineering Department
Technical University of Denmark
Lyngby, Denmark

ABSTRACT

In this paper, the results of an experimental project on insulating material aging, performed in both Denmark and Italy, are reported. This study was concerned with partial discharge (PD) behavior at temperatures between 30 and 80°C using CIGRE method II. The material tested was a commercial polymethylmethacrylate (PMMA) which was chosen not for its good dielectric properties but rather because much of its discharge resistance data at ambient temperature is already well documented. A description is given of the theoretical and experimental methodology followed in this work. Mixed Weibull analysis techniques in terms of the PD amplitude and phase distribution characteristics were employed to distinguish the presence of different aging mechanisms. Such a difference was observed at 30 and at 80°C. At 30°C the analysis inferred a single discharge aging process acting until breakdown, while at 80°C the results suggested the predominance of a single the PD aging mechanism for the first half of the insulation life time; however, for the remainder of the insulation life time, an additional degradation mechanism was evinced.

1 INTRODUCTION

AN electrical insulation system is an insulating structure containing one or more electrical insulating materials in contact with associated conducting parts. It is well known that the service life of electrical equipment in many cases is determined by the life of its electrical insulation system and that electrical failure in solid insulation is of the non-reversible destructive type [1]. The quality of an insulation structure in general is estimated by different post-production tests. These measurements also should yield information concerning the insulation life expectancy and its long-term stability. The knowledge of aging processes taking place in insulating materials under actual working conditions could contribute to the assessment of the lifetime of equipment. This is an important factor due to the economic consequences of an unexpected insulation breakdown, the cost of which often can surpass the price of the whole installation. Furthermore, HV insulation in service is usually subjected to several stresses at the same time: thermal, electrical, environmental, and mechanical stresses [2]. These can cause synergistic effects by their simultaneous action and the life expectancy determined from simulated tests where each kind of stress is applied separately, may be misleading.

In 1971, CIGRE Working Group 15-06 established a Task Group in order to concentrate the best efforts in developing a standard method and electrode assembly to facilitate reliable selection of materials in relation to their use in HV equipment. In 1985 [3, 4] CIGRE method II was presented by this Task Group as a proposal for a standard methodology for assessing the resistance of different materials against PD activity with low experimental data scatter in terms of time to breakdown (lifetime) and assuming environmental test conditions equal to the ambient. It may be considered as an improved version of the antecedent CIGRE method I with which many PD tests have been performed at temperatures higher than the ambient [5-7]. Little data can be found in the literature dealing with the effect of temperature on PD activity in connection with CIGRE II, with the exception of Gjaerde's work [8], who studied PD behavior under different temperatures and found some interesting correlation between the void gas pressure decrease and time to breakdown. The majority of the present work is concerned with the study of PD activity under conditions as close as possible to the real working ones, e.g. at temperatures higher than room temperature. In this paper, results are reported from an experimental project developed between the Technical University of Denmark and the University of Palermo, Italy, regarding PD measurements in connection with CIGRE

method II at different testing temperatures.

The material tested here was a commercially available PMMA, characterized by a very low time scatter in its time-to-failure data which were deemed very useful for verifying different PD testing apparatus in Italy and in Denmark as well as to achieve consistency in the experimental results [9]. The testing temperatures were chosen such as not to exceed the material glass transition temperature; the latter was obtained by dielectric spectrometry [10], performed on specimen sheets similar to those used in the PD tests.

In the tests performed until now, the main goal was to establish whether the aging mechanism in the test cell was temperature dependent. This was effected by means of periodical digital acquisitions, during the life tests, of the PD signals at different temperatures and the related analysis. In particular, it was possible to demonstrate that useful information on the discharge mechanism taking place within the air gap, can be obtained by representing the cumulative PD distribution of the acquired data on a Weibull graph [11–13].

2 PD TESTING SYSTEM AND DIGITAL DATA PROCESSING

Both HV measurement systems used in this work can be described schematically as consisting of three main parts, including a HV circuit, with a PD coupling unit in accordance with IEC Publication 270 and ASTM D1868; a measuring circuit, partly analog and partly digital: the digital circuit continuously records the peak values of individual pulses and of the related actual test voltage value during the acquisition time, so that the controller can post-process these data. Following the quasi-integration of the discharge current pulse and after the peak value of the discharge pulse has been captured, a rectangular pulse is generated with a time width equal to that of the analog pulse. During this dead time, analog to digital operations are performed and results are stored in digital form. The above described operations were performed in Denmark by an electronic Robinson apparatus (BRA) discharge detector combined with a digitizing oscilloscope and a digital system comparable to the one reported in [14] and in Italy by a university-built instrument described in [15]. Both systems have different digital resolution, 8 bit in Denmark and 12 bit in Italy. In both cases, the controller and the data processing was performed by the third part, a PC desk computer. The PD quantities recorded were the discharge magnitude in pC (sensitivity = 5 pC) of the single discharge pulse q_i , discharge phase or epoch ϕ_i , that represents the phase position of q_i within the power frequency cycle and the discharge instantaneous inception voltage value V_i , that is the momentary value of the applied voltage at which the discharge q_i occurs.

Based on the foregoing measured discharge quantities, the pertinent probability functions may be deduced. If t_a is the acquisition test time, then it is possible to arrange all the acquired discharge values in an amplitude histogram: number of discharges n_i vs. discharge amplitude q_i either positive or negative. The last distinction is made on the basis of the polarity of the test voltage derivative. Another way to represent the above data, but for positive and negative discharge separately, is to plot them on a Weibull graph as the cumulative probability $F(q_i)$,

relative to the generic q_i amplitude vs. q_i

$$F(q_i) = \sum_{j=1}^i \frac{n_j}{N_t + 1} \quad (1)$$

where N_t is the total number of acquired discharges and n_j the number of the detected discharges in Channel j ($0 \leq j \leq i$) and $0 \leq i \leq N_C$, where N_C is the number of the total channels adopted in the measuring system, including either positive or negative discharge pulses.

Plotting $F(q_i)$ vs. q_i , a diagram is obtained from which it is possible, by a suitable Weibull algorithm, to extract information about the number of discharge phenomena acting within the insulation and to verify whether during the aging process any new type of discharges (e.g. superficial, pitting or other discharges) superimpose upon the previous incipient discharges [16]. This operation is performed on the basis of the number of Weibull functions n_m to which the experimental data can be fitted, e.g.

$$\begin{aligned} F(q) &= \sum_{i=1}^{n_m} p_i F_i(q) \\ &= \sum_{i=1}^{n_m} p_i \left\{ 1 - \exp \left[- \left(\frac{q}{\alpha_i} \right)^{\beta_i} \right] \right\} \\ \sum_{i=1}^{n_m} p_i &= 1 \end{aligned} \quad (2)$$

and where α_i , β_i are the scale and the shape parameter respectively of the generic pulse sub-population present in Equation (2) and p_i is a value of probability suitably chosen for each of these sub-populations.

The other derived quantities evaluated are the mean pulse repetition rate

$$f_{it} = \frac{1}{t_a} \sum_{i=1}^{N_C} n_i \quad (3)$$

and the average total charge magnitude per cycle of the test voltage, separating all the positive and negative polarity discharges

$$Q_{av} = \frac{1}{f t_a} \sum_{i=1}^{N_C/2} q_i n_i \quad (4)$$

where f is the frequency of the voltage source.

3 TEST CELL AND INSULATING MATERIAL

CIGRE method II is the latest standard methodology for assessing the resistance of different insulating materials against PD with low experimental data scatter. The test cell is shown in Figure 1. This system is an improved version of the CIGRE method I and it is characterized by the following features in that the PD resistance of materials can be assessed, a thin sheet specimen may be used, various solid insulating materials may be tested, assembly of the test cell including the test material is comparatively simple, geometrical space of the void is 100 times larger than that of CIGRE method I, and that PD is concentrated in a specified area and will continue until final failure unaffected by the side wall of the cavity.

The spherical HV electrode placed directly on the test specimen ensures an inhomogeneous electric field in the cavity and thereby a high

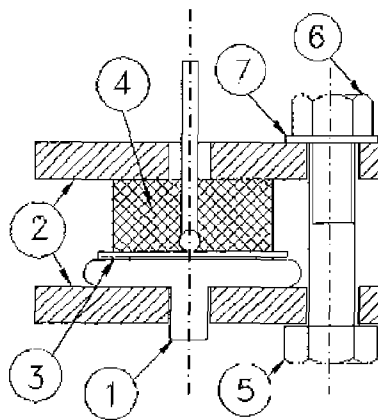

Figure 1. CIGRE method II. 1: plane electrode; 2: acrylic plate; 3: Kapton spacer; 4: molded sphere electrode with a specimen; 5: polycarbonate bolt; 6: polycarbonate nut; 7: nylon washer.

discharge concentration in a limited area on the surface of the test sample. Furthermore, the choice of a large cavity diameter ensures that the discharges can be assumed as being unaffected by boundary effects. This is one of the main reasons for adopting the CIGRE method II electrode system as a standard test electrode for the PD degradation tests. For small-void diameter systems, such as CIGRE method I electrodes, the walls surrounding the void strongly influence and complicate the internal PD process, thereby rendering the interpretation of the test results more difficult. Obviously, the flatness of the specimen sheet and the bottom electrode together with the spacer in the new test cell were decisive for the forming of the calibrated cavity of the CIGRE method II.

As already mentioned in Section 1, the material chosen for this project is a PMMA resin. The PMMA has a relatively homogeneous polymeric structure; the scatter of the time-to-breakdown of PMMA at 30 kV, 50 Hz at 20°C is extremely low (from 10 to 20%) and serves a useful reference [9]. It is widely used in many industrial components for its superior optical properties and weather resistance. High arc resistance makes PMMA suitable for HV applications such as circuit breakers. A decreasing permittivity with increasing frequencies makes it an attractive candidate for high frequency applications. On the contrary, it is not suitable where flammability may be a problem. In order to establish the thermal and environmental constraints, some preliminary tests on the dielectric characteristics of PMMA were carried out. For this purpose, an automatic measuring system for dielectric spectrometry was used in the temperature range from 25 to 100°C at frequencies from 120 Hz to 10 kHz. The results in terms of permittivity ϵ and of dielectric loss $\tan \delta$ as a function of temperature are shown in Figure 2. It is possible to observe and to confirm the decreasing trend of ϵ with frequency, but at 80°C its value was $\sim 25\%$ higher than at ambient temperature. The $\tan \delta$ value is seen to exhibit a dispersed peak over the glass transition temperature region centered between 80 and 100°C. As the temperature increases, the density of PMMA will decrease causing ϵ to fall with temperature. However, in the vicinity of the glass transition temperature, the side link dipoles in the PMMA molecule become free to rotate, giving rise to a dipole loss as well as a very substantial increase in ϵ [17].

On the basis of the above results, it was decided to limit the highest

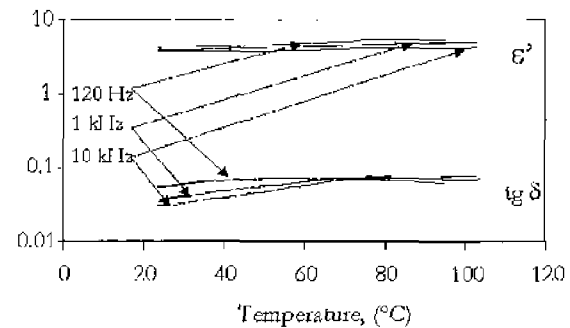

Figure 2. Dielectric spectrometry results on PMMA.

test temperature in the PD tests to 80°C, while for ambient temperature, the value of 30°C was selected in order to take into account the climatic differences between Denmark and Italy. During the experiments, the cell was immersed in a silicone oil bath with constant temperature in order to avoid external corona phenomena. The cylindrical cavity was therefore sealed by a suitable epoxy resin cured at ambient temperature that exhibited a very high adhesion capability at high temperatures.

4 ANALYSIS OF EXPERIMENTAL DATA

The PD measurements were performed to examine the dependence of discharge activity upon temperature. On the basis of the results obtained with dielectric spectrometry and PD life tests on the same material that were reported in [9], it was decided to follow two separate test protocols in order to obtain additional data on the temperature dependence of the PD process.

4.1 TESTS IN ITALY

In Italy the test procedure consisted of a step voltage test in steps of 5 kV from 15 to 30 kV, performed at 30°C and a step temperature test, from 30 to 80°C, under constant voltage of 30 kV. All PD measurements were made 1 h after the voltage application across the specimen. At this particular time, they are considered as having been performed on virgin specimens *i.e.*, not subjected to significant aging. It should be emphasized that the 30 kV voltage level in the life tests was adopted as a result of a compromise between the expected variation in the time to breakdown, and its average time to breakdown value, which exhibits an acceptable value as far as laboratory test procedure is concerned.

The test time sequence adopted in the step voltage test is sketched in Figure 3(a). The time interval between two consecutive measurements is 30 min and the acquisition time t_a of the measuring circuit is 30 s. In Figure 4, the results of a typical test performed on one of five specimens at 30°C are reported. These are presented as amplitude histograms of positive and negative discharge amplitudes. Their shape, for test voltages between 15 to 30 kV, does not appear to change with the applied voltage. The maximum discharge number, however, does change. Numerical evidence for the above PD behavior with voltage is obtained when the acquired data is analyzed using Weibull statistics; this is shown in Figure 5, which gives the α and β coefficients for the positive and for the negative discharges. Only a single Weibull distribution in both cases can be recognized, because the experimental

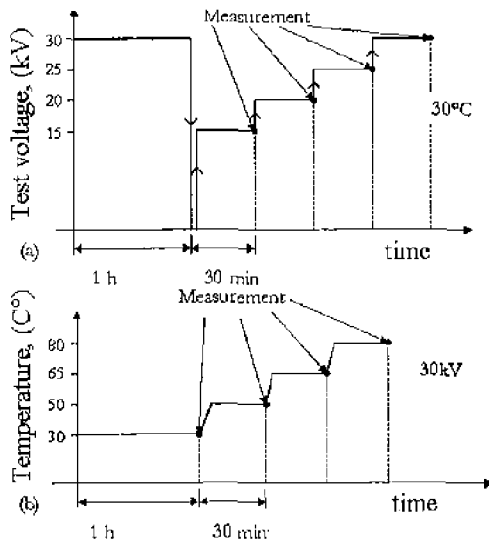

Figure 3. (a) Step voltage test at 30°C. (b) Step temperature test at 30 kV.

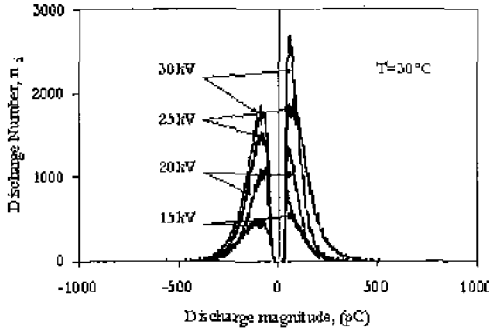

Figure 4. Discharge amplitude distributions at different voltage levels for $T = 30^\circ\text{C}$.

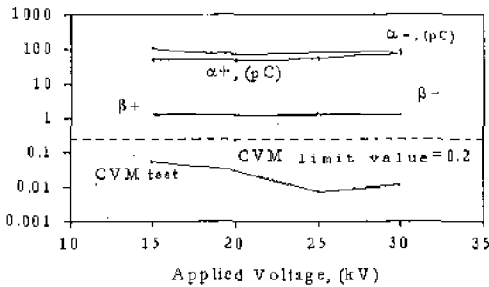

Figure 5. Values of scale and shape parameters fitting the PD data of Figure 5, as function of test voltage. Positive (+) and negative (-). The CVM variable also is reported for positive discharges.

data can be fitted to Equation (2) with $n_w = 1$. The goodness of fit to a Weibull distribution usually is checked by the Cramer von Mises (CVM) test [12]. This test essentially is based on the evaluation of a sort of root mean square deviation between the experimental data and those fitted by the Weibull distribution. Since the discharge activity is very similar for both polarities, the result of the CVM test is shown only for the positive discharges; it is seen to exhibit always a value much lower than its test passing limit value, assumed here to be equal to 0.2.

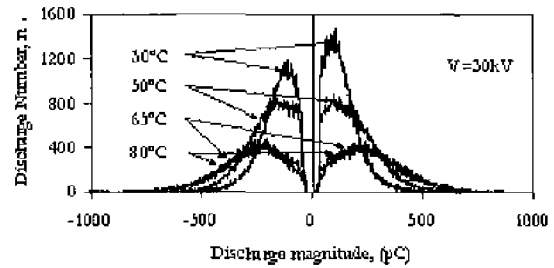

Figure 6. Discharge amplitude distributions detected at 30 kV and under different temperatures.

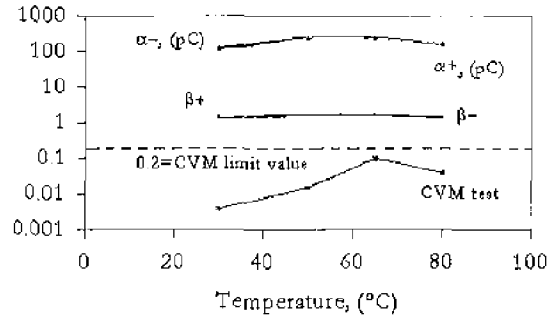

Figure 7. Values of scale and shape parameters fitting the PD data of Figure 7, as function of temperature. Positive (+) and negative (-). CVM variable is also reported for positive discharges.

The step temperature test was performed by increasing the temperature of the oil surrounding the test cell. The test sequence is illustrated in Figure 3(b). The time between two consecutive measurements has been fixed at 30 min in order to ensure temperature uniformity inside the oil bath. In Figure 6 the detected pulse amplitude and, in Figure 7 the related Weibull parameters also in this case, confirmed the presence of only one discharge phenomenon acting inside the air-gap, from 30 to 80°C. The CVM test, performed on the results for positive discharges, confirms this hypothesis as well and the complete overlap of the α^- and α^+ values vs. testing temperature shows that the negative and the positive pulse distributions are very similar. However, there is a clear trend of discharge activity characterized by a reduced number of discharges and an increasing amplitude with temperature, furthermore the 65°C and the 80°C positive and negative discharge pulse amplitude distributions are almost coincident.

4.2 TESTS IN DENMARK

As already stated, the B test protocol was performed in Denmark and consisted of life tests at 30°C and at 80°C carried out with a test voltage of 30 kV on 5 specimens. The results are summarized in Table 1, which indicates a decreased life time for the specimens subjected to 80°C. The acquisition phase t_a lasted for 20 test voltage periods and the digitally acquired and processed PD data during the life tests included the (a) the pulse mean repetition rate; (b) mean charge transferred per cycle, either for positive or for negative discharges; and (c) Weibull analysis in accordance with Equation (2). In Figures 8 and 9 are shown some typical pulse amplitude histograms related to the first and the last (before breakdown) acquisition obtained at 30 and 80°C respectively. Analysis of the data at the beginning of each test indicated

Table 1. PD tests performed in Denmark on specimens at 30 kV, temperature T , lifetime L , average lifetime L_a and standard deviation S .

Spec.	T °C	L h	L_a h	S
1	30	71.76		
2	30	82.5		
3	30	96	89.32	12.19
4	30	162.32		
5	30	94.34		
1	80	97.8		
2	80	72		
3	80	55	71.59	20.70
4	80	60		
5	80	73.1		

a very good correlation with the pulse amplitude histograms obtained in Italy, either in term of pulse repetition rate or of the maximum amplitude of the discharge pulses. The only difference is obviously due to the number of bits in the digitized data (8 bit in Denmark and 12 bit in Italy). Some attention should be given to the different time behavior of pulse amplitude histograms with varying temperature. It can be observed that at 30°C the histogram shape maintains its exponential form up to breakdown, while at 80°C deviation from a simple exponential behavior becomes apparent in the vicinity of the breakdown time.

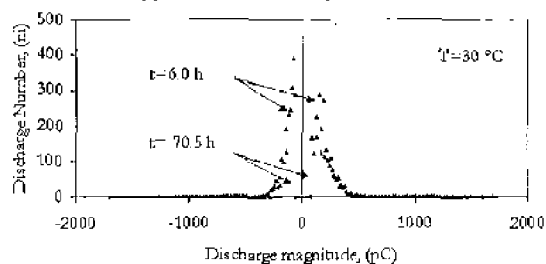

Figure 8. Discharge amplitude distributions detected under a life test at 30 kV and 30°C.

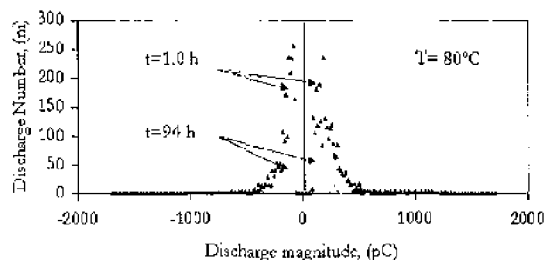

Figure 9. Discharge amplitude distributions detected under a life test at 30 kV and 80°C.

In Figures 10 to 12, the mean pulse repetition rate and the mean charge transferred per cycle are shown, for both the life tests at 30 and 80°C. It is evident from the pulse mean repetition rate behavior that the decrease of PD activity prior to breakdown is more regular at 30°C. The decreasing trend in PD activity with aging of the mean repetition rate and the charge transferred per cycle is also evinced at 80°C, if one considers the linear portion of the curve prior to the extrapolated dotted lines, corresponding to $\approx 50\%$ of the specimen's life time; beyond this point the discharge process at 80°C appears to assume a different characteristic.

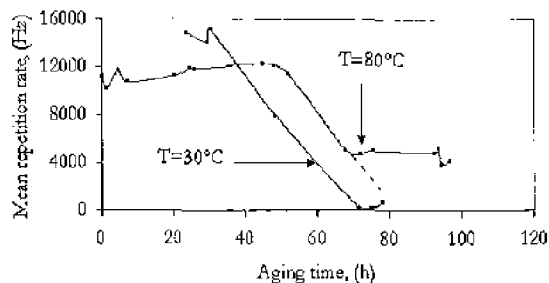

Figure 10. Mean discharge frequency during two life tests: at 30 and at 80°C.

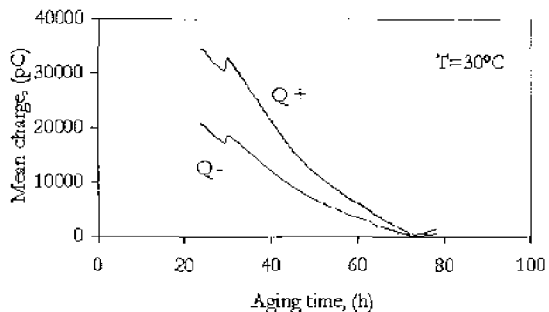

Figure 11. Mean charge transferred per voltage cycle at 30°C, either for positive discharges or for negative discharges.

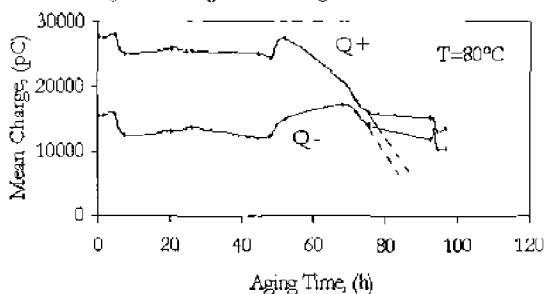

Figure 12. Mean charge transferred per voltage cycle at 80°C, either for positive discharges or for negative discharges.

This difference in PD behavior at 30 and 80°C becomes more obvious in the Weibull analysis of the data obtained in typical life tests. For the test performed at 30°C (Figure 13), the results show only a single Weibull function to which the experimental data may be fitted. The CVM test is accordingly within its limit value of 0.2 for the positive discharges, with the negative discharges exhibiting the same characteristic behavior. In contrast, at 80°C the PD activity evinces a very different. Also for the tests performed in Denmark, the decrease of discharge number and the increase in their amplitude infer a definite temperature effect. The PD activity can thus be modeled by only one Weibull function during about half of the specimen's life time. The CVM test, applied to all the data acquired during life tests at 80°C, (Figure 14) suggests the occurrence of another discharge phenomenon in terms of the changes in the amplitude histogram in Figure 9 and of the repetition rate and of the charge transferred in Figures 10 to 12.

As was observed in Section 3, the permittivity of PMMA increased from 30 to 80°C, thus giving in principle a different electric field distri-

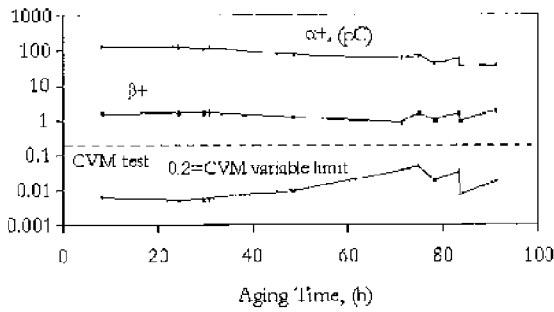

Figure 13. Values of scale and shape parameters for the positive discharges in a life test performed at 30°C. Also the related CVM variable is reported.

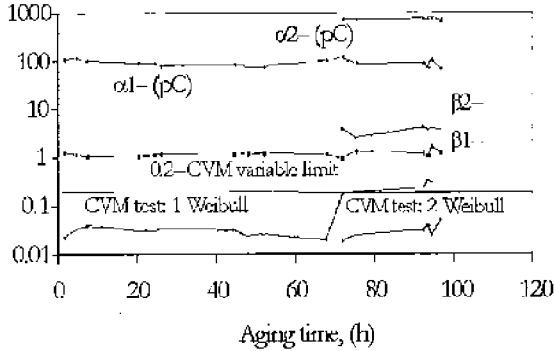

Figure 14. Values of scale and shape parameters for the negative discharges in a test performed at 80°C. Also the value of the CVM variable are reported. Note that after ~70 h of aging, a 5 parameter Weibull function is necessary to maintain the CVM value under its limit value.

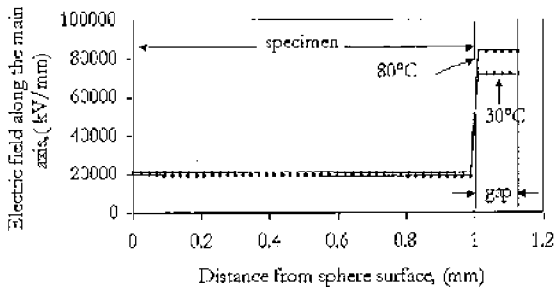

Figure 15. Electric field along the test cell main axis.

bution inside the test cell. In Figure 15 the electric field along the main axis, obtained by the finite element method (QuickField program), is reported at the two test temperatures. From the analysis of the two diagrams, no substantial difference emerged except for a very slight increase of the applied field strength (~16% inside the air-gap). But this was not sufficient to explain the aging mechanism differences at 30 and 80°C. On the other hand, possible effects connected with changes of geometrical dimensions of the void cavity in consequence of the increased temperature, could be excluded because the expansion coefficients of materials used for building the test cell are of the order of $10^{-6}/^{\circ}\text{C}$, e.g. with improbable effects at 80°C such as those observed in the related tests. Possible changes in the discharge mechanism itself may account for the observed differences between the aging test results obtained at 30 and 80°C. In our experiments, the PD pulses were

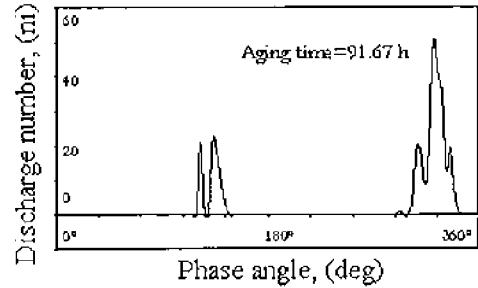
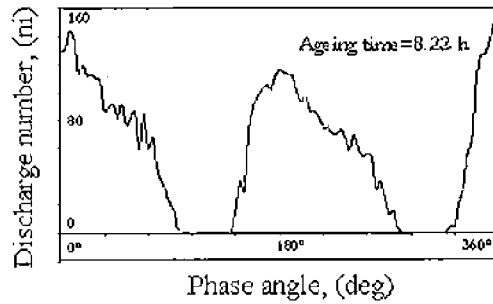

Figure 16. Number to phase discharge distribution of a test performed at 30°C. (a) at the beginning, (b) near the breakdown.

detected on a *R/LC* impedance and then their amplitudes were transformed into digital form, such that only pulsive type discharges were recorded. If one considers Figure 10, which presents typical pulse repetition rate data in a life test performed at 30°C, then the PD behavior may be divided into two possible consecutive stages:

(1) in the first 10 or 20 h the PD activity is governed mainly by pulse-type discharges with a phase discharge epoch distribution which is dispersed over a broad part of the voltage cycle as a consequence of a large discharge time-lag which results in a large overvoltage across the cavity. This can be observed in Figure 16(a), where no substantial discharge polarity effect is apparent and, consequently, an equi-probable first electron emission from metallic or dielectric electrode is inferred and the discharge process appears to be characteristic of a streamer-like discharge.

(2) During this phase, until breakdown, the number of detectable discharge pulses decreases slowly in consequence of a discharge transformation from pulse-type to pseudo glow discharges (a discharge pattern consisting of numerous minute amplitude pulses), as is observed on the monitoring oscilloscope. A conventional PD pulse detector does not respond to these discharges, so that the phase discharge distribution in Figure 16(b) indicates a reduction in the detected number of discharge pulses and their occurrence at the applied voltage zeros [18]. It has been argued that the PD turning from pulse-type to pseudo glow discharges seems to be due to the increasing surface conductivity on the specimen during aging under a very narrow air gap test condition. Similar results have been found from other authors, in a very narrow air gaps between stainless steel parallel-plane electrodes covered with molded epoxy [19].

The PD behavior observed at 80°C can be explained by analyzing the recorded data shown in Figure 17(a). The PD activity at this temperature is characterized by a lower discharge repetition rate and by a larger

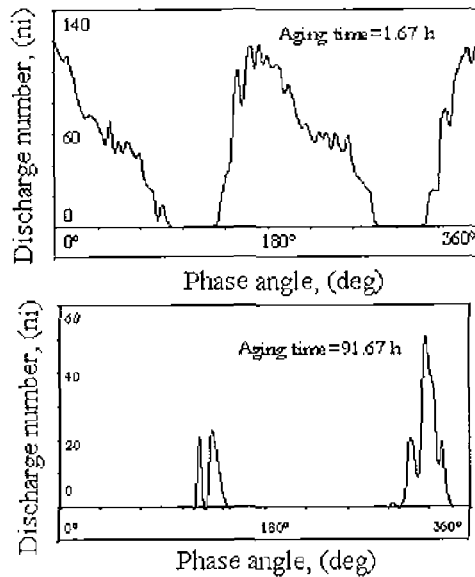

Figure 17. Number of phase discharge distribution of a test performed at 80°C. (a) at the beginning, (b) near the breakdown.

scatter of the pulse amplitudes. The discharge epoch or pulse phase distribution extends over a broad part of the voltage cycle, indicating the presence of streamer-like discharges with high time-lag values during most of the PMMA specimen's life to breakdown. Increase in the gas pressure within the void augments the discharge inception voltage at 80°C. However, the mean free path of the ionizing electrons at 80°C should be lower thus helping the discharge formation. It is difficult to establish which of the two phenomena prevails because the discharge inception voltage was measured only at the beginning of each test and only a very slight difference with temperature was noted. It should be added to these considerations, that the cavity wall conductivity at 80°C increases, thereby reducing the discharge number due to a short-circuiting action. Finally, a synergetic effect is highly likely to occur in the evolution of the degradation gases due to chemical reactions and the enhanced dielectric surface conductivity. At ~60% of the specimen's life a shape transformation begins to manifest itself in the negative part of the discharge amplitude histogram in terms of a new peak, giving rise to a phase discharge distribution depicted in Figure 17(b), which was recorded just prior to breakdown. It is difficult to ascertain the exact physical origin of this new phenomenon, but it is conceivable that it may be caused by discharges originating at the grounded metallic electrode, with initiator electron extracted from the dielectric surfaced electrode. These pulse type discharges caused considerable pitting on the dielectric surface as can be perceived from Figure 18(b), where many micro-crater were formed around the breakdown channel. For comparison purposes, Figure 18(a) shows the pitted surface of a specimen tested at 30°C.

5 CONCLUSIONS

IN this paper, experimental results were reported from PD tests carried out using the CIGRE method II cell, at 30 and 80°C. The main goal in this project was to study in two different laboratories the PD

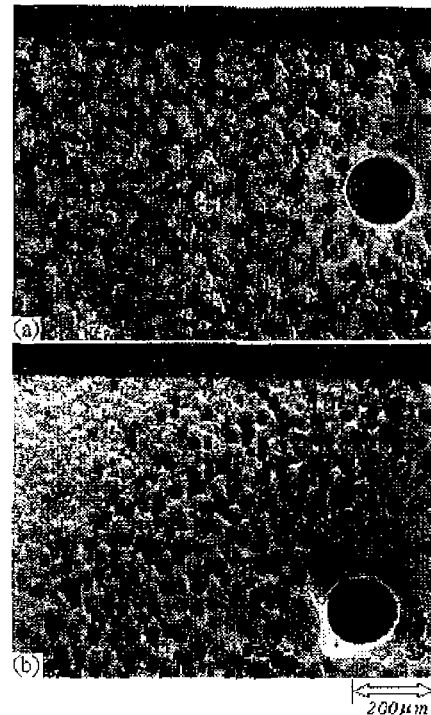

Figure 18. SEM pictures of the breakdown area of two specimens; (a) aged under 30 kV, 30°C. (b) Aged under 30 kV, 80°C.

resistance and the aging mechanism of materials primarily at high temperatures related to their real working conditions. The investigations here reported were carried out with PMMA, on which already extensive data is available at ambient temperature. The main conclusions are as follows.

The results of an analysis of PD amplitude distributions obtained in Denmark and in Italy proved to be in good agreement. Therefore, one of the pursued goals in this project can be considered as achieved.

At the ambient temperature of 30°C, the PD activity decreases with the aging time until breakdown and the analysis of the acquired data confirms this behavior by means of PD pulse amplitudes and epochs or phase histograms, recurrence rate and the average charge transferred per cycle. The decrease in the number of detectable discharge pulses is attributed to a transition from pulse to a pseudo glow or microswarming type discharge process as a result of an increased dielectric surface conductivity associated with chemical degradation of the PMMA subjected to PD. The conventional PD detector was not capable of detecting the pseudo glow discharges; however, just prior to breakdown some pulse-type discharge activity was still detected. Weibull statistic analysis indicated that the pulse-type discharges were associate with one particular discharge process. The average value of the time to breakdown of the specimens was equal to 89.38 h with a standard deviation coefficient of 12.19%.

At 80°C, PD activity is characterized by a general reduction of number of discharges with respect to 30°C, but with an increase of their amplitudes. Furthermore, the observed presence of pseudo glow (microswarming) discharges was very less marked. In general, the PD ac-

tivity was more regular with the aging time with a predominance of the pulse-type discharge mechanism. In particular, PD activity could be modeled by only one Weibull function for about half the specimen's life. Thereafter, the synergetic effects between PD gas production by chemical reactions and the dielectric surface conductivity, substantially higher at 80°C than at 30°C, gave rise to the onset of another discharge phenomenon at ~60% of specimen's life time. The more severe surface degradation at 80°C appears to be the main cause for a shorter average life of 71.95 h (vs. the 90 h at 30°C). Further work is in progress to define more clearly the physical degradation mechanism active at 80°C.

ACKNOWLEDGMENT

The present work was supported by the Ministry of University and Scientific Research of Italy.

REFERENCES

- [1] IEC Publication 505, *Guide for evaluation and identification of insulation system of electric equipment*, 1975.
- [2] J. K. Nelson, in *Engineering Dielectrics*, Vol. IIA, "Electrical Properties of Solid Insulating Materials; Molecular Structure and Electrical Behavior", R. Bartnikas and R. M. Eichhorn, Editors, STP 783, ASTM, Philadelphia, 1983.
- [3] CIGRE Domestic Task Group, 15-06-01 of Japan, "Round Robin Test of PD Resistance by a New CIGRE Method", Part 2. *V-t Characteristics and Related Phenomena*, Berlin, 1985.
- [4] CIGRE, 15-06-01-(Japan)-02-87, "Round Robin Test of PD Resistance by CIGRE Method II Electrode System", Part 4 *V-t Characteristics at Low Voltage Region*. Wien, 1987.
- [5] A. Campocchia, R. Schifani, "On testing Methodology of Thermosetting Dielectric Materials Subjected to Internal Discharges: Effects of Environmental Temperature", *IEEE Trans. on Electrical Insulation*, Vol. 23, No. 3, pp. 419-426, 1988.
- [6] R. Schifani, "On a model for the Comparative Analysis of the Aging Characteristics of Epoxy Resins Subjected to Internal Discharges at Various Environmental Temperatures", 3rd Intern. Conf. on Conduction and Breakdown in Solid Dielectrics; Trondheim, Norway, pp. 456-460, July 3-6, 1989.
- [7] R. Schifani, "Temperature Dependence of Epoxy Resistance to PD", *IEEE Trans. on Dielectrics and Elec. Insul.*, Vol. 2, No. 4, August 1995, pp. 653-659.
- [8] A. C. Giacardi, *Multifactor Aging of Epoxy: The Combined Effect of Temperature and Partial Discharges*, PhD Thesis, Norwegian Institute of Technology, Trondheim, 1994.
- [9] T. Tanaka, M. Nagao, T. Okamoto, M. Ieda, H. Karner, W. Kodoll, "A Method of Evaluating Resistance of Insulating Materials against Internal Partial Discharges", CIGRE, 15-06 (Tanaka-01-91), Trondheim, 1991.
- [10] N. G. McCrum, B. E. Read, G. Williams, *Anelastic and dielectric effects in polymeric solids*, Wiley, London, 1967.
- [11] R. Bozzo, A. Contin, M. Cacciari, F. Guastavino, C. Gemme, G. C. Montanari, "Stochastic Analysis of Partial Discharge Patterns Deriving from Electrical Tree Measurements", Proc. of ICSD 95, Leicester, England, July 10-13, pp. 381-385, 1995.
- [12] W. Nelson, *Applied Life Data Analysis*, John Wiley & Sons, New York, 1981.
- [13] J. F. Lawless, *Statistical Models and Methods for Lifetime Data*, J. Wiley & Sons, New York, 1982.
- [14] J. T. Holball, *The Resistance of Composite Materials Against Electrical Discharges*. PhD Thesis, Technical University of Denmark, 1992.
- [15] R. Schifani, G. Mitelli, "A Computer Aided Instrument for Pattern Recognition of Partial Discharges", COMPEL, The International Journal for Computation and Mathematics in Electrical and Electronic Engineering, Vol. 17, No. 5/6, 1998, pp. 765-772.
- [16] M. Cacciari, A. Contin and G. C. Montanari, "Use of a Mixed-Weibull Distribution for the Identification of PD Phenomena", *IEEE Trans. on Dielec. and Elec. Insul.*, Vol. 2, pp. 1166-1179, Dec. 1995.
- [17] P. J. Phillips in *Engineering Dielectrics*, Vol. IIA, "Electrical Properties of Solid Insulating Materials; Molecular Structure and Electrical Behavior", R. Bartnikas and R. M. Eichhorn, Editors, STP 783, ASTM, Philadelphia, 1983.
- [18] R. Bartnikas and J. P. Novak, "On the Spark to Pseudoglow and Glow Transition Mechanism and Discharge Detectability", *IEEE Trans. on Electrical Insulation*, Vol. 27, 1992, pp. 3-14.

This paper is based on a presentation given at the 1997 Volta Colloquium on Partial Discharge Measurements, Como, Italy, 1997.

Manuscript was received on 28 February 1998, in final form 22 October 1999.