

Steve Alpern, [Alec Morton](#), [Katerina Papadaki](#)

Patrolling games

**Article (Accepted version)
(Refereed)**

Original citation:

Alpern, Steven, Morton, Alec and Papadaki, Katerina (2011) Patrolling games. [Operations Research](#), 59 (5). pp. 1246-1257. ISSN 0030-364X

DOI: [10.1287/opre.1110.0983](https://doi.org/10.1287/opre.1110.0983)

© 2011 [Institute for operations research and the management sciences \(INFORMS\)](#)

This version available at: <http://eprints.lse.ac.uk/32210/>
Available in LSE Research Online: February 2011

LSE has developed LSE Research Online so that users may access research output of the School. Copyright © and Moral Rights for the papers on this site are retained by the individual authors and/or other copyright owners. Users may download and/or print one copy of any article(s) in LSE Research Online to facilitate their private study or for non-commercial research. You may not engage in further distribution of the material or use it for any profit-making activities or any commercial gain. You may freely distribute the URL (<http://eprints.lse.ac.uk>) of the LSE Research Online website.

This document is the author's final accepted version of the journal article. There may be differences between this version and the published version. You are advised to consult the publisher's version if you wish to cite from it.

Patrolling games

Steve Alpern^{*†}, Alec Morton[†], Katerina Papadaki[†]

November 23, 2010

Abstract

A key operational problem for those charged with the security of vulnerable facilities (such as airports or art galleries) is the scheduling and deployment of patrols. Motivated by the problem of optimizing randomized, and thus unpredictable, patrols, we present a class of patrolling games. The facility to be patrolled can be thought of as a network or graph Q of interconnected nodes (e.g. rooms, terminals) and the Attacker can choose to attack any node of Q within a given time T . He requires m consecutive periods there, uninterrupted by the Patroller, to commit his nefarious act (and win). The Patroller can follow any path on the graph. Thus the patrolling game is a win-lose game, where the Value is the probability that the Patroller successfully intercepts an attack, given best play on both sides. We determine analytically either the Value of the game, or bounds on the Value, for various classes of graphs, and discuss possible extensions and generalizations.

Subject classifications: Games, noncooperative; Military, search/ surveillance; Decision Analysis, risk; Networks/ graphs

Area of review: Military and Homeland Security

^{*}Department of Mathematics, London School of Economics and Political Science, London.

[†]Operational Research Group, Department of Management, London School of Economics and Political Science, London.

1 Introduction

A key operational problem for those charged with the security of vulnerable facilities is the scheduling and deployment of patrols. This problem is encountered by, for example:

- security guards patrolling a museum or art gallery;
- antiterrorist officers patrolling an airport or shopping mall;
- police forces patrolling a city containing a number of potential targets for theft such as jewelry stores;
- soldiers patrolling an occupied city or territory;
- air marshals patrolling an airline network;
- inspectors patrolling a container yard or cargo warehouse.

Such problems have been studied in diverse literatures. For example, a well-known problem in computational geometry deals with the position of security guards in art galleries (Urrutia, 2000) and a classical Operations Research literature exists on the scheduling of police patrols (see e.g. Larson (1972) and references therein). The importance of randomized patrols has been recognized in law enforcement for some time, but not the nature of the randomization (e.g. Sherman and Eck (2002, p. 297)). Much of the optimization literature on this subject (e.g. Chelst, 1978) concentrates on the important problem of how to deploy randomized patrols to maximize the probability of intercepting a crime in progress, *when the crime frequency of different locations is taken as given* (often a realistic assumption, at least in the short term). Such models however are not game theoretic and do not capture the idea of a patrolling schedule as a strategy selected in the face of an intelligent and malign adversary, for example an art thief or terrorist, which is a distinctive feature of the class of models we study in this paper. Although there do exist differential game formulations of the relationship between police and criminal (Isaacs, 1999, Feichtinger, 1983) these tend to focus on a dynamic (and often strategic) process of mutual adjustment rather than confronting the problem confronted by the scheduler who sits down to determine the path which the patrol will take.

Game theoretic analyses have recently featured prominently in OR studies of homeland security and counterterrorism (e.g. Brown et al., 2006, Bier and Azaiez, 2009, Lindelauf et

al., 2009). An attractive and unique feature of game theoretic formulations in the context of patrolling is that they provide insight into how a Patroller should randomize her patrols. There is a clear common-sense rationale for randomization: a predictable Patroller is an ineffective one. Yet a naive "maximum entropy" heuristic (Fox et al, 2005) may not fare well: faced with n targets it may not make sense to spend $1/n$ of the available patrolling time with each of them. This dilemma has attracted considerable attention recently amongst practitioners and the research community has responded to this challenge: in particular, the work of Paruchuri and colleagues (2007) provides a number of heuristic models which illustrate how equilibrium randomized strategies can be approximated when the problem is formulated as a Stackelberg (leader-follower) game, and such models have found use in real security situations (Gordon, 2007; Newsweek, 2007).

Our work on this problem is inspired by the theory of search games, on which an extensive mathematical literature has developed over the last few decades. This theory captures situations in which a Searcher aims to minimize the time taken to find a stationary or mobile Hider, who does not want to be found, on a network or in a region (Alpern and Gal, 2003). A variant on the the search game is the Accumulation game (Ruckle, 2001; Kikuta and Ruckle, 2001) where the Hider distributes some sort of continuous material over n locations, and the Searcher searches r locations and confiscates any material hidden there; if the amount of material remaining exceeds a certain critical level, the Hider wins, otherwise he loses. There are also related literatures on Inspection games (Avenhaus, von Stengel and Zamir, 2002), in which an Inspector who seeks to catch an Inspectee red-handed, and Infiltration games (Auger, 1991; Garnaev, Garnaeva and Goutal, 1996; Garnaev, 2000, and Alpern, 1992) in which a Guard seeks to prevent an Infiltrator from penetrating some sensitive facility. Similar attack/ defence games have been studied in military operations research (Washburn, 2003), dating as far back as Morse and Kimball (1950). Many such games are of independent mathematical interest and have been studied in a purely mathematical settings (e.g. Baston, Bostock and Ferguson, 1989; Zoroa, Zoroa and Ruiz, 1988). Various results are available for how the Searcher/ Inspector/ Guard/ Defender should proceed, depending on the assumptions about the structure of the mathematical space which she inhabits. A particularly productive line of research in the search game literature has been to explore the case where the search space can be thought of as a network or graph, as we do here.

In this paper we formulate a game which we call the *Patrolling Game*. Unlike the work of Paruchuri and colleagues, our problem is a zero-sum game, and provides for a defender who is

mobile, being able to travel between locations in the course of her shift (a "Patroller"). Unlike search games, our "Attacker" (the equivalent of the search game "Hider") may commence his attack at any time and has to be detected within a given time-window in order to forestall the performance of some misdeed. Like the Accumulation game, and unlike the standard search game, our game is *win-lose* - a game of *type* rather than *degree* in the terminology of Isaacs (1999). Our problem is sufficiently idealized that it is possible to obtain insightful analytic results, but sufficiently realistic that it is recognizable as a practical problem faced by practitioners in various domains.

We present some analytic results for this game, and demonstrate that it yields patrolling (and attacking) strategies which are natural and intuitive. We are in this paper unable to present general analytic results for all games of this type, and it seems unlikely that closed form expressions exist for the value and optimal mixtures. Indeed, even computing optimal strategies may be quite challenging in many cases, because of the combinatorial explosion in the Patroller's strategy space.

This paper is organized as follows. We present in Section 2 a rigorous formulation of patrolling games, together with some elementary observations on properties of the Value. As the number of pure strategies for the players can be very large, we give in Section 3 three methods for reducing the number that we have to consider: symmetrization, dominance and decomposition. Section 4 discusses certain classes of strategies that the players can use on any graph, and which are optimal on certain classes of graphs. Section 5 gives either the Value, or bounds on the Value, for patrolling games on certain classes of graphs: Hamiltonian, bipartite and line graphs. Section 6 presents extensions of the model and concludes.

2 The Patrolling Game

2.1 Formulation

The Patrolling Game $G = G(Q, T, m)$ is a win-lose (and hence zero-sum) game between a maximizing Patroller (female) and a minimizing Attacker (male). It comes in two forms, the *one-off game* $G^o = G^o(Q, T, m)$ and the *periodic game* $G^p = G^p(Q, T, m)$. The one-off game is played out over a given time interval $\mathcal{T} = \{0, 1, 2, \dots, T - 1\}$ of length T on a graph Q with n nodes \mathcal{N} and edges \mathcal{E} . We will assume that Q is connected unless stated otherwise, and we say two nodes are "adjacent" if they are linked by an edge. A pure strategy for the Attacker is a

pair $[i, I]$, where $i \in \mathcal{N}$ is called the *attack node* and $I = \{\tau, \tau + 1, \dots, \tau + m - 1\} \subseteq \mathcal{T}$ is an m -interval called the *attack interval*. A pure strategy for the Patroller is a walk $w : \mathcal{T} \rightarrow Q$ called a *patrol*. If $i \in w(I)$ we say that the patrol intercepts the attack, in which case the Patroller wins and the payoff is $P = 1$; otherwise the Attacker wins and we have $P = 0$. Thus the payoff is given by

$$P(w, [i, I]) = \begin{cases} 1 \text{ (Patroller wins),} & \text{if } i \in w(I) \text{ (attack is intercepted),} \\ 0 \text{ (Attacker wins),} & \text{if } i \notin w(I) \text{ (attack is completed uninterrupted),} \end{cases}$$

The Value V^o of this game G^o is thus the probability that the attack is successfully intercepted. Except in trivial cases, optimal strategies must be mixed.

The periodic game is played on the time circle $\mathcal{T}^* = \{0, 1, 2, \dots, T - 1\}$ of length T on a graph Q with n nodes \mathcal{N} and edges \mathcal{E} ; the asterisk denotes that arithmetic using the indices of time circle takes place modulo T . As in the one-off game, a pure strategy for the Attacker is a pair $[i, I]$, where $i \in \mathcal{N}$ is the attack node and $I \subset \mathcal{T}^*$ is the attack interval but attack intervals are now m -intervals in the time circle, so for example if T is 24 and m is 5, the attack could be carried out overnight, during the interval $\{22, 23, 0, 1, 2\}$ (10 o'clock to 2 in the morning). The patrols (Patroller pure strategies) are now walks of period T ($w : \mathcal{T}^* \rightarrow \mathcal{N}$) but must "join up" in the sense that they satisfy $(w(T - 1), w(0)) \in \mathcal{E}$ (no such restriction applies in the one-off game).

The periodic game is simpler to analyze because the attack can be assumed to take place equiprobably in any time interval, which simplifies the analysis (see Subsection 3.1). When the values of the games differ, we will use the superscripts V^p and V^o to distinguish between the Values, using V when the result applies to both cases. $V(V^p, V^o)$ can be considered as parameterized by Q, T , and m just as G is, but most of the time writing $V(Q, T, m)$ is distracting and confusing and we will tend to suppress some or all of these arguments. We denote by $d(i, i')$ the distance function on the node set \mathcal{N} , the minimum number of edges between i and $i' \in \mathcal{N}$.

This formulation makes a number of assumptions which are not in fact as restrictive as they might appear. The first is the assumption an attack will take place. An immediate response to this is that even though attacks occur very rarely, one should patrol on the assumption that an attack will happen - otherwise what is the point of patrolling at all? A more sophisticated response is that the parties are really engaged in a non-zero sum deterrence game and the Patroller only has to reduce the probability of attack to a level where the expected value of

the attack is less than the value to the Attacker of engaging in an attack elsewhere (another airport, another art museum). As it turns out, however, the game studied in this paper can be seen as being embedded in a larger non-zero sum deterrence game in the manner of Avenhaus, von Stengel and Zamir (2002). In this case the key to the analysis of the larger non-zero sum game is precisely the analysis of the game discussed in the current paper. The second and third assumptions are that the node values are equal (all paintings are worth the same amount of money; the damage inflicted by an attack at some airport terminal will be the same as at any other airport terminal), and that the distances between nodes are equal, respectively. Obviously this may well not hold in an application setting. It is not hard to modify the modelling framework to include these features. However, beyond rather simple results of the sort proved in this section, it is difficult to obtain analytic results for games which incorporate these complexities.

2.2 General Properties of the Value V

We now make some observations about the Value V , which apply to both one-off and periodic versions of the game. We start with a monotonicity result (Lemma 1), the last part of which involves the notion of *identifying* nodes of a graph. If a graph Q' can be created by successively "merging" pairs (or tuples) of nodes in Q such that the new, merged node in Q' inherits edges from its constituent nodes in Q (i.e. if i and i' in Q are merged to become j in Q' , the nodes adjacent to j are precisely those adjacent to either i or i') we say that Q' can be obtained from Q by *node identification* (Bondy and Murty, 2007). Formally this identification operation can be defined by a projection map $\pi : \mathcal{N} \rightarrow \mathcal{N}'$, where \mathcal{N}' is the node set of the new graph Q' , and $\pi^{-1}(j)$ represents a set of nodes of Q that have been identified. For example, we can easily obtain the line graph with n nodes L_n by vertically identifying nodes of the cycle with $2(n-1)$ nodes $C_{2(n-1)}$ (see Figure 1 for the case $n = 5$).

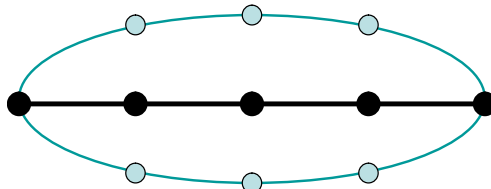

Figure 1. L_5 as a projection of C_8 .

Lemma 1

1. $V(Q, T, m)$ is nondecreasing in m .

2. $V(Q, T, m)$ cannot decrease if an additional edge is added between two nonadjacent nodes of the graph Q . That is, V is nondecreasing in \mathcal{E} (with the ordering on the latter understood in the sense of set inclusion).
3. $V^p(Q, T, m) \leq V^o(Q, T, m)$
4. If Q' is obtained from Q by node identification, $V(Q') \geq V(Q)$.

Proof. The first part follows from the observation that a patrol that intercepts an attack $[i, I]$ also intercepts $[i, I']$ if $I' \supset I$. The next two are based on the fact that in a zero sum game a player cannot do worse if he gets additional strategies. The last is based on the following observation: If a patrol w intercepts an attack on a node i of Q then the patrol $\pi(w)$ intercepts the associated attack on the node $\pi(i)$ of Q' . So the Patroller can ensure that the expected payoff is at least $V(Q)$ by choosing patrols w for Q according to some optimal mixed strategy, and then playing the projected patrol $\pi(w)$. ■

The next result gives easy general bound on the Value.

Lemma 2 $\frac{1}{n} \leq V \leq \frac{m}{n}$, for V equal to V^p or V^o and any parameters Q , T and m . More generally, $V \leq \omega/n$, where ω is the maximum number of nodes that any patrol can cover (ω depends on whether the one-off or periodic version is being played).

Proof. The Patroller can obtain the left inequality by randomly picking a node and waiting there. The Attacker can obtain the right inequality by attacking a random node during some fixed time interval I . Of these n pure strategies, the Patroller can intercept at most $|w(I)| \leq |I| = m$ of them, giving the bound m/n , or more generally the bound ω/n , since $|w(I)| \leq \omega$ by definition. ■

It is worth observing that ω is bounded above by the node size of the largest component of Q (if it is not connected), with ω/n equalling $1/n$ for the completely disconnected graph. Also note that for the one-off game with $m = 1$, where Q is the complete graph K_n , this is a special case of Ruckle's "Simple Search Game" (Ruckle, 1983). Since we thus have (from Part 2 of Lemma 1) $V = 1/n$ whenever $m = 1$, we will assume for the remainder of the paper that $m \geq 2$.

In real life, the authority responsible for Patrolling may have a decision to make about shift length involving weighing effectiveness against some cost criterion (and cost may be convex and increasing in shift length because of a requirement to pay overtime at a higher rate). What can

we say about the impact of shift length on interception probability, i.e. the shape of $V(T)$, in order to help the authority make this sort of decision?

Proposition 3 1. $V^o(T+1) \leq V^o(T)$

2. $V^p(kT) \geq V^p(T) \quad \forall k = 1, \dots, \infty$

Proof. The first result holds because the Attacker pure strategy set for $G^o(T+1)$ contains his pure strategy set in $G^o(T)$: note that the Patroller strategy sets are the same, with an irrelevant truncation of $w(T+1)$ in $G^o(T)$. For the second result, note that the Patroller can ensure a winning probability of $V^p(T)$ in the game $G^p(kT)$ by picking a T -periodic walk according to an optimal strategy in $G^p(T)$ and repeating it k times; but as there may be strategies available in $G^p(kT)$ which have no analogues in $G^p(T)$ the value may be strictly higher. ■

Thus in the one-off game, increasing the time T helps the Attacker, by giving him more choices of when to attack. The situation in the periodic game is more complicated. Increasing T by a multiplicative factor always helps the Patroller. However for some graphs $V^p(T+1)$ may be less than $V^p(T)$, so a larger T is not always better for the Patroller in the periodic game. An example where increasing T may hurt the Patroller is discussed in Section 5 and depicted in Figure 7.

An interesting implication of Proposition 3 and Lemma 1 part 3 is that the gap between the one-off and periodic game decreases as T is multiplied:

Corollary 4 $0 \leq V^o(kT) - V^p(kT) \leq V^o(T) - V^p(T) \quad \forall k = 1, \dots, \infty$

Note that it is not the case that $V^p(\cdot)$ is nondecreasing in T : for example, for the periodic game on the n -cycle, C_n , $V^p(T = n+1)$ is strictly less than $V^p(T = n)$ for $m \geq 2$ because the Patroller has to "waste" a time period by remaining at some node in order to return to her starting point. In Section 5.1, we show that for the games on certain sorts of graphs (e.g. Hamiltonian) the maximum value of the periodic game is obtained with a certain periodicity which is a function of n . Note also that both inequalities can be strict - for example in Section 3.3 we analyze $G^o(L_6, 5, 3)$ and show it has value $3/8$; however, by choosing 123 and 456 with equal probability, the Patroller can obtain $1/2$ in $G^o(L_6, 3, 3)$.

3 Strategy Reduction Techniques

Even for small graphs, the number of pure strategies available to the players can be quite large. So for practical purposes, as well as in proofs, it is useful to have methods for reducing the number of strategies that must be considered. This section discusses three such methods: symmetrization, dominance and decomposition.

3.1 Symmetrization

Symmetry considerations can simplify both the placement and timing of attacks and patrols. First we consider the placement of attacks in terms of the spatial symmetry of Q . As an example, note that the nodes 2 and 3 are symmetrically placed in the Kite Graph KT of Figure 2. So it follows from well-known arguments (Alpern and Asic, 1985; Zoroa and Zoroa, 1993) that there is an optimal mixed Attacker strategy with the property that, for any attack interval I , these two nodes are attacked with equal probability.

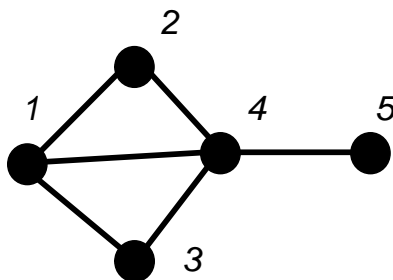

Figure 2. Kite Graph KT

This idea can be formalized by considering the automorphisms of Q , that is, the adjacency-preserving bijections of Q . (For the kite graph there are only the identity automorphism and the reflection about the vertical axis.) Calling nodes *equivalent* if some automorphism σ of Q takes one into the other, we need consider only attacks equiprobably distributed over the equivalence class of nodes. Similarly, two patrols w_1 and w_2 are equivalent if $w_2(t) = \sigma w_1(t)$ for some automorphism σ , and we can restrict our attention to the equiprobable mixture of such patrols.

A similar line of reasoning applies to time. In the periodic game all attack intervals are equivalent under some rotation of the time circle, so we need only consider the attack *node*. In the one-off game, attack intervals I_1 and I_2 are equivalent if $\gamma(I_1) = I_2$ where γ is the reflection automorphism of the time interval $\mathcal{T} = \{0, \dots, T-1\}$ defined by $\gamma(t) = T - t$.

The fact that we need only consider symmetrical strategies, that is, mixed strategies which give equal probability to equivalent strategies, is demonstrated in Alpern and Asic (1985), and

Zoroa and Zoroa (1993). Given a game G we call the modification of G where we restrict attention to Attacker and Patroller strategies which are equiprobable mixtures over the equivalence classes defined by the space and time automorphisms, the *symmetrization* of G ; this symmetrized game has the same value as the original G , but has fewer strategies and so is easier to study.

3.2 Dominance

Since the Patrolling Game is a win-lose game, we can use the following weak notion of dominance. We say a pure strategy s_1 *dominates* a pure strategy s_2 of the same player if it wins against every opponent strategy that s_2 wins against, and against at least one more. The Value is unchanged if we successively eliminate dominated strategies.

As an example of how successive elimination of dominated strategies can be used, consider again the kite graph KT of Figure 2. Node 4 is what we call a *penultimate node*, that is, a *non-leaf node that is adjacent to a leaf node* (node 5 in KT). Our next result shows that there is an optimal strategy on KT which does not involve any attacks on a penultimate node.

Lemma 5 *Assume Q is connected and $T \geq 3$. For $m \geq 2$, patrols that stay on any node for three consecutive periods are dominated. For $m \geq 3$, attacks on penultimate nodes are dominated, and consequently the Attacker has an optimal strategy concentrated on nodes which are not penultimate.*

Proof. The proof is by iterated dominance. Suppose the patrol w_1 is at the same node i for the three consecutive periods $I = \{t-1, t, t+1\}$. Define w_2 to be the same as w_1 except that $w_2(t) = i'$, where i' is adjacent to i . For $m \geq 2$, the patrol w_2 intercepts every attack that w_1 intercepts, as well as the attack on i' during I , and hence dominates w_1 . So we can now assume that at equilibrium the Patroller does not use patrols which stay at a node for three consecutive periods. Next suppose that i' is a penultimate node adjacent to a leaf node i . We now show that any attack on node i' during an m -interval I is dominated by an attack on i during I . If w wins against the attack $[i', I]$, then $w(t) = i$, for some $t \in I$. If $m \geq 3$, then I contains at least three consecutive periods, therefore, therefore one of the sets $\{t-2, t-1, t\}$, $\{t-1, t, t+1\}$, $\{t, t+1, t+2\}$ is contained in I . Let t' and t'' be the two of these periods different from t and contained in I . By the earlier argument, we know that either $w(t')$ or $w(t'')$ is i' and so $i' \in w(I)$, and w wins against $[i', I]$. Hence attacking at node i' is a dominated strategy. ■

3.3 Decomposition

Sometimes we can think of a graph Q as being made up of simpler graphs Q_1 and Q_2 . We call this a *decomposition* of Q . The nodes of the original graph Q are the union of the nodes Q_1 and Q_2 . All nodes which are adjacent in Q are also adjacent in any Q_i which contains both of them. See Figure 3 for an illustration. Q can of course be decomposed into multiple Q_i through repeated decomposition. If the nodes of Q_1 and Q_2 are disjoint and Q has no edges between nodes in distinct Q_i , then we say it is a *disjoint decomposition*.

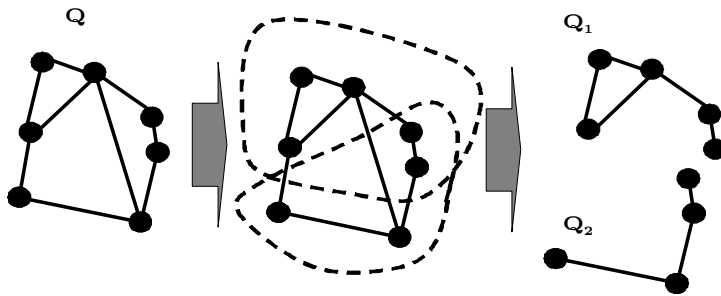

Figure 3. Decomposition of a graph

Lemma 6 *Let $V = V(Q, T, m)$ and $V_k = V(Q_k, T, m)$. If the graphs Q_k , $k = 1, \dots, K$, form a decomposition of Q , then*

$$V \geq \frac{1}{\sum_{k=1}^K 1/V_k},$$

with equality in the case of a disjoint decomposition.

Proof. Suppose the Patroller restricts herself to a family of mixed strategies S_k , where S_k is an optimal mixed strategy for the game $G(Q_k, T, m)$. Suppose she picks S_k with a probability q_k such that $q_k V_k = c$ is constant. In this case we have

$$1 = \sum_{k=1}^K q_k = c \sum_{k=1}^K 1/V_k, \text{ or } c = 1 / \sum_{k=1}^K 1/V_k.$$

For any attack pair $[i, I]$, the node i belongs to the node set of some graph Q_k . So with probability q_k the Patroller will be optimally patrolling Q_k and in this case will intercept the Attacker with probability at least V_k . Hence the Patroller wins with probability at least $q_k V_k = c$. Hence the value of the game on graph Q is at least c , as claimed. If the Patroller is only allowed to patrol nodes from a single graph Q_k , the best she can do is win with probability c , so it follows that if the graphs Q_k have disjoint node sets and are disconnected, then $V = c$. ■

3.4 Examples

In this subsection, we deal with two examples which illustrate the use of the tools discussed previously in this section, and also demonstrate the some of the subtleties of this class of game. Our first example shows that, in the one-off game, it may be the case that the Attacker's optimal strategy may involve a time-varying strategy; our second example shows how our tools can be used to tackle an apparently quite complex game.

For our first example, to illustrate the ideas of symmetry and dominance, we now analyze the line graph L_6 with nodes $i = 1, \dots, 6$, for the case $T = 5$ and $m = 3$. The product of L_6 (drawn vertically) and the time space $\mathcal{T} = \{1, \dots, 5\}$ (drawn horizontally) is shown three times in Figure 3. An attack with probability p at node i and time interval $\{t - 1, t, t + 1\}$ is represented by a p at the middle of the attack interval (i, t) . Since there are three possible attack intervals ($\{1, 2, 3\}, \{2, 3, 4\}, \{3, 4, 5\}$) there are $6 \times 3 = 18$ possible attacks.

We first consider the one-off game $G^o(L_6, 5, 3)$ in a restricted form where the Attacker must use a time-invariant strategy. This is illustrated in the left drawing of Figure 4, where there are no attacks at penultimate nodes ($\{2, 5\}$) (using Lemma 5). Since nodes 1 and 6, and nodes 3 and 4 are equivalent under symmetry, we can assume they are attacked with equal probability. Hence this symmetric and time-invariant strategy is entirely characterized by two numbers, x and y , and (by the law of total probability) $6x + 6y = 1$. The patrol $w_1 = (3, 2, 1, 2, 3)$ intercepts all attacks at node 1 and two attacks at node 3, so wins with probability $3x + 2y$; similarly $w_2 = (1, 2, 3, 4, \text{any})$ intercepts one attack at node 1 and five attacks at nodes 3 and 4, and wins with probability $x + 5y$. These two patrols together dominate all others. So the Attacker minimaxes when $3x + 2y = x + 5y$. This occurs when $x = 1/10$ and $y = 1/15$, with minimax value $V^* = 13/30$. (An easy calculation then shows that the Patroller should adopt w_1 and w_2 with probabilities $4/5$ and $1/5$.)

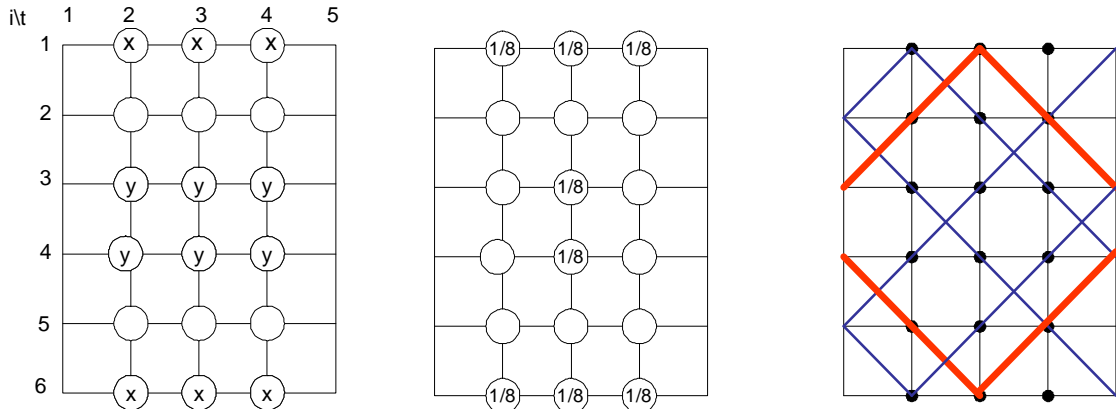

Figure 4. Optimal attacking and patrolling strategies for $G^o(L_6)$ with $T = 5$ and $m = 3$

In the (unrestricted) game $G^o(L_6, 5, 3)$ it is harder to derive the equilibrium strategy pair, but it is fairly easy to demonstrate that the Value is $V^o = 3/8 = 0.375$, which shows that no time-invariant mixed Attacker strategy can be optimal. To see that $V^o \leq 3/8$, consider the Attacker strategy shown in the middle drawing, and observe that no patrol can intercept more than three of the eight equiprobable attacks. For a lower bound, suppose the Patroller adopts the four strategies $(2, 1, 2, 3, 4)$, $(2, 3, 4, 5, 6)$ and their reflections $(5, 6, 5, 4, 3)$, $(5, 4, 3, 2, 1)$ with probability $1/8$ each; and adopts the two equivalent strategies $(3, 2, 1, 2, 3)$ and $(4, 5, 6, 5, 4)$ with probability $1/4$ each. The walks adopted with probability $1/8$ are shown in the right panel of Figure 4 by thin diagonal lines and those in adopted with probability $1/4$ by thick lines. Attacks are shown by heavy dots at the center of the attack interval. The assertion $V^o \geq 3/8$ follows from the observation that any possible attack is intercepted by at least three of the patrols, counting the thick lines as two (i.e. the total probability mass associated with all the walks passing through, immediately to the right of, and immediately to the left of every dot is at least $3/8$). It is also interesting to observe that all ten attacks which are not used at all in the middle drawing are intercepted by more than three of these patrols. Thus, the Value of the one-off game $G^o(L_6, 5, 3)$ is $3/8$, but securing this value requires the use of time-dependent Attacker strategies: the middle node is only to be attacked in the middle time interval $\{3, 4, 5\}$.

Next we analyze the periodic version, the game $G^p(L_6, 5, 3)$. This is similar to the restricted version of the one-off game discussed above, except that the middle of the attack can be at any time, so comparing with the left drawing of Figure 4, the x 's and y 's would extend throughout the rows, and so we have $10x + 10y = 1$. We need only consider four patrols (together with their symmetric translations): $w_1 = (1, 2, 1, 2, 1)$; $w_2 = (1, 2, 3, 2, 1)$; $w_3 = (1, 2, 3, 3, 2)$ and $w_4 = (3, 4, 3, 4, 3)$: the others are either dominated (because they spend time needlessly at a penultimate node which will never be attacked at equilibrium) or are duplicates. If the Attacker attacks at an end node (with probability $10x$), these four strategies will intercept 5, 4, 3, and 0 attacks respectively; if the Attacker attacks at a central node (with probability $10y$) they intercept 0, 3, 4 and 10 attacks respectively. As this game effectively has two Attacker strategies it can be easily solved graphically: the optimal strategy involves the Attacker choosing attacks with probability $x = \frac{7}{110}$, $y = \frac{4}{110}$ and the Patroller mixing between w_2 and w_4 and their symmetric translations with probability $\frac{10}{11}$ and $\frac{1}{11}$ respectively. The value V^p of the game is $4/11$.

Observe that the conditional probability of an attack being intercepted given that the Patroller plays the equilibrium mixture of w_2 and w_4 is $4/11, 5/11, 4/11, 4/11, 5/11, 4/11$ for attacks at a random time at nodes 1, 2, 3, 4, 5, 6 respectively. Thus the penultimate nodes (2 and 5) should not be attacked, as the interception probabilities are higher by $1/11$. This reinforces and (hopefully) makes intuitive the iterated dominance line of reasoning: loosely speaking, when the Patroller ensures that attacks at 4 and 6 are intercepted with probability $4/11$, the intermediate node 5 automatically gets covered enough to have an even higher interception probability.

To summarize, for line graph L_6 , with $T = 5$ and $m = 3$, we have

$$V^p = \frac{4}{11} < V^o = \frac{3}{8} < V^* = \frac{13}{30}$$

Thus the Patroller does better in the one-off game, and thus the bound stated in Lemma 1 Part 3 need not be tight. Further, in this instance, the Attacker has to adopt a time-dependent strategy in order to benefit fully.

For our second example, to demonstrate the use of all of our strategy reduction techniques, we analyze the periodic game for the kite graph illustrated in Figure 2 with $T = m = 3$. The dominance argument of Lemma 3 showed that, at equilibrium, the Attacker would never attack node 4, as it is always better for him to attack the adjacent leaf node 5. Moreover, in the periodic case for $T = 3$, there is no feasible Patroller strategy which visits both node 5 and any one of 1, 2, or 3. Therefore, if we remove node 4, the game on the resulting graph KT' has the same Value as the game on KT .

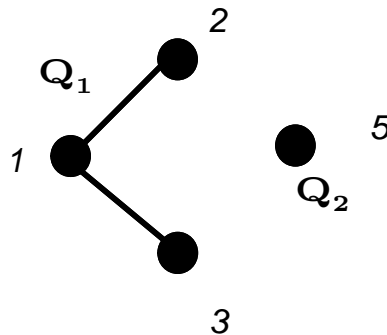

Figure 5. Decomposition of Kite graph KT into KT'

Lemma 6 shows that for Q_1 and Q_2 as in Figure 5, we have

$$V^p(KT') = \frac{1}{1/V^p(Q_1) + 1/V^p(Q_2)} \quad (1)$$

Obviously $V^p(Q_2) = 1$, and it can be easily shown that $V^p(L_3) = 1/2$ for $T = m = 3$ (observe that as attacks adjacent to the a leaf node are dominated, the Attacker has two strategies, to attack at nodes 2 and 3, which are reflections of each other and so are played equiprobably; no feasible Patroller strategy can intercept both). Hence by (1) we have

$$V^p(KT) = V^p(KT') = \frac{1}{1+2} = \frac{1}{3}.$$

This is another example where the Patroller does strictly better in the one-off game, in which $V^o = 3/5$. To see this, first note that by Lemma 2 the Attacker can ensure that $V^o \leq m/n = 3/5$ by attacking equiprobably at the five nodes. Then observe that by using the four patrols $(2, 1, 3)$, $(2, 4, 5)$, $(3, 4, 5)$, $(1, 4, 5)$ with respective probabilities $2/5, 1/5, 1/5, 1/5$ the Patroller ensures any attack at any node will be intercepted with probability $3/5$ and thus that $V^o \geq 3/5$. Note that if edge $(1, 4)$ is removed, the Value V^o goes down to $1/2$; the Attacker chooses nodes 1 and 5 equiprobably and the Patroller chooses the first three of the above patrols with probabilities $1/2, 1/4, 1/4$.

4 Generic Strategies

In general, the type of strategies available to the Patroller depends crucially on the path and circuit structure of the underlying graph Q . However, for purposes of analysis, it is possible to identify certain generic strategy types which are available on all graphs; or on all graphs in a class. We study three generic strategies for the Attacker: the *uniform strategy*, the *diametrical strategy*, and the *independent strategy*.

4.1 The uniform strategy

Our first strategy is an Attacker strategy called the *uniform strategy*, in which the attack $[i, I]$ has i and I chosen equiprobably and independently over their domains. That is, *a random node is attacked at a random time*. In the periodic game this strategy is the equiprobable mixture of the nT possible attacks. For the purposes of the next result, we make use of a standard definition:

Definition 7 *A graph is **bipartite** if it has no odd cycles.*

The reader will note that (for example) all trees are bipartite.

We have already shown that $V \leq \frac{m}{n}$. For bipartite graphs we are able to tighten this bound.

Lemma 8 *If T is odd and Q is bipartite, the bound of Lemma 2 can be tightened to $V^p \leq \frac{(T-1)m+1}{nT}$. This bound is guaranteed by the Attacker adopting the uniform strategy in the periodic game.*

Proof. In the uniform strategy, all nT possible attacks are adopted with probability $1/(nT)$. If T is odd, and there are no odd cycles (because Q is bipartite), then for any w , $w(t) = w(t+1)$ for some t in the periodic game. In these two periods (that is, t and $t+1$), at most $m+1$ of the attacks can be intercepted, and as before at most m in each of the other $T-2$ periods. So at most $(T-2)m + (m+1) = (T-1)m + 1$ attacks can be intercepted altogether, giving the desired inequality. ■

4.2 The diametrical strategy

The diameter \bar{d} of a graph Q is given by $\bar{d} = \max_{i,i' \in \mathcal{N}} d(i, i')$. A pair of nodes at distance \bar{d} is called diametrical, and the Attacker's *diametrical strategy* is to attack these nodes equiprobably during a random time interval I . It is easy to show the following. If \bar{d} is very large with respect to m and T then it is clear the best the Patroller can do against the diametrical strategy is to wait at one of the nodes and win half the time. On the other hand if m and T are large, the best the Patroller can do in the one-off game is go back and forth repeatedly on a geodesic between the diametrical points and win with probability $m/(2\bar{d})$. Since she cannot do better in the periodic game, we have the following.

Lemma 9 $V \leq \max [m/(2\bar{d}), 1/2]$. *The diametrical strategy guarantees this payoff.*

4.3 The independent strategy

The graph theoretic notion of independence and covering numbers has already been shown to be useful in accumulation games (Alpern and Fokkink, 2008). We give here modified versions of these concepts.

Definition 10 *A patrol w is called **intercepting** if it intercepts every attack on a node that it contains. That is, if a node i lies on a patrol w , then it appears in any subpath of w of length m . A set of intercepting patrols is called a **covering set** if every node of Q is contained in at least one of the patrols. The **covering number** \mathcal{J} is the minimum cardinality of any covering set.*

Definition 11 *If, for any two nodes i and j , any patrol which intercepts an attack at node i in attack interval I , cannot also intercept an attack at j in attack interval I , then i and j will be said to be **independent**. In the one-off game G^o , this is equivalent to requiring any two nodes to satisfy $d(i, i') \geq m$; in the periodic game G^p , they must satisfy $d(i, i') \geq m$ or $T \leq 2d(i, i')$ (because the Patroller has to return to her starting point by the end of the period). The **independence number** \mathcal{I} is the cardinality of a maximal independent set.*

Obviously $\mathcal{I} \leq \mathcal{J}$. Observe that both \mathcal{I} and \mathcal{J} depend on the parameters Q, T, m and on the version of the game that is played, G^o or G^p . For example, when $T = 3$ and $m = 3$, the node subset $\{1, 3\}$ of L_3 is independent for the periodic game but not for the one-off game.

For the Attacker, the *independent strategy* is to fix an attack interval and then choose the attack node equiprobably from some maximal independent set. For the Patroller, the *covering strategy* is to choose equiprobably from a minimal set of covering patrols.

Note that for $T = 2$, patrols can be identified with edges of Q , so these definitions reduce to the usual notion of an independent set not having adjacent nodes and a covering set consisting of edges.

Lemma 12 $\frac{1}{\mathcal{J}} \leq V \leq \frac{1}{\mathcal{I}}$ (with $V = 1/\mathcal{I}$ when $\mathcal{I} = \mathcal{J}$).

Proof. The Attacker's independent strategy gives the upper bound and the Patroller's covering strategy gives the lower bound. ■

The cases where $\mathcal{I} = \mathcal{J}$ deal with many patrolling games. For example, we can use this technique to give another solution to the kite graph KT of Figure 2 for the periodic game with $T = m = 3$. Here the nodes 2, 3, and 5 form an independent set (because $2d(i, i') = 4 \geq 3 = T$) and intercepting patrols on the top left, top right and bottom edges (period 3 patrols of the form $(a, a, b, a, a, b, \dots)$) form a covering set. Thus Lemma 12 gives $V = 1/\mathcal{I} = 1/3$, as we demonstrated earlier by another method.

5 Patrolling on Special Classes of Graphs

We have no single form of analysis that is sufficiently robust to give the Value of an arbitrary patrolling game; in general the Value would have to be obtained computationally. However for certain classes of graphs we can determine either the Value in terms of the parameters m and n (the number of nodes), or bounds on the Value. These classes are Hamiltonian graphs, bipartite graphs and line graphs.

5.1 Hamiltonian graphs

A *Hamiltonian graph* is a graph containing at least one cycle which visits each node exactly once (i.e. a Hamiltonian cycle). A special case of the Hamiltonian graphs is the simple cycle with n nodes C_n . (Another special case is the complete graph K_n .) The existence of a natural cycle in the underlying graph is a common feature of the problem faced in application settings, as often the area to be patrolled will be physically compact (consider, e.g. patrolling a campus). Note that if $m \geq n$ the Patroller can win by following the Hamiltonian cycle, so we assume that $m < n$. We define a *random Hamiltonian patrol* to be one which fixes some Hamiltonian cycle, starts at a random node i , and follows the cycle in a fixed direction, repeating as required. Such a patrol is always feasible in the one-off game G^o and is feasible in the periodic game G^p if T is a multiple of n . Using this mixed strategy, the Patroller can get the best possible interception probability V , namely the upper bound m/n of Proposition 2.

Theorem 13 *If Q is Hamiltonian then*

1. $V^o = \frac{m}{n}$;
2. $V^p \leq \frac{m}{n}$ with equality if $T = kn$, with k integer, and $V^p \rightarrow m/n$ as $k \rightarrow \infty$ if $T = kn + \sigma$ with k integer and $0 < \sigma < n$ integer.

Proof. First observe that in either case we have $V \leq m/n$ by Lemma 2. In the one-off game, suppose the Patroller adopts a random Hamiltonian patrol. Then for any attack interval I , $w(I)$ is a random m -arc of the Hamiltonian cycle, and as such contains the attack node i with probability m/n , as claimed. If T is a multiple of n , this strategy is also feasible in the periodic game. To obtain the limiting result, note that if $\sigma = T \bmod n \neq 0$, the periodic Patroller can modify the random Hamiltonian patrol by waiting at a random node during a random σ -interval. This will not hurt her unless the attack interval I overlaps the waiting interval, which has probability $(\sigma + m - 1)/T$, so

$$\left(1 - \frac{\sigma + m - 1}{T}\right) \frac{m}{n} \leq V^p \leq V^o = \frac{m}{n}, \text{ and so } V^p \rightarrow \frac{m}{n}. \quad (2)$$

■

Since the above result applies to the cycle graph, we can use it to solve the game on some graphs which can be obtained from the cycle graph by identification of nodes. We now solve the

periodic Patrolling Game for the eight node graph shown below on the left of Figure 6 in the case $T = 10$ and $m = 4$. First note that since the diameter is $\bar{d} = 5$ we have from Lemma 9 that the diametrical Attack strategy ensures that $V \leq m / (2\bar{d}) = 4/10$. By viewing the graph as a projection of C_{10} (with Value $m/10 = 4/10$ from Theorem 13) we conclude from Lemma 1 Part 4 that $V \geq 4/10$, so $V = 4/10$.

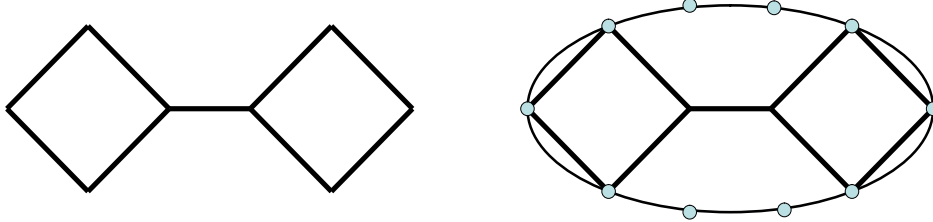

Figure 6. A graph shown as projection of C_{10}

For the cycle C_n where $m = 2$, and n is even, we can refine this result.

Proposition 14 *For n even,*

1. $V^p(C_n, T, 2) = \frac{2}{n}$ if T is even.
2. $V^p(C_n, T, 2) = \frac{2T-1}{nT}$ if T is odd.

Proof. For Part 1., the result follows from Lemma 12. For Part 2., Because C_n is bipartite, Lemma 8 shows that it is bounded above by $\frac{2(T-1)+1}{nT} = \frac{2T-1}{nT}$. To see that this is also a lower bound, suppose the Patroller partitions the node set into $\frac{n}{2}$ pairs of adjacent nodes, i.e. disjoint edges. The Patroller then selects one of these edges (i', i'') equiprobably and oscillates between i' and i'' . Because T is odd and the game is periodic, conditional on her choice of (i', i'') , the Patroller will have to repeat a node, i.e. $w(t) = w(t+1)$ for some t , and she chooses both t and the node (out of i', i'') to repeat at random. Whichever node and time the Attacker chooses, he will fail to be intercepted if he attacks at a node in $\mathcal{N}/i', i''$ or if he attacks the non-repeated node at time t ; otherwise he will be intercepted, and thus his probability of interception is $1 - \left[\frac{2}{n} \left(\frac{n}{2} - 1 \right) + \frac{2}{n} \left(\frac{1}{2T} \right) \right] = \frac{2T-1}{nT}$ so this is a lower bound and thus we have a Value for the game. ■

Because we have in Proposition 14 results which explicitly depend on T , we can use these to illustrate in numerical terms an issue which we discussed in Section 2.2, namely what happens to the value as the T goes to the limit. In particular, we see in Figure 7 the values for the game on C_4 with $m = 2$ as T goes to ∞ . Note that, as demonstrated analytically in Subsection 2.2,

the gap between the one-off and periodic games diminishes as the the value of the periodic game ascends, but this convergence is not monotonic.

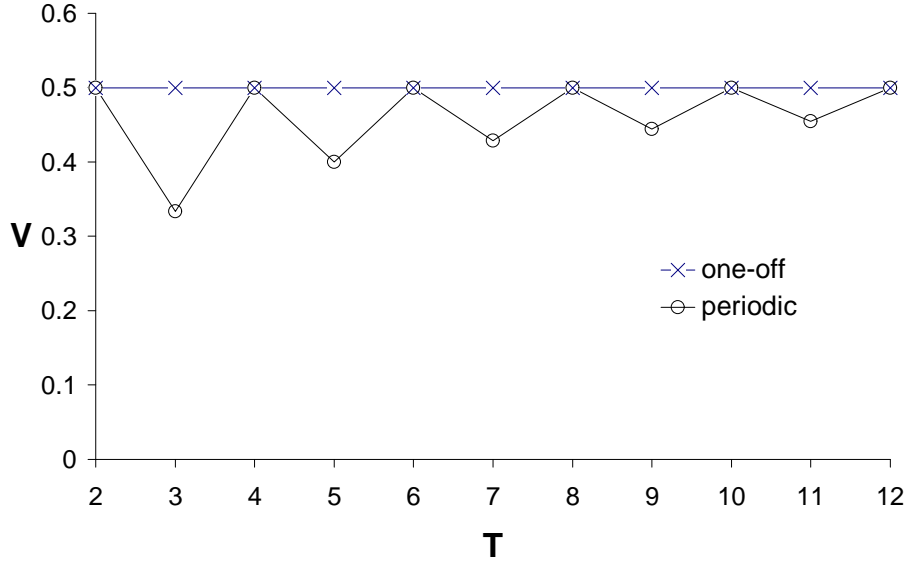

Figure 7. The values of the one-off and periodic games on C_4 for $m = 2$ as T goes to ∞

5.2 Bipartite graphs

If Q is a *bipartite graph* (as defined earlier as having no odd cycles) we can partition its node set into *halfsets* $A = \{\alpha_1, \dots, \alpha_a\}$ and $B = \{\beta_1, \dots, \beta_b\}$, with $a \leq b$, such that its only edges are between nodes in A and nodes in B . If *all* such node pairs are edges then we say Q is the *complete bipartite graph* $K_{a,b}$.

If $m > 2b$ then the Patroller can win by using a patrol with period $2b$ which covers all the nodes, that is, the covering number \mathcal{J} is 1. So we assume $m \leq 2b$.

Theorem 15 *If Q is bipartite with halfsets of sizes $a \leq b$, then*

1. $V^o \leq m/(2b)$, with equality if Q is complete bipartite ($K_{a,b}$);
2. $V^p \leq m/(2b)$, with equality if Q is complete bipartite ($K_{a,b}$) and $T=2kb$ with k integer. Further, if Q is complete bipartite ($K_{a,b}$), $V^p \rightarrow m/(2b)$ as $k \rightarrow \infty$, if $T = kn + \sigma$ with k integer and $0 < \sigma < n$ integer.

Proof. We first show that $V^o \leq m/(2b)$, which then gives the weaker inequality $V^p \leq m/(2b)$. Consider the Attacker mixed strategy of fixing an attack interval I and picking the node i

equiprobably among the b elements of B . For any patrol w , the probability that a random i in B belongs to $w(I)$ equals $|w(I) \cap B|/b \leq (m/2)/b = m/(2b)$. If m is odd, the Attacker strategy must be modified to pick I and the shifted interval $I + 1$ equiprobably. In this case for any w we have $|(w(I) \cap B)| + |(w(I + 1) \cap B)| \leq m$ and the probability that the attack is intercepted by any w is given by

$$\frac{1}{2} \frac{|(w(I))|}{b} + \frac{1}{2} \frac{|(w(I + 1) \cap B)|}{b} \leq \frac{m}{2b}.$$

The equality part follows for $a = b$ from Theorem 13, as $K_{b,b}$ is Hamiltonian. As in Theorem 13, we have separate results for the one-off and periodic cases, and specifically we are only able to show that our result applies for particular or limiting values of T in the periodic case. If $a < b$ then we can obtain $K_{a,b}$ from $K_{b,b}$ by identifying together a subset of $b - a$ nodes of one of the halfsets of $K_{b,b}$ and then applying Lemma 1 (part 4) to assert that $V^o(K_{a,b}) \geq V^o(K_{b,b}) = m/2b$ in general and with a similar limiting result for the periodic case. ■

In all these cases, informally speaking, an optimal strategy for the Attacker is to fix an attack interval and choose the attack node equiprobably from the larger halfset; an optimal strategy for the Patroller is to randomize over a collection of strategies which visit the larger half set every second time period. In the case of $m = 2$, the Patroller chooses an edge joining the halfsets; the Attacker's and Patroller's strategies can be seen as a random choice from an independence and covering set respectively; in this case the Theorem is closely related to König's Theorem (Harary, 1971, Theorem 10.2), since König's Theorem states that the independence and covering numbers of a bipartite graph are identical.

To illustrate the proof, consider the special case of the star graph $S_n = K_{1,n-1}$ consisting of a central node connected to $n - 1$ extreme nodes. This models the situation where the Patroller has responsibility for the safekeeping of a building which has multiple wings, accessible through a common lobby area. We can view S_n as obtained from the even cycle graph $C_{2(n-1)}$ by identifying (say) all even numbered nodes, as in Figure 8.

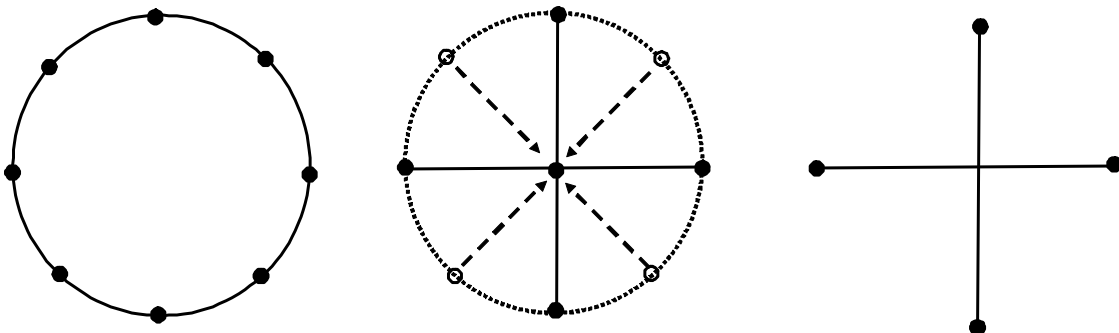

Figure 8. S_5 obtained from C_8 by node identification.

This mode of reasoning leads us to discover additional equilibrium pairs for the Hamiltonian case. Consider the cycle graph C_n for even n and T a multiple of n . We saw earlier that the uniform strategy was optimal for the Attacker. But since $C_n = K_{n/2, n/2}$ is bipartite Theorem 15 now gives the additional optimal strategy of attacking equiprobably on the odd (or even) nodes. In fact there is a further optimal Attacker strategy: since the diameter is $\bar{d} = n/2$, the diametrical strategy also gives $m/(2\bar{d}) = m/n$ by Lemma 9.

5.3 Line graphs

Line graphs L_n seem to be particularly complex to analyze, but we give here some special cases which illustrate the techniques we have developed earlier. We note that they are important in the patrolling context for their relation to the problem of patrolling a border, for example in order to prevent an agent from crossing a partially defended line between two regions. The following case seems to be easy.

Theorem 16 *If Q is a line and $n \leq m + 1$, then*

1. $V^o = \frac{m}{2(n-1)}$;
2. $V^p \leq \frac{m}{2(n-1)}$ with equality if $T=2k(n-1)$ with k integer; $V^p \rightarrow \frac{m}{2(n-1)}$ as $k \rightarrow \infty$, if $T = kn + \sigma$ with k integer and $0 < \sigma < n$ integer.

Proof. Since $\bar{d} = n - 1$, it follows from Lemma 9 that $V^p \leq V^o \leq \frac{m}{2(n-1)}$. That this bound is tight follows from a use of Lemma 1 Part 4 and Theorem 13: we can arrive at L_n from $C_{2(n-1)}$ through node identification in the manner of Figure 1. Thus, $V(L_n) \geq V(C_{2(n-1)}) = \frac{m}{2(n-1)}$. ■

In most of the examples in this paper the optimal strategies have been highly random, in that the players used equiprobable mixtures of similar pure strategies. We did this mainly to keep things simple, but the reader should not be misled into thinking this is always the case.

For example, consider the game $G^p(L_5, 4, 3)$. We claim that the value of this game is $\frac{3}{7}$. Lemma 6 tells us that $V^p(L_5, 4, 3) \geq \frac{1}{V^p(L_2, 4, 3) + V^p(L_3, 4, 3)}$. Since $V^p(L_2, 4, 3) = 1$ and (from Theorem 16) $V^p(L_3, 4, 3) = \frac{3}{4}$, we have that $V^p(L_5, 4, 3) \geq \frac{3}{7}$. Now consider the game from the Attacker's point of view. There are four possible attack intervals I , and five possible attack nodes i . Suppose the Attacker randomizes equiprobably over the intervals and over the nodes with probabilities $\frac{3}{7}$ each for nodes 1 and 5, and $\frac{1}{7}$ for node 3. The Patroller could remain at

node 1 or node 5 and intercept an attack with probability $\frac{3}{7}$ or randomly move between either 1 and 3 or between 3 and 5. She then has a $\frac{3}{4}$ chance of intercepting an attack which will take place with probability $\frac{3}{7}$ and a $\frac{3}{4}$ chance of intercepting an attack which will take place with probability $\frac{1}{7}$, for an overall probability of interception of $\frac{3}{4}(\frac{3}{7} + \frac{1}{7}) = \frac{3}{7}$. All other patrols yield a lower expected payoff and so $V^p(L_5, 4, 3) \leq \frac{3}{7}$.

Next consider $G^p(L_7, 5, 2)$. We claim that the value of this game is $\frac{1}{4}$. We have $\mathcal{I} = 4$ and so from Lemma 12 we have $V^p \leq 1/4$. To ensure winning with this probability, the Patroller must use "biased oscillations" on edges (i, i') of the form (i, i, i', i, i') , which we denote as $i \leftarrow i'$, with a random time rotation. Clearly $i \leftarrow i'$ intercepts any attack on i and intercepts any attack on i' with probability $4/5$ (that is unless the attack coincides with a repeated i). The optimal probabilities of the biased oscillations on consecutive nodes are shown below.

$$1 \quad \xleftarrow{4/16} \quad 2 \quad \xrightarrow{1/16} \quad 3 \quad \xleftarrow{3/16} \quad 4 \quad \xrightarrow{3/16} \quad 5 \quad \xleftarrow{1/16} \quad 6 \quad \xrightarrow{4/16} \quad 7$$

Attacks on any node are intercepted with probability at least $1/4$, with equality except for the central node 4 (which should never be attacked at equilibrium). For example an attack on node 2 is intercepted with probability $4/5$ if either $1 \leftarrow 2$ or $3 \leftarrow 2$ is adopted by the Patroller, that is with probability $(4/16 + 5/16) = 5/16$. So it is intercepted with probability $(4/5)(5/16) = 1/4$.

6 Conclusion

In this paper we have described a simple, intuitive game theoretic model which can serve as the basis for obtaining optimal randomized patrols. Our results could be used by a scheduler of patrols, to come up with a travel plan for a Patroller on a particular shift. Alternatively, the analysis may also give insight into decisions at a more strategic level, when there is interest in constructing or redesigning a facility which will have to be patrolled by a security force. For example, topologies which have a Hamiltonian cycle are generally better (give higher interception probability) than those which do not, which suggests that a good piece of advice might be to include a Hamiltonian cycle. However, adding Hamiltonian cycles beyond the first such cycle does not, in our model, increase the interception probability further, suggesting that for a graph which is already cyclic, constructing additional arcs might not yield a good return on investment.

The assumptions of the present paper can be relaxed to yield extended models. Some of

these models may be similar in spirit to the model of the current paper but incorporate certain real-world complexities which we have abstracted away. In this case some of the results of this paper transfer smoothly over. For example, nodes may have different values in which case Lemma 1 and Proposition 3) and some of the proof strategies (e.g. decomposition) can be generalized in a straightforward way. Or to take another example, there may be multiple patrollers in which case one can simply "multiply up" the numerator of Lemma 12.

On the other hand, there are some superficially similar games which may require quite different formulations and proof strategies. For example:

- It may be natural to consider a continuous time formulation of this problem. An attack takes place at any point of the network (not necessarily a node) on a continuous time interval of fixed length. The Patroller uses a unit speed path and wins if she is at the attacked point at some time during the attack interval. This would model, for example, the defense of a pipeline system, and would resemble to a greater extent the classical search game problem.
- The Patroller may be alerted (perhaps noisily and with some error) to the presence of an Attacker; and the Attacker may be alerted by a confederate who can identify when a Patroller leaves a particular node (for example, if the Patroller is in a marked police car). In this case new machinery would be required to capture the players' evolving knowledge state. Alternatively, it might be possible to formulate this problem so that the considerable body of knowledge about differential games could be applied.
- An absent-minded Patroller who randomizes anew at each time unit depending on her location could be modelled through a Markov game. Such a game may have interesting features: for example, a Patroller who can remember which direction she has come may perform better on a cycle rather than a complete graph, as she is less likely to backtrack, thus contradicting the "increasing in edges" property.

Acknowledgement 17 *We would like to thank Delof von Winterfeldt for suggesting the problem motivating the models explored in this paper to us, and to Milind Tambe for interesting discussions. Alec Morton and Katerina Papadaki are also grateful to the Centre for Risk and Economic Analysis of Terrorist Events (CREATE) at the University of Southern California for their support and hospitality. Steve Alpern was supported by NATO Collaborative Linkage Grant 983583 on Defense Against Terrorism.*

7 References

Alpern, S. (1992). Infiltration games on arbitrary graphs. *J. Math. Anal. Appl.* 163, no. 1, 286-288.

Alpern, S. and M. Asic (1985). "The Search Value of a Network." *Networks* 15(2): 229-238.

Alpern, S. and R. Fokkink (2008). Accumulation games on graphs - LSE-CDAM-2008-18. London, CDAM.

Alpern, S. and S. Gal (2003). *The Theory of Search Games and Rendezvous*. Dordrecht, Kluwer.

Auger, J. (1991) An infiltration game on k arcs. *Nav. Res. Logist.* 38, 511-530.

Avenhaus, R., B. Von Stengel, et al. (2002). Inspection games. *Handbook of Game Theory with Economic Applications*. R. J. Aumann and S. Hart. Amsterdam Elsevier.

Baston, V., F. Bostock, et al. (1989). "The Number Hides Game." *Proceedings of the American Mathematical Society* 107(2): 437-447.

Bier, V. M. and M. N. Azaiez (eds) (2009). *Game Theoretic Risk Analysis of Security Threats*. New York, Springer.

Bondy, J. A. and Murty, U. S. R. (2007). *Graph Theory*. New York, Springer.

Brown, G., Carlyle, M., Salmeron, J. and Wood, K. (2006). "Defending Critical Infrastructure". *Interfaces* 36, 530-544.

Chelst, K. (1978). An algorithm for deploying a crime directed (tactical) patrol force. *Management Science*, Vol. 24, No. 12, pp. 1314-1327

Feichtinger, G. (1983). A differential games solution to a model of competition between a thief and the police. *Management Science*, Vol. 29, No. 6, pp. 686-699.

Fox, C. R., D. Bardolet, et al. (2005). Partition dependence in decision analysis, resource allocation and consumer choice. *Experimental Business Research*. Volume III. R. Zwick and A. Rappoport. Dordrecht, Kluwer.

Garnaev, A. (2000). Search games and other applications of game theory: Lecture notes in *Economics and Mathematical Systems* 485. Berlin, Springer.

Garnaev, A., G. Garnaeva and P. Goutal (1997). On the infiltration game. *Int. J. Game Theory* 26: 215-221.

Gordon, L. (2007). "USC student's computer program enlisted in security efforts at LAX." *Los Angeles Times* October 1(<http://teamcore.usc.edu/ARMOR/LATIMES.pdf>).

- Harary, F. (1971). Graph theory. Reading, MA, Addison-Wesley.
- Isaacs, R. (1999). Differential Games Dover.
- Kikuta, K. and Ruckle, W. (2001), Continuous accumulation games on discrete locations. Naval Research Logistics 41: 821–831.
- Larson, R. C. (1972). Urban Police Patrol Analysis. Boston, MIT Press.
- Lindelauf, R., Borm, P., Hamers, H. (2009). The influence of secrecy on the communication structure of covert networks. Social Networks, 31, 126-137.
- Morse, P. M. and G. E. Kimball (1950). Methods of Operations Research. London, MIT Press and Wiley.
- Newsweek (2007). The Element of Surprise. Newsweek. <http://teamcore.usc.edu/ARMOR/newsweek.pdf>.
- Paruchuri, P., J. P. Pearce, et al. (2007). An efficient heuristic approach for security against multiple adversaries. AAMAS '07, Honolulu, Hawaii, ACM.
- Ruckle, W. H. (1983). Geometric Games and Their Application. Boston, Pitman.
- Ruckle, W. (2001), "Accumulation games". Sci. Math. Jpn. 54: 173–203.
- Sherman, L. and Eck, J. E., (2002). Policing for crime prevention. In: Evidence-based crime prevention, L. Sherman et. al., eds, Routledge, Taylor and Francis, New York.
- Urrutia, J. (2000). Art gallery and illumination problems. Handbook of computational geometry. J.-R. Sack and J. Urrutia. Amsterdam, Elsevier.
- Washburn, A. (2003). Two-person zero-sum games, 3rd edition. Linthicum, MD, INFORMS.
- Zoroa, N. and P. Zoroa (1993). "Some games of search on a lattice." Naval Research Logistics 40: 525-541.
- Zoroa, N., Zoroa, P. and Ruiz, J. M. (1988). "Juego de intersección de intervalos finitos". Revista de la Real Academia de Ciencias Exactas, Físicas y Naturales de Madrid, LXXXII (3,4): 469-481.