

# PERFORMANCE ANALYSIS OF A FREE SPACE OPTICS LINK WITH MULTIPLE TRANSMITTERS/RECEIVERS

NUR HAEDZERIN MD NOOR, AHMED WATHIK NAJI AND WAJDI AL-KHATEEB

*Electrical & Computer Engineering Department, Faculty of Engineering,  
International Islamic University Malaysia,  
Jalan Gombak, 53100 Kuala Lumpur, Malaysia.*

*haedzerain@yahoo.com*

---

**ABSTRACT:** Multiple transmitters/receivers (TX/RX) are used to improve the quality of Free Space Optics (FSO) communication systems. With the current needs of this technology for longer distance communication, the qualitative analysis of the system has become essential. In this work, the received power level (PR) and bit error rate (BER) are considered to influence the FSO link performance. The relationship between the two parameters are investigated and analysed. Furthermore, the received power for various numbers of TXs and RXs are experimentally measured and compared with the values obtained from theoretical calculations. The first part of the work deals with the theoretical calculation and simulation designs of multiple laser beams based on the commercial FSO used in actual sites. The second part describes the practical work and analysis of the system's performance.

**ABSTRAK:** Pemancar/penerima berganda (TX/RX) digunakan bagi meningkatkan kualiti sistem komunikasi Ruang Optik Bebas (FSO). Analisis kualitatif ke atas sistemnya adalah penting bagi keperluan semasa teknologi ini untuk jarak jauh. Di dalam kajian ini, aras kuasa penerima ( $P_R$ ) dan kadar ralat bit (BER) telah diambilkira bagi menentukan prestasi rangkaian FSO. Hubungan di antara kedua-dua parameter telah dikaji dan dianalisis. Seterusnya, kuasa penerima untuk pelbagai nombor TXs dan RXs diukur secara eksperimen dan dibandingkan dengan nilai teori yang dikira. Bahagian pertama skop kajian berkaitan dengan pengiraan teori dan rekabentuk simulasi sinaran laser berdasarkan FSO komersial di lapangan. Bahagian kedua kajian adalah kerja lapangan dan analisis prestasi sistem.

---

**KEY WORDS:** *Free Space Optics (FSO) link; Multiple TX/RX FSO; bit error rate (BER); eye diagram.*

## 1. INTRODUCTION

With recent needs of high speed communication system, Free Space Optics has emerged as an alternative to cater for such transmission. It utilizes the concept of transmitting very high bandwidth information using the optical beam from one point to another in the free space. Hence, the clear line of sight between both transmit and receive terminals is essential to establish a seamless communication. This line of sight technology offers numerous advantages to both telecommunication users and providers. It provides a high data rates up to several Gbps, has immunity to radio frequency interferences, requires no licensing, gives a highly secured communication link due to the usage of a very narrow beam angle, and offers an inexpensive, fast and easy deployment when compared to the fiber optic installation [1, 2].

However, since this technology solely employs the air as the medium of transmission, the vulnerability towards atmospheric phenomena is inevitable. These disturbances, will

significantly affect the FSO transmission performances. The atmospheric turbulences will cause the rapid fluctuation of received power and eventually will reduce the system quality. Moreover, the interruption of the laser beam such as bird flap will also disturb the communication channel [3]. Hence, there are studies [4, 5] proposing alternatives to mitigate the shortcomings.

This work will make use the multiple TX/RX i.e. multiple laser beams within a FSO based unit to analyze its communication link performances. The effort here is to model the multiple TX/RX FSO link based on the commercial FSO equipment that are on an experimental site as well as measure the FSO received power. The performance analysis will be in terms of measured received power, eye diagram and simulated BER. The drive to design the model is triggered by the fact that the BER tester practically does not provide a linear relationship with the BER. Practically, it only display a pass/fail relationship without conveying anything beyond that. Therefore, it would be useful to know how much error the system can tolerate before the BER significantly increases based on the received power and the number of transmitters and receivers used. As for the eye diagram, it will serve as an additional indicator in determining the quality of the FSO link. The objectives are to design the multiple TX/RX FSO link and analyze its performances based on the theoretically calculated received power using the mathematical model developed by previous research and to determine the BER for of each of the multiple TX/RX combinations and finally measure the FSO received power on the actual site to see how the multiple TX/RX can affect the FSO link performances experimentally. There would be a maximum of 16 combinations of multiple TX/RX FSO layouts to be considered, measured and analyzed.

The remainder of the paper is organized as follows. Section 2 describes the system overview of the multiple FSO links. Section 3 covers the theory of the FSO link performances involved in the analysis which are the received power and BER. Section 4 is the details of the system modeling of the multiple TX/RX FSO using the simulator. Section 5 is the experimental setup and procedure of the multiple TX/RX FSO i.e. the practical analysis. Section 6 presents the results and the analysis of the work using 3 different approaches which are theoretical, simulation and experimental. Finally, Section 7 gives the conclusion of the overall work.

## 2. SYSTEM OVERVIEW

For this project, the FSO equipment used is FlighStrata 155 by LightPointe. The multiple TX/RX link configuration can be seen in Fig. 1. Two FSO terminals which each having a link head consists of multiple lenses of TXs and RXs. These lenses will produce and collect multiple laser beams along the optical path. As illustrated by Fig. 1, the multiple beams which are the redundants signal generated by the data splitters, leave the TXs as an independent beam, but along the optical path, they begin to overlap and reach the receivers unit as one spot of a high powered signal. Each TX will transmit 4 laser beams to each of the 4 RXs because of the 4 data splitters used. In, total there would be 16 paths of laser beams/combinations of TX and RX to be analyzed.

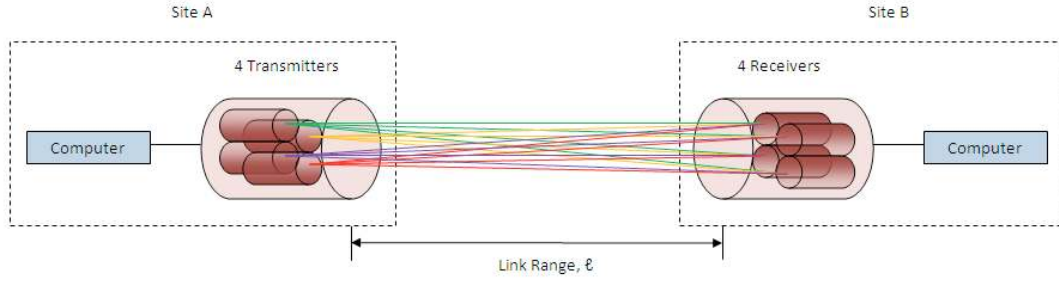

Fig. 1 Multiple TX/RX with multiple laser beams link configuration.

### 3. THEORY OF FREE SPACE OPTIC LINK PERFORMANCE

The FSO link performances can be determined by several parameters including geometrical loss, link margin, received power and BER. This work is focusing on two parameters to evaluate the FSO link performances which are the received power and BER. Theoretically, the basic communication principle stated that received power must be less than transmitted power,  $P_R \leq P_T$ , according to [6]:

$$P_R = P_T - \text{Total Losses} \quad (1)$$

Where  $P_R$  (dBm) is the received power,  $P_T$  (dBm) is the transmitted power. According to [7], total losses in a FSO communication system would cover all the losses caused by the atmospheric phenomena,  $L_{ATM}$  (dB) which can be calculated as in Eq. (7), geometrical loss,  $L_{GEO}$  (dB) and system loss,  $L_{SYS}$  (dB). Therefore, the new equation for FSO received power is as in Eq. (2):

$$P_R = P_{Tcomb} - L_{ATM} - L_{GEO} - L_{SYS} \quad (2)$$

Since the work involved the usage of multiple TX/RX architecture, the total transmitted power denoted by  $P_{Tcomb}$  (dBm) from each of the transmitters has been taken into consideration. The total transmitted power can be obtained in Eq. (3):

$$P_{Tcomb} = P_T + 10 \log_{10}(N_T) \quad (3)$$

Where  $N_T$  is the number of transmitter lenses on a single FSO unit. Geometrical loss and system loss are the internal losses occurred within the FSO transceiver. Both losses are fixed on all FSO link and cannot be neglected.  $L_{SYS}$  is manufacturer defined; meanwhile in [7]  $L_{GEO}$  can be calculated as in Eq. (4):

$$L_{GEO} = -10 \log_{10} \left[ \frac{4A_{Rtotal}}{\pi(\ell\theta)^2} \right] \quad (4)$$

$\ell$  (km) is the distance of the optical path where the laser beams travel and  $\theta$  (mrad) is the divergence angle which is the angle of the cone of light emitted from the transmitter. Meanwhile,  $A_{Rtotal}$  ( $m^2$ ) is the total area of the receiver apertures on a single FSO unit.

Bit error rate, the ratio of the number of errors to the total number of bits. BER is another basic qualitative parameter of FSO link. In this work, it quantifies the quality of the multiple TX/RX system. [3] has defined BER as the estimation of Eq. (5) where,  $n_e$  is the number of received error bits and  $N_B$  is the number of all transmitted bits for a long period.

$$BER \approx \frac{n_e}{N_B} \quad (5)$$

#### 4. SYSTEM MODELING

Multiple TX/RX system is modeled for the performance of FSO link with analysis by using the OptiSystem Version 7.0 by Optiwave. Fig. 2 shows the layout model for 4TX and 4RX combinations. A typical FSO system consists of FSO transmitter, a FSO channel and the FSO receiver. The frequency of the TX is set to be 353 THz or 850 nm in wavelength and the power is 8.66 dBm. The actual transmit power for a single TX of the experimental FSO equipment installed on the practical site is 7.78 dBm; hence the usage of additional 0.88 dBm is due to the power penalty caused by the TX's extinction ratio value. The output of the TX is connected to the fork which is a component used to duplicate the number of output ports so that each of the signals coming out from the fork's output has the same value with the output signal from the previous component connected to it. The first fork connected to the TX will produce a multiple laser beams from one source. Then, each of the output signals will be connected to another set of forks to produce another set of multiple laser beams. The multiple laser beams produced are then combined together with a power combiner before it is sent to the FSO channel.

The output signals coming out from the power combiners are then sent to the FSO channel which is the reproduction of the free space channel. It is a subsystem of two telescopes with the FSO channel between them. The apertures of the TX and RX are set to 2.5 cm and 8 cm respectively. The beam divergence is 2 mrad and the distance of the channel is set to 1 km. The theoretical model used for the FSO channel is as in Eq. (6) which is suitable for single TX and single RX. Hence, the work will involve the modification of the single TX and single RX layout design to enable the simulation of the multiple TX/RX.

$$P_R = P_T * \frac{d_R^2}{(d_T + \theta R)^2} * 10^{-\frac{\alpha R}{10}} \quad (6)$$

Where  $P_R$  is the received power (dBm) at the receiver,  $P_T$  is the transmitted power (dBm),  $d_R$  is the receiver aperture diameter (m),  $d_T$  is the transmitter aperture diameter (m),  $\theta$  is the beam divergence (mrad),  $R$  is the optical link length (km) and  $\alpha$  is the atmospheric attenuation (dB/km).

In every communication system, losses due to the equipment inefficiency cannot be ignored. Since they are two FSO terminals involved, each terminal has a loss of 1.8 dB according to FSO equipment installed on the practical site. Hence, the equipment loss is set to be 3.6 dB for two FSO terminals. According to Beers-Lambert Law [8], the atmospheric losses for any laser power is in a form of exponential equation of:

$$L_{ATM} = e^{-\sigma \ell} \quad (7)$$

Where  $\ell$  (km) is the transmittance range of the laser and  $\sigma$  is the typical attenuation coefficients (0.1 for clear air). Since the simulation is considering the clear weather condition, the attenuation is set to be 0.43 dB/km. All the multiple signals coming out from the FSO channel are then once again combined using the power combiner before received by the RX. The sensitivity of the RX is set to be -45 dBm. The two visualizer used in the simulation is the optical power meter and the BER analyzer. The first power meter is used to measure the transmit power signal coming out from the TX output port and the second power meter is used to calculate and display the average received power at the RX. As for the BER analyzer, it will automatically calculate the BER value and display the eye diagram of the designed system. The bit rate used in this setup is 1 Gbps.

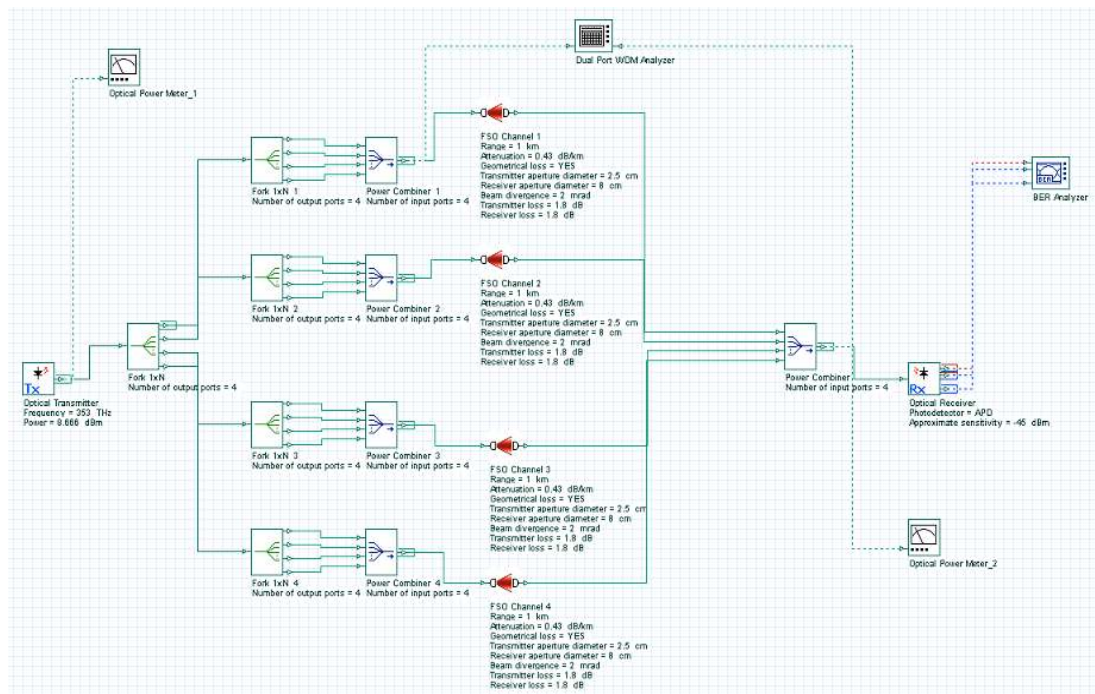

Fig. 2 TX/RX FSO link simulation layout.

## 5. EXPERIMENTAL SETUP AND PROCEDURE

The experimental work started by installing 2 pairs of FSO terminals at the top floor of two buildings at the compound of the International Islamic University Malaysia, Kuala Lumpur. Site A is at the rooftop of E1 building, Faculty of Engineering and Site B on level 5 of a student hostel with approximate distance of 1 km. For Site A, the equipment has been mounted on a tripod, meanwhile for the other site; the equipment is mounted on a universal mount which is attached to a wall.

In order to measure the individual and combined received power of multiple TX/RX FSO, a well fitted mask to cover the individual TX and RX lenses has been developed. The actual size of the front face of the link head including the diameter of each TX and RX are carefully measured to develop the mask. Figure 3 shows the custom-made mask developed using a dark-colored materials to ensure that the intended laser beams are fully blocked. A test has been made before selecting the material. The test is carried out by closing all the TXs and RXs on one site using a dark colored material while the other site has been left as it is, resulting in the complete failure of the communication link, indicating that, no laser beams are received. Hence, the material used is suitable for the practical evaluation of the received power for multiple TX/RX.

FlightManagerPC version 1.0.15.0 is the software provided by the product manufacturer used to measure the received power . Data are collected on 2<sup>nd</sup> August 2010 for approximately 3 hours, starting from 10.35am until 1.19pm. In order for the signal to stabilize for a proper reading, the duration of data collection for each of the combinations is set to be 5 minutes.

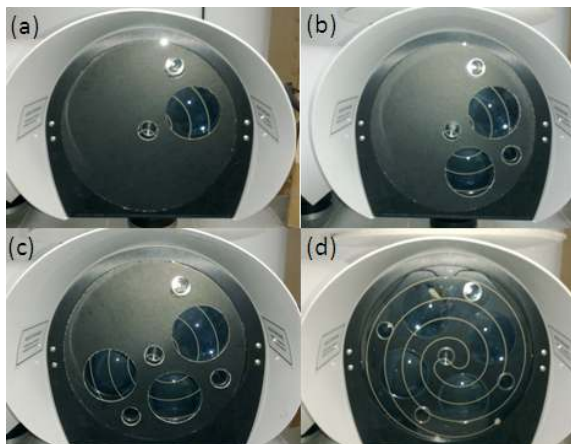

Fig. 3 Experimental transceivers with dark colored mask: (a)1TX/1RX (b) 2TX/2RX (c) 3TX/3RX (d) 4TX/4RX.

## 6. RESULTS AND ANALYSIS

The analysis considers the various 16 combinations of TX and RX. By varying the combinations of TX and RX, the multiple laser beams system can be measured and analyzed for its performances in terms of received power and BER using fixed parameters' values of FSO channel, optical TX and optical RX. The analysis considers the following approaches:

### 6.1 The Theoretical Approach

Figure 4 shows the theoretical setup for the evaluation of the received power using the equations discussed in section 2. As the number of TX/RX increased, the received power will increase accordingly. The 4x1, 4x2, 4x3 and 4x4 combinations of TX and RX give the highest value of received power. It is predicted that these combinations will still give the highest received power value when measured using the experimental setup. By looking at Table 1, doubling the number of TX and RX can effectively increase the received power resulting in 6 dB/octave of gain. For two TXs and two RXs the received power increases by 6 dB, from -24.684 dBm to -18.663 dBm and for four TXs and RXs, the received power gain is from -18.663 dBm to -12.642 dBm, another 6 dB.

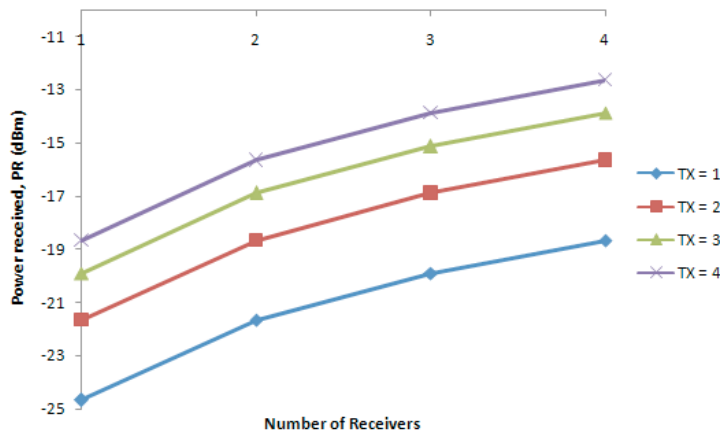

Fig. 4 Theoretical received power of doubling the number of TX and RX.

Table 1: Theoretical received power of doubling the number of TX and RX.

Number of TX	Number of TX	$P_R$ (Theoretical) [dBm]
1	1	-24.684
2	2	-18.663
4	4	-12.642

## 6.2 The Simulation Approach

Prior to the performance analysis, the average received power of the simulation setup for each of the TX/RX combinations are benchmarked with the theoretical received power. It is a step to ensure that, the multiple laser beams are setup correctly as FSO channel in the software accommodates single TX and single RX. Table 1 compares the simulated received power and the theoretical received power. The difference of the two values for all the combinations are within the range of 1.5% to 2.8%. Meaning, the multiple laser beams systems are accurately setup and ready to undergo the performance analysis. The table also shows the simulated received power when the number of TX and RX are doubled. The received power gain is 6 dB/octave which correlates with the theoretical approach.

Table 2: Theoretical and simulated received power for 16 combinations of TXs and RXs.

TX/RX Combination [TX × RX]	$P_R$ (Theoretical) [dBm]	$P_R$ (Simulated) [dBm]	Difference [%]
1 × 1	-24.684	-24.317	1.5
1 × 2 / 2 × 1	-21.673	-21.306	1.7
1 × 3 / 3 × 1	-19.912	-19.545	1.9
1 × 4 / 4 × 1	-18.663	-18.296	2.0
2 × 2	-18.663	-18.316	1.9
2 × 3 / 3 × 2	-16.902	-16.555	2.1
2 × 4 / 4 × 2	-15.653	-15.306	2.2
3 × 3	-15.141	-14.794	2.3
3 × 4 / 4 × 3	-13.892	-13.545	2.5
4 × 4	-12.642	-12.296	2.8

By analyzing the display of the eye diagram, the system performances can be evaluated and measured. Figure 5 shows the eye diagram for the 1TX/1RX, 2TX/2RX, 3TX/3RX and 4TX/4RX combinations. From Fig. 5, the increment in the number of TX and RX will produce less jitters of the signal and increase the size of the eye opening. The significance of a wider eye opening is: it will reduce the potential occurrence for data errors, the wider the eye opening, the better the system performance.

In the BER analysis, the relationship between the average received power and BER is investigated. The minimum BER is obtained via simulation with various numbers of TX and RX. Figure 6 shows the BER for 1km of multiple TX/RX. Theoretically, the received power will increase with the added number of TXs and RXs. With such addition, the BER for the system will decrease due to the spatial diversity effect which has increased the total received power. A single TX and RX has the highest BER of  $10^{-9}$ , which means that there is 1 errored bit for every 1Gbit of received data. The BER continues to decrease as the number of TX and RX increase. The lowest BER recorded is for 4TX/4RX combination which is  $10^{-107}$ . The low BER will enable the system to go a further distance i.e. more than 1 km, as long as the received power is above the receiver threshold.

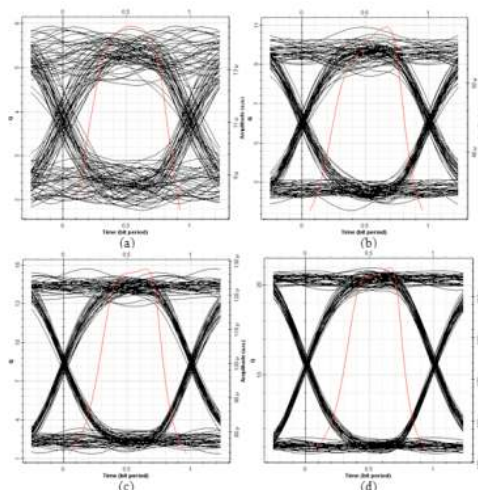

Fig. 5 Diagram for (a) 1TX/1RX (b) 2TX/2RX (c) 3TX/3RX (d) 4TX/4RX.

### 6.3 The Experimental Approach

Experimentally, there are 11 data of received power collected within 5 minutes for each of the TX and RX combinations. The average received power is measured, to enable the comparison between the received power obtained using the theoretical approach and the received power measured using the experimental approach. As the result, Fig. 7 is generated and showed that the highest number of TX and RX give the highest value of received power as predicted theoretically. Even though the measured value are lower than the calculated value, it still correlates with the pattern. 4x4 combination has highest received power value and 1x1 combination has the lowest value. The difference between the theoretical, simulated and experimental values is inevitable due to the losses caused by the environmental factor and installation location of the equipment setup as shown in Fig. 8. The experimental result deviate from that 6 db/octave when doubling the number of TX and RX is due to the location at the rooftop is at close vicinity of wall and fences which will cause possible reflection or diffraction of the laser beams travelled on the optical path.

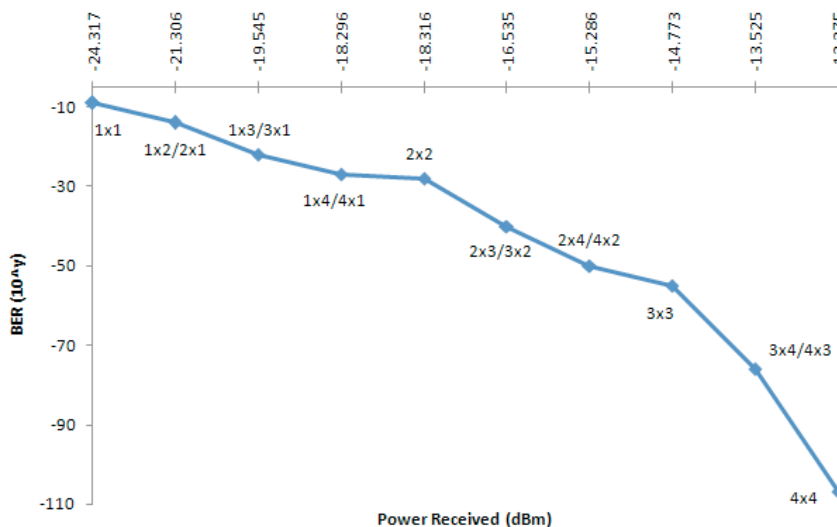

Fig. 6 BER versus power received for multiple laser beams.



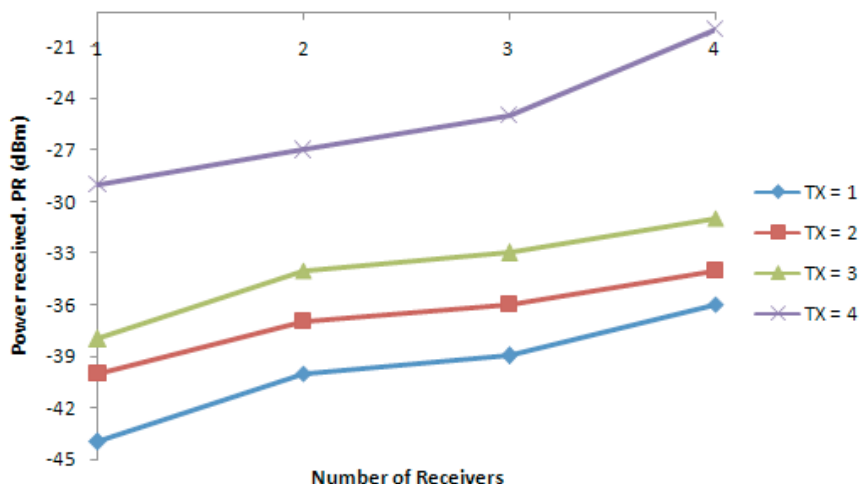

Fig. 7 Experimental received power for link range = 1 km.

### 7. CONCLUSIONS

The aim of this work is setup and investigate a multiple TX/RX FSO link and benchmark it against the theoretical and simulation model. Analysis of system performance is based on two paramaters which are the received power and the BER. The theoretical and simulation modeling provide a 6 dB per octave variation with doubled number of TX and RX. The variation according to the experimental setup shows a slight deviation as compared to the theoretical and simulation setup due to losses from close neighboring installations. This qualitative analysis would help in designing a longer FSO links over longer distances and enhance the usage of this technology beyond the last mile solution in the future.

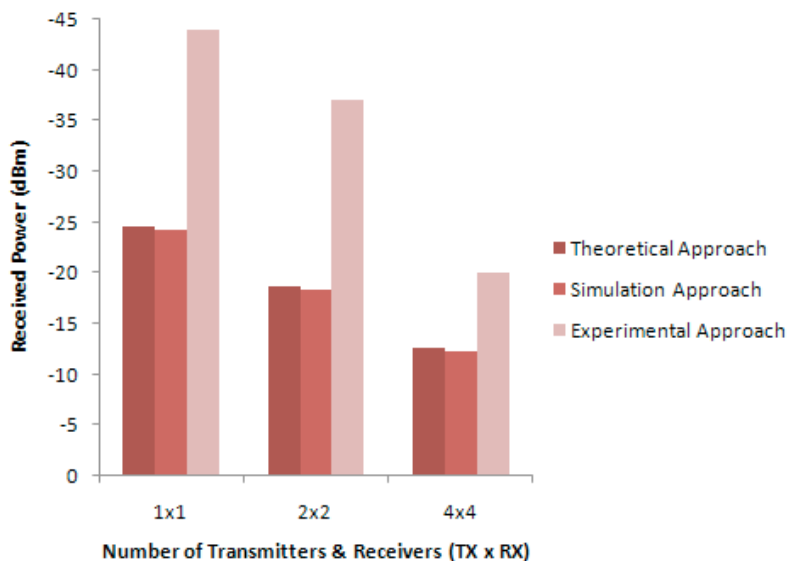

Fig. 8 Received power for doubling the number of TX and RX using theoretical, simulation and experimental approach.

## REFERENCES

- [1] M. Chabane, M. Alnaboulsi, H. Sizun, and O. Bouchet, "A new quality of service FSO software," presented at Conference of reliability of optical fiber components, devices, systems, Strasbourg, 2004 (volume no and page not mention)
- [2] Prokes, Ales, and Vladislav Skorpil, "Estimation of free space optics systems availability based on meteorological visibility," *Communications, 2009. LATINCOM'09. IEEE Latin-American Conference on*. IEEE, 2009.
- [3] R. Kvicala, V. Kvicera, M. Grabner, and O. Fiser, "BER and availability measured on FSO link," *Radioengineering* 16.3 (2007): 7-12.
- [4] Belmonte, Aniceto, and Joseph M. Kahn. "Capacity of coherent free-space optical links using diversity combining techniques," *Optics express* 17.15 (2009): 12601-11.
- [5] Hajjarian, Zeinab, Jarir Fadlullah, and Mohsen Kavehrad. "MIMO free space optical communications in turbid and turbulent atmosphere (invited paper)," *Journal of Communications* 4.8 (2009): 524-532.
- [6] Alma, H., "Free Space Optical Link Performance Analysis under Malaysian Weather Conditions and It's Impact on Quantum Key Distribution," *Electrical & Computer Engineering, Faculty of Engineering, Master of Science in Computer and Information Engineering. Kuala Lumpur: International Islamic University Malaysia* (2009): 1-135.
- [7] Singapore, I. D. A. "A trial-based study of Free-Space Optics systems in Singapore," *Info Communications Development Authority of Singapore (iDA), Singapore* 2002.
- [8] Kim, Isaac I., Bruce McArthur, and Eric J. Korevaar. "Comparison of laser beam propagation at 785 nm and 1550 nm in fog and haze for optical wireless communication," *Information Technologies 2000*. International Society for Optics and Photonics, 2001.