

# Performance Analysis of LMS and NLMS Algorithms for a Smart Antenna System

M. Yasin  
Research Scholar

Dr. Pervez Akhtar  
Professor

Dr. Valiuddin  
Associate. Professor

<sup>1, 2, 3</sup>Department of Electronics and Power Engineering, Pakistan Navy Engineering College, National University of Science and Technology, Karachi, PAKISTAN

## ABSTRACT

Efficient utilization of limited radio frequency spectrum is only possible to use smart/adaptive antenna system. Smart antenna radiates not only narrow beam towards desired users exploiting signal processing capability but also places null towards interferers, thus optimizing the signal quality and enhancing capacity. Least mean square (LMS) and normalized least mean square (NLMS) are two adaptive beamforming algorithms which are presented in this paper. Smart antenna incorporates these algorithms in coded form which calculates complex weights according to the signal environment. The efficiency of LMS and NLMS algorithms is compared on the basis of normalized array factor and mean square error (MSE) for mobile communication. Simulation results reveal that both algorithms have high resolution for beam formation. However LMS has good performance to minimize MSE as compared to NLMS. Therefore, LMS is found more efficient algorithm to implement in the mobile communication environment to minimize MSE and enhancing capacity.

## General Terms

Adaptive filtering, Adaptive signal processing algorithm

## Keywords

Least Mean Square (LMS) Algorithm, Normalized Least Mean Square (NLMS) Algorithm

## 1. INTRODUCTION

Since Radio Frequency (RF) spectrum is limited and its efficient use is only possible by employing smart/adaptive antenna array system to exploit mobile systems capabilities for data and voice communication. The name smart refers to the signal processing capability that forms vital part of the adaptive antenna system which controls the antenna pattern by updating a set of antenna weights. Smart antenna, supported by signal processing capability, points narrow beam towards desired users but at the same time introduces null towards interferers, thus optimizing the service quality and capacity. Consider a smart antenna system with  $Ne$  elements equally spaced ( $d$ ) and user's signal arrives from desired angle  $\Phi_0$  as shown in Fig 1 [1]. Adaptive beamforming scheme that is LMS and NLMS is used to control weights adaptively to optimize signal to noise ratio (SNR) of the desired signal in look direction  $\Phi_0$ .

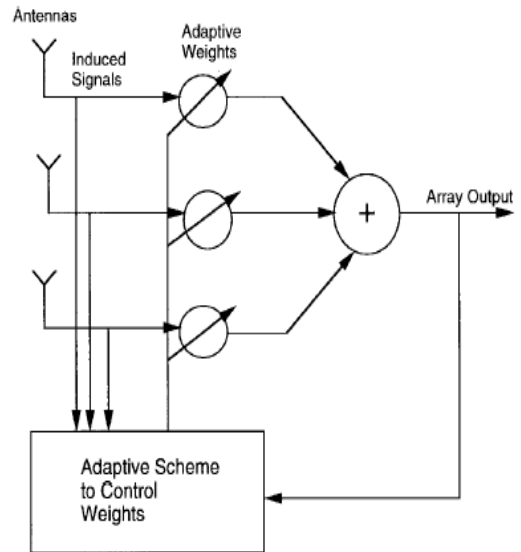

Fig.1. Smart/adaptive antenna array system

The array factor for elements ( $Ne$ ) equally spaced ( $d$ ) linear array is given by

$$AF(\Phi) = \sum_{n=0}^{N-1} A_n \cdot e^{jn\left(\frac{2\pi d}{\lambda} \cos \Phi + \alpha\right)} \quad (1)$$

where  $\alpha$  is the inter element phase shift and is described as:

$$\alpha = \frac{-2\pi d}{\lambda_0} \cos \Phi_0 \quad (2)$$

and  $\Phi_0$  is the desired direction of the beam.

In reality, antennas are not smart; it is the digital signal processing, along with the antenna, which makes the system smart. When smart antenna is deployed in mobile communication using either time division multiple access (TDMA) or code division multiple access (CDMA) environment, exploiting time slot or assigning different codes to different users respectively, it radiates beam towards desired users only. Each beam becomes a

channel, thus avoiding interference in a cell. Because of these, each coded channel reduces co-channel interference, due to the processing gain of the system. The processing gain (PG) of the CDMA system is described as:

$$PG = 10 \log(B / R_b) \quad (3)$$

where  $B$  is the CDMA channel bandwidth and  $R_b$  is the information rate in bits per second.

If a single antenna is used for CDMA system, then this system supports a maximum of 31 users. When an array of five elements is employed instead of single antenna, then capacity of CDMA system can be increased more than four times. It can be further enhanced if array of more elements are used [2] [3] [4] [5] [6] [7].

The rest of the paper is organized as follows: Section 2 introduces LMS algorithm with simulation results. NLMS algorithm with simulation results are presented in section 3. Finally the concluding remarks of this work are provided in section 4.

## 2. LMS ALGORITHM

### 2.1 Theory

The LMS is an iterative beamforming algorithm that uses the estimate of the gradient vector from the available data. This algorithm makes successive corrections to the weight vector in the direction of the negative of the gradient vector which finally concludes to minimum MSE. This successive correction to the weight vector is the point at which optimum value  $w_0$  is obtained

that relies on autocorrelation matrix  $R$  and cross correlation matrix  $p$  of the filter. LMS is an adaptive beamforming algorithm, defined by the following equations [2] [8] [9] [10] with input signal  $u(n)$  :

$$y(n) = w^T(n-1)u(n) \quad (4)$$

$$e(n) = d(n) - y(n) \quad (5)$$

$$w(n) = w(n-1) + \mu e(n)u^*(n) \quad (6)$$

$$\xi = E[e^2(n)] = E[(d^2(n))] - 2w^T p + w^T R w \quad (7)$$

where  $y(n)$  is the filter output,  $e(n)$  is the error signal between filter output and desired signal  $d(n)$  at step  $n$ .  $d(n)$  is the training sequence of known symbols (also called a pilot signal), is required to train the adaptive weights. Enough training sequence of known symbols must be available to ensure convergence.

Equation (6) is the weight  $w(n)$  update function for the LMS algorithm, where  $\mu$  is the rate of adaptation, controlled by the processing gain of the antenna array as described by equation (3) and  $*$  denotes the complex conjugate of the input signal  $u(n)$ . The convergence conditions imposed on step size  $\mu$  is given by

$$0 \leq \mu \leq \frac{1}{\lambda_{\max}} \quad (8)$$

where  $\lambda_{\max}$  is the largest eigen value of autocorrelation matrix  $R$ . If  $\mu$  is chosen to be very small, then convergence becomes slow. If  $\mu$  is kept large, then convergence becomes fast, but stability becomes a problem. Therefore it is better to select  $\mu$  within bounded conditions as defined in equation (8).

$\xi$  is the performance function describing quadratic function of filter tap-weight vector  $w$  in terms of MSE.  $R$  is the autocorrelation matrix of filter input and is given by

$$R = E[u(n)u^T(n)] \quad (9)$$

and  $p$  is the cross correlation matrix between input and desired signal and is defined by

$$p = E[u(n)d(n)] \quad (10)$$

Solving equation (7) for optimum solution, we have:

$$w_0 = pR^{-1} \quad (11)$$

This equation is known as Wiener Hopf.

If  $p$  and  $R$  are not available to solve Wiener Hopf directly, then we employ an iterative search method in which starting with an initial guess for  $w_0$ , say  $w(0)$ , a recursive search method that require many iterations to converge to  $w_0$  is used. With an initial guess for  $w_0$  at  $n=0$ , the tap-weight vector at the  $n$ th iterations is denoted as  $W(n)$  that finally depends on  $\mu$  for convergence to obtain optimum solution  $w_0$  for smart antenna array consisting of number of elements ( $Ne$ ) that finally leads to obtain minimum MSE.

### 2.2 Simulation Results

Computer simulation is carried out, to illustrate that how various parameters such as number of elements ( $Ne$ ) and element

spacing ( $d$ ), affect the beam formation. The simulations are designed to analyze the properties of LMS and NLMS algorithms. The desired signal is phase modulated with  $SNR = 20$  dB, used for simulation purpose. It is given by

$$S(t) = e^{j\sin(2\pi* f*t)} \quad (12)$$

where  $f$  is the frequency in Hertz.

### 2.2.1 Effect of Number of Elements on Array Factor

Uniform linear array is taken with different number of elements for simulation purpose. The spacing between array elements is taken as  $\lambda/2$ . The optimum weight vector for  $Ne = 12$  with spacing  $\lambda/2$  is given by  $[0.0948-0.0217i, 0.0234-0.0760i, -0.0412-0.0835i, -0.0732-0.0106i, -0.0347+0.0562i, 0.0525+0.0508i, 0.0812-0.0214i, 0.0464-0.0929i, -0.0343-0.0732i, -0.0843+0.0130i, 0.0086+0.0556i, 0.0754+0.0323i]$ . Similarly optimum weight vector for,  $Ne = 8, Ne = 4$  and elements spacing ( $d$ ) can be computed.

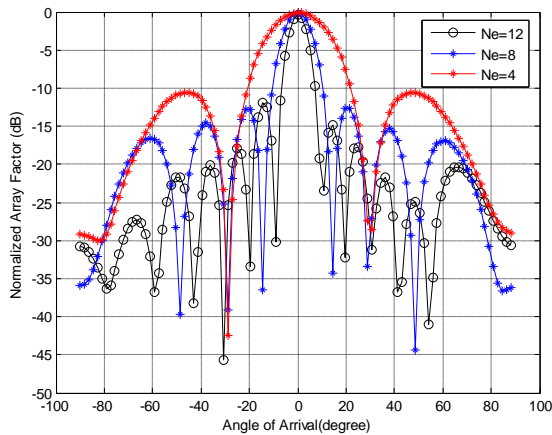

Fig.2. Normalized array factor plot for LMS algorithm with AOA for desired user is 0 degree and - 30 degrees for interferer with constant space of  $\lambda/2$  between elements

Angle of Arrival (AOA) for desired user is set at 0 degree and for interferer at - 30 degrees as shown in Fig. 2 which provides deep null at - 30 degrees but at the same time forms narrow beam in accordance to number of elements.

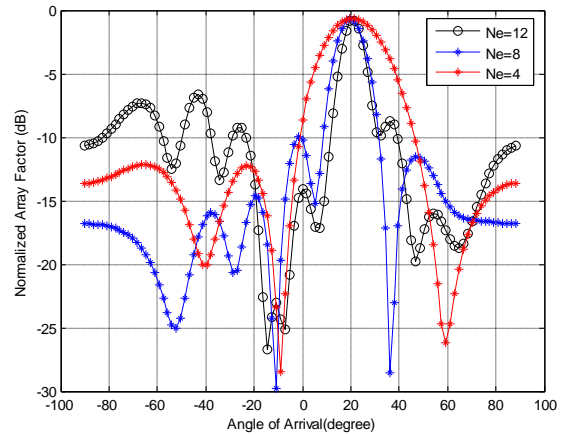

Fig.3. Normalized array factor plot for LMS algorithm with AOA for desired user is 20 degrees and - 10 degrees for interferer with constant space of  $\lambda/2$  between elements

Similarly in Fig.3, we achieved a deep null at -10 degrees and the desired user is arriving at 20 degrees. Therefore, it is proved that for a fixed spacing and a frequency, a longer array ( $Ne = 12$ ) results a narrower beam width but this happens at the cost of large number of sidelobes.

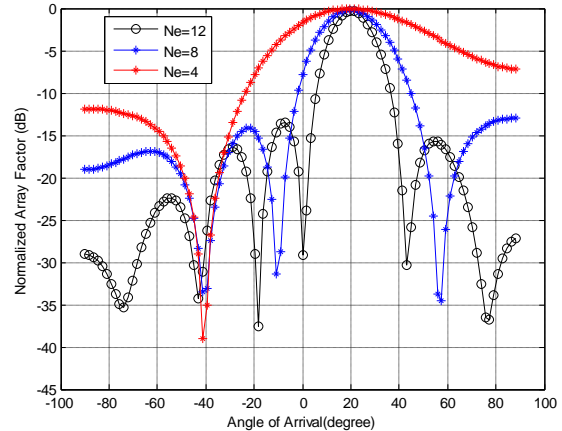

Fig.4. Normalized array factor plot for LMS algorithm with AOA for desired user is 20 degrees and - 40 degrees for interferer with constant space of ( $d = \lambda/4$ ) between elements

In Fig. 4, AOA for desired user is obtained at 20 degrees and deep null is shown at - 40 degrees for  $d = \lambda/4$ . For space  $\lambda/4$ , we got broad beam width as compared to  $d = \lambda/2$  with reduced sidelobes.

### 2.2.2 Effect of Spacing Between Elements on Array Factor

The effect of array spacing for  $\lambda/2$ ,  $\lambda/4$  and  $\lambda/8$  is shown in Fig. 5 for  $N_e = 12$ . Since the spacing between the elements is critical, due to sidelobe problems, which causes spurious echoes and diffraction secondaries, which are repetitions of the main beam within the range of real angles.

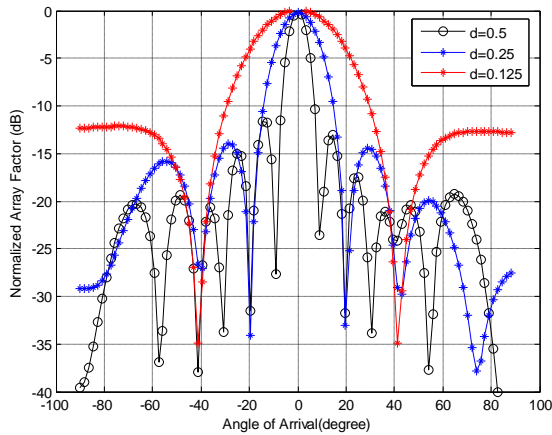

Fig.5. Normalized array factor plot for LMS algorithm for  $N_e = 12$  with interferer – 40 degrees

From Fig. 5, it is observed that increasing element spacing produces narrower beams, but this happens at the cost of increasing number of sidelobes. It is also clear, that spacing between elements equal to  $\lambda/2$  gives optimum result for narrower beam.

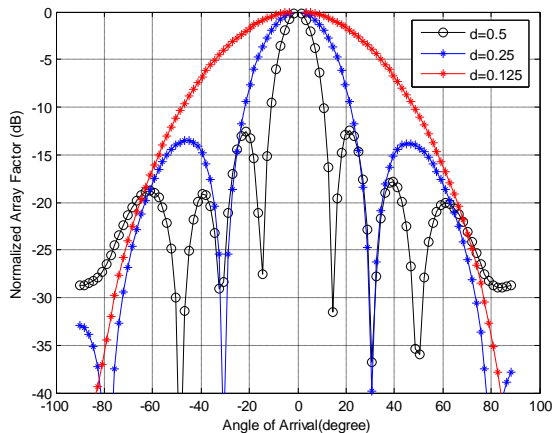

Fig.6. Normalized array factor plot for LMS algorithm for  $N_e = 8$  with interferer – 30 degrees

When number of elements is reduced to 8, then effect of array spacing is shown in Fig. 6. Again, narrower beam width is achieved at  $d = \lambda/2$

### 2.2.3 Effect of Number of Elements on MSE

The effect of number of elements on MSE for constant space  $d = \lambda/2$  and  $d = \lambda/4$  between elements is shown in Fig. 7 and 8, respectively, for same SNR as taken before ( $SNR = 20$ ). From these figures, it is clear that minimum MSE is obtained for  $d = \lambda/2$  when same number of elements is applied for comparison.

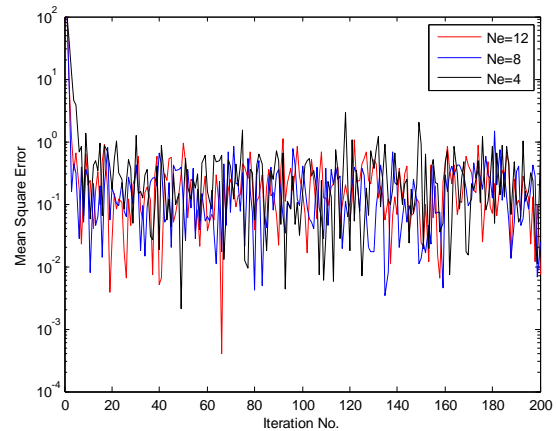

Fig.7. Mean square error for LMS algorithm for  $N_e = 12$ ,  $N_e = 8$ ,  $N_e = 4$  and space ( $d = \lambda/2$ ) is kept constant

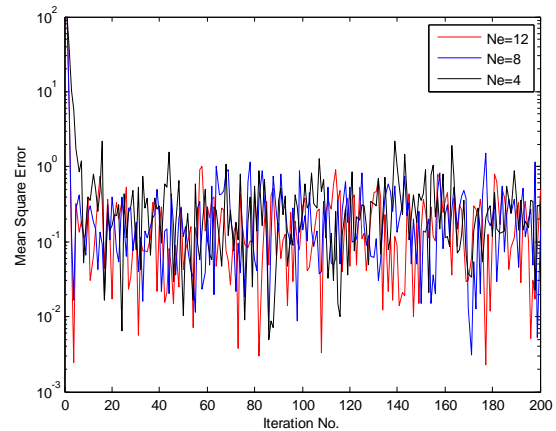

Fig.8. Mean square error for LMS algorithm for  $N_e = 12$ ,  $N_e = 8$ ,  $N_e = 4$  and space ( $d = \lambda/4$ ) is kept constant

### 2.2.4 Effect of Spacing Between Elements on MSE

When space between elements is taken differently for same number of elements ( $Ne = 8$ ) and ( $Ne = 12$ ), then MSE is reduced further for ( $Ne = 12$ ) as compared to ( $Ne = 8$ ). These are shown in Fig. 9 and 10, respectively.

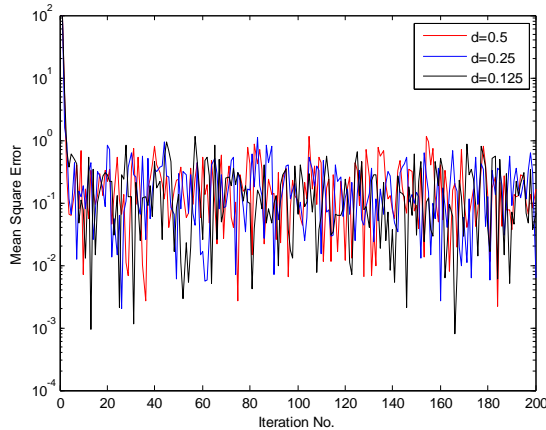

Fig.9. Mean square error for LMS algorithm for  $d = \lambda / 2$ ,  $d = \lambda / 4$  and  $d = \lambda / 8$  and **number of elements ( $Ne = 8$ ) is kept constant**

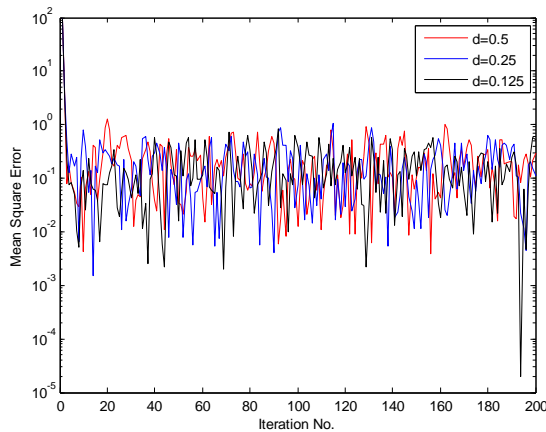

Fig.10. Mean square error for LMS algorithm for  $d = \lambda / 2$ ,  $d = \lambda / 4$  and  $d = \lambda / 8$  and **number of elements ( $Ne = 12$ ) is kept constant**

## 3. NLMS ALGORITHM

### 3.1 Theory

This algorithm uses data-dependent step size  $\mu$  at each iteration and avoids the requirement for calculating the eigen value of

autocorrelation matrix  $R$  or its trace for selection of the maximum permissible step size. In case of this algorithm, only weight update function changes and all other equations remains the same as described for LMS [2] [3] [4]. The weight update equation for the NLMS algorithm is defined as:

$$w(n) = w(n-1) + \mu e(n) \frac{u^*(n)}{\varepsilon + u^H(n)u(n)} \quad (13)$$

where  $H$  denotes the Hermitian transpose, used for complex conjugate of the input signal  $u(n)$ .  $\mu$  is the step size used for convergence to obtain optimum solution  $w_0$  for smart/adaptive antenna consisting of number of elements ( $Ne$ ) spaced equally ( $d$ ) that ultimately leads to get minimum MSE.  $\varepsilon$  is a small positive constant, known as epsilon used for controlling instability in updating of weights.

## 3.2 Simulation Results

### 3.2.1 Effect of Number of Elements on Array Factor

Uniform linear array with same number of sample ( $N = 200$ ) is taken for simulation purpose. AOA for desired user is set at 0 & 20 degrees and deep null is obtained at -30 & -10 degrees for interferer as shown in Fig 11 and 12, respectively. The space  $\lambda / 2$  is maintained between elements. The narrow beam with number of side lobes is observed. The optimum weight vector for  $Ne = 8$  with spacing  $\lambda / 2$  is given by [0.1143-0.0046i, 0.0332-0.1043i, -0.0577-0.1315i, -0.1225+0.0058i, -0.0676+0.1334i, 0.0845+0.0857i, 0.1147-0.0276i, 0.0311-0.1129i]. Similarly optimum weight vector for,  $Ne = 12$ ,  $Ne = 4$  and elements spacing ( $d$ ) can be computed.

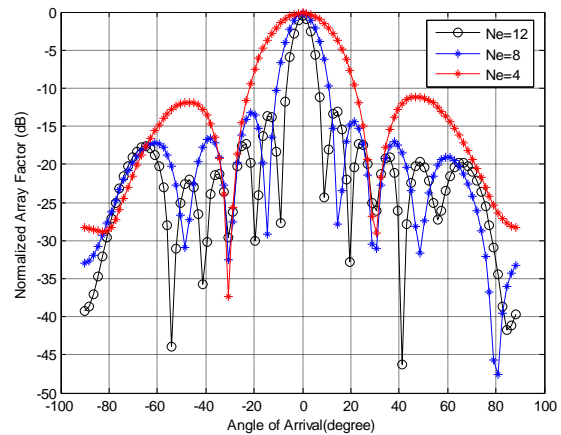

Fig.11. Normalized array factor plot for NLMS algorithm with AOA for desired user is 0 degree and - 30 degrees for interferer with constant space of ( $\lambda / 2$ ) between elements

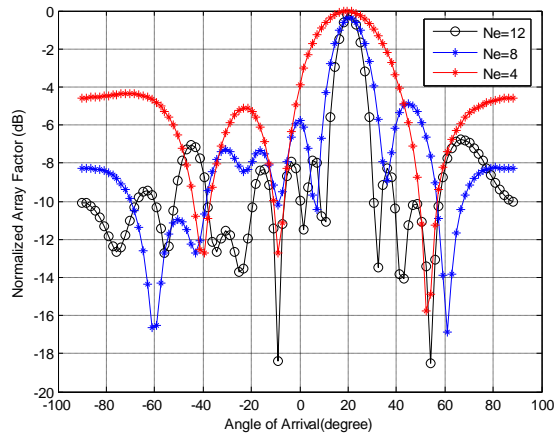

Fig.12. Normalized array factor plot for NLMS algorithm with AOA for desired user is 20 degrees and - 10 degrees for interferer with constant space of ( $\lambda / 2$ ) between elements

Now if space between elements is changed from  $\lambda / 2$  to  $\lambda / 4$ , then broad beam is obtained with reduced sidelobes as shown in Fig. 13.

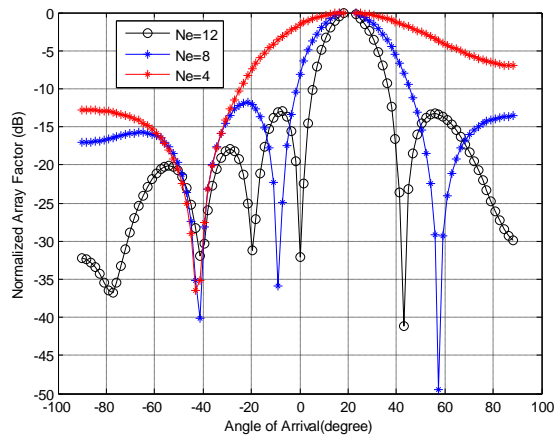

Fig.13. Normalized array factor plot for NLMS algorithm with AOA for desired user is 20 degrees and - 40 degrees for interferer with constant space of ( $\lambda / 4$ ) between elements

### 3.2.2 Effect of Spacing Between Elements on Array Factor

When number of elements is kept constant for different array spacing  $\lambda / 2$ ,  $\lambda / 4$  and  $\lambda / 8$ . Then its effect is shown in Fig. 14 and 15, for  $Ne = 12$  and  $Ne = 8$ , respectively. The sharp beam is obtained for  $\lambda / 2$  and for  $Ne = 12$  as compared to  $Ne = 8$ .

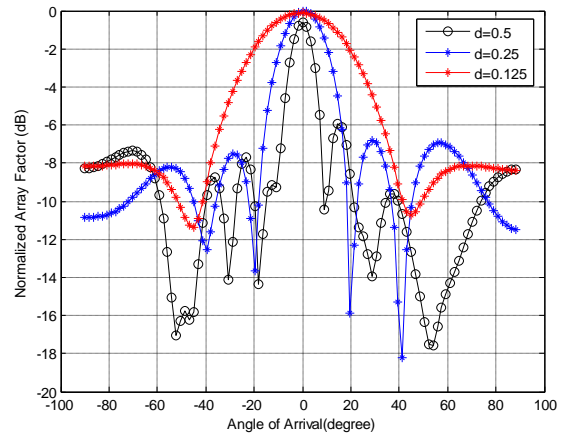

Fig.14. Normalized array factor plot for NLMS algorithm for  $Ne = 12$  with interferer - 20 degrees

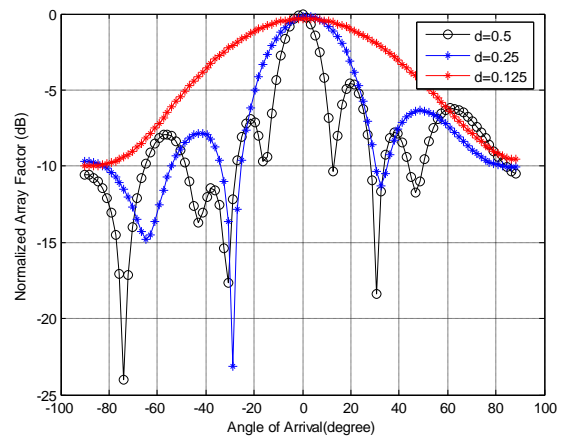

Fig.15. Normalized array factor plot for NLMS algorithm for  $Ne = 8$  with interferer - 30 degrees

### 3.2.3 Effect of Number of Elements on MSE

The mean square error for same data as used for beamforming is shown in fig. 16 for element spacing  $\lambda / 2$  and in Fig. 17 for element spacing  $\lambda / 4$ , respectively. Minimum MSE is obtained for  $Ne = 12$  when distance between elements is kept  $\lambda / 2$  rather than  $\lambda / 4$ .



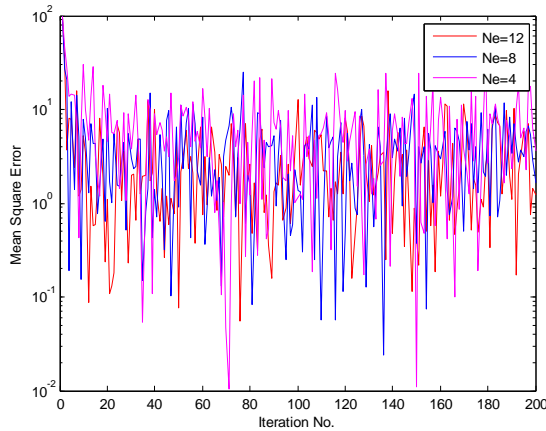

Fig.16. Mean square error for NLMS algorithm for  $Ne = 12$ ,  $Ne = 8$ ,  $Ne = 4$  and space  $(\lambda / 2)$  is kept constant

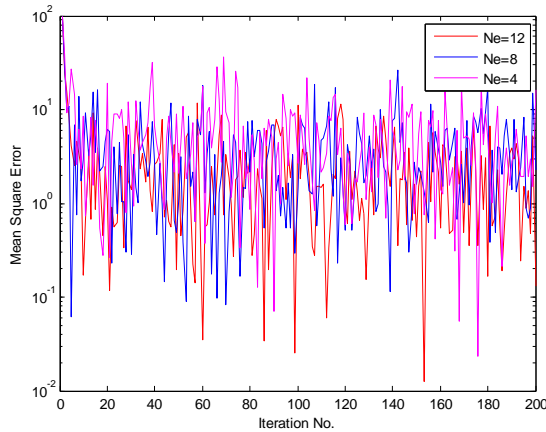

Fig.17. Mean square error for NLMS algorithm for  $Ne = 12$ ,  $Ne = 8$ ,  $Ne = 4$  and space  $(\lambda / 4)$  is kept constant

### 3.2.4 Effect of Spacing Between Elements on MSE

When different spacing between elements are kept i.e.  $d = \lambda/2$ ,  $d = \lambda/4$  and  $d = \lambda/8$  for same number of elements as shown in Fig. 18 for  $Ne = 8$  and in Fig. 19 for  $Ne = 12$ , respectively. It is clear that minimum MSE is obtained for large number of elements ( $Ne = 12$ ).

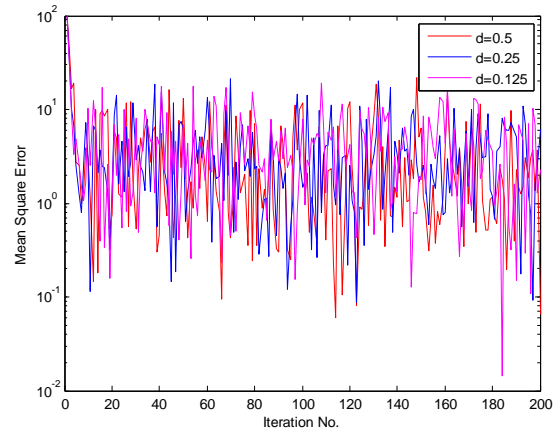

Fig.18. Mean square error for NLMS algorithm for  $d = \lambda / 2$ ,  $\lambda / 4$  and  $\lambda / 8$  and number of elements ( $Ne = 8$ ) is kept constant

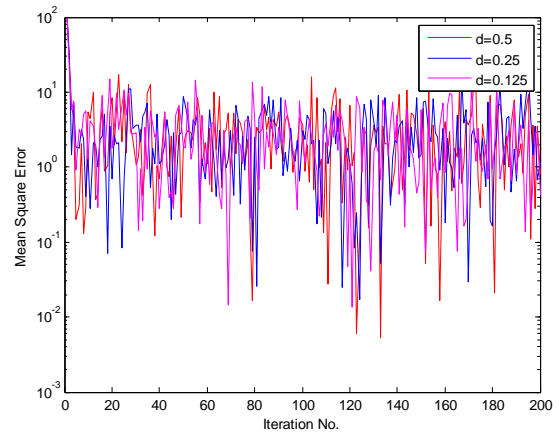

Fig.19. Mean square error for NLMS algorithm for  $d = \lambda / 2$ ,  $\lambda / 4$  and  $\lambda / 8$  and number of elements ( $Ne = 12$ ) is kept constant

## 4. CONCLUSIONS

In this paper, two adaptive beamforming algorithms LMS and NLMS are discussed. These algorithms are used in smart/adaptive antenna array system in coded form, to enhance mobile communication performance. It is confirmed from the simulation results that narrow beam of smart antenna can be steered towards the desired direction by steering beam angle  $\Phi_0$ , keeping elements spacing  $d$ , number of elements  $Ne$  and altering weights  $w(n)$  adaptively for both algorithms. However, LMS algorithm has good response towards desired direction and has better capability to place null towards interferer than NLMS. But the convergence speeds of NLMS algorithm is good than LMS as the speed of convergence for NLMS does not depend on eigen value ( $\lambda_{max}$ ) of input correlation matrix  $R$  that play significant role in optimum solution  $w_0$  in case of LMS. It is also ascertained from the simulation results that the performance of LMS

algorithm is better to minimize MSE for different number of elements and for different spacing maintained between elements using performance function ( $\xi$ ) of the algorithm that minimized the average power in the error signal. However, NLMS algorithm shows deficiency to minimize MSE taking same number of iteration, same number of elements and for different elements spacing. Therefore, LMS is found the most efficient algorithm and also simple in computation than NLMS. LMS is, therefore, a better option to implement at base station of mobile communication systems using CDMA environment to avoid interference and for enhancing capacity.

## 5. REFERENCES

- [1] LAL. C. GODARA, Senior Member, IEEE, "Applications of Antenna Arrays to Mobile Communications, Part I; Performance Improvement, Feasibility, and System Considerations," Proceeding of the IEEE, VOL. 85, NO. 7, pp. 1031-1060, July 1997.
- [2] LAL. C. GODARA, Senior Member, IEEE, "Applications of Antenna Arrays to Mobile Communications, Part II; Beam-Forming and Directional of Arrival Considerations," Proceeding of the IEEE, VOL. 85, NO. 8, pp. 1195-1245, August 1997.
- [3] Simon Haykin, Adaptive Filter Theory, third edition (New Jersey, Prentice-Hall Inc., 1996).
- [4] B. Widrow and S.D. Stearns, Adaptive Signal Processing (New Jersey, Prentice-Hall Inc., 1985).
- [5] Md. Bakhar, Dr. Vani R.M and Dr. P. V. Hunagund, "Eigen Structure Based Direction of Arrival Estimation Algorithms for Smart Antenna Systems," IJCSNS International Journal of Computer Science and Network Security, VOL. 9, NO. 11, pp. 96-100, November 2009.
- [6] F. E. Fakoukakis, S. G. Diamantis, A. P. Orfanides and G. A. Kyriacou, "Development of an Adaptive and a Switched Beam Smart Antenna System for Wireless Communications," Progress in Electromagnetics Research Symposium 2005, Hangzhou, China, pp. 1-5, August 22-26, 2005.
- [7] Rameshwar Kawitkar, "Issues in Deploying Smart Antennas in Mobile Radio Networks," Proceedings of World Academy of Science, Engineering and Technology Volume 31, July 2008, pp. 361-366, ISSN 1307-6884.
- [8] Raed M. Shubair, Mahmoud A. Al-Qutayri and Jassim M. Samhan, "A Setup for the Evaluation of MUSIC and LMS Algorithms for a Smart Antenna System," Journal of Communications, VOL. 2, NO. 4, pp. 71-77, June 2007.
- [9] S.F. Shaukat, Mukhtar ul Hassan, R. Farooq, H. U. Saeed and Z. Saleem, "Sequential Studies of Beamforming Algorithms for Smart Antenna Systems," World Applied Sciences Journal 6 (6): pp. 754-758, 2009 ISSN 1818-4952.
- [10] Kiranpreet Kaur, Magandeep Kaur, Ruchi Mittal, "Improvement in Capacity and Signal Strength Using LMS Algorithms," International Journal of Computer Applications (0975 - 8887), Volume 1 – No. 5, pp. 103-107, 2010.

**Muhammad Yasin** is enrolled for PhD in the field of electrical engineering majoring in telecommunication in Pakistan Navy Engineering College, National University of Science and Technology, Karachi, Pakistan. He is working in Pakistan navy as naval officer in the capacity of communication engineer since 1996. His research interests include signal processing, adaptive filtering, implementation of communication networking and its performance evaluation. He has received a B.Sc. degree in electrical engineering from NWFP University of Engineering and Technology, Peshawar (1994) and M.Sc. degree in electrical engineering from NED, University of Engineering and Technology, Karachi (2006). He has also done a Master degree in Economics (2002) from University of Karachi. In the past, he is involved in implementation of ISO 9000 on indigenous project of AGOSTA 90B Class Submarines along with French engineers. Currently, he is working on indigenous project of Acoustic System Trainer, being used for imparting Sonar related training.