

Performance Analysis of Z-source Inverter Fed Induction Motor Drive

Amol R. Sutar, Satyawan R. Jagtap, Jakirhusen Tamboli

Abstract - This paper presents performance analysis and simulation of maximum constant boost-control with third harmonic injection methods for the Z-source inverter, which can obtain maximum voltage boost for a fixed modulation index. The Z-source inverter is a recently invented a new power conversion concept mainly developed for fuel cell vehicular applications. The Z-source inverter is very advantageous over traditional inverters and it can be employed in all ac and dc power conversion applications. All traditional PWM methods can be used to control Z-source inverter. Maximum constant boost control methods eliminates the low-frequency ripples in the inductor current and capacitor voltage by maintaining the shoot-through duty cycle constant, and minimize the voltage stresses of switching devices at the same time. The Maximum boost control method is suitable for relatively high output frequency only, but in the maximum constant boost control method the Z-source network design is independent of the output frequency and determined only by the switching frequency. In this paper Z-source inverter parameters such as boost factor, output dc link voltage, capacitor voltage, output ac voltage, voltage gain etc. are determined for maximum constant boost control method for a fixed modulation index and these results are verified by simulation and experiments.

Index Terms- traditional inverters, Z-source inverter, voltage boost, boost factor, PWM, third harmonic injection, voltage gain.

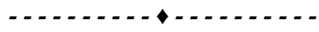

1 INTRODUCTION

Inverters are the dc to ac converters. The input dc supply is either in the form of voltage or current is converted in to variable output ac voltage. The output ac voltage can be controlled by varying input dc supply or by varying the gain of the inverter [8]. There are two types of traditional inverters based on input source used in industries for variable speed drive and many other applications; those are a) Voltage-source inverter and b) Current-source inverter. The gain of the inverter can be controlled by using pulse width modulation. Different PWM techniques are devised to control these inverters. PWM control technique also reduces harmonic distortion in the output signal and improves the performance of the inverter. PWM with third harmonic injection method eliminates third harmonic component from output waveform and also provides higher range of modulation index than regular PWM modulation technique. These PWM waveforms can be generated using analog circuits using active and passive components or it can be generated digitally using microprocessor and microcontroller [4].

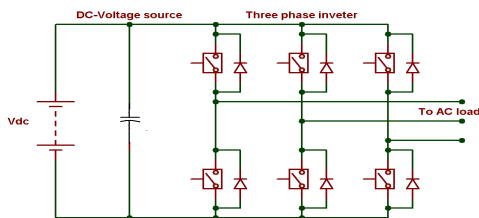

Fig. 1 Traditional voltage source inverter

Figure.1 shows the traditional three-phase voltage-source inverter. The dc voltage source connected at the input side across a large capacitor. DC link voltage produced across this capacitor feeds the main three-phase bridge. The input dc

supply can be a battery or fuel cell stack or diode rectifier, and/or capacitor. Three phase bridge inverter circuit consists of six switches; each is composed of a power transistor and an anti-parallel diode to provide bidirectional current flow and reverse voltage blocking capability. Figure 2 shows the traditional current-source inverter (CSI). The DC current source is formed by a large dc Inductor fed by a voltage source such as a battery or fuel-cell stack or diode rectifier or converter etc. Like VSI three phase bridge inverter circuit consists of six switches; each is composed of a switching device with reverse block capability such as a gate-turn-off thyristor and SCR or a power transistor with a series diode to provide unidirectional current flow and bidirectional voltage blocking. For voltage source inverter and current source inverter the on/off time the switching devices is controlled by applying control voltage (PWM) to the control terminal i.e. gate of the device.

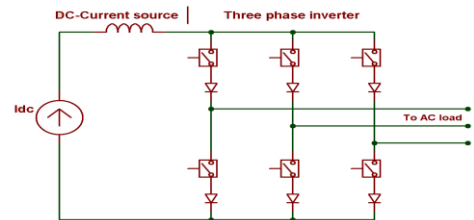

Fig. 2 Traditional current source inverter

Traditionally in most of industries these voltage-source inverter and current-source inverter are used in adjustable speed drives. But these traditional inverters have many limitations as summarized below:

- 1) They are either a buck or a boost converter and cannot be a buck-boost converter [1]. That is, the output voltage is either greater or smaller than the input voltage. The output

voltage of voltage source inverter is always less than input voltage so it is called a buck inverter; hence additional voltage booster circuit needs to be added. While for current source inverter the output voltage is always greater than input voltage so it is called a boost inverter, hence additional voltage regulator circuit needs to be added. This increases additional component cost.

- 2) For VSI and CSI main bridge inverter circuits cannot be interchangeable. In other words the voltage-source inverter main circuit cannot be used for the current-source inverter or vice versa.
- 3) The shoot-through problem for Voltage source inverter and open circuit problem for current source inverter by electromagnetic interference (EMI) noises reduce the inverter's reliability. In case of voltage source inverter both upper and lower transistors should not be switched on simultaneously, otherwise it would cause shoot-through, which may damage inverter circuit due to large current. Hence dead time to block both upper and lower devices needs to be provided in the V-source inverter, which causes waveform distortion.
- 4) In case of current source inverter both upper and lower transistors should not be switched off simultaneously, otherwise it would cause open circuit along the bridge arm, which may damage inverter circuit due large voltage drop across open circuit. Hence overlap time where both upper and lower devices conduct simultaneously needs to be provided for safe operation, which causes waveform distortion.

2 Z-SOURCE INVERTER

The new impedance-source power inverter has been recently invented, eliminates all problems of the traditional V-source and I-source inverters. It is being used in ac/dc power conversion applications. Fig.3 shows the general Z-source converter structure. The power source can be either voltage source or current source.

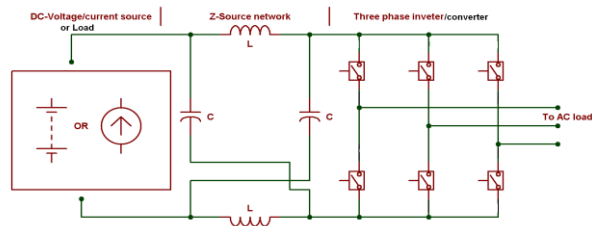

Fig. 3 Z-Source inverter structure

The Z-source inverter consists of a unique impedance network which couple the converter main circuit to the power source, load, or other converter [1], for providing unique features that cannot be observed in the traditional VSI and CSI inverters. The impedance network consists of two inductors and two capacitors connected to each other as shown in the

figure forms the second order filter network. The values of both inductor and both capacitor are equal. The two inductors can be two separate inductors or two inductors inductively coupled to each other on a single core. For size and cost reduction film capacitors of desired value and voltage rating can be selected.

2.1 PWM Control of ZSI

The conventional PWM inverter topology imposes high voltage stresses to the switching devices and motor and limits the motor's constant power speed ratio [6]. The dc/dc boosted PWM inverter topology can alleviate the stresses and limitations, however, suffers from problems such as high cost and complexity associated with the two-stage power conversion. Traditional PWM consists of six active states and two zero states. In traditional zero state either upper three or lower three switching devices of inverter bridge are on and does not provide current to the load so the load voltage is essentially zero in the zero state. In case of Z-source inverter in addition to six traditional active states and two zero state it consists of one more state called as shoot-through state. In a shoot-through state both upper and lower switching devices in a single arm or all the three arms conducts simultaneously, hence producing short circuit across load. Therefore output voltage across the load remains zero in the shoot-through state. Thus the effect of shoot-through state is same as traditional zero state. In Z-source inverter the part of zero state or entire zero state is converted in to shoot-through state, where both upper and lower switching device of one or all the three arm of bridge inverter conducts simultaneously. The shoot-through zero state is forbidden in the traditional voltage source inverter, because it would cause a shoot-through. The Z source network makes the shoot-through zero state possible. This shoot-through zero state provides the buck-boost feature to the inverter. Therefore, to maintain sinusoidal output voltage, the active-state duty ratio is maintained same and some or all of the zero states turned into shoot-through state. The traditional PWM control methods that can be used to control Z-source inverter are:

1. Simple boost control
2. Maximum boost control
3. Maximum constant boost control

The comparison of all of these PWM methods is presented in [2] and [6]. The simple boost control method is simple but produces higher voltage stresses across switching devices. In maximum boost control method the voltage stress across switching devices is reduced but the design of the impedance network depends on the output frequency. The maximum constant boost control with or without third harmonic injection method overcomes the limitations of simple boost and maximum boost control methods.

2.2 Z-source inverter analysis

The equivalent circuit of Z-Source inverter in the active state is shown in Fig. 4. In the active state the inverter circuit acts as a current source as shown in the figure 4. The input power source is a dc voltage source V_{dc} that is applied to the Z-Source inverter through reverse blocking diode D. All traditional PWM techniques are applicable for Z-Source inverter. During the shoot-through time (T_0) the DC link voltage V_{dcl} is boosted to a value greater than input voltage, hence input diode will be reverse biased blocking reverse flow of current. The detailed analysis of Z-source inverter is given in [1]. The average dc-link voltage across the inverter bridge is given by:

$$V_{dcl} = V_c = ((1 - T_0/T) / (1 - 2T_0/T)) V_{dc} \quad (1)$$

Where, V_{dcl} is the average dc link voltage equal to capacitor voltage V_c , T is a switching period and T_0 is shoot-through time over a switching period. The peak dc-link voltage across the inverter bridge is expressed as

$$V_{dclp} = (T / (T_1 - T_2)) V_{dc} = B V_{dc} \quad (2)$$

where;

$$B = T / (T_1 - T_0) = 1 / (1 - 2T_0/T) \geq 1 \quad (3)$$

is the boost factor resulting from the shoot-through zero state.

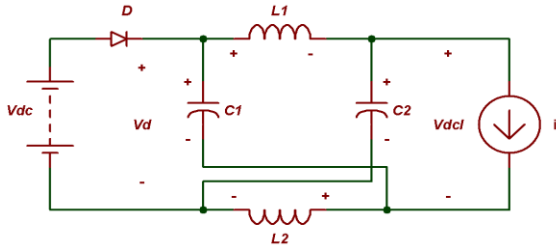

Fig. 4 Equivalent circuit of Z-Source inverter with inverter in active state

The peak dc-link voltage is the equivalent dc-link voltage of the inverter. On the other side, the output peak phase voltage from the inverter can be expressed as;

$$V_{acp} = M V_{ip} / 2 \quad (4)$$

In above equation M is the modulation index of PWM waveform, V_{acp} is output peak phase voltage and V_{ip} is peak dc link voltage across bridge inverter. Using (2) and (4) peak phase voltage can be expressed as

$$V_{acp} = M B V_{dc} / 2 \quad (5)$$

For the traditional V-source PWM inverter, the output peak phase voltage is given by $V_{acp} = M V_{dc} / 2$. Where Modulation index M is always less than unity hence in traditional inverter the output voltage is always less than input dc voltage. Equation (5) shows that in Z-Source inverter the output voltage can be stepped up and down by choosing an appropriate buck-boost factor B_B . The buck-boost factor is determined by the modulation index M and boost factor B . For Z-source inverter the boost factor is always greater than or equal to unity. When boost factor is equal to unity the Z-source inverter acts like traditional inverter. The boost factor B

as expressed in (3) can be controlled by varying shoot-through duty cycle T_0/T of the inverter PWM input.

3 MAXIMUM CONSTANT BOOST PWM WITH THIRD HARMONIC INJECTION CONTROL METHOD

In order to reduce the volume and cost, the shoot-through duty ratio must be kept constant [2]. At the same time, a greater voltage boost for any given modulation index is desired to reduce the voltage stress across the switches. The maximum constant boost control achieves the maximum voltage gain while always keeping the shoot-through duty ratio constant. Maximum Constant boost control with third harmonic injection method is devised to produce the maximum constant boost while minimizing the voltage stress.

Shoot-through pulses are generated as shown in fig.7. These shoot-through pulses can be generated by using triangular waveform generator and comparator. Shoot-through time is decided by the two reference levels called shoot-through level. When triangular carrier wave exceeds above upper shoot-through level or below lower shoot-through level a shoot-through pulse is generated. Shoot-through time remains almost constant from switching cycle to switching cycle. These shoot-through pulses are evenly spread in traditional PWM waveform to obtain PWM waveform with shoot-through.

Figure 8 shows third harmonic injected PWM with shoot-through and the control method is referred as maximum constant boost control with third harmonic injection. The third and higher harmonic component can be injected into fundamental to reduce harmonic distortion in the output waveform [8]. The third harmonic component with 16.6% of the fundamental component is injected into the modulating signals. From the figure 8, it can be seen that the upper shoot-through level is always equal to or higher than the maximum value of the reference signals, and the lower shoot-through level is always equal to or lower than the minimum value of the reference signals. Therefore, the shoot-through states only occur during the traditional zero states. As a result, this control method maintains the output voltage waveform. As shown in Fig.8, at an angle of $\pi/3$ of modulating signal the third harmonic component crosses zero and then increases towards negative peak. Therefore at $\pi/3$ V_a reaches its peak value $(\sqrt{3}/2)M$ while V_b is at its minimum value $-(\sqrt{3}/2)M$. In this method only two straight lines are needed to control the shoot-through time with the third harmonic injection. The boost factor depends up on the shoot-through duty cycle. If the shoot-through duty cycle is kept the same from switching cycle to switching cycle boost factor remains constant. Thus the maximum boost factor B can be obtained while keeping it constant all the time.

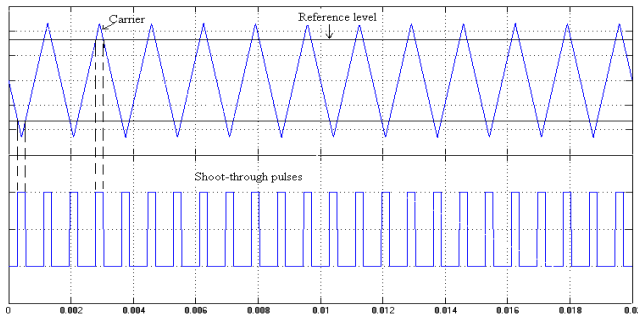

Fig. 7 Shoot-through pulses

The distance between these two reference levels determining the shoot-through duty ratio is always constant $((\sqrt{3}/2)M - (-\sqrt{3}/2)M)$ for a given modulation index M , that is, $\sqrt{3}M$. Therefore, the shoot-through duty ratio is constant and can be expressed from the graph as;

$$\frac{T_0}{T} = \left(\frac{2 - \sqrt{3}M}{2} \right) = \left(1 - \frac{\sqrt{3}M}{2} \right) \quad (6)$$

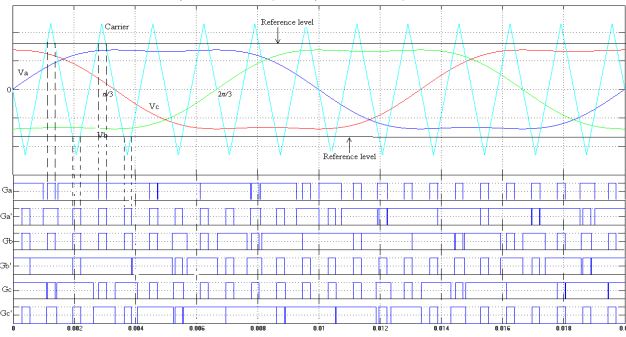

Fig. 8 Maximum constant boost control with third harmonic injection- PWM waveform

The boost factor B and the voltage gain G can be calculated as follows

$$B = \frac{1}{1 - 2T_0/T} = \frac{1}{\sqrt{3}M - 1} \quad (7)$$

$$G = \frac{V_{acp}}{V_{dc}/2} = M.B = \frac{M}{\sqrt{3}M - 1} \quad (8)$$

Where V_{acp} is the peak value of the output phase voltage, V_{dc} is the input dc voltage, M is the modulation index, and B is the boost factor determined by the shoot-through time interval (T_0) over a switching cycle (T), or the shoot-through duty ratio (T_0/T). Equation (7) gives relation between modulation index and boost factor for this method. The third-harmonic-injection control method has a larger modulation index (M) range, which can be increased from 0.577 to 1.154. Equation (8) shows that voltage gain is infinite for $M = \sqrt{3}/3$ or 0.57 and decreases as the modulation index is increased. At $M = 2/\sqrt{3}$ or (1.154) gain of inverter becomes zero.

4 SIMULATION RESULTS

Simulation is performed using MATLAB/SIMULINK software. Simulink library files include inbuilt models of many electrical and electronics components and devices such as diodes, MOSFETS, capacitors, inductors, motors, power

supplies and so on. The circuit components are connected as per design without error, parameters of all components are configured as per requirement and simulation is performed. Maximum constant boost control with third harmonic injection method is used for PWM generation and simulation. The complete simulation diagram is shown in the figure 9. The component values of Z-source inverter depends on switching frequency only. These component values are chosen as per design guidelines in [1] and [3]. For this circuit $L1 = L2 = 4mH$ and $C1 = C2 = 1000\mu F$. The purpose of the system is to produce 230Vrms line to line voltage. For PWM generation the carrier frequency is set to 10 KHz and modulating reference signal frequency is set to 50Hz. The modulation index is 0.8 and the input DC voltage is 188V. Maximum constant boost PWM with third harmonic injection is generated using PWM generator and logic circuit. The PWM generator block generates normal three phase PWM waveforms for a given carrier frequency.

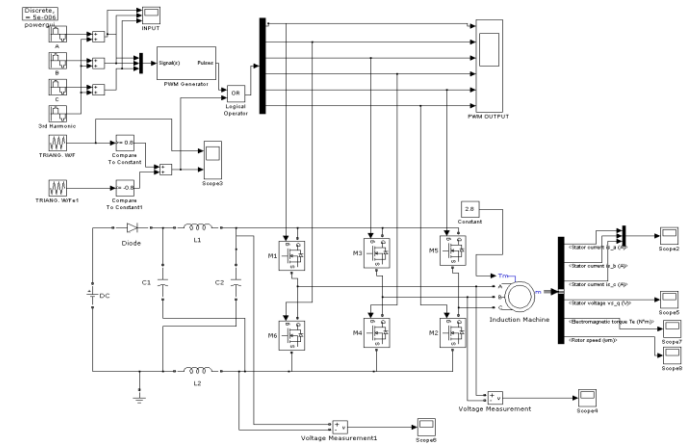

Fig. 9 Simulation configuration

Using triangular function, comparator and adder repeated shoot-through pulses are generated. These shoot-through pulses are evenly spread in all the three phase PWM waveform using OR logic function.

The detailed analysis is given below. The shoot-through duty ratio can be is calculated as $T_0/T = 0.308$

The boost factor = $B = 2.593$

Average dc link voltage = $V_{dcl} = 337V$

Peak dc link voltage = $V_{dcl} = 2.593 * 188 = 487V$

Peak ac output voltage = $V_{acp} = 0.8 * 2.593 * 188 / 2 = 194.5V$

RMS ac output voltage $V_{ac} = 137.5V$

Output line to line rms voltage = $\sqrt{3} * 137.5 = 238V$

The buck-boost factor = $B_B = 0.8 * 2.593 = 2.075$

The capacitor voltage = $V_c = 337V$

Gain of inverter = $G = 2.075$

The voltage gain of inverter obtained in above analysis is 2.075. As we increase the shoot-through time interval (T_0), the boost factor will increase and this will increase the inverter voltage gain. Thus inverter boost factor and voltage gain both

are depends on the shoot-through time. The simulation results with the same input voltage and carrier frequency are shown in following Figures, which agrees well with the analysis and theoretical results. For a traditional inverter, to obtain the output voltage of 230Vrms with modulation index of 0.8, 486V dc voltage is required this is undesirable since it will require additional voltage booster circuit. Figure 10 shows input dc voltage applied to Z-source inverter is 188V. The capacitor voltage is the average dc link voltage remains almost constant about 337V as shown in figure 11. Thus the input voltage (188V) is boosted (337V) and applied as dc link voltage. The peak value of this dc link voltage appears as input voltage across the main inverter circuit.

The output dc link voltage across Inverter Bridge appears as shown in the figure 12. The peak dc link voltage remains almost constant about 480V. It is observed that during shoot-through state dc link voltage becomes zero since all devices in main inverter are switched on simultaneously, short circuiting the dc link.

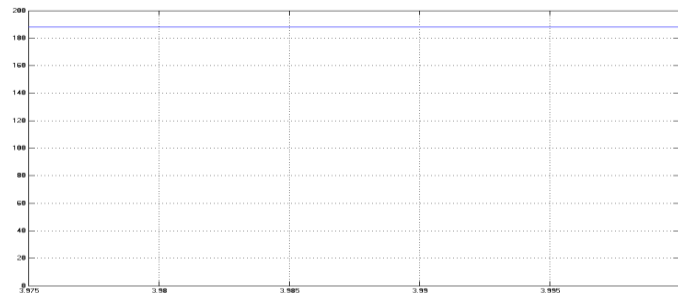

Fig. 10 Input DC voltage = 188V.

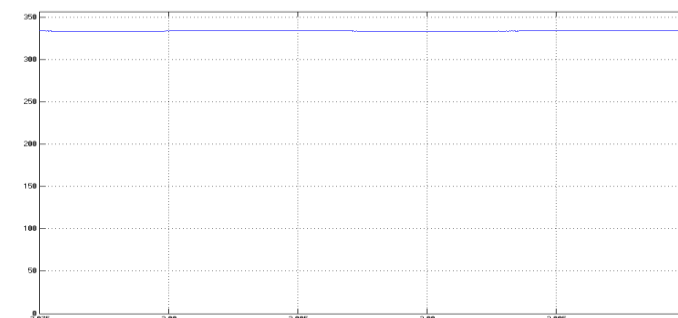

Fig. 11 Capacitor voltage = 337V

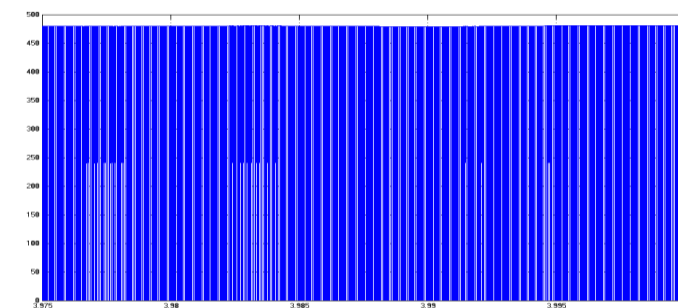

Fig.12. Peak dc Link voltage across inverter Bridge = 480V

Three phase stator current waveforms and stator voltage for a given load condition is shown in the figure 13 and 14 respectively. Stator current waveforms are observed to be very smooth sinusoidal waveform as compared to the traditional PWM inverter.

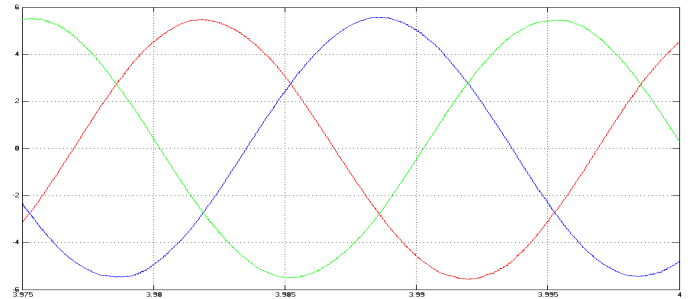

Fig. 13 Three phase stator current

Fig.15 shows the simulation and experimental results of diode voltage and inductor current. The diode is reverse biased by capacitor voltage during shoot-through when all the six switches are turned on, blocking the reverse flow of current. Also, we can see that during the shoot-through period, the capacitor voltage becomes equal to the inductor voltage. The capacitor charges the inductor so that the inductor current increases during this time and releases its energy during active state.

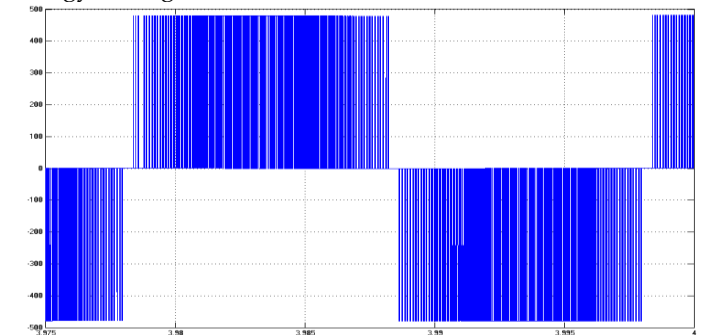

Fig. 14 line to line stator voltage

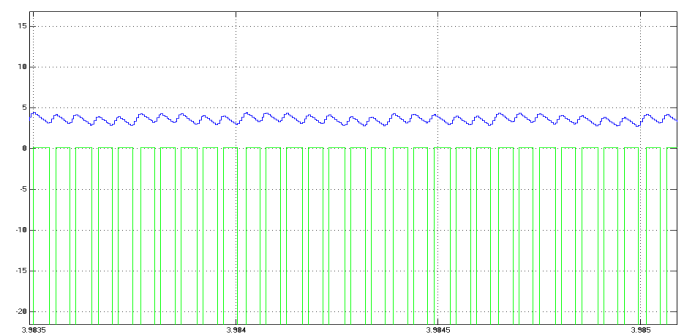

Fig. 15 Diode voltage and inductor current

This is the basic property of the Z-source inverter. Due to this operational behavior, z-source inverter can boost the output voltage to any value greater than input voltage.

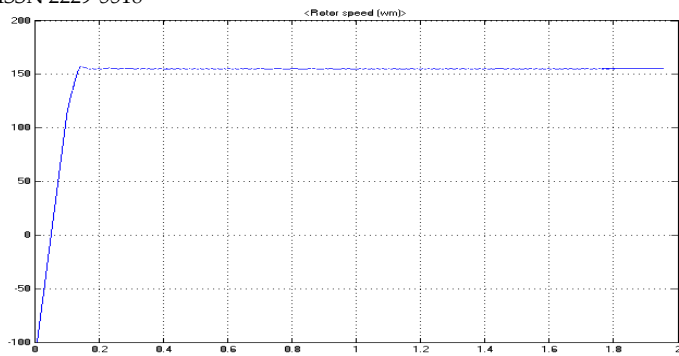

Fig. 16 Speed Variation

The simulation result for speed variation of the induction motor is shown in the following figure 16. Initially speed of induction motor increase linearly where at that time the motor fetches more current so as to maintain the torque. Under steady state condition the maximum speed of induction motor is observed to be about 157rad/s. In terms of rpm the maximum speed is 1500rpm.

5 CONCLUSION

The Z-source converter overcomes the conceptual and theoretical barriers and limitations of the traditional voltage-source converter and current-source converter and provides an advanced power conversion concept. The Z-source inverter system can produce an output voltage greater than the dc input voltage by controlling the shoot-through duty ratio, which is impossible for the traditional ASD systems. In this work, described the operating principle, analyzed the circuit characteristics, and demonstrated its concept and superiority.

Different PWM techniques and their comparison are presented. Maximum constant boost control method is more advantageous PWM control method among the other PWM control methods. Maximum constant boost with third harmonic injection PWM control method increases output voltage boost while minimizing voltage stresses across switching devices. It allows over-modulation where modulation index can be varied from 0.57 to 1.154. Z-Source inverter fed IM drive system is simulated using Simulink software using above described PWM method. Results of simulation are compared with traditional PWM inverter. Following results are observed,

1. Shoot-through state is allowed by switching on all devices in the main inverter, thus EMI noise does not affect operation of Z-source inverter. This shoot-through state does not allowed in traditional inverter.
2. The low frequency ripples in the inductor current and capacitor voltage are eliminated completely.
3. Output voltage can be boosted to any desired value by varying shoot-through period T_0 , in zero states without changing active state for a fixed modulation index.

4. Shoot-through state is determined by two straight lines, so it is easier to maintain constant shoot-through state and hence the boost factor for all the time.
5. Component size (L & C) and hence cost required is less as compared to traditional PWM inverter.
6. Stator current is smooth as compared with traditional PWM inverter. Small permissible ripples in stator current are observed at lower carrier frequency and at higher carrier frequency very smooth stator current is observed.

REFERENCES

- [1] Fang Zheng Peng, "Z- Source Inverter", IEEE Transaction on Industry Applications. 39: 2003,2. Wuhan,China.
- [2] Miaosen Shen, Jin Wang, Alan Joseph, Fang Zheng Peng, Leon M. Tolbert, and Donald J. Adams, "Constant Boost Control of the Z-Source Inverter to Minimize Current Ripple and Voltage Stress", IEEE Transactions on industry application vol. 42, no. 3, May/June 2006
- [3] S. Rajakaruna, Member, IEEE and Y. R. L. Jayawickrama, "Designing Impedance Network of Z-Source Inverters" IEEE Transactions on industry application.
- [4] G. Pandian and S. Rama Reddy, "Embedded Controlled Z Source Inverter Fed Induction Motor Drive" IEEE transaction on industrial application, vol.32, no.2, May/June 2010.
- [5] K. Srinivasan and Dr. S. S. Das, "Performance Analysis of a Reduced Switch Z-Source Inverter fed IM Drives", Journal of Power Electronics, Vol. 12, No. 2, May/June 2010.
- [6] Omar Ellabban, Joeri Van Mierlo and Philippe Lataire, "Comparison between Different PWM Control Methods for Different ZSource Inverter Topologies" IEEE Transactions on industry application, May/June 2010
- [7] K.Niraimathy, S.Krithiga, "A New Adjustable-Speed Drives (ASD) System Based On High-Performance Z-Source Inverter", 978-1-61284-379-7/11 2011 IEEE, 2011 1st International Conference on Electrical Energy Systems
- [8] Muhammad H. Rashid, "Power Electronics", Second Edition, Pearson Education.