

# Performance Evaluation of a New Technique for IP Support in a WDM Optical Network: Optical Composite Burst Switching (OCBS)

Andrea Detti, V. Eramo, and M. Listanti, *Member, IEEE*

**Abstract**—In this paper, the optical composite burst switching (OCBS) technique is proposed to be implemented in an all-optical backbone network to support Internet protocol (IP) traffic. The OCBS is based on two main features. First, several IP packets are assembled in a single macropacket, called burst. Second, the burst contention in an optical switch is handled by means of two techniques, the wavelength dimension and the burst-dropping (BD) technique. Different from traditional optical burst switching, where an entire burst is discarded when all of the output wavelengths are engaged at the arrival instant of the burst, a switch adopting the BD technique discards only the initial part of a burst finding all of the engaged output wavelengths while forwarding the final part of the burst, beginning at the instant in which one wavelength becomes free. The OCBS allows an increase in the switch throughput in terms of number of accepted IP packets because a burst contains a given number of IP packets. We introduce the analytical model that allows us to evaluate the effectiveness of the technique and, in particular, the obtained saving; furthermore, a sensitivity analysis of the saving, with respect to both the optical burst switch parameters and the traffic load, is carried out.

**Index Terms**—Dimensioning, optical burst switching, performance evaluation, wavelength conversion, wavelength division multiplexing (WDM) networks.

## I. INTRODUCTION

THE increase in the demand of transport capacity due to the explosive growth of the Internet protocol (IP)-based traffic has fueled the development of high-speed transmission systems and the emergence of wavelength division multiplexing (WDM) technology [1]–[3] that, in the near future, will support hundreds of wavelengths of several gigabits per second each. However, the bottleneck due to the processes required for switching IP packets within the routers could not allow IP networks to take the full advantage of the huge capacity of the underlying transmission systems.

Some research efforts are directed toward the study and the definition of network architectures in which the transmission and the low-level switching functions are realized in the optical domain while the forwarding and routing functions are implemented in the electronic domain. Such architectures aim at reducing the processing requirements in the IP routers and, furthermore, at implementing switching and transmission infra-

structures transparent to the bit rates and the coding formats [4]–[7].

The first optical switching paradigm that has been proposed in literature is the optical packet switching (OPS) [8]–[11] based on fixed-length packets and synchronous node operation [12], [13]. The drawbacks of this approach mainly consist of the difficulty of implementing the optical synchronizer and of processing the packet headers in the electronic domain [14]. A more recent and more promising proposal in this direction, at least in short-medium term, is a new switching paradigm called optical burst switching (OBS) [15]–[18] based on variable length packets (called *bursts*), asynchronous node operation, and the decoupling of the burst payload from its header with control packets transferred on wavelengths different from the data ones.

The question arising is how to carry IP traffic by means of a new network architecture adopting the OBS switching paradigm. OBS requires that the bursts should be at least several kilobytes long, which is not the case in the present IP packets. Long bursts offer two main advantages, reducing the packet forwarding rate in the core switches and overcoming the link efficiency problems due to the guard times between optical packets needed in order to take account of the switching times of the optical devices in the core switches. The issues mentioned require the aggregation of several IP packets in a single optical burst and, hence, it is necessary to implement the assembly and disassembly functions from IP packets to the burst format and vice versa.

In this view, the Internet transport architecture is structured in two functional layers. The external layer, compatible with the today's Internet transport architecture, is the electronic layer performing traffic aggregation and main packet-routing functions, whereas the internal layer, here called switched optical network (SON), is based on the optical technology and performs transmission and low layer switching functions. Some edge switches (ES) are located at the boundary between the two layers. IP traffic is injected in ES's by standard electronics networks, i.e., local area networks (LANs), metropolitan area networks (MANs). The ES's perform traffic aggregation, burst composition, and routing functions, i.e., they assemble in a single burst a set of incoming IP packets directed toward the same remote ES. Once a burst is composed, it is forwarded through the SON.

One of the key problems in the application of burst switching in an optical domain is the handling of burst contentions that take place when two or more incoming bursts are directed to the same output line. Various techniques have been examined in

Manuscript received July 31, 2000; revised August 2, 2001.

A. Detti is with the University of Rome "Tor Vergata," Roma 110-00133, Italy (e-mail: a.detti@net.infocom.uniroma1.it).

V. Eramo and M. Listanti are with the University of Rome "La Sapienza," Roma 18-00184, Italy (e-mail: marco@infocom.ing.uniroma1.it).

Publisher Item Identifier S 0733-8724(02)00468-1.

the literature. The most important techniques are buffering and wavelength dimension. The application of buffering technique would make the structure of an optical burst switch strictly close to that of a traditional electronic packet switch; therefore, it has been extensively studied, e.g., in [19], [20]. Unfortunately, at least with current technology, optical buffers can be only implemented through a bundle of fiber delay lines (FDLs). This significantly reduces the buffer capacity of an optical packet switch and the number of FDLs becomes a critical system design parameter because it has a heavy impact on the optical hardware volume, on the switch size, and on the noise level due to the transit of optical signal in FDLs. The wavelength dimension technique [21] uses the wavelength dimension as a logical buffer in the WDM optical network layer. In [21], a network solution is proposed that eliminates the need for optical buffers by splitting the traffic load on the wavelength channels by means of tuneable optical wavelength converters.

In this paper, we propose and analyze a new switching paradigm, called optical composite burst switching (OCBS), to be implemented in the SON for the support of IP traffic. The OCBS is derived from the OBS and its basic features are that the aggregation of several IP packets in a single macropacket, called burst, and that the burst contention is handled by means of two techniques, the wavelength dimension previously mentioned and the burst-dropping (BD) technique.

In traditional OBS, an entire burst is discarded when all of the output wavelengths are engaged at the arrival instant of the burst. In contrast, a switch adopting the BD technique discards only the initial part of a burst as long as a wavelength becomes free on the output fiber; from this instant, the switch will transmit the rest of the burst. Note that OCBS allows the switch throughput to be increased in terms of the number of accepted IP packets because a burst contains a given number of IP packets [23], [24]. In our analysis, we introduce analytical models that allow us to evaluate the effectiveness of the technique and, in particular, the savings obtained in terms of IP packet-loss probability when both the wavelength dimension and the BD techniques are adopted with respect to the case in which only the former is used. Furthermore, a sensitivity analysis of the performance of an OCBS, with respect to both the optical burst switch parameters and the traffic load, is carried out.

The present paper is organized as follows. The proposed architecture of the switched optical network is discussed in Section II; the analytical models to evaluate the performance are described in Section III. In Section IV, numerical examples and performance results are given. Finally, in Section V, we discuss the achieved results and give comments about further research items.

## II. SWITCHED OPTICAL NETWORK ARCHITECTURE

The proposed network architecture is sketched in Fig. 1. Two functional layers are envisaged; the external one is the electronic layer performing traffic aggregation and main packet routing functions, whereas the internal layer, here called SON, adopts OCBS. It is based on the optical technology and performs transmission and low layer switching functions.

Some ES's are located at the boundary between the two layers. IP traffic is injected into ES's by standard electronics networks, i.e., LANs, MANs. The ES's perform traffic aggregation, burst composition, and routing functions, i.e., they assemble in a single burst a set of incoming IP packets directed toward the same remote ES. Once a burst is composed, it is forwarded through the SON.

The choice to aggregate more IP packets in an optical burst is made for two reasons, to obviate or ameliorate the bottleneck in the core switches by reducing the burst-forwarding rate, and to reduce the link inefficiency due to the guard times inserted between the optical packets in order to take into account the switching times of the optoelectronic devices. Nevertheless, a critical issue in the aggregation technique is the waiting time of the IP packets needed in this assembly process; this issue is discussed in [23]. Moreover, packet aggregation function entails that the performance of the switched optical network must be evaluated in terms of indexes characterizing the IP packets and not the optical bursts; furthermore, the techniques, introduced inside the optical switch to solve the packet contention problems, must be chosen in order to minimize the IP packet loss and not the burst loss, although the two indexes are tied to each other. The present section is organized as follows. The adopted IP packet delineation protocol is discussed in Section II-A. The OCBS is described in Section II-B, in which the BD technique for solving burst output contentions inside the optical switches is also illustrated.

### A. IP Packets Delineation Protocol

The IP packet delineation function is implemented inside the ES's as illustrated in Fig. 1; this is needed for the destination ES's in order to discriminate the IP packets contained in an optical burst. Many popular point-to-point data link protocols use the high-level data link control (HDLC) framing mechanism [25], which delineates protocol data unit (PDU) by means of a special bit pattern or flag. When such a flag occurs in the payload portion of a frame, an escape byte, used to pad the transmitted byte stream, enables the receiver to differentiate between a true framing flag and an occurrence of the flag pattern in the user information. The need to process each byte in the incoming byte stream to identify the flag pattern makes this frame delineation method increasingly more complex and expensive to implement as the interface speed increases. In order to overcome this problem, the simple data link (SDL) protocol has been proposed [26], [27]. Based on using a length indicator field and a header cyclic redundancy (CRC), rather than a flag, to delineate frames, SDL is inherently scalable to high speeds and provides constant transmission overhead. An example of a possible SDL frame structure is sketched in Fig. 2. Fields are transmitted from left to right. Here, we provide a brief interpretation of each field in an SDL PDU.

- *Length Indicator (LI) field.* This field, two octets long, contains the length of the information field (IP packet) in bytes. This field allows the specification of a length up to 64 kB. This length allows the receiver to identify the end of the current PDU and the beginning of the next one.

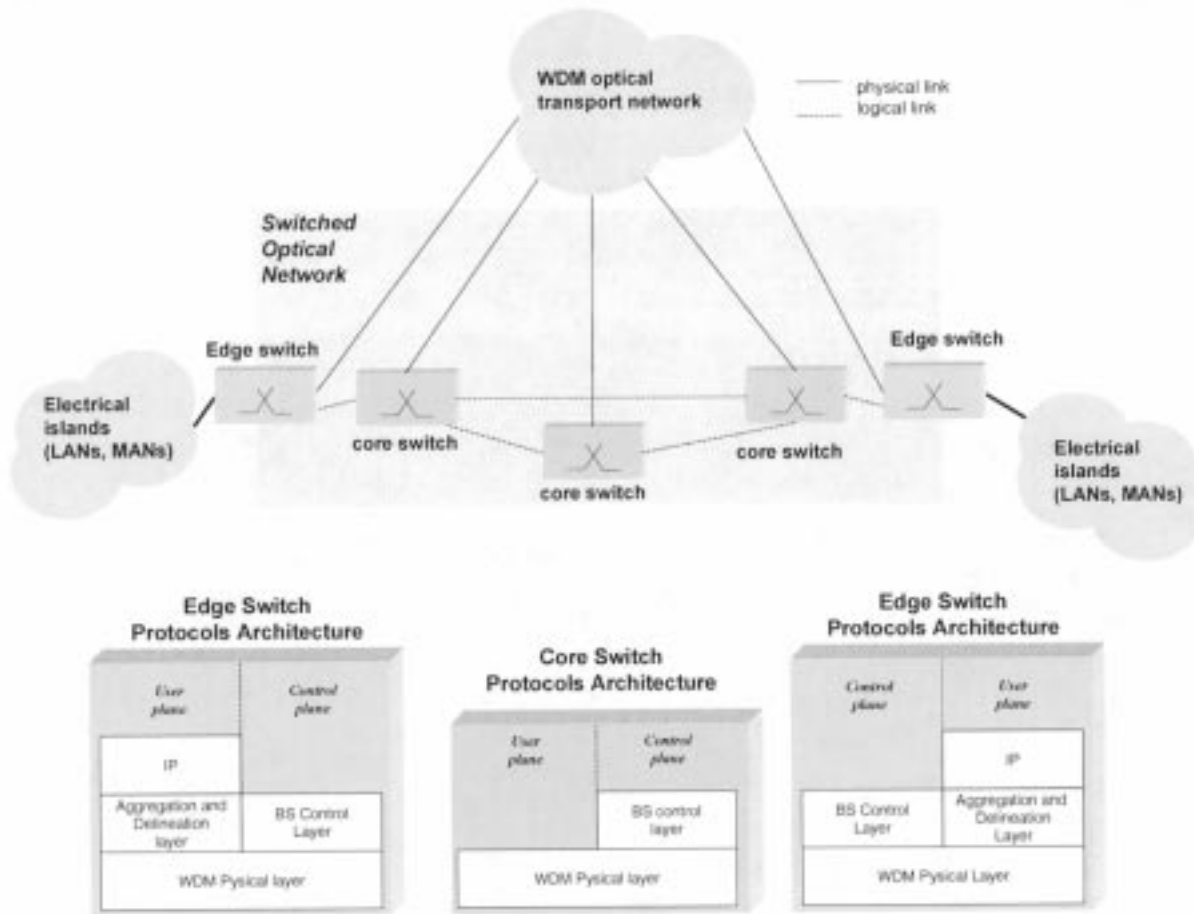

Fig. 1. Optical switched network architecture.

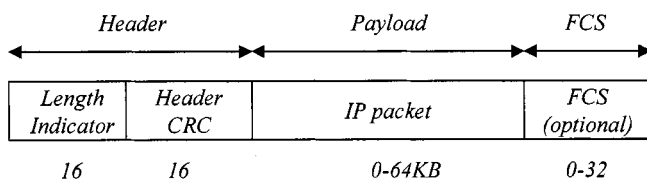

Fig. 2. SDL frame format.

- *Header CRC field.* The value of the two-octet-long header CRC field is calculated over all bits in the LI field. CRC operation is designed to allow correction of all single-bit error and detection of most multiple bit error in the SDL header.
- *Information field.* This field within the SDL payload field carries the IP packet.
- *Frame check sequence (FCS) field.* This optional field is either two or four octets long (for FCS-16 and FCS-32, respectively). The polynomials used are the same as those used in IP–point-to-point protocol (PPP)–HDLC frames, as described in [25]. The field is calculated over all bits in the SDL payload field.

The main function of SDL is to allow high-speed delineation of asynchronous variable-length datagrams contained in the optical burst. To achieve this, the SDL receiver analyzes the LI

field at the beginning of each SDL PDU to extract the framed datagram in the SDL payload and to determine the standard point of the next SDL PDU; Fig. 3 illustrates this operation. Under normal operation, the SDL receiver can extract the IP packets without processing every single byte on the data link. This is one of the aspects that makes SDL particularly suitable for very high transmission speeds with respect to HDLC. Another important function of SDL is to allow resynchronization of the receiver after the delineation is lost; this is realized by finding the match of the LI and header CRC fields.

### B. OCBS

Once a burst has been assembled at the ES, it travels an all-optical path between source and destination ES according to the OCBS. The OCBS operation is similar to the OBS [15]–[18]; the difference consists of the adoption of the BD technique in order to solve burst contention inside the optical switch. This technique allows the IP packet loss probability to be reduced with respect to that obtained with OBS.

In OCBS, when an ES has data to send, it sends a burst control packet (BCP) at a prefixed control wavelength channel, followed by the data burst on an unused data wavelength channel. Along the path from the source ES to the destination ES, the BCP is processed electronically and resources are reserved on the data path for the transmission of the burst. In literature, many

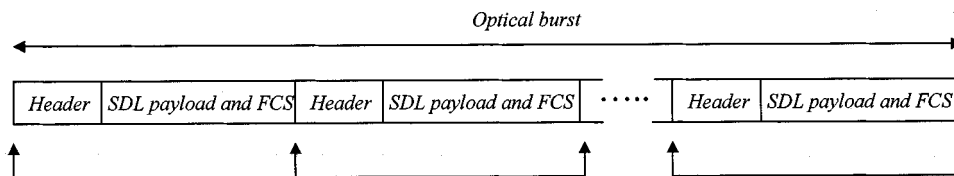

Fig. 3. IP packet delineation procedure by means of SDL.

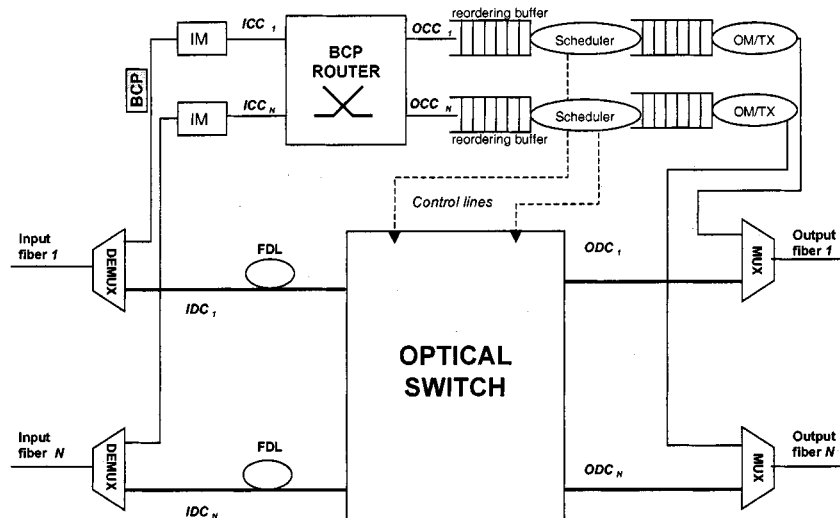

Fig. 4. Burst optical switch architecture.

alternatives are proposed for the control protocol and reservation scheme [15]–[18]; among these alternatives, we use the one proposed in [15], [16]. In order to understand the OCBS transfer mode better, we show, in Fig. 4, the architecture of an OCBS core switch (CS) with  $N$  input and output fibers. Each fiber has  $W$  wavelengths for data channels and one wavelength for control channel. The demultiplexer (DEMUX) is the first component of the OCBS router; its role is to split the input control channel (ICC), used by BCPs, and the input data channel (IDC), which supports  $W$  wavelengths, used by the data bursts. When a BCP reaches a CS, it is immediately converted in the electronic domain by the input module (IM) and is forwarded to the BCP router that determines to which output fiber the BCP and the related data burst are directed. A fiber delay line is used to properly delay the data burst in order to compensate the total delay suffered by BCP. Once the BCP has been processed, it is sent to the output module–transmission (OM–TX) that updates some fields contained in the BCP. Finally, the multiplexer (MUX), illustrated in Fig. 4, inserts the control channel in the output fiber. Furthermore, on each IDC, fiber delay lines are used in order to process the BCP before the arrival of the data burst.

To efficiently use the switch resources [15], [16], the scheduler of the BCP is performed not when the BCP arrives but just before the arrival of the related data burst. In order to delay the scheduling of the BCP, a reordering buffer is used. This buffer is ordered according to arrival times of the data bursts and its logic delivers the BCP to the scheduler  $\Delta$  seconds before the instant of the burst arrival itself, with  $\Delta$  being the sum of scheduling and optical switch setting times. The scheduler processes

the BCP and reserves resources needed to forward the data burst on one wavelength of the addressed output data channel (ODC); furthermore, it reveals possible burst contentions on the output wavelength channels. The CS is not equipped with an optical buffer; this choice is due to the fact that today’s technology allows the implementation of an optical buffer only by means of fiber delay lines, which implies a low buffering capacity due to hardware complexity required by the fiber delay lines [19], [20], as well as an increase of switch complexity in terms of used optical gates [21]. A possible implementation of the switch is illustrated in Fig. 5; it is realized by means of splitters, passive couplers, semiconductor optical amplifiers (SOAs), and tunable optical wavelength converters (TOWCs). The adoption of a bufferless architecture has the drawback that a high number of TOWCs, which are more expensive than the SOA gates, is needed. Moreover, a reduction of the number of TOWCs can be obtained by adopting switching architectures in which the TOWCs are shared among the various input lines as proposed for example in [22]. This obtainable saving is due to the fact that, in general, only a small part of the TOWCs is simultaneously utilized because an input wavelength channel of the optical switch at a given instant could not contain packets if we have a channel load less than 100%, and an arriving packet may not need wavelength conversion if it is directed to a output fiber with a free wavelength on which the packet arrives. In the proposed architecture of Fig. 5, the output burst contention problem is solved by means of two techniques, the wavelength conversion discussed in literature [21] and the BD technique. The BD mode of operation is illustrated in Fig. 6, using just one wavelength.

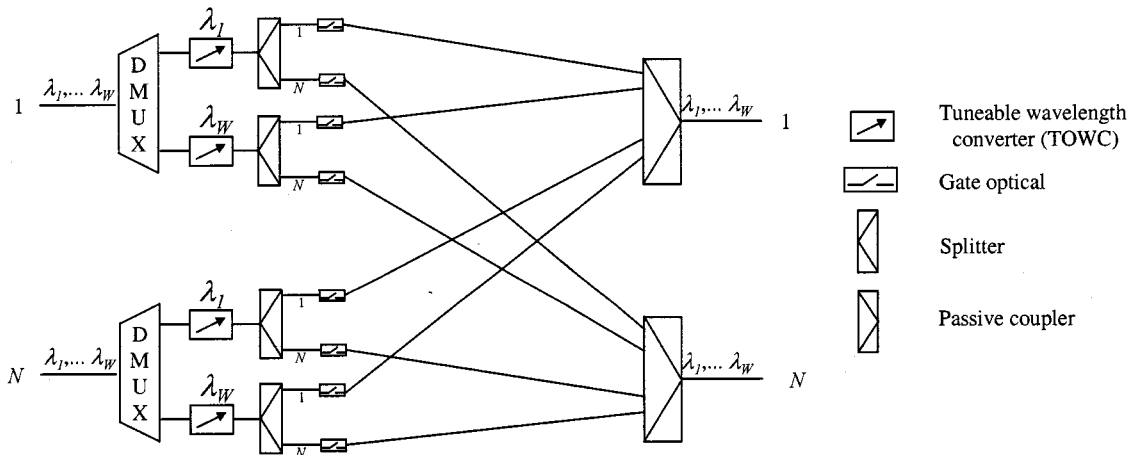

Fig. 5. Implementation of the optical switch by means of splitters, passive couplers, and optical gates.

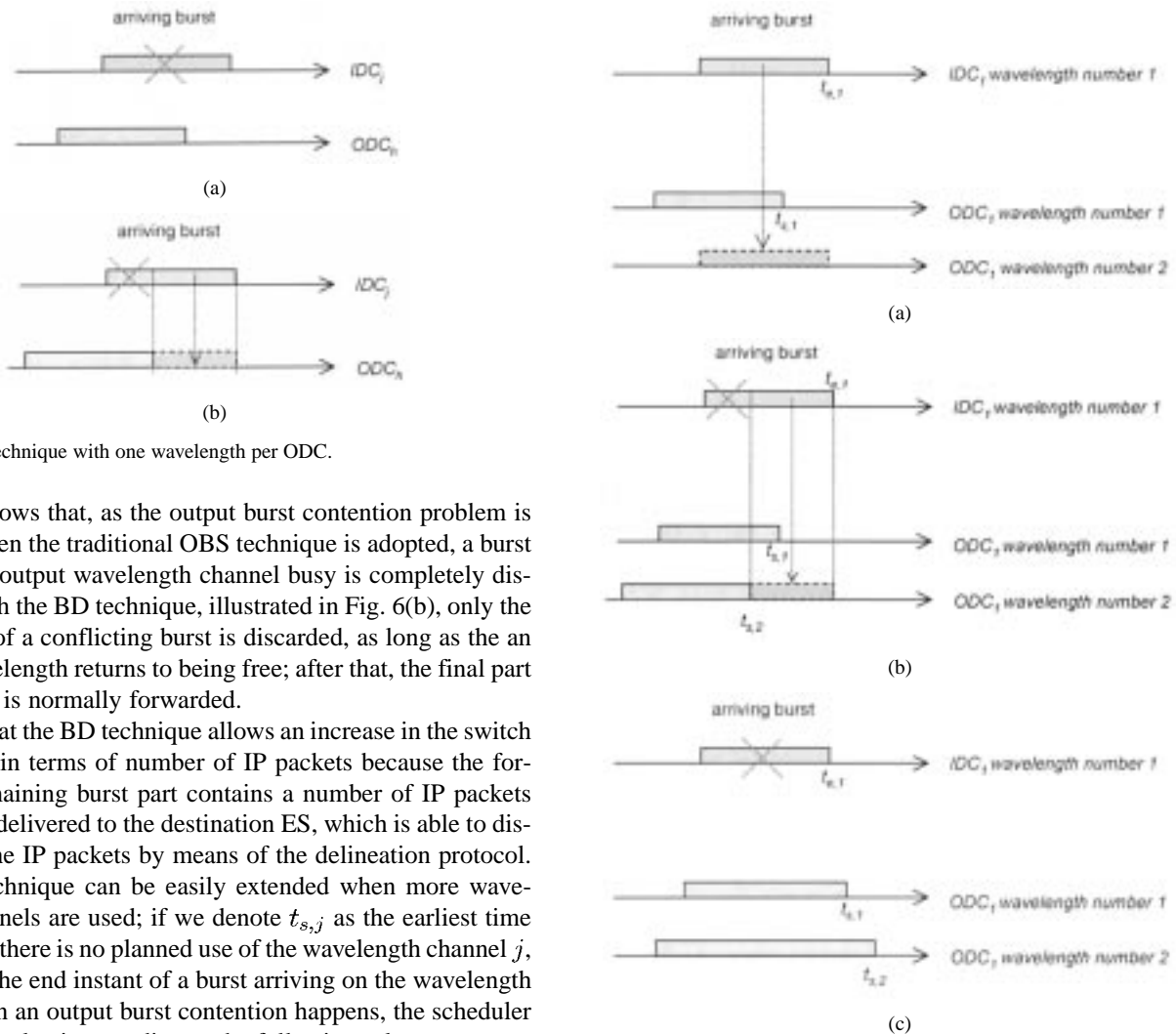

Fig. 6. BD technique with one wavelength per ODC.

Fig. 6(a) shows that, as the output burst contention problem is handled when the traditional OBS technique is adopted, a burst finding the output wavelength channel busy is completely discarded. With the BD technique, illustrated in Fig. 6(b), only the initial part of a conflicting burst is discarded, as long as the an output wavelength returns to being free; after that, the final part of the burst is normally forwarded.

Notice that the BD technique allows an increase in the switch throughput in terms of number of IP packets because the forwarded remaining burst part contains a number of IP packets that can be delivered to the destination ES, which is able to discriminate the IP packets by means of the delineation protocol. The BD technique can be easily extended when more wavelength channels are used; if we denote  $t_{s,j}$  as the earliest time after which there is no planned use of the wavelength channel  $j$ , and  $t_{e,i}$  as the end instant of a burst arriving on the wavelength  $i$ , then when an output burst contention happens, the scheduler attempts to solve it according to the following rules.

- If a wavelength channel is available, the burst is forwarded on such a wavelength by wavelength shifting [see Fig. 7(a) where  $W = 2$ ].
- If no wavelength channel is available, the BD technique is used; the dropped burst is forwarded on a wavelength channel  $h$  having  $t_{s,h} < t_{e,i}$  [see

Fig. 7. BD technique with more wavelengths per ODC.

Fig. 7(b)]; if there are more wavelength channels satisfying the previous condition, the one with smallest  $t_{s,h}$  ( $h = 1, \dots, M$ ) is chosen, indeed  $t_{s,h} = \min_{k=1, \dots, W} \{t_{s,k} \text{ with } t_{s,k} < t_{e,i}\}$ ; obviously,

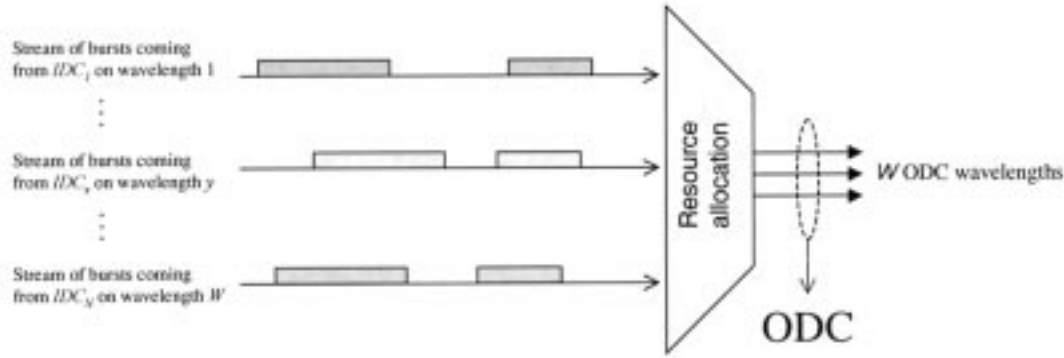

Fig. 8. Model used to compute the ODC packet loss probability.

if  $i \neq k$ , the BD technique is accomplished by means of a wavelength conversion [see Fig. 7(b)].

- Finally, the burst is lost if, for all of the  $j$  wavelengths, the condition  $t_{s,j} > t_{e,i}$  is verified [see Fig. 7(c)].

In Sections III–V, we will develop analytical models that will allow us to evaluate the BD technique and carry out a sensitivity analysis of the obtained performance with respect to both the optical switch and traffic parameters. It is to be noted that the packet aggregation and BD function entail that the performance of the switched optical network must be evaluated in terms of indexes characterizing the IP packets and not only the optical bursts. This is the goal of Section III.

### III. PERFORMANCE EVALUATION

In order to evaluate the effectiveness of the BD technique, we introduce an analytical model allowing us to calculate the IP packets loss probability  $P_{\text{loss}}^p$ . We evaluate this performance index by assuming that the traffic offered by each input wavelength channel is modeled as an ON–OFF process where an ON period is in correspondence with the duration of an optical burst, and the traffic scenario is symmetric, meaning that the input processes have the same statistic and an arriving burst has the same probability  $1/N$  to be directed to any ODC. We denote by  $L_n^b, S_n$ , the random variables characterizing the  $n$ -th ON and OFF periods, respectively; assuming that the variables  $L_n^b, S_n$  ( $n = 1, 2, \dots$ ) are identically distributed, respectively, we denote them by  $L^b, S$  while their probability densities and expected values are indicated by  $f_{L^b}(x), f_S(x), \bar{L}^b, \bar{S}$ . With these assumptions, notice that the traffic offered by each input wavelength channel is  $A = \bar{L}^b / (\bar{L}^b + \bar{S})$ , and the traffic offered to each ODC and to each output wavelength channel is  $A_F = (W \cdot N \cdot A) / N = W \cdot A$  and  $A_T = A$ , respectively.

We denote  $L_m^p$  ( $m = 1, 2, \dots$ ) as the length of the  $m$ -th IP packet; we assume that the variables  $L_m^p$   $m \in \{1, 2, \dots\}$  are identically distributed and we denote  $f_{L^p}(x)$  and  $\bar{L}^p$  as their probability density and their expected value, respectively. Furthermore, we denote by  $N_p$  the average number of IP packets contained in each burst.

To evaluate the effectiveness of the BD technique in Sections III-A and -B, we perform the evaluation of  $P_{\text{loss}}^p$  when either the wavelength dimensioning (WD) technique or both the WD and BD techniques are employed.

#### A. Performance Evaluation When Only the WD Technique is Adopted

According to the symmetric traffic assumption, the packet loss probability of the switch is equal to the packet loss probability of a single ODC. Hence, we evaluate the packet loss probability of a reference ODC. We also assume that the ON and OFF periods of the input processes are independent and exponentially distributed. Because, according to the available resources, a burst is either entirely accepted or rejected, and because the burst loss probability is independent of its length, we can affirm that  $P_{\text{loss}}^p$  equals the burst loss probability  $P_{\text{loss}}^b$ .

We model the system in Fig. 8 by means of a Markovian process whose state is constituted by two discrete variables  $(i, j)$ , where  $i$  denotes the number of entering bursts directed to the considered ODC and obtaining an ODC wavelength (accepted burst), whereas  $j$  denotes the total number of entering bursts that have been rejected due to the absence of available wavelengths. Notice the need to introduce the variable  $j$  for modeling the fact that a rejected burst constrains the arrival instant of the next burst arriving at the same input wavelength channel. Obviously, the variables  $i$  and  $j$  are constrained to be less than  $W$  and  $H - W$ , respectively, with  $H = W \cdot N$ .

In order to evaluate the transition rate of the introduced Markov chain, notice that, as shown in Fig. 9(a), transitions entering a state  $(i, j)$  can occur from the states:

- $(i - 1, j)$ , when a new burst arrives and there is at least one available ODC wavelength;
- $(i, j - 1)$ , when a new burst arrives and all of the ODC wavelengths are busy, that is,  $i = W$ ;
- $(i, j + 1)$  at the end of a previously rejected burst;
- $(i + 1, j)$  at the end of a previously accepted burst.

The rates relative to the mentioned transitions are illustrated in Fig. 9(b) where  $\lambda = 1/N \cdot \bar{S}$  and  $\mu = 1/\bar{L}^b$ .

The transitions outgoing from the state  $(i, j)$  are, as illustrated in Fig. 9(b), toward the following states:

- $(i, j + 1)$ , when a new burst arrives and all of the ODC wavelengths are busy, that is,  $i = W$ ;
- $(i + 1, j)$ , when a new burst arrives and there is at least one available ODC wavelength;
- $(i, j - 1)$ , at the end of a previously rejected burst;
- $(i - 1, j)$ , at the end of a previously accepted burst.

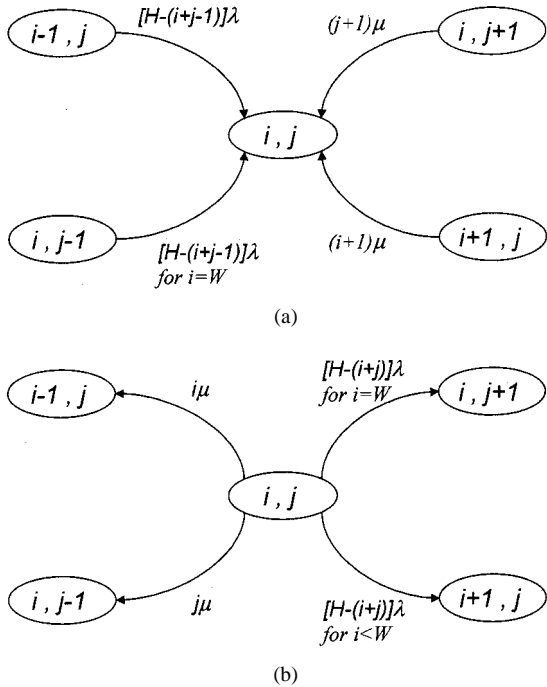

Fig. 9. (a) Entering and (b) outgoing state transition diagram.

Once evaluated, the limit state probability  $P_{i,j}$  of the introduced chain we can determine  $P_{\text{loss}}^b$  and, hence,  $P_{\text{loss}}^p$ , according to the following expression:

$$P_{\text{loss}}^p = P_{\text{loss}}^b = 1 - \frac{A_s}{A_F} = 1 - \frac{A_s}{W \cdot A_T} \quad (1)$$

where  $A_s = \sum_{j=0}^{H-W} \sum_{i=1}^W iP_{i,j}$  is the traffic carried by the considered ODC.

Notice that the introduced analytical model has  $W^2(N-1)$  states and, hence, it can become hard to solve it for large  $N$ . An overestimated value of  $P_{\text{loss}}^p$  can be obtained by neglecting the effect that a rejected burst engages its input wavelength channel for the duration, and by considering that, from the instant of rejection, a new burst will arrive according to an exponentially distributed interval with  $\lambda = 1/N \cdot S$  transition rate. As a consequence, the offered traffic is more peaked than the real one, so we overestimate the packet loss probability. The resolution of this model leads to the Engset formula [30]. To measure the overestimation, we define  $e$  as the percentage increase of the packet loss probability evaluated by the Engset formula ( $P_{\text{loss,Engset}}^p$ ) with respect to the one evaluated with the Markovian chain ( $P_{\text{loss,Markov}}^p$ ), in

$$e = \frac{(P_{\text{loss,Engset}}^p - P_{\text{loss,Markov}}^p)}{P_{\text{loss,Markov}}^p} \cdot 100.$$

Fig. 10 shows the value of  $e$  as a function of the  $N$  size of the optical switch for values of  $W$  and  $A_T$  equal to 2, 4, 8, and 0.7, 0.5, 0.2, respectively. We notice that, with the increase in  $N$  and in  $W$ , the difference between the two model decreases; on the other hand, with the increase of  $A_T$ , the difference increases. However, for  $N \geq 16$  and for  $A_T \leq 0.7$ , the difference is less than 2.5%.

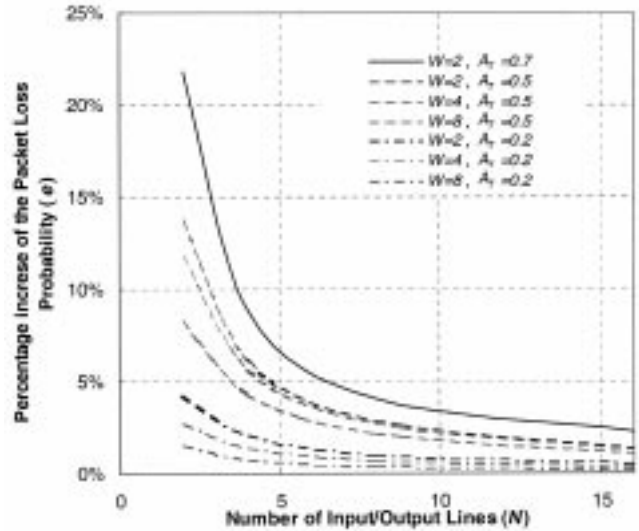

Fig. 10. Percentage increase of the packet loss probability evaluated by the Engset model in an  $N \times N$  switch.

In the rest of this paper, we will analyze the performances of a switch with  $N = 16$  and it will be seen that in order to obtain acceptable packet loss probability ( $10^{-4} \div 10^{-7}$ ) with a reasonable number of wavelengths per IDC-ODC ( $W \leq 64$ ), we can carry out on each wavelength a load not greater than 0.7. As a consequence of using the Engset model we lightly overestimate the packet loss probability.

Under the previous considerations, we can express the packet loss probability when the WD technique is used as follows:

$$P_{\text{loss}}^p \approx \frac{\binom{H-1}{W} \left(\frac{\lambda}{\mu}\right)^W}{\sum_{j=0}^W \binom{H-1}{j} \left(\frac{\lambda}{\mu}\right)^j}. \quad (2)$$

According to [28], [29], it can be demonstrated that (2) depends on the distribution of the ON and OFF periods only through the parameter  $A$ , that is, the traffic offered by each input wavelength channel, and it is independent of the distribution type of the ON and OFF periods. Hence, this property, famous in the literature as the insensitivity property [28], [29], allows us to evaluate the performance of the optical switch by means of (2) for any distribution of the ON and OFF periods.

### B. Performance Evaluation When Both WD and BD Techniques are Adopted

In order to evaluate the performance of the switch when both the WD and BD techniques are adopted, we first determine the fraction  $r_l$  of offered traffic that is rejected by the ODC, after we evaluate  $P_{\text{loss}}^p$  from  $r_l$ . In our analysis, we denote by  $L_n^{b,a}$  the length of the accepted part of the  $n$  burst according to the BD technique; obviously, if no drop is performed and the burst is entirely accepted, we have  $L_n^{b,a} = L_n^b$ . Note that  $L_n^{b,a}$  is composed of a useful part  $L_n^{b,a,u}$  of entire IP packets and a not useful part  $L_n^{b,a,nu}$  relative to the broken IP packet (see IP packet 2 in Fig. 11) due to the drop of the burst; this useless part  $L_n^{b,a,nu}$  will be discarded by the destination ES when a delineation operation of the IP packets contained in the burst is performed and, hence,

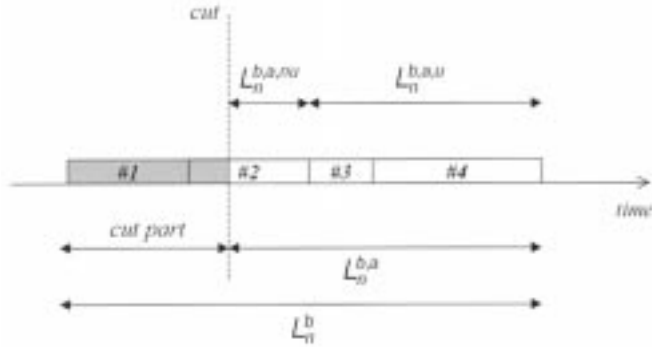

Fig. 11. Aggregation of IP packets in an optical composite burst.

only the entire IP packets will be accepted. From the fact that the random variables  $\{L_n^b, n = 0, 1, \dots\}$  are identically distributed, it follows that also the random variables  $\{L_n^{b,a}, n = 0, 1, \dots\}$ ,  $\{L_n^{b,a,nu}, n = 0, 1, \dots\}$ ,  $\{L_n^{b,a,u}, n = 0, 1, \dots\}$  are identically distributed, respectively; hence, we denote these random variables by  $L^{b,a}$ ,  $L^{b,a,nu}$ , and  $L^{b,a,u}$ , respectively, whereas with  $\overline{L^{b,a}}$ ,  $\overline{L^{b,a,nu}}$ , and  $\overline{L^{b,a,u}}$ , we indicate their expected values.

The fraction  $r_l$  of the offered traffic rejected by the ODC can be evaluated by considering a realization of the processes  $\{l_n^b, n = 0, 1, \dots\}$ ,  $\{l_n^{b,a}, n = 0, 1, \dots\}$  as follows:

$$r_l = 1 - r_a \quad r_a = \lim_{k \rightarrow \infty} \frac{\sum_{n=0}^k l_n^{b,a}}{\sum_{n=0}^k l_n^b} \quad (3)$$

$r_a$  being the fraction of offered traffic carried by the ODC. We can evaluate (3) with an ensemble mean. In fact, at an equilibrium instant, the ODC is able to forward, at most,  $W$  bursts; because, at this instant, an input wavelength channel is active and has a burst directed to the reference ODC with probability  $p = A/N$ , we can express the carried traffic  $A_s$  by the ODC as

$$A_s = \sum_{k=0}^W \binom{H}{k} k p^k (1-p)^{H-k} + \sum_{k=W+1}^H \binom{H}{k} W p^k (1-p)^{H-k} \quad (4)$$

and, hence,  $r_a$  can be written as shown in (5) at the bottom of the page.

$$r_a = \frac{A_s}{W \cdot A_T} = \frac{\sum_{k=0}^W \binom{H}{k} k p^k (1-p)^{H-k} + \sum_{k=W+1}^H \binom{H}{k} W p^k (1-p)^{H-k}}{W \cdot A_T} \quad (5)$$

Once we have evaluated  $r_l$  by means of (3)–(5), we are able to determine  $P_{\text{loss}}^P$ ; in fact,  $r_l$  and  $P_{\text{loss}}^P$  are related by the following expression:

$$P_{\text{loss}}^P = r_l + \frac{\overline{L^{b,a,nu}}}{\overline{L^b}} P_{\text{cut}} \quad (6)$$

where  $P_{\text{cut}}$  is the probability that an arriving burst is dropped.

The expression (6) can be obtained by expressing  $r_l$  as a function of  $P_{\text{loss}}^P$ , as in (7), shown at the bottom of the page, where  $\delta(x)$  is

$$\delta(x) = \begin{cases} 0, & \text{if } x = 0 \\ 1, & \text{otherwise.} \end{cases}$$

In (7), we have expressed  $L_n^{b,a}$  as the sum of the useful part  $L_n^{b,a,u}$  and useless part  $L_n^{b,a,nu}$ , and we have taken into account that  $L_n^{b,a,nu}$  is equal to zero when either a burst is rejected (i.e.,  $L_n^{b,a} = 0$ ) or a burst is entirely accepted (i.e.,  $L_n^b = L_n^{b,a}$ ).

In order to obtain (6), we express the second term of the last equation of (7) once denoted by  $k_1$  the number of dropped bursts among the first  $k$  arriving bursts

$$\begin{aligned} & \lim_{k \rightarrow \infty} \frac{\sum_{n=0}^k l_n^{b,a,nu} \delta(l_n^b - l_n^{b,a}) \delta(l_n^{b,a})}{\sum_{n=0}^k l_n^b} \\ &= \lim_{k \rightarrow \infty} \frac{k_1 \sum_{n=0}^k l_n^{b,a,nu} \delta(l_n^b - l_n^{b,a}) \delta(l_n^{b,a})}{k \sum_{n=0}^k l_n^b} \\ &= \lim_{k \rightarrow \infty} \frac{k_1}{k} \lim_{k \rightarrow \infty} \frac{\sum_{n=0}^k l_n^{b,a,nu} \delta(l_n^b - l_n^{b,a}) \delta(l_n^{b,a})}{\sum_{n=0}^k l_n^b} \\ &= P_{\text{cut}} \frac{\lim_{k \rightarrow \infty} \sum_{n=0}^k l_n^{b,a,nu} \delta(l_n^b - l_n^{b,a}) \delta(l_n^{b,a})}{\lim_{k \rightarrow \infty} \sum_{n=0}^k l_n^b} \\ &= P_{\text{cut}} \frac{\overline{L^{b,a,nu}}}{\overline{L^b}} \quad (8) \end{aligned}$$

from which, together with (7), we obtain (6).

In order to evaluate  $P_{\text{loss}}^P$  from (6), we must determine  $P_{\text{cut}}$  and  $\overline{L^{b,a,nu}}$ ;  $P_{\text{cut}}$  can be obtained from the

$$P_{\text{cut}} = 1 - (P_a + P_r) \quad (9)$$

$$\begin{aligned} r_l = 1 - r_a &= 1 - \lim_{k \rightarrow \infty} \frac{\sum_{n=0}^k l_n^{b,a}}{\sum_{n=0}^k l_n^b} = 1 - \lim_{k \rightarrow \infty} \frac{\sum_{n=0}^k l_n^{b,a,nu} \delta(l_n^b - l_n^{b,a}) \delta(l_n^{b,a}) + \sum_{n=0}^k l_n^{b,a,u}}{\sum_{n=0}^k l_n^b} \\ &= 1 - \lim_{k \rightarrow \infty} \frac{\sum_{n=0}^k l_n^{b,a,u}}{\sum_{n=0}^k l_n^b} - \lim_{k \rightarrow \infty} \frac{\sum_{n=0}^k l_n^{b,a,nu} \delta(l_n^b - l_n^{b,a}) \delta(l_n^{b,a})}{\sum_{n=0}^k l_n^b} \\ &= P_{\text{loss}}^P - \lim_{k \rightarrow \infty} \frac{\sum_{n=0}^k l_n^{b,a,nu} \delta(l_n^b - l_n^{b,a}) \delta(l_n^{b,a})}{\sum_{n=0}^k l_n^b} \quad (7) \end{aligned}$$



where  $P_a$  is the probability that a burst is entirely accepted and  $P_r$  is the probability that a burst is rejected.

$P_a$  is evaluated by taking into account that an arriving burst is entirely accepted if it finds less than  $W$  active input wavelength channels having a burst directed to the reference ODC. We simply say that there are  $W$  active streams directed to the reference ODC

$$P_a = \sum_{i=0}^{W-1} \binom{H-1}{i} p^i (1-p)^{H-1-i}. \quad (10)$$

The probability  $P_r$  that a burst is rejected can be evaluated by applying the law of the total probability

$$P_r = \sum_{i=W}^H P_{r/i} P_i \quad (11)$$

where  $P_{r/i}$  is the probability that a burst is rejected conditioned to the event that the arriving burst finds  $i$  active streams and  $P_i$  is the probability that the arriving burst finds  $i$  active streams, that is,  $P_i = \binom{H-1}{i} p^i (1-p)^{H-1-i}$ .

Notice that  $P_{r/i}$  is equal to zero for  $i < W$  because, when this condition happens, the arriving burst cannot be rejected. On the contrary, for  $i \geq W$ , the arriving burst is rejected when at least  $W$  of the active streams remain active for a time interval greater than the length of the arriving burst. Hence

$$P_{r/i} = \begin{cases} 0 & \text{if } i < W \\ \sum_{j=W}^i \binom{i}{j} P_c^j (1-P_c)^{i-j} & \text{if } i \geq W \end{cases} \quad (12)$$

where  $P_c$  is the probability that the active residual time of a stream is greater than the length of an arriving burst. We can write

$$P_c = \int_0^\infty P_{c/x} f_{L^b}(x) dx \quad (13)$$

where  $P_{c/x}$  is the probability  $P_c$  conditioned to the length of the arriving burst in the interval  $(x, x+dx)$ . Furthermore,  $P_{c/x}$  is given by [30]

$$P_{c/x} = \frac{1}{L^b} \left( 1 - \int_0^x f_{L^b}(y) dy \right). \quad (14)$$

Relative to  $\overline{L^{b,a,nu}}$  of (6), we can express it by taking into account that it is the residual length of an IP packet and, hence, according to [30]

$$\overline{L^{b,a,nu}} = \frac{\overline{LP}}{2} + \frac{\sigma_{LP}^2}{2LP} \quad (15)$$

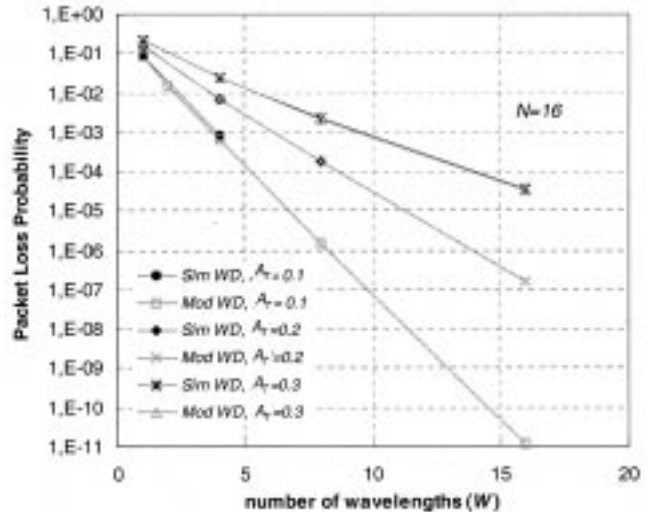

Fig. 12. Comparison of simulation and analytical model WD technique when  $N = 16$  and  $A_T$  varies in the range  $[0.1 \div 0.3]$ .

where  $\sigma_{LP}^2$  is the variance of the random variable  $LP$ .

When  $\sigma_{LP}^2 \leq (\overline{LP})^2$ , an upper bound of  $P_{\text{loss}}^p$  can be obtained by taking into account that  $\overline{L^{b,a,nu}} \leq \overline{LP}$ , and if  $f_{L^b}(x)$  is a negative exponential probability density, due to the lack of memory of the process  $P_c = 0.5$ . Under the previous conditions, we can write formulation (16), shown at the bottom of the page.

#### IV. NUMERICAL RESULTS

In this section, we present some results on the effectiveness evaluation of the BD technique using (16). To validate the introduced analytical models, a simulation package has been developed with the use of the network simulator 2 platform [31]. Such a tool simulates in detail the operation of the system. In the following, we present only a subset of the obtained results. However, we stress that the presented conclusions, with reference to the following set of system parameters, are valid for all of the others cases tested, as well.

In Fig. 12, the simulation and analytical values of  $P_{\text{loss}}^p$  regarding a switch adopting the WD technique have been plotted as a function of the number of wavelengths for a number of input lines  $N = 16$  and switch-offered load  $A_T$  varying from 0.1 to 0.3. The results show that the analytical model is in very good agreement with the simulation results. Analogous results are obtained in Fig. 13, where we have reported the fraction  $r_l$  of the offered traffic rejected by a switch adopting both WD and BD techniques for the same values of input-line number and switch-offered traffic.

$$P_{\text{loss}}^p = 1 - \frac{\sum_{k=0}^W \binom{H}{k} k \left(\frac{A}{N}\right)^k \left(1 - \frac{A}{N}\right)^{H-k} + \sum_{k=W+1}^H \binom{H}{k} W \left(\frac{A}{N}\right)^k \left(1 - \frac{A}{N}\right)^{H-k}}{W \cdot A_T} + \frac{\left\{ 1 - \left[ \sum_{i=0}^{W-1} \binom{H-1}{i} \left(\frac{A}{N}\right)^i \left(1 - \frac{A}{N}\right)^{H-1-i} \right] - \left[ \sum_{i=W}^H \sum_{j=W}^i \binom{i}{j} \binom{H-1}{i} 0.5^i \left(\frac{A}{N}\right)^i \left(1 - \frac{A}{N}\right)^{H-1-i} \right] \right\}}{N_p}. \quad (16)$$

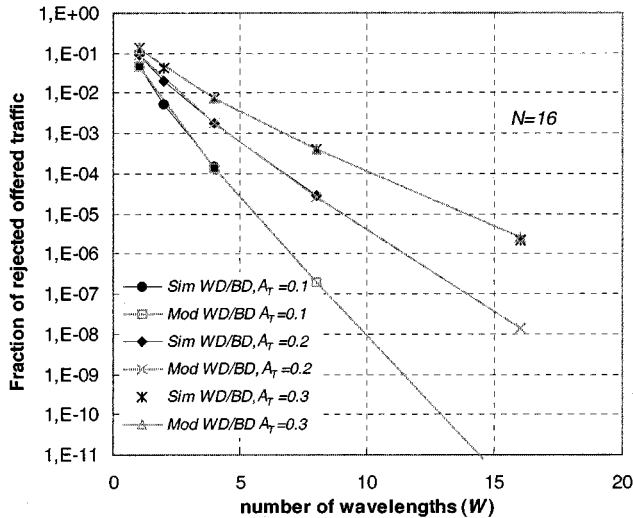

Fig. 13. Comparison of simulation and analytical model WD–BD technique when  $N = 16$  and  $A_T$  varies in the range  $[0.1 \div 0.3]$ .

Now, we discuss the results achieved in the effectiveness evaluation of the BD technique.

We define several values used in this evaluation.

- $A_{O_{BC,WC}}(P_{loss}^P)$  represents the values of traffic that must be offered to the switch in order to have packet loss probability  $P_{loss}^P$  when both the BD and WD techniques are used.
- $A_{O_{WC}}(P_{loss}^P)$  represents the values of traffic that must be offered to the switch in order to have packet loss probability  $P_{loss}^P$  when only the WD technique is used.
- $g(P_{loss}^P) = \frac{(A_{O_{WC}}(P_{loss}^P) - A_{O_{BC,WC}}(P_{loss}^P))}{A_{O_{BC,WC}}(P_{loss}^P)} \cdot 100$  is the utilization percentage gain of the BD–WD technique with regard to only the BD technique.

In particular, in Fig. 14, we evaluate  $g$  as a function of the IP packets average number  $N_p$  contained into each burst, for  $P_{loss}^P = 10^{-6}$ . We have assumed  $N = 16$  and  $W$  varying from 1 to 64. The values of  $A_{O_{BC,WC}}$  are not reported in Fig. 14; they grow when  $W$  increases due to the statistical multiplexing effect. For example, for  $N_p = 100$  and  $W = 4, 16, 64$ , we have  $A_{O_{BC,WC}} = 2.8 \cdot 10^{-2}, 2.7 \cdot 10^{-1}, 5.8 \cdot 10^{-1}$ . The main comments about these figures are the following.

- i) The BD technique allows an increment in the traffic that can be offered to the switch, for example, for  $N = 16$ ,  $N_p = 100$ , and  $W = 8$ , we have a 30% increment; further, notice that when  $N_p$  is fixed, we have an decrement of  $g$  for values of  $W$  increasing because the gain obtained with the BD technique becomes marginal with respect to the statistical multiplexing gain obtained with the WD technique.
- ii) As expected, for a fixed number  $W$  wavelengths,  $g$  increases when  $N_p$  increases according to (16). In particular, for  $N_p = 100$ ,  $P_{loss}^P$  already reaches its asymptotic value that, according to (6), is equal to  $r_l$ . This analysis can be helpful for establishing some guidelines about the way to fix the design parameter  $N_p$ ; in fact, as we can see from Fig. 14, for  $N_p \geq 100$ , the switch performance reaches its asymptotic value.

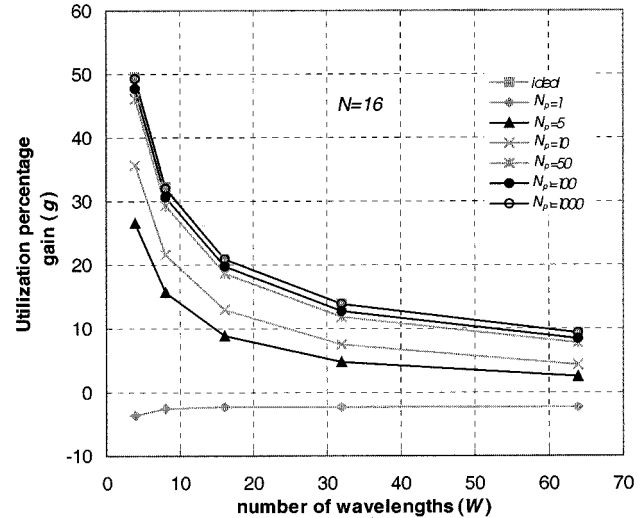

Fig. 14. Utilization percentage gain versus the number of wavelengths for  $P_{loss}^P = 10^{-6}$ ,  $N_p$  varying from 1 to 1000 and  $N = 16$ .

- iii) When each burst contains only one IP packet,  $g$  is negative and the BD technique is not effective; this is due to the fact that a dropped burst is not useful and, hence, the BD technique only wastes resources.

Obviously, the better performance obtained in OCBS when more IP packets are aggregated in a burst must be paid with an increment of the aggregation delay inside the ES [22]. This delay is due to the fact that any IP packet arriving at the ES must await the arrival of all of the IP packets of the burst before being transmitted. The aggregation delay depends on the various parameters, the most important ones of which are the number  $N_p$  of aggregated IP packets and the arrival rate of the IP packets arriving at the ES and directed to a same-destination ES. As a matter of fact, if we assume the arrival process to the ES to be Poissonian, the average aggregation delay needed for aggregating  $N_p$  IP packets is  $D_{agg} = N_p/2 \cdot \lambda$ , with  $\lambda$  being the average packet arrival rate. Hence, for  $\lambda = 5 \cdot 10^3$  pach/s, we have  $D_{agg} = 20$  ms if  $N_p = 100$ , while  $D_{agg}$  increases to 40 ms if  $N_p = 50$ . Hence,  $N_p$  is chosen as a tradeoff between the positive effect to have a smaller  $P_{loss}^P$  and the negative effect to have a larger aggregation delay.

Fig. 15 shows, versus  $W$ , the values of traffic that must be offered to the switch in order to have values of  $P_{loss}^P$  equal to  $10^{-4}$  and  $10^{-7}$ , and maintaining constant  $N = 16$  and  $N_p = 100$ . From Fig. 15, we can observe that the BD technique allows improvement of the packet loss performance on an order of magnitude in terms of  $P_{loss}^P$ . The values  $g$  relative to Fig. 15 are shown in Fig. 16;  $g$  decreases when  $W$  increases, and its value is likely independent of the value of  $P_{loss}^P$  fixed.

A sensitivity analysis of the effectiveness of the BD technique with respect to the switch size  $N$  has been also carried out. The results are not reported but we have seen that the performance of the switch is likely not influenced by the switch  $N$  size; this is due to the fact that the traffic offered to any ODC is independent of  $N$  and, furthermore, when  $N$  is large enough, the traffic offered to any ODC becomes Poissonian [32].

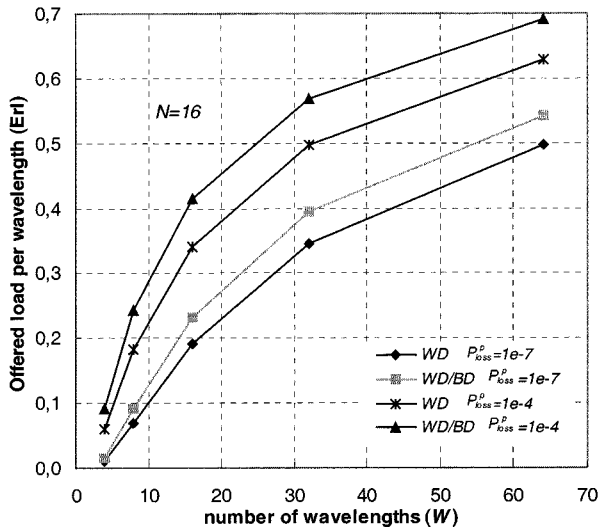

Fig. 15. Offered load per wavelength ( $A_T$ ) as a function of the number of wavelengths when  $P_{loss}^p$  is equal to  $10^{-4}$  and  $10^{-7}$ , and  $N = 16$ .

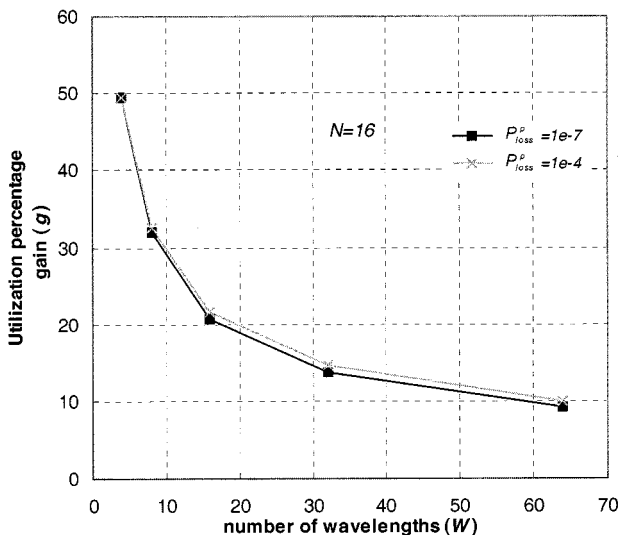

Fig. 16. Utilization percentage gain versus the number of wavelengths for  $N_p = 100$ ,  $P_{loss}^p$  equal to  $10^{-4}$  and  $10^{-7}$ , and  $N = 16$ .

## V. CONCLUSION

In this paper, we have illustrated and analyzed the BD technique, which allows an increase in the performance of an optical switch, in terms of IP packets loss probability, with respect to the case in which only the WD technique is adopted. An analytical model, allowing evaluation of the IP packet loss probability, has been presented. The results of this analytical model fit very accurately with simulation results. The model has been applied to carry out a sensibility analysis of the performance improvement with respect the main system parameters (number of input and output lines, number of wavelengths, number of IP packets contained in each burst) and traffic values. The proposed technique allows, for a required performance, an increase in the offered traffic of a percentage varying 10–50%, according to the number of employed wavelengths. For example, for  $N = 16$ ,  $P_{loss}^p = 10^{-6}$ ,  $N_p = 100$ , and  $W = 8$ , we have a 30% traffic

increase. By means of the introduced analytical model, we have carried out a sensibility analysis with respect to the  $N_p$  parameter, that is, the average number of IP packets contained in each burst. This analysis can be helpful to establish some guidelines about the way to fix the design parameter  $N_p$ ; in particular, for  $N_p \geq 100$ , the switch performance reaches its asymptotic value.

Future work includes the extension of the proposed model in order to analyze the effectiveness of the BD technique with respect to the network performance improvement expressed in terms of end-to-end IP packet loss probability.

## REFERENCES

- [1] R. Ramaswami and K. N. Sivarajan, *Optical Networks*. San Mateo, CA: Morgan Kaufmann, 1998.
- [2] I. Chlamtac, A. Farago, and T. Zang, "Lightpath routing in large WDM networks," *IEEE J. Select. Areas Commun.*, vol. 14, pp. 909–913, June 1996.
- [3] B. Mukherjee, D. Banerjee, S. Ramamurthy, and A. Mukherjee, "Some principles for designing a wide-area WDM optical network," *IEEE/ACM Trans. Networking*, vol. 4, pp. 684–696, Oct. 1996.
- [4] P. Gambini *et al.*, "Transparent optical packet switching: Network architecture and demonstrators in the KEOPS project," *IEEE J. Select. Areas Commun.*, vol. 16, pp. 1245–1259, Sept. 1998.
- [5] C. Guillemot *et al.*, "Transparent optical packet switching: The European ACTS KEOPS project approach," *J. Lightwave Technol.*, vol. 16, pp. 2117–2134, Dec. 1998.
- [6] —, "Optical packet switching for WDM IP gigabit routers," in *Proc. ECOC'98*, Madrid, Spain, Sept. 1998, pp. 433–434.
- [7] —, "Optical packet switching for WDM high speed backbones," in *Proc. ECOC'98*, Madrid, Spain, Sept. 1998, pp. 81–85.
- [8] F. Callegati, M. Casoni, C. Raffaelli, and B. Bostica, "Packet optical networks for high-speed TCP-IP backbones," *IEEE Commun. Mag.*, vol. 37, pp. 124–129, Jan. 1999.
- [9] F. Callegati, M. Casoni, G. Corazza, and C. Raffaelli, "Architecture and performance of a broadcast and select photonic switch," *Opt. Fiber Technol.*, vol. 4, pp. 266–284, 1998.
- [10] D. K. Hunter *et al.*, "WASPNET: A wavelength switched packet network," *IEEE Commun. Mag.*, vol. 37, pp. 120–129, Mar. 1999.
- [11] D. K. Hunter, W. D. Cornwell, T. H. Gilfedder, A. Franzen, and I. Andonovic, "SLOB: A switch with large optical buffers for packet switching," *J. Lightwave Technol.*, vol. 16, pp. 1725–1736, Oct. 1998.
- [12] M. Burzio, P. Cinato, R. Finotti, P. Gambini, M. Puleo, E. Vezzoni, and L. Zucchelli, "Optical cell synchronization in an ATM optical switch," in *Proc. ECOC '94*, Florence, Italy, Sept. 1994, pp. 581–584.
- [13] M. Burzio, P. Gambini, and L. Zucchelli, "New solution for optical packet delineation and synchronization in optical packet switch networks," in *Proc. ECOC '96*, Oslo, Norway, Sept. 1996, pp. 3.301–3.304.
- [14] S. Yao, B. Mukherjee, and S. Dixit, "Advances in photonic packet switching: An overview," *IEEE Commun. Mag.*, pp. 84–94, Feb. 2000.
- [15] Y. Chen and J. Turner, "WDM burst switching for petabit capacity routers," in *Proc. MILCOM*, vol. 2, 1999, pp. 968–973.
- [16] J. Turner, "Terabit burst switching," *J. High Speed Networks*, vol. 8, pp. 3–16, 1999.
- [17] C. Qiao and M. Yoo, "A novel switching paradigm for buffer-less WDM networks," in *Proc. OFC'99*, Feb. 1999, ThM6, pp. 177–179.
- [18] —, "Labeled optical burst switching for IP over WDM integration," *IEEE Commun. Mag.*, vol. 38, pp. 104–114, Sept. 1999.
- [19] F. Masetti, P. Gagniet, D. Chiaroni, and G. Da Lora, "Fiber delay lines optical buffer for ATM photonic switching applications," in *Proc. IEEE INFOCOM '93*, San Francisco, CA, March 1993.
- [20] D. K. Hunter, M. C. Chia, and I. Andonovic, "Buffering in optical packet switches," *J. Lightwave Technol.*, vol. 16, pp. 2081–2094, Dec. 1998.
- [21] S. L. Danielsen, C. Joergensen, B. Mikkelsen, and K. E. Stubbkjaer, "Optical packet switched network layer without optical buffers," *IEEE Photon. Technol. Lett.*, vol. 10, pp. 896–898, June 1998.
- [22] V. Eramo and M. Listanti, "Packet loss in a bufferless WDM switch employing shared tuneable wavelength converters," *J. Lightwave Technol.*, vol. 18, pp. 1818–1833, Dec. 2000.
- [23] A. Ge, F. Callegati, and L. S. Tamil, "On optical burst switching and self-similar traffic," *IEEE Commun. Lett.*, vol. 4, pp. 98–100, Mar. 2000.
- [24] F. Callegati, H. Cankaya, Y. Xiong, and M. Vandenhoute, "Design issue of optical IP routers for internet backbone applications," *IEEE Commun. Mag.*, vol. 37, pp. 2–6, Dec. 1999.

- [25] W. Simpson, "PPP in HDLC-like framing," Internet Engineering Task Force, RFC 1662, 1994.
- [26] J. Anderson, J. S. Manchester, A. Rodriguez-Moral, and M. Veeraraghavan, "Protocol and architectures for IP optical networking," *Bell Labs Tech. J.*, vol. 1, pp. 105–123, Jan.–Mar. 1999.
- [27] T. Doshi *et al.*, "A simple data link protocol for high-speed packet networks," *Bell Labs Tech. J.*, vol. 1, pp. 85–103, Jan.–Mar. 1999.
- [28] D. Mitra and J. A. Morrison, "Erlang capacity and uniform approximation for shared unbuffered resources," *IEEE/ACM Trans. Networking*, vol. 2, pp. 558–580, Dec. 1994.
- [29] F. P. Kelly, *Reversibility and Stochastic Networks*. New York: Wiley, 1980.
- [30] L. Kleinrock, *Queueing Systems*. New York: Wiley, 1975, vol. 1, pp. 164–169.
- [31] Lawrence Berkeley Network Laboratory and University of California Berkeley. Network Simulator 2. [Online]. Available: <http://www-mash.cs.berkeley.edu/ns/>
- [32] M. G. Hluchyj and M. Karol, "Queuing in high performance packet switching," *IEEE J. Select. Areas Commun.*, vol. 6, pp. 1587–1597, Dec. 1988.



**Andrea Detti** received the degree in telecommunication engineering from the University of Rome "La Sapienza," Roma, Italy, in 1998. He is currently pursuing the Ph.D. degree in microelectronics at the University of Rome "Tor Vergata."

In November 2001, he joined the RadioLabs consortium, Rome, Italy, as a Researcher in the Wireless Telecommunication Network group. His current research interests focus on optical burst switching and BlueTooth.



**V. Eramo** received the Dr.Eng. degree from the University of Rome "La Sapienza," Roma, Italy, in 1995 and the Ph.D. degree from the University of Rome "La Sapienza" in 2001.

From June to December 1996, he was with the Scuola Superiore Reiss Romoli as a Researcher. In 1997, he joined the Fondazione Ugo Bordini as a Researcher with the Telecommunication Network Planning group. His current research interests include network performance and traffic characterization, introduction of new devices (video on demand) in the access network, quality-of-service support in Internet, and optical packet switching.



**M. Listanti** (S'78–M'79) received the Dr.Eng. degree in electronics engineering from the University of Rome "La Sapienza," Roma, Italy, in 1980.

In 1981, he joined the Fondazione Ugo Bordoni, where he led the TLC network architecture group. In November 1991, he joined the INFOCOM Department of the University of Rome "La Sapienza," where he is Full Professor of Switching Systems. Since 1994, he has also collaborated with the Electronics Department of the University of Rome "Tor Vergata," where he holds courses on telecommunications networks. He is the author of several papers published in technical journals and conference proceedings in the area of telecommunication networks, and was the guest editor of a special issue of the *IEEE COMMUNICATIONS MAGAZINE* on optical networking solutions for next-generation Internet networks. He has also been a representative of Italian PTT administration in international standardization organizations, including the International Telecommunications Union and ETSI. His current research interests focus on traffic control in IP networks and on the evolution of techniques for optical networking.

Prof. Listanti is a member of the IEEE Communications Society.