

Performance Evaluation of LMS and VSS-LMS Channel Estimation Techniques for LTE Uplink under Different Modulation Types

Mohammed H. M. Nerma* and Nidaa M. H. Elshaikh

*School of Electronic Engineering, College of Engineering, Sudan University of Science and Technology, Khartoum – Sudan

Accepted 27 May 2014, Available online 01 June 2014, Vol.2 (May/June 2014 issue)

Abstract

One of the essential goal of LTE is increasing speed and capacity without consuming high power especially in uplink, in order to save battery life of user equipment as long as possible. Since SC-FDMA achieves this, it has been utilized in the uplink of 3GPP LTE. However the high capacity and speed will affect the received data. This leads to the need of using channel estimation technique in the receiver (eNodeB) to recover the received signal. In this thesis SC-FDMA is modeled using MATLAB and then LMS and VSS-LMS channel estimation techniques are applied in order to evaluate their performance in terms of BER, MSE and algorithm complexity. The evaluation of the algorithms was done under different modulation techniques (BPSK and QPSK). The simulation results show that for QPSK both of BER and MSE has high values compared with BPSK. VSS-LMS algorithm has better performance than LMS in all cases; however it requires more multiplication and addition operations.

Keywords: BER, BPSK, LTE, MSE, QPSK, SC-FDMA, SNR, LMS, VSS-LMS.

1. Introduction

Long term evolution (LTE) is a standard for wireless data communications technology and an evolution of the Global System for Mobile/Universal Mobile Telecommunication System (GSM/UMTS) standards. The goal of LTE was to increase the capacity and speed of wireless data networks using new digital signal processing (DSP) techniques and modulations that were developed around the turn of the millennium [1]. Single carrier Frequency Division Multiple Access (SC-FDMA) is a frequency-division multiple access scheme. It deals with the assignment of multiple users to a shared communication resource. It has drawn great attention as an attractive alternative to orthogonal frequency division multiple access (OFDMA), especially in the uplink communications where lower peak to average power ratio (PAPR) greatly benefits the mobile terminal in terms of transmit power efficiency and terminal costs. It has been adopted as the uplink multiple access scheme in 3GPP Long Term Evolution (LTE) since it's transmit signal has a lower peak-to-average power ratio (PAPR) than OFDMA[2]. Since the radio channel is highly dynamic, the transmitted signal travels to the receiver by undergoing many detrimental effects that corrupt the signal and often place limitations on the performance of the system. Channel estimation (CE) techniques allow the receiver to approximate the impulse response of the channel and explain the behavior of the channel. [3], [4]. In general, CE

techniques can be divided into two major categories such as the trained and blind. The former CE algorithm requires probe sequences that occupy valuable bandwidth whereas the latter uses the received data only. Due of course to their self-sufficiency in training, blind CE techniques are considered more attractive than trained based techniques [5], [6].

Several CE techniques have been proposed for LTE SCFDMA systems in the last years: In 2007, A. ncora and etal has proposed the least square (LS) channel estimation method to minimize the squared differences between the received and estimated signal. This method is widely used in equalization and filtering applications because it does not require knowledge of channel, however, the statistics of channels in real world change over time. Also the inversion of the large dimensional square matrix turns out to be ill-conditioned in the straight application of the LS estimator [7]. In 2008, L. A. M. R. D. Temino and etal has proposed two dimensional based on Wiener filtering pilot symbol aided CE. It has a good performance; however, it is more complex and requires accurate knowledge of second order channel statistics [8]. In 2012, Yongkui Ma and etal has proposed the least mean square (LMS) method, its normalized version (NLMS) and recursive least square (RLS) CE algorithms. In these methods the estimators update coefficients continually and do not need prior knowledge of channel statistics; however, for high Doppler frequencies the performance of LMS and NLMS get worse

than RLS but the last one needs longer filter for better performance. Also RLS is more complex than LMS and NLMS methods [9]. In 2010, adaptive LMS channel estimation algorithms have been proposed for LTE uplink by Md. Masud RANA and etal. This algorithm uses adaptive estimator which is able to update parameters of the estimator continuously by periodically transmitting a training sequence which is known to the receiver. [10] In December 2010, they have proposed the variable step size least mean square VSS-LMS CE. This time-varying step size method is re-selected at each iteration to minimize the sum of the squares of the prior estimation errors up to that current time point. Although this CE algorithm has good performance, MSE and convergence towards true channel coefficient as well as BER performance However, it requires high computational complexity. [11] In this paper an adaptive LMS based Channel Estimation Methods will be focused on since it does not require prior knowledge of channel statistics or noise and simple for practical implementation.

In section two the SC-FDMA model in addition to algorithms used in this work is covered. Section three includes the simulation description followed by the results which are shown in section four. In Section five, the discussion is shown and finally the conclusion and future work in sections six and seven respectively.

2. System design

2.1 Single Carrier Frequency Division Multiple Access (SC-FDMA)

Since SC-FDMA is utilized in the uplink of 3GPP LTE, the implementation of SC-FDMA in 3GPP LTE uplink will be described in this section.

The transmitter of an SC-FDMA system converts a binary input signal to a sequence of modulated subcarriers. To do so, it performs the signal processing operations shown in Figure 1.

Signal processing is repetitive in a few different time intervals. Resource assignment takes place in transmit time intervals (TTIs). In 3GPP LTE, a typical TTI is 0.5 ms. The TTI is further divided into time intervals referred to as blocks. A block is the time used to transmit all of subcarriers once [2].

2.1.1 Frame format

In order to transfer data between LTE base station called eNodeB and User Equipment terminals, a strict frame and sub-frame (slots) structure has been defined for the radio interface E-UTRA (Evolved UMTS Terrestrial Radio Access) used in LTE. Two general frame types are distinguished:

- i. Type 1 - used in both LTE FDD and TDD duplexing.
 - ii. Type 2 - used only in LTE TDD duplexing.
- Due to more frequent use [12], in this paper mainly Type 1 will be investigated.

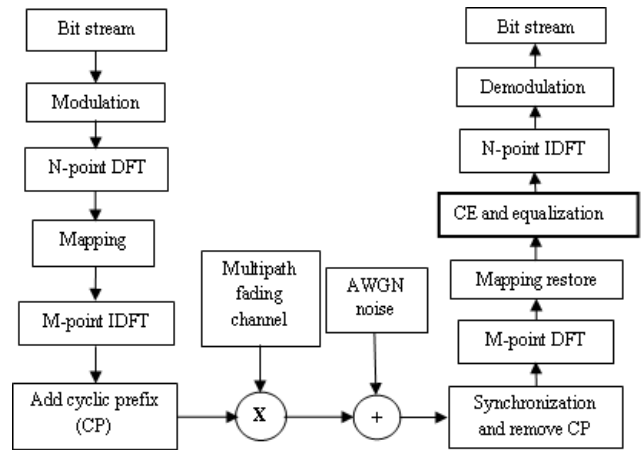

Fig.1 LTE SC-FDMA block diagram

The generic LTE frame has duration of 10 msec. It is divided into ten sub-frames also known as TTI (Transmission Time Interval) [13]. Each sub-frame duration is $T_{subframe} = 1.0$ msec and it consists of two time slots. As it shown in Figure 2 each frame can also be considered as a structure divided into 20 separate time slots each with a duration of 0.5 msec.

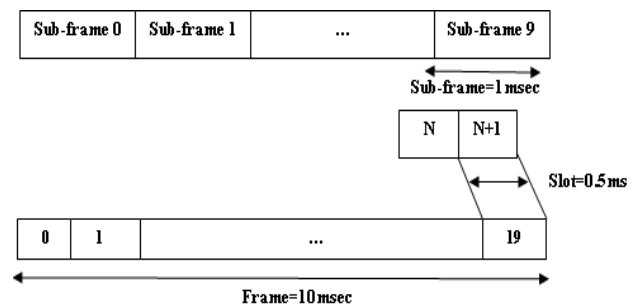

Fig.2 Uplink frame and sub-frame format for structure type 1.

The number of symbols (consider one symbol as DFT blocks + cyclic prefix (CP)) in one slot is determined by CP length [14]. When normal CP is used there are seven SC-FDMA symbols per slot, but for extended CP only six symbols can be transmitted. This is illustrated in Figure 3. Comparing the TTI in LTE with the sub-frames in HSPA systems the LTE sub-frame is two times shorter than the sub-frame in HSPA which has duration of 2 msec. The main objective of the LTE sub-frames structure is to provide higher data rates and smaller latency. This is achieved inter alia using a shorter LTE sub-frames duration so e.g. delays caused by retransmissions are reduced.

2.1.2 Modulation

At the input to the transmitter, a baseband modulator transforms the binary input to a multilevel sequence of complex numbers x_n in one of several possible modulation formats including binary phase shift keying

(BPSK), quaternary PSK (QPSK), 16 level quadrature amplitude modulation (16-QAM) and 64-QAM. The system adapts the modulation format, and thereby the transmission bit rate, to match the current channel conditions of each terminal [15]. The modulation schemes used in 3GPP LTE uplink are BPSK, QPSK, 8PSK and 16QAM [16].

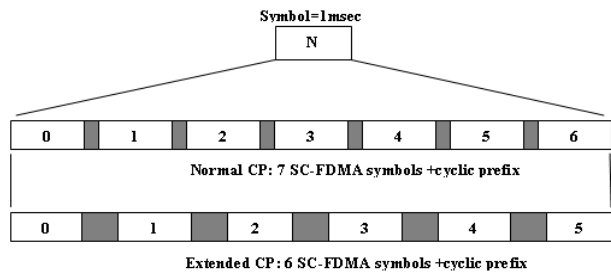

Fig.3 Symbol structure consisting of seven or six modulation symbols depending on the cycle prefix length.

2.1.3 N Point DFT

The transmitter next groups the modulation symbols, x_n into blocks each containing N symbols. The first step in modulating the SC-FDMA subcarriers is to perform an N-point discrete Fourier transform (DFT), to produce a frequency domain representation X_k of the input symbols [15].

2.1.4 Subcarrier Mapping

There are two types of subcarrier mapping in an SC-FDMA system, localized (LFDMA) and distributed (DFDMA). In LFDMA, the K outputs of the DFT block from a particular terminal are mapped to a chunk of K adjacent subcarriers, whereas in DFDMA the symbols are mapped to subcarriers which are equally spaced across a particular part of the (or the entire) bandwidth. Interleaved SC-FDMA (IFDMA) is a special case of DFDMA, where the chunk of K subcarriers occupies the entire bandwidth with a spacing of J-1 subcarriers. In both of the subcarrier allocation methods, the transmitter assigns zero amplitude to the remaining $N_{total-k}$ unused subcarriers.

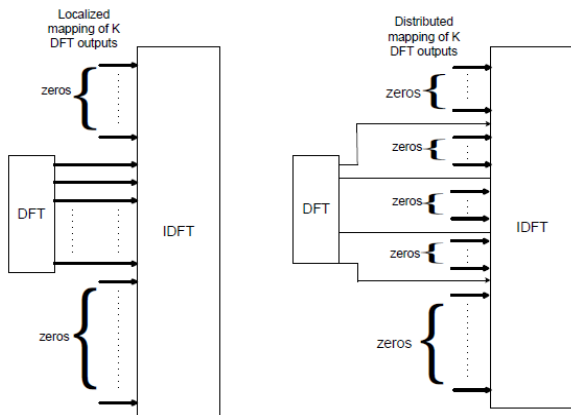

Fig.4 Localized and Distributed subcarrier mapping [20]

Figure 4 illustrates the different types of subcarrier mapping methods.

In LTE uplink each of the N DFT outputs is mapped to one of the $M > N$ orthogonal subcarriers that can be transmitted. As in OFDMA, a typical value of M is 256 subcarriers and $N = M/Q$ is an integer sub multiple of M. Q is the bandwidth expansion factor of the symbol sequence. If all terminals transmit N symbols per block, the system can handle Q simultaneous transmissions without co channel interference. The result of the subcarrier mapping is the set $\tilde{X}_l (l = 0, 1, 2, \dots, M - 1)$ of complex subcarrier amplitudes, where N of the amplitudes are non-zero[15]. Figure 5 illustrates subcarrier mapping in SC-FDMA for k users.

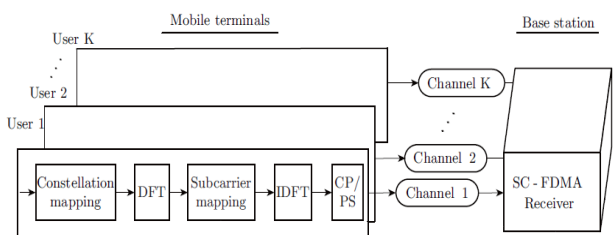

Fig.5 SC-FDMA system subcarrier mapping block diagram [17].

2.1.5 M Point IDFT

An M-point inverse DFT (IDFT) transforms the subcarrier amplitudes to a complex time domain signal \tilde{X}_m . Each \tilde{X}_m then modulates a single frequency carrier and all the modulated symbols are transmitted sequentially [15].

2.1.6 Cyclic Prefix (CP)

The transmitter performs two other signal processing operations prior to transmission. It inserts a set of symbols referred to as a cyclic prefix (CP). The transmitter also performs a linear filtering operation referred to as pulse shaping in order to reduce out of band signal energy [15]. The cyclic prefix is a repetition of the last data symbols in a block which is added at the start of each block. Its length in data symbols exceeds the maximum expected delay spread [18]. Utilizing a cyclic prefix is an efficient method to prevent IBI (Inter-Block Interference) between two successive blocks. In general, CP is a copy of the last part of the block [15]. The existence of CP has a double effect preventing IBI [15].

CP provides a guard time between two successive blocks. If the length of CP is longer than the maximum spread delay of channel, there won't be any IBI. Because CP is a copy of the last part of the block, it will avoid the ICI (Inter Carrier Interference) between subcarriers. However, the drawback of the cyclic prefix is that it doesn't carry any new information, so it will lower the efficiency of the transmission [19].

a. SC-FDMA Receiver

Just like the transmitter, the two major computations required to get back the transmitted symbols in an SC-FDMA receiver are the DFT and IDFT. In an SC-FDMA receiver, after discarding the cyclic prefix, the DFT block transforms the received time domain signal into the frequency domain. Afterwards, subcarrier de-mapping is done following the same method (distributed, localized or interleaved) in which subcarrier mapping was done in the transmitter. Next, an equalizer compensates for the distortion caused by the multipath propagation channel. After the equalization process, the IDFT block transforms the signal into the time domain, and finally, a detector recovers the original transmitted symbols.

The equalization process in an SC-FDMA receiver is done in the frequency domain. Frequency domain equalization is one of the most important properties of SC-FDMA technology. Conventional time domain equalization approaches for broadband multipath channels are not advantageous because of the complexity and required digital signal processing increases with the increase of the length of the channel impulse response. Frequency domain equalization, on the other hand, is more computationally efficient and therefore desirable because the DFT size does not grow linearly with the length of the channel impulse response. Most of the time domain equalization techniques such as Minimum Mean Squared Error Equalization (MMSE), Decision Feedback Equalization (DFE), and turbo equalization can be implemented in the frequency domain [20].

b. Channel Estimation

i. LMS algorithm

Stochastic gradient based adaptive algorithms, such as the least mean square (LMS) one, are the most popular in adaptive filtering applications, due to its low computational complexity and very good stability characteristic. Moreover, in the LMS algorithm a previous knowledge of the process statistics is not required [21]. Such advantages make the LMS algorithm adequate for system identification, noise canceling, echo canceling, channel equalization, among other applications [22]. The standard LMS uses a fixed adaptation step size, determined by considering a tradeoff between convergence rate and miss adjustment [23]. If:

$s(m)$ is the transmitted signal, $z(m)$ is the additive white Gaussian noise (AWGN) and $W(m)$ is the channel coefficients. The output from the channel can be expressed as:

$$r(m) = W^T(m)s(m) + z(m) \tag{1}$$

The output of the adaptive filter is:

$$y(m) = W_{est}^T(m)s(m) \tag{2}$$

Where: $W_{est}(m)$ is the estimated channel coefficients at time m . The priori estimated error signal needed to update the weights of the adaptive filter is:

$$e(m) = r(m) - y(m) = W^T(m)s(m) + z(m) - W_{est}^T(m)s(m) \tag{3}$$

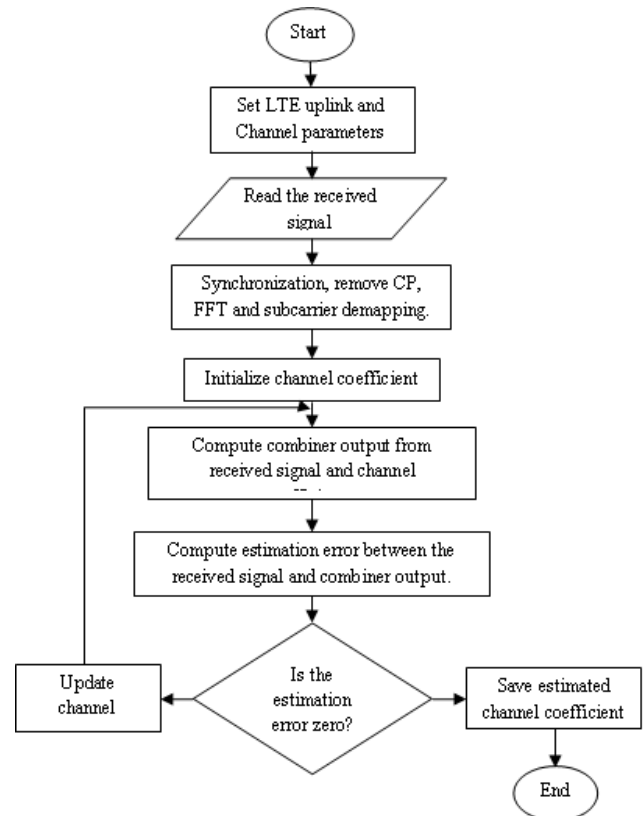

Fig.6 Flow chart of LMS Channel Estimation technique.

This error signal is used by the CE to adaptively adjust the weight vector so that the MSE is minimized. If $w(m)$ is the tap-weight vector at the m^{th} iteration then the following recursive equation may be used to update $W_{est}(m)$:

$$W_{est}(m + 1) = W_{est}(m) + \eta s(m)e^*(m) \tag{4}$$

Where $W_{est}(m+1)$ denotes the weight vector to be computed at iteration $(m+1)$ and η is the LMS step size which is related to the rate of convergence. The smaller step size means that a longer reference or training sequence is needed, which would reduce the payload and hence, the bandwidth available for transmitting data. The term $[\eta s(m)e^*(m)]$ represents the correction factor or adjustment that is applied to the current estimate of the tap-weight vector. The iterative procedure is started with an initial guess $W_{est}(0)$. The detail steps of this CE algorithm are shown in Figure 6. [11].

ii. Variable Step Size (VSS)-LMS Algorithm

The VSS-LMS algorithm involves one additional step size update equation compared with the standard LMS algorithm. The VSS algorithm is [30], [19].

$$\eta(m + 1) = \alpha\eta(m) + \gamma P^2(m) \tag{5}$$

$$P(m) = \beta P(m) + (1 - \beta)e^T(m)e(m - 1) \tag{6}$$

Where $0 < \alpha < 1$, $0 < \beta < 1$, and $\gamma > 0$. When the channel is fast time-varying then algorithm cannot accurately measure the autocorrelation between estimation errors to control step size update. Control parameters α and β need to be adjusted for a better performance [11]. The detail steps of this CE algorithm is shown in Figure 7.

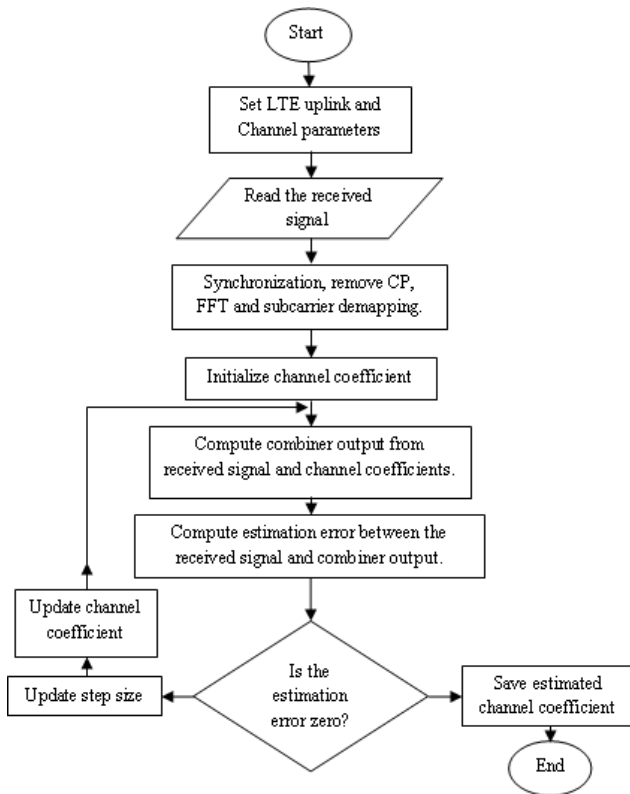

Fig.7 Flow chart of VSS-LMS Channel Estimation technique.

2.2 Simulation description

MATLAB is a high performance language which has easy to use environment and has many build in functions which is used in this work to steer clear of long code.

Table 1 System assumptions.

Systems parameter	Assumption
System bandwidth	5 MHz
Sampling frequency	7.68 MHz
Subcarrier spacing	9.765 kHz (5 MHz/512)
Modulation data type	BPSK,QPSK,16QAM
FFT size	16
Subcarrier mapping scheme	IFDMA
IFFT size	512
Cyclic Prefix	normal
Frame Type	Type 1
Antenna Configuration	SISO
Pilot Spacing	6
Channel model	Extended Pedestrian-A
Maximum Doppler shift	5Hz
Pilot	Zadoff Chu
Equalization	Zero Force
Channel Estimation	LMS, VSS-LMS

Using MATLAB the SC-FDMA system shown in figure 1 will be modeled. LMS and VSS-LMS will be applied for

estimating the channel coefficients. The BER and MSE of LMS and VSS-LMS channel estimation algorithms is evaluated as a function of SNR. The system was tested under SNR from 0-30dB, LMS's BER and MSE are plotted using solid line with star marker and VSS-LMS's ones are plotted with dotted line with square marker. The performance was evaluated under two different modulation methods (BPSK and QPSK). In addition to that time required to estimate the channel response under the specifications documented in table 1 is calculated using the simulation.

Table 2 Channel Estimation Algorithms' assumptions

Channel Estimation Algorithm parameter	Assumption	Channel Estimation Algorithm
η	$6.0000e^{-004}$	LMS
η_0	η_{max}	VSS-LMS
α	0.97	VSS-LMS
β	0.99	VSS-LMS
γ	$7e^{-8}$	VSS-LMS
η_{min}	0	VSS-LMS
η_{max}	$7e^{-004}$	VSS-LMS
Number of iterations	300	LMS/VSS-LMS

3. Results and discussion

Figure 8 shows the BER as a function of SNR for the LMS and VSS-LMS algorithms when using BPSK as the modulation technique and Rayleigh fading channel as a channel model with maximum Doppler shift = 5Hz.

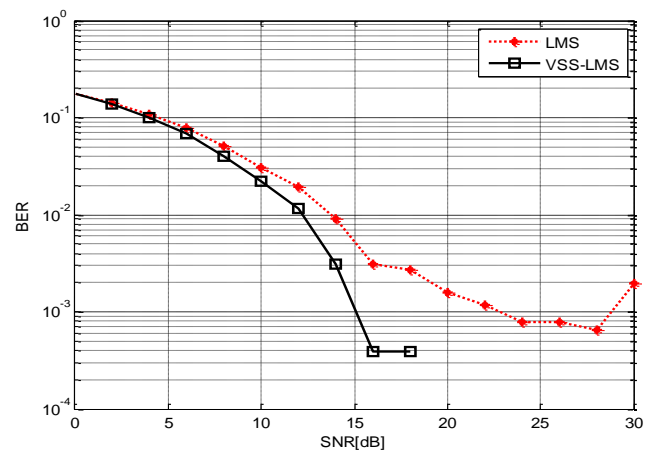

Fig.8 BER of LMS and VSS-LMS algorithms as a function of SNR (Rayleigh channel with Doppler shift = 5Hz, BPSK).

As it is clear, at low SNR (less than 6 dB) the BER for both of the algorithms are almost the same. For higher SNR (greater than 6 dB) the BER for VSS-LMS is better than LMS algorithm. In SNR greater than 12 dB VSS-LMS has BER equal to zero, while the BER of LMS equal to zero for SNR greater than 16 dB. Figure 9 shows the BER as a function of SNR for the LMS and VSS-LMS algorithms when using QPSK as the modulation technique and

Rayleigh fading channel as a channel model with maximum Doppler shift = 5Hz. As it is clear, at low SNR(less than 10 dB) the BER for both of the algorithms are almost the same. For higher SNR (greater than 10 dB) the BER for VSS-LMS is better than LMS algorithm.

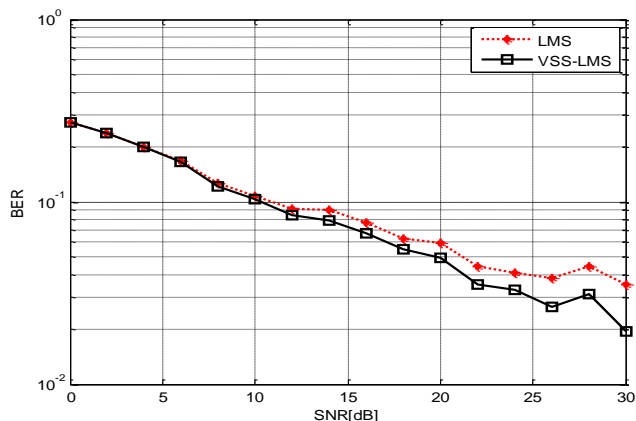

Fig.9 BER of LMS and VSS-LMS algorithms as a function of SNR (Rayleigh channel with Doppler shift = 5Hz, BPSK).

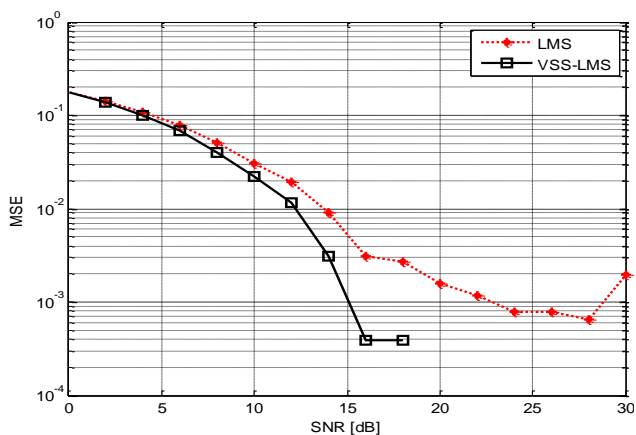

Fig.10 MSE of LMS and VSS-LMS algorithms as a function of SNR (Rayleigh channel with Doppler shift = 5Hz, BPSK).

Figure 10 shows the MSE as a function of SNR for the LMS and VSS-LMS algorithms when using BPSK as the modulation technique and Rayleigh fading channel as a channel model with maximum Doppler shift = 5Hz. As it is clear, at low SNR(less than 6 dB) the MSE for both of the algorithms are almost the same. For higher SNR (greater than 6 dB) the MSE for VSS-LMS is better than LMS algorithm. In SNR greater than 12 dB VSS-LMS has MSE equal to zero, while the MSE of LMS equal to zero for SNR greater than 16 dB.

Figure 11 shows the MSE as a function of SNR for the LMS and VSS-LMS algorithms when using QPSK as the modulation technique and Rayleigh fading channel as a channel model with maximum Doppler shift = 5Hz. As it is clear, at low SNR(less than 10 dB) the MSE for both of the algorithms are almost the same. For higher SNR (greater than 10 dB) the MSE for VSS-LMS is better than LMS algorithm.

LMS algorithm requires $2N+1$ multiplication operations, N multiplications for the weights update and $N+1$ for error calculations, and $2N$ addition operations, N subtraction operations for error estimation and N addition operations for weights update. See equation 3 and 4. VSS-LMS algorithm requires $3N+6$ multiplication operations and $2N+2$ addition operations. In addition to the operations used in LMS algorithm it requires $N+5$ multiplication operations and 2 addition operations, See equation 5 and 6. The time elapse by the two algorithms is shown in figure 12. This figure shows that the LMS requires as average 4.0711 ms and VSS-LMS requires 195.6453 ms.

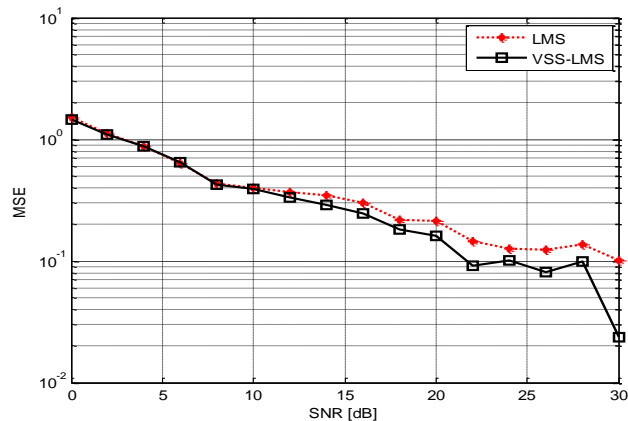

Fig.11 MSE of LMS and VSS-LMS algorithms as a function of SNR (Rayleigh channel with Doppler shift = 5Hz, QPSK).

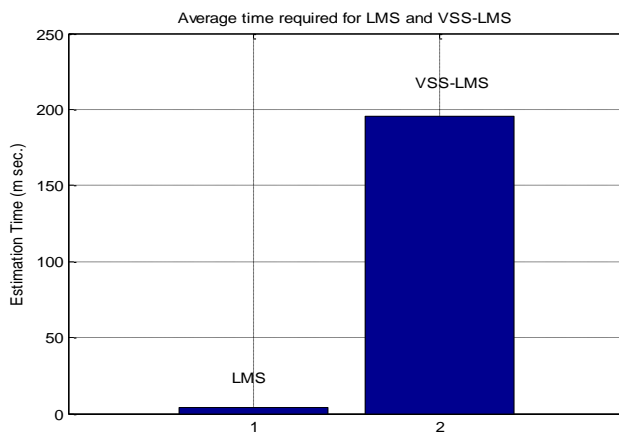

Fig.12 Time estimation of LMS and VSS-LMS algorithms.

4. Conclusion

The BER and MSE degraded when using QPSK modulation compared with BPSK for both algorithms, however; VSS-LMS is less affected by modulation type compared to LMS. With regard to algorithm complexity, VSS-LMS requires just two additional addition operations compared to LMS. But it requires $N+5$ multiplications. As it is known, multiplication operation requires more time to be accomplished (in simulation VSS-LMS algorithm elapsed approximately about 50 times the time elapsed by LMS algorithm). Since VSS-LMS has better performance than LMS algorithm but require more operation, reducing the number of operations by

modifying the cost term of the gain factor equation may give better results. So more studying in this area is required.

References

- [1]. <http://www.etsi.org>, "Work Plan 3GPP (Release 8)", 1 March 2012.
- [2]. H. Ekström, A. Furuskär, J. Karlsson, M. Meyer, S. Parkvall, J. Torsner, and M. Wahlqvist, "Technical Solutions for the 3G Long-Term Evolution," *IEEE Commun. Mag.*, vol. 44, no. 3, pp. 38–45, 2006.
- [3]. PARK, S. Y., KIM, Y. G., KANG, C. G. "Iterative receiver for joint detection and channel estimation in OFDM systems under mobile radio channels". *IEEE Trans. on Vehicular Technology*, vol. 53, no. 2, p. 450 – 460, 2004.
- [4]. HSIEH, M. H., WE, C. H. "Channel estimation for OFDM systems based on comb-type pilot arrangement in frequency selective fading channels". *IEEE Trans. on Consumer Electronics*, vol. 44, no. 1, p. 217 – 225, 2004.
- [5]. DOUKOPOULOS, X. G., MOUSTAKIDES, G. V. "Blind adaptive channel estimation in OFDM systems", *IEEE Trans. On Wireless Communication*, vol. 5, no. 7, pp. 1716 – 1725, 2006.
- [6]. ADIREDDY, S., TONG, L., VISWANATHAN, H. "Optimal placement of training for frequency selective block fading channels. *IEEE Trans. on Information Theory*", vol. 48, no. 8, p. 2338 – 2353, 2002.
- [7]. A. ncora, C. Bona, and D.T.M. Slock, "Down-sampled impulse response least-squares channel estimation for LTE OFDMA," *Proc. Int. Con. ASSP*, vol. 3, pp. 293-296, April 2007.
- [8]. L. A. M. R. D. Temino, C. N. I Manchon, C. Rom, T. B. Sorensen, and P. Mogensen, "Iterative channel estimation with robust wiener filtering in LTE downlink," *Proc. Int. Con. on VTC*, pp. 1-5, September 2008.
- [9]. Yongkui Ma, Ping Tan, Xiaoyu Wang, Dianwei Li, "Research on Channel Estimation Based on Adaptive Filtering for LTE Uplink", *IEEE*, 2012.
- [10]. Md. Masud Rana, Jinsang Kim, and Won-Kyung Cho, "An Adaptive LMS Channel Estimation Method for LTE SC-FDMA Systems", *International Journal of Engineering & Technology IJET-IJENS* Vol: 10 No: 05.
- [11]. Md. Masud RANA, Jinsang KIM, Won-Kyung CHO, "LMS Based Adaptive Channel Estimation for LTE Uplink", *RADIOENGINEERING*, VOL. 19, NO. 4, DECEMBER 2010.
- [12]. Agilent Technologies, "Uplink resource block", Agilent Technologies Inc, USA, 2007.
- [13]. Rohde and Schwarz, "UMTS Long Term Evolution (LTE) Technology Introduction".
- [14]. Agilent Technologies, "Agilent Technologies Solutions for 3GPP LTE", Agilent Technologies Inc., USA, 2007.
- [15]. Hyung G. Myung, Junsung Lim, and David J. Goodman, "Single Carrier FDMA for Uplink Wireless Transmission", *IEEE VEHICULAR TECHNOLOGY MAGAZINE*, SEPTEMBER 2006.
- [16]. 3rd Generation Partnership Project (3GPP), "Requirements for Evolved UTRA (EUTRA) and Evolved UTRAN (E-UTRAN)", <http://www.3gpp.org/ftp/Specs/htmlinfo/25913.ht>.
- [17]. Yibing Li, Xu Zhang, Fang Ye, "Improved Dynamic Subcarrier Allocation Scheduling for SC-FDMA Systems", *Journal of Information & Computational Science* 9: 12, 2012.
- [18]. David Falconer, S. Lek Ariyavisitakul, Anader Benyamin-Seeyar, Brian Eidson, "Frequency Domain Equalization for Single-Carrier Broadband Wireless Systems", *Communications Magazine*, IEEE, Apr. 2002.
- [19]. Jin Xinzhu, "Channel Estimation Techniques of SC-FDMA", *Karlstad University*, 2007.
- [20]. Raina Rahman, "CPM-SC-IFDMA|A Power Efficient Transmission Scheme for Uplink LTE", *University of Kansas*, 2010.
- [21]. B. Widrow and M. Hoff, "Adaptive switching circuits," in *Proc. IRE Western Electronic Show and Convention*, New York, USA, Part 4, Aug. 1960, pp. 96-104.
- [22]. S. Haykin, *Adaptive Filter Theory*, 4th edition, Upper Saddle River, NJ: Prentice Hall, 2002.
- [23]. José Gil F. Zipf, Orlando J. Tobias, and Rui Seara, "A VSS-LMS ALGORITHM BASED ON ERROR AUTOCORRELATION", 16th European Signal Processing Conference (EUSIPCO 2008), Lausanne, Switzerland, August 25-29, 2008.