

Washington University in St. Louis

## Washington University Open Scholarship

---

All Computer Science and Engineering  
Research

Computer Science and Engineering

---

Report Number: WUCS-86-10

1986-06-01

### Performance of a Broadcast Packet Switch

Richard G. Bubenik and Jonathan S. Turner

This paper reports the results of a simulation study undertaken to evaluate a high performance packet switching fabric supporting point-to-point and multipoint communications. This switching fabric contains several components each based on conventional binary routing networks. The most novel element is the Copy Network which performs the packet replication needed for multipoint connections. We present results characterizing the performance of the Copy Network, in particular quantifying its dependence on fanout and the location of active sources. We also evaluate several architectural alternatives for conventional binary routing networks. For example, we quantify the performance gains obtainable by using cut-through switching... [Read complete abstract on page 2.](#)

Follow this and additional works at: [https://openscholarship.wustl.edu/cse\\_research](https://openscholarship.wustl.edu/cse_research)

---

#### Recommended Citation

Bubenik, Richard G. and Turner, Jonathan S., "Performance of a Broadcast Packet Switch" Report Number: WUCS-86-10 (1986). *All Computer Science and Engineering Research*.  
[https://openscholarship.wustl.edu/cse\\_research/826](https://openscholarship.wustl.edu/cse_research/826)

Department of Computer Science & Engineering - Washington University in St. Louis  
Campus Box 1045 - St. Louis, MO - 63130 - ph: (314) 935-6160.

## Performance of a Broadcast Packet Switch

Richard G. Bubenik and Jonathan S. Turner

### Complete Abstract:

This paper reports the results of a simulation study undertaken to evaluate a high performance packet switching fabric supporting point-to-point and multipoint communications. This switching fabric contains several components each based on conventional binary routing networks. The most novel element is the Copy Network which performs the packet replication needed for multipoint connections. We present results characterizing the performance of the Copy Network, in particular quantifying its dependence on fanout and the location of active sources. We also evaluate several architectural alternatives for conventional binary routing networks. For example, we quantify the performance gains obtainable by using cut-through switching in the context of binary routing networks with small buffers. One surprising result is that networks constructed for nodes with more than two input and output ports can perform less well than those constructed from binary nodes. We quantify and explain this result, showing that it is a consequence of a subtle effect of the FIFO queueing discipline used in the nodes. We also show that substantially better performance can be obtained by relaxing the strict FIFO discipline.

**Performance of a Broadcast Packet Switch**

**Richard G. Bubenik and Jonathan S. Turner**

**WUCS-86-10**

**June 1986**

**Department of Computer Science  
Washington University  
Campus Box 1045  
One Brookings Drive  
St. Louis MO 63130-4899**

*This work supported by Bell Communications Research and Italtel SIT. As appeared in the Proceedings of the International Conference, June 1987. To appear in IEEE Transactions on Computers.*

## Abstract

This paper reports the results of a simulation study undertaken to evaluate a high performance packet switching fabric supporting point-to-point and multipoint communications. This switching fabric contains several components each based on conventional binary routing networks. The most novel element is the *Copy Network* which performs the packet replication needed for multipoint connections. We present results characterizing the performance of the Copy Network, in particular quantifying its dependence on *fanout* and the location of active sources. We also evaluate several architectural alternatives for conventional binary routing networks. For example, we quantify the performance gains obtainable by using *cut-through switching* in the context of binary routing networks with small buffers. One surprising result is that networks constructed from nodes with more than two input and output ports can perform less well than those constructed from binary nodes. We quantify and explain this result, showing that it is a consequence of a subtle effect of the FIFO queueing discipline used in the nodes. We also show that substantially better performance can be obtained by relaxing the strict FIFO discipline.

# PERFORMANCE OF A BROADCAST PACKET SWITCH

Richard G. Bubenik  
Jonathan S. Turner

## 1. Introduction

In [16], Turner describes a packet switched communications system, which supports multipoint connections in addition to conventional point-to-point connections. The principal component of this system is a packet switch called a *Switch Module* which replicates and distributes multipoint packets and routes point-to-point packets. This paper reports on a simulation study of the Switch Module undertaken to characterize its performance. Some of these results were reported previously in Bubenik's masters thesis [1].

The Switch Module described in [16] uses a buffered binary routing network as one of its primary components. This network is one of a class that includes the banyan, delta, shuffle-exchange and omega networks among others. When these networks are operated in a buffered mode, the distinctions between them become unimportant and we will therefore refer to them all simply as binary routing networks. The performance of such networks has been studied extensively. See for example [2,3,4,6,7,8,10,12]. Our work differs from previous studies in several respects. The most important is that we evaluate the performance of a *Copy Network*; this is a binary routing network modified to perform the packet replication required for multipoint connections, rather than packet routing. This is to our knowledge, the first study of a network of this sort. Our work also differs from most previous studies in that we consider binary routing networks employing *cut-through switching* [9]. In this mode of operation, a packet need not be fully buffered at every stage of the network, but may proceed directly to the next stage, once the header has been decoded. This yields significant performance gains. We also consider several architectural trade-offs in order to assess their effect on system performance.

Section 2 briefly describes the architecture and operation of a single Switch Module. Section 3 gives the results of simulations of the Routing and Distribution Networks, including results on several architectural variations of the basic design. Section 4 gives results for the Copy Network under a variety of conditions and in section 5 we offer our conclusions and outline directions for future research.

## 2. System Description

Reference [16] describes a broadcast packet switching system comprising a number of components called Switch Modules or SMs. A network made up of these switch modules can support multipoint connections suitable for applications such as entertainment video distribution, LAN interconnection

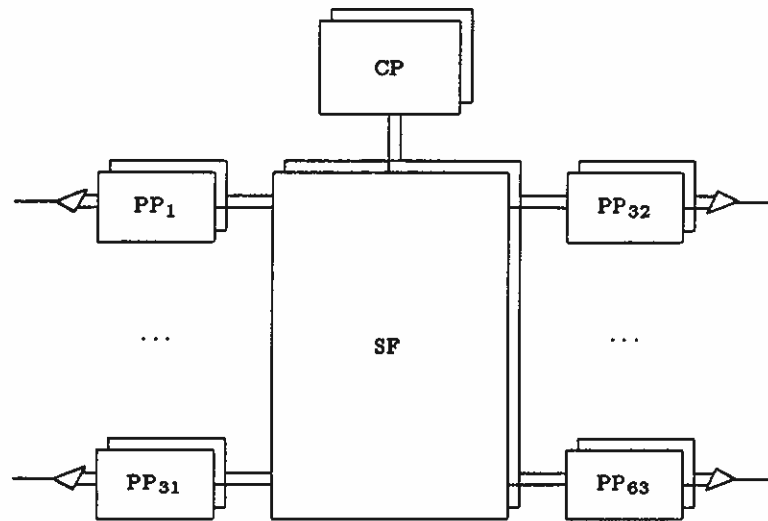

Figure 1: Switch Module

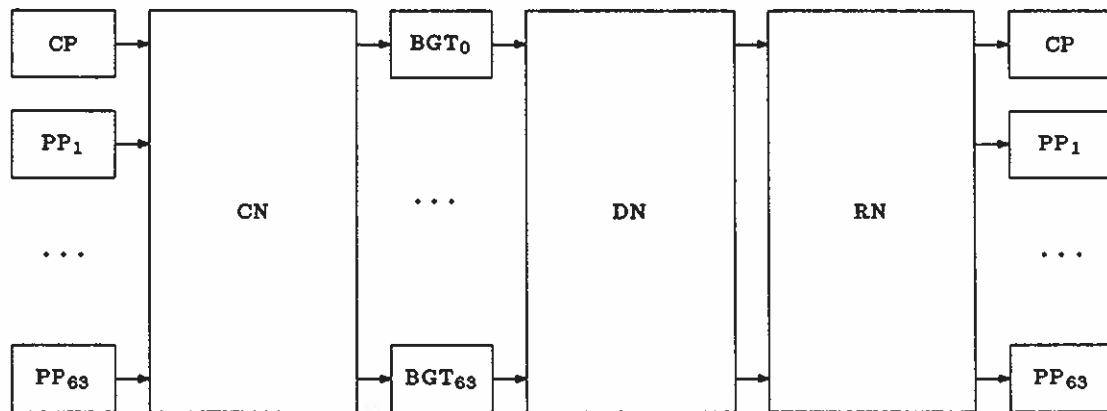

Figure 2: Switch Fabric

and voice/video teleconferencing. In this paper, we study the performance of a single SM using a special-purpose simulation program designed for this purpose. The simulator was written in the C++ programming language [13].

We briefly review the operation of the Switch Module here. The reader is referred to [16] for further details. The overall structure is shown in Figure 1. The SM terminates up to 63 Fiber Optic Links (FOL). Data is carried on the FOLs in the form of large fixed-length packets of approximately 5000 bits each. The *Packet Processors* (PP) perform link level protocol functions, including the determination of how each packet is routed. The *Switching Fabric* (SF) is a parallel packet switching interconnection network that provides routing of point-to-point packets plus replication and distribution of multipoint packets. The *Connection Processor* (CP), is responsible for establishing

connections, including both point-to-point and multipoint connections. It will not be of concern to us here.

When a packet enters the SM, it is reformatted by the addition of several new fields, the Routing field being the only one that concerns us here. The Routing field (RF) contains information needed to process a packet within the switch fabric. In the case of point-to-point packets, it includes an outgoing link number which is used to route the packet through the switch fabric. In the case of multipoint packets, it includes a *Fanout* field which specifies the number of outgoing links that must receive copies of the packet.

A block diagram of the Switch Fabric (SF) is given in Figure 2. It contains four major components, a *Copy Network*, a set of *Broadcast and Group Translators*, a *Distribution Network* and a *Routing Network*. The SF runs at a clock rate of 25 Mbs and has eight bit wide internal data paths. This gives an effective bit rate of 200 Mbs on the internal data paths, or two times the speed of the FOLs. An occupancy of 80% on the FOLs translates to a 40% occupancy on the internal data paths, which keeps contention and delay low.

When a multipoint packet having  $k$  destinations passes through the Copy Network (CN), it is replicated so that  $k$  copies of that packet emerge from the CN. Point-to-point packets pass through the CN without change. The principal function of the Broadcast and Group Translators (BGT) is to assign an outgoing link number to the multiple copies of multipoint packets. As the BGTs' effect on performance is completely deterministic, we will ignore them here. The reader is referred to [16] for details.

The Distribution and Routing Networks (DN,RN) move the packets to the proper outgoing PP. The RN is a  $64 \times 64$  binary routing network. Its structure is illustrated in Figure 3 which shows a  $16 \times 16$  version. The key property of such networks is that they are *bit addressable*—that is, the route a packet takes through the network is determined by successive bits of its destination address. The figure shows paths from two different input ports to output port 1011. Note that at the first stage the packet is routed out the lower port of the node (corresponding to the first one bit of the destination address), at the second stage it is routed out the upper port (corresponding to the zero bit) and in the third and fourth stages it is routed out the lower ports. The self-routing property is shared by a variety of different although similar interconnection patterns, including the so-called banyan, delta, shuffle-exchange and omega networks [5].

Buffers are provided at the inputs of each node. Each buffer holds one or more complete packets. The simulation results given below evaluate several possible buffer sizes. A packet may pass through a node without being buffered at all if the desired output port is available when the packet first arrives. Indeed, in a lightly loaded network, a packet can pass through the RN with no buffering at all. In this case it encounters a delay of just a few clock times in each node.

The data paths between nodes are eight bits wide. In addition, there is a single upstream control lead used to implement a simple flow control mechanism. This prevents loss of packets due to buffer overflows within the fabric. The entire network is operated synchronously, both on a bit basis and a packet basis—that is, all packets entering a given stage do so during the same clock cycle.

Figure 4 is a more detailed picture of a single switch node. The *Node Control* (NC), at the center of the figure monitors the availability of the downstream neighbors via the downstream grant lines ( $dg_1, dg_2$ ) and arbitrates access to the outgoing links. The two *Input Controllers* (IC) receive packets from their upstream neighbors, request the appropriate output link (or links) from the node control, buffer packets if necessary and apply upstream flow control using the upstream grant lines ( $ug_1, ug_2$ ) as needed to prevent buffer overflow. Nodes can also be constructed with more than two input and output ports. In the next section we compare the performance of networks constructed from two port nodes and four port nodes.

Figure 3:  $16 \times 16$  Binary Routing Network

Figure 4: Switch Node



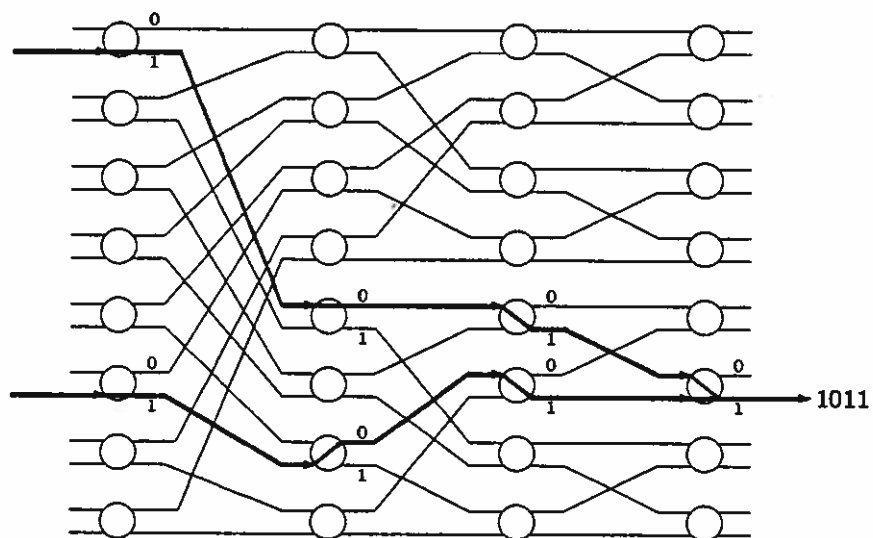
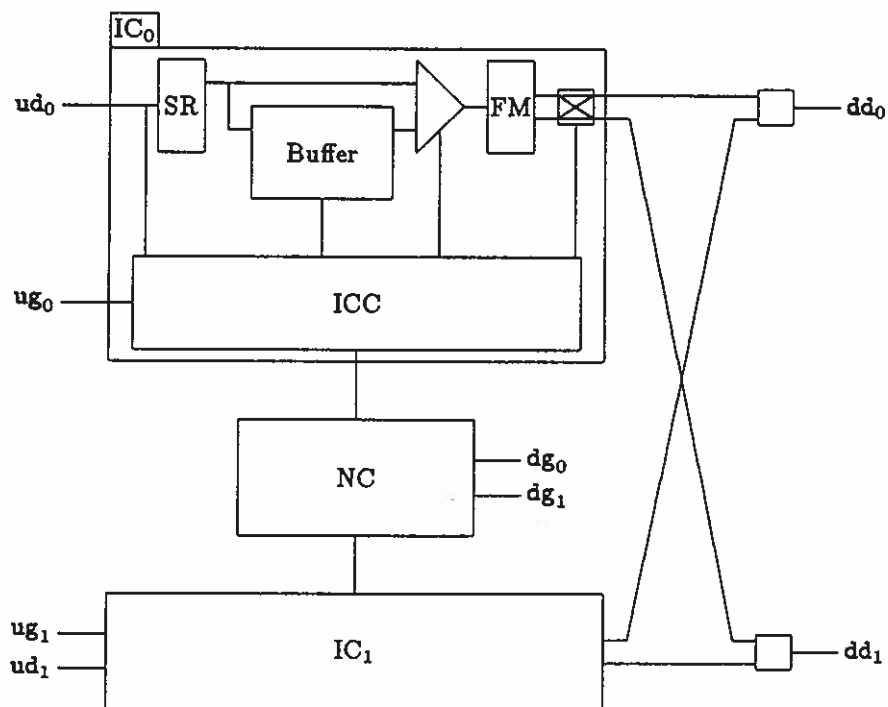
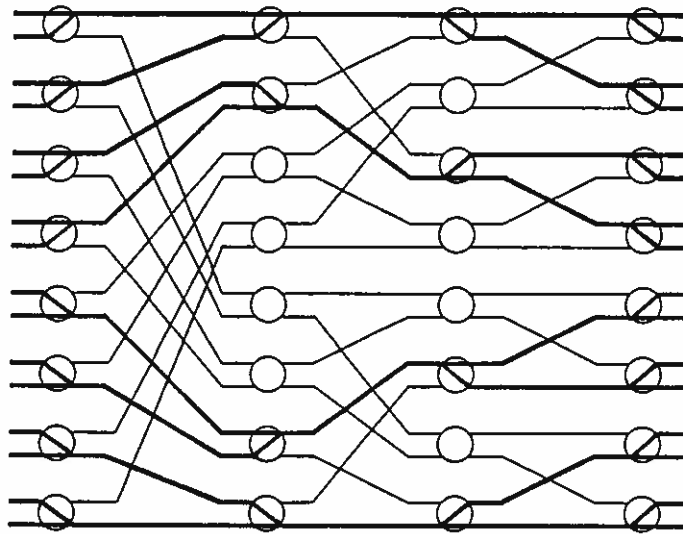

Figure 5: Congestion in Binary Routing Networks

The entire switch fabric operates synchronously using a fixed length packet cycle. Each packet cycle can be viewed as having two phases. During the first phase of the cycle, grant signals propagate from the outgoing packet processors back through to the front of the RN, DN and CN. The outgoing packet processors always accept new packets (if they don't have room in the outgoing buffer, packets are lost). Each node in the switch fabric examines its downstream grant lines and the state of its buffers, then generates the appropriate upstream grant signal. An IC in a node can assert its upstream grant line if it has at least one empty buffer slot. If its buffer is occupied, it attempts to reserve one or more output ports for use during the next cycle (the requested port or ports is determined by the first buffered packet). If the node control grants the reservation request, the IC is assured of being able to move one packet forward during the next cycle and will therefore assert its upstream grant line. Hence, the only case in which the upstream grant line is not asserted is when an IC has full input buffers and has its reservation request denied. After the grant signals ripple back through to the inputs of the switch fabric, packets flow forward. This is the second phase of the packet cycle. It is possible for the two phases to overlap in time, so the effective length of a packet cycle is just the time required to transmit a packet across one of the internal data paths.

One problem with binary routing networks is that they can become congested in the presence of certain traffic patterns. This is illustrated in Figure 5, which shows a traffic pattern corresponding to several *communities of interest*. In this pattern, all traffic entering the first four inputs is destined for the first four outputs, all traffic entering the second group of four inputs is destined for the second group of four outputs, and so forth. Note that with this pattern, only one fourth of the links joining the second and third stages are carrying traffic. Thus, if the inputs are heavily loaded the internal links will be hopelessly overloaded and traffic will back up. In a  $64 \times 64$  network, there are six stages and the links between the third and fourth stages can in the worst-case be carrying all the traffic on just eight of the 64 links. The purpose of the DN is to eliminate this problem by evenly distributing packets it receives across all its outputs. It has the same internal structure as the RN, but its nodes ignore the destination addresses on packets and route them alternately to each of their output ports.

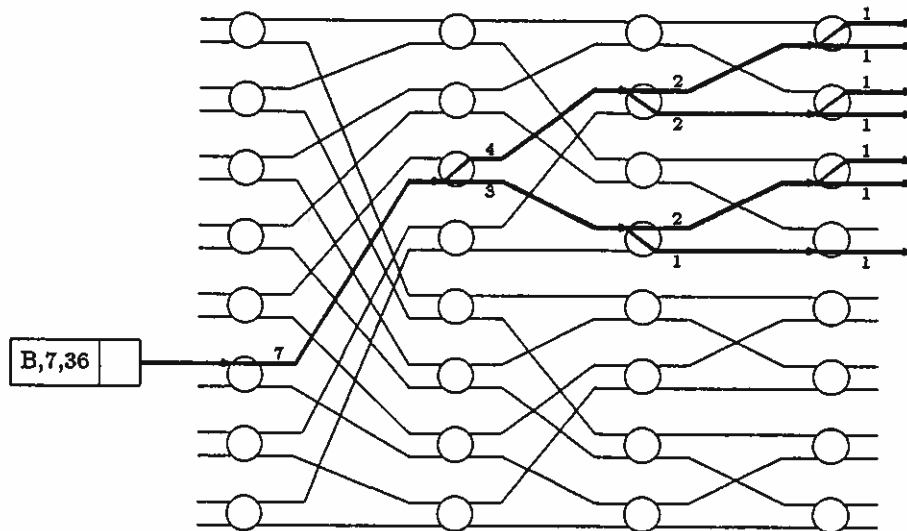

Figure 6:  $16 \times 16$  Copy Network

This strategy is modified if one or both ports is unavailable. In this case, the first port to become available is used. This approach is designed to break up any communities of interest and make the combination of the DN and RN robust in the face of pathological traffic patterns. This configuration is evaluated in the next section.

The structure of the Copy Network (CN) is the same as that of the RN and CN. The CN's function is to make copies of multipoint packets as they pass through, as illustrated in Figure 6. The packet entering at left has a fanout of 7 meaning that it will be sent to seven different output links. At the first stage, the packet is routed out the upper port. This is an arbitrary decision—the lower link could have been used at this point. At the second stage, the packet is sent out on both outgoing links and the fanout fields in the outgoing packets are modified. The upper packet generates four copies and the lower one three. In general, a node in the copy network will replicate a packet if its current fanout value exceeds one-half the number of CN output ports reachable from that node. The fanout values are split as evenly as possible, with an arbitrary decision being made as to which port gets the "bigger half" in the case of an odd fanout value. When a multipoint packet is not replicated, it is routed arbitrarily to one of the node's two output ports. Point-to-point packets are routed through the CN arbitrarily, taking the "path of least resistance."

A simulation model was written that includes components for the incoming Packet Processor, Copy Network, Distribution Network and Routing Network. The Packet Processor was modeled simply as an infinite queue. Each of the networks in the switch fabric was modeled explicitly. The simulation mimics the synchronous nature of the actual system. During each packet cycle, grants are propagated from outputs to inputs, new packets are generated by packet sources feeding into the input buffers and packets are moved forward through the input buffers and switch fabric. Each packet source has a parameter specifying the probability that a packet is generated during a particular cycle. Each cycle is treated independently and at most one packet enters a particular input buffer during a packet cycle. The results described in the next section cover several different configurations in addition to the one just described. In particular, in most of the runs not all the

components described above are included. Also, several variations on the basic design described above are explored. Details of these variations will be given as the results are presented.

### 3. Evaluation of the Routing and Distribution Networks

This section describes a basic set of simulations, selected from an extensive simulation study described fully in [1]. We focus here on the Routing and Distribution Networks. Results for the Copy Network appear in the following section. Unless otherwise stated, the quoted results are for a switch fabric with 64 input and output ports and two port switch nodes.

The first set of results, shown in Figure 7, is for a configuration consisting of a set of input buffers feeding directly into a Routing Network. The CN and DN have been omitted to permit a detailed examination of the RN. This delay plot (and all subsequent ones) gives delay in packet times where a packet time is just the time required to transmit a packet across one of the internal data paths. Assuming 5000 bit packets and a 200 Mb/s data rate on the internal data paths, one packet time is 25  $\mu$ s. Two sets of delay curves are given. The curves that flatten out at large offered loads give the delay through the RN alone, while the other curves give the total delay through the input buffers and the RN. Delays are measured from the time the front end of a packet enters a component to the time the front end leaves the component. Hence, they neglect the time needed to buffer the packet as it exits the switch fabric (that time is one packet time). Notice also that the simulation ignores details such as the pipeline delay experienced by a packet as it passes through a node, since this is a constant which is completely determined by details of the node design. These simulations were run under the *uniform traffic assumption*—that is, packets generated at the sources were assigned random destination addresses with each destination address equally likely.

In these plots, offered load is expressed as a fraction of the capacity of the switch fabric under ideal conditions. Under such ideal conditions, the switch fabric is capable of passing a packet out of every output port during every packet cycle. What has been plotted is the offered load measured at the packet sources. Carried load is the fraction of the ideal capacity that the system actually delivers and is measured at the outputs of the switch fabric.

The results in Figure 7 give the delay for nodes with 1, 2 and 4 buffer slots per input port. As one would expect, increasing the number of buffers increases the throughput of the network and reduces total delay. The carried load curves show clearly the effect of node buffer size on network throughput. As mentioned earlier, the internal data paths operate at twice the rate of the external links meaning that the offered loads within the switch fabric cannot exceed 0.5. If the external links carry a load of 0.8, the internal loading is 0.4. The carried load plot shows that even with a buffer size of one, the RN has sufficient throughput to carry this load. On the other hand, the delay plot shows that the safety margin is unacceptably small with this buffer size. A buffer size of two is probably required to provide an adequate margin against occasional traffic surges. It's worth noting that at low loads, most of the delay is incurred within the RN while at high loads the RN delay becomes constant while the input buffer delay becomes very large. This is a pattern that will be reappear in later results. Note that at an offered load of 0.4, the total delay is approximately two packet times, which translates to about 50  $\mu$ s, assuming 5000 bit packets and a 200 Mb/s data rate.

The next set of results demonstrates the effectiveness of the Distribution Network in breaking up pathological traffic patterns. See Figure 8. The curves labeled "without DN" show the performance of the RN when subjected to a traffic pattern calculated to cause extensive congestion. In particular, traffic was constrained to eight "communities of interest" similar to those shown in Figure 5. This pattern forces all the traffic though just eight of the 64 links in the middle stage of the RN. As expected, this leads to a maximum throughput of about 0.125. The curves labeled "with DN" show the performance when the DN is inserted in front of the RN and the same traffic pattern is applied.

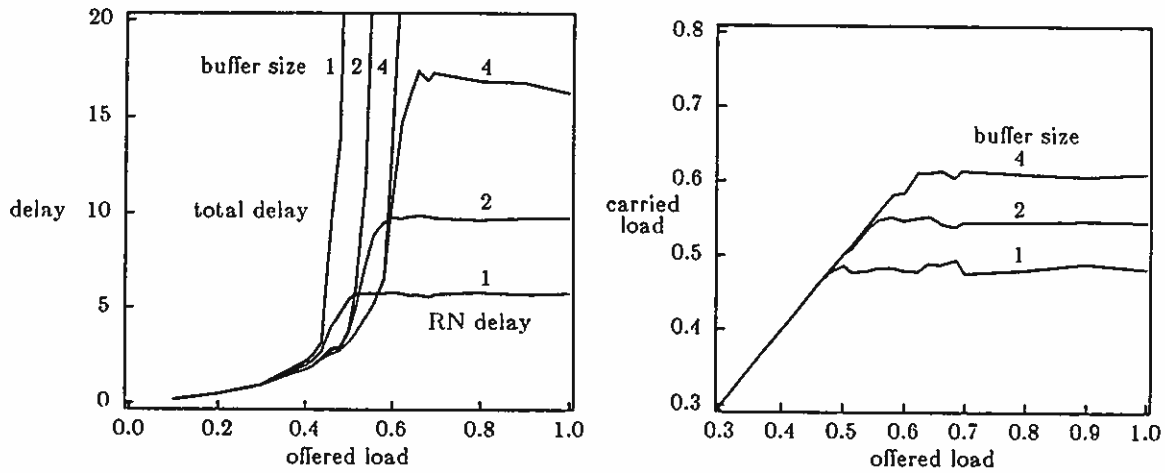

Figure 7: Delay and Throughput Curves for Routing Network

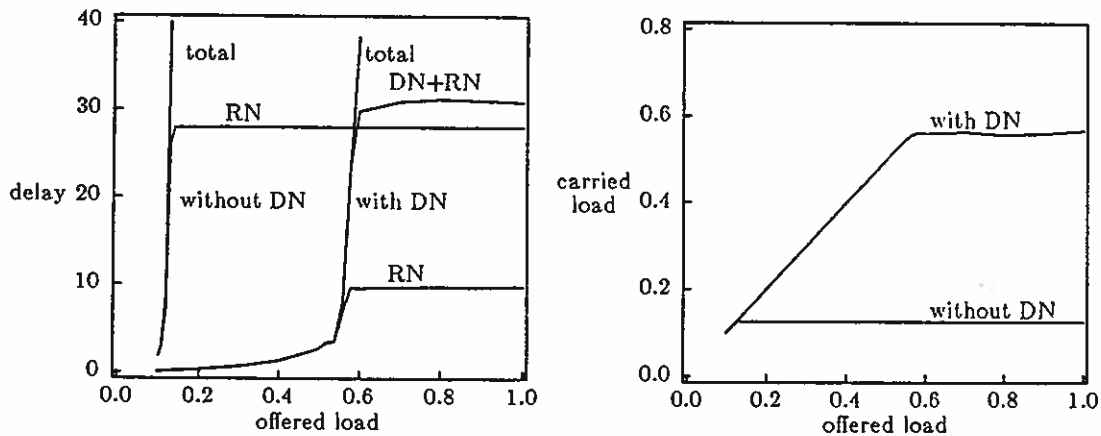

Figure 8: Performance in the Presence of Communities of Interest

Note that the throughput in this case matches that of the RN-only configuration with uniform traffic. Also note that at loads of less than 0.5, the DN adds very little delay. Apparently, at these loads packets encounter little or no "back pressure" from the RN and simply flow through the DN taking the path of least resistance.

### Effect of Cut-Through

Perhaps the principal difference between the Routing Network described here and buffered binary routing networks discussed elsewhere is the use of *cut-through operation* in the switch nodes. In most previous work, packets are buffered completely at each node in the switch fabric before being advanced to the next stage. We relax this restriction, allowing a packet to proceed immediately to the outgoing link whenever possible. Cut-through switching has also been employed in the Fast Packet Switch described in [11,14,17]. The concept of cut-through switching was first discussed

in print in [9], although in a different context. Their analysis of the performance of cut-through switching shows significant advantages, but does not apply to the specifics of our situation. To quantify the advantage of cut-through switching we performed a simulation of the Routing Network in which cut-through was not used. This simulation is for a 64 port routing network with two slot buffers at the node inputs. The resulting comparison appears in Figure 9.

Notice that at low loads, the total delay without cut-through is at least six packet times, corresponding to the enforced buffering at each stage of the simulated network. When cut-through is used, the total delay is less than a single packet time. At an offered load of 0.4, the total delay with cut-through is about two packet times, while without cut-through, it is about eight. This is a significant advantage in the target application as it translates to a delay of  $50 \mu s$  vs  $200 \mu s$ . The delay advantage is even more striking than this comparison reveals, since (as we will see later) most of the delay in the switch fabric comprising the CN, DN and RN occurs in the RN when cut-through is used. Without cut-through the delay would be at least 18 packet times, whereas with cut-through, it is less than three packet times. We also note that the use of cut-through increases the throughput of the switch fabric from 0.5 to 0.55.

Given the advantages obtained with cut-through switching, it is perhaps surprising that it is not universally used. To learn the reason it is not, one must look more closely at specific applications of buffered binary routing networks. In most cases where they have been proposed, the intended application is an interconnection network in a parallel computing system. Typically, these applications involve small packets in which the addressing information may be a large part of the total packet. In this situation, the advantages of cut-through switching are significantly reduced and the extra control complexity required of the nodes may not be justified. On the other hand, in communications systems applications where the addressing information is typically a small part of the packet, cut-through is clearly the right choice.

### Effect of Node Size

We now consider the effect of varying the number of node input and output ports on routing network performance. In particular we compare the performance of a routing network with 64 input and output ports comprising two port nodes to one comprising four port nodes. Four port nodes appear to offer several advantages. First, they can implement a given size network with half the number of stages required when using two port nodes. This makes them topologically richer and since the links between stages are the places where contention occurs, there is less opportunity for contention with four port nodes. This leads one to expect networks constructed with four port nodes to have larger throughput than networks using two port nodes. One also expects smaller delays, since the number of places a packet can be buffered is smaller. Finally, because there are fewer stages, fewer buffers are needed (assuming the number of buffer slots per node input port is the same in both cases). Hence, larger nodes offer advantages in system complexity as well as performance. The intuitive case in favor of larger nodes is compelling. There is also analytical support for the contention that larger nodes perform better than smaller ones. In [12], Patel analyzes the performance of unbuffered binary routing networks and shows that larger nodes offer substantial performance advantages.

We examined three different configurations. Network A is a 64 port routing network with two port nodes and two buffer slots per node, network B is a 64 port routing network with four port nodes and two buffer slots per node, network C is a 64 port routing network with four port nodes and four buffer slots per node. In light of the arguments given above, the results shown in Figure 10 are surprising. Notice that network A out-performs B—it offers higher throughput and smaller total delay. One possible explanation for this behavior is that network B has half the total number of buffer slots that network A has and incurs a performance penalty as a result. Network C however,

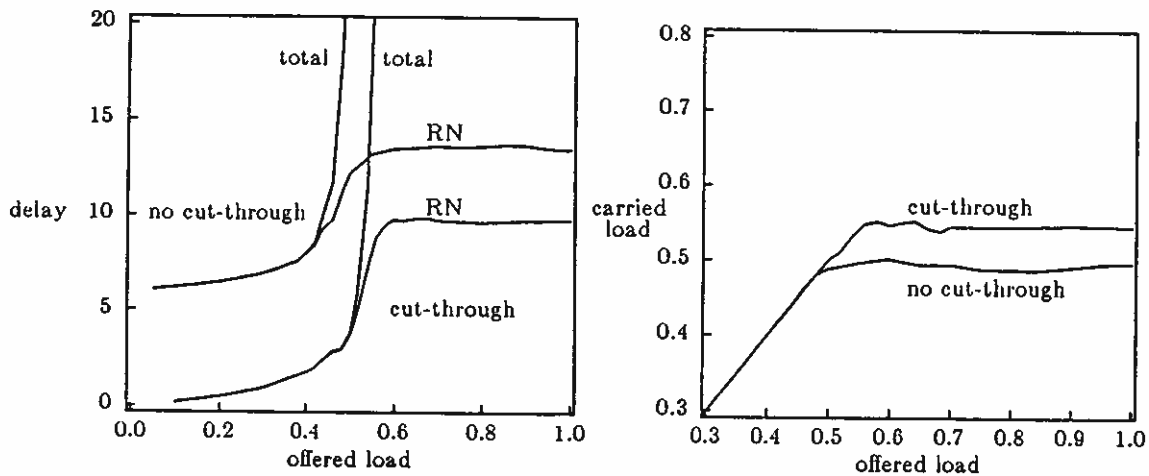

Figure 9: Effect of Cut-Through

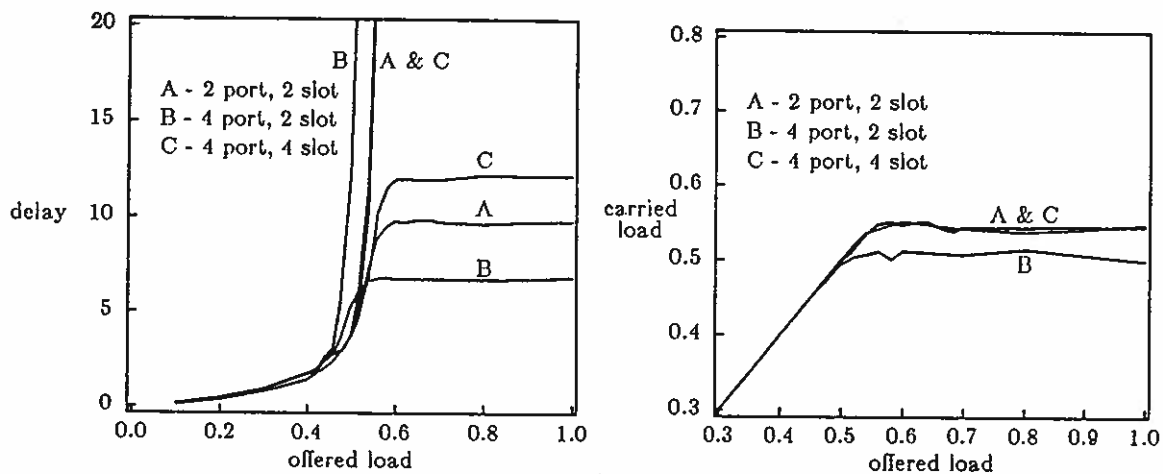

Figure 10: Effect of Node Size

has the same number of buffer slots as A and while it performs better than B, it is still no better than A.

This apparent anomaly is a subtle consequence of the strict FIFO queueing discipline used in the node buffers. If the output port required by the first packet in a node buffer is unavailable, it and all other packets in that buffer must wait. This is true even if the subsequent packets in the buffer require output ports that are available. This queueing discipline limits the way in which packets can proceed through the network. Moreover, it has a more limiting effect on networks constructed from four port nodes than it does on networks constructed from two port nodes. It is this effect that leads to the apparent anomaly.<sup>1</sup>

<sup>1</sup>When this effect was first observed, the only likely explanation appeared to be a faulty simulation. It was only after spending several days in a fruitless hunt for simulator bugs that we came to understand the real nature of this effect.

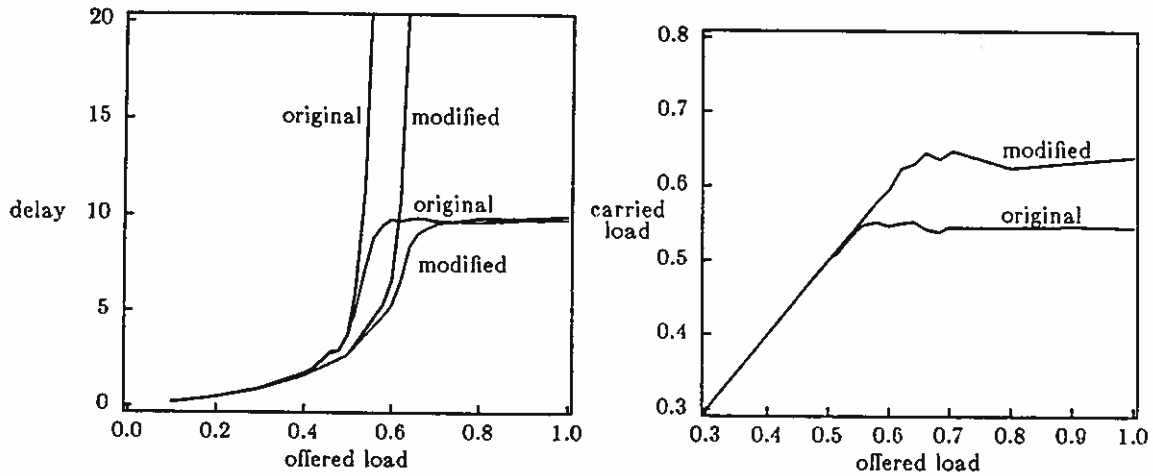

Figure 11: Effect of Modified Queueing Discipline

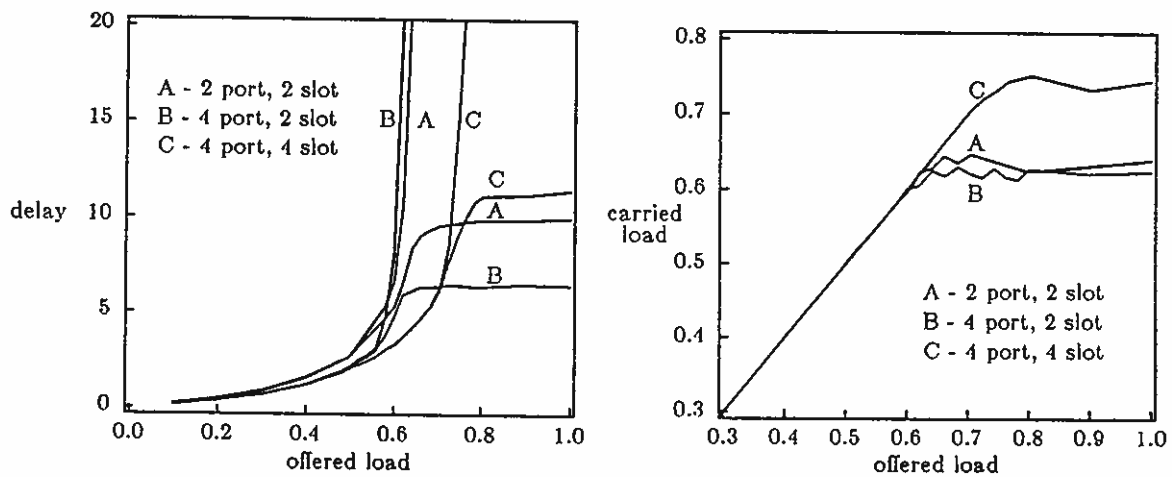

Figure 12: Effect of Node Size with Modified Queueing Discipline

**Effect of Modified Queueing Discipline**

In light of the results just discussed, an obvious next step is to relax the FIFO queueing discipline in the node buffers. We now consider a modified queueing discipline in which a packet other than the first one is allowed to proceed if all its predecessors in the queue are blocked, but it is not. Figure 11 shows the effect of this modified queueing discipline on a routing network with two port nodes and two buffer slots per node. Note that the throughput of the network increases from about 0.55 to 0.63, a substantial improvement.

We now return to our comparison of two port and four port nodes. Figure 12 is similar to the earlier comparison, but here all networks use the modified queueing discipline. Here we observe the expected advantage for four port nodes. In particular, network C achieves a throughput of about 0.75 vs. 0.63 for networks A and B. This plot indicates a choice for a network designer. He may use four port nodes to reduce the total number of buffer slots in the network while maintaining the

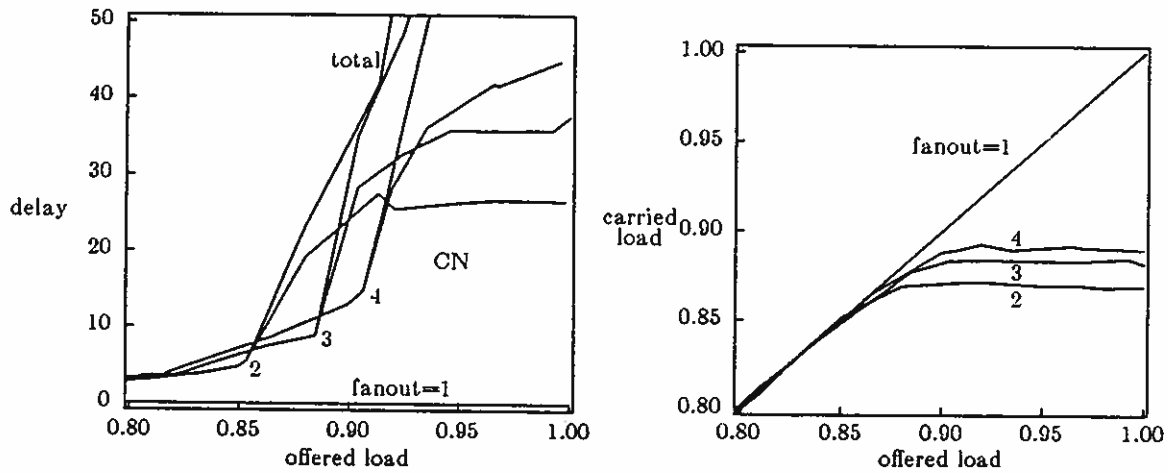

Figure 13: CN Delay and Load with Random Fanouts

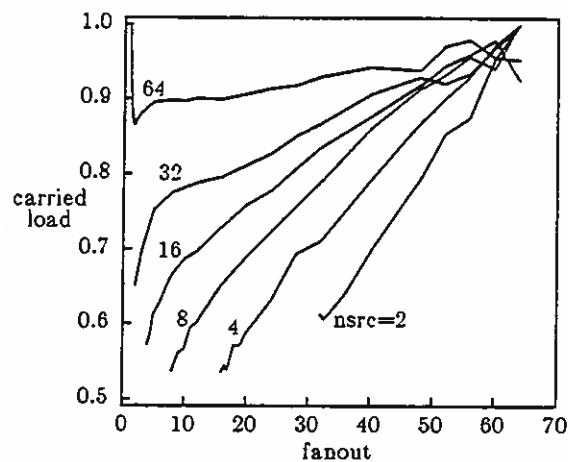

Figure 14: CN Throughput with Random Fanouts

same performance level, or he may use them to increase throughput while holding the number of buffer slots constant. Of course, this trade-off assumes the modified queueing discipline, which may be more difficult to implement than the original FIFO discipline. If the original discipline is used, the designer is better off with two port nodes.

We note that the nodes used in the networks described here perform all their buffering on the input side. Another alternative is to buffer at the outputs. In our case, buffering at the input was chosen because it appears simpler to implement. We have not compared the performance of the two alternatives.



#### 4. Performance of the Copy Network

We now examine the performance of the Copy Network (CN). Recall, that the function of the CN is to replicate packets associated with multipoint connections. To our knowledge, ours is the first performance study of networks of this type.

The results in this section are for a 64 port CN with two port nodes, each having two buffer slots per input. The CN is preceded by a set of input buffers. Nothing is connected to the output side, meaning that there is no "back-pressure" at the last stage of switching. This configuration allows us to focus on properties determined entirely by the CN. In a later section, we look at the CN performance in the context of a fully configured switch fabric.

In our first set of results, packets arrive at all inputs to the CN at the same average rate. The fanout assigned to each packet is selected from a truncated geometric distribution with parameter  $p$ . More specifically, the probability that the fanout is  $k$  is given by

$$\Pr(\text{fanout} = k) = \begin{cases} p(1-p)^{k-1} & 1 \leq k < N \\ (1-p)^{N-1} & k = N \end{cases}$$

where  $0 \leq p \leq 1$  and  $N$  is the number of ports in the network ( $N = 64$  for the results given here). The average fanout obtained with this distribution is given by

$$E(\text{fanout}) = \begin{cases} (1/p) [1 - (1-p)^N] & 0 < p \leq 1 \\ N & p = 0 \end{cases}$$

Since, each packet entering the CN may give rise to multiple output packets, the offered load for the CN is defined as the product of the input load and the average fanout. Given these definitions we can now consider the first set of simulation results shown in Figure 13. The delay plot shows CN delay and total delay for several values of average fanout. The carried load curves are also given for several values of the average fanout. When the average fanout is one, the CN carries the load with no contention and no delay. To understand this, one must realize that to achieve an average fanout of one, the fanout of *all* packets must be one. Hence, no packet replication occurs and there is no source of contention. When the average fanout becomes two the situation changes dramatically. First, the maximum carried load drops to about .865 and there is a corresponding increase in delay. This drop in performance is the expected consequence of contention caused by packet replication. The next effect one notices is that as the fanout continues to increase, the performance improves. While this may appear counter-intuitive, it can be explained by observing that for a given value of offered load, a larger fanout means a smaller packet arrival rate (since offered load is the product of input load and fanout). Thus, when the average fanout doubles from two to four, the packet arrival rate at the CN input ports is halved. This effect tends to reduce contention and counteracts the contention-increasing effect of larger fanout.

The last set of results indicates a dependence of performance on the fanout of the sources. We next consider the effect on performance of limiting the number of active CN input ports. In the next set of results, packets were generated only on input ports 0 to  $nsrc - 1$ , where  $nsrc$  is a parameter that was varied. This choice of input ports leads to maximum contention in the early stages of the network. The results are shown in Figure 14. In this plot, fanout is given on the horizontal axis and carried load on the vertical axis. The offered load in all cases is one, so this plot shows the maximum throughput provided by the network under a wide range of different conditions. The best performance is obtained when all inputs are active. In this case, the minimum throughput occurs with a fanout of about 2. When the number of sources is small, there is a lot of contention in the early stages leading to sharply lower throughputs at small fanouts. We note again that as fanouts

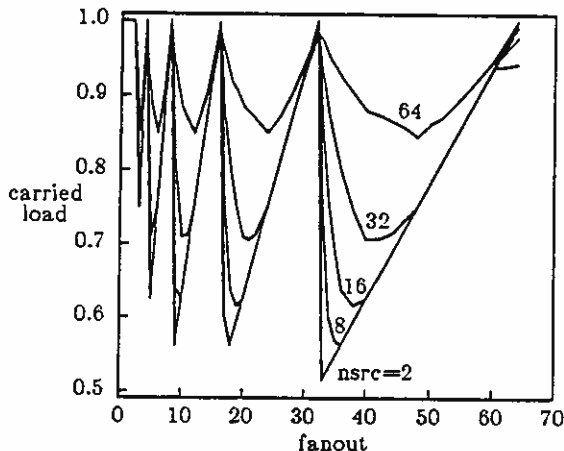

Figure 15: CN Throughput For Fixed Fanouts

increase, throughput climbs rapidly due to the lower arrival rates at the input ports which reduce contention. Note that in all cases, the throughput exceeds 0.5.

The results given above are for randomly generated fanouts. Our next set focuses more closely on the effect of different fanouts. In this set, the fanouts were fixed at a constant for each simulation run, rather than being selected at random. The results are shown in Figure 15. In this plot, offered load is again held at 1, so we see the maximum throughput obtained for various values of fanout and  $nsrc$ . The difference between this and the previous plot is striking. For each value of  $nsrc$ , the throughput takes on values close to one whenever the fanout is a power of two. Between powers of two, the throughput drops sharply achieving its minimum value when the number of sources is small. This plot shows more clearly the effect of different fanout values since in each simulation run all packets had the same fanout and consequently were replicated in the same stages of the copy network. This contrasts to the previous set where in each run there was a mixture of different fanout values. The excellent performance at fanouts equal to powers of two is an expected effect as is the sharp deterioration just above powers of two. This deterioration is explained by noting that when the fanout passes a power of two, copying begins one stage earlier in the network than previously, while the packet arrival rate is about the same. This leads to additional contention and the observed performance deterioration. As the fanout continues to increase, the arrival rate decreases (in order to maintain the same offered load), reducing contention in the early stages and improving performance.

We conclude this section with a review of a few analytical results obtained in [1] and discussed further in [19]. We view the traffic imposed on an  $N$  port Copy Network as coming from a collection of sources  $S_1, \dots, S_k$ . Each source  $S_i$  is described by an ordered triple  $(P_i, B_i, F_i)$ , where  $P_i$  is the input port at which packets from  $S_i$  arrive ( $0 \leq P_i \leq N$ ),  $B_i$  is the average arrival rate of packets from  $S_i$  ( $0 \leq B_i \leq 1$ ) and  $F_i$  is the required fanout ( $1 \leq F_i < N$ ). A *traffic configuration* (or simply configuration) is a set of sources. In a *legal configuration* the sum of arrival rates of sources associated with any particular input port must be at most 1. That is, for  $i \in [0, N - 1]$ ,

$$\sum_{j, P_j=i} B_j \leq 1$$

Also, the sum of the products of arrival rate and fanout must be no more than  $N$ .

$$\sum_{j=0}^k B_j F_j \leq N$$

Configurations that violate these restrictions exceed the capacities of either the input ports or the output ports of the CN and hence its performance under such conditions is immaterial.

We label the links in the CN with ordered pairs  $(i, j)$  where  $i$  is the stage number of the link and  $j$  is its index within the stage. Stage 0 links are those feeding the nodes in the first stage, stage 1 links connect the nodes in the first and second stages, and so forth. Links are numbered within stages from top to bottom at their left ends, starting from 0. Hence, the first link leaving the top node in the first stage is link  $(1, 0)$ .

Let  $S = (P, B, F)$  be a source. We define the average load induced by  $S$  on a link  $(i, j)$  in the Copy Network by

$$\lambda_{ij}(P, B, F) = \begin{cases} 0 & \text{if there is no path from link } (0, P) \text{ to link } (i, j) \\ 2^{-i} B & \text{if there is a path and } 0 \leq i \leq n - \lceil \log_2 F \rceil \\ 2^{-(n - \lceil \log_2 F \rceil)} B & \text{if there is a path and } i \geq n - \lceil \log_2 F \rceil \end{cases}$$

This definition simply reflects the behavior of the CN with respect to a particular source. When a packet from source  $S$  enters the CN it follows a random path until it reaches stage  $f = \lceil \log_2 F \rceil$ . Stage  $f$  is the first at which replication takes place. For a set of sources  $S$ , we define

$$\lambda_{ij}(S) = \sum_{(P, B, F) \in S} \lambda_{ij}(P, B, F)$$

The following theorems are proved in [1].

**THEOREM 1.** Let  $f$  be an integer in  $[0, \log_2 N]$  and let  $S = (S_1, \dots, S_k)$  be any legal configuration in which  $F_i = 2^f$  for  $1 \leq i \leq k$ . Then, for any link  $(i, j)$ ,  $\lambda_{ij}(S) \leq 1$ .

Theorem 1 tells us that when all the sources have fanouts equal to the same power of two, there is no legal configuration that can induce an overload on any internal link. If we drop the restriction to powers of two we get the following.

**THEOREM 2.** Let  $F$  be an integer in  $[1, N]$  and let  $S = (S_1, \dots, S_k)$  be any legal configuration in which  $F_i = F$  for  $1 \leq i \leq k$ . Then, for any link  $(i, j)$ ,  $\lambda_{ij}(S) \leq 2$ .

So, if the fanouts are all equal, the CN can handle any legal configuration in which the arrival rates on all input ports are  $\leq 0.5$  without inducing an overload on any internal link. We get a similar result ( $\lambda_{ij} \leq 2$ ) if we insist on fanouts equal to powers of two but drop the restriction that all fanouts be equal. Finally, if we drop all restrictions we obtain the following.

**THEOREM 3.** Let  $S = (S_1, \dots, S_k)$  be any legal configuration. Then, for any link  $(i, j)$ ,  $\lambda_{ij}(S) \leq 3$ .

This implies that the CN can handle any legal configuration in which the arrival rates on all input ports are  $\leq 1/3$  without inducing an overload on any internal link. In each of the above theorems, the bound on  $\lambda_{ij}$  cannot be improved. In Figure 16 we show a legal traffic configuration for a six stage CN that induces a load exceeding 2.5 on a link in the center stage. This example generalizes to larger copy networks and induces loads approaching 3 as the network size increases. Figure 17 shows the performance curves for a simulation of a six stage CN with this traffic pattern. Note that the maximum throughput for this traffic pattern is about 0.35 and as the offered load

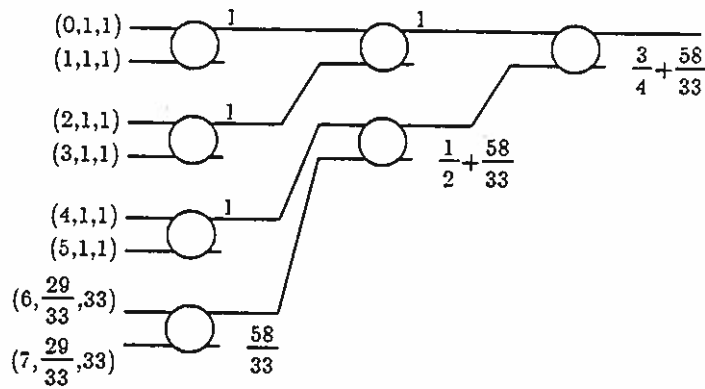

Figure 16: Pathological Traffic Pattern for CN

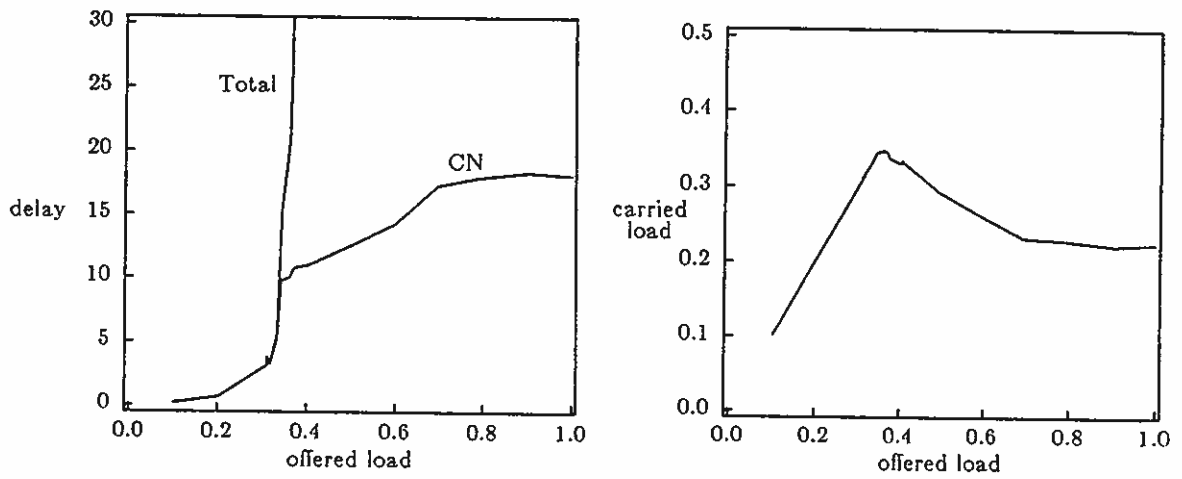

Figure 17: CN Performance for Pathological Traffic Pattern

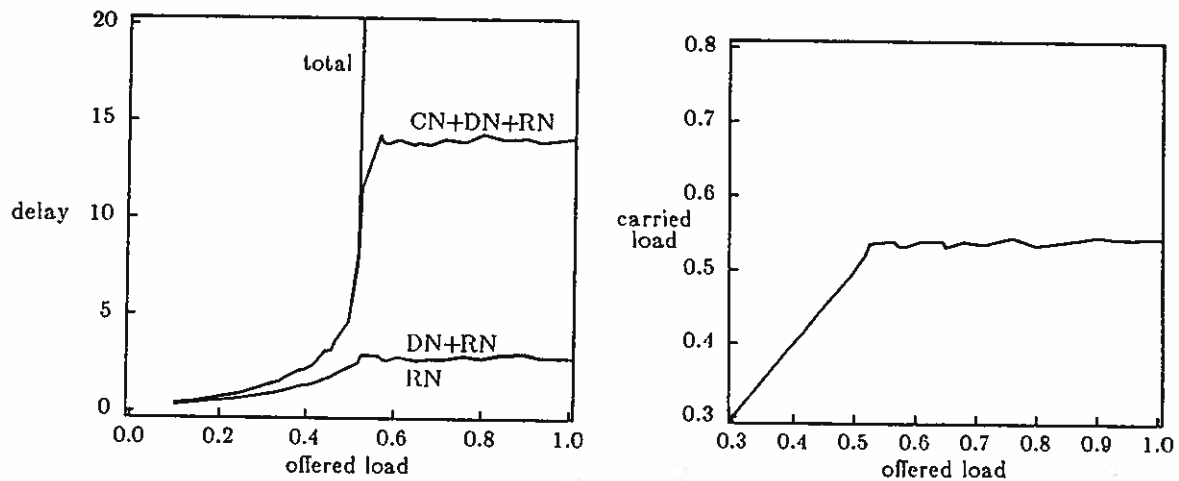

Figure 18: Performance of Recommended Configuration

continues to increase the throughput drops to about 0.22. At high offered loads multipoint packets must wait a long time in a node where they must replicate, because it's rare that both output ports become available simultaneously and if only one is available there is usually a point-to-point packet in the other node buffer that takes it. This suggests that better performance might be obtained at high loads by allowing multipoint packets to be copied serially rather than in parallel. This change would not affect Theorem 3, but could prevent the throughput from dropping at high loads. On the other hand, the implementation of nodes that operate in this way appears substantially more complicated.

## 5. Closing Remarks

The results presented above allow us to select from among several alternative designs for the system described in [16]. In our recommended configuration, we use two slot buffers at the inputs to each node; we also use cut-through switching and the modified queueing discipline. We use four port nodes in the routing and distribution networks, but two port nodes in the copy network. The performance of this configuration is given in Figure 18. This is for an input traffic pattern with eight active sources and fanouts selected from a truncated geometric distribution with a mean of eight. This traffic pattern provides a fairly demanding test of the copy network, but is not worst-case. Note that at the nominal operating point of 0.4, the delay is just over two packet times ( $50 \mu s$ ). Also note that at this load, the delay is split fairly evenly between the CN and the RN and the DN contributes very little delay. Our results give us confidence that this configuration will perform well across a wide range of operating conditions. While there exist pathological traffic patterns that can exceed the capacity of the system, they are sufficiently contrived that it appears unlikely that they would pose an actual threat to a real system.

The simulation results allow us to draw several conclusions concerning the performance implications of alternative node designs. The first is that cut-through switching offers significant performance advantages. In applications where the header is short relative to the packet length, cut-through switching is clearly the method of choice. Without cut-through, the *minimum delay* in the recommended configuration would be twelve packet times ( $300 \mu s$ ). Second, two port nodes are the best choice if queueing is performed at the input side of the switch nodes and a strict FIFO

queueing discipline is used. The modified queueing discipline improves performance significantly, especially for larger switch nodes; when the modified discipline is used, large nodes are preferred.

Our results show that the performance of the copy network is sensitive to the fanout of the incident traffic and also to input ports on which the traffic arrives. There are pathological traffic patterns that can induce a load of three on some of the copy network's internal links, but this is as bad as things can get. To make the copy network robust in the face of arbitrary traffic patterns, there are at least two approaches. The first is to operate the copy network so that the load at the input ports is no more than one third (this may require higher speed operation). The second is to place a second distribution network in front of the copy network. In this configuration, the maximum load obtainable on an internal copy network link is one.

There are many interesting questions that remain to be explored. One area for further research is to seek analytical models of the the kinds of networks studied here. An analysis of binary routing networks with cut-through switching and small buffers would be of particular interest. Another direction for additional work is the exploration of other architectural variations. In particular, our use of a separate distribution network is clearly just one of many ways to avoid congestion in binary routing networks. A second approach is described in [18] and many others are possible. A comparison of buffering strategies in the switch nodes would also be worthwhile; we have limited ourselves to buffering at the inputs, but clearly output buffering merits consideration as well.

When it comes to the copy network there remains a wealth of open problems. The most important perhaps is whether or not there exist implementations using binary nodes and  $\log_2 N$  stages for which the maximum load that can be induced on an internal link is smaller than three. There are several questions that concern packet replication strategies. (1) Is it best to divide the fanouts evenly as we have done here or to divide them unevenly? (2) Should priority be given to packets that require replication? (3) Should sequential copying be allowed at a node, rather than requiring that both copies proceed in parallel? Finally, we note that the issue of copy networks with nodes having more than two ports remains largely unexplored.

## References

- [1] R. G. Bubenik, "Performance Evaluation of a Broadcast Packet Switch," Washington University, Computer Science Department, M.S. thesis, 8/85.
- [2] D. M. Dias and J. R. Jump, "Packet Switching Interconnection Networks For Modular Systems," *Computer*, vol. 14, no. 12, 12/81, 43-53
- [3] D. M. Dias and J. R. Jump, "Analysis and Simulation of Buffered Delta Networks," *IEEE Transactions on Computers*, vol. C-30, no. 4, 4/81, 273-282
- [4] D. M. Dias and Manoj Kumar. "Packet Switching in  $N \log N$  Multistage Networks," *Proceedings of Globecom 84*, 12/84, 114-120.
- [5] Feng, Tse-yun. "A Survey of Interconnection Networks," *Computer*, vol. 14, no. 12, 12/83, 12-30.
- [6] M. A. Franklin, "VLSI Performance Comparison of Banyan and Crossbar Communications Networks," *IEEE Transactions on Computers*, vol. C-30, no. 4, 4/81, 283-290.
- [7] L.R. Goke and G. J. Lipovski, "Banyan Networks for Partitioning Multiprocessor Systems," *Proceedings of the 6th Annual Symposium on Computer Architecture*, 4/79, 182-187.

- [8] Y. C. Jenq, "Performance Analysis of a Packet Switch Based on a Single-Buffered Banyan Network," *IEEE Journal on Selected Areas in Communications*, vol. SAC-1, no. 6, 12/83, 1014-1021.
- [9] P. Kermani and L. Kleinrock. "Virtual Cut-Through: A New Computer Communication Switching Technique," *Computer Networks*, vol. 3, 1979, 267-286.
- [10] C. P. Kruskal and M. Snir. "The Performance of Multistage Interconnection Networks for Multiprocessors," *IEEE Transactions on Computers*, vol. C-32, no. 12, 12/83, 1091-1098.
- [11] J. K. Kulzer and W. A. Montgomery. "Statistical Switching Architectures for Future Services," *Proceedings of the International Switching Symposium*, 5/84.
- [12] J. H. Patel, "Performance of Processor-Memory Interconnections for Multiprocessors," *IEEE Transactions on Computers*, vol. C-30, no. 10, 10/81, 771-780.
- [13] Bjarne Stroustrup, "The C++ Programming Language," Addison-Wesley, 1986.
- [14] J. S. Turner and L. F. Wyatt, "A Packet Network Architecture for Integrated Services," *Proceedings of Globecom 83*, 11/83, 45-50.
- [15] J. S. Turner, "Fast Packet Switching System," United States Patent #4,491,945, 1/15/85.
- [16] J. S. Turner, "Design of a Broadcast Packet Switching Network," Washington University, Computer Science Department, WUCS-85-4, 3/85.
- [17] J. S. Turner, "Design of an Integrated Services Packet Network," *Proceedings of the Ninth ACM Data Communications Symposium*, 9/85, pages 124-133.
- [18] J. S. Turner and L. F. Wyatt, "Alternate Paths in a Self-Routing Packet Switching Network," United States Patent #4,550,397, 10/29/85.
- [19] J. S. Turner, "On the Performance of Packet Switched Interconnection Networks in Communications Systems," Washington University, Computer Science Department technical report, in preparation.
- [20] J. E. Wirsching, T. Kishi, "Conet: A Connection Network Model," *IEEE Transactions on Computers*, vol. C-30, 4/81.