





MBL/WHOI



0 0301 0026737 3



**PHOTOSYNTHESIS
AND RELATED PROCESSES, I**



QK 882
R14
V. 1
C 2

PHOTOSYNTHESIS

and Related Processes

By **EUGENE I. RABINOWITCH** *Research Associate, Solar Energy
Conversion Research Project, Massachusetts Institute
of Technology, Cambridge, Massachusetts.*



VOLUME I

**Chemistry of Photosynthesis,
Chemosynthesis and Related
Processes in Vitro and in Vivo**



30
INTERSCIENCE PUBLISHERS, INC.
1945 NEW YORK, N. Y.

Copyright, 1945, by
INTERSCIENCE PUBLISHERS, INC.
215 Fourth Avenue, New York 3, N. Y.

Printed in the United States of America
by the Lancaster Press, Lancaster, Pa.

PREFACE

Photosynthesis is by far the most important biochemical process on earth because it alone produces organic matter from stable inorganic materials and thus prevents life from becoming extinct. It is also the most puzzling of all biochemical reactions, and will probably remain so as long as all attempts to divorce it from the living cell prove futile. Although many physiologists, chemists, and recently also physicists, have attacked the problem, the progress toward its solution has been slow. The difficulties lie in both the physiological and the physical aspects of photosynthesis. As a physiological phenomenon, photosynthesis is distinguished by a particular sensitivity to all factors which interfere with the normal life processes in the plant. This sensitivity makes it difficult to study the mechanism of photosynthesis by breaking the cells down into their cytological or chemical constituents. From the physical point of view, photosynthesis is distinguished by an extraordinarily large consumption of energy, and the consequent necessity for a mechanism which would permit the utilization of the energy of several light quanta for the transformation of a single molecule and prevent back reactions which tend to destroy the unstable intermediate products. Nothing similar to such a mechanism has as yet been realized in photochemical experiments outside the living cell, and this makes it difficult to approach the problem of photosynthesis by the study of model systems *in vitro*.

Cooperation of plant physiologists, physicists, and physical chemists is a prerequisite for the better understanding and ultimate mastery of these two fundamental aspects of photosynthesis. It is the hope of the author that this book will enable plant physiologists to judge critically the experimental results obtained by various physical methods and will help them appreciate the usefulness of reaction kinetics and of the theory of fluorescence and sensitization in the analysis of photochemical processes in the living cell. To the physicists and the physical chemists who embark on the investigation of photosynthesis equipped mainly with the knowledge of the recent quantitative work on unicellular algae, this book may be of assistance in the understanding of the broad physiological background of photosynthesis and the realization of its intimate association with other life processes in the plant organism.

During the last twenty years, some important new avenues of approach to the study of photosynthesis have been opened. Mention may be made, for example, of oxygen liberation by isolated chloroplasts; of

the broader view of the chemistry of photosynthesis obtained by the study of bacteria; and of the discovery of the possibility of changing the chemical course of photosynthesis in certain algae by substituting new substrates for carbon dioxide and water. The use of flashing light, of heavy hydrogen, and particularly of the isotopes of carbon and oxygen, as well as quantitative study of the fluorescence of living plants during photosynthesis, has revealed many new facts about the mechanism of this process. Together with rate measurements by sensitive physical methods, these new experimental procedures have produced valuable material for comprehensive kinetic treatment. The knowledge of the structure of the photosynthetic apparatus has been advanced by the discovery of the chloroplast grana and laminae; and the application of the electron microscope promises new progress in this field. The long overdue, detailed chemical analysis of the chloroplasts has been brought under way; much progress can be hoped for by its further development, assisted by a more extensive application of the methods of enzyme chemistry. Further progress of our knowledge of the role of pigments in photosynthesis can be expected from the study of the relationship between their structure and photochemical behavior *in vitro*. An important development may have been initiated by the reconsideration of the function in photosynthesis of the "accessory" pigments—the carotenoids and phycobilins.

Photosynthesis was last treated in 1926 in the well-known monograph by Spoehr. Since this book, as well as a similar but shorter one by Stiles (1925), contains an extensive presentation of the older literature, no need was felt for a repetition of such a complete review of the early work. Only those of the older investigations which have proved of historical importance or enduring influence are discussed in detail in the present book—and there are more of them than is often thought. The pioneering investigations of Priestley, Ingen-Housz, de Saussure, Sachs, Timiriazev, Reinke, or Engelmann, not omitting the classical work of Willstätter and Stoll, still deserve the study of all who are interested in photosynthesis. The papers which have appeared since 1925 have been considered in greater detail, some probably receiving more consideration than may prove warranted by their lasting importance. No attempt has been made to cover fully the studies of photosynthesis in relation to systematic botany or ecology, or to discuss the organic chemistry of plant pigments beyond its relationship to the mechanism of photosynthesis.

The present treatise differs from previous books on the subject by an increased emphasis on physical and physicochemical methods and theories—a consequence of the newer trends in the study of photosynthesis as well as of the inclinations and background of the author. However, an impartial reporting of the work of botanists and plant physiologists has

been attempted, although the very nature of this work often makes a concise statement of the results difficult if not impossible.

The original plan envisaged the division of the book into three parts: the chemical mechanism of photosynthesis and chemosynthesis; the properties of photosynthetic pigments; and the kinetics of photosynthesis. Publication of the treatise in two volumes, made necessary partly by its bulk and partly by exigencies of war work which caused an interruption of uncertain duration in the preparation of the manuscript, led to a subdivision of the second part. The work is thus now divided into four parts: I, The Chemistry of Photosynthesis and Related Processes; II, The Structure and Chemistry of the Photosynthetic Apparatus; III, The Spectroscopy and Fluorescence of the Pigments; and IV, The Kinetics of Photosynthesis. The first two parts form the present Volume I, which contains predominantly chemical matter. Parts III and IV will be included in the second, predominantly physical, volume. Most of the second volume is now ready in draft form, and it is hoped that its publication will be possible within a year. Thanks are due to Interscience Publishers, Inc., for the patience with which they have borne the expansion of the manuscript beyond its originally intended scope and the delays ensuing from this growth.

* * *

My interest in photosynthesis originated in the work on the photochemical properties of chlorophyll, carried out in 1937-1938 at University College, in London. In the summer of 1938, during a stay at the Marine Biological Laboratory at Woods Hole, with its unique library, where practically every biological, chemical or physical periodical in the world is available twenty-four hours a day, I first started collecting material on photosynthesis and related subjects. My intention was to see whether this heterogeneous material could be fitted into a unified picture to serve as an incentive and guide for further experiments, but the work soon expanded beyond this original aim. Most of the manuscript was written at Woods Hole during that and three subsequent summers. My work at the Solar Energy Research Project of the Massachusetts Institute of Technology, while not concerned directly with photosynthesis, helped to keep alive an interest in the subject, since, in experimenting on the conversion of light energy into chemical energy, one cannot but turn continuously to plants and wonder how Nature has achieved a result which has not yet been approached in the laboratory. This work could not have been completed without the understanding help of the Solar Energy Project Committee, which not only made possible use of part of my time for the completion of the manuscript, but also provided a grant toward the expenses of its technical preparation.

Special gratitude is expressed to Dr. Selig Hecht, who encouraged the work at its start, and to Dr. Hans Gaffron, who has read and criticized it in its final form. My teacher and friend, Dr. James Franck, has spent many hours in patiently discussing with me the kinetics of photosynthesis—a subject treated in the second volume. I am indebted to my coworkers on the Solar Energy Project, Dr. Leo F. Epstein (now Captain in the U. S. Army Air Force) and Mr. Ely Burstein, for having read and corrected the manuscript in its consecutive versions. My thanks are also due to several friends and colleagues for reading and criticizing single chapters or sections of the book—to Dr. R. Emerson at the California Institute of Technology, Drs. G. Scatchard, L. Heidt, and W. Stockmayer at the Massachusetts Institute of Technology, G. Wald at Harvard University, and W. J. V. Osterhout and S. Granick at the Rockefeller Institute for Medical Research. During the years in which this book grew, and particularly on the occasion of two symposia on photosynthesis, sponsored by the American Association for the Advancement of Science at Columbus in 1939 and at Gibson Island in 1941, I had an opportunity to discuss the subject with many investigators involved in its advance in recent years. They cannot all be enumerated here, but all have contributed to this book in some measure.

EUGENE I. RABINOWITCH

Chicago
April 1945

CONTENTS

	PAGE
Preface	v
Contents	ix

INTRODUCTION

Chap. 1. Photosynthesis and Its Role in Nature	1
A. Organic Matter and Life Energy	1
B. The Total Yield of Photosynthesis on Earth	5
Bibliography	11
Chap. 2. The Discovery of Photosynthesis	12
1. Precursor: Stephen Hales	12
2. The Background: The Birth of Pneumochemistry	12
3. The Purification of Air by Plants: Priestley	13
4. The Importance of Sunlight: Ingen-Housz	17
5. The Part of Carbon Dioxide: Senebier	19
6. The Assimilation of Carbon	22
7. The Participation of Water: de Saussure	23
8. The Conversion of Light Energy: Robert Mayer	24
Bibliography	27

PART ONE—THE CHEMISTRY OF PHOTOSYNTHESIS AND RELATED PROCESSES

Chap. 3. The Over-All Reaction and the Products of Photosynthesis	31
A. The Quantitative Balance of Photosynthesis	31
1. The Photosynthetic Quotient	31
2. The Yield of Organic Matter	35
B. The Products of Photosynthesis	38
1. The Carbohydrates	38
2. The Photosynthetic Formation of Oils and Proteins	43
3. The First Products of Photosynthesis and Their Transformations	44
C. The Energy of Photosynthesis	47
D. Photosynthesis as a Sensitized Oxidation-Reduction	51
Bibliography	56
Chap. 4. Photosynthesis and Related Processes Outside the Living Cell	61
A. Photosynthesis by Dried Leaves, Isolated Chloroplasts and Chlorophyll Preparations	61
1. Leaf Powders and Isolated Chloroplasts	61
2. Experiments with Chlorophyll Preparations	67
B. The Photochemical Oxidation of Water	69
1. Decomposition of Water in Ultraviolet Light	71
2. Mercury-Sensitized Decomposition of Water	71

	PAGE
<i>Chapter 4, contd.</i>	
3. Sensitization of Water Decomposition by Solids (ZnO and AgCl)	72
4. Photoxidation of Water by Cations	74
5. Photoxidation of Water by Dyestuffs	76
C. The Chemical and Photochemical Reduction of Carbon Dioxide	78
1. Chemical Reduction of Carbon Dioxide	79
2. Decomposition and Reduction of Carbon Dioxide in Ultraviolet Light	81
3. Sensitized Reduction of Carbon Dioxide	84
Bibliography	94
Chap. 5. Photosynthesis and Chemosynthesis of Bacteria	99
A. Bacterial Photosynthesis	99
1. Types of Autotrophic Bacteria	99
2. The Over-All Photosynthetic Reactions of Autotrophic Bacteria	102
3. Combined Photosynthesis and Heterotrophic Assimilation of Photoheterotrophic Bacteria	106
B. Bacterial Chemosynthesis	111
1. Types of Chemautotrophic Bacteria	112
2. Efficiency of Chemautotrophic Bacteria	118
3. Methane-Producing Bacteria and other Cases of Carbon Dioxide Absorption by Heterotrophants	120
C. The Role of Autotrophic Bacteria in Nature	123
Bibliography	125
Chap. 6. The Metabolism of Anaerobically Adapted Algae	128
1. The Adaptation of Algae to Hydrogen and Hydrogen Sulfide	128
2. The Mechanism of Hydrogen Adaptation and De-adaptation	129
3. The Dark Reactions of Adapted Algae	136
4. The Photochemical Reactions of Adapted Algae	142
Bibliography	148
Chap. 7. The Primary Photochemical Process	150
1. The Problem of the Primary Process	150
2. Oxidation of Water as the Primary Process. First Four Quanta Theory	155
3. Reduction of Carbon Dioxide as the Primary Process. Second Four Quanta Theory	157
4. Hydrogen Exchange Between Intermediates as the Primary Process. Third Four Quanta Theory	159
5. Two Different Primary Four Quanta Processes. First Eight Quanta Theory	160
6. Dismutation of Energy as an Alternative to a Second Primary Process. Second Eight Quanta Theory	164
7. Comparison of Different Primary Processes	166
8. The Primary Process in Bacteria and Adapted Algae	168
Bibliography	170
Chap. 8. The Nonphotochemical Reactions in Photosynthesis. I. Fixation of Carbon Dioxide	172
A. The Carbon Dioxide Fixation <i>in vitro</i>	173
1. The Carbon Dioxide-Water Equilibrium	173
2. Carbon Dioxide Absorption by Alcohols	179

	PAGE
<i>Chapter 8, contd.</i>	
3. Carbon Dioxide Absorption by Amines	181
4. Carboxylation Equilibria	183
5. Is Carboxylation a Reduction of Carbon Dioxide?	187
B. Carbon Dioxide Fixation by Living Cells	188
1. Solubility of Carbon Dioxide in Plant Sap	189
2. Conversion of Carbon Dioxide into Bicarbonate in Plants	189
3. Role of Bicarbonate Ions in Photosynthesis	195
4. Carboxylation and the {CO ₂ } Complex	200
5. Carbon Dioxide Fixation by Heterotrophants	208
Bibliography	209
Chap. 9. The Nonphotochemical Reactions in Photosynthesis. II. Reduction of Carbon Dioxide	213
1. The Standard Bond Energies	213
2. Reduction Level and Energies of Combustion, Dismutation, and Hydration	214
3. Energies of Hydrogenation and Oxidation-Reduction Potentials	217
4. Formation of Carboxyl Groups in Respiration. The Role of Phosphorylation	222
5. Phosphorylation and Photosynthesis	226
6. The Thermodynamics of Free Radicals	229
7. Free Radicals in Photosynthesis and Chemosynthesis	233
8. Metal Complexes as Reduction Intermediates	239
9. Transformations of the First Reduction Product of Carbon Dioxide	240
10. Experimental Evidence Regarding the Mechanism of Reduction of Carbon Dioxide	241
Bibliography	244
Chap. 10. Intermediates in the Reduction of Carbon Dioxide	246
A. The Problem of Intermediates in Photosynthesis; The Hypotheses of Liebig and Baeyer	246
B. Low Molecular Weight Compounds in Green Plants	248
1. Review of Analytical Data	248
2. The Volatile Components of Green Leaves	252
C. The Formaldehyde Problem	255
1. The Search for Formaldehyde in Leaves	255
2. Formaldehyde Feeding Experiments	257
3. Feeding of Plants with other Low Molecular Weight Compounds	260
D. The Problem of Plant Acids	262
1. Occurrence of Plant Acids in Leaves	262
2. Acidification of Succulents	264
3. Plant Acids in Nonsucculents	267
E. Ascorbic Acid in Green Plants	269
1. Ascorbic Acid in the Chloroplasts	269
2. Ascorbic Acid—An Intermediate or Catalyst?	271
Bibliography	273
Chap. 11. The Nonphotochemical Reactions in Photosynthesis. III. Liberation of Oxygen	281
1. The Peroxide Problem	281
2. The Hydrogen Peroxide Hypothesis	282

	PAGE
<i>Chapter 11, contd.</i>	
3. The Organic Peroxide Hypothesis	286
4. The Oxidase Hypothesis	293
5. Experiments with Heavy Water	295
Bibliography	298
Chap. 12. Inhibition and Stimulation of Photosynthesis. I. Catalyst Poisons and Narcotics	300
A. Catalyst Poisons	301
1. Cyanide Inhibition of Photosynthesis	301
2. Effect of Cyanide on Hydrogen-Adapted Algae	310
3. Hydroxylamine	311
4. Hydrogen Sulfide and Other Inorganic Poisons	315
5. Iodoacetyl and Other Organic Poisons	318
B. Narcotics	320
Bibliography	324
Chap. 13. Inhibition and Stimulation of Photosynthesis. II. Various Chemical and Physical Agents	326
A. Influence of Oxygen on Photosynthesis	326
B. Effect of Excess Carbon Dioxide	330
C. Effect of Carbohydrates on Photosynthesis	331
D. Influence of Dehydration on Photosynthesis	333
E. Inorganic Elements and Ions	335
1. Ionic Deficiency Effects	336
2. Ionic Inhibition Effects	339
F. Miscellaneous Chemical Stimulants	342
G. Physical Stimulants and Inhibitors	344
1. Ultraviolet Light	344
2. Electric Fields and Currents	346
3. Radioactive Rays	346
Bibliography	347
PART TWO—THE STRUCTURE AND CHEMISTRY OF THE PHOTOSYNTHETIC APPARATUS	
Chap. 14. The Chloroplasts and Chromoplasts	355
A. Structure of the Chloroplasts	355
1. Number, Size, and Shape	355
2. The Grana	358
3. The Lamina	362
4. The Birefringence of Chloroplasts	365
B. Composition of the Chloroplasts	368
1. Separation and Total Quantity of Chloroplastic Matter	368
2. Proteins and Lipoids in the Cytoplasm and the Chloroplasts	371
3. The Chloroplast Ash	376
4. The Chloroplast Enzymes	379
C. Pigments in the Chloroplasts	382
1. Association of Pigments with Proteins and Lipoids in the Cell	382
2. Pigment-Protein Suspensions and Solutions	384
3. The Chlorophyll-Protein Ratio	389
4. Role of Lipides in Chloroplasts; the Model of Hubert	391
Bibliography	394

	PAGE
Chap. 15. The Pigment System	399
A. General Composition	399
B. The Chlorophylls	402
1. Chlorophylls <i>a</i> and <i>b</i> and their Ratio	402
2. Protochlorophyll	404
3. The Chlorophylls of the Algae	405
4. Bacteriochlorophyll and Bacterioviridin	407
5. Concentration of Chlorophyll in Leaves	407
6. Chlorophyll Content of Algae	408
7. Chlorophyll Concentration in Single Cells and Chloroplasts	411
C. The Carotenoids	412
D. The Phycobilins	417
E. Influence of External Factors	419
1. The Adaptation Phenomena	419
2. Phylogenetic Adaptation of the Pigment System	420
3. Ontogenetic Adaptation of the Pigment System	424
4. Influence of Different Factors on Pigment Formation	427
Bibliography	432
Chap. 16. Chlorophyll	438
A. Molecular Structure	438
1. Historical Remarks	438
2. Structural Formula	439
3. Bacteriochlorophyll and Protochlorophyll	444
4. Porphins, Chlorins, Phorbins, Phytins, and Phyllins	445
5. Shape and Size of the Chlorophyll Molecule	448
B. Chemical Properties	450
1. Chlorophyll and Water	450
2. Chlorophyll and Carbon Dioxide	451
3. Oxidation and Reduction of Chlorophyll	456
4. Elimination of Magnesium and Phytol	467
Bibliography	467
Chap. 17. The Accessory Pigments	470
A. The Carotenoids	470
1. Chemical Structure	470
2. Oxidation and Reduction	473
3. Carotenoids, Lipides, and Proteins	475
B. The Phycobilins	476
C. Flavones and Anthocyanins	479
Bibliography	480
Chap. 18. Photochemistry of Pigments <i>in vitro</i>	483
A. The Primary Photochemical Process	483
1. Long-Lived Activated States	484
2. Reversible Photochemical Reactions	486
B. The Irreversible Photochemical Transformations of Chlorophyll	494
1. Bleaching of Chlorophyll	494
2. Photooxidation as the Cause of Bleaching	498
3. Effect of Solvents and Protective Substances on Bleaching	501

	PAGE
<i>Chapter 18, contd.</i>	
4. Photochemical Oxidation-Reduction Reactions of Chlorophyll <i>in vitro</i>	503
5. Photoreduction of Chlorophyll	505
C. Chlorophyll as a Sensitizer <i>in vitro</i>	507
1. Examples of Sensitization by Chlorophyll	507
2. Different Mechanisms of Sensitization	514
3. Sensitization by Kinetic Encounters (Type-A Mechanisms)	514
4. Sensitization within a Complex (Type-B Mechanisms)	520
D. Photochemical Properties of the Carotenoids and Phycobilins	521
Bibliography	523
Chap. 19. Photochemistry of Pigments <i>in vivo</i>	526
A. Photooxidations <i>in vivo</i>	526
1. Photosynthesis, Photooxidation, and Photorespiration	526
2. Photooxidation in Narcotized or Starved Plants	528
3. Photooxidation in the Presence of Excess Oxygen and in Intense Light	531
4. The Photooxidation of Chlorophyll <i>in vivo</i>	537
B. Sensitized Oxidation-Reductions <i>in vivo</i>	538
1. Chlorophyll-Sensitized Reduction of Nitrate	538
2. Reduction of Other Inorganic Oxidants	541
3. Reduction of Organic Oxidants	541
C. Mechanism of Sensitization <i>in vivo</i>	543
1. Hypothesis of a Common Primary Process in All Chlorophyll-Sensitized Reactions <i>in vivo</i>	543
2. Association of Chlorophyll with the Sensitization Substrates; Fluorescence and Sensitization Yields <i>in vitro</i> and <i>in vivo</i>	544
3. Problem of the Chemical Participation of Chlorophyll in the Primary Process	548
4. Role of Accessory Pigments in Photosynthesis	557
Bibliography	558
Chap. 20. Photosynthesis and Respiration	561
1. Effect of Respiration on Photosynthesis	562
2. Effect of Photosynthesis (and Photooxidation) on Respiration	563
3. Effect of Light on Respiration	566
Bibliography	570
Author Index of the Main Investigations in Vol. I	573
Subject Index	583

INTRODUCTION



CHAPTER I

PHOTOSYNTHESIS AND ITS ROLE IN NATURE

A. ORGANIC MATTER AND LIFE ENERGY

The chemical reactions which constitute the material aspect of life all take place on a precariously high level of potential chemical energy. Like aerobats performing their complicated exercises high above the circus crowd, the molecules of proteins, carbohydrates, fats, vitamins, enzymes, and other constituents of the living organisms combine, exchange, or dissociate in the midst of an ocean of oxygen which continuously threatens them with breakdown and extinction. Oxygen atoms, reluctantly united in diatomic molecules, are ever ready to break away from each other and to seek stability in the union with carbon, hydrogen, phosphorus, iron or the other elements contained in organic matter. The inorganic world has long since succumbed to a similar attack—so completely that now an average atom in the earth's crust is held in the grip of two atoms of oxygen. Living matter, however, has escaped the same fate by its remarkable capacity for regeneration. Every day, almost a billion tons of organic compounds are destroyed by oxidation, finally to pass into the air as carbon dioxide, or to return as water to the universal moisture which surrounds and permeates all living things on the earth. At this rate of destruction, all organic matter now present on this globe, will be consumed in the next ten or twenty years; but during the same period, an equal quantity of organic matter will be created, *i. e.*, oxygen will be expelled from its stable union with carbon and hydrogen, and the liberated atoms knitted together into the intricate patterns which spell the secrets of organic growth, propagation, heredity, sensitivity, and mobility—all the properties which distinguish living organisms from inanimate objects of the mineral world.

Oxidation is, however, not merely a calamity, permanently threatening all living matter; it is also the prime mover of life. Life thrives on death, not only because the *material* for organic synthesis comes from the decay of living matter (if oxidation should cease, there would be no need for this synthesis), but also, because oxidation is the main source of the *energy* of life. Every movement of the animal body, every chemical activity of the digestive system, every flash of thought in the brain, consumes energy, and the main source of this energy is respiration, *i. e.*,

slow combustion of sugars or other organic compounds. A certain part of the chemical energy contained in organic matter, is thus utilized for the maintenance and manifestation of life, while the larger residue is lost in the decay of dead bodies, fallen leaves, and excretions. Sooner or later, all living matter reverts into carbon dioxide, water and nitrogen, and all the energy which it once contained becomes converted into heat. Only a small fraction of organic matter and of its energy escapes rapid dissipation, and is preserved for millions of years, in the half-decomposed forms of coal, peat or mineral oil, under a protective layer of silt and rock.

The continuous renewal of life on earth requires that its chemical elements, scattered by the decomposition of organic matter, be brought back into combination; and that the energy which was converted into heat be replaced. The regeneration of organic *matter* can occur by a cyclic process—the same carbon dioxide, water and nitrogen which were liberated by organic decay, can be used again for synthesis. The liberated *energy*, however, is lost beyond recovery. Living organisms, no less than inanimate nature, are subject to the laws of thermodynamics. These laws decree that once the energy liberated by oxidation has been dissipated in the vastness of the atmosphere and hydrosphere, it has become practically unavailable for the reverse conversion into chemical energy. Thus, the energy required for organic synthesis must come from an external source—and the only external energy which continuously reaches the surface of the earth is sunlight. No thermodynamic restrictions stand in the way of a complete conversion of light into chemical, electric or mechanical energy; but it requires a mechanism able to intervene immediately after the light strikes the absorbing surface, and to prevent the energy of this impact from being converted into heat. Man has not yet solved this engineering problem; but he would not be here if other organisms had not solved it for him long ago. These organisms are the green plants. (Green, as used here, means *chlorophyll bearing* plants, even though the green color of chlorophyll may sometimes be masked by yellow or red pigments.) The process by which these plants synthesize organic compounds from carbon dioxide and water, with the help of sunlight, is, beyond doubt, the most fundamental of all biochemical reactions.

Chemically speaking, the green plants are the only productive section of the earth's population; they are "self-supporting" ("autotrophic," to use the technical term), and they alone enable animals and "heterotrophic" plants (fungi, most bacteria) to subsist. They accumulate chemical energy, while other organisms dissipate it.

Of course, organic synthesis of one kind or another is carried out by *all* organisms; but the green plants alone start from scratch. All other plants and animals use pre-synthesized materials, which they transform

in thousands of ways. Some of these transformations lead to compounds whose energy is higher than that of the carbohydrates supplied by the plants—for example, when our bodies convert sugars into fats, unfortunately for some of us. However, this accumulation of chemical energy can be achieved only at the cost of degradation of another quantity of a vegetable substrate. For example, in the alcoholic fermentation of starch, one part of this carbohydrate is “promoted” to energy-rich alcohol, while another part is “degraded” to carbon dioxide.

Differences in energy content of organic compounds are small compared with the gap which separates the organic world from the stable inorganic compounds. In the reduction of carbon dioxide to carbohydrates, the energy content increases by about 112 kcal per gram atom of carbon. In the transformation of carbohydrates into fats, which are richer in energy than all other common constituents of animal bodies, the additional gain in chemical energy is only 30 kcal per gram atom of carbon.

To comply with the precepts of thermodynamics, we should have spoken above, not of the *total* energy (or “heat content”) of organic matter, but of its *free* energy, because free energy (or “working capacity”) is what organisms need to give them a lease of life. Nature favors disorder—it means greater variety, and therefore greater probability, that is, higher entropy. Photosynthesis not only converts a state of lower energy into a state of higher energy; it also converts a more disorderly and therefore more probable state, in which the small molecules of carbon dioxide and water are allowed to tumble freely in the rarified gas or liquid, into a denser, more orderly, and therefore less probable state of large organic molecules. In other words, it leads to a decrease in entropy; and since the change in free energy (ΔF), is equal to the change in total energy (ΔH) less a term proportional to the increase in entropy, ($T\Delta S$), the free energy of photosynthesis is even larger than its total energy. (For quantitative data, see Table 3.V, page 49.)

Chemical reactions which are associated with an increase in *total energy* ($\Delta H > 0$) are called *endothermal* (because they consume heat, if carried out at a constant temperature). For reactions which occur with an increase in *free energy* ($\Delta F > 0$), the term *endergonic* has been suggested. The total energy (or “heat effect”) is a characteristic constant of a chemical reaction (at a given temperature); while the free energy depends on the concentrations of the reaction components and reaction products. Photosynthesis is a strongly endothermal, and (with the usual concentrations of carbon dioxide and oxygen), an even more strongly endergonic process.

Certain bacteria can live autotrophically, without carrying out true photosynthesis. Some of them synthesize organic matter, in the dark, with the help of the free energy of unstable organic or inorganic chemical

systems; these are called "chemo-autotrophic" bacteria. Others, so-called purple bacteria, use light for the synthesis of organic matter from carbon dioxide and organic or inorganic hydrogen donors, for example, hydrogen sulfide or fatty acids. In this variation of photosynthesis (called "photoreduction" by Gaffron, *cf.* page 129), light energy is utilized mainly for temporary *activation* and not for permanent *conversion* into chemical energy. The energy of the organic matter produced by purple bacteria is only to a small part converted light energy; most, if not all of it is chemical energy transferred from one unstable chemical system to another. The existence of these bacteria is possible only because the crust of the earth has not yet settled into a complete chemical equilibrium, and spots of high chemical potential can still be found here and there (particularly in volcanic regions). Conceivably, these peculiar modes of autotrophic life (we will speak more of them in Chapter 5) may have played a greater role in earlier geological ages, when the chemical activity on the surface of the earth was more widespread and violent. They are consequently of considerable interest in speculations as to the origin and development of life on this planet. In the contemporary cycle of the living matter on earth, these processes are of no consequence. Photosynthesis by green plants alone prevents the rapid disappearance of all life from the face of the earth.

We cannot definitely assert that photosynthesis takes exactly the same course and leads to the same primary product in all organisms from the lowly diatoms to the highly organized flowering plants. Differences in structure and composition of the photosynthetic organs of different species (described in Chapters 14 and 15) make minor variations in the mechanism of photosynthesis probable. However, the universal occurrence of chlorophyll in *all* photosynthesizing plants and the similarities between the kinetic relationships governing photosynthesis in unicellular algae (*e. g.*, *Chlorella*), and in higher land plants (*e. g.*, wheat) (*cf.* Vol. II, Chapters 27 and 28) indicate that the general characteristics of the process must be the same throughout the plant world.

After the completion of photosynthesis, the plants and animals begin to aminate, halogenate, polymerize, oxidize, reduce or dismute the first products of photosynthesis, thus producing fats, proteins, nucleoproteids, pigments, enzymes, vitamins, cellulose and other structural materials. In due time, before or after the death of the organism, all these compounds will be oxidized and decomposed. This decomposition goes by many different paths. Only one of them, the oxidation of sugars by the respiratory system, appears as a direct reversal of photosynthesis; and even in this case, it is doubtful whether the analogy extends beyond the over-all result (*cf.* Chapter 9, section 4). The reservoir of life is fed by a single channel, through which matter is pumped up from the low-lying

sea of the stable inorganic world, to the high plateau of organic life; it finds its way back in hundreds of streams or meandering rivulets, which set into rotation, as they hurry down towards the sea, thousands of little wheels of life.

B. THE TOTAL YIELD OF PHOTOSYNTHESIS ON EARTH *

To acquire an adequate notion of the importance of photosynthesis in the chemical household of the earth, it is interesting to estimate the total turnover of matter and energy involved in this process. This can be done, of course, only very approximately.

The total yield of photosynthesis on earth was first evaluated by Liebig in his famous book, *Chemistry in its Application to Agriculture and Physiology*, whose first edition appeared in 1840. He estimated that, if all the land were a single meadow with a yearly crop of 5 metric tons (1 ton = 10^6 g.) per hectare (10^4 sq. meters), all carbonic acid in the air would be used up in from 21 to 22 years. Considering the carbon dioxide content of the air (*cf.* Table I.IV), this statement is equivalent to the assertion that the plants utilize 10^{11} tons of carbon dioxide and produce 3×10^{10} tons of organic carbon annually. Arrhenius (1908) and Ciamician (1913) made similar calculations, but assumed an average crop of only 2.5 tons per hectare of land. (They gave Liebig's authority for this figure; but according to Schroeder 1919, this was a misquotation). They thus obtained a yearly yield of only 1.8×10^{10} tons of organic carbon.

Ebermayer (1885) substituted a more elaborate picture for Liebig's simplified assumption of "all land a single meadow." He distinguished between wooded areas, cultivated fields, steppes and barren lands, and added to the crop the roots and stubbles remaining in the fields. In this way, he arrived at a figure of 2.4×10^{10} tons of organic carbon for the annual production of organic matter by the plants.

The next attempt, on the basis of improved statistical data, was made by Schroeder (1919); the results are condensed in table I.I. Schroeder's total of 1.63×10^{10} tons of carbon for the whole surface of the land, corresponds to an average of 1.1 tons per hectare. Assuming that 15% of the organic matter synthesized by the plants is used up by their own respiration, this total can be revised upward to 1.9×10^{10} tons of carbon per annum.

In this estimate, the production of organic matter in the oceans was altogether neglected. Schroeder made an estimate for the benthos, *i. e.*, the ground-attached algal vegetation of the continental ledge, and found its contribution negligible compared to that of the land plants. As to the free-swimming plankton, he saw no way of estimating its yield but

* Bibliography, page 11.

TABLE I.I
CARBON FIXATION BY LAND PLANTS (AFTER SCHROEDER 1919)

Plant habitat	Area, millions of sq. km.	Rate of carbon fixation, millions of tons per annum		
		Estimated		Probable mean value
		from	to	
Woods	44	9000	13000	11000
Farmland	27	3500	4500	4000
Steppes	31	500	2200	1100
Deserts	47	100	500	200
TOTAL:	149	13100	20200	16300

suspected that it too, is relatively small. Later (1919²), he conceded that the carbon fixation by the plankton may as much as double the yield calculated for the land plants alone, thus bringing the annual rate of carbon fixation by all plants to 3.8×10^{10} tons.

It seems that Schroeder's plankton correction still was much too small. Recent experiments make it probable that the oceans account for much more than one-half the total organic synthesis on earth. Table I.II,

TABLE I.II
CARBON DIOXIDE REDUCTION BY THE PLANKTON (FROM RILEY)

Location	Carbon per annum per sq. m., g.	Method	Reference
Long Island Sound	600-1000	Gross production and oxygen liber- ation in experi- mental bottles [O ₂] deficit Changes in [CO ₂], [O ₂], [P] and [N].	Riley (1938, 1939, 1941)
W. Atlantic 23°-38° N.	530		
W. Atlantic 38°-41° N.	320		
Dry Tortugas	60-430		
W. Atlantic 3°-13° N.	278		
English Channel	60-98	Cooper (1933)	
Barents Sea	170-330	Consumption of phosphorus	Kreps and Verbinskaya (1932)
AVERAGE:	375		

compiled by Riley (1941) shows that the production of organic matter by the plankton does not change much from the Equator to the Polar Circle; and that the average of all measurements is as high as 375 g. of organic carbon annually per sq. meter, corresponding to 3.75 tons per hectare. If this yield of organic carbon is taken as representative of all oceans,

multiplied by their area (361×10^6 sq. km.) and corrected for 15% respiration losses, the result is 15.5×10^{10} tons, or eight times the yield of carbon fixation on land as calculated by Schroeder! Even a deduction of 10 or 20% for the Polar Sea, and generally less fertile waters, would not change this result significantly. Thus, the most probable value of the rate of carbon fixation on earth is $15-20 \times 10^{10}$ tons annually, with at least four-fifths (and perhaps nine-tenths) of this amount contributed by the oceans.

TABLE 1.III
CARBON FIXATION BY LAND AND SEA PLANTS

Plant habitat	Area, millions of sq. km.	Average carbon fixation per hectare per year, tons	Total carbon fixation per year, tons
Oceans	361	3.75	15.5×10^{10}
Land	149	1.3	1.9×10^{10}

It is interesting to compare this rate of carbon transformation by the plants with the total quantity of carbon available on earth. Table 1.IV

TABLE 1.IV
CARBON RESERVES OF THE EARTH

Region of earth or atmosphere	Total amount of carbon, tons
Lithosphere (earth's crust 16 km. deep)	$2-8 \times 10^{16}$
Hydrosphere (oceans and seas)	5×10^{13}
Troposphere (air up to 11 km. height)	6×10^{11}

lists some geochemical data (*cf.*, for example, Vernadsky 1930). The large amount of carbon in the carbonate rocks is almost unavailable to the plants. The large reservoir of dissolved carbonates and bicarbonates, on the other hand, is fully available to aquatic plants, and stands in a continuous exchange with the gaseous carbon dioxide in the atmosphere, thus helping to maintain the concentration of the latter on a constant level, and contributing indirectly to the food supply of land plants. According to the figures given in Table 1.III, the land plants assimilate a quantity of carbon equivalent to the total amount of carbon dioxide in the air above the continents, in less than ten years. An approximate confirmation of this estimate was provided by Gut (1938), who measured the carbon dioxide concentration of the air at different heights above a pine forest and calculated that each day the trees consume all carbon dioxide from an air column 50 meters high. Since the atmosphere corre-

sponds to an air layer approximately 8×10^3 meters thick (under standard conditions), Gut's calculations indicate a yearly consumption of about 22% of all carbon dioxide in the air column above the forest.

However, the rapid exchange of carbon dioxide between atmosphere and hydrosphere makes the separate comparison of the carbon utilization by land plants with the amount of atmospheric carbon dioxide, and of the carbon utilization by sea plants with the quantity of dissolved carbonates irrelevant. Instead, we have to compare the total carbon fixation by *all* plants, on land and in the sea, with the total carbon reserve available in both the troposphere and the hydrosphere. The plants assimilate a quantity of carbon equal to this reserve in 300 or 400 years. To maintain the cycle, an equivalent quantity of carbon dioxide must be liberated during the same period by respiration, and by the decay of vegetable and animal matter.

Vernadsky (1930) estimated the weight of the "biosphere" on earth as 10^{13} tons, and postulated its renewal "several times a year." In other words, he assumed that an average carbon atom remains in organic combination for only a few months. These assumptions call for a rate of photosynthesis of the order of at least 10^{13} and more probably 10^{14} tons of organic carbon per year (*i. e.*, from 60 to 600 times more than was allowed above) and for the consumption, each year, of the whole amount of carbon available in the air and in the water of the oceans. In another place, Vernadsky speaks of the living organisms transforming in a single year "more than the total quantity of carbon on the earth." Even if he means only the carbon content of the air and water, this estimate appears much too high, if compared with the better supported figures of Liebig, Schroeder, and Riley. To make his figures plausible, Vernadsky criticizes the values of Liebig for average crops because of the neglect of roots and stubbles, and points out that some plants can produce crops far in excess of these averages. He quotes, for example, 50 tons of dry organic matter per hectare (not including wood and leaves) harvested from a banana plantation; 250 tons fresh tubers which *Manihot utilissima* Pohl can produce per hectare, as well as other types of plants which can yield as much as 50 or 60 tons of organic carbon per hectare annually.

Table I.III shows, however, that unless Vernadsky is willing to postulate that the average annual plankton production in the sea is not 3.75 tons, as estimated by Riley, but 30 or 50 tons of carbon per hectare, his assumption of a yearly fixation of 10^{13} tons carbon is impossible.

Our estimates of the rate of carbon fixation on earth can be checked by calculations of an entirely different and not less interesting type—based on the amount of available sun energy and its average utilization in photosynthesis. The energy of the sun radiation reaching the upper boundaries of the atmosphere is 1.25×10^{24} cal. per annum, and only about 40% of this energy penetrates to the surface of the earth, the rest being scattered and absorbed by the clouds and by the atmosphere. Of the 5×10^{23} cal. which reach the earth's surface, 50% are in the form of infrared and extreme red radiations, which are not used in photosynthesis, and at least 20% are absorbed by rocks, sand and ploughed fields, or

reflected by ice and snow, so that not much more than 2×10^{23} cal. can be allocated to plant-covered land and plankton-filled sea. Of this amount, at least 10% are lost by reflection on water surface, and further losses must occur through the absorption of visible light by water (*cf.* Vol. II, Chapter 22) and dissolved ions. On land, too, 10 or 20% of all radiation which falls on plant-covered areas is lost by diffuse reflection. (Woods and forests are more efficient light traps than meadows and fields, and therefore appear as dark spots on aerial maps.)

Altogether, not more than 1.5×10^{23} cal. are absorbed annually by the plant pigments, and can thus be utilized in photosynthesis. It will be shown in volume II, chapter 28 that, under natural conditions, the energy conversion yield of green plants is of the order of 2%. This brings us to the figure 3×10^{21} cal. for the probable annual energy accumulation by photosynthesis, corresponding to the formation of 3×10^{11} tons of organic carbon. (The heat of combustion of organic matter is approximately 10^{10} cal. per ton of carbon contained in it.) This agrees with the value derived above from crop estimates, and confirms the utter impossibility of the much larger figures of Vernadsky.

The reduction of carbon dioxide by green plants is the largest single chemical process on earth. To make clearer what a yield of 10^{11} tons per year means, we may compare it with the total output of the chemical, metallurgical, and mining industries on earth, which is of the order of 10^9 tons annually. Ninety per cent of this output is coal and oil, *i. e.*, products due to photosynthesis in earlier ages. Similarly impressive is the comparison of the *energy* stored annually by the plants, with the energy available from other sources. The energy converted by photosynthesis is about one hundred times larger than the heat of combustion of all the coal mined on earth in the same period, and ten thousand times larger than the energy of falling water utilized in the whole world. On the other hand, about three hundred times more solar energy is spent on the evaporation of water from the oceans and continents than is utilized in photosynthesis. Plants alone spend, according to the estimates of Schroeder (1919²), 16×10^{21} cal. annually on transpiration, or more than ten times more than on photosynthesis. Since aquatic plants have no need for transpiration, all this energy is used up by land plants. The ratio of transpiration energy to the energy of photosynthesis is, for land plants, of the order of 50 or 100 to 1.

The carbon dioxide cycle in nature is of great importance for the climate of the earth; even small changes in its photostationary state, which probably have occurred in the history of the earth, must have had far-reaching consequences. It is probable, for example, that in the pre-glacial age, the carbon dioxide concentration in the air was higher than now, and the climate warmer (because carbon dioxide prevents the escape

of infrared radiation from the earth). Photosynthesis was therefore more intense than now, and the cover of vegetation denser. The removal of carbon dioxide by the mineralization of coal and oil, the formation of carbonate rocks and the increase in the concentration of alkaline earth ions in the oceans, have caused a decrease in photosynthesis and drop in temperature, and thus contributed to the advent of the glacial period.

We cannot dwell here much longer on the role of photosynthesis in the evolution of the earth and its influence on the geochemical distribution of the elements. It must be mentioned, however, that in addition to the *carbon dioxide cycle*, photosynthesis gives rise also to a natural *cycle of oxygen*. The atmosphere contains approximately 2.8×10^{24} tons of this element. If the living organisms consume annually the equivalent of 15×10^{10} tons of carbon dioxide, *i. e.*, 12×10^{10} tons of oxygen, they must renew all the oxygen in the air in a little over two thousand years, and decompose all the water in the oceans in about two million years. This is still a short period compared with the age of life on earth; we can thus conclude that all oxygen now present on the surface of the earth, as H_2O or O_2 , has repeatedly passed, in previous geological ages, from the atmosphere through the biosphere into the hydrosphere and back.

Since this cycle is composed of a photochemical forward reaction and a nonphotochemical back reaction, it does not lead to a thermodynamic equilibrium, but rather to a steady "photostationary state." This fact may be of importance for the *distribution of oxygen isotopes* between air and water. It has been revealed by the measurements of Dole (1936), Greene and Voskuyl (1936) and others, that the oxygen in the air is about 7.5×10^{-5} atomic weight units heavier than oxygen in the water of the oceans. If air and water were in a thermodynamic isotopic equilibrium at the average temperature prevailing at sea level, the difference should be three times smaller. Among several attempts to explain this discrepancy, Greene and Voskuyl suggested that photosynthesis may play a part in it. They pointed out that, if plants convert oxygen from carbon dioxide (two O atoms) and water (one O atom) into free oxygen without discrimination between O^{16} and O^{18} , the oxygen produced in this way must be 1×10^{-4} atomic weight units heavier than oxygen in water (because the heavy isotope is more abundant in carbon dioxide than in water). However, this explanation presumes that oxygen in the air is the product of a single photosynthesis, whereas we have seen above that it must have undergone repeated back and forth transfers. Furthermore, it has been long suspected, and recently confirmed by experiments with radioactive tracers, (*cf.* page 55), that *all* oxygen produced in photosynthesis comes from water. Thus, the hypothesis of Greene and Voskuyl is untenable. However, photosynthesis may have influenced the oxygen isotope distribution between air and water in a different way. It was suggested above that this distribution corresponds to a *photostationary state*, and not to a thermodynamic equilibrium. If oxygen is produced indiscriminately from H_2O^{18} and H_2O^{16} in photosynthesis (as seems to be indicated by the results of Vinogradov and Teis 1941) but the heavy isotope reacts slower in the thermal back reaction, this must bring about an accumulation of the heavy isotope in the atmosphere, and may thus account for the higher density of atmospheric oxygen.

Bibliography to Chapter 1

Total Yield of Photosynthesis on Earth

- 1840 Liebig, J., *Chemie in ihrer Anwendung auf Agricultur und Physiologie*. 1st ed., Vieweg, Braunschweig, 1840.
- 1885 Ebermayer, E., *Die Beschaffenheit der Waldluft und die Bedeutung der atmosphärischen Kohlensäure für die Waldvegetation*. Enke, Stuttgart, 1885.
- 1908 Arrhenius, S., *Werden der Welten*. Akademische Verlagsgesellschaft, Leipzig, 1908, p. 51.
- 1913 Ciamician, G., *Die Photochemie der Zukunft*, Enke, Stuttgart, 1913, p. 17.
- 1919 Schroeder, H., *Naturwissenschaften*, **7**, 8.
Schroeder, H., *ibid.*, **7**, 976.
- 1930 Vernadsky, V. I. (Wernadsky), *Geochemie*. Akademische Verlagsgesellschaft, Leipzig, 1930; *La biosphère*. Paris, 1930.
- 1932 Krebs, E., and Verbinskaya, N., *J. conseil intern. exploration mer*, **7**, 25.
- 1933 Cooper, L. H. N., *J. Marine Biol. Assoc. United Kingdom*, **20**, 197.
- 1935 Seiwel, H. R., *J. conseil intern. exploration mer*, **10**, 20.
- 1936 Dole, M., *J. Chem. Phys.*, **4**, 268.
Greene, C. H., and Voskuyl, R. J., *J. Am. Chem. Soc.*, **58**, 693.
- 1938 Gut, Ch., *J. forestier suisse*, **89**, 195, 236.
Riley, G. A., *J. Marine Research Sears Foundation*, **1**, 335.
- 1939 Riley, G. A., *ibid.*, **2**, 145.
- 1941 Riley, G. A., *Bull. Bingham Oceanogr. Coll.*, **1**, 1.
Vinogradov, A. P., and Teis, R. V., *Compt. rend. acad. sci. URSS*, **33**, 490.

CHAPTER 2

THE DISCOVERY OF PHOTOSYNTHESIS *

1. Precursor: Stephen Hales

Stephen Hales (1677–1761), the minister-naturalist of Teddington, England, an illustrious contemporary of Newton, made numerous experiments on the evolution and absorption of gases by different substances of animal or vegetable origin, and decided thereupon that air must be an important constituent of all organic matter. (He meant by this, that air, one of the four original elements of Aristotle, must be added to the list of alchemistic “first principles”—mercury, oil, salt, sulfur—which were supposed at that time to contribute to the composition of all material bodies.) Discussing further, in his *Vegetable Staticks* (1727), the importance of leaves for plants, Hales wrote: “Plants very probably draw through their leaves some part of their nourishment from the air,” and he added, “may not light also, by freely entering surfaces of leaves and flowers, contribute much to ennobling the principles of Vegetables?”

2. The Background: The Birth of Pneumochemistry

No further elaboration of Hales' vision was possible until the existence and nature of *different kinds* of “air” became known through the work of the great “pneumochemists” of the second half of the eighteenth century. Black discovered “fixed air” (that is, carbon dioxide) in 1754; Scheele prepared chlorine in 1774, and found in 1773 that atmospheric air is composed of two gases, one inert and the other capable of maintaining combustion. (This observation was not made public until 1777, thus depriving Scheele of the priority in the discovery of oxygen.) In 1775, Priestley obtained “dephlogisticated air” (that is, oxygen) from mercurous oxide; and later the same author described nitrous oxide, sulfur dioxide, hydrochloric acid gas, and carbon monoxide. “Inflammable air” (that is, hydrogen, although, for a while, methane was often confused with it) was discovered by Cavendish in 1766; in 1784, the same author proved that water is a compound of hydrogen and oxygen. Between 1772 and 1782, Lavoisier discovered the composition of the air and propounded the new doctrine of oxidation and respiration, interpreting these processes as combinations of different substrates with oxygen,

* Bibliography, page 27.

and this concept rapidly displaced the old phlogiston theory of Stahl. In 1781 Lavoisier showed that "fixed air" is a compound of carbon and oxygen. Such was the background of rapid progress in the chemistry of gases between 1750 and 1775, which made the discovery of photosynthesis possible, yes, almost inevitable.

Of three men whose names are associated with this discovery, Priestley, Ingen-Housz and Senebier, two were clerics, like Hales, and one a physician; all were typical amateur naturalists of the Age of Enlightenment. There their similarity ended; for it would be difficult to find men more unlike each other than the militant nonconformist minister, Joseph Priestley, the pompous, brilliant, court physician, Jan Ingen-Housz, who was equally at home in Amsterdam, London, Paris and Vienna, and Jean Senebier, a plodding, provincial pastor from the pious and savant town of Geneva.

3. The Purification of Air by Plants: Priestley

Joseph Priestley (1733–1804) was undoubtedly the greatest scientist of the three, although he considered science the least important of his many occupations. His foremost interest was in theology and philoso-

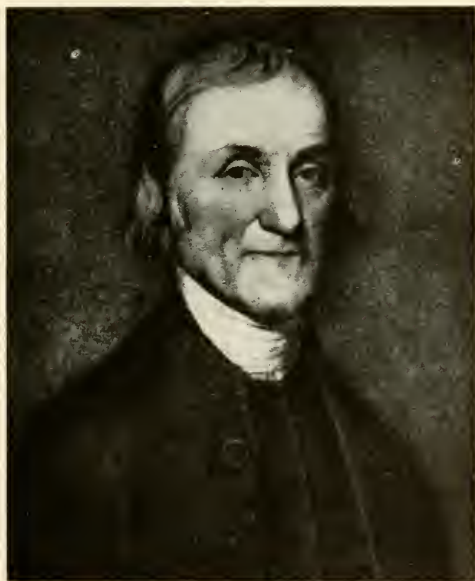

FIG. 1.—Joseph Priestley.

phy; his ardent nonconformism brought him into perpetual conflict with authorities and into disrepute as a sympathizer with the French Revolution. In the stormy days of 1791, his house in Birmingham was sacked by

the mob, whereupon the French Republic made him an honorary citizen, and offered him refuge in France; however, he preferred to exile himself to America, where he spent the last ten years of his life in the little town of Northumberland, Pennsylvania.

Throughout his life, Priestley enjoyed playing about with gases; his writings reveal him as one of the most skillful and successful experimentalists of all times; but his powers of logic and analysis were reserved for philosophy and theology, and in the presentation of his experiments he stuck to the old phlogiston theory—long after the new concepts of Lavoisier had found general acceptance. Thus, the wide implications of Priestley's greatest discovery—oxygen—escaped him; and he was even less aware of the general import of his experiments with green plants, and quite willing to leave their exploitation to others. The following quotations (1772) show the extent of his contribution to the discovery of photosynthesis:

"I have been so happy as by accident to hit upon a method of restoring air which has been injured by the burning of candles and to have discovered at least one of the restoratives which Nature employs for this purpose. It is *vegetation*. One might have imagined that since common air is necessary to vegetable as well as to animal life, both plants and animals had affected it in the same manner; and I own that I had that expectation when I first put a sprig of mint into a glass jar standing inverted in a vessel of water; but when it had continued growing there for some months, I found that the air would neither extinguish a candle, nor was it at all inconvenient to a mouse which I put into it.

"Finding that candles would burn very well in air in which plants had grown a long time . . . I thought it was possible that plants might also restore the air which had been injured by the burning of candles. Accordingly, on the 17th of August 1771 I put a sprig of mint into a quantity of air in which a wax candle had burned out and found that on the 27th of the same month another candle burnt perfectly well in it."

This momentous observation was described in the *Philosophical Transactions of the Royal Society* in 1772; and reprinted in the first volume of Priestley's famous work, *Experiments and Observations on Different Kinds of Air*, which appeared in 1776.

Other experiments, described in the same paper, showed that plants thrive particularly well in air made "obnoxious" by the exhalations of animals. The discovery of the complementary character of the chemical functions of plants and animals made a great impression on Priestley's contemporaries, and brought him in 1773 the award of the Copley medal of the Royal Society. However, Priestley did not return to the study of air improvement by plants until 1777; and the first new results on this subject appeared in his second physicochemical work, *Experiments and Observations Relating to Various Branches of Natural Philosophy*, whose first volume was published in 1779. These new observations were both interesting and confusing. Several scientists abroad, notably Scheele,

had failed to confirm the beneficent effect of plants on air; and now Priestley too found himself unable to obtain positive results regularly. Instead of his earlier categorical statements, he now wrote: "Upon the whole, I think it *probable* that the vegetation of healthy plants, growing in situations natural to them, has a salutary effect on the air." Before



FIG. 2.—A contemporary cartoon of Joseph Priestley.

he succeeded in finding an explanation for the irregular results (which, we think now, might have been caused by poor illumination), Priestley's attention was diverted by an observation which he called "the most extraordinary of all my unexpected discoveries." He found, namely, that a "green matter" deposited on the walls of many of his water containers, formed bubbles of pure "dephlogisticated air" (that is, oxygen), whenever it was illuminated by the sun. At first, Priestley thought this

matter to be of vegetable nature. How close he was, at this point, to the final discovery of photosynthesis! However, he let himself be deceived by microscopic observations which revealed no organic forms in the green matter, and by the formation of this matter in closed vessels, and decided that it was a thing "sui generis," of mineral rather than organic character. Subsequent observations diverted him even further away from the right track—he noticed that water decanted from the green matter also evolved "purified air" upon shaking, and that even pure pump water, not visibly contaminated with green matter, produced "purified air" upon prolonged standing in sunlight. The picture thus became more and more confused, as Priestley acknowledged in the following sentences: "It will probably be imagined that the result of the experiments recited in this section throws some uncertainty on the result of those from which I have concluded that air is ameliorated by the *vegetation* of plants, and especially as the water by which they were confined was exposed to the open air and the sun in the garden. To this I can only say that I have represented the naked *facts*, as I have observed them; and having not great attachment to any particular hypothesis, I am very willing that my reader should draw his own conclusions for himself." (However, he added some arguments which made him believe that the previously observed plant effects were genuine and not due to the illumination of water.)

Obviously, Priestley's careful attention to factual details and his refusal to attach too much importance to hypotheses—in short, his purely experimental approach—prevented, at that time, his complete realization of the true nature of photosynthesis. His doubts were cleared away two years later, when he published the second volume of *Observations and Experiments in Natural Philosophy*. By then, the green matter was definitely identified as vegetable in nature. (It is interesting to reflect that the same unicellular green algae, which have recently become the favorite subjects of photosynthetic study, served in the discovery of this phenomenon over a century and a half ago.) The action of water decanted from the green algal deposits, which baffled Priestley in 1779, was explained in 1781 as an effect of supersaturation with oxygen; the formation of green deposit in closed vessels was attributed to imperfect closure and contamination of water with "seeds" before corking. Thus, the picture of oxygen being formed by the cooperation of green vegetable matter and sunlight, emerged clearly from the temporary confusion.

These results were obtained and published by Priestley in 1781; and in the meantime, a development had taken place, which Priestley himself had described, almost prophetically, four years earlier, when he wrote (in the preface to the first volume of *Different Kinds of Air*):

"I do not think it at all degrading to the business of experimental philosophy to compare it, as I often do, to the diversion of *hunting*, where it sometimes happens that

those who have beat the ground the most, and are consequently the best acquainted with it, weary themselves without starting any game; when it may fall in the way of a mere passenger, so that there is but little room for boasting in the most successful termination of the chase."

4. The Importance of Sunlight: Ingen-Housz

The "mere passenger" in this case turned out to be the Dutchman, Ingen-Housz. Three years older than Priestley (he was born in 1730 in the Dutch town of Breda), he was a man of the world and until then had found little time for experimental research. He practiced medicine, first in his home town in Holland, then in England and Austria, where he be-



FIG. 3.—Jan Ingen-Housz (from a bust by Seifert).

came court physician to the Empress Maria Theresa, and was named Aulic counselor of the Empire, in recognition of his services in saving, by inoculation, the children of the Empress during an epidemic of small-pox. According to Ingen-Housz' own story, his interest in the chemical function of plants was aroused by the speech which the then President

of the Royal Society, John Pringle, made on the occasion of the presentation of the Copley medal to Priestley in 1773. In this speech, Pringle extolled the importance of Priestley's discovery, which showed that the apparently useless or even poisonous plants "do not grow in vain," and that "salutary gales convey to the woods that flourish in the most remote and unpeopled regions, our vitiated air, for our relief, and for their nourishment."

However, Ingen-Housz' plans for studying this mutual well-being of animals and plants, even if they were actually conceived in 1773, did not mature for seven years, and thus not until after the publication of Priestley's observations on the "green matter" which evolved purified air in sunlight. Ingen-Housz—the passenger—was spending the year, 1779, in England on a leave of absence from Vienna. In June of this year he retired to a "small villa" in the English countryside, and there, working "from morning till night," he performed, in less than three months, more than five hundred experiments. With amazing speed, the results of these experiments were ready for presentation to the public in October of the same year, in the form of a book entitled *Experiments upon Vegetables, discovering Their Great Power of Purifying the Common Air in Sunshine and Injuring it in the Shade and at Night*. The book was dedicated to John Pringle, whose presidential address seven years earlier had first aroused Ingen-Housz' interest in plant chemistry. Ingen-Housz explained the hurried publication by the necessity of returning to Vienna; but he also realized the importance of his discovery and was decided not to let anybody deprive him of it or even as much as share in it.

The progress achieved by Ingen-Housz in these three months was indeed remarkable. Despite numerous errors which can be found in his book and which were caused partly by haste and partly by the ready belief of the author in his conjectures (so different from the conscientiousness of a Priestley), Ingen-Housz has clearly established in this book the fundamental facts of photosynthesis. He wrote:

"I observed that plants not only have a faculty to correct bad air in six or ten days, by growing in it, as the experiments of Dr. Priestley indicate, but that they perform this important office in a complete manner in a few hours; that this wonderful operation is by no means owing to the vegetation of the plant, but to the influence of the light of the sun upon the plant. I found that plants have, moreover, the most surprizing faculty of elaborating the air which they contain, and undoubtedly absorb continually from the common atmosphere, into real and fine dephlogisticated air; that they pour down continually a shower of this depurated air, which . . . contributes to render the atmosphere more fit for animal life; that this operation . . . begins only after the sun has for some time made his appearance above the horizon . . .; that this operation of the plants is more or less brisk in proportion to the clearness of the day and the exposition of the plants; that plants shaded by high buildings, or growing under a dark shade of other plants, do not perform this office, but, on the contrary, throw out an air hurtful to animals; . . . that this operation of plants diminishes towards the close of the day, and

ceases entirely at sunset; that this office is not performed by the whole plant, but only by the leaves and the green stalks; that even the most poisonous plants perform this office in common with the mildest and most salutary; that the most part of leaves pour out the greatest quantity of this dephlogisticated air from their under surface . . . ; that all plants contaminate the surrounding air by night; . . . that all flowers render the surrounding air highly noxious, equally by night and by day; that roots and fruits have the same deleterious quality at all times; . . . that the sun by itself has no power to mend the air without the concurrence of plants."

As revealed by this summary, Ingen-Housz' main achievements were the discovery of the importance of *light* for the "dephlogistication" of air by plants, and the proof that the plants improve the air not merely by absorbing its "mephitic" constituents (as suggested by Priestley), but that they also actively *produce* "vital air" (oxygen). He proved this fact by demonstrating the formation of oxygen bubbles by submerged leaves, a technique which was to be widely used later in the study of photosynthesis. (Priestley had observed the oxygen bubble formation with his "green matter" before; but, at that time, he did not yet realize that the absorption of "bad air" by land plants and the liberation of "good air" by "green matter" were merely two aspects of one and the same phenomenon.)

Ingen-Housz laid great emphasis, as shown by the title of his book, on his discovery of the "poisoning" of the air by plants in the dark, and he dwelt in detail on the gruesome dangers of keeping large trees in inhabited rooms, or of spending nights in a closed space containing large quantities of flowers, fruits or vegetables. This point became a subject of violent controversy between Ingen-Housz and Senebier, the latter denying any gas liberation by plants in darkness, and insisting that plants produce no dangerous "effluvia" when they grow in the open air. The fact of plant respiration was correctly observed by Ingen-Housz; but its dangerous aspects were obviously over-stressed, perhaps for the sake of philosophical satisfaction which he derived from the apposition of the wholesome influence of plants during the day and their poisonous activity during the night. The difference between *inert* gases (nitrogen and carbon dioxide) and active *poisons* did not become clear to the chemists until much later.

5. The Part of Carbon Dioxide: Senebier

Ingen-Housz' haste in asserting his priority proved well founded. Three years later, in 1782, Jean Senebier published, in his home town of Geneva, three volumes of *Mémoires physico-chimiques sur l'influence de la lumière solaire pour modifier les êtres des trois règnes de la nature et surtout ceux du règne végétal*. After acknowledging in the preface the priority and the importance of the work of Ingen-Housz, Senebier explained that he started his experiments before the appearance of the latter's book,

being qualified for this work by his previous occupation with the effects of light. He proceeded with the detailed description of his experiments and conclusions, without specifically acknowledging the similarity (or disagreement) between his results and those of Ingen-Housz. He suggested, not unreasonably, that the importance of the subject makes its study by two independent observers worth while. Ever after, he found himself exposed to the merciless irony and clever insinuations of Ingen-Housz, whose wrath would not be assuaged by the long-winded explanations of the Swiss pastor. The subsequent publications of both adver-



FIG. 4.—Jean Senebier.

saries, the second volume of Ingen-Housz' French edition of *Experiments on Vegetables* (1789) and Senebier's *Recherches sur l'influence de la lumière solaire pour metamorphoser l'air fixe en air pur par végétation* (1783) and *Expériences sur l'action de la lumière solaire dans la végétation* (1788), are filled with acid polemics, and make sad reading.

Senebier served his cause badly by the extreme profuseness of his writing. In addition to the above-mentioned *Mémoires physico-chimiques* (1782), *Recherches* (1783), and *Expériences* (1788), he published a *Physiologie végétale* in five volumes in 1800. The absence of adequate summaries, and the trite rhetories embellishing the extensive descriptions

of his experiments, make these thirteen volumes very tedious reading. No wonder the historians were not too kind to Senebier. Harvey-Gibson, in his *Outlines of the History of Botany*, denied him the recognition of the one important step which he made beyond the confirmation of the discoveries of Ingen-Housz, and which was credited to him by Sachs and Pfeffer—the realization of the part played by “fixed air” (carbon dioxide) in photosynthesis.

The words “fixed air” do not occur at all in Ingen-Housz’ first book (1779), and in the second one (1789) they appear almost exclusively in connection with the description of the products of plant respiration. He found the effect of large quantities of “fixed air” to be deleterious to the air-purifying activity of plants, and that of small quantities indefinite. If chemical equations had been known at that time, Ingen-Housz would have written the equation of photosynthesis in the following form:

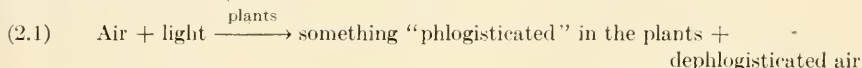

He had no definite conception as to what kind of “air” is used for this transformation. He even considered the possibility of substituting, for “common air” in (2.1), “inflammable air” (hydrogen), or water vapor.

Senebier, on the other hand, was aware even in his first work, published in 1782, of the accelerating effect of “fixed air” on the production of “pure air” by plants and wrote, “Il paroît clairement, que l’air, fourni par les feuilles exposées sous l’eau au soleil, est l’effet d’une combinaison particulière de l’air fixe, opérée dans la feuille par le moyen du soleil,” and in another place, “Je n’admets pas que l’air commun de l’atmosphère se tamise dans les feuilles des végétaux pour y déposer sa portion phlogistique, et en sortir air déphlogistiqué après cette dépuration.” This last remark was directed against the hypothesis of Priestley, but applied equally well to the ideas of Ingen-Housz. As alternative to the picture of a transformation of ordinary air into pure “dephlogisticated air,” Senebier suggested “que l’air fixe, dissous dans l’eau, est la nourriture que les plantes tirent de l’air qui les baigne, et la source de l’air pur qu’elles fournissent par l’élaboration qu’elles lui font subir.” The transformation of “fixed air” into “pure air” is the main subject of his second book (1783), as shown by its title, and in his *Expériences* (1788) a special chapter deals with the proof that “l’air rendu par les plantes exposées au soleil, est le produit de l’élaboration de l’air fixe par le moyen de la lumière.” Senebier shows convincingly, in polemics against Ingen-Housz, who even in 1784 denied that fixed air is necessary for the “purification” of air by plants, that no “dephlogisticated air” is formed from distilled water, even if it is saturated with common air, provided the latter is free from “fixed air.”

The equation (2.1), by which we have summarized the discoveries of Ingen-Housz, was thus improved by Senebier in one point, and could now be written as follows:

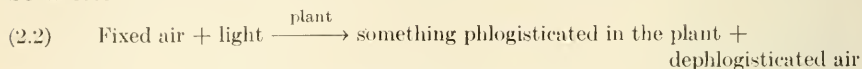

6. The Assimilation of Carbon

Priestley and Ingen-Housz assumed that the plants, in the process of transforming "impure air" into "purified air," acquire nourishment for themselves. (If they would have adhered strictly to the phlogiston theory, they should have concluded that this nourishment is pure phlogiston.) Senebier, who discovered that the substrate of transformation is fixed air, could have gone a step further, and used Lavoisier's theory of the composition of fixed air to deduce that *carbon* is the acquisition which the plants make by absorbing carbon dioxide and exhaling oxygen. However, Senebier again showed himself no match for the quick-witted Ingen-Housz. In 1779, the Dutchman had reaped the seeds sown by Priestley's experiments, and left to the Swiss pastor the work of gleanings; in 1796, he was the first to harvest the fruits of Lavoisier's theory. He, who as late as 1784, denied that fixed air has anything to do with photosynthesis, wholeheartedly espoused this doctrine in 1796, in a new book *Food of Plants and Renovation of the Soil*. He hinted that he had believed in this doctrine since 1779, and left Senebier and his polemics with him about this point unmentioned. Nevertheless, this last book of Ingen-Housz is another remarkable achievement, and has been a milestone in the development of the science of plant nutrition. The mechanism of photosynthesis is presented in this book, for the first time, in terms of the new chemical theory, calling "fixed air"—carbonic acid, and "dephlogisticated air"—oxygen, and proclaiming that plants acquire their carbon (whose important role in the composition of organic matter was well recognized by then) by the decomposition of carbonic acid from the air. Hales' doctrine of "aerial nourishment" of plants has thus received its first concrete interpretation. While Senebier thought that carbon dioxide from the air is first dissolved in soil water and reaches the leaves through the roots, Ingen-Housz suggested that plants receive only their "juices" from the soil, and obtain both their carbon, and their oxygen, from the air. He had the erroneous idea that while carbon is obtained from carbonic acid during the day, oxygen is derived from the same source during the night. (This is one example of the many "wild guesses" which can be found in the writings of Ingen-Housz.) One question which worried Ingen-Housz was the supply of carbon dioxide. While de Saussure thought that carbon dioxide is a permanent, although minor and variable component of the atmosphere, Lavoisier found no carbon dioxide at all

in the common air. In his introduction to the German translation of Ingen-Housz' pamphlet, von Humboldt communicated analyses which purported to show the constant occurrence of carbon dioxide in common air, in concentrations from 0.7 to 1.4%. The true carbon dioxide content of the air—which is fairly constant at 0.03% in the open country, but may rise considerably above this value in the neighborhood of populated places, industrial establishments and active volcanoes—was established early in the next century by Dalton, de Saussure, and Boussingault (*cf.* the review by Letts and Black, 1900).

After the appearance of Ingen-Housz' *Food of Plants*, the problem of oxygen liberation by illuminated plants became merged with the problem of carbon assimilation from the air and the synthesis of organic matter. The two terms under which this process is generally known, "photosynthesis" and "assimilation" have their origin in these two aspects of the problem. Neither is entirely satisfactory, since "photosynthesis" could etymologically mean any synthesis under the influence of light, and "assimilation" (or even "assimilation of carbon") covers an even wider variety of phenomena. We shall use the term "photosynthesis" because it has practically acquired a very definite meaning and is only seldom applied to any photochemical reaction other than the synthesis of organic matter by plants in light.

In the light of Ingen-Housz' realization of the nutritive role of "air refining" by plants, we can again rewrite equation (2.2), in the form

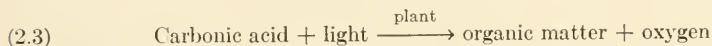

7. The Participation of Water: de Saussure

Quantitative treatment soon proved equation (2.3) to be incomplete. The recognition of this incompleteness came when *weighing* was added to *volume measuring* in the study of photosynthesis. This progress was due to another scholar from Geneva, Nicolas Théodore de Saussure (1767–1845) (son of the physicist who invented the hygrometer), a quiet and retiring man and a skillful and conscientious experimentalist. His results were published in 1804, under the title, *Recherches chimiques sur la végétation*. This is the first modern book on plant nutrition, full of careful analyses of gases, humus, and ash, and almost devoid of any speculations, or even hypotheses. The measurements of de Saussure proved definitely the correctness of Ingen-Housz' doctrine of aerial nutrition, and showed what elements the plants acquire from the soil. They confirmed the surmise of Senebier, that plants find enough nourishment in the small amount of carbon dioxide regularly present in the air, and showed that this is the *only* source of their carbon supply. De Saussure made the first comparison of the amounts of carbon dioxide absorbed and of oxygen

liberated by the plants; and most important of all, he proved that the *increase in dry weight caused by the assimilation of a certain quantity of carbon dioxide, is considerably larger than the weight of carbon contained in it.* Since the equivalent of all the oxygen contained in the decomposed carbon dioxide is evolved into the air, the large weight increase cannot be attributed to a coassimilation of oxygen from this source. The plants grew in pure water and air containing air carbon dioxide; therefore the only other possible source of weight increase was *water* (taken up in a form not removable by drying). De Saussure thought at that time that the assimilation of water is an independent process, merely coupled with the decomposition of carbon dioxide. However, the experimental results do not warrant such a separation of the two processes; what they prove is the *participation of water in photosynthesis.* They require an amplification of the over-all equation (2.3), which we may now write in the form:

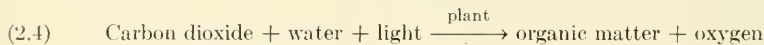

Perhaps because water came into the picture several years later than carbon dioxide, the concept of photosynthesis as *decomposition of carbon dioxide*

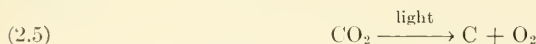

followed by hydration of carbon

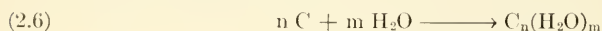

has persisted in the literature for a long time. We shall see in chapter 3, that photosynthesis is better interpreted as a *reaction between carbon dioxide and water*—more exactly, as reduction of carbon dioxide by water (or oxidation of water by carbon dioxide).

The study of photosynthesis, after the above described rapid start in the quarter century between 1779 and 1804, lapsed into an almost complete quiescence for the next fifty years. Liebig (1803–1873) in his famous *Chemistry in its Application to Agriculture and Physiology*, severely criticized the methods used by plant physiologists of that time in dealing with the problems of material exchange between plants and the surrounding media. Boussingault (1802–1887) was the first to improve these methods; to him is due the first redetermination of the gas exchange in photosynthesis, with a precision better than that achieved by de Saussure in 1804 (*cf.* Chapter 3).

8. The Conversion of Light Energy: Robert Mayer

If the time between 1804 and 1864 (the year when Boussingault published his first paper on photosynthesis) was sterile in the development of the *physiology* and *chemistry* of photosynthesis, it saw the foundation of

its *physics* laid by another surgeon, Julius Robert Mayer of Heilbronn. In 1845, three years after he first enounced the law of conservation of energy, Mayer, in a pamphlet entitled *The Organic Motion in its Relation*



FIG. 5.—Robert Mayer.

to *Metabolism* dwelt upon the consequences of this law for life processes on earth, and wrote:

“Die Natur hat sich die Aufgabe gestellt, das der Erde zuströmende Licht im Fluge zu erhaschen und die beweglichste aller Kräfte, in starre Form umgewandelt, aufzuspeichern. Zur Erreichung dieses Zweckes hat sie die Erdkruste mit Organismen überzogen, welche lebend das Sonnenlicht in sich aufnehmen and unter Verwendung dieser Kraft eine fortlaufende Summe chemischer Differenz erzeugen.

Diese Organismen sind die *Pflanzen*; die Pflanzenwelt bildet ein Reservoir, in welchem die flüchtigen Sonnenstrahlen fixiert und zur Nutzniessung geschickt niedergelegt werden; eine ökonomische Fürsorge, an welche die physische Existenz des Menschengeschlechtes unzertrennlich geknüpft ist.

“Die Pflanzen nehmen eine Kraft, das Licht, auf, und bringen eine Kraft hervor: die chemische Differenz.”

The last quotation means that our equation (2.4) can be amplified, to read

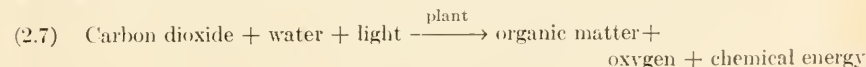

The work of Robert Mayer can be considered as the concluding chapter in the history of the discovery of photosynthesis. Qualitatively,

equation (2.7) is complete; its further elaboration could result only from detailed quantitative investigations, of the kind inaugurated by Bous-singault in 1864.

The discovery of photosynthesis has engendered bitter rivalries, and historians have kept the flame of hate alive long after the principal actors in the drama have been silenced by death. The biographers of Priestley have felt that the discovery has been unfairly snatched away from this great experimentalist; the biographer of Ingen-Housz, Wiesner (1905), had no doubts that all honors belong to his hero, who "always kept his fights noble and magnanimous, even after Priestley had attempted baselessly to defame his reputation and Senebier had undertaken to put himself into the possession of his discoveries by dishonest means. The most he has ever allowed himself has been gentle, nicely expressed irony." The friends and compatriots of Senebier, including de Saussure, and later N. Pringsheim (the latter mainly for reasons of his disagreement with everything Sachs stood for), were inclined to attribute to him, if not the whole, at least a large part of the discovery.

We are now sufficiently remote from these controversies to be only mildly interested in the questions of priority and personal ambitions, and to recognize the discovery of photosynthesis as the inevitable consequence of the two great achievements of science in the period between 1770 and 1840—the discovery of chemical elements, and the creation of the concept of energy. The work of the five men whose names are associated with the foundations of photosynthesis, Priestley, Ingen-Housz, Senebier, de Saussure and Robert Mayer, has evolved from this background, which two of them, Priestley and Mayer, themselves helped to create.

After 1860, the development of plant physiology in general, and of photosynthesis in particular, took a rapid spurt, under the leadership of such men as Sachs, Pfeffer and Timiriazev. From this time on, the literature on photosynthesis has grown precipitously, until now a complete review of all papers on this subject, scattered through botanical, agricultural, chemical and physical journals, appears almost impossible.* This broad development of the subject of photosynthesis after 1860, which has branched into many different fields, including in addition to plant physiology also organic chemistry, physical chemistry and physics (not to speak of ecology and other branches of botany), makes it advisable to close here the historical introduction, and to deal henceforth with the different aspects of photosynthesis in a logical rather than chronological order.

* A list of about 900 investigations published before 1925 can be found in W. Stiles' monograph, *Photosynthesis*. The subject was treated in an even more comprehensive manner one year later, in the well-known monograph, of the same title, by H. A. Spoehr (1926), which, however, does not contain a list of bibliographical references.

Bibliography to Chapter 2

Discovery of Photosynthesis

(a) ORIGINAL WORKS

- 1727 Hales, St., *Statical Essays, Containing Vegetable Staticks, or, an Account of Some Statical Experiments on the Sap in Vegetation*. W. Innys, London, 1727.
- 1772 Priestley, J., *Phil. Trans. Roy. Soc. London*, **62**, 147.
- 1776 Priestley, J., *Experiments and Observations on Different Kinds of Air*. Vol. 1, J. Johnson, London, 1776.
- 1779 Priestley, J., *Experiments and Observations Relating to Various Branches of Natural Philosophy*. Vol. 1, J. Johnson, London, 1779.
- Ingen-Housz, J., *Experiments upon Vegetables, Discovering their Great Power of Purifying the Common Air in Sunshine and Injuring It in the Shade and at Night*. Elmsly & Payne, London, 1779.
- 1780 Ingen-Housz, J., *Expériences sur végétales etc.* (French translation by the author, with additions). F. Didot le jeune, Paris, 1780.
- 1781 Priestley, J., *Experiments and Observations Relating to Various Branches of Natural Philosophy*. Vol. 2, J. Johnson, London, 1781.
- 1782 Senebier, J., *Mémoires physico-chimiques sur l'influence de la lumière solaire pour modifier les êtres de trois règnes, surtout ceux du règne végétal*. 3 vols., Chirol, Genève, 1782.
- 1783 Senebier, J., *Recherches sur l'influence de la lumière solaire pour metamorphoser l'air fixe en air pur par végétation*. Chirol, Genève, 1783.
- 1784 Ingen-Housz, J., *Vermischte Schriften*. 2 vols., Waple, Wien, 1784.
- 1788 Senebier, J., *Expériences sur l'action de la lumière solaire dans la végétation*. Barde, Manget et Co., Genève, 1788.
- 1789 Ingen-Housz, J., *Expériences sur végétales etc.* Vol. 2, Barrois, Paris, 1789.
- 1796 Ingen-Housz, J., *An Essay on the Food of Plants and the Renovation of Soils*. (Appendix to 15th Chapter of the General Report from the Board of Agriculture) London, 1796; appeared as a separate book in German: *Ernährung der Pflanzen und Fruchtbarkeit des Bodens*, with an introduction by F. A. von Humboldt, Leipzig, 1798.
- 1800 Senebier, J., *Physiologie végétale*. 5 vols., Paschoud, Genève, 1800.
- 1804 de Saussure, N. Th., *Recherches chimiques sur la végétation*. Nyon, Paris, 1804.
- 1845 Mayer, J. R., *Die Organische Bewegung in ihrem Zusammenhang mit dem Stoffwechsel*. Heilbronn, 1845. Reprinted in *Die Mechanik der Wärme; gesammelte Schriften*, Stuttgart, 1893, and in *Ostwald's Klassiker der exacten Naturwissenschaften*. No. 180, Akad. Verlagsgesellschaft, Leipzig, 1911.

(b) HISTORICAL WORKS AND REVIEWS

- Sachs, J. v., *Geschichte der Botanik*, First German ed., Oldenbourg, München, 1875, 1st English ed., Clarendon Press, London, 1890.
- Hansen, A., "Geschichte der Assimilation und Chlorophyllfunktion," *Arbeit. Botan. Inst. Univ. Würzburg*, 3, 123 (1884).
- Letts, E. A., and Black, R. F., "Carbonic Anhydride of the Atmosphere," *Sci. Proc. Roy. Dublin Soc.*, 9, II, 105 (1900).
- Green, J. R., *A History of Botany in the United Kingdom*. Dent & Co., London, and Dutton, New York, 1914.
- Harvey-Gibson, R. J., *Outlines of the History of Botany*. A. & C. Black, London, 1919.

about Priestley:

- Thorpe, T. E., *Joseph Priestley*. English Men of Science Series, Dent & Co., London, and Dutton, New York, 1906.
- Smith, E. F., *Priestley in America, 1794-1804*. Blakiston, Philadelphia, 1920.
- Holt, A., *A Life of John Priestley*. Oxford University Press, London, 1931.
- Aykroydt, W. R., *Three Philosophers (Lavoisier, Priestley, Cavendish)*. Heinemann, London, 1935.

about Ingen-Housz:

- Wiesner, J., *Jan Ingen-Housz, sein Leben und sein Wirken als Naturforscher und Arzt*. Wien, 1905.

PART ONE
THE CHEMISTRY OF PHOTOSYNTHESIS
AND RELATED PROCESSES

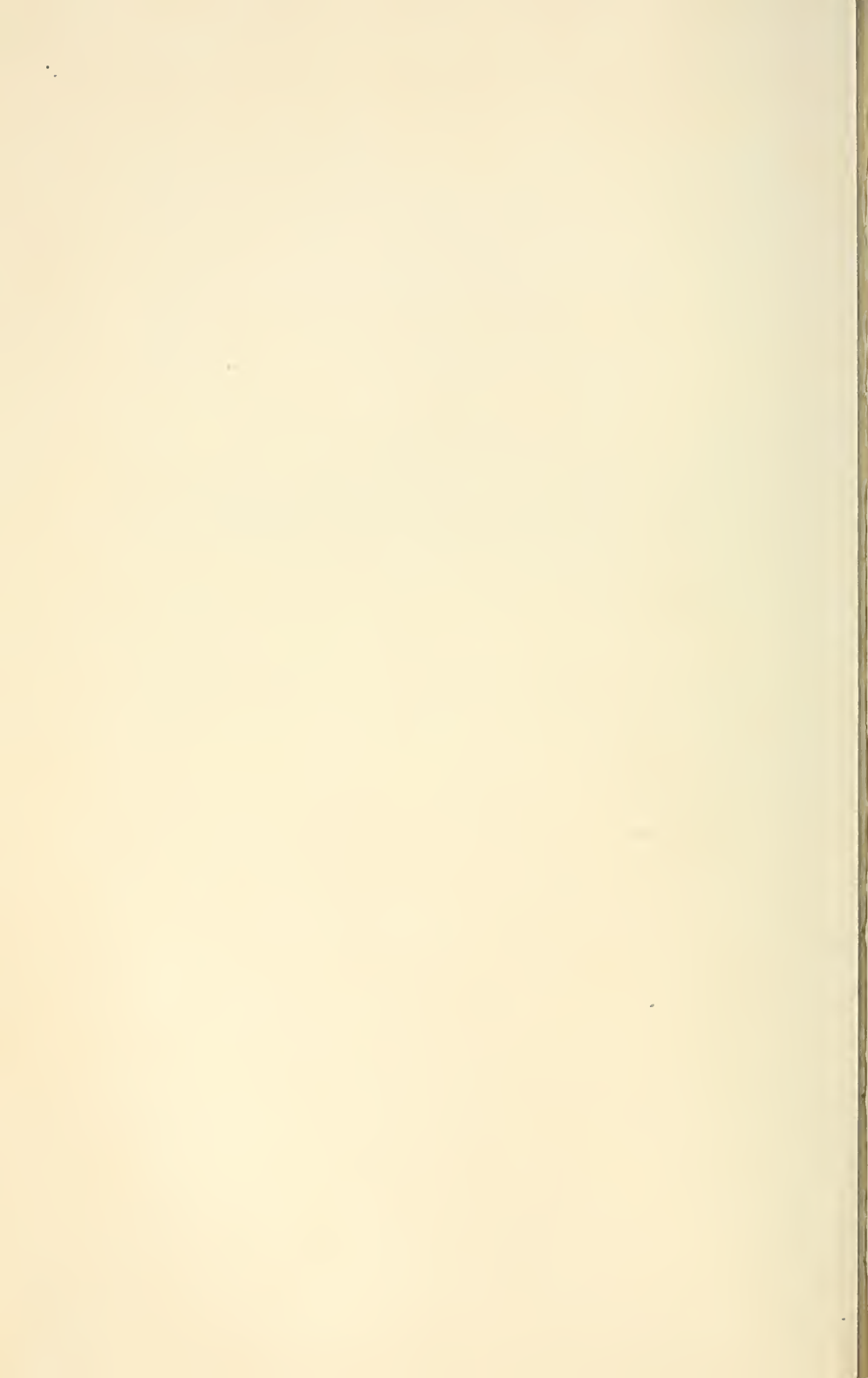

CHAPTER 3

THE OVER-ALL REACTION AND THE PRODUCTS OF PHOTOSYNTHESIS

In the first chapter, photosynthesis was characterized as the *reversal of combustion*, a process by which carbon dioxide and water are combined to form organic matter, while oxygen escapes into the medium. This definition describes what may be called "normal photosynthesis" of the higher plants, mosses and algae. In recent years, some significant variations of this process have been discovered, which occur regularly in pigmented bacteria, and can be induced artificially in certain algae. The present chapter deals with the over-all reaction of normal photosynthesis, while chapters 5 and 6 will be devoted to its modifications in bacteria and algae.

A. THE QUANTITATIVE BALANCE OF PHOTOSYNTHESIS *

1. The Photosynthetic Quotient

The relative amounts of oxygen and carbon dioxide exchanged in photosynthesis were first determined by de Saussure in 1804. He found the volume of oxygen evolved, ΔO_2 , to be smaller (by as much as 30–40%) than the volume of carbon dioxide consumed by the plants, $-\Delta CO_2$. According to his analyses, the "missing" oxygen was converted into nitrogen. We cannot blame de Saussure for this error, for it was not until sixty years later that the methods of quantitative plant physiology were sufficiently improved to allow a better determination of the "photosynthetic quotient," Q_P :

$$(3.1) \quad Q_P = \Delta O_2 / -\Delta CO_2$$

(The term "photosynthetic quotient" has been used by many authors, for example, by Willstätter and Stoll, to designate the inverse ratio, $-\Delta CO_2 / \Delta O_2$; this difference calls for care in the quotation of numerical results.)

When Boussingault redetermined the photosynthetic quotient in 1864, he found Q_P values varying between 0.8 and 1.2, with an average close to unity. In his measurements, the *net* production of oxygen was compared with the *net* consumption of carbon dioxide. However, even

* Bibliography, page 56.

Ingen-Housz knew (or suspected) that plants continue to respire in light, so that their net gas exchange during the day is the balance of photosynthesis and respiration. The calculation of *true* photosynthesis thus requires the application of a "respiration correction," which cannot be determined without certain arbitrary assumptions. Bonnier and Mangin (1886), who were the first to face this problem, used four methods for its solution. One method (which has since come into common use) was to determine the respiration in darkness, and to assume that its rate remains unchanged in light (*cf.* Chapter 20). The second method was based on the inhibition of photosynthesis by narcotics (which leaves the respiration almost unchanged, *cf.* Chapter 12); the third on the prevention of photosynthesis by deprivation of carbon dioxide, and the fourth on the comparison of gas exchange in leaves with high and low content of chlorophyll. By all four methods, Bonnier and Mangin obtained Q_P values considerably above unity (1.1 to 1.3). These results were not confirmed by subsequent investigators, notably Maquenne and Demoussy (1913) and Willstätter and Stoll (1918), who found that Q_P is equal to unity within the limits of experimental error. Maquenne and Demoussy determined the respiration correction by experiments in the dark, while Willstätter and Stoll reduced it to insignificance by working in very strong light and with ample supply of carbon dioxide, so that photosynthesis was twenty or thirty times stronger than respiration. Table 3.I gives a selection of their results together with those of some recent investigations, in which a different type of plant (lower algae) has been used instead of the higher land plants.

Table 3.I shows the remarkable constancy of the photosynthetic quotient—it is independent of light intensity, duration of illumination, temperature, and the concentrations of oxygen and carbon dioxide. Values slightly above 1 seem to predominate, although deviations from unity are hardly beyond the limits of experimental error. Table 3.I shows also that the *respiratory quotient*:

$$(3.2) \quad Q_R = \Delta CO_2 / -\Delta O_2$$

is close to unity for most plants (although its deviations from the normal value are more common than are those of the quotient Q_P). Very few significant cases of abnormal Q_P values have been found. Before discussing them, we may first inquire what the normal value, $Q_P = 1$, means for the chemical mechanism of photosynthesis. It finds a natural explanation in the assumption that the product of photosynthesis is a *carbohydrate*, *i. e.*, a compound with the atomic ratio $H : O = 2 : 1$. We can thus elaborate equation (2.4), by writing:

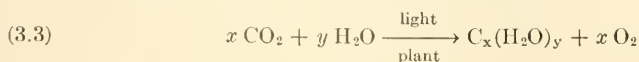

TABLE 3.I

THE PHOTOSYNTHETIC QUOTIENT ($Q_P = \Delta O_2 / - \Delta CO_2$) AND THE RESPIRATORY QUOTIENT ($Q_R = \Delta CO_2 / - \Delta O_2$)

Species	Observer ^a	Remarks	Q_P	Q_R
<i>Ailanthus</i>	M.D.		1.02	1.08
<i>Aspidistra</i>	M.D.		1.00	0.94
<i>Begonia</i>	M.D.		1.03	1.11
Cherry laurel	M.D.		0.97	1.03
Kidney bean (young)	M.D.		1.12	1.12
Pea	M.D.		1.00	1.07
<i>Ricinus</i>	M.D.		1.03	1.03
Sorrel	M.D.		1.04	1.04
Wheat	M.D.		1.02	1.03
AVERAGE (27 spp.):	M.D.		1.04	1.05
<i>Sambucus nigra</i>	W.St.	25° C., 5% CO ₂ , illuminated for 5 hrs., 45,000 lux	1.00-1.05	
	W.St.	Same after 12 hrs. in dark	0.98-1.02	
<i>Pelargonium zonale</i>	W.St.	25° C.; 2 hrs., 45,000 lux, low O ₂ (2%)	1.01-1.02	
	W.St.	Same after 3.5 hrs. in dark	1.01	
<i>Sambucus nigra</i>	W.St.	35° C., 45,000 lux, 6.5% CO ₂ , 4.5 hrs.	1.00-1.01	
<i>Aesculus hippocastanum</i>	W.St.	10° C., 45,000 lux, 6.5% CO ₂	0.99-1.02	
<i>Ilex aquifolium</i>	W.St.	Leathery leaves, $Q_P > 1$ according to Bonnier and Mangin	1.00	
<i>Leucobryum glaucum</i>	W.St.	Moss, 25° C., 5% CO ₂ , 22,000 lux	1.01	
<i>Hormidium flaccidum</i>	v.d.P.	Alga (green)	0.92-1.07	
<i>Chlorella pyrenoidosa</i>	M.S.D.D.	Green alga, low light	0.98 ^b	
<i>Nitzschia closterium</i>	B.	Diatom, high light, 12-31° C.	1.04 ± 0.03	0.93 ± 0.04
	B.	Same, low light, 12-28° C.	1.07 ± 0.02	
<i>Nitzschia palea</i>	B.	Diatom, high light	1.03 ± 0.03	0.79 ± 0.03
	B.	Same, low light	1.05 ± 0.02	

^a M.D. = Maquenne and Demoussy (1913); W.St. = Willstätter and Stoll (1918); v.d.P. = van der Paauw (1932); B. = Barker (1935); M.S.D.D. = Manning, Stauffer, Duggar and Daniels (1938).

^b Average of 18 single determinations of quantum yields of photosynthesis by simultaneous measurements of ΔCO_2 and ΔO_2 ; single values varying from 0.3 to 1.5.

In the same year, 1864, in which the correct value of the photosynthetic quotient was first determined by Bousingault, a direct proof of the formation of carbohydrates by photosynthesis was given by Sachs, who observed the growth of starch grains in the chloroplasts of photosynthesizing leaves. However, not all plants form starch after intense

photosynthesis—some do not form any visible deposits of reserve materials at all, while others store oils or proteins. Since the latter products are more strongly reduced than the carbohydrates, their formation by photosynthesis would require more hydrogen and lead to the liberation of more oxygen, than does the synthesis of carbohydrates. This would mean an increased value of the photosynthetic quotient. It is therefore important that Barker (1935) found a normal value of the photosynthetic quotient also in oil-storing diatoms (*cf.* Table 3.I), even in those which have an abnormally low value of the respiratory quotient (*Nitzschia palea*). This difference illustrates the fact, already stated in the first chapter, that photosynthesis is a universal process, taking the same course in all plants, while the reverse process of oxidation can proceed by many different paths. Whenever compounds other than polymerized carbohydrates (starch, inulin, cellulose) are stored in an organism, the symmetry of photosynthesis and respiration must needs be disturbed. Thus, plants (or animals feeding on carbohydrates) which accumulate fats, may have Q_R values above unity while the fats are formed, and below unity while they are consumed. Conversely, plants which store low-molecular organic acids or salts, (*e. g.*, oxalates, tartrates or citrates), often have Q_R values below unity during the deposition, and above unity during the consumption of these reserve materials. This is true, for example, of ripening fruits, and of succulents during the nightly accumulation of acids (*cf.* page 264).

Succulents (*e. g.*, *Cacti*) often have also *abnormally large photosynthetic quotients* (Aubert 1892); or, at least, they appear to be large if determined by the usual method of subtracting the gas exchange in the dark from the gas exchange in light. The quotient decreases, however, with prolonged illumination, as shown by Willstätter and Stoll (1918) in experiments with *Opuntia*. The change is associated with the gradual disappearance of organic acids, which these plants accumulate in darkness. This "deacidification" in light can be interpreted either as a *photooxidation*, producing free carbon dioxide, or as a *photoreduction*, converting the acids into carbohydrates. If the first hypothesis is correct, the high photosynthetic quotient is deceptive: the complete oxidation of acids of the type of malic acid produces more carbon dioxide than it consumes oxygen, and thus reduces the net carbon dioxide consumption from the atmosphere more than the net liberation of oxygen. If, however, the second hypothesis is correct, the high photosynthetic quotients are real, and the succulents carry out a "photosynthetic assimilation of organic acids" instead of, or in addition to, the usual photosynthetic assimilation of carbon dioxide. We will return to this problem in chapter 10.

Abnormal photosynthetic quotients are sometimes shown also by nonsucculent plants *at the start of illumination* after a period of darkness.

This was first noticed by Kostychev in 1921. During this so-called *induction period*, which, depending on specific conditions, can last for seconds, minutes or even hours, the photosynthetic quotient may be larger or smaller than unity; it may even become *negative*, that is, plants may consume (or liberate) both oxygen and carbon dioxide at the same time. These phenomena must be ascribed to the restoration of enzymatic systems and the regeneration of intermediate products, which have been destroyed during the dark interval (*cf.* Vol. II, Chapter 33).

Considering all known deviations of the photosynthetic quotient from unity, we see no reason to admit the steady photochemical production of compounds other than carbohydrates. However, the value $Q_P = 1$ does not preclude the formation of organic acids or other "underreduced" compounds as *intermediates* in photosynthesis. Willstätter and Stoll quoted the constancy of Q_P as an argument against Liebig's theory of photosynthesis, in which plant acids were supposed to *accumulate* by photosynthesis in summer, and to be slowly transformed into carbohydrates in fall. However, this objection does not avail against those modifications of Liebig's theory which assume that the plant acids are only passing intermediates in the transformation of carbon dioxide into carbohydrates. The observed value of Q_P proves that no underreduced (or overreduced) intermediate products accumulate during steady photosynthesis; but as long as these intermediates are consumed at the same rate as they are produced, their presence cannot affect the photosynthetic quotient (except during the induction period).

2. The Yield of Organic Matter

The photosynthetic quotient is the most easily measurable quantitative characteristic of photosynthesis. However, it is not sufficient to give a complete picture of the chemical reaction. It does not reveal the absolute value of x in eq. (3.3), or that of the ratio $x : y$. Thus, it does not allow one to identify the product of photosynthesis as a simple sugar ($x = y$) or as a polymer ($y < x$, *e. g.*, $y = 5/6 x$ for high polymers of hexoses). Furthermore, the photosynthetic quotient is not a very sensitive criterion of the exclusive production of carbohydrates. A deviation of Q_P by 3% from unity—which is well within the limits of error of most experiments—may mean the formation of as much as 12% of protein (Smith, 1943), or 5% of fats. This makes it important to use other and more direct methods for the determination of the chemical nature of the "photosynthate." Interesting information could be provided by the determination of the *amount of water* assimilated together with a known quantity of carbon dioxide, but this experiment encounters considerable difficulties, because of the abundant presence of water in all cells. *The determination of the total increase in organic matter*, caused by

the assimilation of a certain quantity of carbon dioxide, is easier; we remember that de Saussure used this method in 1804 to prove the participation of water in photosynthesis. Qualitatively, the proof was successful; but quantitatively, the two experiments performed by de Saussure disagreed. In the first of them, seven *Vinca* plants assimilated 314 mg. water together with 217 mg. carbon, corresponding to a molecular ratio $x : y = 1.03$; in the second, two *Mentha* plants assimilated 159 mg. water together with 159 mg. carbon, corresponding to $x : y = 1.50$. Similar experiments were carried out almost one hundred years later by Krashennikov (1901), who determined the total increase in the dry matter of illuminated detached leaves of five species, and the amount of absorbed carbon dioxide, and obtained $x : y$ ratios between 0.87 and 1.23. Bose (1924) compared the increase in dry weight and the oxygen production of several plants of *Hydrilla*, and obtained $x : y$ ratios of 0.92 or less. Smith (1943) made careful determinations of the carbon dioxide consumption and dry matter production by sunflower leaves, after illumination periods of the order of 1-3 hours. Table 3.II shows some typical results.

TABLE 3.II

CARBON ASSIMILATION AND INCREASE IN DRY WEIGHT OF SUNFLOWER LEAVES
(AFTER SMITH)

Expt. No.	ΔC , mg. carbon assimilated		ΔW , mg. (increase in dry weight)	$\Delta C/\Delta W$	
	Calcd. from ΔCO_2	Detd. by analysis		From ΔCO_2	By analysis
1	5.3	5.2	12.9	0.41	0.41
2	7.6	8.9	20.6	0.37	0.43
3	7.3	8.0	17.2	0.43	0.47
4	6.8	6.5	17.6	0.39	0.37
5	6.0	6.2	14.1	0.43	0.44
6	6.2	5.6	14.0	0.44	0.40
AVERAGE:				0.41	0.42

The average ratio $\Delta C/\Delta W$ (0.415), corresponds to $x : y = 1.06$ and thus agrees well with the theoretical ratio for a simple sugar (0.40, $x : y = 1.00$) and even better with that for a disaccharide (0.42, $x : y = 1.09$). In the leaf as a whole, the proportion of carbon is considerably larger than in the newly formed "photosynthate" (about 0.51 if referred to dry weight without ash).

The most satisfactory method of determining the nature of the products of photosynthesis is direct analysis. However, when Sapozhnikov (1890) first determined the difference between the carbohydrate

content of sunflower leaves kept in the dark, and that of similar leaves which had been exposed to light for 3-5 hours, and compared the amounts of synthesized carbohydrates with the quantities of carbon dioxide consumed by the illuminated leaves, he found "carbohydrate deficiencies" of 5-35%. Similarly, Krashennikov (1901) was able to identify as carbohydrates only 50-75% of the dry matter synthesized by the leaves of bamboo, cherry laurel, sugar cane, linden and tobacco. These results could be taken as indications of a rapid transformation of the primary product of photosynthesis into compounds other than carbohydrates; this conclusion was supported by the observation of Ruben, Hassid and Kamen (1939) who found that, after one hour of photosynthesis by barley leaves in radioactive carbon dioxide, only 25% of the assimilated radioactive carbon could be recovered in water-soluble carbohydrates, and not more than 10% in insoluble material (cellulose).

Smith (1943), on the other hand, was able to recover, in the form of carbohydrates, practically all carbon assimilated by sunflower leaves in illumination periods of 1-3 hours (*cf.* Table 3.III). According to this

TABLE 3.III
DETERMINATION OF CARBOHYDRATES IN THE PHOTOSYNTHATE
OF SUNFLOWER LEAVES (AFTER SMITH)

Number of experiments	Temp., °C.	Illumination duration, min.	Percentage of assimilated carbon found in						
			Mono-saccharides	Sucrose	Non-identified sugars	Starch	All soluble carbohydrates	In-soluble carbohydrates ^a	All carbohydrates
4	10	156	7	71	5	16	99	8	107 (±5)
7	20	58	10	52	3	26	91	7	98 (±3)

^a Assumed to have the elementary composition of cellulose.

table, more sucrose and less monosaccharides (and less starch) are obtained at 10° C. than at 20°. The proportion of monosaccharides may rise to as much as 35% if several hours of respiration in the dark are allowed to pass between illumination and analysis. (This amylolysis in the dark may be caused by water deficiency, *cf.* page 333).

The difference between the observations of Smith and those of the earlier investigators may be attributed to improved methods of analysis. However, the results may also depend on the plant species used and on the conditions of the experiment (duration and intensity of illumination, temperature, etc.). An explanation remains to be found for the failure of Ruben and coworkers to recover more than one quarter of assimilated radioactive carbon in the carbohydrates photosynthesized by barley leaves.

B. THE PRODUCTS OF PHOTOSYNTHESIS *

1. The Carbohydrates

Experiments described in the preceding section indicate that the direct products of photosynthesis belong to the class of carbohydrates. However, by the time when the quantity of the photosynthate becomes sufficient for chemical analysis, the carbohydrate fraction is found to contain a variety of compounds of different degree of polymerization, and it is unlikely that they all are the primary products of photosynthesis. Which of them, if any, is the primary product, is a moot question. Before presenting the arguments advanced on behalf of different contenders for this distinction, it seems advisable to give a short review of the structure and properties of the most common plant carbohydrates—pentoses, hexoses and their various polymers. For a detailed presentation of sugar chemistry, the reader is referred to the monographs by Pringsheim (1932), Bernhauer (1933), Armstrong and Armstrong (1934) and Micheel (1939).

(a) *Pentoses*

These C_5 sugars occur abundantly in many plants, usually not in the free soluble form, but as the so-called *pentosans*, *i. e.*, anhydrous compounds of the composition $(C_5H_8O_4)_x$. The pentosans are mostly found in the supporting structures—cell walls, wood fibers, etc., and are thus not directly associated with photosynthesis. However, they are more easily hydrolyzed than cellulose, and sometimes serve as reserve materials, thus coming into closer relation with nutritional processes.

Some authors, Nef (1910), for example, thought that the synthesis of pentoses must be independent of that of hexoses; others, as Löb and Pulvermacher (1910), suggested that pentoses are intermediates in the formation of hexoses. The production of starch from externally supplied pentoses (*cf.* page 260) indicates that plants contain enzymes capable of bringing about the conversion of pentoses into hexoses. On the other hand, it is known that pentoses can be produced by degradation of hexoses (by the intermediary of hexuronic acids). According to Spoehr, Smith, Strain and Milner (1940), albino maize plants provided with sucrose as the only source of carbon, produce uronic acids and pentosans from this food. This supports the opinion of those authors, including Ravenna (1911) and Tollens (1914), who believed that pentoses in plants are secondary products of transformation of the hexoses. The pentosans deposited in the cell walls and wood fibers must be produced there from products transported by the sap, which usually contains only glucose, fructose and sucrose (and no free pentoses).

* Bibliography, page 57.

(b) *Hexoses (Monosaccharides)*

Among the compounds of this group, *glucose* and *fructose* are most widely distributed in plants. They are found in the sap of practically all leaves (as first proved by Brown and Morris in 1893) in quantities which depend on species as well as on the previous treatment of the plant. Starvation may reduce their concentration to zero, while intense photosynthesis may raise it to 10 or 15% of the dry weight of the leaf. Free fructose is sometimes more abundant than free glucose; Brown and Morris (1893), for example, found in *Tropaeolum majus* leaves four times more fructose than glucose, and Gast (1917) found up to eight times more in leaves of five different species. Equal quantities of glucose and fructose are contained in cane sugar (sucrose), which is present in all green leaves, while the most common highly polymeric carbohydrates, starch and cellulose, are built entirely of glucose units, thus making the latter the most abundant single organic compound on earth.

It is often forgotten that the photosynthesis by higher plants is far inferior, in its yield, to the photosynthesis by the microscopic organisms of the plankton. The tendency to extend to the whole plant world conclusions reached in the study of the highly developed land plants, is not without its danger. It is therefore important to note that hexoses have been found also in many algae, although no systematic information about their distribution in those organisms is as yet available.

Hexoses other than glucose and fructose are rare in green plants. Clements (1932) was unable to find mannose in leaves of 42 species. Galactose is only encountered in the esterified form, as galactosides, or in condensation products with other sugars; while sorbose was definitely identified only in fruit juices.

Glucose (and other aldohexoses) act chemically as mixtures of three or four different tautomeric forms.

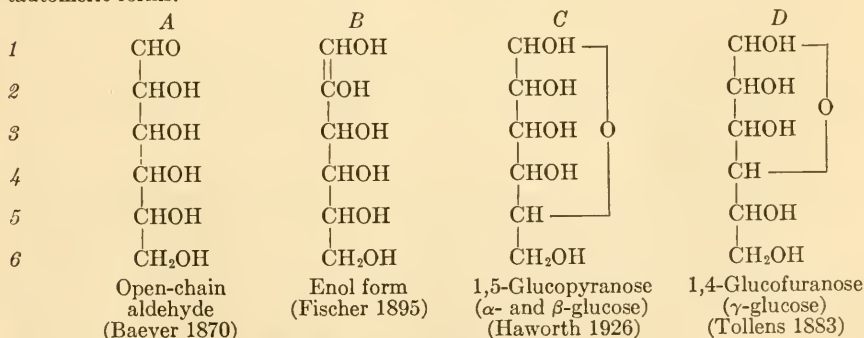

Formulae 3.I. Tautomers of Glucose

The most stable structure is the six-membered ring C. These formulae describe all aldohexoses; the particular spacial arrangements characterizing the α - and β -glucose

are best brought out by Haworth's prospective formulae:

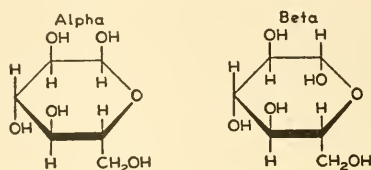

Formulae 3.II. α - and β -Glucose
(α - and β -glucopyranoses)

In β -glucose, all substituents are in trans-positions, which probably gives the lowest energy and highest stability.

Fructose is a 2-ketohexose, with the five possible structures:

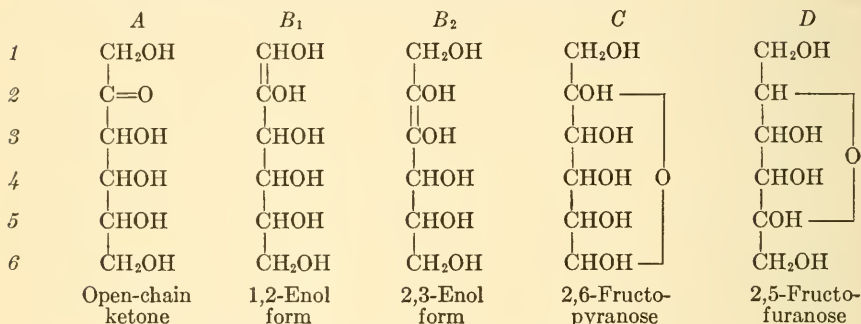

Formulae 3.III. Tautomers of Fructose

Of the two enols, B_1 is identical with the enol of glucose; this relation is responsible for the slow interconversion of glucose and fructose in alkaline solutions. The diphosphates of these two sugars also are identical, and this must be important for their interconversion in living plants.

In polymerization, glucose usually acts in the pyranoid form, whereas fructose more often enters into polymers in the form of a five-membered furanoid ring.

All hexoses in plants are optically active and belong to the *d*-series. This shows that asymmetric synthesis takes place in the course of the reduction of carbon dioxide, probably through the intervention of an asymmetric enzyme.

Mention must be made also of *inositols*, carbocyclic compounds which are isomeric with hexoses, (*cf.* Formula 3.IV), taste sweet and are included in the general classification of sugars under the name of "cycloses." Inositols are widely distributed in plants (particularly in seeds), and have been identified in leaves, *e. g.*, by H. Müller (1907), Tanret (1907) and Curtius and Franzen (1916) in quantities of about 0.05% of dry weight. Interesting is the *phytin*, a calcium-magnesium salt of inositol phosphate, $C_6H_6 \cdot [OPO(OH)_2]_6$, which was found in green leaves by Curtius and Franzen.

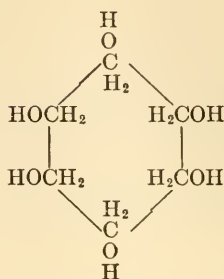

Formula 3.IV. Inositol

(c) Disaccharides

Glucose and fructose are the constituents of the most common dimeric and polymeric sugars. The relationships between these compounds are represented by the following scheme:

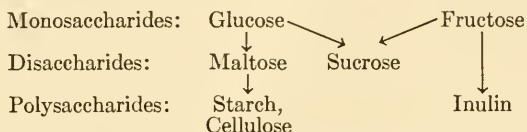

Sucrose is the most common disaccharide in green leaves; its concentration often exceeds that of the free hexoses (*cf.* Table 3.III). Sucrose is a product of condensation of one molecule of α -glucose in the pyranoid form and one molecule of fructose in the furanoid form:

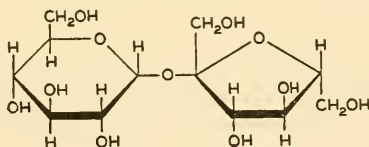
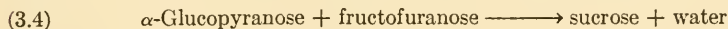

Formula 3.V. Sucrose

Since starch occurs regularly in a large proportion of leaves, one would also expect to find *maltose* which is an intermediate between starch and glucose. The molecule of maltose contains two glucopyranose units bound by an oxygen "bridge." Brown and Morris (1893) found 0.7–5.3% and Gast (1917) up to 1% maltose in *Tropaeolum* leaves; but Davis, Daish and Sawyer (1916) identified it as a product of hydrolysis of starch during the slow drying of the leaves. If leaves are killed rapidly, no maltose is found in them. Davis (1916) and Daish (1916) showed that leaves contain *maltase*, which hydrolyzes maltose to glucose, and attributed to this fact the absence of maltose in living leaves. However, the presence of *diastase*, which hydrolyzes starch, (*cf.* Brown

and Morris 1893, Sjöberg 1922) and of invertase, which splits sucrose into fructose and glucose (Robertson, Irvin and Dobson 1909), does not prevent leaves from containing large quantities of these polysaccharides. The relative quantities of different monosaccharides and polysaccharides in living plants must be determined by the rates of their formation and decomposition, which depend on the available quantities of different enzymes and the distribution of the latter in the tissue.

(d) *Polysaccharides*

Among the polysaccharides and their derivatives which occur in very large quantities in plants, some (for example the cellulose of the higher plants, and the alginic acid of algae) are too inert or too far removed from the site of photosynthetic activity, to be suspected of a direct relationship to photosynthesis. *Starch* is the only polymeric carbohydrate whose association with photosynthesis is evident. The occurrence of starch grains in chloroplasts, *i. e.*, plant organs primarily concerned with photosynthesis, has been known since 1837, when von Mohl first observed the chloroplasts under the microscope. Boehm (1856) confirmed that these grains consist of starch, by the well-known iodine color test. Gris (1857) noticed their growth during the day and dissolution during the night, and Sachs (1862, 1863, 1864) first postulated their direct association with photosynthesis. In a famous experiment, Sachs exposed one-half of a leaf to the sun and kept the other covered, and showed that after some time only the exposed half gave the color reaction with iodine. Pfeffer (1873) and Godlewski (1877) completed the proof by showing that no starch is formed by leaves illuminated in absence of carbon dioxide.

As mentioned above, starch is a high polymeric form of glucose; it contains, in the native state, a small proportion of phosphoric acid (about 0.1% P_2O_5) which is probably important for its enzymatic transformations. As in maltose, the α -glucose molecules in starch are bound together by oxygen bridges:

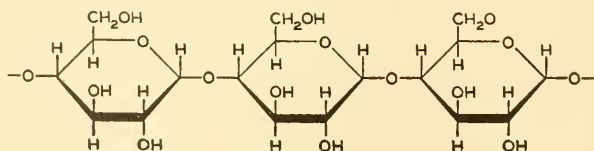

Formula 3.VI. *Starch*

A similar chain of β -glucose molecules forms the basis of the structure of *cellulose*.

Most of our knowledge of starch has been derived from the study of storage materials in seeds, tubers and roots; recently the preparation and

properties of *leaf starch* have been described by Spoehr and Milner (1935, 1936).

Grafe and Vouk (1912, 1913) and Melchior (1924) found that in some plants *inulin* replaces starch. Inulin is a polymer of *fructose*, constructed from fructofuranose units, in the same way that starch is built up from glucopyranose units. Varied reserve materials are encountered in algae. *Starch* is found in green and red algae (*Chlorophyceae* and *Rhodophyceae*); and *glycogen* (a form of starch common in animals) in blue-green algae (*Cyanophyceae*). Brown algae (*Phaeophyceae*) store pentosans and fucosans.

2. The Photosynthetic Formation of Oils and Proteins

All storage materials mentioned so far were carbohydrates. However, many algae, particularly the diatoms (*Bacillariophyceae*), but also some green algae (*Vaucheria*), store *oils* or *fats* instead of carbohydrates (Beijerinck 1904). In addition, the chromoplasts of most algae contain so-called *pyrenoids*, peculiarly shaped bodies (*cf.* page 357), usually considered as masses of reserve proteins surrounded by starch sheaths.

It has sometimes been suggested that these reserve materials may represent the direct products of photosynthesis in algae. Bond (1932) thought for example that diatoms may produce fats directly by photosynthesis, according to the equation:

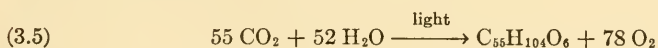

However, we have seen (page 34) that the photosynthetic quotient of an oil-storing diatom was found to be not larger than 1.05, while equation (3.5) would require a value of 1.42. Thus, the oil deposits of the diatoms—and probably the fat and protein stores of other algae as well—must be considered as products of comparatively slow secondary transformations not directly associated with photosynthesis.

Oily drops have been observed not only in algae, but also in the leaves of some higher plants. Briosi (1873) suggested that these drops are produced directly by photosynthesis; however, his conclusions were criticized by Holle (1877) and Godlewski (1877).

Meyer (1917) observed, in illuminated leaves of *Tropaeolum majus* the temporary formation of what he described as “droplets of an assimilatory secretion.” Later (1918) he suggested that oil drops formed in some green algae (*e. g.*, *Vaucheria terrestra*) are of a similar nature, and proposed that this “assimilatory secretion” be considered as an immediate product of photosynthesis. From observations of its chemical behavior (1917²), he concluded that it is not a fat, but may possibly consist of *hexenaldehyde*, a compound whose presence in green leaves

was at that time investigated by Curtius and Franzen (*cf.* page 252). Hexenaldehyde has the formula $C_6H_{10}O$, and its formation by photosynthesis should lead to a photosynthetic quotient of 1.33. In addition to this high photosynthetic quotient, not confirmed by experiments, two other arguments speak against Meyer's interpretation. In the first place, the quantity of hexenic aldehyde, found by Curtius and Franzen, is much too small to account for the large volume of Meyer's "photosynthetic secretion." In the second place, even this small quantity has recently been proved to be of a secondary origin, being apparently formed during the steam distillation of the leaf material (page 254). It seems probable that Meyer's "oil drops" were the so-called "grana," whose occurrence in chloroplasts was first postulated by Meyer himself in 1883 and recently confirmed by many other observers (*cf.* Chapter 14).

3. The First Products of Photosynthesis and Their Transformations

Having satisfied ourselves that no direct photochemical formation of fats or proteins needs to be postulated on the basis of available experimental material, we may now return to the problem of the "first carbohydrate," mentioned on page 38. This role has variously been claimed for glucose, sucrose, inositol and starch, usually on the basis of experiments on the absolute and relative concentrations of these carbohydrates in plants at different times of the day and season of the year. Both the concentration of soluble sugars in the cell sap and the quantity of solid starch in the chloroplasts, undergo wide variations with the intensity of photosynthesis. They may be reduced to zero by starvation, and can rise to 20 or 30% of the total dry weight after a period of intense photosynthesis, particularly if translocation is interrupted, as in detached leaves. Brown and Morris (1893) found, in the leaves of *Tropaeolum majus* attached to the plant, 9.7% sugars and 1.2% starch at 5 A.M. and 9.6% sugars and 4.6% starch at 5 P.M.; but if the leaves were detached at 5 A.M. and left in sunlight until 5 P.M., the concentration of sugars increased to 17.2%, while that of starch was 3.9%.

Numerous authors have determined the relative quantities of glucose, fructose, and sucrose in leaves, and the changes in these ratios caused by starvation and illumination; and several of them, *e. g.* Perrey (1882), Brown and Morris (1893), Parkin (1911), Mason (1916), Davis, Daish and Sawyer (1916), Davis and Sawyer (1916), Gast (1917), and Venezia (1938) have arrived at the conclusion that the disaccharide *sucrose* precedes the monosaccharides in the order of synthesis. They based this conclusion either on the more widespread occurrence and larger absolute quantity of sucrose in leaves, or on the observation that the concentration of sucrose follows more closely the diurnal cycle of photosynthesis.

However, the primary formation of a disaccharide seems implausible *a priori*, and authors who argued in its favor, have neglected the rapidity with which the primary product of photosynthesis may undergo enzymatic isomerizations and polymerizations in leaves which are equipped with invertase, diastase, maltase and other carbohydrate-transforming enzymes. Priestley (1924), Stiles (1925), Spoehr (1926), and Barton-Right and Pratt (1930) stressed the fact that the way in which the leaves are killed (by freezing, drying, boiling, or immersion into alcohol) affects the analytical results, thus proving that extensive enzymatic transformations can take place even during the preparation of the material. Dixon and Mason (1916), Priestley (1924) and Spoehr (1926) pointed out that a mechanism for rapid enzymatic conversion of primary products (*e. g.*, hexoses) into storage materials (and sucrose may be a soluble storage material) can keep the concentration of the primary products approximately constant, while that of the storage materials rises and falls with the intensity of photosynthesis. Contrary to the experimental results of the above-mentioned investigators, others—notably Weevers (1924), Tottingham, Lepkovsky, Schulz and Link (1926), Clements (1930), Barton-Right and Pratt (1930) and Kretovich (1935)—have obtained analytical evidence favoring the conclusion that the monosaccharides precede the more complex sugars in organic synthesis. Weevers (1924), for example, found both glucose and sucrose in the green (*i. e.*, photosynthetically active) spots of variegated leaves, and only sucrose in the yellow spots. The same author observed that when a leaf of *Pelargonium* was deprived of all its sugars by starvation for 48 hours, the first sugar to appear upon illumination was glucose, which was only later followed by sucrose and starch. Clements (1930) and Barton-Right and Pratt (1930) found by hourly analyses extending from sunrise to sunset, that glucose predominates in leaves early in the morning, while sucrose begins to accumulate (and often surpasses glucose in concentration) later in the day. These experiments support the plausible assumption that disaccharides are secondary products formed by condensation of simple hexoses. On the other hand, Smith (1944) has again found, in extending to several hours the duration of his experiments on the fate of carbon assimilated in sunflower leaves (*cf.* page 37), that sucrose (and starch) are formed immediately upon the beginning of illumination, while the relative quantity of monosaccharides is at first very small, and increases with time (*e. g.*, from 4% of total carbohydrates after 27 minutes of illumination to 22% after 146 minutes). He concluded that the primary product of photosynthesis is a common precursor of sucrose and starch (perhaps a hexose monophosphate), and suggested that the free monosaccharides found in the cell sap are secondary products, formed by the hydrolysis of sucrose.

There does not seem to be any basis for arguing whether fructose and glucose are independent products, or whether one is a "primary" and the other a "secondary" sugar. Some leaves contain more free glucose, others more free fructose; while glucose usually predominates in the polymeric carbohydrates. Endo (1936) found only glucose in some green algae (*Codium latum*), and only fructose in others (*Cladophora Wrightiana*). *In vitro*, glucose, fructose and mannose are interconvertible in alkaline solutions (the so-called Lobry de Bruin-van Eckenstein reaction). This conversion, which is supposed to proceed through the intermediary of the enols B₁ and B₂ (Formula 3.III), inevitably produces a certain proportion of mannose. The leaf cells are not alkaline, but neutral or acid; and the leaves apparently contain no mannose (page 39). These facts have been used as arguments against the glucose-fructose interconversion in the leaves. However, Spoehr and Strain (1929) showed that in presence of sodium phosphate the interconversion can be achieved, *in vitro*, also in neutral or even slightly acid solution. Fructose, kept at 37° C. in slightly acid Na₂HPO₄ solution (pH 6.7) was found to contain, after 165 hours, 8.5% mannose and 28% glucose.

An enzyme (isomerase) is known which converts glucose monophosphate into fructose monophosphate; while the diphosphates of these two sugars are identical. Thus, the interconversion in living plants probably occurs by a combination of phosphatization with the action of specific enzymes.

In addition to glucose and fructose, the distinction of being the first C₆ products of photosynthesis was claimed also for the *inositols*. Crato (1892) and Kögel (1919) suggested that these cyclic compounds, consisting entirely of HCOH groups, are the parent substances of all other sugars in plants. Gardner (1943) suggested that the first carbohydrate formed by photosynthesis may be the triose, *glyceraldehyde*; but the only basis for this hypothesis was that trioses are the last carbohydrates which occur in respiration (*cf.* Chapter 9, page 223).

If it is implausible that disaccharides could precede monosaccharides in the synthesis of carbohydrates, it is, *a fortiori*, even less probable that *starch* could be formed directly by photosynthesis (as has occasionally been suggested, *e. g.*, by Baly). True, one could conceive of a mecha-

nism of photosynthesis in which new —CHOH links would be added to a chain, growing from some "carrier" molecule, and hexoses and other simple sugars would be produced by an enzymatic breakdown of these chains only after they have grown to a considerable length. It is, however, unlikely that this hypothetical intermediate long-chain product should be identical with leaf starch. The prevailing opinion is that the latter is only a temporary storage product, deposited in the chloroplasts during intense photosynthesis, when more sugar is formed than can be removed by translocation. Sapozhnikov (1889, 1890, 1891, 1893) found that detached leaves of *Vitis vinifera* and *V. labrusca* can accumulate up to 25–50% dry weight in starch before becoming "choked" with this product. According to Winkler (1898) the formation of starch grains sets in when the concentration of glucose exceeds 0.2%, and reaches a maximum at 10% glucose in the leaf sap.

In addition to "common-sense" arguments against the direct formation of starch by photosynthesis, the fact that many plants do not contain any leaf starch at all, also favors this conclusion. It has been known since Meyer (1885) that starch is less common in the leaves of the monocotyledons, than in those of the dicotyledons. Another argument in favor of starch formation as a secondary process which is not a part of photosynthesis proper, is the capacity of plants to convert artificially supplied sugars (or similar compounds) into starch, without the help of light.

The starch synthesis and starch dissolution (amylolysis) in leaves must be considered a part of the "second stage" of plant nutrition, which follows photosynthesis proper. Important advances in this field have become possible by the successful enzymatic synthesis of glycogen from glucose phosphate by Cori and coworkers. However, it would lead us too far to enter here into this complex matter. Spoehr and Milner (1939) have studied the effects of oxygen, carbon dioxide, water and temperature on the rate of dissolution of starch amylolysis *in vivo*. (These effects are important for photosynthesis because they influence the mechanism by which the stomata of the higher plants are opened and closed, thus regulating the supply of carbon dioxide to the chloroplasts, *cf.* page 334.) Spoehr and coworkers (1940) also initiated a study of the organic nutrition of albino plants to establish the food requirements of plants which have been denied the possibility of preparing their own food from the air. Obviously, studies of this kind can indirectly help in the identification of the first product of photosynthesis. Glucose and other sugars *can* supply the plants with all their food requirements (except for nitrogen and mineral elements assimilated through the roots), so that the formation of hexoses constitutes an entirely *sufficient* interpretation of the over-all reaction of photosynthesis; but whether it is also the *minimum* possible explanation, is another question.

At the present stage of our knowledge, all processes from the moment of the entrance of carbon dioxide into the plant to the completion of sugar synthesis must be included into the "over-all reaction of photosynthesis," which thus becomes

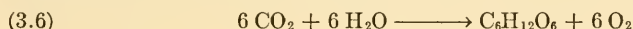

We will often use the abbreviated equation

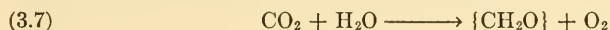

where $\{\text{CH}_2\text{O}\}$ stands for a generalized link in a carbohydrate chain.

C. THE ENERGY OF PHOTOSYNTHESIS *

From the time of Robert Mayer, it was known that photosynthesis converts light into chemical energy. The energy stored in this way is equal to the heat of combustion of the primary products of photosynthesis. In the first approximation, the heat of combustion of organic compounds containing carbon, hydrogen and oxygen, depends only on their *level of*

* Bibliography, page 59.

reduction (cf. Chapter 9). Table 3.IV shows how rapidly the heats of combustion rise with the progress of reduction. Photosynthesis lifts the stable "food" of the plants, $\text{CO}_2 + \text{H}_2\text{O}$, to the carbohydrate level, as indicated by the arrow on the left side of table 3.IV. Starting from this

TABLE 3.IV
THE FOUR REDUCTION LEVELS OF CARBON DIOXIDE

Reduction stage	Number of bonds				Heat of combustion (in the gaseous state) to H_2O (liq.) and CO_2 (gas) ΔH_c , kcal/mole
	C—O	O—O	C—H	O—H	
1. Carbon dioxide $\text{CO}_2 + 2 \text{H}_2\text{O}$	4	0	0	4	0
2. Formic acid $\text{HCOOH} + 1\frac{1}{2} \text{H}_2\text{O} + \frac{1}{2} \text{O}_2$	3	1	1	3	74
3. Formaldehyde $\text{CH}_2\text{O} + \text{H}_2\text{O} + \text{O}_2$	2	2	2	2	134
4. Methanol $\text{CH}_3\text{OH} + \frac{1}{2} \text{H}_2\text{O} + 1\frac{1}{2} \text{O}_2$	1	3	3	1	183
5. Methane $\text{CH}_4 + 2 \text{O}_2$	0	4	4	0	211

level, the plants produce compounds whose energy content is higher than that of the carbohydrates (*e. g.*, alcohols and fats) without further supply of external energy, by *dismutations*, that is, reactions in which one part of the carbohydrates is oxidized enabling another part to be reduced.

If *formaldehyde* were the first product of photosynthesis (as suggested by Baeyer in 1870), the heat effect of this process would be close to 135 kcal per gram atom of assimilated carbon. However, the "formaldehyde hypothesis" has never been proved and is now considered improbable (cf. Chapter 10). Whether photosynthesis involves the formation of another reduction intermediate with an energy content as high as that of formaldehyde is unknown. The same can be said of the often postulated formation of a *peroxide* as precursor of free oxygen (cf. Chapter 11), which would add approximately another 45 kcal to the chemical energy accumulated in the first stage of photosynthesis. If both an unstable aldehyde and an unstable peroxide were among the immediate products of photosynthesis, the true heat effect of this process would be as high as 180 kcal per mole of reduced carbon dioxide. However, by the time the synthesis reaches an analytically recognizable stage—that of sugar and oxygen—the energy accumulation has been stabilized at about 112 kcal per mole. As shown by table 3.V, this value does not depend greatly on the exact nature of the "first sugar." Formaldehyde is less stable by about 23 kcal than an HCOH link in a long-chain carbohydrate; when we pass from this "monose" to a "biose" (glycolaldehyde), and further to "trioses" (for example, glyceraldehyde), tetroses, pentoses and

TABLE 3.V

ENERGIES (ΔH_c) AND FREE ENERGIES (ΔF_c) OF COMBUSTION OF CARBOHYDRATES TO LIQUID H₂O AND CO₂ GAS, AT 25° C.

Compound	Formula	State	- ΔH_c , kcal per gram atom carbon	Observer ^a	- ΔF_c per gram atom C	
					to H ₂ O (l.), CO ₂ (1 atm.) ^b	to H ₂ O (l.), CO ₂ (3 × 10 ⁻⁴ atm.)
Formaldehyde	HCHO	gas	134.1	W.L.	124.6	129.4
Formaldehyde, 1 M/l.	(HCHO) _{aq.}	solution			119.7	124.5
Para-formaldehyde	(HCHO) _n	solid	122.1	D.; W.M.R.		
Glyceraldehyde	C ₃ H ₆ O ₃	solid	112.7	N.H.J.		
Arabinose	C ₅ H ₁₀ O ₅	solid	112.0	K.F.		
Xylose	C ₅ H ₁₀ O ₅	solid	112.1	K.F.		
α -Glucose	C ₆ H ₁₂ O ₆	solid	112.3	S.K.L.; K.F.	115.1	119.9
α -Glucose, 1 M/l.	(C ₆ H ₁₂ O ₆) _{aq.}	solution			114.8	119.6
Fructose	C ₆ H ₁₂ O ₆	solid	112.6	S.L.		
			111.8	E.B.		
Galactose	C ₆ H ₁₂ O ₆	solid	111.7	K.F.		
Sucrose	C ₁₂ H ₂₂ O ₁₁	solid	112.5	V.K.	115.0	119.8
				V.F.		
Maltose	C ₁₂ H ₂₂ O ₁₁	solid	112.3	K.N.N.W.		
Starch	(C ₆ H ₁₀ O ₅) _n	solid	112.8	S.L.		
Cellulose	(C ₆ H ₁₀ O ₅) _n	solid	112.9	S.L.		
Inulin	(C ₆ H ₁₀ O ₅) _n	solid	113.1	K.F.		

^a D. = Delépine (1897), E.B. = Emery and Benedict (1911), K.F. = Karrer and Fioroni (1923), K.N.N.W. = Karrer, Nägeli, Hurwitz, Wälti (1921), N.H.J. = Neuberger, Hoffmann, Jacoby (1931), S.K.L. = Stohmann, Kleber, Langbein (1890), S.L. = Stohmann, Langbein (1892), V.K. = Verkade, Koops (1923), W.L. = v. Wartenberg, Lerner-Steinberg (1925), and W.M.R. = v. Wartenberg, Muchlewski, Riedler (1924).

^b Figures from G. S. Parks and H. M. Huffman, *The Free Energies of Some Organic Compounds*.

hexoses, the comparatively high energy of the keto group is rapidly "diluted" by the lower energies of the alcoholic groups, until a limiting value of about 112 kcal per link is reached. (The heats of combustion of the inositols, the only compounds consisting entirely of HCOH groups, have not yet been determined.)

The standard bond energy table (*cf.* Table 9.II) shows that the endothermal character of photosynthesis has a double origin. In the first place, the C—H bond is less stable (by 12 kcal) than the O—H bond, so that the hydrogen atoms have to be transferred, in photosynthesis, from a stronger to a weaker bond. In the second place, the C=O double bond in carbon dioxide (which has to be "opened" in photosynthesis) is more stable (by as much as 72 kcal) than the O=O double bond formed in this process. The weakness of the O=O double bond is the most important cause of the tendency of most elements for

oxidation, and of the difficulty of reversing this oxidation and expelling oxygen from oxides or organic oxygen compounds.

The values of ΔF_c in the last two columns of table 3.V, serve to illustrate the statement, made in chapter 1 (page 3) that the *increase in free energy* in photosynthesis is even larger than the increase in total energy, particularly if ΔF is calculated not for the "standard" pressure of one atmosphere, but for the actual partial pressure of carbon dioxide in the air, 3×10^{-4} atm. (Only for formaldehyde vapor ΔF_c is *smaller* than ΔH_c , because in this case *two gases*, H_2CO and O_2 , are converted into *one gas*, CO_2 , and a liquid, H_2O , thus decreasing the molecular disorder.)

Of course, an increase in free energy is possible only because photosynthesis is not a *spontaneous* process in a closed system, but a *photochemical* reaction, maintained by a continuous supply of light energy (to make the system complete, the sun should be included in it).

To sum up, table 3.V makes it probable that photosynthesis proceeds with an accumulation of at least 112 kcal per mole of reduced carbon dioxide:

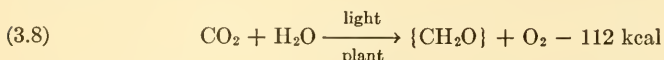

and, in the free atmosphere, with an increase in *free energy* by about 120 kcal per mole.

In thermochemical equations, we will conform to the usage and designate the *absorbed* energy by a minus sign, and the *released* energy, by a plus sign. On the other hand, the heat effect ΔH of a reaction shall be considered as positive for endothermal and negative for exothermal reactions, in accordance with the notation of Lewis and Randall. In other words, the figure -112 kcal in equation (3.8) represents *minus* ΔH_c .

The *efficiency* of photosynthesis as an energy-converting process depends on the amount of light required for the reduction of one mole of the substrate. Much study has been devoted to this problem (which will be discussed in Vol. II, Chapters 28 and 29). Anticipating the results we can state that the average conversion yield in direct sunlight is of the order of 3% of the *absorbed* light energy, or 2% of the *incident* visible light; but in weak light and in presence of ample carbon dioxide it may rise to as much as 30%. This indicates that the low energy conversion observed under natural conditions is caused by a limited capacity of the photosynthetic apparatus and consequent dissipation of energy absorbed in excess of this capacity, rather than by an obligatory utilization of a large part of light energy for the *activation* of the chemical process of photosynthesis. Fundamentally, the photosynthetic mechanism is capable of converting light into chemical energy with an efficiency of not less than 30%, and perhaps more. This is a much higher efficiency than has ever been achieved in photochemical processes in the laboratory (except for reactions which take place only in ultraviolet light).

An even more striking characteristic of photosynthesis has been claimed by Spessard (1940), who asserted that photosynthesis results in "conversion of light into matter." His experiments purported to show that a sealed vessel containing photosynthesizing plants increases in weight with the progress of photosynthesis, and certainly will receive a less spectacular explanation.

D. PHOTOSYNTHESIS AS A SENSITIZED OXIDATION-REDUCTION *

After having described the over-all chemical reaction of normal photosynthesis by equations (3.6) and (3.7), we will now assign to this reaction its proper place in the general classification of chemical reactions, by identifying it as a *sensitized photochemical oxidation-reduction*.

When the first light was thrown on the chemistry of photosynthesis by the investigations of Ingen-Housz and Senebier, it appeared as "decomposition of fixed air" (*i. e.*, carbon dioxide) with the oxygen escaping into the air, and carbon retained by the plants. Even when de Saussure in 1804 added water to the reaction components, he did not doubt that all oxygen liberated in photosynthesis was the product of decomposition of carbon dioxide, while the role of water was vaguely described as "contributing its elements" to the formation of organic matter. Later, the "decomposition" of carbon dioxide was generally recognized as a *reduction* of this compound, and different paths of reduction were devised, *e. g.*, by Liebig (1843) and Baeyer (1870). According to Liebig, the *plant acids*—oxalic, malic, succinic, tartaric—are the main intermediates in the reduction of carbon dioxide to carbohydrates; while according to Baeyer, formic acid and formaldehyde are the two main stepping stones in this reduction. The question of the way in which *water* participates in the reduction was left aside by both authors.

However, some chemists have looked on photosynthesis from a different angle. As early as 1864, Berthelot suggested that water is decomposed by photosynthesis into hydrogen and oxygen, while carbon dioxide is dissociated into carbon monoxide and oxygen, after which the two products unite to form a carbohydrate,



Although this theory was vague, it clearly made both carbon dioxide and water subjects of primary transformations in photosynthesis. Fifty years later, Bredig (1914) and Hofmann and Schumpelt (1916) turned the spotlights entirely on the transformation of *water*. They suggested that the primary effect of light in photosynthesis is the *decomposition of water into oxygen and hydrogen*. The former escapes into the atmosphere, while the latter reduces carbon dioxide to the carbohydrate level (by a secondary process, not specifically defined).

* Bibliography, page 60.

Willstätter and Stoll (1918) were opposed to concepts of this kind. They thought that the exact equivalence between the consumption of carbon dioxide and the evolution of oxygen can be understood only if one assumes that oxygen originates in the *decomposition of carbon dioxide*, or, since water has to be given a place in the scheme, in the *decomposition of carbonic acid*:



These three schemes of photosynthesis: (a) *decomposition of carbon dioxide* (with a subsequent reaction of one of the products with water); (b) *decomposition of water* (with a secondary reaction between one of the products and carbon dioxide); and (c) *decomposition of carbonic acid* (after a preliminary combination of CO_2 and H_2O to H_2CO_3), have been widely used in the literature; but it was some time before it became clear that all three of them implied, without telling it in so many words, that photosynthesis is an *oxidation-reduction reaction between carbon dioxide and water*. That photosynthesis is a *reduction of carbon dioxide*, was generally acknowledged; but that reduction presupposes a *reductant* and that in photosynthesis the only possible reductant is *water* (which is oxidized to oxygen) was ignored. It seemed strange to call "oxidation" a process in which free oxygen is produced; but the removal of hydrogen from the water molecule *is* oxidation by any general definition of this term. In the above-mentioned scheme (a), carbon dioxide is reduced to carbon, and the latter "hydrated" by water, a process which seems to imply no oxidation at all. In scheme (c), of Willstätter and Stoll, neither the hydration of carbon dioxide to carbonic acid, nor the decomposition of carbonic acid into formaldehyde and oxygen, seems to bear the character of oxidation-reduction. However, both the "hydration" of C to H_2CO and the "decomposition" of H_2CO_3 into H_2CO and O_2 , involve *transfers of hydrogen atoms from oxygen to carbon*, and this is the mark of an oxidation-reduction, even if the transfer occurs *intramolecularly*, *i. e.*, between two atoms belonging to the same molecule, and not *intermolecularly*, as in typical oxidation-reduction reactions. To say that photosynthesis is an oxidation-reduction reaction between water and carbon dioxide, is not to suggest an *hypothesis*, but to make a *statement of fact*.

In recent years, the mechanisms of many biological oxidation-reductions have been elucidated, and the transfer of *hydrogen atoms* (or electrons, *cf.* page 219) from molecule to molecule, has emerged as the most important elementary act in these processes. Thus Wieland (1913, 1914) explained respiration as the transfer of hydrogen atoms from a substrate (glucose, for instance) to oxygen; and Kluver and Donker (1926) and

Kluyver (1930) interpreted different anaerobic fermentations as similar transfers of hydrogen to acceptors other than oxygen.

The hypothesis that photosynthesis can be placed alongside with other biological oxidation-reductions and interpreted as an *intermolecular exchange of hydrogen atoms* between water and carbon dioxide, was first discussed by Thunberg (1923), but the credit for its clear formulation, based on the analysis of the metabolism of sulfur bacteria (which will be discussed in chapter V), belongs to van Niel (1931). Starting from Kluyver and Donker's generalization of Wieland's ideas, van Niel proclaimed photosynthesis to be a hydrogen transfer from water to carbon dioxide in the higher plants, and from other hydrogen "donors" to carbon dioxide in bacteria.

In spontaneous metabolic processes, the transfer of hydrogen atoms (or electrons) always occurs "downhill," that is, in the direction of decreasing oxidation-reduction potentials. The substance with higher (more positive) potential yields its hydrogen to the substance with the lower (more negative) potential. In photosynthesis, which is the reverse of respiration, the hydrogen atoms must be moved "uphill," from a system with a lower potential— O_2/H_2O —to the system with a higher potential— $CO_2/\{CH_2O\}$ —light being relied upon to give the necessary "push."

The reduction of carbon dioxide to the carbohydrate level requires the hydrogenation of two $C=O$ double bonds, and thus the transfer of *four* hydrogen atoms:

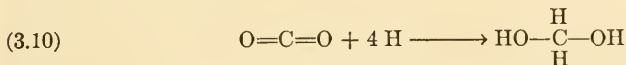

The primary product of photosynthesis, according to (3.10) is *formaldehyde hydrate*. However, van Niel's theory does not *require* the formation of this compound as an intermediate in photosynthesis, since it can equally well be applied to the reduction of a larger molecule (*e. g.*, of a carboxylic acid, $R \cdot COOH$), into which CO_2 has been incorporated in a preliminary reaction step.

The four hydrogen atoms required in (3.10) can be provided by either *two* or *four* water molecules:

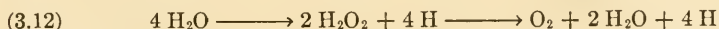
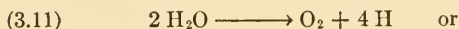

The *over-all reaction* of normal photosynthesis becomes, with (3.11):

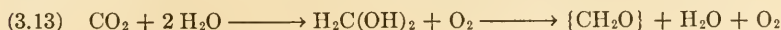

and with (3.12):

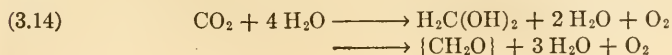

We prefer the second alternative, because the probability of one water molecule losing both its hydrogen atoms in succession seems to be smaller than that of two different water molecules contributing one hydrogen atom each (and the remaining hydroxyl radicals reacting to water and oxygen). One of the two water molecules which enter reaction (3.13), and three of the four which enter reaction (3.14), are recovered at the end, and could be cancelled out in the equations, if it were not desirable to underline that hydrogen atoms from several water molecules participate in the reduction of one molecule of carbon dioxide.

If we add the "intermolecular hydrogen transfer" theory as scheme (d) to the three schemes listed on page 52, and consider the origin of oxygen according to all four of them, we find that only the oldest scheme, (a), suggests that all oxygen comes from *carbon dioxide*; schemes (b) and (d) predict that all of it should come from *water*; while according to scheme (c), one part of oxygen must come from carbon dioxide and another part from water. The last conclusion is based on the consideration that, since the two hydroxyl groups in H_2CO_3 are equivalent, they must contribute equally to the production of oxygen. After the hydration

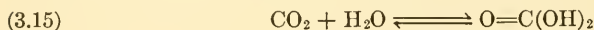

one-half the oxygen atoms in the hydroxyl groups have their origin in water and one-half in carbon dioxide. If the hydration is followed immediately by decomposition into H_2CO and O_2 , the proportion of oxygen which originated in water can be one-half (if all oxygen comes from the hydroxyl groups), one-third (if all three O atoms in H_2CO_3 contribute equally to the formation of oxygen), or one-fourth (if one oxygen atom in O_2 must come from the $\text{C}=\text{O}$ group). However, reaction (3.15) is, usually, not a single transformation, but a series of repeated hydrations and dehydrations, and as a result the ratio of oxygen atoms in H_2CO_3 which originally belonged to water or carbon dioxide, gradually approaches the ratio of these atoms in all available molecules of these two compounds. Since water is present in large excess, practically *all* oxygen atoms in H_2CO_3 will ultimately be contributed by water. However, the hydration and dehydration of carbon dioxide are *slow* reactions (*cf.* Chapter 8, page 175) and since plants apparently do not contain the enzyme (carbonic anhydrase) which accelerates them (*cf.* Chapter 15, page 380), the equilibration of CO_2 and H_2CO_3 takes a measurable time, and the contribution of carbon dioxide to the oxygen production according to scheme (c) must only gradually drop from an initial maximum ($\frac{3}{4}$, $\frac{2}{3}$, or $\frac{1}{2}$) to zero.

The existence of a heavy isotope of oxygen, O^{18} , made possible a direct check of these predictions—a striking example of the possibilities inherent in the method of "isotopic tracers." Ruben, Randall, Kamen and Hyde

(1941) introduced heavy oxygen (O^{18}) into the carbon dioxide and water used for photosynthesis of *Chlorella*, and determined the concentration of the heavy isotope in the liberated oxygen. The results are given in table 3.VI. It shows that the proportion of O^{18} in oxygen is under all

TABLE 3.VI
ISOTOPIC RATIO IN OXYGEN EVOLVED IN PHOTOSYNTHESIS BY CHLORELLA ^a
(AFTER RUBEN, RANDALL, KAMEN AND HYDE)

Expt. No.	Substrate	Time between dissolving $KHCO_3 + K_2CO_3$ and start of O_2 collection, min.	Time at end of O_2 collection, min.	Per cent O^{18} in		
				H_2O	$HCO_3^- + CO_3^-$	O_2
1	$KHCO_3, 0.09 M$ $K_2CO_3, 0.09 M$	0		0.85	0.20	..
		45	110	0.85	0.41 ^b	0.84
		110	225	0.85	0.55 ^b	0.85
		225	350	0.85	0.61	0.86
2	$KHCO_3, 0.14 M$ $K_2CO_3, 0.06 M$	0		0.20		..
		40	110	0.20	0.50	0.20
		110	185	0.20	0.40	0.20
3	$KHCO_3, 0.06 M$ $K_2CO_3, 0.14 M$	0		0.20	0.68	..
		10	50	0.20		0.21
		50	165	0.20	0.57	0.20

^a The volume of evolved oxygen was large compared with the amount of atmospheric oxygen present at the beginning of the experiment.

^b Calculated values.

circumstances equal to its proportion in water, and independent of its concentration in the carbonate—thus disproving the hypotheses (a) and (c). As each experiment progresses, the isotopic exchange between carbon dioxide and water, brought about by reaction (3.15), tends to equalize the isotope distributions in the two reaction components; but since the concentration of HCO_3^- is high and that of CO_2 low (*cf.* page 178), the equalization proceeds slowly and several collections of oxygen can be made before its completion. In chapter 26 (Volume II), we will encounter an additional quantitative argument against Willstätter and Stoll's scheme (c)—the inability of the hydration reaction (3.15) to keep pace with photosynthesis in very intense light.

The fact that most if not all oxygen molecules liberated by photosynthesis, originate from water, was confirmed by Vinogradov and Teis (1941) who determined the density of water synthesized from this oxygen, and proved that the isotopic composition of the latter is similar to that of oxygen in natural water (rather than to that of oxygen in carbon dioxide).

As to the two schemes, (b) and (d), which predict that all oxygen should come from water, the difference between them is that the older

one assumes the intermediate formation of *molecular hydrogen*, while the newer one postulates a transfer of hydrogen *atoms* from water to carbon dioxide (either directly, or through the intermediary of catalysts). We prefer the second theory because the intermediate formation of molecular hydrogen in photosynthesis could hardly have remained unnoticed.

After having characterized in general terms, the chemical nature of photosynthesis, it seems appropriate to add a similar general description of its physical nature, by classifying photosynthesis as a *sensitized photochemical reaction*. It must be sensitized by a pigment, because the reaction substrate ($\text{CO}_2 + \text{H}_2\text{O}$) does not absorb visible light. The concept of sensitization is familiar from the photographic plate, from so-called "photodynamic effects" in biology, and from many photochemical reactions *in vitro*. In the exact sense of the term, sensitization means a photochemical reaction induced by a light-absorbing substance *which is not itself permanently affected by the reaction*. True sensitizers are thus substances which act as *catalysts in light*. However, substances are often called "sensitizers" *even if they take an active part in the photochemical reaction* (as this is probably the case in most photodynamic effects). We cannot entirely avoid using "sensitization" and "sensitizer" in the usual loose manner, and shall therefore speak of "photocatalysts" when desiring to emphasize that we are dealing with a case of "true" sensitization.

Chlorophyll is a photocatalyst, since no decrease in the concentration of chlorophyll in leaves has been observed after intense photosynthesis (*cf.* Chapter 19, page 549). Therefore, only truly photocatalytic reactions can be adduced as imitations of photosynthesis *in vitro*. This has often been neglected by investigators who have attempted to reproduce photosynthesis outside the living cell, as will be demonstrated by many examples in chapter 4.

Bibliography to Chapter 3

The Over-All Reaction and the Products of Photosynthesis

A. The Quantitative Balance of Photosynthesis

- 1804 de Saussure, N. Th., *Recherches chimiques sur la végétation*. Nyon, Paris, 1804.
- 1864 Boussingault, T. B., *Ann. sci. nat. Botan.*, **1**, 314.
- 1874 Boussingault, T. B., *Agronomie, chimie agricole et physiologie*. Vol. 5, Mallet-Bachelier, Paris, 1874.
- 1886 Bonnier, G., and Mangin, L., *Ann. sci. nat. Botan.* **VII**, **3**, 1.
- 1890 Sapozhnikov, V., *Ber. deut. botan. Ges.*, **8**, 234.
- 1892 Aubert, E., *Rev. gén. botan.*, **4**, 203, 273, 321, 337, 373, 421, 457, 558.
- 1901 Krashennnikov, T., *Accumulation of Solar Energy in Plants*. (Russ.) Moscow, 1901.
- 1913 Maquenne, L., and Demoussy, E., *Compt. rend.*, **156**, 506.

- 1918 Willstätter, R. and Stoll, A., *Untersuchungen über die Assimilation der Kohlensäure*. Springer, Berlin, 1918; pp. 315-341.
- 1921 Kostychev, S., *Ber. deut. botan. Ges.*, **39**, 319.
- 1924 Bose, J. C., *The Physiology of Photosynthesis*. Longmans, London, 1924, p. 198.
- 1932 van der Pauw, P., *Rec. trav. botan. néerland.*, **29**, 497.
- 1935 Barker, H. A., *Arch. Mikrobiol.*, **6**, 141.
- 1938 Manning, W. M., Stauffer, J. F., Duggar, B. M., and Daniels, F., *J. Am. Chem. Soc.*, **60**, 266.
- 1939 Ruben, S., Hassid, W., and Kamen, M. D., *J. Am. Chem. Soc.*, **61**, 661.
- 1943 Smith, J. H. C., *Plant Physiol.*, **18**, 207.

B. The Products of Photosynthesis

- 1837 Mohl, H. von, *Untersuchungen über anatomische Verhältnisse des Chlorophylls*. (Dissertation of W. Michler, *Univ. Tübingen*, 1837.)
- 1856 Boehm, T. A., *Sitzber. Akad. Wiss. Wien, Math. Naturw. Klasse*, **22**, I, 479.
- 1857 Gris, A., *Ann. sci. nat. Botan.*, (IV), **8**, 170.
- 1862 Sachs, J., *Botan. Z.*, **20**, 365.
- 1863 Sachs, J., *Jahrb. wiss. Botan.*, **3**, 184.
- 1864 Sachs, J., *Botan. Z.*, **22**, 289.
- 1873 Pfeffer, W., *Monatsh. Akad. Wiss., Berlin*, 784.
- Brioso, G., *Botan. Z.*, **31**, 529, 545.
- 1874 Boehm, T. A., *Sitzber. Akad. Wiss. Wien, Math. Naturw. Klasse*, **69**, I, 76.
- 1876 Boehm, T. A., *ibid.*, **73**, I, 39.
- 1877 Holle, H. G., *Flora*, **35**, 113, 154, 160, 184.
- Godlewski, E., *ibid.*, **35**, 215.
- 1882 Perrey, A., *Compt. rend.*, **94**, 1124.
- 1883 Boehm, T. A., *Botan. Z.*, **41**, 33, 49.
- 1885 Meyer, A., *ibid.*, **43**, 417, 433, 449, 465, 480, 497.
- 1889 Sapozhnikov, V., *Ber. deut. botan. Ges.*, **7**, 25.
- 1890 Sapozhnikov, V., *ibid.*, **8**, 233.
- 1891 Sapozhnikov, V., *ibid.*, **9**, 293.
- 1892 Crato, E., *ibid.*, **10**, 250.
- 1893 Sapozhnikov, V., *ibid.*, **11**, 391.
- Brown, H. T., and Morris, J. H., *J. Chem. Soc.*, **63**, 604.
- 1898 Winkler, F., *Jahrb. wiss. Botan.*, **32**, 525.
- 1904 Beijerinck, M. W., *Rec. trav. botan. néerland.*, **1**, 28.
- 1907 Müller, H., *J. Chem. Soc.*, **91**, 1767.
- Tanret, G., *Compt. rend.*, **145**, 1196.
- 1909 Robertson, R. A., Irvin, T. C., and Dobson, M. E., *Biochem. J.*, **4**, 258.
- 1910 Nef, T. U., *Ann. Chemie (Liebig)*, **376**, 1.
- Löb, W., and Pulvermacher, G., *Biochem. Z.*, **23**, 10.

- 1911 Ravenna, C., *Gazz. chim. ital.*, **41** (2), 115.
Parkin, T., *Biochem. J.*, **6**, 1.
- 1912 Grafe, V., and Vouk, V., *Biochem. Z.*, **43**, 424.
Grafe, V., and Vouk, V., *ibid.*, **56**, 249.
- 1914 Tollens, B., *Kurzes Handbuch der Kohlehydrate*. 3rd ed., Barth, Leipzig, 1914.
- 1916 Curtius, Th., and Franzen, H., *Sitzber. Heidelberger Akad. Wiss. Math. naturw. Klasse*, Nr. 7.
Davis, W. A., Daish, A. T., and Sawyer, J. C., *J. Agr. Sci.*, **7**, 255.
Davis, W. A., and Sawyer, G. C., *ibid.*, **7**, 352.
Davis, W. A., *Biochem. J.*, **10**, 31.
Daish, A. J., *ibid.*, **10**, 49.
Mason, T. G., *Sci. Proc. Roy. Soc. Dublin*, **15**, 13.
Dixon, H. M., and Mason, T. G., *Nature*, **97**, 160.
- 1917 Gast, W., *Z. physiol. Chem.*, **99**, 1.
Meyer, A., *Ber. deut. botan. Ges.*, **35**, 586.
Meyer, A., *ibid.*, **35**, 676.
- 1918 Meyer, A., *ibid.*, **36**, 235.
- 1919 Kögel, P. R., *Biochem. Z.*, **95**, 313.
Kögel, P. R., *ibid.*, **97**, 21.
- 1922 Sjöberg, K., *ibid.*, **133**, 218.
- 1924 Weevers, T., *Proc. Acad. Sci. Amsterdam*, **27**, 1.
Priestley, J. H., *New Phytologist*, **23**, 255.
Melchior, R., *Ber. deut. botan. Ges.*, **42**, 198.
- 1925 Stiles, W., *Photosynthesis*. Longmans, Green, London, 1925, pp. 151-160.
- 1926 Spoehr, H. A., *Photosynthesis*. Chemical Catalog Co., New York, 1926, pp. 215-220.
Tottingham, W. E., Lepkovsky, S., Schulz, E. R., and Link, P., *J. Agr. Research*, **33**, 59.
- 1929 Spoehr, H. A., and Strain, H. H., *J. Biol. Chem.*, **85**, 365.
- 1930 Barton-Wright, E. C., and Pratt, M. C., *Biochem. J.*, **24**, 1217.
Clements, H. F., *Botan. Gaz.*, **89**, 241.
- 1932 Clements, H. F., *Plant Physiol.*, **7**, 547.
- 1935 Spoehr, H. A., and Milner, H. W., *J. Biol. Chem.*, **111**, 679.
Kretovich, V. C., *Z. physiol. Chem.*, **231**, 265.
- 1936 Endo, S., *Science Repts. Tokyo Bunriku Daigaku*, **2**, 223, 231; cf. *Chem. Abstracts*, **30**, 7150.
Spoehr, H. A., and Milner, H. W., *J. Biol. Chem.*, **116**, 493.
- 1938 Venezia, M., *Atti Ist. Veneto* **2**, **97**, 357.
- 1939 Spoehr, H. A., and Milner, H. W., *Proc. Am. Phil. Soc.*, **81**, 37.
- 1940 Spoehr, H. A., Smith, J. H. C., Strain, H. H., and Milner, H. W., *Carnegie Yearbook*, **39**, 147.
- 1943 Smith, J. H. C., *Plant Physiol.*, **18**, 207.
Gardner, Th. S., *J. Org. Chem.*, **8**, 111.
- 1944 Smith, J. H. C., *Plant Physiol.*, **19**, 394.

General References

Structure of Carbohydrates and their Occurrence in Plants

- Czapek, F., *Biochemie der Pflanzen*. Vol. 2, 2nd ed., Fischer, Jena, 1920.
- Pringsheim, H., *The Chemistry of the Monosaccharides and of the Polysaccharides*. McGraw-Hill, New York, 1932.
- Bernhauer, K., *Grundzüge der Chemie und Biochemie der Zuckerarten*. Springer, Berlin, 1933.
- Armstrong, E. F., and Armstrong, K. F., *The Carbohydrates*. 4th ed., Longmans, Green, London, 1934.
- Micheel, F., *Chemie der Zucker und Polysaccharide*. Akadem. Verlagsgesellschaft, Leipzig, 1939.

Products of Photosynthesis in Algae

- Tilden, J. E., *The Algae and their Life Relations*. Univ. Minn. Press, Minneapolis, 1935.
- Fritsch, F. E., *The Structure and Reproduction of Algae*. Macmillan, Cambridge, 1935.

C. Energy of Photosynthesis

- 1890 Stohmann, F., Kleber and Langbein, *Z. physik. Chem.*, **6**, 334, 341.
- 1892 Stohmann, F., and Langbein, *J. prakt. Chem.*, (2), **45**, 305.
- 1897 Delépine, N., *Compt. rend.*, **124**, 1525.
- 1911 Emery, A. G., and Benedict, F. G., *Am. J. Physiol.*, **28**, 301.
- 1921 Karrer, P., Nägeli, C., Hurwitz, O., and Wälti, A., *Helv. Chim. Acta*, **4**, 678.
- 1923 Karrer, P., and Fioroni, W., *ibid.*, **6**, 396.
- Verkade, P. E., and Koops, J., *Rec. trav. chim.*, **42**, 223.
- 1924 v. Wartenberg, H., Muchlewski, and Riedler, *Z. angew. Chem.*, **37**, 457.
- 1925 v. Wartenberg, H., and Lerner-Steinberg, *ibid.*, **38**, 592.
- 1931 Neuberg, C., Hoffmann, E., and Jacoby, M., *Biochem. Z.*, **234**, 344.
- 1940 Spessard, E. A., *Plant Physiol.*, **15**, 109.

General References

Compilations of Heats of Reactions

- Kharash, M. S., *Bur. Standards J. Research*, **2**, 359 (1929).
- Bichowski, F. R., and Rossini, F. D., *The Thermochemistry of Chemical Substances*. Reinhold, New York, 1936.
- Roth, W. A. in Vol. II² and III³ of Landolt-Börnstein's *Physikalisch.-Chem. Tabellen*. Springer, Berlin, 1931, 1936.

Compilations of Free Energies

- Parks, G. S., and Huffman, H. M., *The Free Energy of Some Organic Compounds*. Reinhold, New York, 1932.
- v. Stackelberg and Teichmann, in Vol. II² and Ulich, in Vol. III³ of Landolt-Börnstein's *Physikalisch.-Chem. Tabellen*. Springer, Berlin, 1931, 1936.

D. *Photosynthesis as an Oxidation-Reduction*

- 1804 de Saussure, N. Th., *Recherches chimiques sur la végétation*. Nyon, Paris, 1804.
- 1843 Liebig, J., *Ann. Chemie*, **46**, 58.
- 1864 Berthelot, M., *Leçons sur les méthodes générales de synthèse en chimie organique*. Gauthier-Villars, Paris, 1864.
- 1870 Baeyer, A. von, *Ber. deut. chem. Ges.*, **3**, 63.
- 1913 Wieland, H., *ibid.*, **46**, 3327.
- 1914 Wieland, H., *ibid.*, **47**, 2085.
Bredig, G., *Umschau*, **18**, 362.
- 1916 Hofmann, K. A., and Schumpelt, K., *Ber. deut. chem. Ges.*, **49**, 303.
- 1918 Willstätter, R., and Stoll, A., *Untersuchungen über die Assimilation der Kohlensäure*. Springer, Berlin, 1918, pp. 236-246 and 319.
- 1923 Thunberg, T., *Z. physik. Chem.*, **106**, 305.
- 1926 Kluyver, A. J., and Donker, H. J. L., *Chem. Zelle Gewebe*, **13**, 134.
- 1930 Kluyver, A. J., *Arch. Mikrobiol.*, **1**, 181.
- 1931 van Niel, C. B., *ibid.*, **3**, 1.
- 1941 Ruben, S., Randall, M., Kamen, M. and Hyde, J. L., *J. Am. Chem. Soc.*, **63**, 877.
Vinogradov, A. P., and Teis, R. V., *Compt. rend. acad. sci. URSS*, **33**, 490.

CHAPTER 4

PHOTOSYNTHESIS AND RELATED PROCESSES OUTSIDE THE LIVING CELL

Complete photosynthesis—that is, reduction of carbon dioxide to carbohydrates, and oxidation of water to oxygen, at low temperature and with no energy supply except visible light—has never been achieved outside the living cell. What has been accomplished were at best “partial” successes, reactions which in some future time may (or may not) be integrated into a complete reconstruction of photosynthesis *in vitro*.

In attempting to divest photosynthesis of its association with the living state, one may begin with the living cell, *tear it down*, and observe the effects of this procedure on the different aspects of photosynthesis; or one may *build up* from simple light-sensitive oxidation-reduction systems to more complicated ones, with an eye on the maximum conversion of light into chemical energy.

Some investigators have been too impatient to use either of these gradual approaches, and have spent unprofitable years in attempts to reproduce photosynthesis *in toto* by experiments which deserve to be called alchemistic rather than chemical.

A. PHOTOSYNTHESIS BY DRIED LEAVES, ISOLATED CHLOROPLASTS AND CHLOROPHYLL PREPARATIONS *

1. Leaf Powders and Isolated Chloroplasts

In 1881, Engelmann stated that “as soon as the structure of the chlorophyll-bearing bodies is destroyed, the capacity for oxygen production ceases at once and forever.” Since then, the association of photosynthesis with the *living state* of the cells has been one of the fundamental facts of plant physiology. It was observed again and again, that freezing, drying, boiling or poisoning puts an immediate end to photosynthesis. Many tissues can live and function outside the body; a heart will beat for days in a physiological salt solution, but the chloroplasts cease functioning the moment the cell is destroyed or damaged.

In 1901, Friedel reported that *powdered leaves*, dried at 100° C. and mixed with glycerol extracts from fresh leaves, produce oxygen and consume carbon dioxide in

* Bibliography, page 94.

light. Similar observations were described by Macchiati (1903). However, Harroy (1901), Herzog (1902), Molisch (1904) and Bernard (1904, 1905) failed to confirm them, and Friedel found himself unable to reproduce his earlier positive results later in the same year (1901²), a failure which he attributed to the inefficiency of autumnal leaves.

While dead or broken cells certainly are unable to carry out *complete* photosynthesis, they may maintain a limited capacity for *evolving oxygen* in light (without a concurrent reduction of carbon dioxide). This was first noticed in 1888 by Haberlandt and in 1896 by Ewart, who observed that *isolated chloroplasts* (obtained by grinding leaves under water) liberate a small quantity of oxygen when exposed to light. Similar observations with *dried leaf powders* were made by Molisch in 1904.

The matter rested there for twenty years, until Molisch came back to it in 1925. He confirmed the evolution of oxygen by leaves which were dried for three or four days at 30–35° C., and often kept in a desiccator for several weeks. Some leaves produced oxygen even after having been heated to 84° for five hours. To obtain oxygen, dried leaves had to be powdered under water and the mixture illuminated *without straining*. Leaves killed by freezing also produced oxygen in light. Inman (1935) repeated the experiments of Ewart and Molisch. Fresh leaves of *Trifolium repens*, *Zea mais* and *Melilotus alba* were ground with sand and the remaining whole cells removed by filtration. The suspension of broken and unbroken chloroplasts, obtained in this way, produced oxygen upon illumination. Positive results were obtained also with leaves dried for several days at 30–35° before powdering. The leaves lost their capacity for evolving oxygen more quickly if they were *first* macerated and *then* dried, instead of drying first and powdering afterwards. The alga, *Nostoc*, was able to evolve oxygen even after having been kept in the dry state for eighteen months. Addition of protein-digesting enzymes (*e. g.*, trypsin) prevented the evolution of oxygen by leaf powders. (Photosynthesis by unbroken cells was *not* affected by trypsin.) The production of oxygen was limited to the pH range 5–7, with a sharp maximum at a pH of 5.5. Inman (1938) stressed the similarity between the effects of temperature, acidity, and trypsin on the oxygen evolution by leaf triturates and on the denaturation of proteins, and suggested that the oxygen liberation is catalyzed by an enzyme. According to Inman (1938²), the evolution of oxygen can also be demonstrated with the isolated cell contents of the giant cells of *Nitella* and *Valonia macrophysa*, and with press juices from clover leaves and *Euglena viridis*.

In all these experiments, oxygen formation could be proved only by the luminescence of Beijerinck's bacteria; the rate of its evolution was unknown, but certainly very small; and the whole process lasted

for not more than an hour. All this seems to point to a decomposition of a limited quantity of a peroxide, either left in the leaves as a residue from normal metabolism, or accumulated by *post mortem* processes. Yamafuji and coworkers have observed that dried vegetable and animal tissues form small quantities of peroxide (*cf.* page 78). This peroxide, slowly accumulated in darkness or in diffuse light, could decompose suddenly upon exposure to strong light (particularly if chlorophyll is present as a sensitizer), thus producing the "burst" of oxygen observed by Molisch and Inman.

If this explanation is correct, the oxygen evolution by dried leaves is not directly related to photosynthesis (except for the fact that it, too, may be sensitized by chlorophyll). However, the experiments of Hill (1937, 1939, 1940) favor another hypothesis—that the oxygen evolution by leaf powders bears a significant relation to the production of oxygen in photosynthesis.

In Hill's first experiments (1937, 1939), a chloroplast suspension was obtained from leaves of *Stellaria media*, *Lamium album* and other plants, by grinding in a phosphate-buffered 10% sucrose solution (*pH* 7.9), and filtering through glass wool. The suspension was mixed with a solution of hemoglobin, under exclusion of air. The evolution of oxygen (in light of 40,000 lux) was measured spectrophotometrically by observing the conversion of hemoglobin into oxyhemoglobin. However, oxygen was found only when an *aqueous leaf extract* was added to the suspension. (This extract was prepared by grinding leaves under acetone, filtering, drying the filtrate and extracting the residue with water.) In further developing these experiments, Hill observed that the leaf extract can be replaced by a yeast extract, and that the efficiency of the latter was dependent on its content of organic iron compounds. Finally, he found that the oxygen evolution can also be brought about by the addition of *ferric potassium oxalate*, thus allowing him to dispense with cell extracts of unknown composition. The illumination of an air-free mixture of chloroplasts with ferric potassium oxalate and hemoglobin, causes a rapid appearance of oxyhemoglobin, and a reduction of Fe^{+++} to Fe^{++} (detectable, for example, by means of dipyriddy). In the dark, the original state is slowly restored again. The *total quantity* of oxyhemoglobin produced in this experiment, depends on the quantity of ferric salt taken, while the *initial velocity* of oxidation is determined by the quantity of the chloroplasts. The most active wave lengths are those around 600 $\text{m}\mu$ (thus pointing to chlorophyll as the sensitizing agent).

The maximum rate of oxygen evolution by a *chloroplast suspension* in the presence of ferric oxalate, was about equal to the rate of oxygen liberation by a *suspension of whole cells* (from the same leaves) in the presence of carbon dioxide, but was only one-tenth of the rate of photo-

synthesis of the *intact leaf* (if all three rates were related to the same quantity of chlorophyll).

One may attempt to explain Hill's results by a chlorophyll-sensitized oxidation of a peroxide by ferric oxalate (*cf.* Eq. 4.1). As pointed out by Kautsky (1938) ferric oxalate itself oxidizes hydrogen peroxide in violet and ultraviolet light; this reaction could easily be sensitized by chlorophyll. However, the total quantity of oxygen obtained in Hill's experiments would require the presence in the chloroplasts of 0.1 mole per liter of the peroxide, which is not plausible. Furthermore, only one-half a gram atom of oxygen was produced for one gram atom of reduced ferric iron. For the oxidation of a peroxide, this ratio would be 1:1.

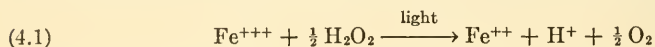

Thus, the substrate of oxidation must be an *oxide* (*e. g.* water) rather than a *peroxide*:

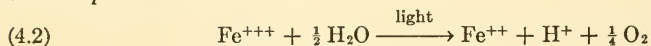

Equation (4.2) suggests that Hill's reaction is a chlorophyll-sensitized reversal of the familiar oxidation of ferrous to ferric iron by oxygen, just as photosynthesis is a reversal of the familiar process of combustion of carbohydrates.

In photosynthesis, oxygen can be liberated regardless of its partial pressure in the atmosphere. In Hill's first experiments with isolated chloroplasts, oxygen was evolved (in absence of hemoglobin) only if the partial pressure of this gas was less than 1 mm. in experiments with leaf extracts, and 4 mm. in experiments with ferric oxalate. Hill and Scarisbrick (1940¹) found, however, that the limitation was caused by the reoxidation of ferrous oxalate by oxygen. If potassium ferricyanide (which does not itself cause an evolution of oxygen by the chloroplasts in light) was added to the mixture, it reoxidized ferrous oxalate more rapidly than did oxygen, and thus allowed the latter to accumulate, independently of its partial pressure, until its total quantity was equivalent to the maximum quantity of oxyhemoglobin obtainable from the same preparation.

If no exhaustion of the oxidant (ferric oxalate) was allowed to occur, the evolution of oxygen could be maintained for several hours; however, it gradually became weaker, and sank to zero after five or six hours of illumination.

Hill and Scarisbrick (1940²) investigated the effects of different external factors on the initial rate of liberation of oxygen and reduction of ferric oxalate by chloroplasts. For the determination of ferrous oxalate, they used the reduction of methemoglobin to hemoglobin (a method which they considered more reliable than the complex formation

with 1,1'-dipyridyl). The amount of hemoglobin was measured spectrophotometrically, by oxidizing it to oxyhemoglobin. Thus, in practice, the *evolution of oxygen* was determined by measuring the rate of formation of oxyhemoglobin in *anaerobic* mixtures of chloroplasts with ferric oxalate and *hemoglobin*, while the *reduction of ferric oxalate* was determined by measuring the same rate in *aerobic* mixtures of chloroplasts with ferric oxalate and *methemoglobin*.

The rates obtained by the second method were lower, but better reproducible than those calculated from anaerobic experiments. The cause of this difference was the slowness of the methemoglobin-ferrous oxalate reaction, which "limited" the over-all process, making it less sensitive to poisons (but more sensitive to temperature). Thus, values obtained in anaerobic experiments, though less consistent, are more significant, being free from such artificial limitation.

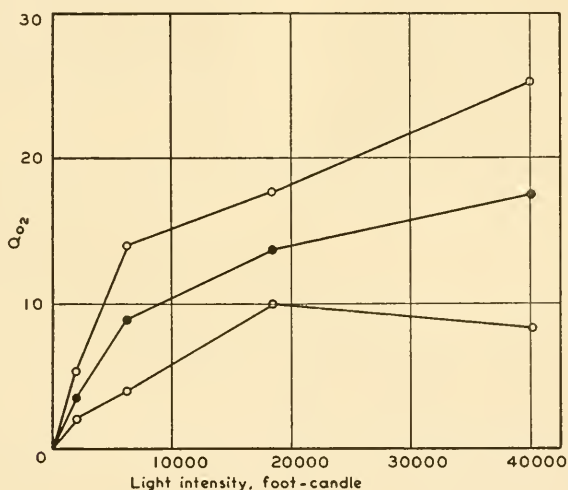

FIG. 6.—Effect of varying light intensity on the rate of evolution of oxygen by chloroplasts (after Hill and Scarisbrick 1940²).

Fe concentration, 4×10^{-4} mole per l. Chloroplast suspension, 0.4 ml. Circles, extreme values; dots, mean values.

The effect of *light intensity* on the rate of oxyhemoglobin production by chloroplasts from *Stellaria media* is illustrated by figure 6. It shows the phenomenon of "light saturation," typical of true photosynthesis (Vol. II, Chapter 28) and occurring in the same region ($\sim 40,000$ lux) of intensities. The occurrence of light saturation shows that Hill's reaction includes a nonphotochemical process of limited velocity, in addition to the photochemical process proper. We know now that different enzymatic reactions may become "limiting" in photosynthesis under appropriate conditions, as, for instance, if slowed down by a specific poison.

The reaction responsible for the inhibition of photosynthesis by *cyanide* probably is associated with the *entry of carbon dioxide* into the photosynthetic apparatus (*cf.* Chapter 12). Since carbon dioxide does not participate in Hill's reaction, it appears natural that this reaction is *not* affected by cyanide. (Less easily understandable is the indifference of this reaction to *hydroxylamine*, which, according to page 313, is a specific poison for the oxygen-liberating enzymatic system in photosynthesis.) Urethans, on the other hand, which inhibit photosynthesis in the "light-limited" as well as in the "enzyme-limited" state, also inhibit Hill's reaction. Ethylurethane, for example, causes a 50% inhibition in a 0.6% solution, while phenylurethan produces the same effect in a concentration of only $4 \times 10^{-4}\%$. (The ratio of the efficiencies is 1500, as compared with 450 in true photosynthesis, *cf.* table 12.VIII).

The *temperature coefficient* of hemoglobin oxidation by ferric oxalate in the presence of chloroplasts is 1.3 to 1.4 (while that of methemoglobin reduction is 1.8 to 1.9). This value is smaller than the temperature coefficient of photosynthesis in the light-saturated state (>2) (*cf.* Vol. II, Chapter 31), but figure 6 shows that the conditions of Hill's measurements were not those of complete light saturation.

These results cannot be fully appreciated in the present chapter, because the corresponding relationships in photosynthesis will first be discussed in chapters 12, 28 and 31. The assumption that Hill's reaction represents "one half of complete photosynthesis" (photochemical oxidation of water, with ferric oxalate as a substitute oxidant taking the place of carbon dioxide), seems to be in agreement with most observations (the most notable exception being the insensitivity of Hill's reaction to hydroxylamine). If this interpretation is correct, it means that broken or dried chloroplasts retain an important part of their normal photocatalytic capacity—they can still produce oxygen from water in light. However, they are not able any more to transfer hydrogen to carbon dioxide as acceptor, and thus cannot synthesize organic matter.

In chapter 7, we shall discuss several alternative theories of the primary photochemical reaction in photosynthesis—some envisaging a direct participation of carbon dioxide in this reaction, others interpreting it as a photooxidation of water, with the hydrogen being first transferred to an unknown intermediary acceptor. Hill's experiments fit best into this second picture. If, in living cells, the hydrogen atoms find their way from the primary acceptor to carbon dioxide, with the help of a nonphotochemical enzymatic apparatus, it appears plausible that this apparatus may be destroyed by drying or crushing the cells, while the photochemical mechanism remains more or less intact.

A recent observation of Frenkel (*cf.* page 204) makes it probable (but by no means certain) that the first transformation of carbon dioxide

in photosynthesis takes place outside the chloroplasts. This may explain why isolated chloroplasts are unable to use carbon dioxide as oxidant, even if they are capable of oxidizing water in light.

Attempts to take the photosynthetic mechanism apart in order to find out how it works have been for a long time as unsuccessful as the proverbial farmer's attempt to get at the source of golden eggs by killing the goose which laid them. Hill's experiments represent the first step forward in this direction, and their continuation appears of great interest. (A confirmation of his results was contributed by French and coworkers, 1942.) They support the conclusion, derived by van Niel and Gaffron from experiments with bacteria and anaerobically treated algae (*cf.* Chapters 5 and 6), that the two partial processes of oxygen evolution and carbon dioxide reduction are largely independent, and can be investigated separately. While van Niel and Gaffron showed that it is possible to substitute in photosynthesis other *reductants* for water, Hill's observations indicate that ferric salts can be substituted for carbon dioxide as *oxidants* in this process.

Hill's original experiments with leaf and yeast extracts, as well as the earlier qualitative observations of Friedel and Molisch (in which, too, leaf extracts in glycerol or water were found necessary to bring about the evolution of oxygen by leaf powders) make it seem probable that these extracts contain organic oxidants which can be used to oxidize water, in the presence of illuminated chloroplasts, instead of ferric oxalate. In the case of leaf extracts, the oxidants may well be identical with the intermediate hydrogen acceptors in true photosynthesis. It would be important to identify these oxidants by systematic analysis.

One can ask whether Hill's reaction is similar to true photosynthesis from the point of view of *conversion of light into chemical energy*. Ferric salts are much stronger oxidants than carbon dioxide. At pH 8, where Hill's reaction proceeds most easily, the potential of an oxygen electrode is -0.75 volt and thus almost equal to the normal potential of the *nonassociated* ferri-ferro system (-0.77 volt). However, ferric oxalate solutions *are* strongly associated, and their potential is therefore much less negative. The reduction of potassium ferricyanide by ferrous oxalate, *cf.* page 64, proves it to be > -0.49 volt. Therefore, the photochemical oxidation of water by ferric oxalate must lead to the conversion of a considerable amount of light energy into chemical energy—even if this amount is much smaller than that utilized in true photosynthesis.

2. Experiments with Chlorophyll Preparations

Of all chemical components of plants, the only one which is clearly indispensable for photosynthesis is the green pigment chlorophyll. Ingen-Housz, in 1779, established that only green parts of plants improve

the air in light. Whenever red, brown or blue cells have been found capable of photosynthesis, it could always be proved that they, too, contain the green pigment, even though its color may be masked by carotenoids or anthocyanins.

It was natural therefore that attempts to repeat photosynthesis outside the plant have centered on chlorophyll preparations. The results have been disappointing, and we need only devote a few lines to these experiments.

Nobody has ever claimed to have achieved photosynthesis by illuminating a *chlorophyll solution in an organic solvent* in the presence of carbon dioxide; but a few negative experiments on this subject have been published by von Euler (1909). Usher and Priestley (1906²) have asserted that *chlorophyll films on gelatin* produce hydrogen peroxide and formaldehyde when exposed to light and carbon dioxide. But this claim, although supported by Schryver (1910), was discredited by Ewart (1908), von Euler (1909), Schiller and Baur (1912), Warner (1914) and Wager (1914), who proved that, although some formaldehyde can be found after the illumination of chlorophyll films in air, it originates in the oxidation of chlorophyll and *not* in the reduction of carbon dioxide. Willstätter and Stoll (1918) asserted that no formaldehyde is produced at all, if *pure* chlorophyll preparations are used. Chodat and Schweizer (1915) claimed the formation of formaldehyde and hydrogen peroxide by the illumination of *chlorophyll precipitated on calcium carbonate*; but Willstätter and Stoll (1918) failed to confirm this claim. It was thought by Willstätter and Stoll that chlorophyll is contained in the leaves in the colloidal state; they therefore carried out some experiments on the photosynthetic activity of *colloidal chlorophyll solutions in water*, with completely negative results. They also tried the addition of *peroxidase* (on the assumption that the completion of photosynthesis requires the decomposition of a peroxide), but without success. Knoll, Matthews and Crist (1938) have described an oxygen evolution caused by the addition of *catalase* to illuminated aqueous solutions of sodium chlorophyllide and carbonate, but details of this experiment have never been published.

We shall find in chapter 14 proofs of the existence in the plant cells of a chlorophyll-protein complex. The preservation of this complex may be necessary to maintain the photosynthetic capacity of chlorophyll. Different methods to extract the chlorophyll-protein complex from leaves have been perfected, and these extracts have been found to possess some of the properties of the chlorophyll in the leaf, *e. g.*, its absorption spectrum, chemical stability and fluorescence. Nevertheless, they, too, lack photosynthetic capacity (*cf.* Smith 1938). Eisler and Portheim (1923) claimed that *artificial* chlorophyll protein complexes (prepared by adding horse serum to chlorophyll solutions) were able to reduce carbon dioxide and liberate oxygen in light, but their methods were crude, and the promised detailed publication has not materialized.

The incapacity of chlorophyll-protein complexes to bring about photosynthesis appears natural if we remember that even isolated chloroplasts maintain, at the utmost, only a vestige of their normal photosynthetic activity. The question to ask about chlorophyll prepara-

tions is not whether they are capable of complete photosynthesis, but whether they too, retain some properties reminiscent of the part which chlorophyll plays in photosynthesis. As shown in chapter 3, this part is the *utilization of light energy for hydrogen transfer against the gradient of chemical potential*. Chlorophyll may achieve this either by a purely physical transfer of energy to a cellular oxidation-reduction system, or, more probably, by direct chemical participation in such a system. Consequently, what we ask is whether chlorophyll *in vitro* forms a reversible oxidation-reduction system and, if it does, whether the oxidizing capacity of its oxidized form, or the reducing capacity of its reduced form (or both) are enhanced by the absorption of light.

Indications that chlorophyll *in vitro* actually possesses the properties of a light-activated oxidation-reduction catalyst, have been found by Rabinowitch and Weiss (1937) in experiments which shall be discussed in chapter 18. Some observations of Baur (1935), Baur and Fricker (1937), and Baur, Gloor and Künzler (1928), which point in the same direction, will be described later in the present chapter (page 90). These interesting, but as yet inconclusive results are the only indications that chlorophyll outside the cell does retain certain of the properties which make it "the most important single organic compound on earth" as long as it is contained in living plant cells.

B. THE PHOTOCHEMICAL OXIDATION OF WATER *

We now leave the living cell and the products obtained from it and consider nonbiochemical systems whose behavior is of interest from the point of view of artificial photosynthesis.

The essence of photosynthesis is the reduction of the oxidant of an oxidation-reduction system of a higher potential (carbon dioxide-carbohydrate) by the reductant of a system of a much lower potential (oxygen-water), with light supplying the necessary energy. The difference in *total internal energy* between the substrates and products of photosynthesis is 112 kcal per gram atom of carbon; the difference in *free energy* is a few calories larger (*cf.* Table 3.V). *Complete* artificial photosynthesis should bridge this whole gap at once. However, all experiments which help to narrow it, may be considered as helpful *partial* solutions. The bridging may begin at either end or in the middle. It may include photochemical or nonphotochemical reactions likely to bring the two reacting systems closer together. Nonphotochemical reactions cannot contribute to the bridging of the energy gap; but they can make the solution easier, by substituting catalytic reactions with low activation barriers for reactions with the same net heat effect, but with a larger energy of activation.

* Bibliography, page 95.

The experiments on isolated chloroplasts, described on page 63 *et seq.*, as well as considerations based on bacterial metabolism, (*cf.* Chapter 5), make it feasible that one (and perhaps the only) photochemical reaction in photosynthesis may be the transfer of hydrogen from water to an intermediate acceptor. Consequently, in our search for a model of photosynthesis *in vitro*, we are concerned, in the first place, with the *photochemical oxidation of water* by substances thermodynamically incapable of achieving this oxidation in the dark.

The liberation of oxygen from water can occur by "self-oxidation" (dismutation),

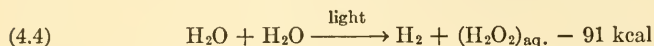
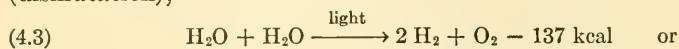

or (if hydrogen is taken over by an "acceptor") by an oxidation-reduction:

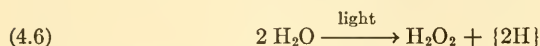
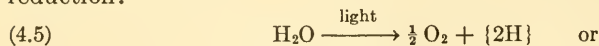

where brackets indicate acceptor molecules.

Reactions (4.3) to (4.6) can be brought about by direct absorption of ultraviolet light by water, or they can be sensitized. If, in (4.5) and (4.6), the acceptor itself is the light-absorbing species, the reaction is a *photoxidation of the acceptor*, rather than a true *photocatalysis*, and can only be called "sensitized" in the wider sense defined on page 56.

For the sake of simplicity, we do not speak here of the possibility that an acceptor can be provided also for hydroxyl radicals or oxygen atoms, so that the primary products of oxidation will be complexes of the type $\{\text{OH}\}$, $\{\text{OH}\}_2$ or $\{\text{O}_2\}$, rather than free molecules of oxygen or hydrogen peroxide (*cf.* Chapter 11).

Any of reactions (4.3) to (4.6) can provide an appropriate first step towards artificial photosynthesis. To complete the process, carbon dioxide must be reduced by hydrogen or by the hydrogenated acceptor $\{\text{H}\}$.

In addition to the photodismutations, (4.3) and (4.4), and the photoxidations, (4.5) and (4.6), we shall also consider here the "photoautoxidation":

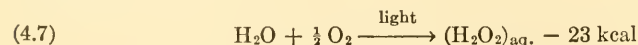

(The term "autoxidation" for "oxidation by molecular oxygen" is ugly, but has come into general use.) This reaction could be useful as a first step in artificial photosynthesis only if hydrogen peroxide were able to reduce carbon dioxide. This question will be discussed on page 79 and answered in the negative. We have nevertheless added (4.7) to the other forms of photochemical oxidation of water, because this reaction

must be considered whenever the oxidation of water takes place in the presence of air.

1. Decomposition of Water in Ultraviolet Light

The direct photochemical decomposition of water into hydrogen and oxygen according to equation (4.3) was described by Coehn (1910) and Coehn and Grote (1912). A "photostationary state" is established in ultraviolet-illuminated water vapor, with light accelerating both its decomposition and the recombination of hydrogen and oxygen (Berthelot and Gaudechon 1910).

The decomposition according to (4.4), *i. e.*, with the formation of hydrogen peroxide, was discovered by Thiele (1908) and Kernbaum (1909). Tian (1916) suggested the existence, in ultraviolet-illuminated liquid water, of a stationary state involving photochemical formation and decomposition of hydrogen peroxide. If oxygen is present, all hydrogen formed by (4.4) is taken away, making it possible for hydrogen peroxide to accumulate, and the net effect is a peroxide formation according to equation (4.6).

In these investigations, a mercury arc was used, and the decomposition was caused mainly by the first resonance line of mercury (189 m μ), which is strongly absorbed by quartz walls and only weakly absorbed by water. A more rapid decomposition can be achieved by means of a hydrogen discharge tube with a fluorite window, as used by Terenin and Neujmin (1934, 1935, 1936). The active wave lengths are 130–140 m μ , which fall into the second absorption band of water. In this region, water decomposes into OH* + H (the asterisk indicating electronic excitation), as proved by the emission of OH bands in fluorescence. The primary process in the first absorption band of water, situated below 178–179 m μ , may be either:

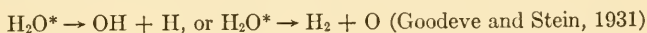

or (in the liquid state):

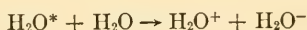

The direct photochemical decomposition of water solves a large part of the difficulties involved in artificial photosynthesis (it accumulates energy and liberates oxygen), but it does not solve *all* of them, because neither hydrogen molecules nor hydrogen atoms prove capable of reducing carbon dioxide. The reaction between *molecular* hydrogen and carbon dioxide will be discussed in more detail on page 83; as to *atomic* hydrogen, Harteck (1933) found that the admission of hydrogen atoms to carbon dioxide gas does not produce more than traces of formaldehyde.

2. Mercury-Sensitized Decomposition of Water

We now go over to *sensitized* photodecompositions of water. The first extension of the photochemically active range towards the visible can be achieved by using *mercury vapor* as a sensitizer.

Wood (1925) found that water vapor containing mercury decomposes when illuminated with the resonance line (253.6 $m\mu$) of mercury. Senftleben and Rehren (1926) investigated the reaction more closely by measuring the heat conductivity of the illuminated mixture. In a closed vessel, the illumination leads to a photostationary state. Gaviola and Wood (1928) have given spectroscopic proofs of the presence in this state of free hydroxyl radicals (OH) and of mercury hydride molecules (HgH). According to Beutler and Rabinowitch (1930) these are the primary products of the reaction:

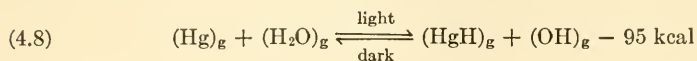

However, through the recombination of OH radicals, the dissociation of the unstable HgH molecules, and other processes competing with (4.8), numerous other products are formed, among others, H_2 , O_2 , H_2O_2 , HgO and free H atoms. Melville (1936) found that the uncondensable fraction of the illuminated Hg/ H_2O mixture consists mainly of hydrogen, and suggested that the equivalent quantity of oxygen is bound in mercurous oxide.

Reaction (4.8) is of the type (4.6), a photooxidation of water by mercury, with the transfer of only one hydrogen atom. This reaction is possible, despite the high energy of dissociation of water into H and OH (109 kcal), because the absorption of the line 253.6 $m\mu$ brings mercury into a state (3P_1) with an excess energy of 112 kcal per mole. This is the first example of how light energy can be utilized for hydrogen transfer against the gradient of chemical potential.

The efficiency of conversion of light energy into chemical energy in reaction (4.8) is 90%. However, most of this energy is dissipated by secondary processes. If the hydroxyl radicals decompose into water and oxygen, while the mercury hydride decomposes into mercury and hydrogen, the ultimate result is that a quantum equivalent to 112 kcal per mole, has produced the reaction $\frac{1}{2} \text{H}_2\text{O} \rightarrow \frac{1}{2} \text{H}_2 + \frac{1}{4} \text{O}_2$, with a heat effect of 27 kcal, corresponding to the conversion of only 25% of light energy into chemical energy. This result is actually achieved when the reaction between Hg and H_2O is carried out in a *streaming* system. Bates and Taylor (1927) found that the decomposition products contain 73% H_2 and 27% O_2 . The deficiency of oxygen may be due to the incomplete decomposition of hydrogen peroxide.

3. Sensitization of Water Decomposition by Solids (ZnO and AgCl)

The photochemical decomposition of water can be extended further towards longer waves by the use of *solid* sensitizers, *e. g.*, *zinc oxide* and *silver chloride*. However, it is not certain whether the sensitization by zinc oxide goes beyond sensitized *photooxidation* of water, according to equation (4.7). This reaction was discovered by Baur and Neuweiler (1927). After *oxygen-containing* water has been shaken with zinc oxide for 10–15 hours in full sunlight, the liquid is found to contain about 1×10^{-3} mole per liter of hydrogen peroxide. According to Baur and Neuweiler, no peroxide is formed in *air-free* solutions; the oxidant is thus apparently molecular oxygen. The active light belongs to the near ultraviolet (the absorption limit of ZnO lies at 380 $m\mu$), and zinc oxide seems to act as a true photocatalyst, promoting reaction (4.7) without participating in it.

Richardson (1939) found that the quantum yield of this reaction is of the order of 0.1 in weak light, and less at the higher light intensity. The rate of peroxide formation shows a "light saturation" similar to that occurring in photosynthesis, proving that the photochemical process is coupled with a thermal process of limited velocity. (For example, the photochemical decomposition of water adsorbed at the surface of ZnO may be followed by the desorption of the reaction products.) The mechanism of this reaction is unknown, but we may assume that the primary process is the decomposition of adsorbed water into OH and H, made possible by the large heats of adsorption of OH and H on zinc oxide.

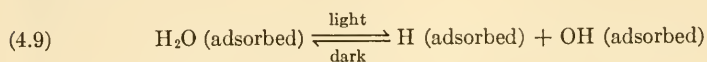

In order to enable reaction (4.9) to occur in the near ultraviolet (that is, with light quanta of about 78 kcal per einstein, one einstein being 6×10^{23} quanta), the combined heat of adsorption of the radicals must be at least 35 kcal larger than that of water.

The assumed primary reaction (4.9) is of the type postulated by van Niel for photosynthesis (*cf.* Eq. 7.1)—photochemical decomposition of water, with zinc oxide serving as acceptor for both hydrogen atoms and hydroxyl radicals. To explain why hydrogen peroxide is formed only in presence of oxygen, we may assume that oxygen molecules snatch away the adsorbed hydrogen atoms, thus preventing the reversal of reaction (4.9), and leaving to the hydroxyl radicals no other way but to recombine to "biradicals" H_2O_2 . In this way, the primary photochemical decomposition of water is again reduced to a "photoautoxidation," according to equation (4.7), with its comparatively small energy conversion.

The question arises as to whether the back reaction in (4.9) is completely effective in absence of oxygen, or whether some hydrogen atoms succeed in recombining to hydrogen molecules, causing an equal number of hydroxyl radicals to recombine to H_2O_2 and giving the net effect of sensitized water decomposition (4.4), a result much more significant from the point of view of artificial photosynthesis than the photoautoxidation (4.7). Successful achievement of reaction (4.4) would leave us with the problem of carbon dioxide reduction by molecular hydrogen as the final stage of artificial photosynthesis—a reaction which requires no additional conversion of energy. True, we do not yet know how to conduct it in a reversible way, without spending considerable energy on activation; but we shall see in chapter 5, that the so-called "Knallgas bacteria" reduce carbon dioxide to carbohydrates in the dark, by means of molecular hydrogen, with up to 40% of the theoretical yield.

It is thus an interesting question whether hydrogen peroxide can be obtained by the illumination of zinc oxide suspensions *in the absence of oxygen*. Baur and Neuweiler (1927) gave a negative answer to this question, while Yamafuji, Nishioeda, and Imagawa (1939) asserted that a small quantity of hydrogen peroxide is formed even if all oxygen had been removed.

Vogel (1863), Eder (1906) and Siehling (1911), found that water over a *silver chloride* precipitate evolves oxygen if exposed to daylight, and this was confirmed by Baur (1908) and Baur and Rebmann (1921). However, the amount of gas evolved is small, and the reaction soon stops. In contrast to water decomposition by zinc oxide, this reaction is probably not a true photocatalysis, but a *photooxidation of water by silver chloride*:

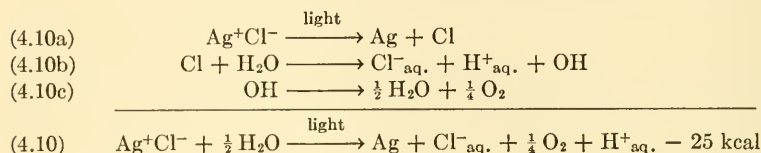

This reaction deserves attention because of the apparent conversion of a large part of light energy into chemical energy. If brought about by a single quantum at 400 $m\mu$, it would lead to the conversion of about 35% of absorbed light energy, a yield not attained by any other known photochemical reaction in visible light. It is, however, not certain whether the observations of Vogel, Baur, and Rebmann are correct, whether interpretation (4.10) applies to them and, if it does, what the quantum yield of this reaction may be.

4. Photooxidation of Water by Cations

We have considered *mercury vapor* and *ionic crystal powders* as sensitizers which enable the photochemical liberation of oxygen from water to occur in the medium or near ultraviolet. A third group of such sensitizers is found in *dissolved cations*.

The only cation whose capacity for photochemical water oxidation has been demonstrated by experiments, is the *ceric ion*, Ce^{++++} . The normal oxidation-reduction potential of the system $\text{Ce}^{++++}-\text{Ce}^{+++}$ is close to - 1.5 volt, that is, far below that of the oxygen electrode. Consequently, Ce^{++++} ions liberate oxygen from water even in the dark; but this process is slow. Baur (1908) noticed that this oxidation can be accelerated by light, and Weiss and Porret (1937) found that oxygen is produced with a quantum yield as high as 0.5.

The absorption bands of the ceric ions extend from the far ultraviolet to the blue-violet region of the visible spectrum. (The molar extinction coefficient is about 150 at 400 $m\mu$.) It is likely that absorption every-

where in this region is effective in bringing about the reaction

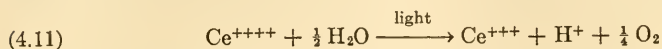

Since the oxidation potential of ceric ions is more negative than that of molecular oxygen, reaction (4.11) does not convert light into chemical energy.

It is known or suspected (see Rabinowitch 1942) that the light absorption by many other cations also leads to a primary oxidation of water, probably, according to the equation:

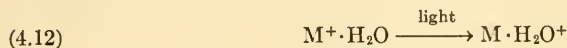

A. and L. Farkas (1938), who suggested this primary process, pointed out that the final state in (4.12) is unstable, and is terminated either by a return of the electron to water:

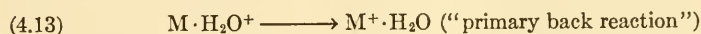

or by a chain of transformations of the ion H_2O^+ , *e. g.*:

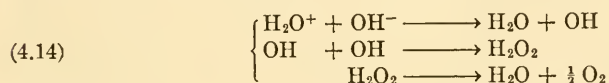

At any stage of (4.14), the reaction may be reversed by a "secondary" back reaction, that is, the reoxidation of M by hydroxyl, peroxide or oxygen.

In the case of the ceric ions, reaction sequence (4.14) has a good chance of occurring in preference to a primary or secondary back reaction. With other cations, no oxygen evolution has been observed upon illumination (at least, as far as attention has been paid to this point) and this can be taken as an indication that the back reactions are more probable than the oxidation chain (4.14). The cause most probably lies in the relative energies of the different states involved in the process. For ceric ions, oxidation releases more energy than the return into the initial state, and the probability of the metastable state $\text{Ce}^{++++} \cdot \text{H}_2\text{O}^+$ undergoing a development according to (4.14) is correspondingly high. In the case of other ions (ferric ions, for example) much more energy can be gained by the transformation of the metastable complex ($\text{Fe}^{++} \cdot \text{H}_2\text{O}^+$) back into $\text{Fe}^{+++} \cdot \text{H}_2\text{O}$, than by the completion of oxidation according to

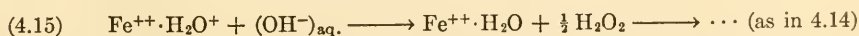

The reaction with ferrous oxalate observed by Hill and described on page 63 is probably of type (4.12) - (4.14), although it requires sensitization (by chloroplasts). In this case, the oxygen liberation occurs with a considerable yield, *despite the unfavorable position of the energy*

levels. This must be due to an enzymatic mechanism preventing a primary back reaction of type (4.13), and accelerating the completion of the oxidation process. A *secondary* back reaction (reoxidation of ferrous oxalate by oxygen) actually was observed by Hill, but this reaction is comparatively slow and does not prevent a partial escape of oxygen into the atmosphere, or the fixation of oxygen by hemoglobin.

A "hidden," *i. e.*, instantaneously reversible, photochemical oxidation of water by illuminated cations has also been postulated in the explanation of two forms of the "Becquerel effect," the "photovoltaic" effect, in which the illumination of an oxide-, halide-, or dyestuff-coated *electrode* causes a change of potential, and the "photogalvanic effect," in which a similar change is induced by the illumination of an *electrolyte* in contact with an inert electrode. Both effects must be caused by short-lived chemical changes in the surface layer of the electrode, or of the electrolyte. The most probable change is the displacement of an oxidation-reduction equilibrium (*cf.* Rabinowitch 1940). It has been suggested by Baur (1918, 1919) for the photogalvanic effect, and by Audubert (1934) for the photovoltaic effect, that one partner in the oxidation-reduction equilibrium in aqueous electrolytes is *water* (the other being the specific photosensitive component—dyestuff, salt, or oxide). However, Svensson (1919) found no evolution of oxygen or hydrogen in illuminated photogalvanic systems; neither was he able to observe the formation of hydrogen peroxide or ozone. Baur suggested therefore, that the decomposition of water remains in a "hidden stage," that is, stops short of an actual evolution of oxygen or hydrogen, because of the efficiency of the back reactions.

5. Photooxidation of Water by Dyestuffs

In connection with the problem of photosynthesis, the photochemical oxidation of water by *dyestuffs*, either in consequence of a reduction of the dyestuff itself, or by true sensitization as in Hill's experiments, is of great interest.

Many cationic dyestuffs are oxidants, capable of being reduced to so-called *leuco dyes*. Their oxidation-reduction potentials are much too low to enable them to oxidize water in the dark—the strongest known organic oxidants have potentials of -0.4 volt at pH 7, which is still 0.4 volt above the potential of the oxygen electrode at the same pH . However, the absorption of a light quantum, even of a "red" light quantum of about $600 m\mu$, corresponding to 45 kcal per einstein, should make the free energy of reaction (4.16) negative.

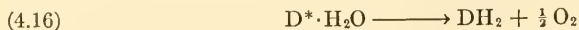

In other words, light-excited dyestuff molecules contain enough energy

to bring about the oxidation of water. However, the primary process in dyestuff solutions is *excitation*, and not an electron *transfer* from water to dyestuff (as assumed above for the inorganic cations, Ce^{++++} and Fe^{+++}). In this case, the oxidation of water must be brought about by a secondary electron transfer from water to the excited dyestuff ion. Processes of this kind are known to occur between excited dyestuff ions and other electron donors, as, for example, ferrous ions. As shown by Weber (1931), Weiss (1935) and Rabinowitch (1940), excited thionine or methylene blue cations oxidize ferrous ions, even though in the dark the reaction proceeds in the opposite direction, in accordance with the positions of the normal oxidation-reduction potentials:

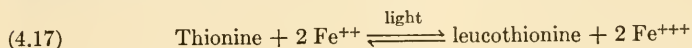

For example, at $p\text{H}$ 3, the normal potential of the system thionine-leucothionine is approximately -0.3 volt, while that of the system Fe^{+++} - Fe^{++} is approximately -0.75 volt. Nevertheless, in light, ferrous ions are oxidized by thionine ions, and it takes the system several seconds to come back to equilibrium in the dark.

The slowness of the back reaction may be attributed to a peculiar relation between ΔH and ΔF in reaction (4.17). The normal potentials indicate that the free energy of this reaction is strongly positive; but its heat effect probably is negative. The free energies of hydrogenation of most organic systems, including thionine, are less negative than the total energies—that is, the reduced state has a smaller entropy. The relation is reversed in the case of the reduction of ferric ions by hydrogen. Consequently, the reversal of reaction (4.17) is an endothermal reaction, and as such cannot proceed with a high velocity.

This more or less accidental circumstance is the explanation why, in the thionine-iron system, the shift in the oxidation-reduction equilibrium by light, which usually is hidden by rapid back reactions, becomes easily observable, even though it remains transient.

It can be asked whether, in the absence of ferrous ions, a reversible reaction does not occur between dye and the *solvent* (even if with a smaller quantum yield and with a more rapid back reaction). Such "hidden" oxidation-reductions have been held responsible for the photo-voltaic effect of dyestuff-coated electrodes by Audubert and coworkers, Hoang Thi Nga (1935) and Stora (1935, 1936, 1937). In the same way, the directly observable reversible reduction of thionine by ferrous ions has been shown by Rabinowitch (1940²) to produce a strong photo-galvanic effect.

If oxygen is present in aqueous dyestuff solutions, one could expect some of the leuco dye formed by the oxidation of water to be reoxidized

by oxygen, thus leaving an equivalent quantity of oxidized water. In other words, we could expect the occurrence of a dyestuff-sensitized formation of hydrogen peroxide, according to equation (4.14), by the mechanism which was contemplated above in the case of the zinc oxide sensitization. Blum and Spealman (1933) have in fact claimed the formation of hydrogen peroxide in illuminated fluorescein solutions, and Yamafuji and coworkers (1938, 1939) have also obtained positive hydrogen peroxide tests with illuminated solutions of chlorophyll, eosin and hematoporphyrin.

While the dyestuff-sensitized "photoautoxidation" of water, indicated (but by no means proved) by the experiments of Blum and Spealman and Yamafuji, appears explicable according to the hypothesis of "hidden" photochemical oxidation-reduction reactions, the alleged formation of hydrogen peroxide in *oxygen-free* dyestuff solutions is, if true, a much more remarkable phenomenon. Yamafuji and coworkers (1938-1939) have asserted that illuminated tissue extracts, dyestuff solutions, and zinc oxide suspensions also produce hydrogen peroxide in the absence of oxygen, although much less than under aerobic conditions. As discussed on page 73, this result (if true) would indicate a sensitized decomposition of water into hydrogen and hydrogen peroxide, according to equation (4.4). In the case of zinc oxide, the energy of two ultraviolet quanta (about 75 kcal per einstein) is sufficient to bring about reaction (4.4); but two quanta of visible, particularly red light (60-40 kcal per einstein), are insufficient for this purpose. This makes us doubt whether oxygen (or other oxidants) have actually been eliminated in the experiments of Yamafuji and coworkers. The problem is too important to allow the acceptance of their results without further confirmation. Baur and Rebmann (1921) have attempted to achieve a sensitized photolysis of water in visible light, using uranyl salts, quinine, eosin, rhodamine and other sensitizers, but could obtain no traces of oxygen.

C. THE CHEMICAL AND PHOTOCHEMICAL REDUCTION OF CARBON DIOXIDE *

If one primary photochemical process in photosynthesis is the hydrogen transfer from water to an intermediate acceptor, the reduction of carbon dioxide may be brought about either by a second photochemical reaction, or by a "dark" enzymatic reaction with the reduced primary hydrogen acceptor (*cf.* Chapter 7). We are therefore interested, in the present chapter, both in photochemical and nonphotochemical reduction of carbon dioxide *in vitro*.

* Bibliography, page 96.

1. Chemical Reduction of Carbon Dioxide

So far, carbon dioxide has been reduced *in vitro* only by means of the strongest available reductants, or at high temperatures.

Fenton (1907) described the reduction of carbon dioxide to formaldehyde by magnesium, while Bredig and Carter (1914) have achieved the reduction of carbon dioxide to formic acid by means of hydrogen and palladium. Reactions of this type are of no use in artificial photosynthesis. Imagine, for example, that we would begin by reducing carbon dioxide with magnesium, and—to provide a similar start at the other end of the reaction chain—oxidize water with fluorine. We would thus obtain magnesium oxide and hydrogen fluoride as the first reaction products. Bringing these two compounds together will lead to the formation of magnesium fluoride, and the completion of the reaction cycle would now require the photochemical dissociation of this salt into metal and halogen, a task considerably more difficult than photosynthesis itself.

One comparatively mild reductant which has been credited with the capacity to reduce carbon dioxide, was hydrogen peroxide. Kleinstück (1918) working in Wislicenus' laboratory, found that phosgene, diphenyl carbonate and carbonate ions, can be reduced to *formaldehyde* by heating with hydrogen peroxide under pressure. Wislicenus (1918) corrected the results, stating that the reduction product obtained from alkali carbonates (or bicarbonates) and hydrogen peroxide is *formic acid*, and suggested that the process involves the formation of *percarbonic acid* as an intermediate:

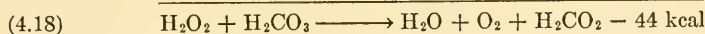
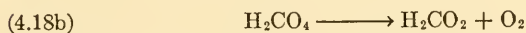
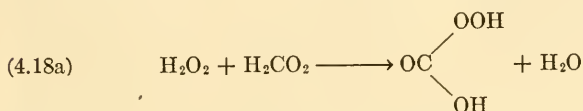

Thunberg (1923), while failing to confirm most of Kleinstück's results, claimed that formaldehyde can be obtained by boiling lead carbonate with hydrogen peroxide.

Thunberg and Weigert (*cf.* page 70) have used these results as basis for a theory according to which photosynthesis consists of a photochemical decomposition of water into hydrogen and hydrogen peroxide, and a nonphotochemical reduction of carbon dioxide by the latter two compounds:

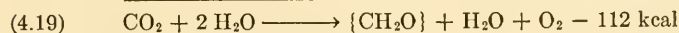
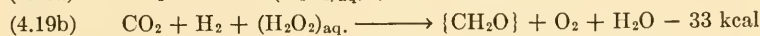
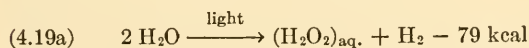

However, not only reaction (4.18), in which hydrogen peroxide alone reduces carbon dioxide, but even reaction (4.19b), in which hydrogen peroxide is assisted by hydrogen, is endothermic to such an extent that it cannot occur spontaneously at low temperatures.

Some doubts may be entertained as to the reliability of Thunberg's experiments; but, even if they are correct, they do not point a way by which carbon dioxide can be reduced at low temperatures. The energy accumulated in the oxidation of water to peroxide by oxygen (23 kcal per mole) is much too small to enable the product to reduce carbon dioxide without an external supply of energy. The oxidation-reduction potential of the system $\text{O}_2\text{-H}_2\text{O}_2$ (-0.27 volt at pH 7) is much too negative to bring about the reduction of the system $\text{H}_2\text{CO}_3\text{-H}_2\text{CO}_2$, or $\text{H}_2\text{CO}_3\text{-H}_2\text{CO}$, whose potentials (at the same pH) are above +0.4 volt (*cf.* Table 9.IV).

The first reaction in Wislicenus' scheme (4.18), is feasible, because all peroxides have approximately the same energy content; but the decomposition of percarbonic acid into formic acid and oxygen is as impossible as a spontaneous *monomolecular* decomposition of hydrogen peroxide into hydrogen and oxygen. Peroxides decompose spontaneously only by *bimolecular* dismutation into oxide and oxygen (*cf.* Chapter 11). If we replace (4.18b) by such a decomposition, the net result will be merely a carbonate-catalyzed decomposition of hydrogen peroxide.

Thus, none of the known chemical methods of reduction of carbon dioxide appears significant from the point of view of artificial photosynthesis. However, it seems probable (*cf.* Chapter 8) that the immediate substrate of reduction in nature is not free carbon dioxide at all, but carbon dioxide incorporated, by enzymatic catalysis, into a large organic molecule, probably with the formation of a carboxyl group:

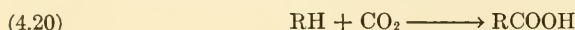

Once association (4.20) has taken place, the reduction of carbon dioxide to carbohydrate can be replaced by the reduction of the carboxyl group, RCOOH, to the carbinol group RCH₂OH:

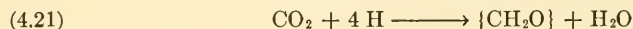
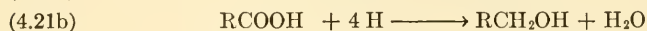

Furthermore, the reduction of one molecule of acid to one molecule of carbinol can be replaced by the reduction of *two* molecules of acid to two molecules of aldehyde, and the dismutation of the latter compound (Cannizzaro reaction):

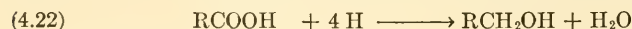
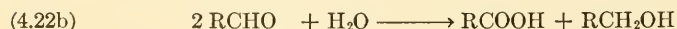
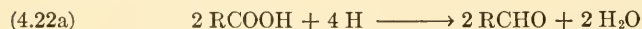

Thus, the chemical problem of carbon dioxide reduction to a carbohydrate, can be replaced by the problem of the reduction of a carboxylic acid to an aldehyde. The methods by which this reduction is achieved in organic chemistry are, however, as violent as those used for the reduction of carbon dioxide, *i. e.*, they involve either very strong reductants (sodium amalgam, or hydrogen and palladium under high pressure), or high temperatures (dry distillation of calcium salts). Thermodynamical constants show that there is not much difference between the energies of reduction of carbon dioxide and carboxyl (*cf.* Table 9.IV); but the substitution of a large molecule of a carboxylic acid for the small molecule of carbon dioxide may decrease the activation energy, and thus make the reduction easier. The free radicals, HCO₂ and H₃CO₂, which must arise as intermediates in the reduction of carbon dioxide if the

hydrogen atoms are transferred one by one, have the full energy of their unsaturated bonds; while the corresponding radicals derived from large organic molecules can often be stabilized by resonance, and therefore present much less of a barrier to a reversible reduction. We will revert to this function of free radicals in chapter 9 (page 233). At this point, we must state that we do not know of any reaction of carbon dioxide or of the carboxyl group *in vitro*, which could be called a *reversible* (or almost reversible) *reduction* of the C=O double bond to a CH—OH single bond, and that a closer inquiry into the possibilities of such a reduction would be important for the study of artificial photosynthesis.

2. Decomposition and Reduction of Carbon Dioxide in Ultraviolet Light

In describing the photochemical oxidation of water, we started with the direct effects of ultraviolet light; similarly, we begin now with the nonsensitized photochemical decomposition of carbon dioxide by ultraviolet light.

The spectrum of the molecule CO_2 consists of discrete bands, from 200 $\text{m}\mu$ to 103 $\text{m}\mu$; thus, the primary process is electronic excitation rather than photochemical decomposition. Figure 7 shows the extinction curves of the ions, CO_3^{--} and HCO_3^- in water. In this case, the primary process probably is an electron transfer from the ion to water:

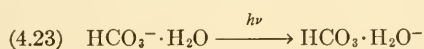

that is, an *oxidation* of the carbonate and *reduction* of water. This is hardly an appropriate initial step towards the *reduction* of the carbonate and *oxidation* of water.

The effect of ultraviolet light on carbon dioxide was first observed by Chapman, Chadwick and Ramsbottom (1907) and Herschfinkel (1909). They found that carbon dioxide gas decomposes in light with an increase in pressure (*i. e.*, probably into carbon monoxide and oxygen), until a stationary state is reached. Berthelot and Gaudechon (1910) found that ultraviolet light accelerates both the dissociation of carbon dioxide and

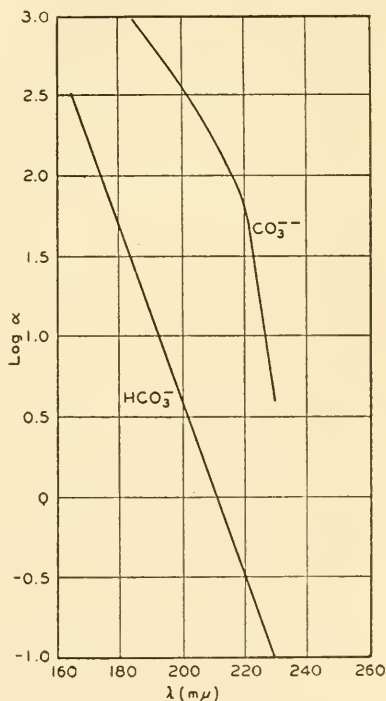

FIG. 7.—Molar extinction curves of CO_3^{--} and HCO_3^- in water (after Ley and Arends).

the recombination of carbon monoxide and oxygen. The photostationary state:



was investigated by Coehn and Sieper (1916), Tramm (1923), Coehn and Spitta (1930) and Coehn and May (1934), with particular emphasis on the effect of *moisture*. They found that the decomposition has a maximum at a certain moderate degree of drying, and is inhibited both by an excess and by a complete absence of water. The mechanism of this twofold effect of water remains unexplained.

From the point of view of photosynthesis, it would be interesting if this effect were due to a photochemical reaction between carbon dioxide and water; but Thiele (1908) and Coehn and Sieper (1916) have asserted that this is not the case, and that the influence of water is a purely catalytic one. Also, Stoklasa and Zdobnický (1910, 1911) and Stoklasa, Šebor and Zdobnický (1912, 1913) found that no formaldehyde is formed by the illumination of carbonic acid in *solution*, while Baly, Heilbron and Barker (1921), Dhar and Sanyal (1925) and Mezzadroli and Gardano (1927) asserted that small quantities of formaldehyde can be obtained in this way. This was disputed by Baur and Rebmann (1922), Spoehr (1923) and Porter and Ramsperger (1925), who found the yield of formaldehyde to decrease with increasing purity of the reactants. However, Baly, Davies, Johnson and Shanassy (1927) reiterated this organic matter is formed by illumination of carbonate solutions with ultraviolet light, claiming this time that it was not formaldehyde, but an undefined higher aldehyde. Mezzadroli and Varetton (1931) claimed that the yield of formaldehyde can be increased by preliminary ionization of carbon dioxide by emanation or electric discharges.

It is difficult to judge whether the newer claims of Baly, Dhar, and Mezzadroli and coworkers deserve more confidence than the older ones. The positive test for formaldehyde in illuminated carbon dioxide solutions, described by Joo and Wingard (1933), is anything but convincing, since it was obtained by Allison's "magneto-optic analysis," whose reliability is open to serious doubts.

If it should be confirmed that traces of formaldehyde are formed by ultraviolet illumination of carbonate solutions, this phenomenon may be of some interest from the point of view of the *origin of organic matter on earth*. The *first carbohydrates* may have been formed, from carbonic acid and water, by the *ultraviolet light*, which reaches the higher layers of the atmosphere. Dhar and Ram (1933) have analyzed *rain water* and found (by iodine titration) 1.5×10^{-3} to $1 \times 10^{-2}\%$ of formaldehyde, the larger values being obtained after long periods of sunshine. They suggested that the photochemical formation of formaldehyde occurs at,

or even above the level where ozone is formed (about 50 km. above the surface), since no rays with wave lengths $< 290 \text{ m}\mu$ are available below this layer. From the point of view of artificial photosynthesis, or of natural photosynthesis under the present terrestrial conditions, it appears entirely irrelevant whether traces of formaldehyde can be formed by ultraviolet illumination of carbonate solutions or not. In dealing with photochemical reactions, it must be kept in mind that the energy available in one quantum, particularly a quantum of ultraviolet light, is much larger than the activation energy required for most, if not all chemical reactions. Thermal reactions take place when the energy of molecular vibrations, together with the collision energy, are just sufficient to bring the reacting molecules over the top of an "activation pass" in the many-dimensional relief map representing the potential energy of the reacting system as a function of its various configuration co-ordinates. This favors a uniform fate for all these molecules, which all drop into the same "potential valley." Activation by light absorption, on the other hand, often breaks molecules into free atoms and radicals, thus lifting the system onto a high energy plateau from which it can descend into many different valleys, corresponding to more than one set of reaction products. In the rearrangement of radicals formed from carbon dioxide and water by the absorption of quanta with an energy of 150 kcal per einstein, a few may err into the shallow potential trough of formaldehyde, and miss the opportunity to drop into deeper valleys, representing more stable configurations. In this way, traces of formaldehyde may be formed by an entirely accidental side reaction, which can have nothing in common with the highly specific and purposeful mechanism of photosynthesis.

The same consideration applies to experiments in electric discharge tubes, irradiation with x-rays, and other treatments which break the molecules and afford the opportunity for the rearrangement of the broken pieces into all kinds of new patterns. The formation of formaldehyde by silent electric discharges and corona discharges in carbon dioxide—described by Losanitsch and Jovitschitsch (1897), Berthelot (1898, 1900), L6b (1905, 1906), Gibson (1908), Holt (1909), Moser and Isgarishev (1910) and Lunt (1925)—had for a while aroused much interest as an approach to the problem of artificial photosynthesis. In our opinion, the only aspect of these observations which may conceivably be of importance for the understanding of photosynthesis, is the contribution of atmospheric discharges to the first synthesis of organic matter on earth.

The results discussed above show that, even when the molecules of carbon dioxide and water are broken to pieces and allowed to recombine at random, the chance that they will form formaldehyde and oxygen is very small. The same also seems to be true for mixtures of carbon dioxide and hydrogen, despite the fact that in this case, the system CH_2O and H_2O represents as deep a potential trough as did the system $\text{CO}_2 + 2 \text{H}_2$ in its initial state. Thiele (1908) found no formaldehyde after the ultraviolet illumination of hydrogen-carbon dioxide mixtures, while Berthelot and Gaudechon (1910), Coehn and Sieper (1916) and Mezzadrolì and Babes (1929) asserted that some

formaldehyde is formed under these conditions. Stoklasa and Zdobnický (1912, 1913) emphasized particularly the alleged photochemical production of formaldehyde from carbon dioxide in presence of *nascent* hydrogen. They suggested that this is the actual photochemical reaction in photosynthesis, and that nascent hydrogen can be formed in the plant by an enzymatic reaction. Since the reduction of carbon dioxide by hydrogen liberates a small amount of energy, while the dissociation of water into hydrogen and oxygen requires even more energy than photosynthesis itself:

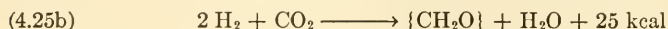
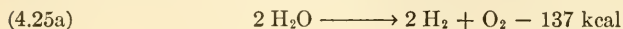

—it is obviously absurd to suggest that the first reaction is thermal and the second photochemical.

3. Sensitized Reduction of Carbon Dioxide

This section describes the investigations in which “artificial photosynthesis” has been claimed as an accomplished fact. Their usual technique was to illuminate carbon dioxide solutions in presence of different “sensitizers” and then search for traces of formaldehyde or other organic compounds as ardently as alchemists have searched for a grain of gold in the bottom of their crucibles. More often than not, no specific reductant was provided for the reduction of carbon dioxide, and the assumption that water acted as such was made without any attempt to confirm it by proving the liberation of oxygen.

In our discussion of these experiments, we will endeavor to keep apart the two phenomena defined in the discussion of the sensitized oxidation of water: *true photocatalysis* (either of the *decomposition* of carbon dioxide, or of the *reduction* of carbon dioxide by a specific reductant) and photoreduction of carbon dioxide (or its derivatives) by the “sensitizer” itself.

In 1893, Bach found that a solution of carbon dioxide and *uranyl acetate* reacts in light; uranium oxides are precipitated, and Bach thought that carbon dioxide might be reduced to formaldehyde. The same “sensitizers” (uranyl salts) were used by Usher and Priestley (1906) and Moore and Webster (1918). The last named authors thought the *colloidal state* of the sensitizer to be of particular importance; they obtained positive formaldehyde tests in illuminated carbonate solutions containing colloidal uranium and iron salts, and thought that these results afford an explanation of natural photosynthesis, since colloidal iron compounds are present in the chloroplasts (*cf.* Chapter 14, page 376). Apart from doubts concerning the correctness of the experimental results of Moore and Webster (*cf.* page 89), we must ask what happened in these experiments to the “sensitizers.” Did they remain unchanged,

thus playing the part of true photocatalysts, or did they also serve as reductants? Of course, to reduce carbon dioxide by uranyl salts or ferrous salts would be an important success, since the oxidation-reduction potentials of these substances are far below the potential of the system $\text{CO}_2\text{-H}_2\text{CO}$. Still, this reduction would represent only one-half of photosynthesis, the remaining half being the reduction of the oxidized catalyst (*e. g.*, ferric iron) by water, leading to the liberation of oxygen (as in Hill's experiments with isolated chloroplasts). It is, however, improbable that Moore and Webster have achieved even that much, since Baur and Rebmann (1922), in attempts to repeat their experiments, have failed to observe any formation of formaldehyde, oxalic, glyoxalic or formic acid, not to speak of evolution of oxygen.

(a) *The Experiments of Baly and Dhar*

The subsequent development of the subject, in two long series of publications, one by Baly and coworkers in Liverpool (1927-1940) and the other by Dhar and coworkers in Allahabad (India) (1925-1933), brought many spectacular claims, but no convincing results. One is therefore tempted to dispense with their presentation altogether; but wishing the reader to be able to form his own opinion as to the validity of claims which have been repeated so persistently (lastly, in Baly's monograph, *Photosynthesis*, published in 1940), we will review in some detail the experiments on which these claims were based.

Baly's experiments have attracted most attention, because of the reputation of the author, and of the comparatively large yields of organic matter which he and his coworkers claimed to have obtained in their first investigations.

Baly, Davies, Johnson and Shanassy (1927), employed *white* powders (barium sulfate or alumina) as sensitizers, and used ultraviolet light. Baly, Stephan and Hood (1927) went over to the use of *colored* powders (basic carbonates of nickel and cobalt), illuminated by incandescent lamps. Carbon dioxide was bubbled for several hours through illuminated vessels containing these powders suspended in water; the solution was then separated from the powder and evaporated. A gummy residue was obtained which gave some aldehyde and sugar reactions (reduction of Benedict's solution, Molisch test; Rubner test; osazone formation). The carbonates soon lost their "catalytic" capacity; Baly attributed this to their oxidation by the oxygen produced by photosynthesis (no direct test for oxygen production was ever attempted). The yield of "artificial carbohydrates," obtained by Baly and Davies (1927) was up to 75 mg. in two hours, in a vessel with a surface of 300 sq. cm., *i. e.* "about equal to the yield of natural photosynthesis on an equal area covered by vegetation." Baly and Hood (1929) found that the rate of "artificial photosynthesis" increased between 5° C. and 31°, and declined between 31° and 41°, like that of natural photosynthesis.

Difficulties in reproducing these first promising results soon arose, and the next ten years were spent on attempts to prepare reliable catalysts.

In 1931, Baly reported two new methods for obtaining catalytically active preparations: electrolytic precipitation of basic nickel or cobalt carbonates, and deposition of thorium oxide—"promoted" ferric or chromic oxide on alumina-coated kieselguhr (diatomaceous earth). However, Bell (1931) was unable to repeat these experiments, and the same disappointment was later experienced by Baly himself. In 1937, Baly announced that "two methods of preparing active catalysts have been now standardized." In 1939, he described the results obtained with these new catalysts; the whole development, from the "early investigations" to the "final achievement of photosynthesis of carbohydrates," was reviewed in Baly's monograph, *Photosynthesis*, in 1940.

The two new methods of preparation of the sensitizers were: (a) the deposition of *nickel oxide* or *cobalt oxide* on kieselguhr; and (b) the precipitation of (unsupported) nickel oxide by the addition of potassium bicarbonate to a solution of nickel nitrate, and heating of the precipitate *in vacuo*. The first method, although more complicated, had the advantage that the supported oxide layers did not dissolve in carbon dioxide-saturated water.

In the investigation of Baly, Pepper and Vernon (1939), the surface potentials (ζ potentials) of the oxide-coated kieselguhr powders were measured by cataphoresis, and it was concluded that the coating consisted of three monomolecular layers. One molecule of thorium oxide was incorporated into the surface layer for each 24 molecules of nickel oxide.

In the preparation of unsupported oxide, attention was directed to the avoidance of the adsorption of alkali, which, according to Baly, is the main source of trouble with oxide catalysts. The unsupported catalysts, too, were prepared with one molecule of ThO_2 as "promoter" for each 24 molecules of NiO .

The successes obtained with the new preparations did not go beyond those achieved in 1927. Ten to 20 g. of the catalyst were suspended in 1.5 liters of air-free, carbon dioxide-saturated water, at 30°C ., and illuminated for two hours by two 250-watt lamps. The irradiated liquid, separated by filtration, gave a positive Molisch test upon saturation with sulfur dioxide. If the solution was left standing for two hours, or heated to 60° , the test became negative; this was taken as proof that the first product of artificial photosynthesis was unstable. Upon evaporation of the liquid, a whitish precipitate was obtained, which was shown by charring to contain some organic matter; but 30 mg. of this matter, collected from several irradiations, gave only traces of carbon dioxide and water in a microcombustion. This was attributed by Baly to the content of the precipitate in silica and was not considered by him as a decisive argument against its predominantly organic nature. The precipitate was taken up in a little water, and treated for two hours with takadiastase at 37° . The product, tested with Fehling's solution, gave 7-8 mg. of cuprous oxide. This was taken as a proof that the white precipitate contained "a kind of starch," which the diastase had converted into a reducing sugar. The yield of cuprous oxide could not be increased by prolonged irradiation; this was attributed by Baly to a poisoning of the catalysts by the products of photosynthesis.

This is what Baly called the "final achievement" of photosynthesis *in vitro*! It contained no proof of oxygen liberation; no proof of carbon

dioxide consumption; and only an unsuccessful attempt to prove the formation of organic matter by combustion.

The obvious incompleteness of experimental evidence did not prevent Baly from giving a detailed picture of how six-membered inositol rings grow on the surface of nickel oxide around "hubs" provided by thorium oxide molecules; and how a similar growth occurs in nature on the surface of chlorophyll crystals, also provided with an appropriate number of "anchor points" consisting of "impurities." Baly postulated—without any proof—that nickelous oxide is oxidized in light by carbon dioxide to nickelic oxide, and the latter decomposes into nickelous oxide and oxygen, and that, in nature, chlorophyll *a* is oxidized by carbon dioxide to chlorophyll *b*, and reduced back to chlorophyll *a* by carotene (*cf.* page 554).

Practically all attempts to repeat Baly's experiments elsewhere have given negative results.

Only Yainik and Trehuna (1931) have obtained positive formaldehyde tests with nickel and cobalt carbonate sensitizers (but also with other colored inorganic salts, as well as with "white powders colored blue, green or red by different dyes").

In attempting to repeat Baly's early work, Emerson (1929) found that a suspension of nickel carbonate absorbs carbon dioxide (probably by bicarbonate formation) in a completely reversible manner; this absorption is unaffected by light, and not accompanied by oxygen evolution. The negative outcome of Bell's (1931) attempts to repeat the experiments with electrolytically deposited carbonates and with kieselguhr-supported ferric oxide was mentioned before. Zscheile (1932) and Qureshi and Mohammad (1932, 1933) repeated Baly's experiments with precipitated basic nickel and cobalt carbonates, "activated" (according to Baly's preception) by illumination with a mercury arc. The same tests for sugars and aldehydes as used by Baly failed to reveal the presence of any carbohydrates.

No attempts to repeat Baly's latest experiments (1939) have as yet been published. We have no specific reasons to deny that the 5–7 mg. of cuprous oxide, which were precipitated by Fehling's solution in these experiments, were due to the presence of a reducing sugar; or that this sugar was formed by the action of diastase on "a kind of starch" (although the specificity of enzymes and the optical activity of the natural carbohydrates raises a difficult problem); or that this "starch" was formed by the reduction of carbonic acid by light and nickelous oxide. However, the inadequacy of experimental evidence and the results of previous controls outside Baly's laboratory do not encourage us to give credence to these interpretations. It may be worth stressing the fact that, even if the sugar formation should be confirmed, the assertion that it represents the result of true photosynthesis would remain arbitrary as long as no oxygen evolution has been demonstrated. The rapid cessation of the reaction certainly does not speak in favor of true catalysis.

Baly thought that he has achieved not only the photosynthesis of carbohydrates from carbon dioxide and water but also the photosynthesis of organic nitrogen compounds. Baudisch (1911, 1916), Baudisch and Mayer (1913) and Baudisch and Klinger (1916) have found that nitrate and nitrite solutions in aqueous formaldehyde or methanol are converted in daylight, first into formhydroxamic acid, $(\text{OH})\text{CH}=\text{NOH}$, and then into a large variety of complex nitrogen compounds. Baudisch suggested that, while carbon dioxide is photochemically reduced in the plants to formaldehyde ($\text{H}_2\text{C}=\text{O}$), nitrate could be reduced to a similar compound—free nitrosyl, $\text{HN}=\text{O}$, after which the two products may unite and give formhydroxamic acid. Baly, Heilbron and Hudson (1922) and Baly, Heilbron and Stern (1923) extended these experiments; and Baly,

Saunders and Morrison (*cf.* Baly 1940) claimed to have photosynthesized an amino acid, an alkaloid, and even a protein, by the ultraviolet illumination of mixtures of nitrite and formaldehyde. Baly suggested that the "co-assimilation" of carbonates and nitrites is the source of organic nitrogen compounds in plants:

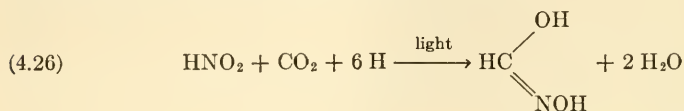

These speculations have even less of an experimental foundation than Baly's hypotheses concerning the synthesis of carbohydrates.

In another series of papers on photosynthesis *in vitro*—those of Dhar and coworkers, it was claimed that positive tests for formaldehyde were obtained after the exposure of carbon dioxide or carbonate solutions in open vessels for several hours to "tropical sunlight." (In what respect this light is different from sunlight elsewhere, or from the light of a strong artificial source, was not made clear.)

According to Dhar and Sanyal (1925), Rao and Dhar (1931^{1,2}), Rajwansi and Dhar (1932) and Dhar and Ram (1932), formaldehyde can be detected after irradiation, even in pure solutions of carbon dioxide or sodium bicarbonate; the yield can be increased by the addition of the following sensitizers: *In carbon dioxide solutions:* FeCl₃, Fe(OH)₃, FeSO₄, NiSO₄, CoCO₃, CuSO₄, CuCO₃, copper acetate, Cr₂(SO₄)₃, Cr₂O₃, Cr(OH)₃, MnCl₂, V₂O₅, NH₄-Ce-nitrate, Pd(NO₃)₂, UO₂(NO₃)₂, methylene blue, methyl orange and malachite green; *in sodium bicarbonate solutions:* Fe(OH)₃, CoCO₃, NiCO₃, ZnO, Mg and FeCO₃. No formaldehyde was found in solutions "sensitized" by cerous oxide, molybdic acid, rhodamine and safranin. The largest concentration of formaldehyde, obtained in *carbon dioxide* solutions after four hours of irradiation (in the presence of manganous chloride) was $8 \times 10^{-4}\%$, while in bicarbonate solutions yields up to $4 \times 10^{-3}\%$ have been obtained. In the presence of zinc oxide or magnesium, Dhar and Ram (1932) obtained, in four hours, 1-3 mg. of formaldehyde.

Results similar to those of Dhar were obtained by Mezzadrolì and Vareton (1928), Mezzadrolì and Babes (1929) and Gore (1934); but Burk (1927), Reggiani (1932), Qureshi and Mohammad (1932) and Mackinney (1933) were unable to confirm them. Some formaldehyde was found in experiments with dyestuffs. Since its occurrence, however, did not depend on the presence of carbon dioxide, it must have originated in the decomposition of the dyestuff (*cf.* page 68).

In refusing to accept as significant, from the point of view of photosynthesis, the results of Dhar's experiments, we take into consideration not only the danger of contamination and the generally unsatisfactory experimental technique, but also the general proposition, formulated on page 83, that as long as quantum yields remain extremely small (of the order of 10^{-5} or 10^{-6}) "everything is possible in photochemistry." This applies not only to direct effects of ultraviolet light but even to sensitized reactions brought about by the comparatively small quanta of visible

light. Once in a million absorption acts two photons may strike the same molecule or two excited molecules may collide and exchange energy, accumulating a quantum sufficiently large to cause the formation of a free atom or radical. Accidents of this kind may lead to the formation of a few molecules of formaldehyde in carbonate solutions subjected to a prolonged irradiation by visible light. The essential characteristic of natural photosynthesis is that the accumulation of energy occurs with an efficiency far in excess of anything explicable by statistical considerations. Unless we are able to imitate nature in this respect, we have no right to speak of having achieved "artificial photosynthesis"—even if we should succeed in producing traces of formaldehyde by a prolonged illumination of carbonate solutions.

(b) *The Experiments of Baur*

The series of papers by Baur and coworkers, dealing with artificial photosynthesis and related processes in a variety of systems *in vitro*, remain to be discussed. In many respects, they compare advantageously with the attempts of Baly and Dhar. Unfortunately, Baur's adherence to a strange theory—the reduction of all photochemistry to electrochemistry (*cf.* page 90) makes the reading of his papers difficult. The variety of systems investigated by Baur and coworkers was imposing, and the results were always reported in a scrupulous fashion. Nevertheless, we do not believe that artificial photosynthesis has been achieved by Baur. Aside from the one very complex system (acetate silk-chlorophyll-cetyl alcohol) whose illumination allegedly yielded as much as 20 moles of formaldehyde per mole of chlorophyll present, the essence of all the other experiments was the formation of formaldehyde in quantities roughly equivalent to those of the sensitizing dyes used, and very small compared with the total quantity of the other organic components of the reacting system. The assumption that this formaldehyde was formed by the reduction of a carboxyl group, or of carbonic acid (and not by oxidation of an alcohol or hydrocarbon) cannot be considered as proved. The formation of oxygen was claimed only in an experiment which was termed by Baur himself as "preliminary" and in a recent investigation, of which only an abstract could be obtained (*cf.* p. 93).

His first papers (Schiller and Baur 1912, Baur and Rebmann 1922, and Baur and Büchi 1923) were concerned with the refutation of the claims by Usher and Priestley (1906), Moore and Webster (1913, 1918) and Baly, Heilbron and Barker (1921). In addition to showing that colloidal ferric oxide, ferric chloride, uranium oxide, sodium uranate, and malachite green do not convert carbon dioxide in light into formaldehyde or formic acid (as asserted by the above-mentioned authors), Baur and Büchi (1923) also investigated the action of dyestuffs (eosin, phosphine, malachite green) in non-aqueous systems (lecithin emulsions in xylene), as well as in the adsorbed state (on cotton and silk fiber) in the form of resinates, etc. No oxygen evolution was observed,

and when formaldehyde was found (as in the case of malachite green), it could be detected also in absence of carbon dioxide, and thus must have originated in the decomposition of the dyestuff.

In later papers, Baur was not satisfied with the provision of a *sensitizer*, but attempted also the substitution of a stronger *reductant* (in place of water) or of a less reductant *oxidant* (in place of carbonic acid). He was guided in these experiments by a concept of photochemistry as "molecular electrochemistry." He considered a molecule excited by light absorption as "polarized," with a positive and a negative pole, and treated all photochemical reactions as "depolarizations" brought about by the transfer of charges from the "light-polarized" molecule to appropriate acceptors. Although this picture has little in common with well-founded concepts of molecular excitation, it can be used without much harm as a description of certain facts of sensitization. An excited molecule has no "plus" and "minus" pole, but it can have both an increased affinity for an electron (*i. e.*, the properties of an oxidant), and the tendency to lose an electron (*i. e.*, the properties of a reductant). When the excited molecule meets a reductant, it may oxidize it, by taking away an electron (Baur's "cathodic depolarization"). If it meets an oxidant, it can reduce it by donating an electron (Baur's "anodic depolarization").

Baur's conception proved useful in practice in that it induced him to pay attention to the nature of the "depolarizers," that is, to provide complete oxidation-reduction systems, and not to be satisfied with the reduction of carbon dioxide without asking whether the part of the reductant was played by water, by the sensitizer itself, or by some accidental component of the system.

In a series of experiments, Baur has attempted to achieve the photochemical reduction of carbon dioxide by providing, in addition to sensitizers, reductants ("anodic depolarizers") which can be expected to donate their electrons more willingly than the water molecules. He tried (1928) urea, cyanamide, cyanide, benzidine and sodium sulfite (in benzene), with eosin, resinate dyes or chlorophyll as sensitizers. He also attempted the fixation of the sensitizer by adsorption on carbonates (magnesia alba) and the combination in one molecule of the oxidant (carbonate ion) and sensitizer (uranyl ions, ferrous ions). He also used iron-substituted permutites (for a still stronger fixation of the sensitizers) and colored lacquers, in which tannin was supposed to create a molecular link between carbonate and sensitizer. All these experiments gave negative results; no formaldehyde was produced, and no oxygen was liberated. Similarly negative results were obtained also by Reggiani (1932), who used eosin, quinine sulfate, methylene blue, rhodamine, thionine, and methyl orange as sensitizers, in both artificial light and sunlight, and sodium sulfide, hydrogen, zinc, Dewarda alloy, pyrogallol and hydroquinone as reductants.

In another series of experiments, Baur substituted carboxyl groups for carbonate ions as substrates of reduction (*cf.* page 80). At first (1928), he used β -resorcylic acid and other polyphenolcarboxylic acids. Then he tried carboxyl-containing dyestuffs, gallocyanin and pseudopurpurin, with different reductants ("anodic depolarizers"), in the hope that uniting sensitizer and oxidant (carboxyl) in one molecule might yield some success. However, no oxygen or formaldehyde were obtained in these experiments as well.

In subsequent experiments, (1935), Baur arrived at the conclusion that *chlorophyll* is capable of producing formaldehyde by the reduction of its two carboxyl groups (*cf.* Formula 16.III), and, what is more, that this oxidation can be carried out *at the cost of water*, by the intermediary of an "auxiliary" reversible oxidation-reduction system, *e. g.*, methylene

blue-leuco methylene blue. This conclusion—which, if correct, would be of extraordinary importance for the theory of photosynthesis, and for the imitation of this process *in vitro*—was based on the observation that formaldehyde can be detected in water in which collodion films impregnated with alcoholic solutions of the two dyestuffs have been exposed to light. We mentioned on page 68 the controversy concerning the formaldehyde formation by gelatin films containing only chlorophyll. Baur found no formaldehyde after the illumination of pure chlorophyll-collodion films, but obtained positive results with chlorophyll-methylene blue films. One possible explanation of these results is the *photooxidation* of methyl groups in methylene blue by chlorophyll (or of methyl groups of chlorophyll by methylene blue); but Baur suggested a more complicated mechanism, described by the series of equation (4.27) in which excited chlorophyll molecules are alternatively “depolarized” by hydrogen and hydroxyl ions, and whose final result is the oxidation of water by the carboxyl group of chlorophyll, with methylene blue playing the part of a catalyst (XCOOR is chlorophyll, MB is methylene blue and MB^{−−} is leuco methylene blue):

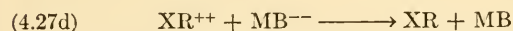
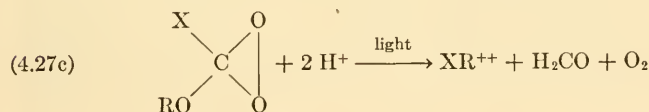
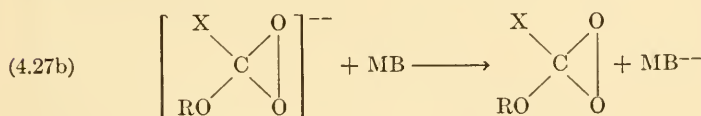
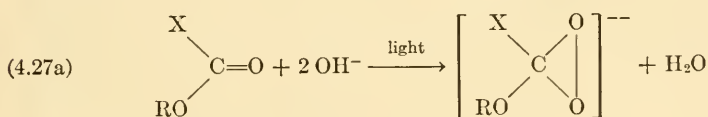

The scheme is obviously a very arbitrary one. Baur, however, used it as a starting point for a whole series of experiments. First, he showed (Baur and Fricker 1937) that chlorophyll can be replaced by eosin and that other reversibly reducible dyestuffs or inorganic redox systems can be substituted for methylene blue. Instead of collodion films, he found colophony (rosin) suspensions in water more suitable. The “sensitizer” (chlorophyll or eosin) was contained in the sol particles, the “auxiliary” redox pair in the aqueous phase. The auxiliary systems included thionine, malachite green, safranin, quercetin, Janus red, neutral red, phenosafranin, gallocyanin, hydroquinone, Nile blue and ferric chloride,

i. e., systems of widely different oxidation-reduction potentials. However, formaldehyde was obtained with all of them, and none was obtained from chlorophyll or eosin sols in the absence of an auxiliary system. The yield was from 16 to 70% of the material available in the two carboxyl groups of chlorophyll. Baur attached a particular importance to experiments with ferric salts and quercetin because both are common components of plants.

In this work, no attempt was made to prove the evolution of oxygen. Assuming that oxygen might cause a partial photooxidation of chlorophyll, Baur attempted to improve the yield by adding substances capable of "catching" oxygen,—rubrene and carotene. Rubrene (in benzene) was without effect; carotene (in palm oil suspension) increased the yield by about 30%, which was considered as significant. No formaldehyde was obtained from chlorophyll adsorbed on alumina (suspended in methylene blue solution); from nonfluorescent chlorophyll, preparations (copper phaeophytin) and from water-soluble dyes (*e. g.* gallocyanin), which gave no two-phase systems. Baur and Gloor (1937) tested several other dyes as sensitizers and oxidants, and found that only esterified compounds can be used, whereas compounds containing free carboxyl groups gave no formaldehyde. Rhodamine derivatives were found to be even better oxidants than eosin. Baur, Gloor and Künzler (1938) obtained positive results with rhodamine both in colophony sols and collodion films, and found an increase of the yield with increasing length of the alcohol molecule in the ester; the free acid, rhodamine B, was ineffective. They endeavored further to bring about suitable conditions for the recarboxylation of the (supposedly) decarboxylated dyestuff; and thought that the use of "ol" phases (higher alcohols), which take carboxylic acids out of the aqueous phase, might help to shift the equilibrium $RH + CO_2 \rightleftharpoons RCOOH$ towards a more complete carboxylation (*cf.*, however, Chapter 8, page 179). Different "ol" compounds were found useful, particularly geraniol. The authors then used a carbon dioxide atmosphere, to favor still more the recarboxylation of the oxidant. Positive results were obtained, however, only with two very special systems: mashed leaves in geraniol, and acetate silk-chlorophyll-cetyl alcohol. The latter system formed twenty times more formaldehyde than could be accounted for by the carboxyl groups of chlorophyll. This experiment was announced as the first successful photochemical reduction of carbon dioxide *in vitro*. Baur also tried to give the proof of complete photosynthesis in this system by demonstrating the liberation of oxygen; but the analytical results were not very consistent and the authors themselves termed them "preliminary."

Baur, Gloor and Künzler (1938) found that positive results can also be obtained with sensitizers not containing esterified carboxyl groups, if

a higher alcohol is provided which is capable of binding carbon dioxide in a substituted carbonic acid ester:



In other words, carbon dioxide must be bound to a "lipophilic" organic molecule, and thus held in the nonaqueous phase. Whether this is

achieved by the formation of an esterified carboxyl group, $\text{R}_1-\overset{\text{O}}{\parallel}{\text{C}}-\text{OR}_2$,

or by the formation of a carbonic acid ester, $\text{HO}-\overset{\text{O}}{\parallel}{\text{C}}-\text{OR}$, is unimportant; in both cases, if R is sufficiently large, the product is lipophilic and does not pass into the aqueous phase. (The absence of free carboxyl reduces the affinity to water.) In the first case, the oxidant can also be the sensitizer; in the second case, a separate sensitizer must be added. Baur, Gloor and Künzler used acetate silk, colored with "cibacet" or "celliton" dyes, coated with cetyl alcohol and suspended in aqueous methylene blue solution, which also contained suspended calcium carbonate. From all these experiments, Baur concluded that the prerequisite of artificial photosynthesis is a *two-phase system*, with the *sensitizer and oxidant in a nonaqueous phase*, and the *reductant and an "auxiliary oxidation-reduction system" in the aqueous phase*.

In 1943 Baur and Niggli announced that two-phase systems containing chlorophyll in geraniol or phytol (*e. g.*, 50 mg. chlorophyll in 25 ml. geraniol), and methylene blue in dry glycerol (*e. g.*, 30 mg. in 50 ml.), produced steadily from circulating carbon dioxide gas both oxygen and formaldehyde, at a rate of about 5 mg. per 24 hours, which corresponds to about 5% of the saturation yield produced by the same quantity of pigment in a living plant.

Bukatsch (1939) thought that *ascorbic acid* (*cf.* Chapter 10) may play the part of the "auxiliary system." He therefore compounded two-phase mixtures containing ascorbic acid (chlorophyll in colophony or lecithin; ascorbic acid in water), and obtained positive formaldehyde tests (with Schiff's reagent) after illuminating these systems for 5-15 hours with 25,000 lux.

Our opinion of Baur's work was stated at the beginning of this discussion. Despite the unnecessary complication introduced by the "electrophotochemical" terminology, the general idea of the research was sound. The provision of complete oxidation-reduction systems, the substitution of less reluctant oxidants and reductants for carbon dioxide and water, the attempts to unite the reactants in molecular complexes, and to separate the products by the provision of two phases—all these were reasonable steps towards the reproduction of the essential

conditions of photosynthesis. However, the technique of Baur's experiments was so primitive, and so devoid of the modern quantitative approach to the problems of photochemistry, and conclusions were drawn so hastily, that it is impossible to accept any of them as well founded, let alone proved. The experiments of Baur were hurried excursions along paths which, if more patiently explored, may perhaps one day lead to important results.

Bibliography to Chapter 4

Photosynthesis and Related Processes Outside the Living Cell

A. *Dead Cells, Isolated Chloroplasts, and Chlorophyll Preparations*

- 1881 Engelmann, Th. W., *Botan. Z.*, **39**, 441.
 1888 Haberlandt, G., *Flora*, **71**, 291.
 1896 Ewart, A. J., *J. Linnean Soc. London J. Botany*, **31**, 423.
 1901 Friedel, J., *Compt. rend.*, **132**, 1138.
 Friedel, J., *ibid.*, **133**, 840.
 Harroy, M., *ibid.*, **133**, 890.
 1902 Herzog, R. O., *Z. physiol. Chem.*, **35**, 459.
 1903 Macchiati, *Bull. soc. botan. ital.*, **1903**.
 1904 Molisch, H., *Botan. Z.*, **62**, 1.
 Bernard, Ch., *Compt. rend.*, **140**, 509.
 1905 Bernard, Ch., *Botan. Centr. Beihefte*, **16**, 1.
 1906 Usher, F. L., and Priestley, J. M. V., *Proc. Roy. Soc. London B*, **78**, 318.
 1908 Ewart, A. J., *ibid.*, **80**, 30.
 1909 von Euler, H., *Z. physiol. Chem.*, **59**, 122.
 1910 Shryver, S. B., *Proc. Roy. Soc. London B*, **82**, 226.
 1912 Schiller, H., and Baur, E., *Z. physik. Chem.*, **80**, 669.
 1914 Warner, C. H., *Proc. Roy. Soc. London B*, **87**, 378.
 Wager, H., *ibid.*, **87**, 386.
 1915 Chodat, R., and Schweizer, K., *Arch. sci. phys. nat.*, **39**, 334.
 1918 Willstätter, R., and Stoll, A., *Untersuchungen über die Assimilation der Kohlensäure*. Springer, Berlin, 1918.
 1923 Eisler, M., and Portheim, L., *Biochem. Z.*, **135**, 293.
 1925 Molisch, H., *Z. Botan.*, **17**, 577.
 1935 Inman, O. L., *Cold Spring Harbor Symposia Quant. Biol.*, **3**, 184
 Baur, E., *Helv. Chim. Acta*, **18**, 1157.
 1937 Rabinowitch, E., and Weiss, J., *Proc. Roy. Soc. London A*, **162**, 251.
 Hill, R., *Nature*, **139**, 881.
 Baur, E., and Fricker, H., *Helv. Chim. Acta*, **20**, 391.
 1938 Baur, E., Gloor, K., and Künzler, H., *ibid.*, **21**, 1038.
 Smith, E. L., *Science*, **88**, 170.
 Knoll, A. F., Matthews, Jr. F. L., and Crist, R. H., *J. Chem. Phys.*,
6, 109.
 Kautsky, H., *Naturwissenschaften*, **26**, 14.
 Inman, O. L., *Plant Physiol.*, **13**, 859.

- 1938 Inman, O. L., *Science*, **88**, 544.
 1939 Hill, R., *Proc. Roy. Soc. London B*, **127**, 192.
 1940 Hill, R., and Scarisbrick, R., *Nature*, **146**, 61.
 Hill, R., and Scarisbrick, R., *Proc. Roy. Soc. London B*, **129**, 238.
 1942 French, C. S., Newcomb, E., and Anson, M. L., *Am. J. Botany*,
29, 83.

B. Photochemical Oxidation of Water

- 1863 Vogel, H. W., *Ann. Phys.*, **119**, 407, 497.
 1906 Eder, J., *Photochemie*, in *Ausführliches Handbuch der Photographie*
 3rd ed., Knapp, Halle, 1906; p. 208.
 1908 Baur, E., *Z. physik. Chem.*, **63**, 683.
 Thiele, H., *Ber. deut. chem. Ges.*, **40**, 4914.
 1909 Kernbaum, M., *Compt. rend.*, **149**, 273.
 Kernbaum, M., *Le Radium*, **6**, 225.
 1910 Coehn, A., *Ber. deut. chem. Ges.*, **43**, 880.
 Berthelot, D., and Gaudechon, H., *Compt. rend.*, **150**, 1690.
 Berthelot, D., and Gaudechon, H., *J. pharm. chim.*, (7), **2**, 5.
 1911 Sichling, K., *Z. physik. Chem.*, **77**, 20.
 1912 Coehn, A., and Grote, G., *Nernst Festschrift*. Knapp, Halle, 1912,
 p. 136.
 1916 Tian, A., *Ann. phys.*, **5**, 248.
 1918 Baur, E., *Helv. Chim. Acta*, **1**, 186.
 1919 Baur, E., *Z. Elektrochem.*, **25**, 102.
 Svensson, T., *Arkiv. Kemi Mineral. Geol.*, **7**, No. 19.
 1921 Baur, E., and Rebmann, A., *Helv. Chim. Acta*, **4**, 256.
 1925 Wood, R. W., *Phil. Mag.*, **50**, 774.
 1926 Senftleben, H., and Rehren, I., *Z. Physik*, **37**, 529.
 1927 Baur, E., and Neuweiler, C., *Helv. Chim. Acta*, **10**, 901.
 Bates, J. R., and Taylor, H. S., *J. Am. Chem. Soc.*, **49**, 2438.
 1928 Gaviola, E., and Wood, R. W., *Phil. Mag.*, **6**, 1191.
 1930 Beutler, H., and Rabinowitch, E., *Z. physik. Chem. B*, **8**, 403.
 1931 Goodeve, C. F., and Stein, N. O., *Trans. Faraday Soc.*, **27**, 393.
 Weber, K., *Z. physik. Chem. B*, **15**, 18.
 1933 Harteck, P., *Trans. Faraday Soc.*, **30**, 134.
 Blum, H. F., and Spealman, C. R., *J. Phys. Chem.*, **37**, 1123.
 1934 Audubert, R., *Phénomènes Photoélectrochimiques*, Actualités scienti-
 fiques, No. 91, Gauthier-Villars, Paris, 1934.
 Terenin, A., and Neujmin, H., *Nature*, **134**, 255.
 1935 Terenin, A., and Neujmin, H., *J. Chem. Phys.*, **3**, 436.
 Terenin, A., and Neujmin, H., *Acta physicochim. U.R.S.S.*, **5**, 465.
 Weiss, J., *Nature*, **136**, 794.
 Hoang Thi Nga, *J. chim. phys.*, **32**, 564.
 Stora, C., *Compt. rend.*, **200**, 552.
 1936 Stora, C., *ibid.*, **202**, 48, 408, 2152.
 Melville, H. W., *Proc. Roy. Soc. London A*, **157**, 621.
 1937 Stora, C., *J. chim. phys.*, **34**, 536.

- 1937 Weiss, J., and Porret, D., *Nature*, **39**, 1019.
- 1938 Yamafuji, K., Fujii, M., and Nishioeda, M., *Biochem. Z.*, **296**, 348.
Yamafuji, K., Nishioeda, M., and So, K., *ibid.*, **298**, 293.
Farkas, A., and Farkas, L., *Trans. Faraday Soc.*, **34**, 1113.
- 1939 Yamafuji, K., So, K., and Tin, H., *Biochem. Z.*, **300**, 414.
Yamafuji, K., Nishioeda, N., and Imagawa, H., *ibid.*, **304**, 404.
Richardson, F. D., (unpublished).
- 1940 Rabinowitch, E., *J. Chem. Phys.*, **8**, 551.
Rabinowitch, E., *ibid.*, **8**, 560.
- 1942 Rabinowitch, E., *Rev. Modern Phys.*, **14**, 112.

C. Chemical and Photochemical Reduction of Carbon Dioxide

- 1893 Bach, A., *Compt. rend.*, **116**, 1145.
- 1897 Losanitsch, S. M., and Jowitschitsch, M. Z., *Ber. deut. chem. Ges.*, **30**, 135.
- 1898 Berthelot, D., *Compt. rend.*, **126**, 610.
- 1900 Berthelot, D., *ibid.*, **131**, 772.
- 1905 Löb, W., *Z. Elektrochem.*, **11**, 745.
- 1906 Löb, W., *ibid.*, **12**, 282 (1906); *Landw. Jahrb.*, **35**, 541.
Usher, F. L., and Priestley, J. M. V., *Proc. Roy. Soc. London B*, **77**, 369.
- 1907 Chapman, D. L., Chadwick, S., and Ramsbottom, J. E., *J. Chem. Soc.*, **91**, 942.
Fenton, H. J. H., *ibid.*, **91**, 687.
- 1908 Gibson, R. J. H., *Ann. Botany*, **22**, 117.
Thiele, H., *Ber. deut. chem. Ges.*, **40**, 4914.
- 1909 Holt, A., *J. Chem. Soc.*, **95**, 30.
Herschfinkel, H., *Compt. rend.*, **149**, 395.
Herschfinkel, H., *Le Radium*, **6**, 228.
- 1910 Berthelot, D., and Gaudechon, H., *Compt. rend.*, **150**, 1690.
Berthelot, D., and Gaudechon, H., *J. pharm. chim.*, (7), **2**, 5.
Moser, A., and Isgarishev, N., *Z. Elektrochem.*, **16**, 613.
Stoklasa, J., and Zdobnicky, W., *Chem. Z.*, **34**, 945, 1391.
- 1911 Baudisch, O., *Ber. deut. chem. Ges.*, **44**, 1009.
Stoklasa, J., and Zdobnicky, W., *Biochem. Z.*, **30**, 433.
- 1912 Schiller, H., and Baur, E., *Z. physik. Chem.*, **80**, 641.
Stoklasa, J., Šebor, J., and Zdobnicky, W., *Biochem. Z.*, **41**, 333.
- 1913 Stoklasa, J., Šebor, J. and Zdobnicky, W., *ibid.*, **54**, 330.
Baudisch, O., and Mayer, E., *Ber. deut. chem. Ges.*, **46**, 115.
Moore, B., and Webster, T. A., *Proc. Roy. Soc. London B*, **87**, 163.
- 1914 Bredig, G., and Carter, G., *ibid.*, **47**, 541.
- 1916 Baudisch, O., and Klinger, G., *ibid.*, **49**, 1167.
Baudisch, O., *ibid.*, **49**, 1159.
Coehn, A., and Sieper, G., *Z. physik. Chem.*, **91**, 347.
- 1918 Kleinstück, M., *Ber. deut. chem. Ges.*, **51**, 108.
Wislicenus, H., *ibid.* **51**, 942.
Moore, B., and Webster, T. A., *Proc. Roy. Soc. London B*, **90**, 168.

- 1921 Baly, E. C. C., Heilbron, I. M., and Barker, W. F., *J. Chem. Soc.*, **119**, 1025.
Baly, E. C. C., Heilbron, I. M., and Barker, W. F., *J. Soc. Chem. Ind.*, **40**, 377.
- 1922 Baur, E., and Rebmann, A., *Helv. Chim. Acta*, **5**, 828.
Baly, E. C. C., Heilbron, I. M., and Hudson, D. P., *J. Chem. Soc.*, **121**, 1078.
- 1923 Baur, E., and Büchi, P., *Helv. Chim. Acta*, **6**, 959.
Tramm, H., *Z. physik. Chem.*, **105**, 356.
Spoehr, H. A., *J. Am. Chem. Soc.*, **45**, 1184.
Thunberg, T., *Z. physik. Chem.*, **106**, 305.
Baly, E. C. C., Heilbron, I. M., and Stern, K., *J. Chem. Soc.*, **123**, 185.
- 1925 Lunt, W., *Proc. Roy. Soc. London A*, **108**, 172.
Porter, C. W., and Ramsperger, H. C., *J. Chem. Soc.*, **47**, 79.
Dhar, N. R., and Sanyal, R. P., *J. Phys. Chem.*, **29**, 926.
- 1927 Baly, E. C. C., Davies, J. B., Johnson, M. R., and Shanassy, H., *Proc. Roy. Soc. London A*, **116**, 197.
Baly, E. C. C., Stephan, W. E., and Hood, N. R., *ibid.*, **116**, 212.
Baly, E. C. C., and Davies, J. B., *ibid.*, **116**, 219.
Burk, D., *J. Phys. Chem.*, **31**, 1338.
Mezzadrolì, G., and Gardano, G., *Atti accad. Lincei Classe sci. fis. mat. nat. Rend.*, **6**, 160.
- 1928 Mezzadrolì, G., and Vareton, B., *ibid.*, **8**, 511.
Baur, E., *Z. physik. Chem.*, **131**, 143.
- 1929 Emerson, R., *J. Gen. Physiol.*, **13**, 163.
Baly, E. C. C., and Hood, N. R., *Proc. Roy. Soc. London A*, **122**, 393.
Mezzadrolì, G., and Babes, G., *Gazz. chim. ital.*, **59**, 305.
- 1930 Coehn, A., and Spitta, Th., *Z. physik. Chem. B*, **9**, 401.
- 1931 Baly, E. C. C., *Trans. Faraday Soc.*, **27**, 545.
Bell, J., *ibid.*, **27**, 771.
Rao, G. G., and Dhar, N. R., *J. Phys. Chem.*, **35**, 1418.
Rao, G. G., and Dhar, N. R., *ibid.*, **35**, 1425.
Yainik, N. A., and Trehuna, F. G., *J. chim. phys.*, **28**, 517.
Mezzadrolì, G., and Vareton, B., *Atti accad. Lincei Classe sci. fis. mat. nat. Rend.*, **14**, 347; *Chimie & Industrie*, Spec. No. 778.
- 1932 Rajwanshi, A. R., and Dhar, N. R., *J. Phys. Chem.*, **36**, 567.
Dhar, N. R., and Ram, A., *Nature*, **129**, 205.
Dhar, N. R., and Ram, A., *Z. anorg. Chem.*, **206**, 171.
Reggiani, M., *Helv. Chim. Acta*, **15**, 1383.
Zscheile, F. P., Jr., *J. Am. Chem. Soc.*, **54**, 973.
Qureshi, M., and Mohammad, S. S., *J. Phys. Chem.*, **36**, 2205.
- 1933 Qureshi, M., and Mohammad, S. S., *J. Osmania Univ.*, **1**, 48.
Dhar, N. R., and Ram, A., *J. Phys. Chem.*, **37**, 525.
Joo, J. H., and Wingard, R. H., *J. Chem. Phys.*, **1**, 886.
Mackinney, G., *J. Am. Chem. Soc.*, **54**, 1688.

- 1934 Coehn, A., and May, B. W., *Z. physik. Chem. B*, **26**, 117.
- 1935 Gore, V., *J. Phys. Chem.*, **39**, 399.
Baur, E., *Helv. Chim. Acta*, **18**, 1157.
- 1937 Baur, E., and Fricker, H., *ibid.*, **20**, 391.
Baur, E., and Gloor, K., *ibid.*, **20**, 970.
Baly, E. C. C., *Nature*, **140**, 930.
- 1938 Baur, E., Gloor, K., and Künzler, H., *Helv. Chim. Acta*, **21**, 1038.
- 1939 Bukatsch, F., *Planta*, **30**, 118.
Baly, E. C. C., Pepper, W. P., and Vernon, C. E., *Trans. Faraday Soc.*, **35**, 1165.
Baly, E. C. C., *Proc. Roy. Soc. London A*, **172**, 445.
- 1940 Baly, E. C. C., *Photosynthesis*. Van Nostrand, New York, 1940.
- 1943 Baur, E., and F., Niggli, *Helv. Chim. Acta*, **26**, 251, 999.

CHAPTER 5

PHOTOSYNTHESIS AND CHEMOSYNTHESIS OF BACTERIA

A. BACTERIAL PHOTOSYNTHESIS *

1. Types of Autotrophic Bacteria

Most bacteria are *heterotrophic* organisms, that is, unlike the *autotrophic* green plants, they are unable to synthesize their organic matter directly from carbon dioxide, but require organic nutrients, in common with animals and fungi. They live either in host organisms as parasites or in media containing organic decay products.

However, there are two groups of bacteria which are exceptions to this rule. The first group, which consists of *photoautotrophic* bacteria, is capable of reducing carbon dioxide to organic matter in light, using hydrogen sulfide, thiosulfate, hydrogen or other inorganic or organic reductants (but *not* water, as do the higher green plants). *Green* and *purple sulfur bacteria* are representatives of this group; they thrive in sulfide-containing media, and most of them are more or less strictly anaerobic.

A second group is formed by *chemautotrophic* bacteria, colorless organisms which reduce carbon dioxide to organic matter in the dark, by coupling this reaction with different energy-releasing chemical processes. They live in media containing oxidizable substances (sulfide, ferrous iron, methane, etc.) and generally need oxygen (although some can use nitrate instead).

The photosynthetic activity of *purple bacteria* was discovered by Engelmann in 1883. At first, he merely noticed their *phototropism* which is similar to that of the motile green algae. Under the microscope, the purple bacteria could be observed gathering in a beam of light. Later (1888), Engelmann proved that these bacteria cannot develop in absence of light. If a spectrum is thrown on a culture of purple bacteria, they grow only in the absorption bands of the green "bacteriochlorophyll" which is found in all of them, together with a variable assortment of carotenoids (*cf.* Eymers and Wassink 1938). The strongest absorption band of bacteriochlorophyll lies in the near infrared. Engelmann (1888) pointed out that here for the first time, invisible light appeared to be active in photosynthesis; later, Dangeard (1921, 1927) confirmed this

* Bibliography, page 125.

and demonstrated that purple bacteria can develop in complete darkness if they are exposed to infrared radiation. Engelmann thought that purple bacteria are normal photosynthesizing organisms, although he was unable to prove, even by means of the extremely oxygen-sensitive motile bacteria, that they produce oxygen in light. He suggested that all oxygen formed by purple bacteria is immediately utilized for the oxidation of sulfide to sulfur.

The inability of purple bacteria to produce oxygen was confirmed by Molisch (1907) and van Niel (1931), by means of the even more sensitive luminous bacteria of Beijerinck. On the other hand, Czurda (1936), who observed the oxidation of leuco dyes by purple bacteria in light, and Nakamura (1937), who noticed the decrease in their oxygen consumption in light, interpreted these results as indirect evidence of a photochemical production of oxygen. Van Niel (1941) suggested that the first observation can be explained by the utilization of the leuco dye as reductant in photosynthesis, while the second one proves merely that the respiration of purple bacteria is inhibited by light (*cf.* page 111). Van Niel exposed dense suspensions of purple bacteria, mixed with luminous bacteria, to prolonged illumination in closed bottles, without ever being able to detect the slightest traces of oxygen. The indirect arguments of Czurda and Nakamura do not avail against these direct proofs, as was later conceded by Czurda (1937).

While Engelmann thought that purple bacteria are normal photosynthesizing organisms, whose oxygen output is used up by a secondary dark metabolic process, Vinogradsky (1887, 1888) saw in this dark metabolism the main source of organic matter in the bacteria. He based this view on analogies with the *colorless* chemautotrophic sulfur bacteria, which derive the energy required for organic synthesis, from the chemical oxidation of sulfide by oxygen.

If Vinogradsky's conception was correct, why should light be at all necessary for the development of purple bacteria? Vinogradsky, and Skene (1914) offered the following explanation. Purple bacteria thrive only under anaerobic conditions; they are thus unable to use atmospheric oxygen for the oxidation of sulfide. Vinogradsky and Skene surmised that purple bacteria live in symbiosis with green photosynthesizing bacteria, the latter supplying them with oxygen of such low partial pressure as not to disturb their anaerobic metabolism. However, this hypothesis had to be abandoned when pure cultures of purple bacteria were obtained and found capable of independent growth in light. Buder (1919, 1920) suggested that photosynthesis is carried out by the purple bacteria themselves, to supply the small quantities of oxygen they require for the oxidation of sulfide. He maintained that the latter is their main source of metabolic energy.

Molisch (1907) disagreed with both Engelmann and Vinogradsky. He thought that purple bacteria are not autotrophic at all, but *photoheterotrophic*, *i. e.*, that they require organic nutrients but are capable of assimilating them only in light. This confused situation was clarified by van Niel and coworkers in several important papers (van Niel 1930, 1931; van Niel and Muller 1931; Muller 1933, Roelefsen 1934, van Niel 1935, 1936^{1,2}, 1937; Foster 1940; review by van Niel 1941). Significant contributions to this field also were made by Gaffron (1933, 1934, 1935^{1,2}) as well as by French (1936, 1937^{1,2}), Wessler and French (1939), Eymers and Wassink (1938), Nakamura (1937^{1,2}, 1938^{1,2}, 1939) and Sapozhnikov (1937).

The two main results of van Niel's investigations were as follows:

(1) Engelmann, Vinogradsky and Molisch all observed correctly, but used *different organisms*. There are *two* kinds of sulfur bacteria: pigmented, *photoautotrophic* sulfur bacteria (Engelmann); and nonpigmented, *chemautotrophic* sulfur bacteria (Vinogradsky). In addition, there is a second kind of pigmented bacteria, the *heterotrophic* purple bacteria (Molisch).

(2) In the photosynthesizing sulfur bacteria the oxidation of hydrogen sulfide is *not* an independent process, coupled with normal photosynthesis through the intermediary of free oxygen, but is a part of the photosynthetic mechanism itself. The photosynthesis of these bacteria differs from that of the higher plants, in that hydrogen sulfide takes the place of water as reductant. (Gaffron suggested that this type of photochemical metabolism be designated as *photoreduction* rather than photosynthesis.) However, hydrogen sulfide is not the only reductant which the purple bacteria can use; in contrast to the photosynthesis of the higher plants, their metabolism is highly adaptable. Some species prefer certain specific reductants; but others can use indiscriminantly a large variety of hydrogen donors. Therefore, only a tentative classification of pigmented bacteria according to their normal photosynthetic function is possible. Table 5.I, taken from van Niel (1941), shows the three main classes: *green sulfur bacteria*, *purple sulfur bacteria* (*Thiorhodaceae*), and *purple "nonsulfur" bacteria* (*Athiorhodaceae*). (Franck and Gaffron designated them as green, red and purple bacteria, respectively; actually the color of both *Thiorhodaceae* and *Athiorhodaceae* can be purple, bright red or brown, depending on the nature of the carotenoids associated with the green "bacteriochlorophyll.") The pigment of green bacteria is the so-called "bacterioviridin" (page 445), whose structure probably is intermediate between those of bacteriochlorophyll and ordinary chlorophyll.

Table 5.I shows the variety of compounds which purple sulfur bacteria can use for the reduction of carbon dioxide. Sapozhnikov (1937) found that *selenium* can be substituted for sulfur. The purple nonsulfur

TABLE 5.I

 CHARACTERISTICS OF THE THREE GROUPS OF PHOTOSYNTHESIZING BACTERIA
 (AFTER VAN NIEL)

GREEN BACTERIA:	Green-colored bacteria, occurring in hydrogen sulfide media. Photosynthetic activity seems restricted to photoreduction of carbon dioxide with <i>hydrogen sulfide</i> as hydrogen donor. Oxidation proceeds only to elementary <i>sulfur</i> . Other sulfur compounds and organic substances not used as hydrogen donors. Organic growth factors not required.
PURPLE SULFUR BACTERIA (<i>Thiorhodaceae</i> Molisch):	Purple to red-colored bacteria, also occurring primarily in sulfide-containing media. Capable of oxidizing <i>various inorganic sulfur compounds</i> to sulfate with the simultaneous photoreduction of carbon dioxide. Various organic substances, particularly the <i>lower fatty acids</i> , and some <i>hydroxy</i> and <i>dibasic acids</i> , can be used as hydrogen donors instead of sulfide. Some species can also use <i>molecular hydrogen</i> . Organic growth factors not required.
PURPLE NONSULFUR BACTERIA (<i>Athiorhodaceae</i> Molisch):	Purple, red or brown-colored bacteria, occurring principally in media containing organic compounds. Capable of photochemical reduction of carbon dioxide with a <i>large number of different organic reductants</i> ; some species can use <i>molecular hydrogen</i> . Although some species are also capable of oxidizing <i>inorganic sulfur compounds</i> to sulfate, growth depends on the presence of small amounts of complex organic materials, such as yeast extract, which presumably furnish necessary organic growth factors.

bacteria normally require an organic source of hydrogen. They thrive on a large variety of organic compounds, including acids, alcohols, hydroxy acids, etc.

2. The Over-All Photosynthetic Reactions of Autotrophic Bacteria

Over-all chemical equations have not yet been established for all the forms of bacterial photosynthesis by analyses comparable in precision to those which lead to equation (3.6) and (3.7) for the over-all reaction of normal photosynthesis. Since the oxidation products of bacterial photosynthesis are solids (*e. g.*, sulfur) or solutes (*e. g.*, sulfuric acid), they are unsuitable for manometric assay, which is so convenient for the determination of the "photosynthetic quotient" of the higher plants.

On the other hand, bacterial photosyntheses offer the possibility of determining the consumption of the *reductant* (*e. g.*, hydrogen sulfide or hydrogen) simultaneously with that of the oxidant (carbon dioxide), whereas a determination of water consumption in normal photosynthesis is practically impossible.

The relation between the quantities of carbon dioxide and hydrogen sulfide consumed by bacteria was determined by van Niel (1930, 1931) for a species of purple bacteria which oxidizes sulfide to sulfate. The over-all reaction deduced from these experiments, was:



This and the following equations of bacterial photosynthesis have been rewritten in the ionic form most suitable for reactions in aqueous phases. For the sake of uniformity all equations have been reduced to the assimilation of one molecule of carbon dioxide, even if this necessitated the use of fractional coefficients.

Formula (5.1) implies the following "photosynthetic quotients":

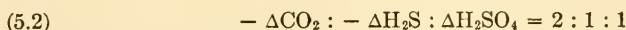

The observed ratios are shown in table 5.II. These ratios are close to

TABLE 5.II
THE PHOTOSYNTHETIC QUOTIENTS FOR PURPLE SULFUR BACTERIA
(AFTER VAN NIEL)

After days	$\frac{\Delta\text{H}_2\text{SO}_4}{-\Delta\text{H}_2\text{S}}$	$\frac{\Delta\text{CO}_2}{\Delta\text{H}_2\text{S}}$
I. 15	0.98	1.86
27	0.97	1.80
34	0.88	1.78
42	0.95	1.94
II. 14	0.97	1.94
24	0.99	1.98

the stoichiometric values, thus proving that carbon dioxide and hydrogen sulfide take part in a common reaction, and not in two "coupled" metabolic processes, as assumed by Buder. A further proof of the absence of a separate photosynthetic reaction not involving the sulfide is the fact that the consumption of carbon dioxide ceases as soon as the supply of sulfide has been exhausted (instead of continuing with the liberation of oxygen, as one would expect according to the theories of Vinogradsky and Buder).

Van Niel also measured the gas exchange of *green* sulfur bacteria, and found it to be in agreement with the following equation:

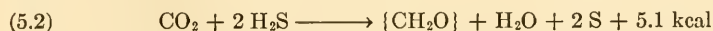

As mentioned above, various species of purple sulfur bacteria are capable of reducing carbon dioxide by means of compounds intermediate between sulfide and sulfate, *e. g.*, free sulfur, thiosulfate or sulfite. The following over-all equations were suggested by van Niel for these forms of bacterial

photosynthesis:

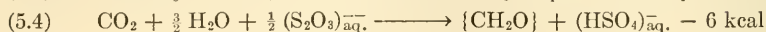
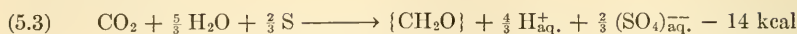

A form of bacterial photosynthesis particularly suitable for quantitative study, is the *carbon dioxide-hydrogen assimilation* which produces only organic matter and water. According to the equation:

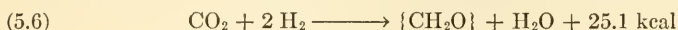

the quotient $\Delta H_2/\Delta \text{CO}_2$ should be equal to 2.

Reaction (5.6) was discovered by Roelefsen (1934) in the study of *Thiorhodaceae*. In the same year, Gaffron found, that certain *Athiorhodaceae* also can reduce carbon dioxide by means of molecular hydrogen in light. Table 5.III contains several determinations of the "photo-

TABLE 5.III
PHOTOSYNTHETIC QUOTIENTS OF HYDROGEN-CONSUMING BACTERIA

Organism	$\Delta H_2/\Delta \text{CO}_2$	Observer
<i>Athiorhodaceae</i> { <i>Rhodovibrio parvus</i> <i>Streptococcus varians</i>	1.85-2.25	Gaffron (1935)
	2.2 -2.6	van Niel (1941)
	2.6	Wessler and French (1939)
<i>Thiorhodaceae</i> : <i>Chromatium</i> sp.	2.4	van Niel (1936)

synthetic quotient" $\Delta H_2/\Delta \text{CO}_2$. Most values in the table are somewhat larger than 2, indicating a possible formation of products reduced beyond the carbohydrate stage.

We have given, in equations (5.2) to (5.6), the heats of the photo-reduction of one mole of carbon dioxide by bacteria (calculated from the data of Bichowsky and Rossini, assuming 51 kcal for the heat of formation of the $\{\text{CH}_2\text{O}\}$ group). They vary between $\Delta H = + 13$ kcal for the oxidation of sulfur to sulfuric acid, and $\Delta H = - 25$ kcal for the reduction of carbon dioxide by molecular hydrogen. Thus, the photochemical reactions of autotrophic bacteria are either exothermal, or only weakly endothermal (as compared with the photosynthesis of the higher plants, $\Delta H = 112$ kcal). However, the reduction of carbon dioxide by elementary *selenium* (Sapozhnikov) should involve the accumulation of as much as 60 kcal per mole (if selenium is oxidized to selenic acid). Furthermore, according to Eymers and Wassink (1938) the carbon dioxide reduction by *thiosulfate* in *Chromatium* D leads to the oxidation of the latter to *tetrathionate*, a strongly endothermal reaction. Using the heats of formation of the ions given by Bichowsky and Rossini, we obtain:

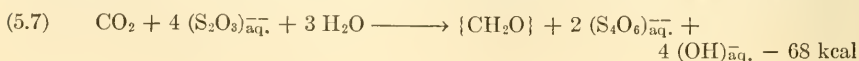

In confirmation of this hypothesis, Eymers and Wassink quoted the observation that, for each molecule of carbon dioxide assimilated by the bacteria, four were taken up by the medium—obviously to neutralize the four hydroxyl ions. However, most of the energy accumulation in (5.7) is associated with the formation of the four hydroxyl ions. If this reaction occurs in an acid medium, and the hydroxyl ions are neutralized, the heat effect is only -12.5 kcal.

Altogether, it appears that bacterial photosynthesis is not necessarily inefficient as far as energy conversion is concerned, but can lead to the conversion into chemical energy of up to one-third or one-half the amount which is accumulated in the photosynthesis of the higher plants.

Because electrolytes are involved in many forms of bacterial photosynthesis, the *free energies* of these reactions often differ considerably from their total energies (while the free energy of normal photosynthesis is almost equal to its total energy; cf. Table 3.V). Calculated for standard conditions (atmospheric pressures of gases and one-molar solutions of the solutes), the gains in free energy in different forms of bacterial photosynthesis, generally are *larger* than those in total energy, by as much as 20 or 30 kcal per mole. For example, the free energy of reaction (5.7) is $\Delta F = 97$ kcal per mole in alkaline, and 20 kcal in acid solution.

In reactions (5.1) to (5.6), carbon dioxide is reduced to carbohydrate by means of different inorganic reductants. In chapter 3, we have interpreted normal photosynthesis as a transfer of hydrogen atoms from water to carbon dioxide. Van Niel (1931, 1935) generalized this concept by describing all forms of bacterial photosynthesis as hydrogen transfers from various hydrogen donors (reductants) to carbon dioxide as the common hydrogen acceptor.

In analogy to the two alternatives, (3.13) and (3.14), in normal photosynthesis, the generalized equation of photosynthesis can be written in two forms:

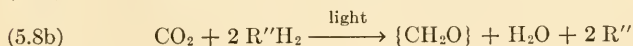
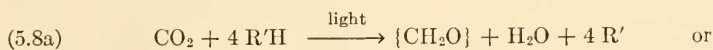

In the first formulation, each molecule of the reductant contributes *one*, and in the second formulation *two*, hydrogen atoms, towards the reduction of one molecule of carbon dioxide.

In the case of normal photosynthesis, R' is OH, or—if formulation (5.8b) is preferred—R'' is O. In the case of photoreduction with sulfide, R' is SH or R'' is S, and in that of photoreduction with hydrogen, R' is H or R'' is nothing. The application of equations (5.8) when the reductant contains no hydrogen at all (as in the case of elementary

sulfur), or is unlikely to yield it (as in the case of the bisulfite ion, HSO_3^-), will be demonstrated in chapter 9 (page 220).

Van Niel's generalized concept of bacterial photosynthesis adds an important argument in favor of the "intermolecular oxidation-reduction" theory of normal photosynthesis, and against the Willstätter-Stoll "internal rearrangement" theory. The easily verifiable fact that in the photosynthesis of sulfur bacteria, the reduction of carbon dioxide leads to the production of sulfur, and not of one part of sulfur and two parts of oxygen (or of sulfur dioxide) is analogous to the fact—proved with much more difficulty by the radioactive isotope experiments of Ruben, Randall, Kamen and Hyde (page 55)—that all oxygen in ordinary photosynthesis originates in water.

3. Combined Photosynthesis and Heterotrophic Assimilation of Photoheterotrophic Bacteria

The metabolism of the "photoheterotrophic" bacteria—that is, bacteria which require light for the assimilation of organic nutrients, seemed at first to be quite different from that of the "photoautotrophic" bacteria discussed above. However, van Niel made it plausible that the organic nutrients serve primarily (although not exclusively) as *hydrogen donors*, so that the generalized equations (5.8), with R now standing for an organic radical, apply to these organisms as well.

The study of the photosynthesis of heterotrophic bacteria had at first encountered difficulties, because the organisms employed were found to require yeast extracts or peptones, and would not thrive in solutions of pure organic compounds. However, this difficulty was overcome by Gaffron (1933) and Muller (1933). Muller used *Thiorhodaceae*, which were found capable of subsisting not only in sulfide media but also in fatty acid solutions; while Gaffron (1933, 1935) found that the *Athiorhodacea*, *Rhodovibrio parvus*, grown in a yeast extract, can be transferred into a simple organic solution for the study of its photosynthetic activity. Similar observations were made by van Niel (1941) with *Spirillum rubrum*. In these investigations, *fatty acids* were used as organic hydrogen donors. However, the utilization of these compounds goes far beyond the contribution of one or two hydrogen atoms. In fact, Muller and Gaffron found that the acids are *completely used up*, leaving no organic residue at all. It is formally possible to explain this complete assimilation in terms of photochemical dehydrogenation, by assuming the transfer of *all* hydrogen atoms to carbon dioxide, and a conversion of *all* carbon atoms into carbon dioxide (*cf.* Eq. 5.15). However, this explanation is speculative; at least a part of the carbon atoms could be assimilated directly, without taking the roundabout way through carbon dioxide. The fact that the assimilation occurs only in light, and often

requires the presence of carbon dioxide (which is "coassimilated" with the acid), makes it probable that the *initial* step is a photochemical reaction between the organic substrate and carbon dioxide; but the subsequent stages of the process could include the direct "heterotrophic" assimilation of the organic material.

Under these conditions, it is important that Foster (1940) found organic substrates capable of yielding only two hydrogen atoms to carbon dioxide in light, and resisting any further assimilation. These were *secondary* alcohols. The carbon chain in these compounds is not attacked by purple bacteria, and the reaction in light is restricted to the transfer of two hydrogen atoms from the alcohol to carbon dioxide, according to the equation:

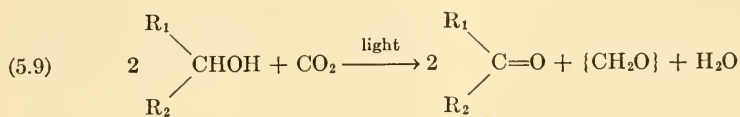

For example, *isopropanol* is quantitatively converted into acetone:

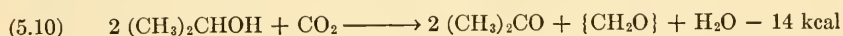

Foster found for this reaction, the "photosynthetic quotients" given in table 5.IV.

TABLE 5.IV

PHOTOSYNTHETIC QUOTIENTS FOR BACTERIAL PHOTOSYNTHESIS WITH ISOPROPANOL

Time, days	$\frac{\Delta \text{ Isopropanol}}{\Delta \text{CO}_2}$	$\frac{\Delta \text{ Acetone}}{-\Delta \text{ Isopropanol}}$
6	2.22	1.02
9	2.02	1.06
12	2.00	1.02
15	2.12	1.00
19	1.97	1.02
25	1.97	1.02
Theoretical	2.0	1.0

We shall now return to the assimilation of fatty acids and attempt to analyze it in terms of photoreduction combined with direct assimilation. A "pure" photoreduction of fatty acids, if it is to lead to carbohydrates as the only products, must involve either "coassimilation" or liberation of carbon dioxide. When the substrate is "overreduced" (compared to the carbohydrates), it must be diluted with carbon dioxide; when it is "underreduced," some carbon dioxide must be eliminated.

The following general equations can be derived for monobasic acids:

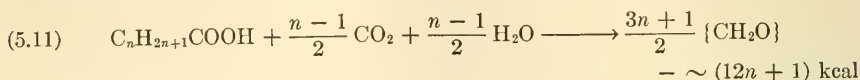

and for dibasic acids:

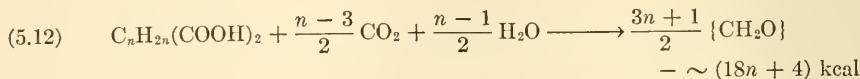

The heats of the reactions (5.11) and (5.12) have been estimated by assuming 112 kcal for the heat of combustion of {CH₂O}, (156n + 55) kcal for that of monobasic acids, and (150n + 60) kcal for that of dibasic acids.

Equation (5.11) indicates consumption of carbon dioxide for $n > 1$ and liberation for $n < 1$, while equation (5.12) requires absorption of carbon dioxide for $n > 3$ and its liberation for $n < 3$. The theoretical "photosynthetic quotients," $\Delta CO_2/\Delta FA$ (FA = fatty acid) are $(n - 1)/2$ for monobasic and $(n - 3)/2$ for dibasic acids.

On the whole, these deductions are confirmed by experiments, although the agreement is only qualitative, and individual results scatter considerably. Muller (1933) found that *Thiorhodaceae* liberate carbon dioxide in the photoreduction of lactate and malate (as they should according to stoichiometric equations, analogous to 5.11 and 5.12, which can be set up for hydroxy acids), but consume it in that of butyrate (in accordance with equation 5.11). Significantly, no butyrate assimilation was observed unless bicarbonate was also provided. More detailed results have been obtained by Gaffron (1933, 1935) with the *Athiorhodaceae* (*Rhodovibrio*). He found the following values of the "photosynthetic quotient" $Q_P = \Delta CO_2/\Delta FA$.

TABLE 5.V

$Q_P = \Delta CO_2/\Delta FA$ FOR RHODOVIBRIO (GAFFRON) AND SPIRILLUM RUBRUM (VAN NIEL)

Acid	n	Q _P		Acid	n	Q _P	
		Observed	Calc.			Observed	Calc.
Acetic	1	-0.25 to 0.11	0	Methyl ethyl acetic	4	0.68-0.91	1.5
	1	-0.21 (v.N.)					
Propionic	2	0.29-0.42	0.5	n-Caproic	5	0.90-1.34	2
	2	0.31 (v.N.)					
n-Butyric	3	0.30-0.43	1	i-Caproic	5	1.10-1.30	2
	3	0.65 (v.N.)					
i-Butyric	3	0.61	1	Heptylic	6	1.03-1.54	2.5
n-Valeric	4	0.62-0.90	1.5	Caprylic	7	1.60-1.96	3
i-Valeric	4	0.83	1.5	Nonylic	8	1.90-2.90	3.5

Gaffron's results showed the expected general increase of Q_P with n , with the notable exception of n -butyric acid. He saw in the different values for the two butyric acids an indication that the mechanism of assimilation may depend on the structure of the molecule. Van Niel (1941) made similar experiments with *Spirillum rubrum* (another *Athiorhodacea*). The individual values again scattered over a considerable range; for example, for acetate, in 48 single experiments, they varied from -0.15 to $+0.28$, but the averages, as given in table 5.VI, showed the expected regular increase from acetate through propionate to n -butyrate.

A comparison of the observed values with the calculated ones in table 5.V shows a regular deficiency of carbon dioxide consumption. In the case of acetate, some carbon dioxide is *liberated*, although the formula of acetic acid, $C_2H_4O_2$, allows of a quantitative conversion into a carbohydrate (corresponding to $Q_P = 0$). The average "coassimilation" of carbon dioxide with the higher fatty acids, amounts to only 60% of the theoretical value. One possible explanation of this fact is that assimilation produces compounds which are more reduced than the carbohydrates.

For compounds consisting only of C, O and H atoms (and not containing peroxide bonds), an appropriate measure of the reduction level is provided by the *respiratory quotient*, Q_R (which is defined on page 32 as the ratio $\Delta CO_2 / -\Delta O_2$) or, more conveniently, by its inverse value, the *reduction level* L , which is equal to the number of molecules of oxygen required for the complete combustion of a molecule, divided by the number of carbon atoms in it. It can be calculated by means of the equation

$$(5.13) \quad L = \frac{1}{Q_R} = \frac{2n_C + \frac{1}{2}n_H - n_O}{2n_C}$$

where n_C , n_H and n_O are the numbers of carbon, hydrogen and oxygen atoms in the molecule, respectively. (We shall see in chapter 9 how closely L determines the energy content of compounds of this type.)

The value of L for carbohydrates is 1. A simple calculation shows that products obtained by the coassimilation of fatty acids and 60% of the quantity of carbon dioxide required for the formation of a carbohydrate, must have L values between 1.43 ($n = 0$) and 1.15 ($n = \infty$). Analyses of the dry matter of purple bacteria are in good agreement with this calculation. Van Niel (1936) found in *Spirillum rubrum*, *Rhodomonas*, *Streptococcus varians* and *Chromatium* (sulfur-free) an average of 55.7% C, 7.4% H, 15.1% O and 11.8% N. Assuming that all nitrogen is present in the form of amino groups, and substituting an equivalent quantity of hydroxyl groups for them, we arrive at a compo-

sition approximately represented by the formula $C_5H_7O_2$, corresponding to a L value of 1.15. Gaffron (1933) isolated from the purple bacteria a substance which could be depolymerized to crotonic acid, $C_4H_6O_2$, $L = 1.18$, and considered it as a direct product of photosynthesis. However, the results obtained by Foster with isopropanol indicate that the true photosynthetic quotient of purple bacteria probably corresponds to the formation of carbohydrates, rather than to the production of any more completely reduced substances. If this is true, deviations from equations (5.11) and (5.12) in the assimilation of fatty acids are due to a direct *assimilation* of intermediates, whose reduction level is higher than that of the carbohydrates, rather than to the *photosynthesis* of "overreduced" substances. (*Dismutations*, which often occur in enzymatic oxidation, can produce such high-energy intermediates even if the original oxidation substrate itself is not overreduced.)

This is not the only argument in favor of a partial heterotrophic nutrition of purple bacteria. Another argument can be derived from the consideration of the metabolism of these organisms in the dark.

Barker (1936), Giesberger (1936), Clifton (1937), Clifton and Logan (1939), Winzler and Bamberger (1938) and Winzler (1940) showed that the oxidation of organic substrates by respiring bacteria often is coupled with their partial assimilation, *e. g.*, in the case of acetate, according to one of the equations:

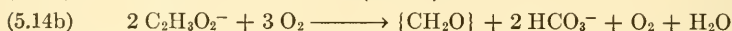

In the case of the purple bacteria, the mechanism of respiration has a particularly close bearing on that of photosynthesis, because van Niel demonstrated that the first stages of both processes are probably brought about by the same enzymatic system. A few words may be said here about this peculiar relationship.

All *Thiorhodaceae* (as well as some *Athiorhodaceae*) are *anaerobic*, *i. e.*, their dark metabolism is of the nature of fermentation. This metabolism was studied by Gaffron (1934, 1935), Roelefsen (1935), French (1937^{1,2}) and Nakamura (1937); but its chemistry has not yet been clarified, mainly because it is preponderantly "autofermentative" (although Nakamura observed the dismutation of formate into hydrogen and carbonate by purple bacteria). The relationship, if any, between this dark metabolism and the metabolism of the same bacteria in light, is as yet not clear.

However, some *Athiorhodaceae* are *aerobic* (or not strictly anaerobic), and their dark oxidative metabolism was found by van Niel to bear a remarkable relation to their photosynthesis. Respiration and photosynthesis, which are independent (although *contra-acting*), in green plants, appear to be *competitive* in aerobic *Athiorhodaceae*.

The investigations of Nakamura (1937^{1,2}, 1938^{1,2}) with *Rhodobacillus palustris* showed that the same substances which are readily used as substrates of photosynthesis, also are eagerly consumed as respiration substrates in the dark. Van Niel (1941) found that the uptake of different fatty acids by *Spirillum rubrum* occurs at the same rate in the dark and in light—although *only oxygen* is consumed in the dark, while both *oxygen and carbon dioxide* are taken up in moderate light, and *carbon dioxide alone* is consumed in strong light.

As mentioned on page 100, Nakamura interpreted the decrease in oxygen consumption by purple bacteria in light as evidence of a photochemical production of

oxygen. However, we now see a more plausible explanation: If the rates of photosynthesis and respiration are limited by the supply of hydrogen through a common enzyme system, every increase in photosynthesis must lead to a decrease in respiration. The fact that under no circumstance does the organism switch over from oxygen consumption to oxygen liberation, agrees well with this picture, whereas it would be difficult to explain if photosynthesis and respiration were two independent processes, as in the higher plants.

Each fatty acid is decomposed by purple bacteria at a different characteristic rate—the same in respiration and photosynthesis; and if a mixture of several acids is provided, their total decomposition rate is additive. This proves that a specific enzyme is available for each of the acids.

We made this digression to the subject of the metabolism of purple bacteria in the dark because the parallelism of respiration and photosynthesis provides an additional argument in favor of a partial direct assimilation of the reductant: Since such an assimilation is known to occur in the dark metabolism, it is also likely to occur in light. Thus, in addition to the direct assimilation of *overreduced* intermediates, which was suggested as an explanation of deviations from equations (5.11) and (5.12), a part of the *carbohydrates* formed in the "photoassimilation" of fatty acids, can also be due to a direct "heterotrophic" assimilation, and not to photosynthesis. Van Niel (1941) considered, for the case of acetate assimilation, the three possibilities (5.15), (5.16) and (5.17), to which we may add (5.18) and (5.19) for the sake of completeness:

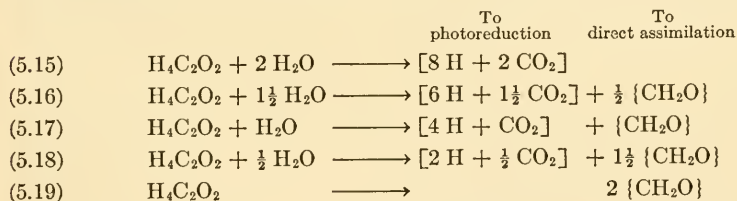

The first equation (5.15), represents pure photoreduction; the next three represent photoreduction coupled with an increasing proportion of direct carbohydrate assimilation; and the last one, direct assimilation without photoreduction.

B. BACTERIAL CHEMOSYNTHESIS *

From the pigmented photosynthesizing bacteria, there is but one step to the nonpigmented "chemosynthesizing" bacteria, which often use the same oxidation substrates (*e. g.*, sulfide, thiosulfate or hydrogen), but work with chemical energy instead of light energy. The discovery of these organisms by Vinogradsky was mentioned on page 100. Some of them can live in (and sometimes only in) purely inorganic media; their autotrophic mode of life is thus easy to prove. These organisms are

* Bibliography, page 126.

analogous to the colored sulfur bacteria. Other species require the presence of simple organic compounds, as methane, carbon monoxide, formate, or methanol. They have thus the appearance of heterotrophants. However, evidence speaks in favor of assigning to the organic substrates of these bacteria, the function of *fuels* rather than of *nutrients*. There seems to be an analogy between the colorless bacteria which use these substrates, and the purple bacteria which require organic hydrogen donors for the reduction of carbon dioxide, except that, in the case of the colorless bacteria, the organic substrate has to supply not only hydrogen but also chemical energy. As in the case of the purple *Athiorhodaceae*, conditions become complicated when colorless bacteria use comparatively complex organic substrates, instead of methane or similar "C₁ compounds"; in this case, heterotrophic nutrition can be superimposed upon the chemosynthesis.

1. Types of Chemautotrophic Bacteria

The main representatives of this class are the *nitrifiers*, the (colorless) *sulfur* bacteria, the *iron* bacteria, the *hydrogen* (or "Knallgas") bacteria, the *carbon monoxide*, *methane* and *carbon* bacteria. This list shows that some kind of chemautotrophic bacteria has become associated with practically every oxidizable inorganic compound found on the surface of the earth—ammonia, hydrogen sulfide, sulfur, ferrous iron, methane and coal. Hydrogen and carbon monoxide are not found in natural habitats of the bacteria. These gases are facultative components of the metabolism of bacteria, whose mode of life under natural conditions is heterotrophic. Thiosulfate has occasionally been found in black mud, but most thiosulfate bacteria also can live on organic substrates (that is, they, too, are only facultative autotrophants).

The following short description of the chemical activity of the chemautotrophic bacteria is based mainly on the review by Stephenson (1939), although the thermochemical figures have been revised on the basis of compilations by Kharash, Bichowski and Rossini, and Roth (*cf.*, bibliography to Chapter 3), and the over-all equations have been simplified by the consequent use of ionic formulations. All equations are reduced to the *consumption of one mole of oxygen*, to facilitate comparison with the equation of carbon dioxide reduction, in which one mole of oxygen is produced for each gram atom of assimilated carbon.

(a) *The Nitrifiers* (Vinogradsky 1890)

These include *Nitrosomonas*, which oxidizes ammonia to nitrate, and *Nitrobacter*, which carries the oxidation from nitrite to nitrate:

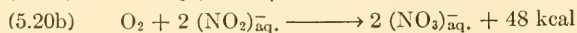
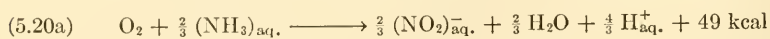

(b) *The Sulfur Bacteria*

We include in this classification the autotrophic bacteria which utilize hydrogen sulfide, elementary sulfur, thiosulfate, and thiocyanate.

Hydrogen Sulfide Oxidizers, *e. g.*, *Beggiatoa* (Vinogradsky 1887), transform hydrogen sulfide into sulfur globules deposited inside the cell. When the sulfide is exhausted, the sulfur globules are consumed by further oxidation to sulfate:

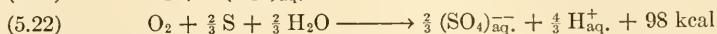
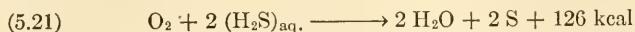

Sulfur Oxidizers (*e. g.*, *Thiobacillus thiooxidans*, Waksman and Joffe, 1922).—These bacteria oxidize externally supplied sulfur to sulfate, in accordance with equation (5.22), and are characterized by extreme tolerance to acid. Their optimum *pH* lies between 3 and 4, and they survive even in 5% sulfuric acid.

The metabolism of these organisms recently was investigated by Vogler and Umbreit. Vogler and Umbreit (1941) and Umbreit, Vogel and Vogler (1942) proved that sulfur is first dissolved in fat globules in the ends of the cell, and saw in this fact a proof that only oxidations which take place *inside* the cell can provide energy for chemosynthesis. According to Vogler (1942), despite its exclusively inorganic nutrition, *Thiobacillus* possesses an organic metabolism based on storage materials formed by chemosynthesis. Vogler, LePage and Umbreit (1942) showed that the rate of sulfur oxidation is independent of *pH* (between 2 and 4.8), and of the oxygen pressure; it is inhibited by cyanide (50% inhibition at 10^{-4} mole/l.), dinitrophenol (50% inhibition at 1.3×10^{-5} mole/l.), azide, iodoacetate, arsenite, indole and phthalate. It is affected by urethane only at comparatively high concentrations (35% inhibition in 0.1 molar solutions). It is 50% inhibited by carbon monoxide in a concentration of 80%, an inhibition which is removed by illumination. All these results indicate that sulfur oxidation proceeds through the intermediary of a heavy-metal enzymatic system (of the hemin type). Since enzymes of this type transfer only electrons, and not oxygen atoms, the oxygen in the SO_4^{--} ions formed by *B. thiooxidans* must originate in water and not in air, a consequence which could be checked by isotope tracers.

The relation between sulfur oxidation and carbon dioxide reduction by *B. thiooxidans* was studied by Vogler (1942²). Young cultures took up a limited quantity of carbon dioxide even *in the absence of sulfur*; in older cultures, this uptake was overbalanced by the carbon dioxide production by endogenous respiration. The sulfur-free carbon dioxide uptake could, however, be observed in all cultures, if respiration was suspended by depriving the cells of oxygen. The maximum total uptake, reached in about two hours, was of the order of 0.4 ml. of carbon dioxide

per mg. bacterial nitrogen. This uptake seemed to be reversible and dependent on the concentration of carbon dioxide in the medium (*cf.* Chapter 8, page 201). Cells which have been allowed to chemosynthesize intensely, subsequently showed a greater capacity for carbon dioxide uptake in absence of sulfur or oxygen than "starved" cells. A short period of "sulfur respiration" restored the capacity for carbon dioxide fixation in "carbon dioxide saturated" cells; while endogenous respiration had no such effect.

The rate of *oxygen* consumption decreased in the presence of carbon dioxide, but the sum $\Delta\text{CO}_2 + \Delta\text{O}_2$ remained approximately constant. This is an obvious parallel to the relation between respiration and photosynthesis in purple bacteria, described on page 110.

The initial carbon dioxide uptake was unaffected by 0.01 mole per liter of sodium azide or arsenite (which completely inhibit the uptake of oxygen), but was completely inhibited by 10^{-4} mole per liter of iodoacetate, which caused only 10% inhibition of the oxygen uptake. (Of course, inhibition of sulfur oxidation must cause a corresponding inhibition of carbon dioxide absorption *after* the initial saturation period.) A concentration of 0.006 mole per liter of sodium pyruvate inhibited both reactions completely, and similar effects were caused by lactic, fumaric and succinic acids, while citric acid had a weaker influence and malic acid none at all.

Vogler and Umbreit (1942) inquired into the way in which sulfur oxidation can cause carbon dioxide fixation in a subsequent period of anaerobiosis. They found that during the oxidation period, inorganic phosphate is transferred from the medium into the cells, to be released again during the period of carbon dioxide fixation. Seventy to 80 molecules of oxygen are used up for oxidation while one molecule of phosphate is transferred into the cells; 40–50 molecules of carbon dioxide are taken up concomitantly with the release of one phosphate molecule. This seems to indicate a $\Delta\text{O}_2/\Delta\text{CO}_2$ ratio of about 1.5. Table 5.VII shows that this value corresponds to an almost 100% utilization of the free energy of oxidation, if one assumes that all absorbed carbon dioxide is reduced to carbohydrate. This proves that the question (which Vogler and Umbreit considered as "open") of whether the "delayed" carbon dioxide fixation is a reduction to carbohydrate or not, must be answered in the negative. Probably, it is not a reduction at all, but a *carboxylation* (or another reversible carbon dioxide absorption), analogous to that which forms the first stage of photosynthesis (*cf.* Chapter 8). Remarkable, however, is the large amount of carbon dioxide taken up in this way—it seems to be at least ten and perhaps a hundred times larger than the reversible carbon dioxide fixation by green plant cells (if one excludes from the latter the rather incidental alkali-acid buffer equilibrium).

Vogler and Umbreit considered the phosphate transfer, coupled with sulfur oxidation and carbon dioxide fixation by *B. thiooxidans*, as a proof that the combustion energy of sulfur is stored in the cells in the form of *phosphate bond energy*. Of course, the observed transformation of one phosphate molecule per 40 or 50 molecules of carbon dioxide cannot provide more than a small fraction of the energy required for chemosynthesis; but Vogler and Umbreit considered it merely as an index of the intercellular formation of high-energy phosphoric acid esters on a much larger scale.

If one refuses to consider the "delayed" carbon dioxide fixation by sulfur bacteria as a carbohydrate synthesis, the energy calculations based on this assumption lose their meaning. It is rather improbable that sufficient energy for true chemosynthesis can be stored in the form of "phosphate bond quanta" of 10 kcal per mole each (*cf.* Chapter 9, page 226).

One may suggest that the phosphate transfer and phosphorylation have something to do with the primary reversible carbon dioxide fixation (in chemosynthesis as well as in photosynthesis), rather than with the reduction of carbon dioxide to carbohydrate (*cf.* Ruben's hypothesis, page 201).

The investigations of Vogler and Umbreit show how much information, which may help in the understanding of the closely related phenomena of chemosynthesis and photosynthesis, can be expected from a quantitative study of the metabolism of autotrophic bacteria.

Bacteria which oxidize sulfur by means of *nitrate*, instead of oxygen (*Thiobacillus denitrificans*), were discovered by Beijerinck in 1904. Since 0.8 mole of NO_3^- ions, reduced to nitrogen, are equivalent to one mole of oxygen, we write the over-all equation as follows:

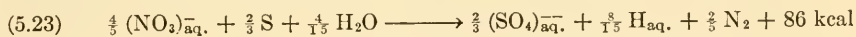

Thiosulfate Oxidizers.—*Thiobacillus thioparus* (Natansohn 1902) oxidizes thiosulfate with the deposition of sulfur *outside* the cell.

Natansohn assumed an intermediate formation of tetrathionate *inside* the cell, and a subsequent external dismutation of tetrathionate into sulfur and sulfate; but Starkey (1935) found no evidence of tetrathionate formation, and gave the following formulation of the over-all reaction:

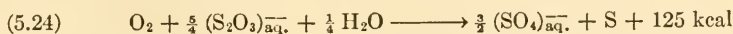

Waksman and Starkey (1922) found a bacterium (*Thiobacillus novellus*) which oxidizes thiosulfate to sulfate without the production of sulfur:

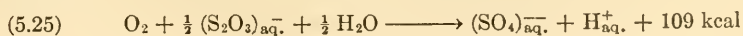

A third kind of thiosulfate-oxidizing bacteria uses nitrate instead of oxygen (Lieske 1912):

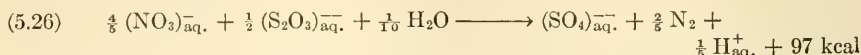

Thiocyanate Oxidizers.—Happold and Key (1937) discovered the *Bacillus thiocyan-oxidans*, which catalyzes the reaction:

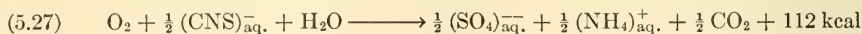

(c) *The Iron Bacteria* (Vinogradsky 1888)

These organisms precipitate ferric hydroxide from waters containing ferrous salts, and are responsible for the red color of many natural waters. Their chemical activity can be represented by the equation:

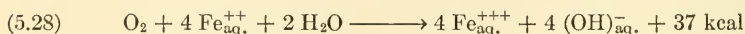

The gain in energy becomes larger if we include in the equation the precipitation of ferric hydroxide (*cf.* Lieske 1911, 1919):



(d) *The Hydrogen Bacteria*

Bacillus pantotrophus, discovered by Kaserer in 1906, and a number of similar microorganisms of the soil, are heterotrophants which are, however, capable of survival and growth in purely inorganic media, if they are provided with molecular *hydrogen*, in addition to *oxygen* and *carbon dioxide*. Their metabolism is based, under these conditions, on the energy of oxidation of hydrogen to water (“oxyhydrogen reaction”):

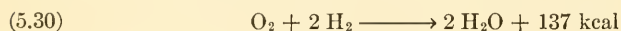

—hence the name “Knallgas bacteria” suggested by Ruhland (1924). Reaction (5.30) is coupled with the reduction of carbon dioxide to organic matter, and further complicated by the simultaneous respiration, *i. e.*, autoxidation of cell material. (Some autotrophic bacteria, the *Nitrosomonas*, for example, apparently dispense with ordinary respiration altogether, their energy requirements being covered entirely by the oxidation of the inorganic substrate.)

The investigations of Kaserer (1906), Nabokich and Lebedev (1907), Lebedev (1908, 1909) and particularly Niklevsky (1908, 1910) have shown a wide distribution of normally heterotrophic but potentially hydrogen-oxidizing bacteria in all soils. Some of them appear to be capable of using nitrate, nitrous oxide or even sulfate as oxidants instead of oxygen, but not much is known about these reactions. Only one species, *Bacillus piconoticus*, has been thoroughly investigated by Ruhland (1924); and because these hydrogen bacteria appear to be the simplest

and most efficient carbon dioxide-assimilating biological systems known, a few words must be said here on his results.

Bacillus picnoticus thrives best in inorganic media at pH 6.8 to 8.7; the decline in its activity in alkaline solutions seems to be caused by the precipitation of ferric hydroxide. (It requires a minimum concentration of ferrous iron $> 10^{-8}$ mole per l.) It is poisoned by cyanide (5×10^{-5} mole/l.) as well as by urethans (50% reduction in hydrogen consumption by 1.2 moles/l. methylurethan, 2×10^{-2} ethylurethan, 1×10^{-2} propylurethan, 5×10^{-3} isobutylurethan, and 1×10^{-3} phenylurethan; compare table 12.VIII).

While some hydrogen bacteria can use nitrate as oxidant (in absence of oxygen), no such substitution is possible with *B. picnoticus*. Its rate of consumption of hydrogen is independent of the partial pressure of oxygen (1.5 to 72%) as well as hydrogen. It can operate in "electrolytic gas" ($\frac{2}{3} \text{H}_2 + \frac{1}{3} \text{O}_2$), and in nitrogen containing mere traces of oxygen and hydrogen (these traces being completely removed by the activity of the bacteria). The concentration of carbon dioxide is also without specific effect except by its indirect influence on acidity.

The rate of hydrogen absorption increases rapidly with temperature ($Q_{10} = 3.5$ between 20° and 32.5°C). Since the combustion is coupled with the reduction of carbon dioxide, the net ratio $\Delta\text{H}_2/\Delta\text{O}_2$ is larger than 2 (Table 5.VI), the excess hydrogen consumption reaching 40%

TABLE 5.VI
GAS EXCHANGE OF BACILLUS PICNOTICUS (AFTER RUHLAND)

$-\Delta\text{H}_2$	$-\Delta\text{O}_2$	$-\Delta\text{CO}_2$	$\frac{\Delta\text{H}_2}{\Delta\text{O}_2}$	$\frac{\Delta\text{CO}_2}{\Delta\text{H}_2 - 2\Delta\text{O}_2}$
138	53	16.9	2.6	0.53
112	45	10.4	2.5	0.48
90	39	6.2	2.3	0.56
88	41	3.0	2.1	0.53
91	41	5.3	2.2	0.53
103	39	13.1	2.6	0.53
29.5	10.6	4.3	2.8	0.53
85	31	10.9	2.8	0.45
113	41	17.0	2.8	0.53
95	34	13.9	2.8	0.53
225	81	33	2.8	0.53
AVERAGE:			2.56	0.52

under the most favorable conditions. The consumption of carbon dioxide, $-\Delta\text{CO}_2$, is in exact stoichiometric relationship with the excess consumption of hydrogen, $-(\Delta\text{H}_2 - 2\Delta\text{O}_2)$. This "photosynthetic

quotient" is equal to 0.5, indicating the formation of a carbohydrate as the first product of chemosynthesis.

Some heterotrophic bacteria (*e. g.*, *Acetobacter peroxidans*, *cf.* Wieland and Pistor 1936, 1938) also catalyze the "oxyhydrogen" reaction (5.30) but apparently without profiting from its energy for organic synthesis.

(e) *The Carbon Bacteria*

The Carbon Monoxide Oxidizers (*Bacillus oligocarbophilus*) (Beijerinck and van Delden 1903).

The reaction which these bacteria catalyze is:

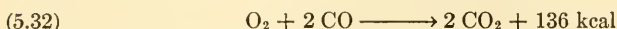

which produces no less energy than does the oxidation of hydrogen.

Methane Oxidizers.—(*Bacillus metanicus*), (Söhngen 1906, Münz 1915). Although methane is usually considered an "organic" carbon compound, we include the methane-burning bacteria in the list of chemoautotrophic organisms because there is no doubt that methane serves exclusively as a source of energy and as a *hydrogen donor*, and not as an organic nutrient.

The combustion of methane liberates less energy than that of hydrogen:

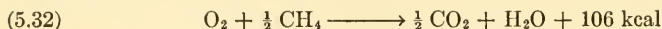

but considerably more than the oxidation of ammonia or ferrous iron.

The Benzene and Toluene Oxidizers.—These bacteria, discovered by Tausson (1929), seem to be similar to Söhngen's methane bacteria in that they too use the energy of oxidation of a hydrocarbon for the synthesis of organic matter from carbon dioxide.

Carbon Oxidizers.—We mention lastly the *carbon* bacteria of Potter (1908) which can live autotrophically by oxidizing solid carbon to carbon dioxide:

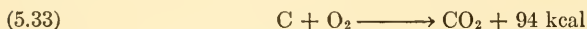

2. Efficiency of Chemautotrophic Bacteria

The efficiency of the autotrophic bacteria can be expressed in three different ways: by the *molecular ratio* (ΔO_2 consumed by oxidation divided by ΔCO_2 reduced to organic matter; the latter quantity being determined either directly, or from the amount of synthesized organic material); by the ratio of *energies* (ΔH_R accumulated in synthesis divided by ΔH_O liberated by oxidation); and by the corresponding ratio of the *free energies* ($-\Delta F_R$ accumulated to ΔF_O dissipated). Only the first ratio is derived directly from experiments. The calculation of the last two is based on the fiction that all of the oxidation substrate is completely

oxidized by oxygen, while carbon dioxide is reduced independently by water (*cf.* page 235). The efficiency has been determined for several species, and the results have been discussed, among others, by Baas-Becking and Parks (1927), Burk (1931), and Stern (1933). Many measurements have not been very reliable, so that most of the figures collected in table 5.VII should be considered as preliminary.

TABLE 5.VII
EFFICIENCY OF AUTOTROPHIC BACTERIA

Type	Species	Re- action	$\frac{\Delta O_2}{\Delta CO_2}$	$\frac{\Delta H_R}{\Delta H_O}$ (%)	$\frac{\Delta F_R}{\Delta F_O}$ (%) ^a	Observer
NITRIFIERS	<i>Nitrosomonas</i> <i>Nitrobacter</i>	(5.20a)	47	5.4	5.9 ^b	Vinogradsky (1890) Vinogradsky (1890) Meyerhof (1916, 1917)
		(5.20b)	66	4.0		
			46	8.5	7.4 ^c	
SULFUR BACTERIA	<i>Thiobacillus</i> <i>thiooxidans</i>	(5.22)	18 (1.5) ^d	6.5 (78) ^d	7.9 (96) ^d	Waksman, Starkey (1922) Vogler, Umbreit (1942) Beijerinck (1920)
	<i>Thiobacillus</i> <i>denitrificans</i>	(5.23)	43	6	6	
	<i>Thiobacillus</i> <i>thioparus</i>	(5.24)	19	4.8	6.5	
	<i>Thiobacillus</i> <i>novellus</i>	(5.25)	21	4.9	6.5	
	<i>Thiobacillus</i> <i>denitrificans</i>	(5.26)	9	~13	~13 ^e	
HYDROGEN BACTERIA	<i>Bacillus</i> <i>psenoticus</i>	(5.31)	2.5 4	32 20	42/ 26/ ^f	Ruhland (1924)
METHANE BACTERIA	<i>Bacillus</i> <i>methanicus</i>	(5.32)	(3.5-4.5) ^g ~20	(22-29) ^g ~5	(26-34) ^g ~6	Söhngen (1906)

^a ΔF of $\{CH_2O\}$ synthesis, for $p(CO_2) = 3 \times 10^{-4}$ atm. and $p(O_2) = 0.2$ atm., is 118 kcal (*cf.* Table 3.V).

^b Calculated for $[NH_4^+] = 5 \times 10^{-3}$ mole/l. and $[H^+] = 10^{-8}$ mole/l.

^c Calculated for $[NO_2^-] = 3 \times 10^{-2}$ mole/l.

^d We put these values in parentheses because we believe (*cf.* page 226) that they apply to primary carbon dioxide fixation rather than to carbon dioxide reduction. The same may be true of the low ratios $\Delta O_2/\Delta CO_2$ observed by Söhngen for methane bacteria.

^e Baas-Becking and Parks calculated 11%. They thought that Lieske's yields refer to 1 g. $Na_2S_2O_3 \cdot 5H_2O$ instead of 1 g. $Na_2S_2O_3 \cdot 5H_2O$.

^f 42% is maximum, and 26% the average.

^g The larger values were calculated by Baas-Becking and Parks from the gasometric data of Söhngen, while the smaller were obtained from the permanganate titration of organic matter. *Cf.* footnote ^d above.

For the majority of organisms in table 5.VII, the "energy yields" are of the order of 5-6%, and the "free energy yields" of the order of 6-8%. The difference is due to the fact that the free energies of oxidations leading to the formation of *electrolytes* often are considerably less negative than the corresponding total energies.

Although low, the efficiencies in table 5.VII are similar to the best efficiencies of the utilization of light energy by green plants under natural conditions. Thus, if chemautotrophic organisms did not succeed in spreading over the whole surface of the earth, as did the green plants, it was not for lack of efficiency, but merely because chemical energy is available only in a few nonequilibrated spots—sulfur springs, coal mines, iron carbonate waters, marsh gases, etc., while sunlight flows abundantly everywhere.

Hydrogen bacteria occupy a unique position in table 5.VII because of their high efficiency. (The high values given for methane bacteria are unreliable, because the gas balance does not agree with any reasonable equation, and the amount of organic matter, as determined by the permanganate method, indicates a much smaller yield. The value given for the delayed chemosynthesis of *T. thiooxydans* also is of doubtful meaning, as discussed on page 114.) The figures for *B. picnoticus* are the most reliable of all, having been derived from a series of complete gas analyses by Ruhland (Table 5.VI). The values for the ratio, $\Delta H_2/\Delta O_2$, found in these experiments, varied between 2.1 and 2.8 depending on the state of the culture. If one neglects the oxygen consumption by respiration (a correction for this process would raise the efficiency still higher) a ratio of 2.8 means that for every two hydrogen molecules burned to water, 0.8 molecules of hydrogen are used for the reduction of carbon dioxide. This corresponds to the reduction of 0.4 molecules of carbon dioxide, and leads to the maximum ratio, $\Delta O_2/\Delta CO_2 = 2.5$, given in table 5.VII, corresponding to the utilization of 32% of available energy and 42% of available free energy. Even if one uses the *average* value of $\Delta H_2/\Delta O_2$ in table 5.VI (~ 2.5), one calculates that only four oxygen molecules are required for the reduction of one molecule of carbon dioxide, and obtains an energy utilization of 20%, and a free energy utilization of 26%. Gaffron found (*cf.* page 140), for hydrogen-adapted green algae, a maximum ratio of $\Delta H_2/\Delta O_2 = 3$, and considered this value as the theoretical maximum, probably valid also for the hydrogen bacteria.

Burk's (1931) calculation which gave a 100% efficiency for the chemosynthesis of hydrogen bacteria, was based on the assumption that the average ratio (0.52) in the last column of table 5.VI represents, not a confirmation of the theoretical stoichiometric value (0.5)—*cf.* equation (5.6)—but the quantity of hydrogen actually combusted to water to provide energy for the reduction of one mole carbon dioxide by one mole of water (as if all the rest of hydrogen oxidized by the bacteria had nothing to do with the reduction process!). With this assumption, the result of Burk's calculation became a simple consequence of the fact that the free energy of the reaction, $2 H_2 + CO_2 \longrightarrow \{CH_2O\} + H_2O$, is approximately zero. We can see no relation between his elaborate calculations and the problem of the true thermodynamic efficiency of the hydrogen bacteria. (This was noted also by van Niel, 1943.)

3. Methane-Producing Bacteria and other Cases of Carbon Dioxide Absorption by Heterotrophants

We have described the *methane-oxidizing* bacteria together with other chemautotrophic species, because their use of methane is similar to the use of hydrogen sulfide, sulfur, thiosulfate, or ammonia by "true" autotrophic bacteria. Many other allegedly "heterotrophic" bacteria can live on one chemically pure organic substrate, and it is quite possible

that they, too, use it mainly or exclusively as a source of *hydrogen* and *energy*, but prepare their cell matter by the reduction of carbon dioxide. However, the metabolism of most of these bacteria is not sufficiently known to allow one to assert that they do not use at least a part of the organic substrate for direct heterotrophic assimilation—especially since we know, from the example of the purple *Athiorhodaceae*, that synthesis of carbohydrates by the reduction of carbon dioxide can often be coupled with heterotrophic assimilation of one part of the reductant.

Only one type of bacteria which uses organic substrates for the reduction of carbon dioxide shall be described here, the *methane-producing* bacteria, which were discovered in 1910 by Söhngen (who had previously discovered the *methane-burning* bacteria). Methane is produced by the fermentation of many organic substrates; these processes have been investigated, *e. g.*, by Neave and Buswell (1930), Fischer, Lieske and Winzer (1931, 1932), Stephenson and Stickland (1933), Barker (1936^{1,2}, 1937), and Barker, Ruben and Kamen (1940). One thinks, at first, that methane must be the product of dismutation of an organic substrate, as, for example, in the simplest case of the acetate fermentation:



(Decarboxylation can be considered as a special case of dismutation in which one part of the molecule is oxidized to carbon dioxide.) However, Söhngen noticed that the same bacteria which cause methane fermentation of organic substrates, also reduce carbon dioxide to methane *in the presence of molecular hydrogen*:

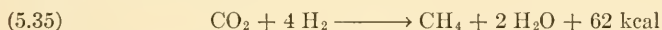

More recently, Barker (1936²) found a species of methane bacteria which reduces carbon dioxide to methane by means of *ethanol*:



These examples make it probable that even in methane fermentations which proceed with a net *liberation* of carbon dioxide, as in (5.34), the way to methane leads through carbon dioxide. Arguments in favor of this hypothesis were adduced by Barker (1936, 1937). He found, for example, that in the gradual decomposition of butanol by methane bacteria, the first stage conforms to the equation:



and the second stage to the equation:

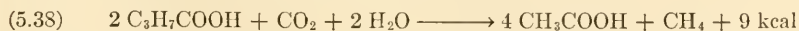

while, in the third stage, four molecules of carbon dioxide are *liberated*, according to the over-all equation (5.34), thus giving a *net* production

of one molecule of carbon dioxide for each fermented molecule of butanol:

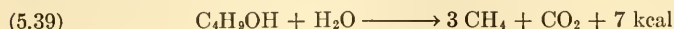

It seems plausible to assume, in analogy to steps (5.37) and (5.38), that the last step in butanol fermentation, the decomposition of acetic acid, also involves the participation of carbon dioxide, *i. e.*, proceeds not according to the "abbreviated" equation (5.34), but by a true oxidation-reduction:



A *direct* proof of the participation of free carbon dioxide in the formation of methane in reactions which proceed with the net liberation of carbon dioxide was achieved by means of radioactive carbon, C*. Barker, Ruben and Kamen (1940) showed that the methane fermentation of inactive ethanol by *Methanosarcina methanica*, in the presence of radioactive carbon dioxide, gives active methane, thus establishing the correctness of the equation:

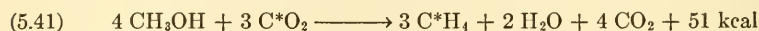

and precluding the "cancelling out" of three carbon dioxide molecules on each side of this equation. A similar interpretation of acetate fermentation, assumed in (5.40), thus becomes increasingly plausible.

At first sight, the reduction of carbon dioxide to methane by the methane bacteria appears as a biochemical "art for art's sake," since the product escapes as a gas, carrying with it the accumulated energy. However, Barker, Ruben and Kamen noticed that about 10% of radioactivity supplied in the form of C*O₂ is found afterwards in the cell material. This shows that, while a large part of reduced carbon dioxide is wasted, a small proportion is utilized for the synthesis of the cell material. This reminds one of the autotrophic bacteria which dissipate most of the available oxidation energy, in order to reduce a small quantity of carbon dioxide to carbohydrate. It seems possible that the methane bacteria have solved a similar problem in a different way (the usual solution being precluded by their anaerobic mode of life). Deprived of oxygen, they cannot derive energy from the *autoxidation* of the available substrate. Their solution is to use *carbon dioxide* as an oxidant. We know that none of the available oxidation substrates—not acetate, or methanol, or even hydrogen—has sufficient reducing power to bring about the stoichiometric reduction of carbon dioxide to *carbohydrate*. However, the reduction of carbon dioxide to *methane* requires less energy per transferred hydrogen atom than the "halfway" reduction to carbohydrate. This is why the reactions (5.35) – (5.41) are exothermal—with the exception of reaction (5.40), which, however, has a positive free energy of about 10 kcal.

The fact that the methane bacteria *are* capable of reducing carbon dioxide to methane, shows that they have developed a mechanism which avoids the intermediate formation of a carbohydrate (because the latter would present an "energy barrier" which is insurmountable at ordinary temperatures). Under these conditions, it seems possible that the large-scale, exothermal reduction of carbon dioxide to methane may be used by the methane-liberating bacteria to the same purpose as the large-scale, exothermal oxidation of autoxidizable substrates is used by the autotrophic bacteria, namely, to provide energy for the reduction of a relatively small proportion of carbon dioxide to a carbohydrate.

In the same class with the methane-producing bacteria may perhaps be placed the species of *Clostridium*, which reduce carbon dioxide to *acetic acid* by means of hydrogen (Wieringa 1936):

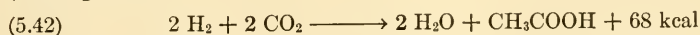

or by means of various purines (*Clostridium acidi urici*, Barker, Ruben and Beck 1940).

We shall not continue with the enumeration of bacterial and other biological systems which have been found capable of absorbing carbon dioxide and incorporating it into organic matter. Although some of them probably carry out a "chemosynthetic" reduction of carbon dioxide, similar to that achieved by the microorganisms described above, the most important examples worked out so far appear to belong to a different type, that of *enzymatic carboxylations*. It is customary to speak of "reduction of carbon dioxide" whenever this compound is bound in an organic molecule. However, it is advisable to distinguish clearly between *true reduction* of carbon dioxide and *carboxylation*, *carbamination* and similar "additive" reactions of carbon dioxide with organic molecules. Whether carboxylations should be called reductions at all, is a matter of definition. In chapter 8 arguments will be presented in favor of *not* using this designation. This convention would prevent misunderstandings which have led to the use of expressions like "dark assimilation," or even "dark photosynthesis" for processes in which carbon dioxide was merely added to existing organic compounds. Carboxylation is important from the point of view of photosynthesis, not as an analogy to the main photosynthetic process, but as a possible way of entry of carbon dioxide into the photosynthetic apparatus. It will therefore be considered in detail in chapter 8, which deals with the immediate fate of carbon dioxide in photosynthesis.

C. THE ROLE OF AUTOTROPHIC BACTERIA IN NATURE

Bacterial metabolism is of great importance for the elucidation of the chemical mechanism of photosynthesis. It indicates that photosynthesis consists of two distinct stages, the reduction of carbon dioxide, and the

oxidation of water, and that the second stage can be changed and other reductants substituted for water without affecting the first one. Chemosynthesis by autotrophic bacteria makes it plausible that the reduction of carbon dioxide is a nonphotochemical process, which can be brought about by the intermediates of the photochemical oxidation of water (or other reductants), as well as by products of exothermal chemical reactions.

These problems will be discussed more extensively in chapters 7 and 9.

Another interesting question which arises from the study of the photosynthesis and chemosynthesis of autotrophic bacteria, concerns the role which these processes may have played in the development of life on earth. Prior to van Niel's interpretation of the mechanism of bacterial photosynthesis, the synthesis of organic matter by green plants appeared as a unique process, unrelated to all other biochemical reactions in living organisms. Van Niel's investigations have established the long-missing link between the world of green plants and that of the lower microorganisms.

Green plants reduce carbon dioxide in light by means of water; green and purple sulfur bacteria reduce carbon dioxide, also in light, by means of hydrogen sulfide; colorless sulfur bacteria reduce carbon dioxide, by means of hydrogen sulfide, without light. This comparison shows the existence of a hierarchy of autotrophic organisms, and encourages speculations as to the genetic relationships between them.

In considering the present state of life on earth, one is struck by the paradox "no life without chlorophyll—no chlorophyll without life." The large-scale formation of organic matter from inorganic materials has as its prerequisite the existence of complex organic molecules, such as chlorophyll and various enzymes, without which photosynthesis appears impossible, but which themselves cannot be synthesized in nature outside the living cell.

Obviously, photosynthesis could not have started on earth without the previous existence of living matter. The existence of chemautotrophic and photototrophic bacteria shows a possible development. It was mentioned on page 82 that the first organic molecules may have arisen on earth by photochemical reactions of inorganic compounds in ultraviolet light, or by the action of electric discharges in the atmosphere. Which of these molecules first acquired the capacity of propagation by self-duplication, which is the first sign of life, we cannot surmise; but we can imagine a continuous "chemosynthetic" development leading from this molecule to autotrophic bacteria. At that time, the earth was less settled in its chemical ways than now, and not only hydrogen sulfide, but also free hydrogen might have been available in the atmosphere. From colorless autotrophic bacteria, the development might have

progressed to purple bacteria, and hence to green plants. The transition from bacteria to algae, which liberated the plants from the dependence on uncertain and dwindling supplies of unstable hydrogen donors, has allowed life to spread over the whole surface of the globe. The capacity of certain green algae for adaptation to hydrogen (*cf.* Chapter 6) may be a reminiscence of their genetic relationship to photoreducing bacteria.

Bibliography to Chapter 5

Photosynthesis and Chemosynthesis of Bacteria

A. Photosynthesizing Bacteria

- 1883 Engelmann, Th. W., *Arch. ges. Physiol. Pflügers*, **30**, 90.
 1887 Vinogradsky (Winogradsky), S., *Botan. Z.*, **45**, 489.
 1888 Vinogradsky, S., *Zur Morphologie und Physiologie der Schwefelbakterien*.
 O. Felix, Leipzig, 1888.
 Engelmann, Th. W., *Arch. ges. Physiol. Pflügers*, **42**, 183.
 Engelmann, Th. W., *Botan. Z.*, **46**, 661
 Engelmann, Th. W., *Arch. néerland. sci.*, **23**, 151
 1907 Molisch, H., *Die Purpurbakterien*. Fischer, Jena, 1907.
 1914 Skene, M. G., *New Phytologist*, **13**, 1.
 1919 Buder, J., *Jahrb. wiss. Botan.*, **58**, 525.
 1920 Buder, J., *Naturwissenschaften*, **8**, 261
 1921 Dangeard, P. A., *Botaniste*, **14**, 1.
 1927 Dangeard, P. A., *ibid.*, **19**, 1.
 1930 van Niel, C. B., *Contrib. Hopkins Marine Biol. Sta.*, **1930**, 161.
 1931 van Niel, C. B., *Arch. Mikrobiol.*, **3**, 1.
 van Niel, C. B., and Muller, F. M., *Rec. trav. botan. néerland.*, **28**, 245.
 1933 Muller, F. M., *Arch. Mikrobiol.*, **4**, 137.
 Gaffron, H., *Biochem. Z.*, **260**, 1.
 1934 Roelefsen, P. A., *Proc. Acad. Sci. Amsterdam*, **37**, 660.
 Gaffron, H., *Biochem. Z.*, **269**, 447.
 1935 Gaffron, H., *ibid.*, **279**, 1.
 Gaffron, H., *ibid.*, **275**, 301.
 van Niel, C. B., *Cold Spring Harbor Symposia Quant. Biol.*, **3**, 138.
 1936 Czurda, V., *Arch. Mikrobiol.*, **7**, 110.
 van Niel, C. B., *Bull. assoc. diplômés microbiol. faculté pharm. Nancy*,
No. 13.
 van Niel, C. B., *Arch. Mikrobiol.*, **7**, 323.
 French, C. S., *Science*, **84**, 575.
 Barker, H. A., *J. Cellular Comp. Physiol.*, **8**, 231.
 Giesberger, G., *Dissertation*, Univ. Utrecht, 1936.
 1937 Czurda, V., *Rept. Proc. 2nd Intern. Congr. Microbiol. London*, **1937**,
470.
 Clifton, C. E., *Enzymologia*, **4**, 246.
 Nakamura, H., *Acta Phytochim. Japan*, **9**, 189.

- 1937 Nakamura, H., *Acta Phytochim. Japan*, 10, 211.
 French, C. S., *J. Gen. Physiol.*, 20, 711.
 French, C. S., *ibid.*, 21, 71.
 Sapozhnikov, D. I., *Microbiology USSR*, 6, 643.
 van Niel, C. B., *Ann. Rev. Biochem.*, 6, 595.
- 1938 Winzler, R. J., and Baumberger, J. P., *J. Cellular Comp. Physiol.*, 12, 183.
 Eymers, J. G., and Wassink, E. C., *Enzymologia*, 2, 258.
 Nakamura, H., *Acta Phytochim. Japan*, 10, 259.
 Nakamura, H., *ibid.*, 10, 297.
- 1939 Clifton, C. E., and Logan, W. A., *J. Bact.*, 37, 523.
 Wessler, S., and French, C. S., *J. Cellular Comp. Physiol.*, 13, 327.
 Nakamura, H., *Acta Phytochim. Japan*, 11, 109.
- 1940 Winzler, R. J., *J. Cellular Comp. Physiol.*, 15, 343.
 Foster, J. W., *J. Gen. Physiol.*, 24, 123.
- 1941 van Niel, C. B., in *Advances in Enzymology*, Vol. 1. Interscience, New York, 1941, p. 263.

B. Chemosynthesizing Bacteria

- 1887 Vinogradsky, S., *Ann. inst. Pasteur*, 1, 548.
- 1888 Vinogradsky, S., *Botan. Z.*, 46, 262.
- 1890 Vinogradsky, S., *Ann. inst. Pasteur*, 4, 213.
- 1902 Natansohn, A., *Mitt. Zool. Stat. Neapel*, 15, 665.
- 1903 Beijerinck, M. W., and van Delden, A., *Zentr. Bakt. Parasitenk.*, II, 2, 33.
 Beijerinck, M. W., *ibid.*, 16, 681.
- 1906 Kaserer, H., *ibid.*, 16, 681.
 Söhngen, N. L., *ibid.*, 15, 513.
- 1907 Nabokich, A. J., and Lebedev, A. J., *ibid.*, 17, 350.
- 1908 Potter, M., *Proc. Roy. Soc. London B*, 80, 739.
 Niklewski, B., *Zentr. Bakt. Parasitenk.*, II, 20, 469.
 Lebedev, A. J., *Biochem. Z.*, 7, 1.
- 1909 Lebedev, A. J., *Ber. deut. botan. Ges.*, 27, 598.
- 1910 Niklewski, B., *Jahrb. wiss. Botan.*, 48, 113.
 Söhngen, N. L., *Rec. trav. chim.*, 29, 238.
- 1911 Lieske, R., *Jahrb. wiss. Botan.*, 49, 91.
- 1912 Lieske, R., *Ber. deut. botan. Ges.*, 30, 12.
- 1915 Münz, E., *Dissertation*, Univ. Halle, 1915.
- 1916 Meyerhof, O., *Arch. ges. Physiol. Pflügers*, 164, 353.
- 1917 Meyerhof, O., *ibid.*, 166, 240.
- 1919 Lieske, R., *Zentr. Bakt. Parasitenk.*, II, 49, 413.
- 1920 Beijerinck, M. W., *Proc. Acad. Sci. Amsterdam*, 22, 899.
- 1922 Waksman, S. A., and Starkey, R. L., *J. Gen. Physiol.*, 5, 285.
 Waksman, S. A., and Joffe, J. S., *J. Bact.*, 7, 239.
- 1924 Ruhland, W., *Jahrb. wiss. Botan.*, 63, 321.
- 1927 Baas-Becking, L. G. M., and Parks, G. S., *Physiol. Revs.*, 7, 85.
- 1929 Tausson, W., *Planta*, 7, 735.

- 1930 Neave, S. L., and Buswell, A. M., *J. Am. Chem. Soc.*, **52**, 3308.
- 1931 Fischer, F., Lieske, R., and Winzer, K., *Biochem. Z.*, **236**, 247.
Burk, D., *J. Phys. Chem.*, **35**, 432.
- 1932 Fischer, F., Lieske, R., and Winzer, K., *Biochem. Z.*, **245**, 2.
- 1933 Stephenson, M., and Stieckland, L. H., *Biochem. J.*, **27**, 1517.
Stern, K., *Pflanzenthermodynamik*. Springer, Berlin, 1933.
- 1935 Starkey, R. U., *Soil Sci.*, **39**, 97.
Starkey, R. U., *J. Gen. Physiol.*, **18**, 325.
- 1936 Barker, H. A., *Arch. Mikrobiol.*, **7**, 404.
Barker, H. A., *ibid.*, **7**, 420.
Wieringa, K. T., *Antonie van Leeuwenhoek J. Microbiol. Serol.*, **3**, 1.
Wieland, H., and Pistor, H. T., *Ann.*, **522**, 116.
- 1937 Barker, H. A., *Arch. Mikrobiol.*, **8**, 415.
Happold, F. C., and Key, A., *Biochem. J.*, **31**, 1323.
- 1938 Wieland, H., and Pistor, H. T., *Ann. Chemie (Liebig)*, **535**, 205.
- 1939 Stephenson, M., *Bacterial Metabolism*. 2d ed., Longmans, Green, London, 1939.
- 1940 Barker, H. A., Ruben, S., and Kamen, M. D., *Proc. Natl. Acad. Sci. U. S.*, **26**, 426.
Barker, H. A., Ruben, S., and Beck, J. V., *ibid.*, **26**, 477.
- 1941 Vogler, K. G., and Umbreit, W. W., *Soil Sci.*, **51**, 331.
- 1942 Vogler, K. G., *J. Gen. Physiol.*, **25**, 617.
Umbreit, W. W., Vogel, H. R., and Vogler, K. G., *J. Bact.*, **43**, 141.
Vogler, K. G., LePage, G. A., and Umbreit, W. W., *J. Gen. Physiol.*, **26**, 89.
Vogler, K. G., *ibid.*, **26**, 103.
Vogler, K. G., and Umbreit, W. W., *ibid.*, **26**, 157.
- 1943 van Niel, C. B., *Physiol. Revs.*, **23**, 338.

Compilations of *Thermochemical Data and Free Energies*,
see Bibliography to Chapter 3

CHAPTER 6

THE METABOLISM OF ANAEROBICALLY ADAPTED ALGAE *

1. The Adaptation of Algae to Hydrogen and Hydrogen Sulfide

In the preceding chapter, we found that the photosynthesis of bacteria is strikingly adaptable. The photosynthesis of green plants, on the other hand, has long been considered as a rigid process, which can be accelerated or retarded by external influences, but whose chemical mechanism is unalterable. This is, however, not universally true. Nakamura (1937, 1938) found that certain diatoms (*Pinnularia*) and blue-green algae (*Oscillatoria*) can use *hydrogen sulfide* for the reduction of carbon dioxide—in other words, can adopt a metabolism similar to that of the purple sulfur bacteria. Ordinarily, the photosynthesis of green plants is inhibited by hydrogen sulfide (*cf.* page 315); but Nakamura's algae *consumed carbon dioxide* even in presence of this gas. The *evolution of oxygen*, however, was replaced by the deposition of sulfur globules in the cells.

This interesting phenomenon certainly deserves more than the cursory attention it has received in Nakamura's work. Much more detailed has been the study which Gaffron devoted to certain unicellular green algae which, after a period of anaerobic incubation, become able to utilize *molecular hydrogen* or *organic hydrogen donors* as reductants in photosynthesis, that is, adopt a metabolism reminiscent of the autotrophic or heterotrophic *Athiorhodaceae*.

The adaptation of green algae to molecular hydrogen was discovered by Gaffron in 1939, and investigated in a series of important papers (Gaffron 1939, 1940^{1,2}; 1942^{1,2}; Gaffron and Rubin 1942, reviews Franck and Gaffron 1941, Gaffron 1943). In studying "induction effects" in plants after anaerobiosis in the dark, Gaffron found that some unicellular green algae (*Scenedesmus*, for example) do not react to this "anaerobic incubation" by a temporary *inhibition* of gas exchange in light, as do the higher plants, but by a more-lively-than-usual liberation of gas. This "inverse induction" was later found to be caused by a liberation of *hydrogen*, in addition to (or instead of) the usual exchange of carbon dioxide and oxygen.

* Bibliography, page 148.

In studying this phenomenon Gaffron (1939, 1940) found that algae which were capable of *liberating* hydrogen, were also able to *absorb* it, if placed in an atmosphere containing a high proportion of this gas. Hydrogen evolution and consumption can be observed even in darkness; but both processes are accelerated by light. The hydrogen exchange continues, gradually decreasing, until the available cellular "hydrogen acceptors" are entirely saturated with hydrogen, or until the available "hydrogen donors" are exhausted. In presence of an added hydrogen acceptor, the absorption of hydrogen can continue for a much longer time, and the same is true of hydrogen liberation in presence of an added donor.

Appropriate hydrogen acceptors are *oxygen* (in small quantities, since larger quantities of this gas cause de-adaptation), and *carbon dioxide*; while *glucose* and other organic substrates can act as hydrogen donors. Thus, hydrogen-adapted algae are capable of bringing about the following reactions:

In the Dark: (I) and (II).—*Absorption of hydrogen* from an atmosphere containing a high proportion of this gas, and *evolution of hydrogen* into an atmosphere of pure nitrogen (so-called "hydrogen fermentation").

(III).—*Simultaneous absorption of hydrogen and oxygen* (so-called "oxyhydrogen" or "Knallgas" reaction).

(IV).—*Reduction of carbon dioxide* coupled with the oxyhydrogen reaction (III), a process analogous to the metabolism of *autotrophic hydrogen bacteria* (page 116).

In Light: (V) and (VI).—*Enhanced hydrogen absorption* in an atmosphere of hydrogen, and enhanced *hydrogen evolution* in an atmosphere of nitrogen. The first-named process may, however, be identical with reaction (VII), *i. e.* it may represent the photoreduction of carbon dioxide produced by acid fermentation, rather than the hydrogenation of an organic hydrogen acceptor.

(VII) and (VIII).—*Photosynthesis from carbon dioxide and hydrogen* or from *carbon dioxide and organic hydrogen donors*—processes reminiscent of the metabolism of autotrophic and heterotrophic *purple bacteria* respectively. Gaffron designated these reactions as "photoreductions," and although this term is not very specific, it may be used as a short substitute for "photoreduction of carbon dioxide by reductants other than water," while the term "photosynthesis" is retained to mean "photoreduction of carbon dioxide by water." (To be consistent, one should use the term "photoreduction" also when speaking of the metabolism of purple bacteria, a terminology which was not rigidly adhered to in chapter V.)

2. The Mechanism of Hydrogen Adaptation and De-adaptation

Before discussing the metabolic reactions of hydrogen-adapted algae, we shall deal with the processes of adaptation and de-adaptation (the latter called "reversion" by Gaffron).

Not all unicellular green algae can be adapted to hydrogen. Experiments with *Chlorella*, as well as with diatoms (two strains of *Nitzschia*) and blue-green algae (*Oscillatoria*), gave no positive results. No generic relationships are apparent: *Scenedesmus*, *Ankistrodesmus* and *Raphidium*

(three genera which have been successfully adapted) are no more closely related between themselves than they are to *Chlorella*.

Adaptation requires at least two hours of anaerobic incubation at 20° C., less at higher temperatures. At 35°, the hydrogen metabolism of *Scenedesmus* starts almost immediately upon the removal of oxygen; however, this temperature rapidly causes an irreversible injury to the algae. During the adaptation period, the algae ferment, as all green plants do when the oxygen pressure is below that corresponding to the Pasteur effect (*cf.* Génévois 1927), producing carbon dioxide and non-volatile acids; the rate of this "acid fermentation" is about the same in hydrogen and in nitrogen. When fermentation has proceeded for a certain time, *Scenedesmus* and similar algae become capable of picking up hydrogen and this rapidly completes their adaptation.

Gaffron suggested that an enzyme, which is usually present in the chloroplasts in an inactive, oxidized form (we may designate it by E_HO) is reduced by a fermentation product H_2F :

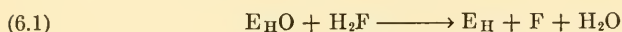

and by this acquires the properties of a *hydrogenase*, *i. e.*, of a reversible acceptor for molecular hydrogen:



capable of transmitting this hydrogen to other substrates:

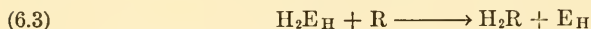

The effect of a hydrogenase on photosynthesis can be understood if one assumes that the role of the oxidant R in (6.3) can be played by the oxidation intermediates of photosynthesis, whose conversion into free oxygen is thus effectively blocked (*cf.* Scheme 6.I, page 136).

If we use the most general formulation of the primary photochemical process (Eq. 7.10a) and designate the primary oxidation product as Z, we may postulate that in hydrogen-adapted algae, reaction (6.4):

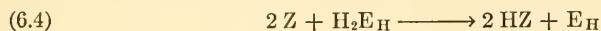

takes the place of reaction (7.10b) and photosynthesis is thus converted into "photoreduction."

To explain the long "incubation period" and the rapid completion of adaptation after the absorption of hydrogen has finally set in, Gaffron suggested that the activation of the hydrogenase is accelerated autocatalytically by the reaction:

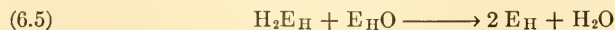

which is the reverse of a dismutation, and may perhaps be designated as a

“commutation.” As soon as some reduced and hydrogenated enzyme, H_2E_H , has been formed, reaction (6.5) allows the organism to dispense with the slow incubation reaction (6.1).

Enzymes capable of introducing molecular hydrogen into cellular metabolism have been discovered by Stephenson and Stickland (1931) in certain colorless bacteria (as *B. coli*) and later found by Roelefsen (1934), Gaffron (1935) and Nakamura (1937, 1938) in the nonsulfur purple bacteria *Rhodovibrio*, *Rhodobacillus palustris* and *Rhodospirillum giganteum*, and in the sulfur bacteria *Thiocystis* and *Chromatium minutissimum*. In each case, a variety of organic and inorganic substrates (methylene blue, fumarate, nitrate, oxygen, etc.) were found to be suitable as hydrogen acceptors. Their assortment is different for different organisms, so that one can conceive of the existence of a number of different, acceptor-specific hydrogenases. However, Yamagata and Nakamura (1938) concluded, from comparative cyanide inhibition experiments with *B. coli formicum*, *Rhodobacillus palustris* and *B. delbrückii*, that the hydrogenase in all these organisms is the same, and that it donates hydrogen to a common intermediate acceptor, after which specific *oxidoreductases* (or an oxidase) transfer it to different final acceptors.

We may assume that the same hydrogenase and the same intermediate acceptor are present also in anaerobically incubated algae.

We designate the primary hydrogen acceptor by A_H , and split equation (6.3) into the two equations (6.6a) and (6.6b); and equation (6.4)—into the two equations (6.6a) and (6.6c):

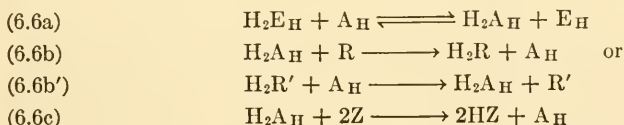

Reaction (6.6a) must be reversible (since adapted algae can either absorb or liberate hydrogen). As for reaction (6.6b), its direction may depend not only on concentrations, but also on the *specific nature* of the metabolites R present in the cell (as expressed by the alternative equation 6.6b').

De-adaptation occurs, in presence of carbon dioxide, if the *intensity of illumination* is raised beyond a certain threshold. The further this threshold is exceeded, the more rapid is the return to normal photosynthesis (cf. Fig. 14, p. 145). The photochemical de-adaptation is irreversible, *i. e.*, hydrogen absorption is not resumed upon return to low light intensity (Fig. 8). However, the adapted state can be restored much more rapidly immediately after de-adaptation than after a prolonged period of aerobic photosynthesis, probably because the autocatalytic

mechanism (6.5) provides for rapid re-adaptation whenever small amounts of the hydrogenated enzyme still are present.

De-adaptation can be enforced *also in the dark*, by means of oxygen. While 0.5% oxygen (constantly renewed to prevent exhaustion by respiration) is sufficient to *prevent* adaptation, the tolerance for oxygen may rise, after adaptation, to 1 or 2%. This is due to the capacity of the adapted cells for the oxyhydrogen reaction (III); only when the rate of oxygen fixation by the cells becomes higher than the maximum possible rate of this reaction, does de-activation become inevitable.

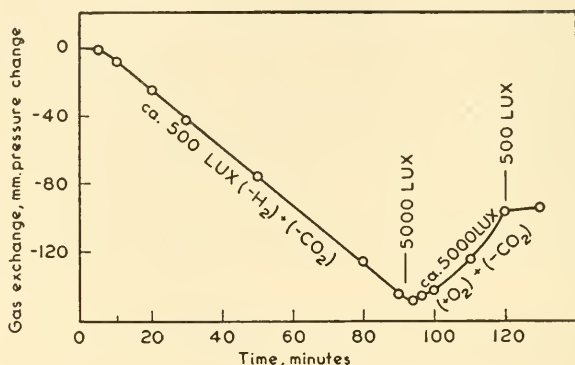

FIG. 8.—The “de-adaptation” of anaerobically adapted *Scenedesmus* by light increase from 500 to 5000 lux is not reversed by return to 500 lux (after Gaffron 1941).

If the reduction of an enzyme is the basis of adaptation, its reoxidation must be the basis of de-adaptation. This oxidation may be attributed either to *free oxygen*, or to *cellular oxidants*, formed as intermediates either in the photochemical reduction of carbon dioxide (in the case of photochemical de-adaptation), or in the oxyhydrogen reaction (in the case of dark de-adaptation).

If one assumes that photochemical and dark de-adaptation are both caused by free oxygen, one cannot help noticing the difference between the partial pressure of oxygen at the moment of *photochemical* de-adaptation (which is exceedingly low) and the comparatively high pressure required for de-adaptation in the dark. To explain this difference, one could suggest that when oxygen is produced photochemically within the cell, a high internal pressure has to be built up before any gas can escape into the atmosphere; so that chemical and photochemical de-adaptation could correspond to the same *internal* oxygen tension in the chloroplasts. Gaffron argued, however, that experiments with the oxygen electrode (*cf.* Volume II, Chapter 33), as well as observations with luminous bac-

teria and fluorescent dyestuffs prove that oxygen appears in the surrounding medium within 0.01 second after the beginning of photosynthesis, and that therefore the internal oxygen tension cannot be markedly different from its external pressure.

If this is so, then *photochemical* de-adaptation, at least, must be attributed to an intermediate of photosynthesis, and not to free oxygen. We shall designate this "oxygen precursor" as $\{O_2\}$, with the braces indicating an "acceptor" or "carrier" molecule. The oxidant $\{O_2\}$ is not likely to be the *direct* product of the primary photochemical process. This is indicated by inhibition experiments (Chapter 12), and by the observation of Rieke and Gaffron (1943) that the de-adaptation in *flashing light* occurs at the same *average* intensity of illumination as does the de-adaptation in continuous light. We therefore assume, with Gaffron, that (at least) two successive enzymatic reactions are required for the conversion of the primary photochemical product Z into O_2 (*cf.* Eqs. 7.10b and c):

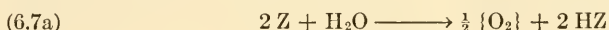

We attribute the photochemical de-adaptation to the reaction:

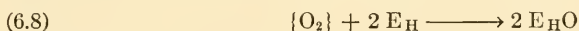

The rate at which the intermediate oxidant $\{O_2\}$ is produced in light, must decrease with decreasing concentration of carbon dioxide, at least in a certain range of concentrations (*cf.* Chapter 27, Vol. II). The tolerance of the adapted state for light should rise under these conditions. In fact, if the carbon dioxide formed by fermentation is removed by an alkaline absorber, the adapted state can be preserved in light which would otherwise cause a rapid de-adaptation.

Another treatment which prevents photochemical de-adaptation, is poisoning with comparatively large quantities of hydroxylamine (*cf.* Chapter 12). Apparently, this agent prevents the conversion of the primary photochemical oxidation product into the hydrogenase-destroying intermediate $\{O_2\}$, *i. e.*, it inhibits reaction (6.7a).

Finally, the tolerance of adapted algae for light can be increased also by the provision of added oxidation substrates, *e. g.*, glucose. They either accelerate the removal of the primary oxidation products, HZ, and thus *prevent* the formation of the oxidant $\{O_2\}$, or reduce this oxidant in competition with the hydrogenase.

Having thus attributed the *photochemical* de-adaptation to accumulation of an intermediate oxidant $\{O_2\}$, we ask whether *dark* de-adaptation should be ascribed to a similar agent, or to free oxygen. Gaffron

pointed out, in support of the second viewpoint, that the maximum rate of hydrogen consumption by the oxyhydrogen reaction, attained when *dark* de-adaptation sets in, is approximately equal to the maximum rate of hydrogen consumption by photoreduction, reached just prior to *photochemical* de-adaptation. This equality finds a plausible explanation in the assumption that de-adaptation is caused by oxidation intermediates, which in both cases must be removed by the hydrogenase system. As long as the removal keeps pace with the photochemical or enzymatic supply of the oxidants, the adapted state is stable; whenever the supply becomes too rapid, an accumulation of oxidants occurs and brings about the de-activation of the hydrogenase. In other words: the maximum attainable rates of photoreduction (in light) and of the oxyhydrogen reaction (in the dark) are the same, because they are both limited by the quantity of available hydrogenase.

One may further ask whether the intermediate oxidant which causes de-activation in the dark is *identical* with the intermediate $\{O_2\}$ of photosynthesis and photoreduction, or merely *similar* to it in its capacity to oxidize the hydrogenase. This question is important because if the first alternative were correct, the oxygen evolution in photosynthesis (reaction 6.7b) would have to be considered as a reversible process, its direction depending on the concentration of $\{O_2\}$ and the partial pressure of oxygen.

The following considerations speak against this concept. In the first place, almost the only known reversible oxygen acceptor in nature is hemoglobin, and it is doubtful whether a similar catalyst exists in plants (*cf.* Chapter 11). In the second place, Gaffron concluded from poisoning experiments that the enzyme E_o ("deoxidase," *cf.* Chapter 11), which catalyzes the oxygen-liberating reaction (6.7b), is *de-activated*, in the course of anaerobic adaptation, simultaneously with the *activation* of the hydrogenase, E_H . If this conclusion is correct, a reversal of reaction (6.7b) in adapted algae is impossible, even if this reaction were thermodynamically reversible in the first place.

Gaffron's argumentation in favor of a de-activation of the enzyme, E_o , in the adapted state was as follows: *Cyanide* prevents adaptation; if applied after completed adaptation, it causes a slow de-adaptation in light. This is best explained by assuming that an oxidation of the hydrogenase occurs continuously during photoreduction, but does not lead to de-adaptation as long as the autocatalytic re-adaptation (reaction 6.5) holds step with the de-adapting reaction (6.8). Cyanide blocks re-adaptation (by "freezing" the hydrogenase in its oxidized state, E_HO), and thus causes a cumulative de-adaptation in light.

This hypothesis implies that a small quantity of the intermediate oxidants $\{O_2\}$ is formed even in the adapted state, where the great

majority of the primary oxidation products HZ is disposed of by reaction (6.6c). If this is true, then the absence of oxygen evolution during photoreduction indicates that the oxygen-liberating enzyme, E_o , is in an inactive state.

Another argument in favor of the absence of an active enzyme, E_o , in the adapted state is, according to Gaffron, the fact that the adaptation process shares with the oxygen evolution in photosynthesis a sensitivity to very small quantities of hydroxylamine and phenantroline. To explain this similarity, one can assume that the complex formation with hydroxylamine "freezes" enzyme E_o in the oxidized state, thus inhibiting its function in photosynthesis, but at the same time preventing its deactivation by reduction during anaerobic incubation.

Gaffron (1943) suggested that the de-activation of E_o does not eliminate this enzyme altogether as a catalytic agent, but converts it into an "oxidase" E_o' (whose presence is revealed by the oxyhydrogen reaction). However, it is thermodynamically impossible for E_o' to catalyze the formation of the same complex $\{O_2\}$, whose decomposition was catalyzed by E_o . (A catalyst has the same effect on the velocity of reaction in both directions, because it cannot shift a thermodynamic equilibrium.) Therefore, we must assume that the transformation of E_o into E_o' brings about a change in specificity—in other words, that enzyme E_o catalyzes the formation of a complex $\{O_2\}'$ which is *different* from the complex $\{O_2\}$, decomposed by enzyme E_o .

As a result of this discussion, we attribute the de-adaptation by excess oxygen to the reactions:

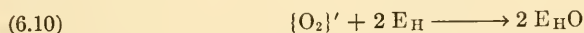

which is analogous to, but not identical with, reaction (6.8), and occurs whenever the removal of $\{O_2\}'$ by the hydrogenase system (*i. e.*, the oxyhydrogen reaction) lags behind the formation of this intermediate by reaction (6.9).

It will be noted that, according to (6.9), the formation of the oxidant $\{O_2\}'$ in the oxyhydrogen reaction cannot be *avoided*; but its rapid consumption (by reaction 6.11) can prevent the deactivating reaction (6.10) from destroying the hydrogenase more rapidly than it is restored by reaction (6.5). As mentioned before, Gaffron assumed that, in photoreduction too, a certain quantity of the oxidant $\{O_2\}$ is formed despite the removal of the preponderant part of the oxidation product, HZ, by reaction with the hydrogenase system.

A summary of the reactions associated with the adaptation and de-adaptation phenomena is given in scheme 6.I.

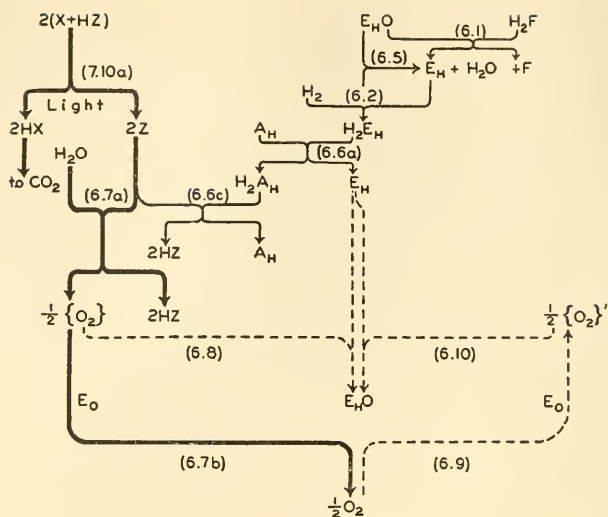

Scheme 6.I.—Reactions in anaerobically adapted algae. (Figures in parentheses refer to equations in text.)

———— Normal photosynthesis.

———— Adaptation and photoreduction (reaction 6.6c competes with 6.7a, thus converting photosynthesis into photoreduction).

----- De-adaptation by the intermediates $\{O_2\}$ (in light) or $\{O_2\}'$ (in excess oxygen).

3. The Dark Reactions of Adapted Algae

We now begin with a more detailed description of the metabolic processes in adapted algae, which were enumerated on page 129.

(I) and (II): **Hydrogen Absorption and Hydrogen Fermentation.**—The absorption and evolution of hydrogen in darkness and in light by pure cultures of *Scenedesmus* D₁, D₃ and *Scenedesmus obliquus* have been studied by Gaffron and Rubin (1942). During the first hour or two of anaerobic incubation, the algae fermented, liberating carbon dioxide and accumulating nonvolatile acids. After this initial period, *Scenedesmus* or *Raphidium* cells, while continuing the steady evolution of carbon dioxide, began to pick up hydrogen, if the incubation took place in a hydrogen atmosphere, and to liberate hydrogen if they were placed in an atmosphere of nitrogen (Fig. 9). Algae which have been allowed to photosynthesize vigorously before incubation, evolved the largest quantity of hydrogen, while those which have been made to respire in the dark for a considerable length of time, gave little hydrogen. The rate of absorption of hydrogen was very slow, but the *total* amount absorbed in several days was considerable—1 ml. of cells took up as much as 2 ml. of hydrogen (simultaneously with the evolution of 1.3 ml. of carbon dioxide). This corresponds to an exchange of about one-tenth

of one mole of hydrogen per liter of cell volume, and shows that the substrate of hydrogenation is a major cell component, whose concentration is considerably larger than that of chlorophyll (the latter being of the order of 0.01 mole per liter, *cf.* page 411).

The liberation of hydrogen can be increased by the addition of an external fermentation substrate, *e. g.*, glucose (Fig. 10). In the presence of 0.07% glucose, (in phosphate buffer of pH 6.2) 1 ml. of *Scenedesmus* cells produced hydrogen steadily at the rate of 0.2 ml. per hour.

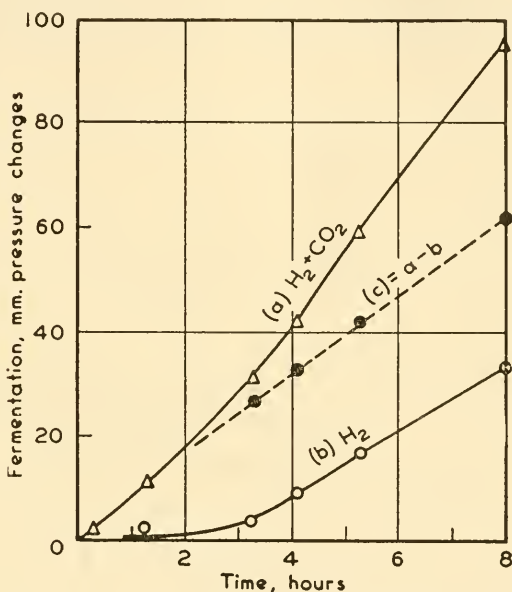

FIG. 9.—Liberation of molecular hydrogen by fermentation in *Scenedesmus* (after Gaffron 1942¹).

0.027 ml. of cells in culture medium with 0.01 *M* phosphate buffer of pH 6, containing 0.2% glucose. 25° C. Curve *b*: KOH solution in side arm of vessel, absorbing carbon dioxide.

Among several carbohydrates investigated by Gaffron and Rubin, glucose alone was found to stimulate fermentation (in all its forms) immediately. All others acted with a lag, indicative of a need for preliminary enzymatic transformation. In contrast to respiration and photosynthesis, the hydrogen fermentation was dependent on pH, with an optimum between pH 6 and 7.

The "acid fermentation" continues independently of the hydrogen fermentation. Therefore, the ratio $\Delta\text{CO}_2/\Delta\text{H}_2$ can vary in the widest limits. Because of the simultaneous appearance of hydrogen fermentation and photoreduction in *Scenedesmus*, it is safe to assume that the

site of the hydrogen fermentation is in the chloroplasts (while acid fermentation may occur everywhere in the cell).

The nonvolatile acids, produced by the autofermentation of algae, contained only a few per cent of lactic acid, while in presence of glucose, this percentage reached 50%. (In some colorless heterotrophic organisms, the fermentation of glucose produces up to 95% lactic acid.)

The mechanism of the hydrogen evolution and absorption by algae which contain an active hydrogenase, can be represented by equations (6.2) and (6.3), (or 6.6a,b): the hydrogen is transferred from the atmosphere, through the reversible systems, $E_H-H_2E_H$ and $A_H-H_2A_H$ (and probably through specific oxidoreductases), to a cellular oxidant, R; or

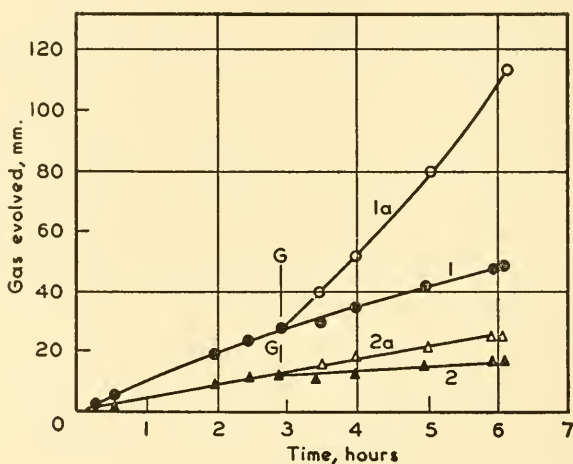

FIG. 10.—Increase in fermentation and hydrogen production in *Scenedesmus* by glucose (after Gaffron 1942¹).

Final sugar concentration, 0.06%. Curve 1: carbon dioxide with acid. Curve 1a: carbon dioxide and acid after addition of glucose. Curve 2: hydrogen. Curve 2a: hydrogen after addition of glucose.

from a cellular reductant $R'H_2$, through a similar catalytic system, back into the atmosphere. The direction of the process should depend on the oxidation-reduction potentials of the cellular reserve substances R and R' , on their concentrations, and on the partial pressure of hydrogen.

(III) and (IV). **Oxyhydrogen Reaction and the Reduction of Carbon Dioxide in the Dark** (Algae as Chemautotrophic Bacteria).—As mentioned on page 132, small quantities of oxygen prevent anaerobic adaptation, but after adaptation, they are tolerated, without causing a return to normal photosynthesis, because they are used up by the *oxyhydrogen* reaction. If a few millimeters of oxygen are added to an adapted *Scenedesmus* culture in a hydrogen atmosphere, in the dark, the algae

begin to consume both hydrogen and oxygen (Gaffron 1940²). Figure 11 shows the course of gas absorption in the presence of about 3.8 mm. Hg of oxygen (50 mm. Brodie solution). The total gas absorption approaches, but does not reach 150 mm. (the value which corresponds to the complete absorption of oxygen, with double its volume in hydrogen).

Figure 11 also shows that the gas consumption increases *above* the $2\text{H}_2 + \text{O}_2$ mark if *carbon dioxide is present*; and analysis shows that, in this case, carbon dioxide is absorbed together with hydrogen and oxygen. The algae probably now function as chemautotrophic "hydrogen bacteria," that is, they couple the combustion of hydrogen with the reduction of carbon dioxide.

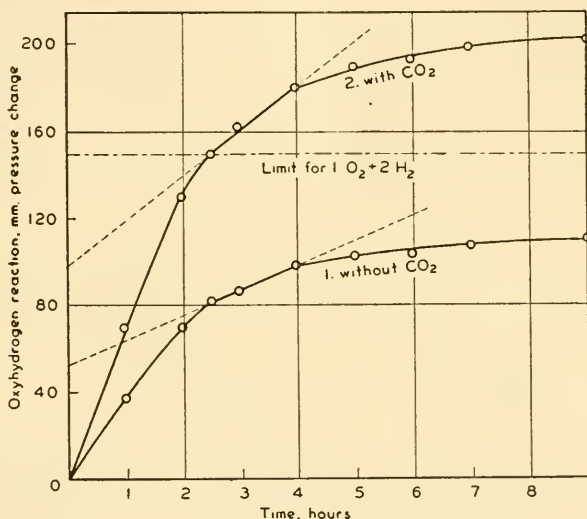

FIG. 11.—Oxyhydrogen reaction in adapted *Scenedesmus* in presence and absence of carbon dioxide (after Gaffron 1942).

Initial oxygen concentration, 50 mm. Brodie solution.

In contrast to *Bacillus picnoticus*, described in chapter V, chemosynthesizing *Scenedesmus* cells have only a very limited tolerance for oxygen. If, for example, the partial pressure of oxygen is increased to 23 mm. Hg (300 mm. Brodie), the rate of the oxyhydrogen reaction declines rapidly and "de-adaptation" sets in. *B. picnoticus*, on the other hand, works well even in pure electrolytic gas. However, other bacteria capable of catalyzing the oxyhydrogen reaction, for example, *Acetobacter peroxidans* (cf. page 118), are also inhibited by excess oxygen.

In a renewed study of the oxyhydrogen reaction in adapted algae, Gaffron (1942²) confirmed that in absence of carbon dioxide, the ratio $\Delta\text{H}_2/\Delta\text{O}_2$ often is much smaller than the theoretical value of 2 for water

synthesis. A similar observation was made in the case of *B. picnoticus* (page 117); but there Ruhland attributed the excess oxygen consumption to respiration, *i. e.*, autoxidation of cellular substrates, which proceeds simultaneously with the combustion of hydrogen. A similar explanation is impossible in the case of the hydrogen-adapted algae. In the first place, the ratio $\Delta H_2/\Delta O_2$ drops in these algae as low as 1.0 (as against a minimum of 1.8 in hydrogen bacteria). In the second place, respiration is practically absent (as shown by determinations of the carbon dioxide production during the oxyhydrogen reaction). Gaffron suggested, therefore, that in the absence of carbon dioxide oxygen is reduced only to a peroxide. (However, since a continuous accumulation of peroxide appears impossible, one must assume that its reduction is completed by

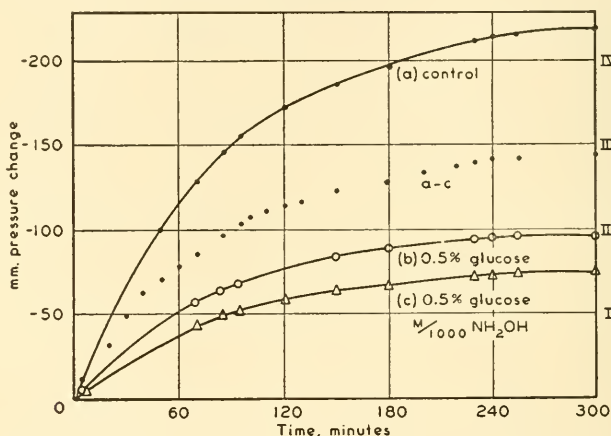

FIG. 12.—Inhibition by glucose of the hydrogen uptake by the oxyhydrogen reaction in *Scenedesmus* (after Gaffron 1942).

cellular hydrogen donors—without the latter's being oxidized to carbon dioxide.)

In presence of carbon dioxide, the ratio $\Delta H_2/\Delta O_2$ is between 2 and 3 (as shown in Fig. 11), while the ratio $\Delta CO_2/(\Delta H_2 - 2\Delta O_2)$ (compare Table 5.VI) is close to 0.5. This indicates that now all absorbed oxygen is reduced to water, while all absorbed carbon dioxide is converted into carbohydrates. Thus, the reduction of carbon dioxide helps the oxyhydrogen reaction to run to completion.

The efficiency of chemosynthesis was measured, on page 117, by the ratios $\Delta CO_2/\Delta H_2$ and $\Delta H_2/\Delta O_2$. The minimum value of the second ratio, in the presence of carbon dioxide, is 2.0 (no chemosynthesis, but a complete combustion of hydrogen to water), while the majority of experiments gave values between 2.6 and 3, a result similar to that obtained by Ruhland with *Bacillus picnoticus* ($\Delta H_2/\Delta O_2 \leq 2.8$, *cf.* Table

5.VI). In other words, in the presence of carbon dioxide, for every two molecules of hydrogen transferred to oxygen, up to one molecule finds its way to carbon dioxide.

In place of molecular hydrogen, hydrogen from organic donors can be used by adapted algae in reactions with oxygen, as shown by the diminution of hydrogen consumption caused by the addition of 0.05–1% of glucose, or yeast autolysate (*cf.* curves *a* and *b* in Fig. 12). The occurrence of coupled carbon dioxide reduction remains to be demonstrated in this case.

The explanation of the oxyhydrogen reaction in adapted algae requires one new assumption (in addition to the presence of a hydrogenase and of an oxidase, which already have been postulated in the interpretation of the adaptation phenomena). This assumption is that the oxidant $\{O_2\}'$ can react not only with the hydrogenase, E_H (thus causing deadaptation) but also with the intermediate reductant, H_2E_H , thus completing the transfer of hydrogen to oxygen. The fact that the ratio $\Delta H_2/\Delta O_2$ in the absence of carbon dioxide often is closer to 1 than to 2 indicates that this reaction takes place in two steps:

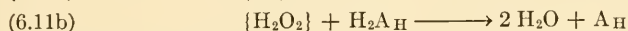

and that the second step can be replaced by reaction with an internal hydrogen donor:

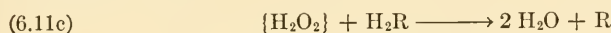

thus reducing the hydrogen consumption to one molecule of hydrogen per molecule of oxygen.

This mechanism of the oxyhydrogen reaction is represented in scheme 6.IIA, which is merely a partial elaboration of scheme 6.I.

In the presence of carbon dioxide, reaction (6.11) runs to completion, and one molecule of carbon dioxide can be reduced simultaneously with the reduction of two molecules of oxygen. This indicates that reaction (6.11c) is replaced by a "coupled" reaction:

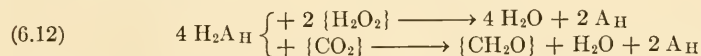

represented by scheme 6.IIB. A combination of (6.11) with (6.12) leads to the ratios $\Delta H_2/\Delta O_2 = 3$ and $\Delta CO_2/(\Delta H_2 - 2\Delta O_2) = \frac{1}{2}$, in agreement with the experimental values.

The nature of the coupling between the oxyhydrogen reaction and the reduction of carbon dioxide, symbolized by bracketing in (6.12) will be discussed in chapter 9 (page 235).

Equation (6.12) shows that the "chemosynthetic" reduction of carbon dioxide in adapted algae requires the existence of an enzymatic

link between the hydrogenase-oxidase system on the "oxidation side" of the primary photochemical process (*cf.* Scheme 6.I) and the catalytic system on the "reduction side" of this primary process (which takes care of the reduction of carbon dioxide in photosynthesis). A similar

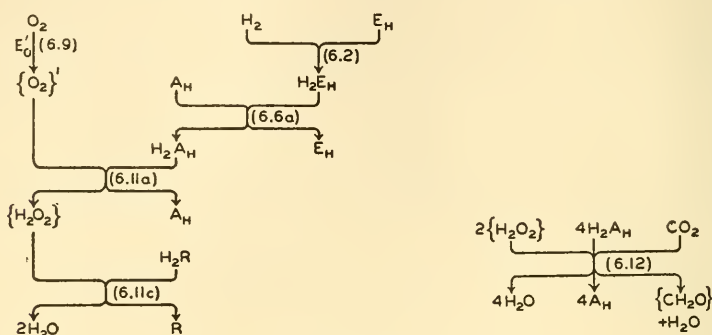

Scheme 6.II

A. Mechanism of the oxyhydrogen reaction in adapted algae.

B. Carbon dioxide reduction coupled with the second stage of the oxyhydrogen reaction.

(Figures in parentheses refer to equations in text.)

link is required also for the explanation of the photochemical absorption and evolution of hydrogen which will be discussed in the next section.

4. The Photochemical Reactions of Adapted Algae

(V) and (VI). **Photochemical Absorption and Liberation of Hydrogen.**—As mentioned on page 129, illumination accelerates both evolution and absorption of hydrogen by adapted *Scenedesmus* cells (*cf.* Fig. 13). The dependence of both effects on light intensity is so different, that sometimes a change in light intensity can convert hydrogen evolution into hydrogen consumption. For example, on the left side of figure 13, (which corresponds to 0.2% H_2 in the air), hydrogen absorption prevails at 800 lux and hydrogen evolution at 3500 lux. On the right side of the same figure (in an atmosphere of pure hydrogen), even an illumination of only 400 lux causes a rapid saturation of the cells with hydrogen.

The photochemical liberation of hydrogen can be observed only in absence of carbon dioxide. If the latter gas is admitted, it acts as an acceptor for hydrogen, and photochemical hydrogen liberation is transformed into photoreduction. Since acid fermentation liberates carbon dioxide continuously as long as the cells are deprived of oxygen, experiments on hydrogen liberation in light have to be carried out with alkali in a side arm of the manometer, and allowance must be made for the amount of carbon dioxide consumed by photoreduction before it had

time to reach the absorption vessel. Similarly to the hydrogen fermentation in the dark, the hydrogen production in light can be sustained by an added hydrogen donor, *e. g.*, glucose.

The hydrogen evolution in light is not affected by some poisons (*e. g.*, dinitrophenol) which inhibit the hydrogen fermentation in the dark. It thus seems that light permits the by-passing of an enzymatic step necessary for the hydrogen fermentation in the dark.

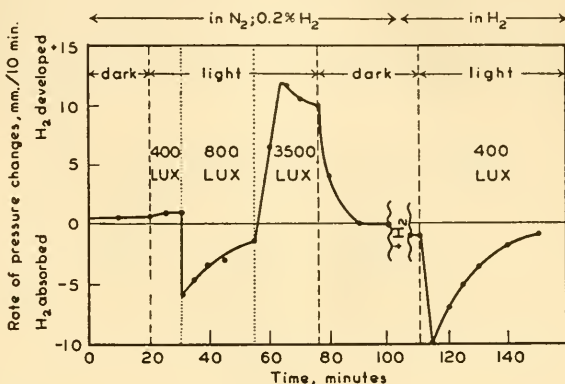
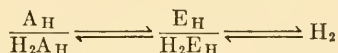

FIG. 13.—Photochemical absorption and evolution of hydrogen by *Scenedesmus* in absence of carbon dioxide at different light intensities (after Gaffron 1942).

0.074 ml. of cells of *Scenedesmus* D₃ in 0.05 M phosphate buffer of pH 6.2 at 25° C. Side arm contains KOH. Preceding dark periods, 20 hours; during this time the algae have formed hydrogen up to 0.2% of the gas phase.

The explanation of the *photochemical evolution of hydrogen* requires the assumption that the photochemical hydrogen transfer can be interposed between the hydrogen donor R'H₂ and the hydrogenase system



as represented in scheme 6.III, where the photochemical reaction sequence (6.14), (7.10a), (6.13), achieves the same result as the dark reaction (6.6b'). The method of representation used in scheme 6.III is different from that in schemes 6.I and 6.II. Instead of giving a complete representation of each partial reaction, we have merely written down the oxidation-reduction systems which participate in the process, and indicated by arrows the direction of hydrogen transfer between them.

The *photochemical absorption of hydrogen* can be interpreted in two ways: either as a light-accelerated hydrogenation of organic acceptors, R, or (as mentioned on page 129) as a photoreduction of carbon dioxide produced by fermentation. The first alternative is represented in scheme 6.III by the reaction sequence (6.6c), (7.10a), (6.15), whose

final result is identical with that of the dark reaction (6.6b). In the second alternative, reaction (6.15) is replaced by (7.10d,e).

Comparing scheme 6.III with scheme 6.I, we find two new features. In the first place, it provides for an enzymatic link between the catalytic systems on both sides of the primary photochemical hydrogen transfer, by means of the reaction:

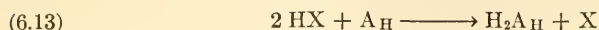

This means that the primary reduction product in photosynthesis is capable of supplying hydrogen back to the same acceptor which serves as a reductant for the primary photochemical oxidation product, Z,

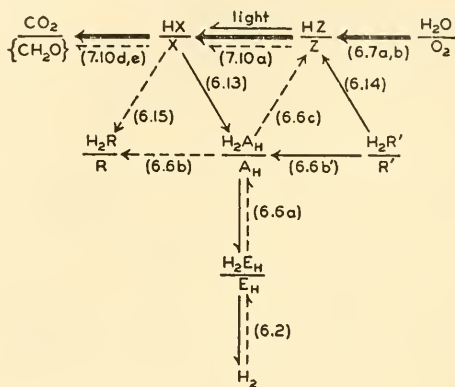

Scheme 6.III.—Photochemical and dark reactions in adapted algae. Simplified representation. Arrows indicate hydrogen transfers between two oxidation-reduction systems. Full equations given in text and referred to by figures in parentheses.

← Normal photosynthesis (6.7a, b), (7.10a), (7.10d, e).

← Photochemical and dark hydrogen liberation. The first step of the dark reaction (6.6b') is by-passed in light via (6.14), (7.10a) and (6.13).

← - - - Photochemical and dark hydrogen consumption. The last step of the dark reaction (6.6b) is by-passed in light, via (6.6c), (7.10a) and (6.15); alternatively hydrogen may go in light to CO₂ (by reactions 7.10d, e) instead of R (by reaction 6.15).

by means of reaction (6.6c). The necessity for a nonphotochemical linkage between the two catalytic systems already was emphasized in connection with the mechanism of the chemosynthetic reduction of carbon dioxide, where an enzymatic link had to be provided from the hydrogenase system to carbon dioxide.

The second feature of scheme 6.III are the direct links (6.14) and (6.15):

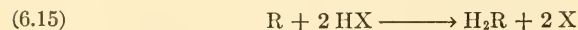

between the cellular hydrogen donors, H_2R' , and cellular hydrogen acceptors, R , on the one side, and the primary photochemical products, Z and HX , on the other, which provide parallel photochemical channels to dark reactions (6.6b) and (6.6b'). (This relation between the paths of dark and photochemical reaction explains, incidentally, why they are not necessarily inhibited by the same poisons.)

The assumption of reaction (6.14) leads to a question which must for the time being be left open: Why are nonadapted green plants—in which

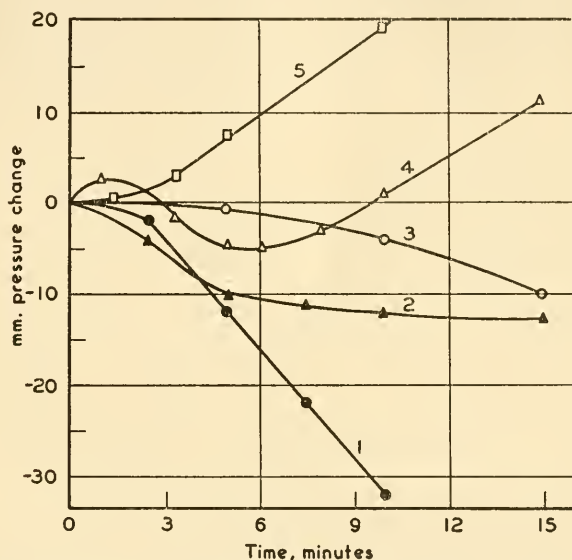

FIG. 14.—Time course of gas exchange of anaerobically incubated *Scenedesmus* (after Gaffron 1942).

Downward trend—absorption of hydrogen; upward trend—liberation of oxygen.

1—Hydrogen—560 lux.

3—Hydrogen—200 lux.

2—Hydrogen—1020 lux.

4—Hydrogen—6000 lux.

5—Air—6000 lux.

allegedly only the system H_2E_H/E_H is eliminated by oxidation to E_HO —incapable of using organic compounds as hydrogen donors in photosynthesis (instead of water)? One may suggest that the enzyme which catalyzes reaction (6.14) is de-activated simultaneously with the hydrogenase, or that the rate of reaction (6.14) is so slow as to make its competition with reaction (6.7a,b) impossible, as long as the “deoxidase” which catalyzes the latter reaction is fully active. (The de-activation of this enzyme was postulated, on page 134, to be the second feature of the adaptation process, supplementing the activation of the hydrogenase.) Reaction (6.15) poses a similar question as to why plants are unable

to use cellular oxidants, R, as hydrogen acceptors in photosynthesis instead of carbon dioxide. However, it was mentioned above that this reaction can be eliminated if one assumes that the hydrogen absorbed in light is conveyed to the fermentation carbon dioxide rather than to R.

(VI) and (VII). **Photoreduction by Adapted Algae** (Algae as Photosynthesizing Bacteria).—Hydrogen-adapted algae can reduce carbon dioxide either at the cost of molecular hydrogen or of organic hydrogen donors, the latter taking precedence as long as they are available. When adapted algae are illuminated in presence of carbon dioxide, the photochemical consumption of hydrogen sets in only after a certain delay,

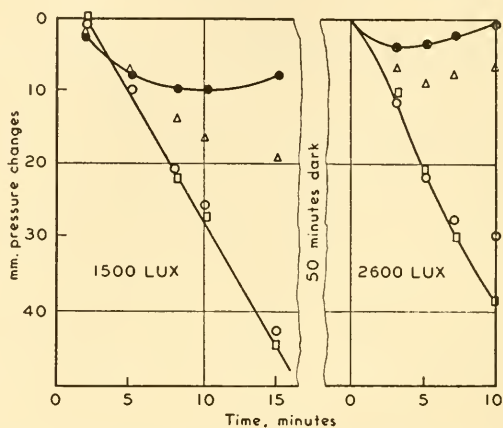

FIG. 15.—Time course of photoreduction by adapted *Scenedesmus D₃* as a function of the partial pressure of hydrogen (after Gaffron 1942).

Culture medium. Adaptation 16 hours in hydrogen; 4% carbon dioxide. All mixtures of hydrogen and nitrogen contained 4% carbon dioxide. □—96% hydrogen; ○—22% hydrogen; △—8% hydrogen; ●—4% hydrogen.

during which the cellular hydrogen donors are used up. In agreement with this explanation, the length of the "induction period" decreases with increased light intensity (while in ordinary photosynthesis the length of the induction period is independent of light intensity). The induction effect is illustrated by the curves for 200 and 560 lux in figure 14; the curves for 1020 and 6000 lux show, in addition to induction, the de-adaptation by excessive light.

The "photosynthetic quotient," $\Delta H_2/\Delta CO_2$, of the hydrogen-adapted algae was found by Gaffron (1940²) to be 1.97 (average of five measurements with *Scenedesmus D₃*, and seven measurements with *Scenedesmus obliquus*, individual values varying between 1.84 and 2.17). This result can be compared with the corresponding quotients found for purple hydrogen bacteria and assembled in table 5.III. In that table, some

figures (particularly those of French and Wessler) were considerably above 2. Gaffron, too, at first found quotients as high as 3, but decided that these high values were due: (a) to hydrogen absorption not connected with photoreduction; and (b) to carbon dioxide liberation by acid fermentation.

The consumption of hydrogen increases linearly with light intensity between 200 and 600 lux; but before any "light saturation" can be observed "de-adaptation" sets in, as illustrated by figure 14, and photoreduction is replaced by normal photosynthesis. De-adaptation can be delayed by hydroxylamine or phenantroline (*cf.* Chapter 12, page 319); the maximum rate of photoreduction observed under these conditions was three times the rate of dark respiration.

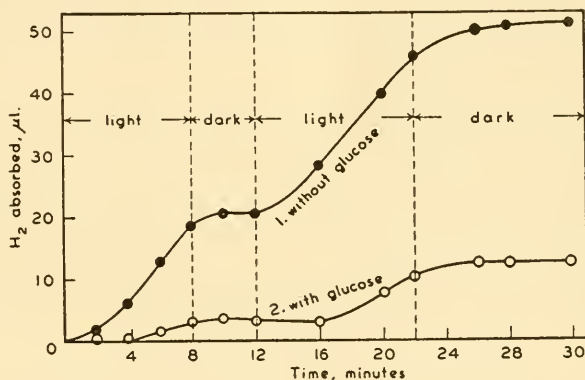

FIG. 16.—Photoreduction with hydrogen in *Scenedesmus* (after Gaffron 1940).

Preceding anaerobiosis, 12 hours. 20° C. in H₂. Curve I: cells washed and suspended in 0.01 M NaHCO₃. Curve II: cells suspended in nutrient medium with 0.01 M NaHCO₃ and 0.5% glucose.

The effect of *hydrogen concentration* on the rate of photoreduction in nitrogen is shown in figure 15. The reaction is slowed down when the hydrogen concentration is below 20% and de-adaptation starts rapidly below 4%.

It was mentioned before that hydrogen-adapted algae also may function like *heterotrophic* purple bacteria, that is, reduce carbon dioxide at the cost of hydrogen from organic donors. The delay in hydrogen absorption, which was attributed above to the "cleanup" of intercellular hydrogen donors, and illustrated by figure 14, can be interpreted as evidence of this type of metabolism. This delay can be extended by a supply of organic reductants. Figure 16 shows the effect of glucose on the consumption of hydrogen. The hydrogen absorption in the dark is inhibited entirely, and that in light is strongly reduced. An induction

period of four minutes appears in light, during which no hydrogen is consumed at all. Obviously, the supply of hydrogen from glucose or its metabolic derivatives suffices to cover all requirements in the dark, and to eliminate the absorption of hydrogen from outside in the first four minutes of illumination. After that, the more rapidly diffusing molecular hydrogen enters into competition with the slower diffusing glucose. A complete inhibition of hydrogen uptake has been observed when yeast autolysate is used instead of glucose.

The explanation of the photoreduction by adapted algae is contained in scheme 6.I. It is due to the "interception" of the photochemical oxidation products by the hydrogenase system, with the cellular hydrogen donors $R'H_2$ and external hydrogen competing as suppliers of hydrogen to the intermediate reductant, H_2A_H (cf. Schemes 6.II and 6.III). The evolution of oxygen is probably prevented not only by this interception (which, as noted on page 135, is not perfect), but also by the de-activation of the "deoxidase," E_O (page 134).

The photosynthesis of green and purple bacteria may proceed by exactly the same mechanism as the photoreduction by adapted algae (except that their enzymatic system is "frozen" and under no circumstances can switch over to the liberation of oxygen); but more probably, the incapacity of purple bacteria to produce oxygen is caused by a different character of the primary oxidation products, Z , which do not contain sufficient energy for transformation into $\{O_2\}$ and free oxygen, and can only be reduced by the hydrogenase system (cf. Chapter 7, page 169).

Despite the analogy between the metabolism of adapted algae and purple bacteria, there is a difference in the role which this metabolism can play in the life of these plants: Gaffron (1943) found that, after several days of "photoreduction," the algae showed no multiplication or increase in chlorophyll concentration comparable to that caused by a similar period of photosynthesis.

Bibliography to Chapter 6

The Metabolism of Anaerobically Adapted Algae

- 1927 G n vois, L., *Biochem. Z.*, **186**, 461.
1931 Stephenson, M., and Stickland, L. H., *Biochem. J.*, **25**, 205, 215.
1934 Roelefsen, P. A., *Proc. Acad. Sci. Amsterdam*, **37**, 660.
1935 Gaffron, H., *Biochem. Z.*, **275**, 301.
1937 Nakamura, H., *Acta Phytochim. Japan*, **9**, 189.
1938 Nakamura, H., *ibid.*, **10**, 259.
Nakamura, H., *ibid.*, **10**, 271.
Yamagata, S., and Nakamura, H., *ibid.*, **10**, 297.

- 1939 Gaffron, H., *Nature*, **143**, 204.
- 1940 Gaffron, H., *Am. J. Botany*, **27**, 273.
Gaffron, H., *Science*, **91**, 529.
- 1941 Franck, J., and Gaffron, H., in *Advances in Enzymology*, Vol. 1.
Interscience, New York, 1941, pp. 199-262.
- 1942 Gaffron, H., *J. Gen. Physiol.*, **26**, 195.
Gaffron, H., *ibid.*, **26**, 241.
Gaffron, H., and Rubin, J., *ibid.*, **26**, 218.
- 1943 Rieke, F. F., and Gaffron, H., *J. Phys. Chem.*, **47**, 299.
- 1944 Gaffron, H., *Biol. Rev. Cambridge Phil. Soc.*, **19**, 1.

CHAPTER 7

THE PRIMARY PHOTOCHEMICAL PROCESS *

1. The Problem of the Primary Process

Observations with isolated chloroplasts, bacteria, and hydrogen-adapted algae, described in chapters 4, 5 and 6, as well as kinetic measurements (to be described in Volume II), indicate that photosynthesis is not a direct reaction between carbon dioxide and water, but a complicated sequence of physical, chemical and photochemical processes. One of the most important problems in the study of the mechanism of photosynthesis is the identification of the *primary photochemical reaction* (or reactions), and its separation from the nonphotochemical processes, which may precede or follow it in the reaction sequence.

In the third chapter, the photosynthesis of green plants was described as a hydrogen transfer from water to carbon dioxide; and in the fifth chapter, bacterial photosynthesis was characterized as a transfer of hydrogen to the same acceptor, from reductants other than water. Although these hydrogen transfers may be associated with reactions of a different type, *e. g.*, carboxylations, hydrations, phosphorylations or dismutations, we feel safe to assume that the primary photochemical process is a stage in the main oxidation-reduction process.

One suggestion of a different kind (*cf.* Ruben 1943, and Emerson, Stauffer and Umbreit 1944) was that the absorbed light energy (or, at least, a part of it) is used for the *synthesis of high energy phosphate esters*, whose subsequent degradation is coupled with endergonic oxidation-reductions. This theory, derived from observations on the mechanism of energy utilization in respiration and fermentation, will be discussed in chapter 9 (page 226), and found improbable.

Even less plausible is the hypothesis of Kautsky (1932) that the light energy is first stored in metastable oxygen molecules (*cf.* Chapter 18, page 514), later modified by the substitution of a dissociable oxygen complex for free oxygen (*cf.* Kautsky and Franck 1943).

Another suggestion, which we consider quite implausible, was made by Seybold (1941). He thought that the light energy absorbed by chlorophyll *b* is used for *polymerization of sugars to starch* rather than for the reduction of carbon dioxide.

* Bibliography, page 170.

In the present chapter, we will disregard these hypotheses and consider the primary photochemical process as a stage in the main oxidation-reduction reaction between water (or a substitute reductant) and carbon dioxide.

In green plants, and in many bacteria as well, the hydrogen transfer must occur against the gradient of chemical potential, *i. e.*, from an oxidation-reduction system (O_2-H_2O) with a more negative potential to a system ($CO_2-\{CH_2O\}$) with a more positive potential. This "uphill flow" is possible only with the assistance of external energy; here, light is called upon to play its part. However, the exact location of this "lift" in the reaction sequence cannot be predicted *a priori*. When a canal is built between two bodies of water situated at different levels, the provision of locks cannot be avoided; but whether these locks are constructed at the upper or lower end of the waterway is a purely practical problem. Similarly, the photochemical processes, which serve as "locks" in the flow of hydrogen from water to carbon dioxide, can be located either at the beginning of the transfer (in the oxidation of water) or at its end (in the reduction of carbon dioxide), or somewhere in the middle, or even in several different places.

The description of the photochemical process in photosynthesis as a *transfer of hydrogen atoms*, which will be used throughout this chapter, does not exclude the possibility that it may be primarily an *electron transfer*. As described elsewhere (*cf.* Chapter 9, page 219), electron transfers coupled with acid-base equilibria, are equivalent to hydrogen transfers (and, if coupled with hydrations and dehydrations, may be equivalent to oxygenations).

Franck (1935) and Stoll (1936) once made the suggestion that the primary photochemical process in photosynthesis may be an *exchange of hydrogen for hydroxyl* (*cf.* Chapter 19, page 555). However, the assumption of a transfer of hydroxyl radicals from carbonic acid to water is equivalent to the postulate that one part of the liberated oxygen originates in carbon dioxide, a concept which was found in chapter 3 (page 55) to be in conflict with experimental evidence.

Looking for analogies to the postulated primary photochemical reaction in the realm of ordinary photochemistry, we find them in certain phenomena discussed in sections 4 and 5 of chapter 4. It was suggested there, that light absorption by *inorganic ions* in solution often leads to the oxidation of water, even though this effect remains "hidden" because of the high rate of back reactions. In certain *dye-stuff* solutions, a similar photochemical electron transfer takes place in the presence of added reductants, for example, ferrous ions, and may perhaps occur also in their absence. In the system thionine-ferrous ions, the back reaction is so slow that the mixture can lose all its color in light (as described

in Chapter 4, page 77), despite the fact that the oxidation potential of thionine is several tenths of a volt more positive than that of ferric iron. This is the best-known photochemical reaction *in vitro* which is fundamentally similar to the postulated primary photochemical process in photosynthesis—similar in that it, too, is an oxidation-reduction which, with the help of light, proceeds against a considerable gradient of chemical potential.

The unique characteristic of photosynthesis probably is not the photochemical transfer of hydrogen from water to an oxidant much weaker than oxygen, brought about by visible light—this may be a common occurrence even in nonbiological systems—but the *avoidance of back reactions*. The latter prevent a direct demonstration of primary photochemical water oxidation in many simple inorganic systems, and make even the photooxidation of ferrous ions by thionine a transitory phenomenon.

The secret of how back reactions are prevented in photosynthesis must be sought in the *heterogeneous structure* of the photosynthetic apparatus and the consequent *topochemical* mechanism of the whole process—meaning by this term a chemical mechanism in which the participants follow prescribed paths on the catalytic surfaces, without appearing as free intermediates between the successive steps of their catalytic transformations. The preservation of at least a part of this structure in isolated chloroplasts may account for the success of Hill's experiments on chloroplast-sensitized photooxidation of water by ferric oxalate.

Theoretically, there is no reason why *all* electronic energy contained in molecules excited by the absorption of light should not be available for oxidation-reductions. A light-excited molecule is both an efficient electron donor (that is, reductant) because it contains a "loose" electron; and a potential electron acceptor (that is, oxidant) because (to use a picture suggested by Weiss) it contains a "hole" in its usual complement of electrons.

All electronic excitation energy is "free energy" and thus available for chemical reactions. Therefore, *in a true thermodynamic equilibrium*, light-excited molecules can be assigned oxidation-reduction potentials equal to those of the same molecules in the normal state plus (or minus) their electronic excitation energy. Excitation by visible light ($\lambda = 700\text{--}400\text{ m}\mu$) should add (or subtract) from 1.7 to 3 volt to the oxidation-reduction potential of the excited molecules, and thus make even the weakest oxidants thermodynamically capable of oxidizing water, and even the weakest reductants able to reduce carbon dioxide. However, a photochemical reaction is practically never a part of a true thermodynamic equilibrium (unless we consider systems at very high temperatures, as, for example, the cosmic bodies). What is observed under ordinary conditions is a progressive conversion of light, partly into heat and partly into chemical energy; the high theoretical oxidation or reduction potentials of the light-excited molecules are of no practical avail if the conversion into heat occurs much more rapidly

than the energy-storing photochemical reaction. In other words, the problem of oxidation and reduction by light-activated molecules is one of *reaction kinetics* rather than *thermodynamics*.

We will now describe the different specific interpretations of the photochemical oxidation-reduction process in photosynthesis, using a logical rather than historic approach. It was stated above that the photochemical stage may be located at the "oxidation end" or at the "reduction end," or in the middle, of the sequence of reactions by which hydrogen atoms are transferred from water to oxygen. We can represent this "hydrogen bucket brigade" by the following scheme:

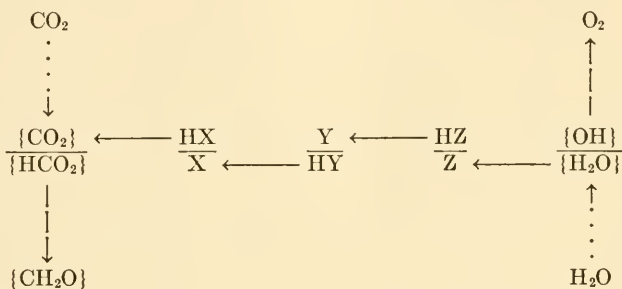

Scheme 7.I.—Photosynthesis as an oxidation-reduction, coupled with preparatory and finishing catalytic reactions (represented by dotted and dashed arrows respectively). Full arrows symbolize hydrogen transfers (or electron transfers) between adjacent oxidation-reduction systems.

Full arrows in scheme 7.I symbolize hydrogen transfers between adjacent oxidation-reduction systems (*e. g.*, the second full arrow from the left represents the reaction $\text{HY} + \text{X} \longrightarrow \text{Y} + \text{HX}$). For the sake of simplicity, all these systems are assumed to be "monovalent" (*cf.* Chapter 9). Broken arrows represent "finishing" catalytic reactions (dismutations, polymerizations, etc.) by which the first reduction product of carbon dioxide, $\{\text{HCO}_2\}$, is converted into a carbohydrate, and the first oxidation product of water, $\{\text{OH}\}$, into free oxygen, while dotted arrows symbolize the "preparatory" reactions by which the reactants (CO_2 and H_2O) are "fixed" prior to their participation in the oxidation-reduction proper. Braces in scheme 7.I—as throughout this book—indicate that the components are supposed to be present, not in the free state, but as parts of larger molecules or complexes.

The catalytic system which serves as the immediate hydrogen donor to carbon dioxide (or to a carbon dioxide-acceptor complex, *cf.* Chapter 8), is designated in scheme 7.I by X, and the system which serves as the immediate hydrogen acceptor from water (or a water-acceptor complex), by Z, while Y stands for an intermediate catalyst which does not react

directly with either of the two reaction components. Photosynthesis might require several such intermediates (Y' , $Y'' \dots$), or none at all. It is even possible (although not very probable) that only a single oxidation-reduction system lies between water and carbon dioxide, *i. e.*, that X and Z are identical (this single intermediary being the chlorophyll, *cf.* Chapter 19).

Any one (or several) full arrows in scheme 7.I may represent the primary photochemical process (or processes). If one assumes only one such process, it appears that *four quanta* should be sufficient to bring about photosynthesis, since four hydrogen atoms are required for the reduction of one molecule of carbon dioxide to the carbohydrate level. Earlier quantum yield determinations seemed to support this conclusion (Vol. II, Chap. 29); and, even though recent experiments have proved it to be incorrect, it is still useful to begin our discussion with the consideration of "four quanta theories," since they can be used afterwards as a basis for theories in which a larger number of quanta are assumed to contribute to the reduction of one molecule of carbon dioxide. We shall initiate this discussion in section 2 (page 155) with the four quanta theories which consider the primary photochemical process to be the *dehydrogenation of water* (*cf.* Scheme 7.II). In section 3 (page 157), we shall consider a similar theory which identifies this process with the *hydrogenation of carbon dioxide* (*cf.* Scheme 7.III); and in section 4 (page 159), we shall make the least specific assumption that the primary process is an *exchange of hydrogen between two intermediates* (*cf.* Scheme 7.IV).

Thermochemical difficulties (Vol. II, Chapter 29) make four quanta theories implausible, and recent redeterminations of the quantum yield of photosynthesis have confirmed that at least eight quanta are required for the reduction of one molecule of carbon dioxide. The next step in our discussion will thus be the transition to "eight quanta theories," by a combination of two different or identical four quanta processes. Two "eight quanta theories" will be discussed in sections 5 and 6 (pages 160 and 164). In the first one, *four* hydrogen atoms take part in *two different* photochemical transfers each (*cf.* Schemes 7.V and 7.VA), while in the second, *eight* hydrogen atoms are transferred by eight *identical* photochemical reactions, but the energy of four of them is used afterwards for a second activation of the other four (*cf.* Scheme 7.VI).

In these eight quanta schemes, too, the primary photochemical processes may be located either at the "oxidation end" or at the "reduction end" of the reaction sequence (or in both places), or somewhere in the middle. In schemes 7.V and 7.VI, the last alternative is used as the least specific one. We consider these schemes the most appropriate starting points in the quest for the true chemical mechanism of photosynthesis. Scheme 7.VA, suggested by Franck and Herzfeld (1941)

represents a possible elaboration of 7.V; its advantages and disadvantages will be discussed in section 7.

In Franck and Herzfeld's theory (as well as in several other theories of the primary process), one of the participants in the photochemical oxidation-reduction was identified with chlorophyll. We have eliminated all reference to chlorophyll from reaction schemes in this chapter, so as not to prejudice their generality. The chemical function of chlorophyll in photosynthesis, and its possible identification with one of the intermediate oxidation-reduction catalysts in scheme 7.I, will be discussed in chapter 19.

2. Oxidation of Water as the Primary Process

FIRST FOUR QUANTA THEORY

In first formulating the oxidation-reduction theory of photosynthesis, van Niel (*cf.* van Niel and Muller, 1931, Muller 1933, van Niel 1931, 1935, 1941) postulated that photosynthesis involves a single photochemical reaction and that this reaction is the *decomposition of water* (as was suggested earlier by Bredig in 1914, Hofmann and Schumpelt in 1916, Thunberg and Weigert in 1923, and Wurmser in 1930). The reduction of one molecule of carbon dioxide to a carbohydrate requires the transfer of *four* hydrogen atoms. If we assume that each of these atoms is contributed by a different molecule of water, that is, if we select the alternative reaction (3.14) in preference to (3.13), we can postulate, with van Niel, *four identical primary photochemical reactions*:

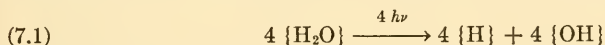

where $h\nu$ symbolizes, in the usual way, a quantum of light energy.

The decomposition of water has also been postulated, as the principal or only photochemical reaction in photosynthesis, by Shibata and Yakushiji (1933), Dhar (1934), and Gaffron (1942).

In equation (7.1), braces again indicate that the components and products of this reaction do not occur in the free state. Water is assumed to be attached to a molecular complex, which probably includes the sensitizer (chlorophyll), while the "primary reduction product," $\{H\}$, and the "primary oxidation product," $\{OH\}$, are taken up by unknown "acceptors." With *free* molecules, atoms and radicals, reaction (7.1) would require not less than 110 kcal per mole (*cf.* Table 9.II), that is, more than twice the energy available in one quantum of red light. In order to make the primary reaction (7.1) at all possible, the energy of association of the products, $\{H\}$ and $\{OH\}$, with their acceptors, must be larger than that of water, by at least 70 kcal per mole. (We recall

that, on page 73, the adsorption of hydrogen and hydroxyl radicals by zinc oxide was suggested as an explanation of the zinc oxide-sensitized decomposition of water in ultraviolet light.)

Instead of representing the elementary photochemical process as a *decomposition* of water (as it appears in equation 7.1), it may be useful to emphasize its character as an *oxidation-reduction*, with water (or a water-acceptor complex) in the part of the reductant and an intermediary hydrogen acceptor in the part of the oxidant. In this case, we may write, using the symbols introduced in scheme 7.I:

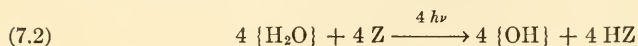

The completion of photosynthesis, initiated by reaction (7.2), calls for a nonphotochemical reduction of carbon dioxide (or, more probably, of an association product, $\{CO_2\}$), by the primary reduction product HZ, perhaps through the intermediary of other catalysts (Y and X in scheme 7.I):

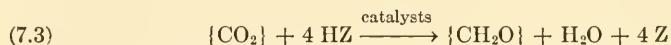

We have further to assume the dismutation of the oxidation product, $\{OH\}$, into water and oxygen. The latter can occur either directly,

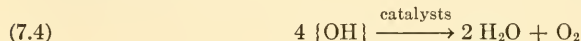

or through the intermediary of biradicals (peroxides $\{OH\}_2$ or moloxides $\{O_2\}$, cf. Chapter 11):

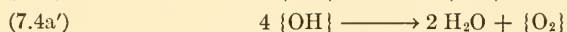
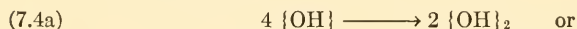

The alternative formulation of equations (7.4a) and (7.4b) is the one used previously in chapter 6, *e. g.*, in scheme 6.I.

By the summation of (7.2) and (7.4), one obtains, for the oxidation of water in photosynthesis, the equation:

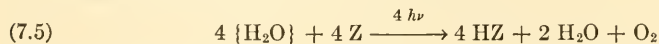

By further addition of equation (7.3), the *over-all reaction of photosynthesis* becomes

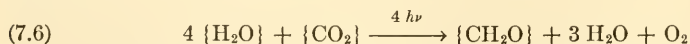

Thus, in van Niel's theory, *four* water molecules and *one* carbon dioxide molecule participate in the formation of *one* $\{CH_2O\}$ group, and *three* water molecules are recovered in the end—two by the dismutation of the

first oxidation product, according to (7.4), and one by the dehydration of an intermediate reduction product, as described by equations (3.11) and (3.12).

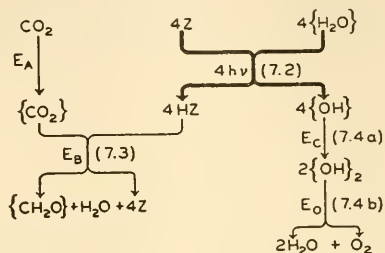

Scheme 7.II.—Photosynthesis, with water oxidation by an intermediate catalyst as the primary photochemical process (first four quanta theory).

Scheme 7.II may help to visualize the mechanism of photosynthesis according to van Niel. The heavy arrow in this and all subsequent schemes designates the primary photochemical process, while figures in parentheses refer to equations in text.

Wislicenus (1918), Thunberg (1923) and Weigert (1923, 1924) suggested that the primary photochemical process in photosynthesis is the decomposition of water into *hydrogen* and *hydrogen peroxide*, and that it is followed by a nonphotochemical reduction of carbon dioxide by *hydrogen peroxide*, either alone (Eq. 4.18), or in cooperation with hydrogen (Eq. 4.19b). As stated in chapter 4 (page 79), the nonphotochemical reactions postulated in this theory require too much energy to occur spontaneously at the low temperatures prevailing in living organisms. There is therefore no need to consider the Thunberg-Weigert theory in more detail here.

Experiments to be described in chapter 11 (page 295) prove that the substitution of heavy water for ordinary water affects the rate of a nonphotochemical reaction in photosynthesis. This does not furnish, however, an argument against the participation of water in the primary photochemical process, because hydrogen (or deuterium) atoms transferred by light from water to an intermediate acceptor must afterwards take part in a number of catalytic reactions. In fact, the only partial reaction in photosynthesis whose rate is likely to be left unaffected by the substitution of heavy water for ordinary water, is the fixation of carbon dioxide in the $\{\text{CO}_2\}$ complex.

3. Reduction of Carbon Dioxide as the Primary Process

SECOND FOUR QUANTA THEORY

The oldest theory, according to which the primary process in photosynthesis was thought to be the *decomposition of carbon dioxide*, had to be discarded when hydrogen transfer was proved to be the main mechanism of biochemical oxidation-reductions, and when all oxygen in photosynthesis was shown to originate in water. We can nevertheless associate the primary photochemical process in photosynthesis with a transformation of carbon dioxide, if we consider this process as a photochemical *hydrogenation* rather than a *decomposition* of this compound (*cf.* Scheme 7.I).

If water does not participate directly in the primary process, the photochemical reduction of carbon dioxide must occur at the cost of an intermediate hydrogen donor (designated by HX in Scheme 7.I).

It has often been assumed that the reduction of carbon dioxide must of necessity involve several successive photochemical steps, *e. g.*:

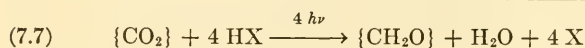
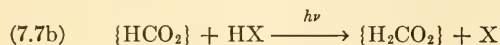
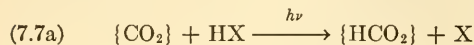

The first and third stage lead to "odd" molecules (that is, free radicals), while the second one produces an intermediate of the reduction level of formic acid.

In equations (7.7) we postulated *four different primary photochemical reactions*, and this may be considered as a setback compared with van Niel's theory. However, the assumption of a single primary process is possible in van Niel's theory only through combination of this primary process with the catalytic dismutation of the primary oxidation product, {OH}, by reactions (7.4). A similar scheme, with a single primary photochemical reaction, also can be substituted for (7.7), with the only difference that, because of the participation of *four* hydrogen atoms in the reduction of *one* molecule of carbon dioxide, *two* successive dismutations are required to complete the reaction. In the first one, two radicals, {HCO₂}, dismutate into two "even" molecules, {CO₂} and {H₂CO₂}, while in the second one, two molecules, {H₂CO₂}, dismutate into {CO₂} and {H₄CO₂}:

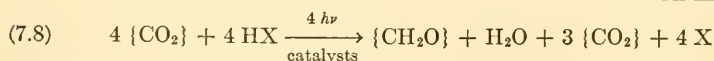
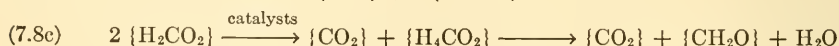
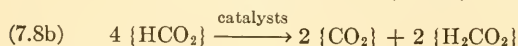
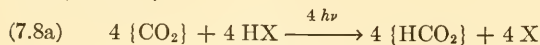

If (7.8a) is considered to be the only photochemical reaction in photosynthesis, the process must be completed by a nonphotochemical oxidation of water by the oxidized intermediate X, possibly involving the intermediate catalysts Y and Z (*cf.* Scheme 7.I):

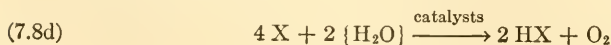

so that the over-all reaction becomes:

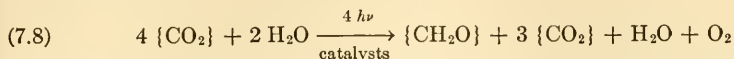

The reaction mechanism (7.8) is represented graphically in scheme 7.III.

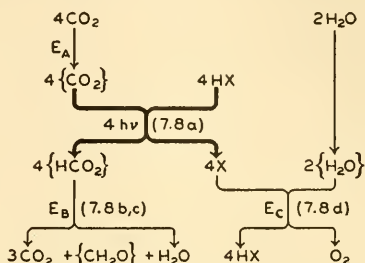

Scheme 7.III.—Photosynthesis, with reduction of carbon dioxide (in the form of a compound $\{CO_2\}$) by an intermediate catalyst as the primary photochemical process (second four quanta theory).

If $\{CO_2\}$ is a carboxylic acid (*cf.* Chapter 8), reaction (7.8c) is analogous to the “Cannizzaro reaction” (4.22b). As an analogy to (7.8b), we may mention the dismutation of semiquinones into quinones and hydroquinones. For example, the reduction of thionine by ferrous ions in light—a reaction whose first step was described on page 000 as similar to the primary process in photosynthesis—runs to completion by the dismutation of the primary reduction product (semithionine) into thionine and leucothionine:

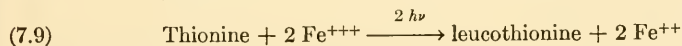
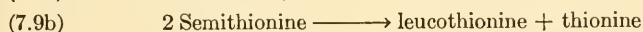
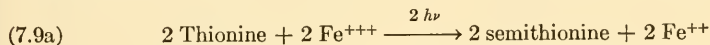

In van Niel's mechanism (7.6), *four water molecules* participate in the primary reaction, and three of them are recovered; in mechanism (7.8), *four carbon dioxide molecules* participate in the primary reaction, and three of them are restored at the end.

The dismutation of the radicals, $\{HCO_2\}$, can take place either directly, as assumed in (7.8b), or through the intermediate formation of “biradicals,” $\{HCO_2\}_2$, analogous to the peroxides $\{OH\}_2$, postulated in (7.4a,b).

4. Hydrogen Exchange Between Intermediates as the Primary Process

THIRD FOUR QUANTA THEORY

In the absence of decisive arguments in favor of a direct association of the primary photochemical process with either carbon dioxide or

water, it may be useful to write down also a less specific scheme, in which both the reduction of carbon dioxide *and* the oxidation of water are assigned to secondary catalytic reactions, and the primary photochemical process is thought of as an oxidation-reduction reaction between two intermediates, *e. g.*, X and Z in scheme 7.I:

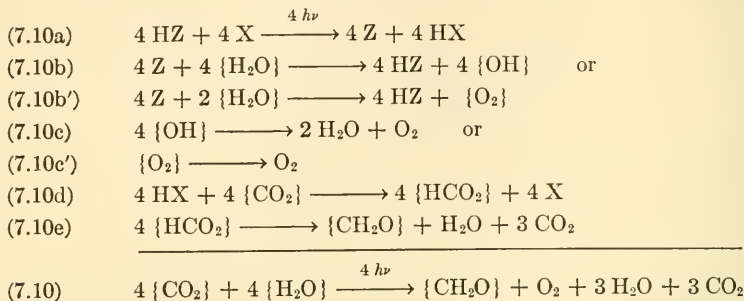

Reaction system (7.10) is represented graphically in scheme 7.IV. It also was used, because of its unspecific character, in the construction of schemes 6.I and 6.III in the preceding chapter.

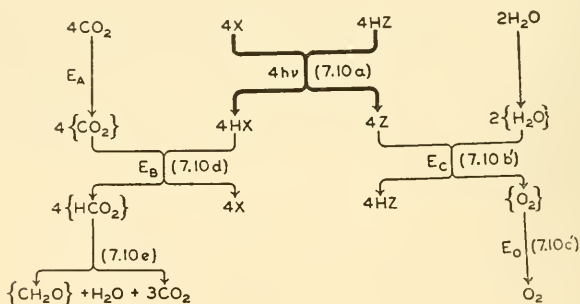

Scheme 7.IV.—Photosynthesis, with an oxidation-reduction reaction between two intermediate catalysts as the primary photochemical process (third four quanta theory).

5. Two Different Primary Four Quanta Processes

FIRST EIGHT QUANTA THEORY

Schemes 7.II, 7.III, and 7.IV have in common the assumption of *four* identical photochemical reactions for each reduced molecule of carbon dioxide. But after a controversy which lasted for several years (Vol. II, Chapter 29) it now seems probable that the maximum quantum yield of photosynthesis is not 1/4, but 1/8 (perhaps even 1/10 or 1/12), that is, that at least eight quanta must be absorbed for each reduced molecule of carbon dioxide. This larger number of available quanta is welcome, because the energy contained in four quanta of red light (about 160 kcal

per einstein) is scarcely sufficient to cover the net requirements of photosynthesis (112 kcal per mole) and leave a sufficient margin for losses involved in the stabilization of unstable intermediates (*cf.* Wohl 1935).

If we assume, as a working hypothesis, that *eight* quanta are actually utilized in photosynthesis (while quanta absorbed above this number are lost by energy dissipation), we may ask how *eight* primary photochemical processes can be utilized for the transfer of *four* hydrogen atoms. The obvious answer is that each hydrogen atom can be activated *twice*, thus enhancing its reducing power.

This result can be achieved in two ways. One is to activate the same four hydrogen atoms *photochemically* twice in succession, *e. g.*, to combine two of the different four quanta processes discussed in the preceding sections. The other solution is to double the number of identical primary photochemical processes, *e. g.*, (7.2), (7.8a) or (7.10a), and to allow four of the primary products to recombine, transferring their recombination energy to the remaining four intermediates. This kind of secondary reactions can be designated as "energy dismutations," because of their analogy to chemical dismutations repeatedly mentioned in this chapter.

We will begin by exploring the first alternative, that is, by discussing hypotheses which postulate *two* sets of different primary photochemical reactions. We may designate one set—in which hydrogen atoms are taken away from water (or from an intermediate donor), as *photooxidations*, and those of the second set—in which the same hydrogen atoms are transferred to carbon dioxide (or an intermediate acceptor), as *photo-reductions* (using this term in a sense different from that assigned to it by Gaffron, *cf.* Chapter 6).

The hypothesis of two primary processes has often been associated with the assumption that the intermediate hydrogen acceptor is *chlorophyll*, and that this pigment is capable of taking hydrogen atoms away from water (or another donor), with the help of light, and transferring them to carbon dioxide (or another acceptor), also with the help of light.

As announced before, we will postpone the question of the role of chlorophyll in photosynthesis until chapter 19, and use in the following schemes the symbols X or Z where the original papers may have used Chl (= chlorophyll). However, we will retain the assumption that the same catalyst whose oxidized form participates in the photooxidation of water also participates, in the reduced form, in the photoreduction of carbon dioxide. (A less specific assumption would be to consider the photooxidation and photoreduction as separated by an unknown number of intermediate oxidation-reduction catalysts.) In other words, we assume that only one of the intermediate catalysts in scheme 7.I, either X, Y, or Z, is a "photocatalyst." We begin with the second alter-

native (Y as a photocatalyst), since it removes both carbon dioxide and water from the direct participation in the primary photochemical process, and can thus be considered as the least specific of all. The resulting system of reactions, (7.11), represented in scheme 7.V, is a logical generalization of system (7.10) and scheme 7.IV.

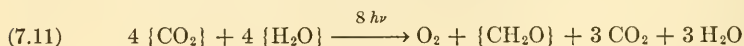
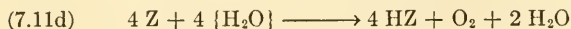
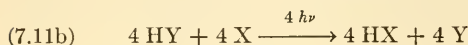
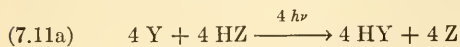

Another scheme of the same type was suggested by Franck and Herzfeld (1941) to replace the older "four quanta theories" of Franck

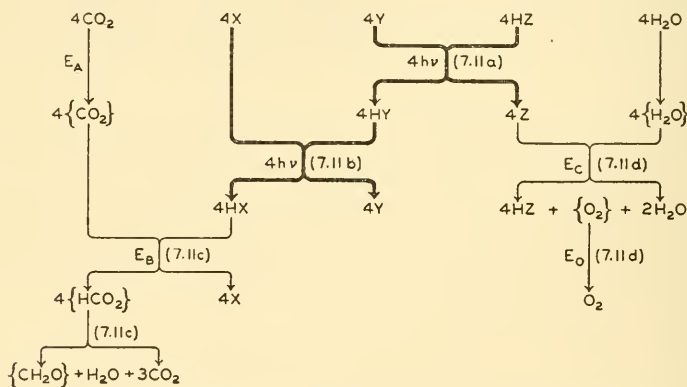

Scheme 7.V.—Photosynthesis, with oxidation-reduction reactions between three intermediary catalysts as the two primary photochemical processes. (The central catalyst, which participates in both photochemical reactions, may be chlorophyll.) (First eight quanta theory.)

(1935) and Franck and Herzfeld (1937). In this scheme, the "photocatalyst" was identified with X in scheme 7.I, that is, it was assumed to react directly with the carbon dioxide-acceptor complex in the "photoreduction," and to be restored by an intermediate hydrogen donor in the "photooxidation." Two additional specific assumptions were made by Franck and Herzfeld. In the first place, they assumed that the reduced photocatalyst, HX, hydrogenates not only the complex, $\{CO_2\}$, but also its three reduction intermediates, $\{HCO_2\}$, $\{H_2CO_2\}$, and $\{H_3CO_2\}$ —in other words, they assumed four different photoreduction processes (cf. 7.7a, b, c, and d), and combined them with four identical primary

photooxidation processes of the type (7.10a). In the second place, they postulated that the intermediary catalyst, HZ, which reduces X to HX, is an organic hydroxyl compound, ROH. Upon its dehydrogenation to a radical, RO, this catalyst was assumed to oxidize water, forming an organic hydroperoxide, ROOH, which finally dismutates, restoring ROH and liberating oxygen. This special mechanism of catalytic water oxidation will be compared with the mechanism (7.4) in chapter 11 (page 189). The hypothesis of Franck and Herzfeld is represented by the formulae (7.12) and the reaction scheme 7.VA.

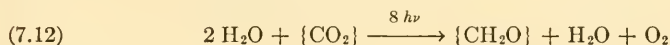
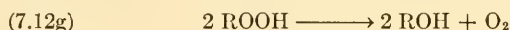
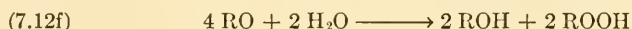
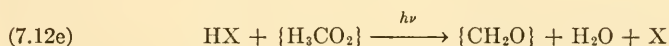
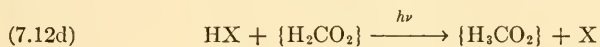
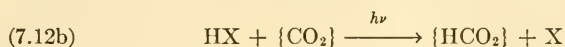

A characteristic assumption in scheme 7.VA is that all intermediary products (designated by asterisks) are stabilized by one and the same catalyst (E_B), to protect them from back reactions. The assumption of a common effect of a catalyst on four different intermediates on the "reduction side" of the primary photochemical process, and on one intermediate "on the oxidation side" is not very plausible. The number of different photochemical products requiring catalytic stabilization could be reduced from five to two by combining (7.10a) with (7.8), instead of with (7.7), thus arriving at a scheme similar to 7.V except for the elimination of the intermediate oxidation-reduction system HY-Y—a change which makes $\{CO_2\}$ a direct participant in the primary photochemical process:

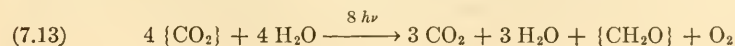
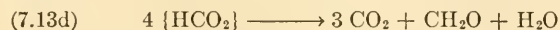
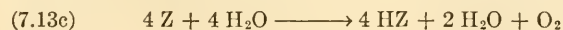
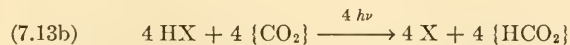
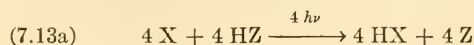

6. Dismutation of Energy as an Alternative to a Second Primary Process

SECOND EIGHT QUANTA THEORY

As stated on page 154, an alternative to two sets of different photochemical reactions is a single set of eight identical primary reactions,

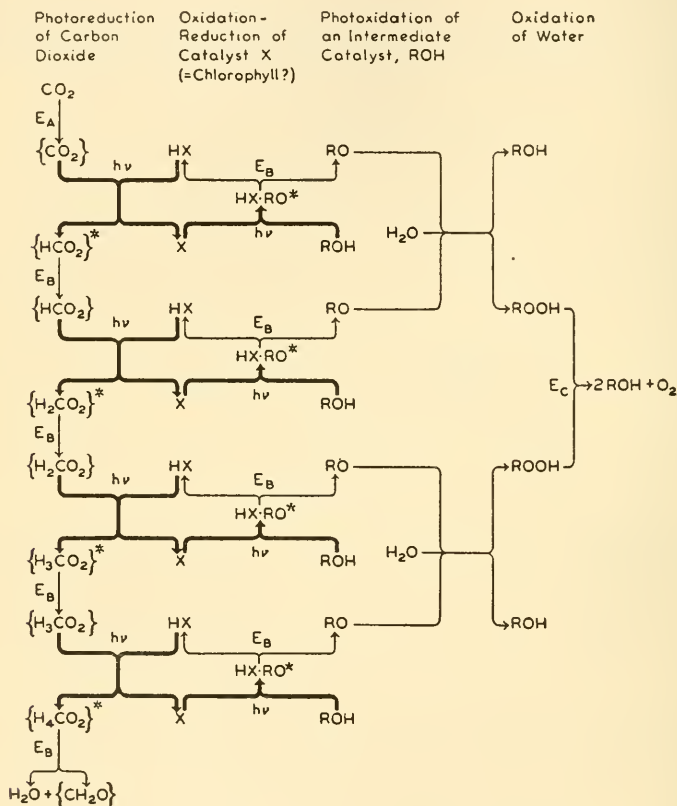

Scheme 7.VA.—Photosynthesis according to Franck and Herzfeld. This is a variation of scheme 7.V, with the carbon dioxide complex $\{\text{CO}_2\}$ and its reduction intermediates substituted for the intermediate oxidant. The intermediate reductant is designated as ROH (instead of Z). The central catalyst X (which corresponds to Y in scheme 7.V) may be chlorophyll.

coupled with secondary processes by which the energy contained in *eight* primary intermediate products is transferred to *four* secondary intermediates. As an example, we assume that the primary reactions are all of the type (7.10a). This assumption leads to the following mechanism:

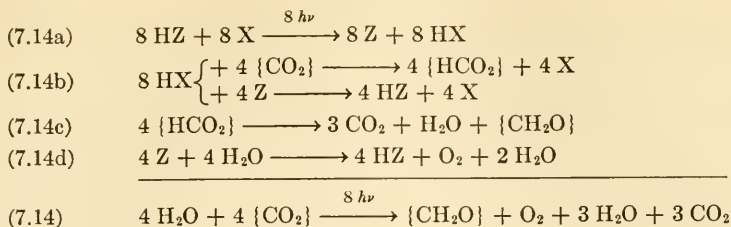

This mechanism is represented in scheme 7.VI. Its essential part is the "energy dismutation" by the coupled reaction (7.14b), in which the reoxidation of four reduction intermediates HX by four oxidation intermediates Z is supposed to assist four other molecules HX in reducing carbon dioxide.

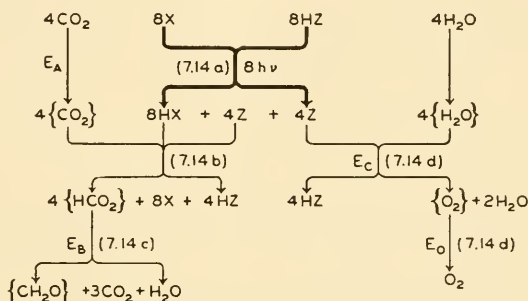

Scheme 7.VI.—Photosynthesis according to the concept of energy dismutation (second eight quanta scheme). Primary photochemical process is an oxidation-reduction reaction between eight molecules of an intermediate catalyst X and eight molecules of another catalyst Z (one of them may be chlorophyll). The reduction of carbon dioxide is coupled with the recombination of one-half of the primary photochemical products.

A similar scheme can be devised also by assuming an "energy dismutation" on the "oxidation side" of the primary photochemical process, that is, by postulating that the recombination of four pairs of primary products gives four other primary oxidation products the power to oxidize water according to reaction (7.14d).

Simple energy dismutations are well known in physics. The descent of one weight in a clock lifts the other weight to twice its original height, doubling its potential energy. When two excited mercury atoms collide, the result is often the excitation of one of them to twice its original energy level, and the return of the other into the ground state (*cf.* Beutler and Rabinowitch 1930).

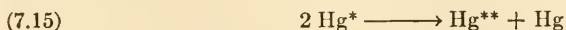

Chemical reactions involving "energy dismutations" undoubtedly occur in chemosynthesizing bacteria, in which the oxidation of several

molecules of a comparatively mild reductant is utilized for the production of one molecule (or radical) able to react with carbon dioxide. This analogy with chemosynthesis is the main reason for the introduction of the concept of "energy dismutation" into the discussion of the mechanism of photosynthesis. This concept enables one to postulate only one kind of primary photochemical processes even if the number of these processes is much larger than the number of elementary oxidation-reduction acts (hydrogen transfers or electron transfers) required for the completion of the overall reaction.

A possible mechanism of "energy dismutation" in photosynthesis and chemosynthesis will be discussed in chapter 9, and the results presented in schemes 9.III and 9.IV. The assumption on which these schemes are based is that, after a compound, RH_2 , has been first oxidized by a *strong* oxidant (oxygen, for example) to a radical, RH , the latter may be able to yield its remaining hydrogen atom to a much weaker second oxidant (carbon dioxide, for example).

7. Comparison of Different Primary Processes

Comparing critically the various schemes of photosynthesis presented in this chapter, we can discard the four quantum schemes as contradicting recent quantum yield determinations, as well as straining dangerously the thermochemical possibilities. As between the alternative eight quanta theories, no final decision is possible at present. Two questions remain to be decided: Is the assumption of *eight identical photochemical processes* (as in 7.14) more probable than that of two different kinds of primary processes (as in 7.11 or 7.13) or of five such processes (as in 7.12)? Does carbon dioxide or water (or both or neither) participate (directly or as complexes) in the primary photochemical process?

Although the hypothesis of two sets of primary photochemical processes—photooxidations and photoreductions—does not *require* the direct chemical participation of chlorophyll in both of them, an experimental proof of the existence of two interconvertible colored forms of chlorophyll belonging to different reduction levels and capable of using light energy for photooxidations and photoreductions, respectively, would strengthen this hypothesis almost to the point of certainty. We shall see, in chapter 18, that experiments with extracted chlorophyll make the existence of two such chlorophyll modifications plausible but do not prove it. The main argument in favor of the alternative theory of eight *identical* photochemical reactions (beside the greater simplicity of this scheme) is the analogy which it enables to establish between the mechanisms of photosynthesis and chemosynthesis. This appeals to our desire for a unified conception of all forms of organic synthesis, and receives support from the discovery of Gaffron that photochemical and non-

photochemical reduction of carbon dioxide can occur in the same organisms (anaerobically-adapted *Scenedesmus* and similar green algae).

As to the second question, that of the direct participation of the reaction components in the primary photochemical process, the non-photochemical reduction of carbon dioxide in autotrophic bacteria and hydrogen-adapted algae constitutes a strong, even if indirect, argument against the association of carbon dioxide with the photochemical reaction proper. One is tempted to attribute photosynthesis and chemosynthesis to a reaction of carbon dioxide with the same reducing agents, formed in one case by a photochemical reaction and in the other case by the catalytic oxidation of hydrogen, hydrogen sulfide, or another inorganic or organic reductant.

Against this argument, one must weigh several observations which speak in favor of a closer association of carbon dioxide with the photochemical apparatus, and which caused Franck and Herzfeld to assume such an association in their scheme 7.VA.

One such observation is the *light-induced liberation of carbon dioxide*, which occurs occasionally (*cf.* Emerson and Lewis, page 207) during the induction period of photosynthesis, and which may be attributed to a *photochemical decomposition of the complex*, $\{\text{CO}_2\}$, into acceptor and free carbon dioxide. However, Franck (1942), in a discussion of this "CO₂ gush," decided that it is caused, not by a *direct* photochemical interaction between $\{\text{CO}_2\}$ and excited chlorophyll, but by back reactions of the first intermediate ($\{\text{HCO}_2\}$ in scheme 7.VA), in which so much energy is released that the regenerated complex, $\{\text{CO}_2\}$, dissociates immediately into free acceptor and carbon dioxide. This mechanism does not require that $\{\text{HCO}_2\}$ be formed by a direct photochemical interaction of $\{\text{CO}_2\}$ with chlorophyll, but can equally well be fitted into a scheme in which the complex $\{\text{CO}_2\}$ is reduced by an intermediate reductant.

A second argument in support of a photochemical interaction between chlorophyll and carbon dioxide is the *relationship between the photosynthesis and chlorophyll fluorescence in vivo*. This phenomenon will be discussed in detail in volume II, chapters 24 and 32. The essential point is that the yield of fluorescence sometimes increases at high light intensities and that, according to Franck, French, and Puck (1941), this occurs whenever the stationary concentration of the complexes, $\{\text{CO}_2\}$, is depleted. The simplest explanation of the quenching effect, which the complex $\{\text{CO}_2\}$ apparently exercises on chlorophyll fluorescence, is the assumption of a *direct photochemical interaction of this complex with excited chlorophyll molecules*.

However, in this case, too, an *indirect* interaction may suffice to produce the observed results. For example, if chlorophyll reacts photochemically with an intermediate oxidant X, and the reduced intermediate

HX is reoxidized by reaction with the complex, $\{CO_2\}$, an exhaustion of $\{CO_2\}$ may lead to an accumulation of reduced intermediates, HX, and exhaustion of the quenching species, X.

On the basis of all these considerations, without pretending to be able to give a final answer to the problem of the primary photochemical process in photosynthesis, it seems that eight primary processes of the type assumed in scheme 7.VI, perhaps, with chlorophyll identified with the reductant, HZ (*cf.* Chapter 19, page 552), provides the best working hypothesis.

Scheme 7.V, which contains two sets of different primary processes but leaves open the possibility of the same intermediate reductants occurring in photosynthesis and chemosynthesis, is our second choice, and would become the first one if the existence of two interconvertible green modifications of chlorophyll—one a photo-oxidant and one a photoreductant—would be definitely confirmed by experiments *in vitro*.

8. The Primary Process in Bacteria and Adapted Algae

In hydrogen-adapted algae and in bacteria, molecular hydrogen, hydrogen sulfide, or other inorganic or organic hydrogen donors replace water in the role of the ultimate reductant in photosynthesis. Does this substitution mean a change in the primary photochemical process, or merely a different course of secondary catalytic reactions?

Nakamura (1938), van Niel (1941), Franck and Gaffron (1941), and Gaffron (1942) all suggested, for different reasons, that the substitute reductants do not participate in the primary photochemical process. One of van Niel's arguments was the observation (*cf.* page 110) that organic reductants are used up by *Spirillum rubrum* at the same rate in the dark and in light. This indicates a preliminary enzymatic transformation of these reductants, *e. g.*, hydrogen transfer to the hydrogenase system (*cf.* Chapter 6, Eq. 6.6b), which they have to undergo both in respiration and in photoreduction.

Since van Niel and Gaffron considered the oxidation of water as one (or even the only) primary photochemical reaction in ordinary photosynthesis (as in Scheme 7.II), the assumption that substitute reductants do not participate in the photochemical process led them to the logical conclusion that, in bacterial photoreduction too, the primary photochemical process is the oxidation of water. The fact that purple bacteria do not evolve oxygen in light could then be explained in two ways. One hypothesis, suggested by Gaffron, was that the intermediate product of water oxidation, $\{OH\}$, can only be reduced in bacteria by substitute reductants—hydrogen, hydrogen sulfide, etc.—(and not by water), because these organisms contain an active hydrogenase system, but *not* the oxygen-liberating enzyme, E_o . The other hypothesis, proposed by

van Niel, was that the primary product obtained by the oxidation of water in bacteria, $\{\text{OH}\}^{\text{B}}$, is somewhat different from that formed in green plants, $\{\text{OH}\}^{\text{A}}$, and therefore incapable of conversion into oxygen. For example, the energy content of $\{\text{OH}\}^{\text{B}}$ could be insufficient for this conversion, perhaps because this product is formed with the help of infrared quanta, supplied by bacteriochlorophyll, which are about 30% smaller than the red quanta made available by ordinary chlorophyll. The difference between $\{\text{OH}\}^{\text{A}}$ and $\{\text{OH}\}^{\text{B}}$ may be in the nature of the acceptor (symbolized by brackets), the simplest hypothesis being that this acceptor is the sensitizing pigment itself, that is, chlorophyll in green plants and bacteriochlorophyll in purple bacteria.

If we accept van Niel's hypothesis, we must conclude that the mechanism of photoreduction is somewhat different in hydrogen-adapted algae and in purple bacteria. The former contain ordinary chlorophyll, apparently unaffected by the adaptation process; the primary oxidation product of water, $\{\text{OH}\}^{\text{A}}$, is thus probably the same in the ordinary and in the adapted state, and the difference in the final stages of oxidation must be attributed to the activation of the hydrogenase system and the simultaneous inactivation of the oxygen-liberating enzyme, E_0 , as suggested by Gaffron (*cf.* Chapter 6, page 134). The identity of the primary processes in adapted and ordinary green algae is supported by the observations of Rieke and Gaffron (1943) that the maximum quantum yield and the saturation rate in flashing light are the same in the photoreduction by adapted algae as in the photosynthesis in the nonadapted state. In the case of purple bacteria, on the other hand, the primary oxidation product, $\{\text{OH}\}^{\text{B}}$, is naturally incapable of conversion into free oxygen; therefore, aerobic conditions may cause only a complete cessation of synthesis (if they lead to an oxidative deactivation of the hydrogenase) but cannot cause a transition to ordinary photosynthesis (with water as reductant), as this occurs in the "de-adaptation" of green algae.

However, an even simpler description of the same facts becomes possible if one assumes, as we have done above, that the primary photochemical process is the oxidation of an intermediate reductant, HZ , and that, in the course of normal photosynthesis, the oxidation product, Z , recovers hydrogen from water by a nonphotochemical reaction. In adapted algae, this recovery is blocked, and a reaction with a substitute reductant (*e. g.*, H_2) is made possible by a characteristic transformation of the enzymatic system (activation of the hydrogenase, deactivation of the deoxidase). This was the mechanism assumed in schemes 6.I and 6.III. In purple bacteria, on the other hand, the primary reductant, HZ^{B} , is different from the corresponding compound in green plants, HZ^{A} , and its oxidation product, Z^{B} , is incapable of oxidizing water, but capable

of oxidizing the less stable "substitute reductants" (H_2 , H_2S , $\text{S}_2\text{O}_3^{--}$, etc.). (Again, the simplest explanation of the difference between Z^A and Z^B is their identification with chlorophyll and bacteriochlorophyll respectively.)

It may further be asked whether the primary oxidation product Z^B is the same in all purple bacteria, or whether it may further depend on the specific nature of the reductant (H_2S , or $\text{S}_2\text{O}_3^{--}$, or H_2 , etc.). Was-sink, Katz, and Dörrestein (1939) noticed that, in the spectra of living purple bacteria, the single absorption band of free bacteriochlorophyll in the far red is replaced by several red and infrared bands whose pattern varies from species to species (Vol. II, Chapter 22), and suggested that each of these bands corresponds to a different bacteriochlorophyll-bearing complex adapted to the reduction of a specific hydrogen donor. However, this hypothesis disagrees with the assumption, made in chapter 6, that the hydrogenase system, even if it acquires hydrogen from different donors by means of specific "oxidoreductases," transfers it to a common acceptor (designated by A_H in Chapter 6). This seems to leave no place for a specific photocatalyst *between* A_H and carbon dioxide.

Bibliography to Chapter 7

The Primary Photochemical Process

- 1914 Bredig, G., *Umschau*, **18**, 362.
- 1916 Hoffmann, K. A., and Schumpelt, K., *Ber. deut. chem. Ges.*, **49**, 303.
- 1918 Wislicenus, C., *ibid.*, **51**, 942.
- 1923 Thunberg, K., *Z. physik. Chem.*, **106**, 305.
Weigert, F., *ibid.*, **106**, 313.
- 1924 Weigert, F., *ibid.*, **109**, 79.
- 1930 Wurmser, R., *Oxidations et réductions*. Presses universitaires de France, Paris, 1930.
Beutler, H., and Rabinowitch, E., *Z. physik. Chem.*, **B6**, 233.
- 1931 van Niel, C. B., and Muller, F. M., *Rec. trav. botan. néerland.*, **28**, 245.
van Niel, C. B., *Arch. Mikrobiol.*, **3**, 1.
- 1932 Stoll, A., *Naturwissenschaften*, **20**, 955.
Kautsky, H., *Ber. deut. chem. Ges.*, **65**, 1762.
- 1933 Muller, F. M., *Arch. Mikrobiol.*, **4**, 131.
Muller, F. M., *Chem. Weekblad*, **30**, 1.
Shibata, K., and Yakushiji, E., *Naturwissenschaften*, **21**, 267.
- 1934 Dhar, N. R., *Trans. Faraday Soc.*, **30**, 142.
- 1935 van Niel, C. B., *Cold Spring Harbor Symposia Quant. Biol.*, **3**, 138.
Franck, J., *Naturwissenschaften*, **23**, 226.
Franck, J., *Chem. Revs.*, **17**, 433.
Wohl, K., *Z. physik. Chem.*, **B31**, 152.
- 1936 Stoll, A., *Naturwissenschaften*, **24**, 53.

- 1938 Nakamura, H., *Acta Phytchim. Japan*, **10**, 271.
- 1939 Wassink, E. C., Katz, E., and Dörrestein, R., *Enzymologia*, **7**, 113.
- 1941 Franck, J., French, C. S., and Puck, T. T., *J. Phys. Chem.*, **45**, 1268.
Franck, J., and Gaffron, H., in *Advances in Enzymology*, Vol. 1. Interscience, New York, 1941, p. 199.
Franck, J., and Herzfeld, K. F., *J. Phys. Chem.*, **45**, 978.
van Niel, C. B., in *Advances in Enzymology*, Vol. 1. Interscience, New York, 1941, p. 263.
- Seybold, A., *Botan. Arch.*, **42**, 254.
- 1942 Gaffron, H., *J. Gen. Physiol.*, **26**, 195.
Gaffron, H., *ibid.*, **26**, 241.
Gaffron, H., and Rubin, J., *ibid.*, **26**, 218.
Franck, J., *Am. J. Botany*, **29**, 314.
- 1943 Ruben, S., *J. Am. Chem. Soc.*, **65**, 279.
Rieke, F. F., and Gaffron, H., *J. Phys. Chem.*, **47**, 299.
Kautsky, H., and Franck, U., *Biochem. Z.*, **315**, 207.
- 1944 Emerson, R. L., Stauffer, J. F., and Umbreit, W. W., *Am. J. Botany*, **31**, 107.

CHAPTER 8

NONPHOTOCHEMICAL PARTIAL PROCESS IN PHOTOSYNTHESIS

I. FIXATION OF CARBON DIOXIDE

In the reaction schemes developed in chapter 7, the primary photochemical process was coupled with several nonphotochemical reactions. Since these reactions proceed at low temperatures, they probably require catalysts. Some of these undoubtedly are true enzymes, while others may be comparatively simple organic, or even inorganic, compounds.

The realization that photosynthesis includes nonphotochemical reaction steps first came from kinetic studies. About 1905, Blackman had established that, under certain conditions, photosynthesis cannot be accelerated by further increase in light intensity, or carbon dioxide supply, but only by a raise in temperature; Willstätter and Stoll (1918) and Warburg (1919) interpreted this as evidence that photosynthesis includes a non-photochemical process (which they called "Blackman reaction") whose maximum rate is limited by the available quantity of an enzyme (Vol. II, Chapter 28). Willstätter and Stoll suggested, more specifically, that the Blackman reaction may be the liberation of oxygen from peroxides. Warburg thought at first that the Blackman reaction consists in a transformation of carbon dioxide preliminary to its participation in the photochemical reaction, but later agreed with the Willstätter-Stoll hypothesis because of the similarity which he found between the effects of poisons on photosynthesis and on catalase activity (*cf.* page 284). The assumption, which appeared natural at that time, of a single "Blackman reaction" later led to various difficulties. Suggestions that there may be several "Blackman reactions" were made repeatedly, but without much conviction, until Franck postulated, on the basis of an analysis of various kinetic data, that photosynthesis must include (at least) *three* different catalytic reactions. In addition to the preliminary transformation of carbon dioxide (first postulated by Warburg), and the peroxide decomposition (first suggested by Willstätter and Stoll), Franck assumed a third catalytic reaction, the stabilization of the primary photochemical products, which prevents their destruction by back reactions. He made no suggestion as to the chemical nature of this reaction, but our discussions in chapter 7, would indicate that it may possibly be a *dismutation*,

which converts free radicals into saturated molecules. Franck designated the catalysts involved in these three reactions as "catalyst A" (probably a "carboxylase"), "catalyst B" (the "stabilizing" catalyst, perhaps a "mutase") and "catalyst C" (possibly a "catalase"); we have designated them, in chapters 6 and 7, as E_A , E_B and E_C , respectively. These three catalysts are only a minimum; and the actual number of nonphotochemical reactions in photosynthesis may be larger than three. The *evolution of oxygen*, for example, may require *two* successive catalytic reactions (*cf.* Schemes 6.I, etc.), while the *reduction and polymerization of the carbon dioxide-acceptor complex*, $\{CO_2\}$, to glucose, probably involves a whole series of oxidoreductions, dismutations, and polymerizations, requiring a complex catalytic system of which Franck's "catalyst B" may be only the first component.

This and the next four chapters will deal with these catalytic processes. We begin with the primary carbon dioxide fixation, represented in chapter 7 by the formula: $CO_2 \longrightarrow \{CO_2\}$.

Evidence pertaining to the nature of the carbon dioxide-acceptor complex in photosynthesis includes kinetic observations, experiments on carbon dioxide absorption by plants in the dark, carbon dioxide fixation by bacteria and other heterotrophic organisms, and the binding of carbon dioxide by different absorbers *in vitro*.

A. THE CARBON DIOXIDE FIXATION *in vitro* *

1. The Carbon Dioxide-Water Equilibrium

The primary absorber of carbon dioxide in all organisms is *water*, which forms 70-80% of the average tissue. The absorption of carbon dioxide by water is partly physical solution, partly chemical hydration, determined by the constants of the following equilibria:

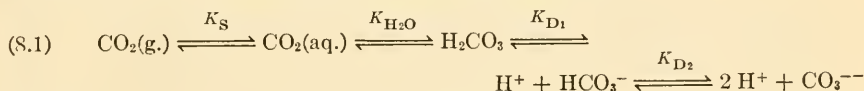

The indices refer to solubility (S), hydration (H_2O), first ionic dissociation (D_1), and second ionic dissociation (D_2). The equilibrium may be further affected by cations whose carbonates have a small solubility product, for example, Ca^{++} or Mg^{++} .

At a given pH and temperature, the equilibrium concentrations of all molecular species of carbonic acid (CO_2 , H_2CO_3 , HCO_3^- , and CO_3^{--}) are determined by that of any one of them, and thus indirectly by the partial pressure of carbon dioxide in the atmosphere, or by the presence of a solid carbonate. If the pH is allowed to adjust itself, *two* parameters can be chosen, *e. g.*, the concentrations $[CO_3^{--}]$ and $[HCO_3^-]$.

The solubility constant α' (the so-called Ostwald's distribution coefficient) of

* Bibliography, page 209.

carbon dioxide is not identical with K_S in (8.1), because in its determination all the molecular species in solution are lumped together as "dissolved carbon dioxide." However, α' is not appreciably different from K_S in acid solutions ($pH \leq 4.5$), where the concentrations $[HCO_3^-]$ and $[CO_3^{--}]$ are negligible (*cf.* Table 8.III).

Table 8.I shows the solubility of carbon dioxide in water at different temperatures. In addition to Ostwald's distribution coefficients, α' , the table contains the Bunsen solubility coefficients, α —the volumes of gas, reduced to 0° C., dissolved in unit volume of water at t° C. The relation between the two constants is: $\alpha = \alpha' (1 + 0.00367 t)$.

TABLE 8.I
CARBON DIOXIDE SOLUBILITY IN WATER (BOHR 1899)

t° C.	α	α'	ΔF_{S_2} , kcal/mole
0	1.713	1.71	-0.291
5	1.424	1.45	-0.205
10	1.194	1.24	-0.121
15	1.019	1.08	-0.043
20	0.878	0.94	+0.036
25	0.759	0.83	+0.110
30	0.665	0.74	+0.181
35	0.592	0.67	+0.245
40	0.530	0.61	+0.308

$$\Delta H_S = -4.2 \text{ kcal/mole (25}^\circ \text{C.)}$$

Using the values $K_S = 0.827$, D_{H_2O} (dissociation constant of water) = 1.04×10^{-14} and $K_{D_1} = 4.54 \times 10^{-7}$ for the calculation of $[H^+]$ and $[HCO_3^-]$, and neglecting the species H_2CO_3 and CO_3^{--} because of the small values of the constants K_{H_2O} and K_{D_2} (see below), one obtains the compositions of carbon dioxide solutions (at 25° C.) given in table 8.II.

TABLE 8.II

DISTRIBUTION OF CARBON DIOXIDE BETWEEN AIR AND DISTILLED WATER AT 25° C.
(calculated with $K_S = 0.827$ and $K_{D_1} = 4.54 \times 10^{-7}$)

p_{CO_2} atm.	[CO ₂], mole/liter		[HCO ₃ ⁻], mole/l.	[H ⁺] ^b pH
	Gas ^a	Solution		
10 ⁻⁵	4.07×10^{-7}	3.37×10^{-7}	3.78×10^{-7}	6.42
10 ⁻⁴	4.07×10^{-6}	3.37×10^{-6}	1.24×10^{-6}	5.91
^c 3.1 × 10 ⁻⁴	1.26×10^{-5}	0.94×10^{-5}	2.07×10^{-6}	5.68
10 ⁻³	4.07×10^{-5}	3.37×10^{-5}	3.92×10^{-6}	5.41
10 ⁻²	4.07×10^{-4}	3.37×10^{-4}	1.24×10^{-5}	4.91
10 ⁻¹	4.07×10^{-3}	3.37×10^{-3}	3.92×10^{-4}	4.41
1	4.07×10^{-2}	3.37×10^{-2}	1.24×10^{-3}	3.91

^a Assuming ideal gas laws.

^b *Cf.* Quinn and Jones (1936), p. 119.

^c Normal carbon dioxide content of free atmosphere.

The table shows that, in very dilute carbon dioxide solutions, the concentration of bicarbonate ions is close to that of carbon dioxide molecules; in distilled water equilibrated with the atmosphere the ratio $[\text{CO}_2] : [\text{HCO}_3^-]$ is approximately 5 : 1.

The constant of the *hydration equilibrium*:

$$(8.2) \quad K_{\text{H}_2\text{O}} = [\text{H}_2\text{CO}_3]/[\text{CO}_2]$$

is not known precisely, but can be calculated approximately from the rate constants of hydration (k_{H}) and dehydration (k'_{H}):

$$(8.3) \quad K_{\text{H}_2\text{O}} = k_{\text{H}}/k'_{\text{H}}$$

McBain noticed, in 1912, that the hydration of carbon dioxide is a comparatively slow process. Thiel and Strohecker (1914) and Strohecker (1916) measured its rate in the alkaline region. More recently, Faurholt (1924), Stadie and O'Brien (1933), and Brinkman, Margaria and Roughton (1933) determined k_{H} and k'_{H} over a wide range of hydrogen-ion concentrations.

TABLE 8.III
HYDRATION AND DEHYDRATION OF CARBON DIOXIDE^a

$t^\circ \text{C.}$	$k'_{\text{H}},$ sec^{-1}	$k_{\text{H}},$ sec^{-1}	$K_{\text{H}_2\text{O}}$	ΔH of hydration, kcal/mole
0°	2.67 (F) ^b	0.0030 (F) ^b	0.0012	2.80 (R)
	1.70 (BMR) ^b	0.0026 (BMR) ^b	0.0015	
	1.4 (SO) ^b	0.0027 (SO) ^b		
		0.0027 (MU) ^b		
		0.0021 (RB)		
		0.0021 (MU)		
18°	16.4 (F) ^b	0.025 (F) ^b	0.0016	1.40 (R)
	11.1 (BNR) ^b	0.024 (BMR) ^b	0.0022	
	14 (R) ^b			
25°		0.0275 (MU)		
27°	31 (R) ^b			1.05 (R)
37°	77 (R) ^b			0.38 (R)
38°		0.23 (F) ^b		
		0.26 (BMR) ^b		
		0.10 (MU)		

^a F—Faurholt (1924); BMR—Brinkman, Margaria and Roughton (1933); SO—Stadie and O'Brien (1933); RB—Roughton and Booth (1938); R—Roughton (1940); MU—Mills and Urey (1940).

^b Buffered solutions!

The hydration occurs, in addition to the reaction:

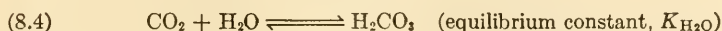

also through the bicarbonate ion:

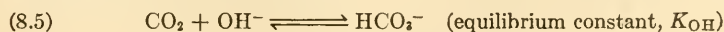

Reactions (8.4) and (8.5) can be interpreted as additions of HOH and OH⁻ respectively to a C=O double bond in CO₂.

According to Olsen and Joule (1940), the activation energy of reaction (8.4) is 19 kcal, and that of reaction (8.5) between 10 and 13 kcal.

In the pH range of 8–10, the rates of the two reactions (8.4) and (8.5), are of the same order of magnitude. At pH > 8, the pH-independent reaction (8.4) predominates, while at pH > 10, hydration and dehydration occur practically exclusively by reaction (8.5). At pH > 8, and 18° C., a dissolved carbon dioxide molecule lives, on the average, about one minute before it is hydrated, but remains only about 0.1 second in the hydrated state. Hydration and dehydration are accelerated by the anions of many weak acids, *e. g.* phosphate, borate, and acetate (Roughton and Booth 1938). This is of importance whenever buffers are used. Particularly strong is the effect of a specific enzyme, *carbonic anhydrase*, found in red blood corpuscles by Meldrum and Roughton (1932): *cf.* the reviews by Roughton 1934, 1935.

Further results on the rate of hydration of carbon dioxide were obtained by Mills and Urey (1939, 1940) by the use of isotopic indicators. Their results are summarized in table 8.III.

The *apparent* first dissociation constant of carbonic acid was redetermined by MacInnes and Belcher (1933), who found:

$$(8.6) \quad K'_{D_1} = \frac{[\text{H}^+][\text{HCO}_3^-]}{[\text{CO}_2] + [\text{H}_2\text{CO}_3]} = 4.54 \times 10^{-7} \quad (25^\circ \text{C.})$$

Kauko and Carlberg (1935) obtained a smaller value, 3.50×10^{-7} . The *true* dissociation constant is considerably larger:

$$(8.7) \quad K_{D_1} = \frac{[\text{H}^+][\text{HCO}_3^-]}{[\text{H}_2\text{CO}_3]} = K'_{D_1} \frac{(K_{\text{H}_2\text{O}} + 1)}{K_{\text{H}_2\text{O}}} \approx \frac{K'_{D_1}}{K_{\text{H}_2\text{O}}} = 1.8 \times 10^{-4} \quad (25^\circ \text{C.})$$

The equilibrium constant of reaction (8.5) is:

$$(8.7a) \quad K_{\text{OH}} = \frac{[\text{HCO}_3^-]}{[\text{CO}_2][\text{OH}^-]} = \frac{K_{D_1}}{[\text{H}^+][\text{OH}^-]} = 4.4 \times 10^7 \quad (25^\circ \text{C.})$$

Thus, the standard free energies of hydration of CO₂ molecules are:

$$\Delta F_{\text{H}_2\text{O}} = + 3.7 \text{ kcal/mole} \quad (18^\circ \text{C.})$$

for the hydration to H₂CO₃ molecules, and:

$$\Delta_H F_{\text{OH}} = - 10.4 \text{ kcal/mole} \quad (25^\circ \text{C.})$$

for the association with hydroxyl ions to HCO₃⁻ ions. The *second dissociation constant* of carbonic acid (according to MacInnes and Belcher) is:

$$(8.8) \quad K_{D_2} = \frac{[\text{CO}_3^{2-}][\text{H}^+]}{[\text{HCO}_3^-]} = 5.61 \times 10^{-11} \quad (25^\circ \text{C.})$$

A knowledge of the equilibrium constants K_S , $K_{\text{H}_2\text{O}}$, K'_{D_1} and K_{D_2} permits the calculation of the equilibrium concentrations of all the molecular species in carbonic acid solutions (*cf.* Tables 8.IV and 8.V). Table 8.IV and figure 17 show the composition of carbonic acid solutions at 0° C. according to Faurholt (1924), based on the following values of the dissociation constants:

$$K_{D_1} = 2.24 \times 10^{-7} \quad \text{and} \quad K_{D_2} = 3.2 \times 10^{-11} \quad (0^\circ \text{C.})$$

TABLE 8.IV
EQUILIBRIUM CONCENTRATIONS IN CARBONIC ACID SOLUTIONS AT 0° C.
(FROM FAURHOLT 1924)

pH	CO ₂ , %	HCO ₃ ⁻ , %	CO ₃ ²⁻ , %
0	99.888		
1	99.888		
2	99.886	0.0022	
3	99.886	0.022	
4	99.664	0.224	
5	97.70	2.19	
6	81.60	18.3	
7	30.81	69.1	0.022
8	4.25	95.4	0.302
9	0.43	96.5	3.05
10	0.034	76.0	24.0
11	0.0011	24.0	76.0
12		3.07	96.9

Table 8.V shows the concentration of the species CO₂ in the carbonate-bicarbonate buffer mixtures, which were first used in the study of photosynthesis by Warburg (1919), and found many applications, particularly

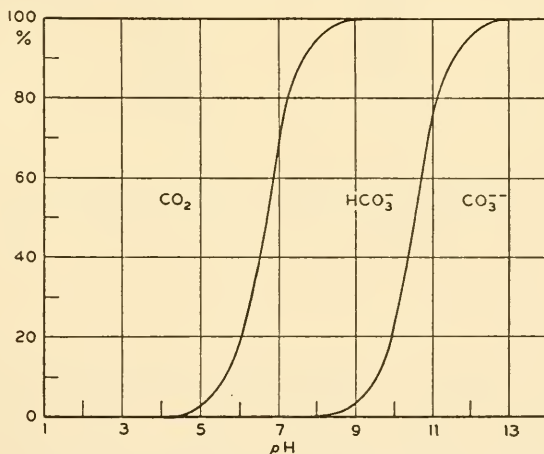

FIG. 17.—Distribution of carbonic acid between CO₂, HCO₃⁻ and CO₃²⁻ as a function of pH (0° C., ionic strength 0) (after Faurholt 1924²).

in kinetic investigations. The presence of a large quantity of bicarbonate ions has the effect of stabilizing the concentration of the carbon dioxide molecules and thus preventing a local exhaustion of carbon dioxide during intense photosynthesis.

Such exhaustion effects—caused by the slow diffusion of carbon dioxide through water—can falsify the results of kinetic studies; the use of carbonate buffer solutions prevents these errors. Warburg's buffer No. 6 (Table 8.V) contains, for example, 5800 HCO_3^- ions (and an equal number of CO_3^{--} ions) for each CO_2 molecule. One can withdraw 10^{-3} moles of CO_2 from a liter of this solution, that is, 120 times more than its initial content in CO_2 molecules—and the concentration of CO_2 molecules will not change by more than 12% (from the initial 8.7×10^{-6} moles/l. to 7.8×10^{-6} moles/l.).

TABLE 8.V
CARBONATE-BICARBONATE BUFFER SOLUTIONS^a

Buffer no.	Moles/liter		[CO ₂] moles/liter × 10 ⁶ (25° C.)
	[K ₂ CO ₃]	[KHCO ₃]	
1 _s	0.085	0.015	0.481
2	0.080	.020	0.902
3	.075	.025	1.49
4	0.070	.030	2.29
5	.060	.040	4.48
6 ^b	.050	.050	8.67 ^b
7	.035	.065	20.5
8	.025	.025	37.5
9	.015	.085	78.7
10	.010	.090	131.
11	.005	.095	290.

^a Warburg (1919), recalculated by Smith (1937), using the dissociation constants of MacInnes and Belcher.

^b This buffer is closest to the concentration of carbon dioxide in pure water equilibrated with the free atmosphere.

Other carbonate-bicarbonate buffer mixtures are listed in Kolthoff's book (1937), p. 259.

Warburg's buffers are strongly alkaline ($p\text{H}$ 8.5 to 11) and therefore "unphysiological," which calls for a certain caution in their use (*cf.* Vol. II, Chapter 27). Pure bicarbonate solutions have, at 25° C., in the concentration range of 0.001 to 0.1 mole per liter, an approximately constant $p\text{H}$ of 8.37 (Kolthoff 1937, p. 21), and therefore also an approximately constant ratio $[\text{HCO}_3^-]/[\text{CO}_2] = 90$.

The solubility of carbon dioxide in water is enhanced by the presence of solid alkaline earth carbonates. Investigators have usually been concerned with another aspect of this phenomenon—the dissolving action of carbonated water on solid carbonates—because this effect has great practical importance. According to the equations:

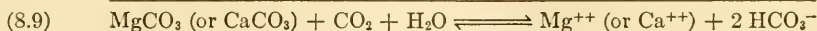
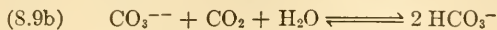
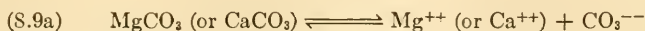

the dissolution of one mole of alkaline earth carbonate is coupled with the absorption of one mole carbon dioxide from the air. The equilibrium (8.9) has been studied by Tillmans and Heublein (1912), Auerbach (1912), Tillmans (1919, 1921), Johnston and Williamson (1916), Frear and Johnston (1929), and Kline (1929). Table 8.VI contains some results.

TABLE 8.VI

SOLUBILITY OF CO₂ IN PRESENCE OF ALKALINE EARTH CARBONATES AT 25° C.

P_{CO_2} , atm.	[HCO ₃ ⁻] in (mole/l.) × 10 ³		
	Without solid carbonates	In presence of CaCO ₃	In presence of MgCO ₃
3.1×10^{-4}	0.0021	1.02	12
1×10^{-3}	0.0039	1.54	16
1×10^{-2}	0.0124	3.4	26
1×10^{-1}	0.0392	7.8	60
1	0.124	18.0	215

The "natural" concentration of bicarbonate ions in solution is increased by the presence of calcium carbonate, by a factor of 500 in air, and a factor of 140 in pure carbon dioxide. The effect of magnesium carbonate is ten times stronger. One-half of this bicarbonate comes from the solid salt and the other half from the atmosphere.

The solubility of carbon dioxide in water is *decreased* by the presence of electrolytes (salting-out effect). For salt concentrations found in plant saps ($\sim 10^{-1}$ mole/liter), this depression may be of the order of 5–10% (*cf.* Quinn and Jones 1936, pp. 97 and 102).

2. Carbon Dioxide Absorption by Alcohols

Plants contain, in addition to aqueous phases (cell sap and cytoplasm), phases of a predominantly "lipoid" character. Chloroplasts, in particular, are rich in lipoids. The carbon dioxide distribution between atmosphere and plant cells can therefore be affected by the solubility of carbon dioxide in lipoids. In general, carbon dioxide is more soluble in organic solvents, than in water—3 times more soluble in toluene and benzene, 3.5 times more in ethanol, and 7.5 times more in acetone. In true lipids, the solubility may well be even higher.

The "physical" solution of carbon dioxide in organic solvents is often enhanced by chemical reactions, analogous to hydration. As in water, the effect of chemical solvation is small in pure solvents, but becomes large when occasion is given for the formation of *anions*, analogous to the bicarbonate ions in water.

In the case of *alcohols*, for example, the molecular solvation equilibrium

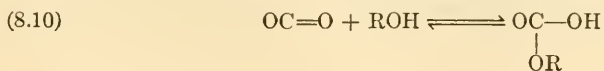

which leads to *carbonic acid esters*, is overshadowed in the presence of alcoholates, by the ionic equilibrium

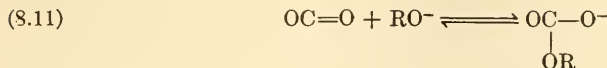

which is analogous to reaction (8.5) in water. Faurholt (1927) estimated, for example, that the two carbon dioxide methanolation constants are (at 0° C.):

$$(8.12) \quad K_{\text{ROH}} = \frac{[\text{HRCO}_3^-]}{[\text{CO}_2]} \approx 0.01; \quad \Delta F_{\text{ROH}} = + 2.7 \text{ kcal}$$

(as against $K_{\text{H}_2\text{O}} \approx 0.001$ in water), and

$$(8.13) \quad K_{\text{RO}} = \frac{[\text{RCO}_3^-]}{[\text{CO}_2][\text{RO}^-]} = 2 \times 10^6; \quad \Delta F_{\text{OR}} = - 9.3 \text{ kcal}$$

(the corresponding value for water is $K_{\text{OH}} = 4 \times 10^7$)

Since the dissociation of methanol is much weaker than that of water ($[\text{RO}^-][\text{H}^+] \approx 10^{-17}$), neither (8.10) nor (8.11) can contribute more than one per cent to the solubility of carbon dioxide in pure methanol; but in sodium alcoholate solutions, with their high concentration of RO^- ions, carbon dioxide is eagerly absorbed with the formation of RCO_3^- ions.

Qualitatively, the absorption of carbon dioxide by alcohols in the presence of alkali was known for a long time. It was studied by Siegfried and Howwjanz (1909), who observed the absorption of 0.2 to 1 mole of carbon dioxide by one mole of methanol, ethanol, glycol, glycerol, erythrol, quercitol, lactose, sucrose, and lactic acid, in the presence of calcium hydroxyde. In *aqueous* alcohol, carbon dioxide becomes an object of competition between water and alcohol. The resulting equilibria have been studied by Faurholt (1927^{2,3}) and Faurholt and Jespersen (1933), for methanol, ethanol, propanol and sucrose. They found that the contribution of alcohols to the absorption of carbon dioxide in alcohol-water mixtures is comparatively small and disappears on both side of the "bicarbonate range" (pH around 8.4) because of the decomposition of the carbonic acid esters (into CO_2 and alcohol on the acid side, and into CO_3^{--} and alcohol on the alkaline side of this range). The ratio:

$$(8.14) \quad K_{\text{OR/OH}} = \frac{[\text{RCO}_3^-]}{[\text{HCO}_3^-][\text{ROH}]}$$

is 0.083 for methanol, 0.044 for ethanol (at 0° C.), and even smaller for sucrose. Consequently, the proportion of carbon dioxide bound to alkyl in a molar methanol solution is only 7.4% at pH 8-9.

Without reference to Faurholt's quantitative results, Baur and Namek (1940) made some rough qualitative observations concerning the carbon dioxide absorption by alcohols. In addition to the rapid gas uptake by dissolution, they noticed a slow absorption which they attributed to esterification. For the extent of this chemical binding, they gave values between 18 ml. of carbon dioxide per mole of ethanol (8×10^{-4} mole/l.) which is many times more than one would expect from Faurholt's equilibrium constants, and 470 ml. (0.02 mole/l.) per mole of phytol. Since phytol is a component of chlorophyll, Baur considered this result as significant for the carbon dioxide fixation in photosynthesis.

3. Carbon Dioxide Absorption by Amines

Carbon dioxide addition to N—H bonds is similar to its addition to O—H bonds in HOH and ROH, except that the basicity of the amines may lead to the formation of *carbamates* (by the addition of a second molecule of amine to the primary formed *carbamic acids*), for example:

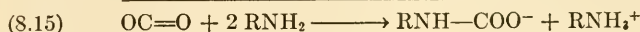
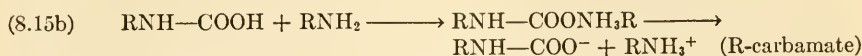
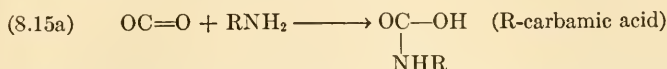

Faurholt (1921, 1922, 1924, 1925) investigated these equilibria in aqueous solutions, and found for the ratio:

$$(8.16) \quad K_{\text{NHR/OH}} = \frac{[\text{RNHCO}_2^-]}{[\text{RNH}_2][\text{HCO}_3^-]}$$

values of about 2 for ammonia, 165 for methylamine, 46 for dimethylamine and 32 for glycine, that is, considerably larger than the corresponding ratios for alcohols. However, because of the basicity of the amines, the RNH_2 molecules constitute (except in very alkaline solutions) only a small proportion of the dissolved amine (most of it being present as RNH_3^+ ions, which have no affinity for carbon dioxide). This restricts the contribution of amines to the carbon dioxide absorption by aqueous solutions. Nevertheless, in a one-molar solution of methylamine, at 18°C . (pH 8.9), 61% of the absorbed carbon dioxide is present in the form of carbamate while 39% is present as HCO_3^- or CO_3^{--} ions. In less alkaline solutions, the extent of carbamation is much smaller; solid carbamates decompose in pure water.

Siegfried (1905^{1,2}), Siegfried and Neumann (1908) and Siegfried and Liebermann (1908) have studied qualitatively the formation of carbamates in aqueous solutions of amines, amino acids, peptones, and proteins, in the presence of alkali (calcium hydroxyde) and Fichter and Becker (1911) have observed the formation of carbamate from gaseous methyl amine and carbon dioxide at low temperatures. According to Siegfried, the proximity of an oxidized group (*e. g.*, carboxyl) favors the addition of carbon dioxide to the amino group; thus, amino acids absorb carbon dioxide more eagerly than alkyl amines. Siegfried suggested that the fixation of carbon dioxide by amino acids may be of importance for photosynthesis. He claimed (1905²) that this reaction can occur even in absence of alkali. However, this conclusion, based on measurements of the increase in the conductivity of glycooll solutions by saturation with carbon dioxide, requires confirmation.

The carbamation equilibria of simple amino acids were again investigated by Stadie and O'Brien (1936). They confirmed the fact that the dipolar ions $\text{NH}_3^+ \cdot \text{RCOO}^-$, which predominate near the isoelectric point, do not unite with carbon dioxide at all; this association is restricted to the anions $\text{NH}_2 \cdot \text{RCOO}^-$, which predominate on the alkaline side of the isoelectric point. The equilibrium:

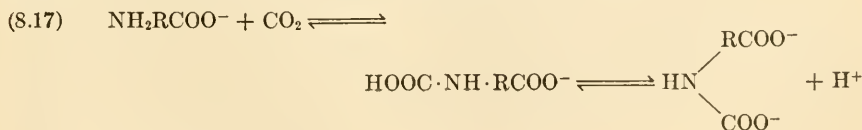

is established so rapidly that it can be studied, in aqueous solution, without interference from the side of the more slowly established hydration equilibrium. The constants

$$(8.18) \quad K_{\text{Carbam.}} = \frac{\left[\begin{array}{c} \text{COO}^- \\ \diagup \\ \text{NH} \\ \diagdown \\ \text{RCOO}^- \end{array} \right] [\text{H}^+]}{[\text{H}_2\text{NRCOO}^-] [\text{CO}_2]}$$

of alanine and glycine are, according to Stadie and O'Brien, of the order of 2.5×10^{-6} at 20°C . Consequently, half-saturation of these amino acids with carbon dioxide is reached at $[\text{CO}_2] = 4 \times 10^{-3}$ mole per liter (*i. e.*, at a partial pressure of 90 mm.) if $p\text{H} = 8$, and at a ten times smaller pressure if the $p\text{H}$ is 9.

Carbamination is of particular importance for the carbon dioxide transportation by blood. The entire absorption of carbon dioxide by blood was attributed, until 1928, to the carbonate-bicarbonate interconversion, although Bohr had postulated the existence of a hemoglobin-carbon dioxide compound in 1905, and Siegfried had demonstrated in the same year the formation of carbamates in blood serum. Kinetic studies by Henriquez (1928, 1931), Margaria and Green (1933), and Meldrum and Roughton (1933) have proved since that an important proportion of carbon dioxide is present in the form of carbamate. The carbamination of blood was discussed quantitatively also by Roughton (1935) and Stadie and O'Brien (1937).

Despite the presence of carbonic anhydrase in blood, the carbamination equilibrium can be studied, independently from the hydration equilibrium, by poisoning this enzyme with cyanide (0.05–0.1 mole/l.). At 0° , with poisoned enzyme, the half-saturation of oxyhemoglobin is reached at about 10 mm. carbon dioxide in the air, and that of reduced hemoglobin at about 30 mm. The heat of carbamination is considerable, about 17 kcal per mole. Table 8.VII illustrates the role which carbamination plays in the carbon dioxide balance of blood.

TABLE 8.VII
BICARBONATES AND CARBAMATES IN BLOOD

Component	Arterial		Venous	
	Plasma	Cells	Plasma	Cells
$p\text{H}$	7.45	7.12	7.43	7.11
CO_2 (free), ml./l.	16	8	18	9
CO_2 as HCO_3^- , ml./l.	331	98	352	105
CO_2 as carbamate, ml./l.	10	20	11	26

Up to 20% of carbon dioxide in red blood cells is present as carbamate, and 45% of the difference between the carbon dioxide content of these cells in venous and arterial blood is caused by a shift of the carbamination equilibrium.

The possible role of amino acids in the carbon dioxide absorption by plants will be mentioned on pages 191 and 194. We must, at this point, cite a case of carbamination which may conceivably be of importance for photosynthesis. For C—H bonds, the substitution of a metal for hydrogen makes the affinity for carbon dioxide stronger, as shown by the eager carboxylation of Grignard's reagents and other metalloorganic compounds. Is it possible for nitrogen-metal bonds also to be more efficient carbon

dioxide acceptors than the nitrogen-hydrogen bonds? In other words, may we expect the reaction:

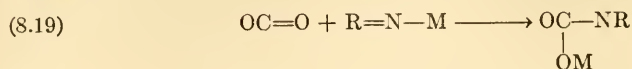

where M = metal, to proceed more easily and completely than reaction (8.15a)?

The importance of this question lies in the fact that chlorophyll contains two nitrogen-magnesium bonds. The interaction of carbon dioxide with chlorophyll *in vitro* will be discussed in chapter 16. One mole of solid or colloidal chlorophyll apparently can absorb up to two moles of carbon dioxide. In interpreting this uptake (page 454), we shall have to consider a reaction of type (8.19) as one possibility.

4. Carboxylation Equilibria

The reaction which has aroused most interest in connection with the primary carbon dioxide fixation in photosynthesis is *carboxylation*. It can be interpreted as an addition of an organic compound RH to the C=O double bonds in carbon dioxide; in other words, the C—H bond plays in carboxylation the same part which the N—H bond plays in carbamination and the O—H bond in the hydration of carbon dioxide.

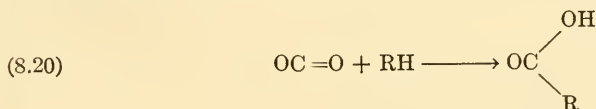

Respiration ends with the elimination of carbon dioxide by *decarboxylation* of certain keto acids. Since photosynthesis is the reversal of respiration, one is tempted to consider the reversal of this last step in respiration as a possible first step in photosynthesis (Thimann 1938).

However, the analogy between the role of decarboxylation in respiration and the role of a preliminary carboxylation in photosynthesis is not quite so close as it may appear. In the respiratory process, decarboxylation is a step in the breakdown of the sugar molecule. Carboxylation would play a corresponding role in photosynthesis only if carbon dioxide were added to an intermediate reduction product, and not to a catalyst which must be restored at the end of the reaction. The carboxylation of chlorophyll or another temporary carrier may be useful for kinetic purposes, but it does not constitute a first step in the building up of a carbon chain.

Carboxylations and decarboxylations do not change the average reduction level of the reacting system and hence have only relatively small heat effects (*cf.* page 216). Table 8.VIII shows that decarboxylations usually are slightly endothermic ($\Delta H > 0$). If decarboxylation leads to the disruption of a conjugation between the C=O double bond in the carboxyl and another C=O double bond in the molecule (as in

pyruvic and oxalic acid) the energy is not markedly different; but conjugation with a C=C double bond apparently has a stabilizing effect, since the decarboxylation energy of benzoic and fumaric acid is as high as 16-17 kcal.

TABLE 8.VIII
HEAT AND FREE ENERGY OF DECARBOXYLATION^a

Acid	Reaction	ΔH	ΔF
I. NO CONJUGATION			
Formic	$\text{HCOOH(l.)} \longrightarrow \text{H}_2\text{(g.)} + \text{CO}_2\text{(g.)}$	+ 5.5	- 8.9
	$\text{H}^+ + \text{HCOO}^-\text{(aq.)} \longrightarrow \text{H}_2\text{(g.)} + \text{CO}_2\text{(aq.)}$	+ 5.7	-11.5
	$\text{H}_2\text{O} + \text{HCOO}^-\text{(aq.)} \longrightarrow \text{H}_2\text{(g.)} + \text{HCO}_3^-\text{(aq.)}$	+ 3.6	- 0.8
Acetic	$\text{CH}_3\text{COOH(l.)} \longrightarrow \text{CH}_4\text{(g.)} + \text{CO}_2\text{(g.)}$	+ 5.0	-11.8
	$\text{H}_2\text{O} + \text{CH}_3\text{COO}^-\text{(aq.)} \longrightarrow \text{CH}_4\text{(g.)} + \text{HCO}_3^-\text{(aq.)}$	+ 3.3	- 5.9
Malonic	$\text{CH}_2\text{(COOH)}_2\text{(s.)} \longrightarrow \text{CH}_3\text{COOH(l.)} + \text{CO}_2$	+ 2.2	
Hexylic	$\text{C}_6\text{H}_{13}\text{COOH(s.)} \longrightarrow \text{C}_6\text{H}_{14}\text{(l.)} + \text{CO}_2$	+ 5.3	
II. CONJUGATION			
$\begin{array}{c} \text{---C=O} \\ \\ \text{---C=O} \end{array}$			
Pyruvic	$\text{CH}_3\text{COCOOH(l.)} \longrightarrow \text{CH}_3\text{CHO(l.)} + \text{CO}_2\text{(g.)}$	+ 1.4	(-15.2)
	$\text{H}_2\text{O} + \text{CH}_3\text{COCOO}^-\text{(aq.)} \longrightarrow \text{CH}_2\text{CHO(aq.)} + \text{HCO}_3^-\text{(aq.)}$	- 1.8	(- 2.9)
	$\text{HOOC---COOH(s.)} \longrightarrow \text{HCOOH(l.)} + \text{CO}_2\text{(g.)}$	+ 3.1	-13.4
Oxalic	$\text{HOOC---COOH(s.)} \longrightarrow \text{H}_2\text{(g.)} + 2 \text{CO}_2$	+ 8.6	-22.3
	$2 \text{H}_2\text{O} + \text{---OOC} \cdot \text{COO}^- \longrightarrow \text{H}_2\text{(g.)} + 2 \text{HCO}_3^-\text{(aq.)}$		- 8.8
III. CONJUGATION			
$\begin{array}{c} \\ \text{=C---C=O} \end{array}$			
Acrylic	$\text{CH}_2=\text{CH---COOH(s.)} \longrightarrow \text{C}_2\text{H}_4\text{(g.)} + \text{CO}_2\text{(g.)}$	+ 9.1	
Fumaric	$\text{HOOC---CH=CH---COOH(s.)} \longrightarrow \text{CH}_2=\text{CH---COOH(s.)} + \text{CO}_2\text{(g.)}$	+16.6	
Benzoic	$\text{C}_6\text{H}_5\text{COOH(s.)} \longrightarrow \text{C}_6\text{H}_6\text{(l.)} + \text{CO}_2\text{(g.)}$	+16	- 4.6
Salicylic	$\text{C}_6\text{H}_4\text{(OH)COOH(s.)} \longrightarrow \text{C}_6\text{H}_6\text{OH(s.)} + \text{CO}_2\text{(g.)}$	+ 9.1	- 3.3
Gallic	$\text{C}_6\text{H}_2\text{(OH)}_3\text{COOH(s.)} \longrightarrow \text{C}_6\text{H}_3\text{(OH)}_3\text{(s.)} + \text{CO}_2\text{(g.)}$	+ 5.0	

^a Cf. bibliography to chapter 3, page 56.

The *free energies* of decarboxylations of pure (solid or liquid) organic acids are more negative (by as much as 10 or 15 kcal) than the *total energies* of these reactions, and thus do not favor back reactions. The ΔF values are negative even for benzoic and salicylic acid, despite their stabilization by conjugation. This explains why attempts of Widmer

(1929) and Hirsbrunner (1934) to reverse the decarboxylation of salicylic, gallic, and phloroglucin-carboxylic acid have been unsuccessful.

In *alkaline* solutions, where carbonic acid is present in the form of anions, the carboxylation reaction becomes:

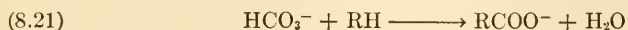

The free energy of reaction (8.21) is considerably less positive than that of reaction (8.20), because carbonic acid is weaker than most carboxylic acids. This explains why the decarboxylation of formic acid in alkaline solution is reversible. This reversibility was demonstrated by experiments with biological catalysts (*Escherichia coli*, cf. page 208). However, with acids much weaker than formic acid (for example, acetic acid), not even the substitution of bicarbonate ions for carbon dioxide molecules will suffice to make carboxylation thermodynamically possible at low temperatures and low partial pressures of carbon dioxide.

Aromatic compounds (benzene, phenol, polyphenols) as well as noncyclic, unsaturated compounds, whose free energies of carboxylation in the acid range are less positive than those of the saturated aliphatic compounds, can be expected to show negative free energies of carboxylation in alkaline media. It is well known that phenols can be carboxylated, in the presence of alkali, at comparatively low temperatures (100–200° C.) and low carbon dioxide pressures. (The usual method of preparation of salicylic acid is by carboxylation of phenolate.) Ruben and Kamen (1940) suggested that the presence in plants of polyphenols (of the type of tannin and quercetin) may be of importance for the fixation of carbon dioxide. However, it still remains to be demonstrated that carboxylations of this type can occur at the comparatively low *pH* values prevailing in plant cells.

In respiration, the elimination of carbon dioxide involves the decarboxylation of two α -keto acids, oxalacetic and pyruvic:

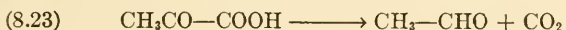

According to table 8.VIII, the decarboxylation of pyruvic acid is not easily reversible ($\Delta F = -15$ kcal), not even in alkaline solution ($\Delta F = -3$ kcal). Carson, Ruben, Kamen, and Foster (1941) tried unsuccessfully to prove, by the use of radioactive carbon dioxide, the reversal of this reaction in enzymatic systems.

No data are available in standard compilations on the thermochemical properties of oxalacetic acid. However, the decarboxylation of this acid was studied by means of radioactive indicators by Carson, Foster, Ruben, and Barker (1941), Wood, Werkman, Hemingway, and Nier (1940, 1941), Krampitz and Werkman (1941), and Krampitz, Wood, and

Werkman (1943); and good evidence of reversibility obtained. Werkman and coworkers found, for example, that if nonradioactive oxalacetic acid is allowed to lose by enzymatic action in an atmosphere of radioactive carbon dioxide about one-half its carbon dioxide content, and the remaining portion is analyzed for radioactivity, a measurable quantity of active carbon is found in the acid (in the carboxyl adjoining the CH_2 group). It thus seems that, in the case of oxalacetic acid, the equilibrium lies further on the side of carboxylation than it does in other organic acids. It would be interesting to check this conclusion directly by the carboxylation of pyruvates.

Baur and Namek (1940) suggested that the carboxylation equilibrium can be shifted towards association not only by the formation of *salts* (as discussed above) but also by the formation of *esters*:

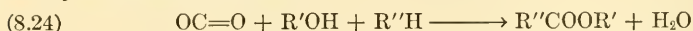

Experiments, by which the occurrence of reaction (8.24) was allegedly proved, consisted in determining the effect of phloroglucinol, $\text{C}_6\text{H}_3(\text{OH})_3$, and of rosolic acid (both representing $\text{R}''\text{H}$) on the carbon dioxide absorption by glycerol (representing $\text{R}'\text{OH}$). A certain increase in absorption was observed in the case of phloroglucinol, but no glycerate of the phloroglucinol-carboxylic acid, $\text{C}_6\text{H}_2(\text{OH})_3\text{COOH}$, could be isolated. The addition of 0.7 g. rosolic acid to 5 ml. of glycerol caused an increase in the carbon dioxide absorption by 2.5 ml.; this, as well as certain color and fluorescence effects, was interpreted as evidence of the formation of a dyestuff derivative of triphenylmethyl-carboxylic acid by the carboxylation of about 5% of added rosolic acid. As in the case of his work on the mechanism of photosynthesis (*cf.* Chapter 4), the conclusions of Baur run far ahead of the very rough experiments.

Organic compounds which are known to absorb carbon dioxide eagerly, with the formation of carboxyl groups, are *metal alkyls*, *e. g.* Grignard reagents. These reactions can be interpreted as additions of $\text{R}-\text{M}$ (M = metal) to $\text{C}=\text{O}$

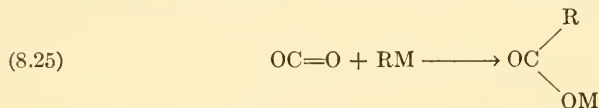

The instability of the carbon-metal bonds and the stability conferred on the salts by ionic dissociation offer sufficient explanation of why, in this case, the equilibrium lies far on the side of synthesis.

We have reviewed the reversible addition of carbon dioxide to $\text{O}-\text{H}$, $\text{N}-\text{H}$, $\text{N}-\text{M}$, $\text{C}-\text{H}$ and $\text{C}-\text{M}$ bonds. Before applying these results to observations on the carbon dioxide fixation by plants, it might be worth while to mention one important example of reversible carbon dioxide fixation in nature—the equilibrium between carbon dioxide and *carbonic anhydrase*. According to Roughton and coworkers (1940), the equilibrium constant:

$$(8.26) \quad K = \frac{[\text{E}]\text{pCO}_2}{[\text{E}\cdot\text{CO}_2]}$$

where E = enzyme, is of the order of 0.1 atm. at 0°C ., and 1 atm. at room temperature. Thus, the energy of formation of the $\text{E}\cdot\text{CO}_2$ complex is of the order of $\Delta H = -15$ kcal, while the *free* energy is about $\Delta F = +1.85$ kcal at 25° . The chemical nature of this complex is unknown.

5. Is Carboxylation a Reduction of Carbon Dioxide?

It is customary to speak of "reduction of carbon dioxide" whenever a carbon dioxide molecule is incorporated into an organic compound with the formation of a new C—C bond. This practice leads to misunderstandings when processes of this kind are put on the same level with the reduction of carbon dioxide in phototrophic and chemotrophic organisms. It is necessary to distinguish clearly between the two types of reactions involving carbon dioxide: reversible *additions* (e. g., the addition of CO₂ to RH, leading to the substitution of C—C bonds for C—O bonds); and true *reductions* (characterized by the creation of new C—H bonds). Whether carboxylation should be called a "reduction" of carbon dioxide at all is a matter of convention. The definition of the word reduction is unambiguous only in the case of *intermolecular* oxidation-reductions, in which the reaction partners exchange electrons (or hydrogen atoms) and then separate, one having experienced oxidation and the other reduction. If the reaction partners remain linked together, the definition becomes vague. To find out whether an oxidation-reduction has occurred, one may consider the positions of electrons or hydrogen atoms before and after the reaction. By this criterion, a carboxylation:

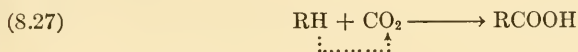

could be considered as the oxidation of the organic radical R and reduction of carbon dioxide, since it involves the shift of a hydrogen from RH to CO₂. However, by the same token, one could also describe the *hydration* of carbon dioxide:

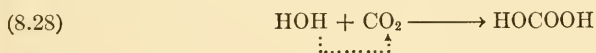

as a reduction of carbon dioxide and oxidation of water. Both in (8.27) and (8.28), the hydrogen is transferred to *oxygen* (in the carbon dioxide); because of the high affinity of oxygen for hydrogen, this requires no supply of energy. A true reduction of carbon dioxide (as defined above) would require the shift of hydrogen to *carbon*. If, after such a shift (from RH or H₂O to CO₂) the products remain united in a single molecule, the results will be:

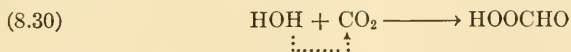
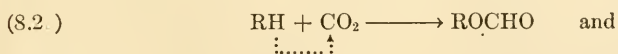

that is, the formation of a *formic acid ester* and *performic acid*, respectively. This would constitute a true reduction of carbon dioxide (and oxidation

of the donor, RH, or water). (Reactions of type 8.30 were postulated by Willstätter and Stoll in 1918 as the main photochemical steps in photosynthesis.)

To sum up, it seems more logical to reserve the term "carbon dioxide reduction" for reactions in which hydrogen atoms (or electrons) are transferred from "donor" molecules to the carbon atom in carbon dioxide, and *not* to apply it to carboxylations and similar additive reactions. True, in dealing with metabolic processes, it is often not clear whether an observed consumption of carbon dioxide is caused by addition or reduction; but the distinction should be kept in mind and applied whenever possible.

B. CARBON DIOXIDE FIXATION BY LIVING CELLS*

The review of different reversible carbon dioxide addition processes *in vitro* in the preceding section illustrates the variety of reactions which may occur when carbon dioxide comes in contact with living organisms.

This interaction has been studied in detail only in the case of blood; observations of the absorption of carbon dioxide by other tissues, animal or vegetable, have for the most part been qualitative. However, the work of Spoehr and Smith on sunflower leaves has opened the way to a more quantitative treatment, which is a prerequisite for the complete understanding of the fate of carbon dioxide in photosynthesis.

From the studies of Smith, water, phosphate, and alkaline earth carbonates emerge as the three main factors determining the carbon dioxide balance of nonilluminated leaves under high partial pressures of carbon dioxide. It was mentioned above that the carbon dioxide balance of blood was originally attributed exclusively to the conversion of carbonates into bicarbonates. Later, it was found that carbamination also plays a limited, but not negligible, part. A similar development may possibly occur in the theory of the carbon dioxide absorption by plants; but the suggestion of Willstätter and Stoll that carbamination is the *main* factor in this absorption is not borne out by the analysis of Spoehr and Smith.

While dissolution in water and bicarbonate formation (and possibly carbamination) determine the carbon dioxide balance of plants under high partial pressures of this gas, the carbon dioxide binding in the complex, $\{\text{CO}_2\}$ —which is probably a carboxylation—comes into greater prominence under low pressures, for instance, in the free atmosphere. Under these conditions, the $\{\text{CO}_2\}$ complex may account for carbon dioxide quantities of the same order of magnitude (1 to $5 \times 10^{-2}\%$ of the dry weight of the leaves) as those absorbed by conversion into bicarbonate.

* Bibliography, page 211.

1. Solubility of Carbon Dioxide in Plant Sap

In all measurements of the carbon dioxide absorption by plant tissues, the solubility in cell water has to be corrected for in order to determine the extent of "chemical" binding. This component is small at the low carbon dioxide concentrations, but grows with increasing pressure, when the chemical absorbers become saturated.

According to table 8.I, the cell water, if it were pure, would contain, in contact with the free atmosphere at 25° C., about 9×10^{-6} mole per liter of CO₂ molecules, and in contact with an atmosphere of pure carbon dioxide, approximately 3×10^{-2} mole per liter. Since an average leaf is about 80% water, the first concentration corresponds to about $2 \times 10^{-4}\%$, and the second to 0.6% dissolved CO₂, relative to the dry weight of the leaves.

A correction is needed in exact calculations for the effect of salts and nonelectrolytes on the solubility of carbon dioxide. However, this effect cannot exceed a few per cent (*cf.* page 179). Smith (1940) found that partial drying of leaves affects the absorption of carbon dioxide somewhat more than can be accounted for by the amount of evaporated water, and ascribed this effect to the solubility-depressing influence of sugars and salts. He noticed also that expressed and acidified cell sap absorbs about 10% less carbon dioxide than the same volume of pure water. Leaves of *Sedum prealtum*, whose sap has a strongly acid reaction (pH 4.08) and in which no bicarbonates can be formed, also absorb less carbon dioxide than calculated from the solubility of this gas in pure water.

The possible contribution of *lipoids* to the reversible absorption of carbon dioxide by plants (*cf.* page 179) has never yet been taken into consideration. The small volume of the lipid phase compared with the hydrophilic phases (cytoplasm and cell sap) perhaps makes the omission permissible.

2. Conversion of Carbon Dioxide into Bicarbonate in Plants

If the cell water were unbuffered, about 15% of dissolved carbon dioxide would be in the form of bicarbonate ions in ordinary air, and a smaller proportion in an atmosphere enriched in carbon dioxide. The sap, under these conditions, would be acid. The absorption of carbon dioxide in excess of normal solubility, actually observed with almost all investigated plants, must be attributed to a conversion of carbon dioxide into bicarbonate by alkalizing agents. The most important of these are solid alkaline earth carbonates and dissolved primary phosphates.

The presence in plants of *solid carbonates* was discovered by Berthelot and André in 1887. They removed "free" carbon dioxide (that is,

dissolved carbon dioxide and one-half the carbonic acid of the bicarbonates) by pumping, then extracted the leaves with water, acidified the extract and the insoluble residue, and measured the evolved carbon dioxide. Table 8.IX contains some of the results obtained in this way.

TABLE 8.IX
CARBONATES IN PLANTS (AFTER BERTHELOT AND ANDRÉ)

Species	CO ₂ , % of dry matter	
	Insoluble carbonates	Soluble carbonates
<i>Chenopodium quinoa</i>	0.03	
<i>Rumex acetosa</i>	0.50	0.14
<i>Oxalis stricta</i>	0.36	0.06
<i>Amaranthus caudatus</i>		0.09
<i>Mesembrianthemum cristallinum</i>	none	0.13 to 0.72

The quantities of *soluble* carbonates (presumably, alkali carbonates) found by Berthelot and André appear too high when one considers the comparatively low *pH* of the cell sap, and do not agree with the quantity of carbon dioxide which the leaves absorb under an increased pressure of carbon dioxide, and liberate *in vacuo*. Recent investigations of Smith make it probable that *divalent* cations account for all the carbonate anions found in the leaves.

The presence of *phosphates* in the cell sap of green plants has been demonstrated by Martin (1927). Their concentration is of the order of 10⁻² mole per liter. Primary phosphate absorbs carbon dioxide according to the equation:

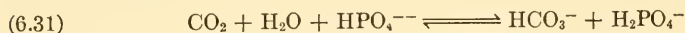

The presence in leaves of alkaline earth carbonates and primary phosphates makes it necessary to consider these factors first in the interpretation of the reversible carbon dioxide absorption by plants.

The first determinations of the reversible carbon dioxide absorption by leaves were carried out by Willstätter and Stoll (1918), with *Urtica dioica* (nettle) and *Helianthus annuus* (sunflower). The absorption isothermals are reproduced in figure 18. Half-saturation is reached in *Helianthus* at about 40 mm., and in *Urtica* at a somewhat higher pressure. The maximum absorbed quantities (after correcting for solubility) are, in both cases, of the order of 1 ml. CO₂ per 10 g. fresh leaves (5 × 10⁻³ mole/l., or about 0.1% of the dry weight of the leaves).

Willstätter and Stoll mentioned the carbonate-bicarbonate conversion as a possible explanation of the carbon dioxide absorption, but thought

that the comparatively high pressure required for saturation argues against this hypothesis and in favor of carbamate formation. The comparison of figure 18 with Smith's figure 19, which contains the calculated absorption curve for a solution of primary phosphate, shows, however, that the Willstätter-Stoll results can be accounted for almost entirely by the phosphate buffer equilibrium.

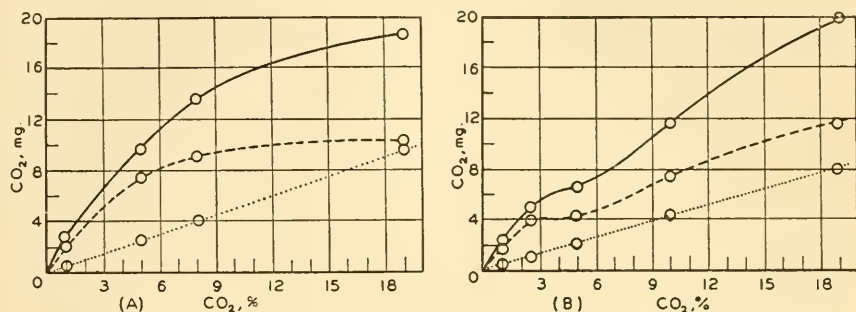

FIG. 18.—Absorption of carbon dioxide at 5° C. A. *Helianthus annuus* (about 20 g. fresh leaves); B. *Urtica dioica* (same quantity) (after Willstätter and Stoll 1918).

— Leaves
 Water in the leaves
 - - - - - Leaves without water (calculated)

According to Willstätter and Stoll, sunflower leaves absorb, under 150 mm. partial pressure, twice as much carbon dioxide as can be dissolved in pure cell water and, under a partial pressure of 0.75 mm. (0.1% CO₂ in the air), twelve times as much. The ratio between chemically bound and physically dissolved carbon dioxide must become even larger at still lower pressures. Thus, Schafer (1938) found that leaves of *Vicia faba* (broad beans) may liberate, *in vacuo*, fifty times as much carbon dioxide as could have been dissolved in the cell water under the partial pressure of carbon dioxide in the air (0.23 mm.).

Systematic attempts to elucidate the nature of the carbon dioxide absorbing agents in plants were first undertaken by Spoehr and coworkers. Spoehr and McGee (1923, 1924) proved that *dried* or *frozen* leaves retain the capacity for carbon dioxide absorption. They found that the absorbing compounds can be extracted from the leaves by ether-saturated water, and considered this at first as a proof of their proteinaceous nature. Later, however, Spoehr and Newton (1925, 1926) found that the absorbing agent (reprecipitated by alcohol from the ether-water extract) does not contain enough nitrogen to account for the carbon dioxide absorption on stoichiometric basis. They therefore abandoned the carbamate hypothesis and turned to the bicarbonate hypothesis.

Spoehr and Newton observed that leaves of sunflower and nettle absorb about twenty times more carbon dioxide than those of alfalfa, rhubarb, spinach, and hydrangea. However, the properties of sunflower are not exceptional, as shown by the later data of Smith (1940), some examples of which are given in table 8.X.

TABLE 8.X
CARBON DIOXIDE ABSORPTION BY FRESH LEAVES

Leaves of	CO ₂ absorbed by 10 g. at 15° C. under 1 atm. pressure of CO ₂ , ml.		
	Total	Dissolved (calcd.)	Excess
<i>Helianthus annuus</i>	10.2–11.6	7.5–8.0	2.2–3.7
<i>Malva parviflora</i>	11.9	7.8	4.1
<i>Libo cedrus</i>	7.7	5.0	2.7
<i>Eschscholtzia californica</i>	9.0	7.6	1.4
<i>Rosa species</i>	8.0	5.9	2.1
<i>Quercus douglasii</i>	6.4	5.6	0.8
<i>Trifolium repens</i>	10.2	7.6	2.6

In all species listed in table 8.X, "chemical" absorption of carbon dioxide enhances the solubility under atmospheric pressure by 20–50% (in agreement with the 100% increase under 150 mm. pressure found by Willstätter and Stoll). The absorption is fully reversible—in fact, a little more carbon dioxide is usually removed by evacuation than has been absorbed under high pressure (obviously because of respiration). *Acidification* liberates an additional quantity of carbon dioxide by the decomposition of neutral carbonates.

TABLE 8.XI
CARBON DIOXIDE CONTENT OF HELIANTHUS LEAVES ^a

No.	Material	CO ₂ content in excess of normal solubility, ml.		
		"Reversible" CO ₂ (under 1 atm.) ^b	"Irreversible" CO ₂ ^c	Total (under 1 atm.)
1	Living leaves	3.0	15.8	18.8
2	Frozen leaves	8.9	7.8	16.7
3	Water extract from 2	4.8	-0.3	4.5
4	Water-insoluble residue of 2	4.9	4.3	9.2
5	CO ₂ -water extract from 4	5.9	5.3	11.2
6	CO ₂ -water-insoluble residue of 4	0	0.5	0.5

^a All figures refer to 10 g. fresh leaves or material derived therefrom.

^b Amount of carbon dioxide absorbed when CO₂ pressure is increased from 0 to 1 atm.

^c Amount of carbon dioxide released by cold dilute acid, minus the "reversible" CO₂.

The total quantity of chemically bound carbon dioxide in *Helianthus* leaves, equilibrated with an atmosphere of pure carbon dioxide, is 17–19 ml. per 10 g. fresh leaves, corresponding to an average CO_2 concentration of 0.1 mole per liter, or 2% CO_2 relative to the dry weight of the leaves. This absorption equilibrium can have nothing to do with chlorophyll, whose average concentration in the leaves is only of the order of 2×10^{-3} mole per liter.

This conclusion is borne out by the observations that yellow leaves absorb the same quantities of carbon dioxide as green leaves (Willstätter and Stoll), that white leaves also yield carbon dioxide *in vacuo* (Schafer), and that stalks, roots, and petals show the same reversible carbon dioxide absorption as leaves (Smith). Schafer found that the quantity of dissociable carbon dioxide increases in light; but this can scarcely be taken as an indication of a direct relationship between the agent absorbing carbon dioxide and the photochemical apparatus of the leaves.

Not all figures in table 8.XI can easily be interpreted. The properties of fractions 3, 4, 5 and 6 are understandable, but the carbon dioxide uptake of whole leaves (rows 1 and 2) is considerably larger than the sum of the volumes taken up by fractions 3 and 4, and its distribution between “reversible” and “irreversible” CO_2 is remarkably different for the living and the frozen leaves.

Fraction 3 behaves as a buffered solution which takes up carbon dioxide under pressure (in excess of the solubility of this gas in pure water) by conversion into bicarbonate, but releases all of it upon evacuation. It will be shown below (*cf.* Fig. 19) that this uptake can be attributed practically entirely to the presence of a phosphate buffer.

The behavior of fraction 4 is that of an insoluble carbonate, which absorbs reversibly an equivalent quantity of carbon dioxide by conversion into bicarbonate (*cf.* p. 179), and thus contains, upon saturation, equal amounts of “reversible” and “irreversible” carbon dioxide. This interpretation is confirmed by the properties of fractions 5 and 6, since they show that the carbon dioxide-absorbing component of fraction 4 is completely soluble in carbonated water.

Fractions 3 to 6 were prepared from 10 g. of frozen leaves. An aliquot portion of whole frozen leaves (No. 2) took up the expected quantity of “reversible” carbon dioxide (roughly the sum of those absorbed by fractions 3 and 4), but proved to contain considerably more “irreversible” carbon dioxide than did these two fractions together. Fresh leaves showed an even stronger deviation from additive behavior: the amount of “reversible” CO_2 was only one-third of that of fractions 3 and 4, while that of “irreversible” carbon dioxide was four times larger.

Since carbonates yield equal quantities of “reversible” and “irreversible” carbon dioxide, while phosphates take up only “reversible” carbon dioxide, the combined action of these two agents should lead to the uptake of more “reversible” than “irreversible” CO_2 —while fresh leaves in table 8.XI show the reverse relation. This can only be explained by assuming the presence of carbonates in such a state or location that they are unable to take part in the absorption of gaseous carbon dioxide, but can be decomposed by acid.

Smith suggested that the difference between living and frozen leaves can be explained by the rapid carbon dioxide production by respiration in the former ones—a

production which partially saturates the buffers during the short time between preliminary evacuation and the admission of carbon dioxide. This may explain the smaller CO_2 uptake after the admission of this gas, but not the increased quantity of "irreversible" carbon dioxide found in living leaves. Furthermore, this explanation implies that respiration builds up a large internal pressure of carbon dioxide before the latter escapes into the atmosphere—which is improbable (compare Vol. II, Chapter 33).

Despite these difficulties of quantitative interpretation, which show the desirability of continued experimentation, Smith's general conclusion that leaves contain two main carbon dioxide-absorbing factors—solid carbonates, and a water soluble buffer—appears plausible.

The behavior of the aqueous fraction in particular can be quantitatively accounted for by the action of a phosphate buffer, as shown by measurements of the CO_2 uptake by this fraction under varying partial pressures of carbon dioxide (*cf.* Table 8.XII and Fig. 19).

TABLE 8.XII
CARBON DIOXIDE ABSORPTION BY WATER EXTRACT OF SUNFLOWER LEAVES

p_{CO_2} atm.	$[\text{HCO}_3^-]$, mole/l. (excess CO_2)	$[\text{HCO}_3^-]$, mole/l. calcd. from pH	pH	Corresponding CO_2 absorption by 10 g. fresh leaves, ml.
0.05	0.0088	0.0088	6.83	1.6
0.20	0.0133	0.0138	6.42	2.4
0.75	0.0180	0.0186	5.98	3.3
0.99	0.0187	0.0197	5.89	3.6

A comparison of pH values in table 8.XII with those in table 8.II confirms the presence of buffers in the sap. The second column in table 8.XII shows that if the bicarbonate concentration is calculated from the carbon dioxide absorption, by assuming that *all* absorption in excess of solubility is due to bicarbonate formation, the result is equal to that derived from acidity. This is taken by Smith as a proof that carbamination plays no part in the carbon dioxide absorption by the water-soluble leaf fraction. In figure 19, the experimental absorption values are compared with the calculated absorption by the phosphate buffer alone; the comparison shows that the phosphate can account for most, but not quite all, the bicarbonate formation in the extract. The remaining discrepancy indicates the presence of some minor buffering components.

The assumption that the carbon dioxide absorbing capacity of the insoluble leaf fraction is caused by the presence of alkaline earth carbonates is supported not only by the solubility of the absorbing agent in carbon dioxide-saturated water, but also by the analysis of the ash. It shows the presence of 6.7×10^{-4} gram atom of calcium and 1.8×10^{-4} gram atom of magnesium in 10 grams of fresh leaves. In the form of

carbonates, these cations could account for the absorption of 8.5×10^{-4} mole, or 19 ml. carbon dioxide. This is a little more than the observed effect; but not all alkaline earths need to be present as carbonates. Insoluble phosphates, as well as manganese (found in the ash), also can

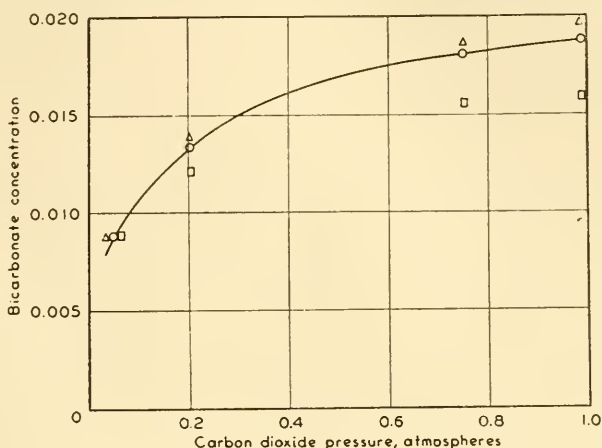

FIG. 19.—The bicarbonate-ion concentration determined from e.m.f. measurements (Δ) compared with the total combined carbon dioxide obtained by gas-analytical methods (\circ) and that calculated from the buffer action of the phosphates (\square) in the sunflower-leaf sap (after J. H. C. Smith 1940).

contribute to the absorption of carbon dioxide by the water-insoluble fraction.

3. Role of Bicarbonate Ions in Photosynthesis

The preceding section showed that plant cells (at least those of the higher plants, since no data are available on algae) usually contain, in equilibrium with the atmosphere, considerably more bicarbonate ions than carbon dioxide molecules. The role of these ions in photosynthesis has been much discussed in the literature, but most arguments used in this discussion are now obsolete; they were based on the effect of the presence of bicarbonate ions *in the environment* on the photosynthesis of aquatic plants.

When Draper (1844) discovered that plants can live in bicarbonate solutions without a carbon dioxide supply, he concluded that bicarbonate ions can be used as such in photosynthesis. Later, it was realized that all bicarbonate solutions contain carbon dioxide molecules; but it was thought that *quantitative* determinations of the rate of photosynthesis in relation to the concentrations, $[\text{CO}_2]$ and $[\text{HCO}_3^-]$, can reveal whether the bicarbonate ions participate directly in photosynthesis or not.

Natanson (1907, 1910) postulated that CO_2 molecules are the only form in which carbonic acid is utilized in photosynthesis, while Angelstein (1911), who had observed

that at a constant value of $[\text{CO}_2]$, the rate of photosynthesis is improved by the addition of bicarbonate, believed in the availability of the latter for the photosynthetic process. Wilmott (1921) found, on the other hand, that the rate of oxygen production by *Elodea* is the same in acid carbon dioxide solutions and in alkaline bicarbonate solutions with the same concentration of CO_2 molecules. Romell (1927) attributed Angelstein's results to the capacity of bicarbonates to renew the supply of carbon dioxide (*cf.* page 177), an interpretation confirmed by James (1928), who noticed that the improvement of photosynthesis, caused by the addition of bicarbonate ions, disappeared with an increase in the rate of circulation of the medium—thus indicating that it was predicated upon a local exhaustion of carbon dioxide.

Because of the permeability of cell membranes to carbon dioxide molecules, changes in the external concentration of this molecular species produce shifts in the carbonate concentration inside the cell (accompanied by changes in the acidity of the aqueous cell phases). Whether variations in the external concentration of bicarbonate ions, for which the cell membrane is almost impermeable, also affect the composition of the carbonic acid system in the cell, is a complicated problem of membrane equilibrium, and as long as we do not know the answer, experiments with varying concentrations of carbonate ions in the external medium do not tell us anything definite about the part which these ions play *inside the cell*.

One thing, however, can be stated with certainty. If the presence of carbonate anions in the medium does have an influence on the composition of the carbonic acid system within the cell (in the equilibrium state or in the steady state of illumination), this influence is at least several orders of magnitude smaller than that of free carbon dioxide molecules. Warburg's buffers contain tens of thousands of HCO_3^- and CO_3^{--} ions for each CO_2 molecule (*cf.* Table 8.V). Nevertheless, the curves showing the yield of photosynthesis in relation to the concentration of the species CO_2 in these mixtures have approximately the same shape as those obtained in experiments with land plants supplied with free CO_2 molecules only. For instance, according to chapter 27 (Vol. II), the saturation of the photosynthetic apparatus of *Chlorella* occurs, in carbonate-bicarbonate buffers, at $[\text{CO}_2] = 5 \times 10^{-5}$ mole/l., with 7.5×10^{-2} mole/l. HCO_3^- and 2.5×10^{-2} mole/l. CO_3^{--} ions also present in solution; while the photosynthetic apparatus of wheat is saturated when the concentration of carbon dioxide is of the order of 2 to 4×10^{-5} mole/l. In other words, the presence of an enormous excess of HCO_3^- and CO_3^{--} ions does not essentially affect the carbon dioxide saturation, which remains determined, in the first approximation, by the concentration of the carbon dioxide molecules alone.

The assertion that carbonate ions cannot penetrate into the cells as rapidly as do the carbon dioxide molecules is based not only on the general experience that ions, with their clusters of water molecules, are much

less capable of penetrating through cell membranes than neutral, particularly lipophilic molecules, but also on direct experiments of Osterhout and Dorcas (1926), who found that the rate of penetration of carbonic acid into the interior of the unicellular alga, *Valonia*, is proportional to the external concentration of carbon dioxide and unaffected by the addition of a large quantity of carbonate and bicarbonate ions.

At first sight, certain results of Arens (1930, 1933, 1936^{1,2}) seem to contradict the conclusions of Osterhout and Dorcas. He investigated the well-known fact that aquatic plants, *Elodea* or *Potamogeton*, for instance, while carrying out photosynthesis in natural waters, often become covered by a precipitate of calcium carbonate; at the same time, the water in the neighborhood of the leaves becomes alkaline. Both observations are easily explained by shifts in the equilibrium (8.9), caused by the elimination of carbon dioxide by photosynthesis. The interesting aspect of the phenomenon is that the deposition of calcium carbonate often takes place on the *upper* surface only. This would be natural if the *consumption* of HCO_3^- ions also took place only there. Arens found, however (by experiments in which leaves were used as membranes between two water-filled cells), that the bicarbonate— $\text{Ca}(\text{HCO}_3)_2$ or KHCO_3 — is consumed on the *lower* surface of the leaf, while an equivalent quantity of Ca^{++} (or K^+) ions emerges at the upper surface, accompanied either by CO_3^{--} ions (in the case of potassium bicarbonate), or by OH^- ions (in the case of calcium bicarbonate). This directed transfer of ions through the leaves takes place only in light and thus appears to be related to photosynthesis. Although the results of Arens indicate a penetration of ions across the leaf, they do not necessarily clash with the conclusions of Osterhout and Dorcas. According to the latter, the flow of carbonic acid into the cells is maintained practically exclusively by the molecules of CO_2 , even when the medium contains a large excess of carbonate or bicarbonate ions. This makes it probable that the *ions*, HCO_3^- and CO_3^{--} , cannot penetrate through the membranes at all. However, carbonate solutions contain a small proportion of undissociated salt molecules (KHCO_3 , K_2CO_3 etc.). It seems plausible that salt molecules can pass through the membranes as easily as acid molecules. If this is so, the results of Arens could be attributed to the penetration of the cell by these molecules, rather than by free ions. A salt, *e. g.* KHCO_3 , would enter the cell in the form of neutral molecules, dissociate there into ions, have a part or all of its HCO_3^- ions consumed by photosynthesis, and escape on the opposite side of the cell in the form of other neutral molecules, *e. g.*, K_2CO_3 or KOH . Simultaneously with this comparatively slow flow of carbonates and bicarbonates across the cell, a much larger quantity of free carbon dioxide—unobserved in Arens technique—enters the cell (as shown by Osterhout and Dorcas), to be completely consumed there by photosynthesis.

It must be added that the correctness of the results of Arens is not beyond doubt. Gessner (1937) found, for instance, by experiments with vaseline-covered leaves, that both surfaces of *Elodea* leaves are equally active in supplying carbon dioxide for photosynthesis.

A complete interpretation of the transport of ions across the leaves must also take into consideration the possibility of diffusion through the cell walls without actual entrance into the membrane-shielded interior of the cells.

It was repeatedly stated that the ratio $[\text{HCO}_3^-]/[\text{CO}_2]$ in the medium cannot be changed without simultaneous change in acidity. The occasionally observed *depressing influence of carbonates* on the rate

of photosynthesis at constant $[\text{CO}_2]$ may thus have been caused by the alkalinity of the medium rather than by the carbonate ions themselves. It has, for example, been reported by van der Honert (1930) and van der Paauw (1932), that *Horridium* does not thrive in carbonate buffers at all; *Chlorella* cells are more resistant but they too are affected by the more alkaline of Warburg's buffers (Emerson 1936; Emerson and Green 1938).

To sum up: all experiments described so far do not teach us anything about the true role of carbonate ions in photosynthesis. The occasional *improvement* in rate caused by an addition of these ions at a constant concentration of carbon dioxide can be attributed to the removal of CO_2 -depletion effects, while the occasional *decrease* in rate caused by the same treatment may be due to changes in pH . The meaning of Arens' observations on the direct transfer of ions across the leaves cannot be assessed without new quantitative experiments.

While we find no basis for the claim that carbonate ions play a direct part in photosynthesis, neither can we assert that they play no such part at all. Even if these ions do not penetrate into the cell from the outside, they are produced inside by the interaction of carbon dioxide molecules with alkalinizing buffers (HPO_4^{--} , CaCO_3 , etc.). In equilibrium with the atmosphere, the concentration of HCO_3^- ions in the cell usually is many times larger than that of free CO_2 molecules. We have assumed that the immediate substrate of reduction is a complex, $\{\text{CO}_2\}$. The participation of HCO_3^- (and CO_3^{--}) ions in the formation of this complex may be twofold. If this complex can be used for photosynthesis both as a carboxylic acid RCOOH and as its anion, RCOO^- , then the presence of bicarbonate ions can increase its *equilibrium concentration*. If, however, only the neutral complex can take part in photosynthesis, then the presence of anions, although it cannot affect the equilibrium concentration of the reduction substrate, may accelerate the *rate of its formation*.

One argument has been presented in favor of the assumption that the main reaction sequence of photosynthesis does *not* include the intermediate formation of bicarbonate ions. It was based on an estimate of the *rate of hydration of carbon dioxide* in the cell, a rate which appears to be too slow to allow *all* the reduced carbon dioxide molecules to pass through the hydration stage. It was mentioned on page 175 that the (noncatalyzed) hydration of carbon dioxide requires about one minute at room temperature. Consequently, only about $5 \times 10^{-6} \times p$ moles of carbon dioxide (p = carbon dioxide pressure in mm.) can be hydrated (noncatalytically) each second in one liter of cells. On the other hand, at $p = 1$ mm. (a pressure sufficient for carbon dioxide saturation of photosynthesis in most plants), as much as 10^{-4} mole carbon dioxide can

be reduced each second in one liter of plant cells (Vol. II, Chapter 28), *i. e.* twenty times more than can be hydrated during the same period. Calculations of this type were first carried out by Burr (1936), who obtained, for a number of plants, ratios between the rates of uncatalyzed hydration and photosynthesis ranging from 1 : 73 to 1 : 2440. He concluded that hydration of carbon dioxide cannot represent a necessary step in photosynthesis.

It may be argued that the conversion of CO_2 into HCO_3^- ions in plant cells is catalyzed, if not by carbonic anhydrase, at least by milder catalysts such as phosphates (*cf.* page 176). Experiments carried out by Burr (1936) failed to reveal any catalytic effects of mashed leaves on the hydration velocity of carbon dioxide; and the same result was obtained by Mommaerts (1940). Neish (1939), on the other hand, gave some figures for the carbonic anhydrase activity of leaf matter as a whole, and of separated chloroplast matter (Table 14.VIII). According to his measurements, 1 ml. of a suspension containing 1 mg. of dry leaf material can liberate, at 22° C., about 1 mm.³ carbon dioxide per second from 1 ml. of a 0.2 M NaHCO_3 solution mixed with an equal volume of a phosphate buffer (*pH* 6.8). It appears impossible to calculate from this rate of catalytic *dehydration* the maximum rate of *hydration* of carbon dioxide by the same amount of leaves, and thus to decide whether Neish's results contradict directly the conclusions of Burr and Mommaerts.

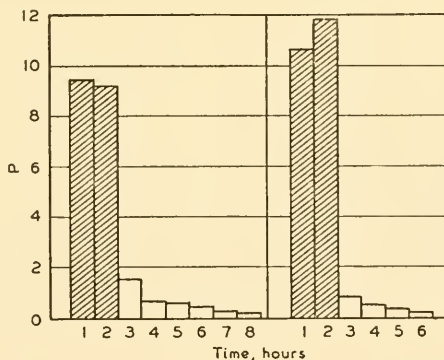

FIG. 20.—Hourly yield of photosynthesis (*P*) of *Hydrilla* (left) and *Cabomba* (right) in carbonate solution (shaded) and after transfer into distilled water (white) (after Gessner 1937).

The carbon dioxide–bicarbonate–carbonate equilibrium in the cells, even if it does not lie in the direct path of photosynthesis, may play a part in this process by providing *carbon dioxide reserves* within the cell which help to even out short-time variations in the external supply of

this substrate. Arens (1933, 1936^{1, 2}) asserted, for example, that *Elodea*, *Potamogeton*, and other aquatic plants can continue photosynthesis for a considerable length of time after having been transferred from a bicarbonate solution into distilled water, and attributed this phenomenon to the formation of carbonate reserves. Gessner (1937) confirmed the existence of such reserves in many (although not all) aquatic plants, but found that they are much less extensive than could be gathered from Arens' observations. Figure 20 shows the rapid decline in the rate of oxygen evolution by *Hydrilla* and *Cabomba* which follows a transfer of their twigs into distilled water. This figure indicates that the carbonate reserves of aquatic plants are not larger than those of land leaves (Tables 8.IX and 8.X), *i. e.*, of the order of 0.1 to 1% of the dry weight of the leaves. Since intense photosynthesis leads to an hourly increase in dry weight by several per cent (Vol. II, Chapter 28), carbonate stores of this magnitude cannot maintain photosynthesis at its full rate for more than a few minutes.

4. Carboxylation and the $\{CO_2\}$ Complex

Except for the observations of Schafer on the increase in carbon dioxide content upon illumination (page 193), the experiments described above do not reveal any relationship between the reversible carbon dioxide absorption by plants in the dark and the reduction of carbon dioxide in light. We shall now describe experiments which indicate that a different (although also a reversible and nonphotochemical) absorption of carbon dioxide is closely associated with photosynthesis—presumably as a preliminary step in this process (as assumed in Chapter 7). The quantities of carbon dioxide involved in this absorption are twenty or fifty times smaller than those which can be accounted for by the carbon dioxide-bicarbonate equilibria, *i. e.*, of the order of 2×10^{-3} mole per liter of cell volume, or $5 \times 10^{-2}\%$ CO_2 relative to the dry weight of the cells, or 0.5 ml. carbon dioxide gas per 10 grams of fresh cells. On the other hand, the affinity of the acceptor responsible for this absorption to carbon dioxide must be higher than that of the phosphate or carbonate buffers, since its saturation occurs at carbon dioxide pressures of the order of 1 mm. This value is derived from the "carbon dioxide" curves of photosynthesis (representing rate *vs.* concentration of carbon dioxide). These curves (*cf.* Vol. II, Chapter 27) show "half-saturation" at $[CO_2]$ values of the order of 0.03% in the air. One explanation of this saturation, which will be discussed in chapter 27 (Vol. II), is that the carbon dioxide curves are equilibrium isothermals of the acceptor-carbon dioxide complex. According to this hypothesis these curves may be distorted by supply and disposal limitations which prevent the maintenance of the carboxylation equilibrium during intense photosynthesis, or cause the

rate to become insensitive to the concentration of carbon dioxide long before the complex, $\{\text{CO}_2\}$, has been fully saturated; but this distortion does not change the *order of magnitude* of the carbon dioxide concentration required for saturation. If the complex, $\{\text{CO}_2\}$, is half-saturated at carbon dioxide concentrations of the order of 10^{-5} mole per liter (0.03% CO_2 in the air), the free energy of its formation must be of the order of -6 kcal at room temperature (Ruben 1943, estimated $\Delta F = -2$ kcal)—a considerably more negative value than the free energies of carbamination and carboxylation quoted in the first part of this chapter; more negative than even the free energy of association of carbon dioxide with carbonic anhydrase (page 186).

As an alternative to this "static" interpretation of the carbon dioxide saturation of photosynthesis, we will consider in volume II, chapter 27, the hypothesis of Franck, according to which this saturation is due mainly to *kinetic* factors (slow rates of certain partial processes of photosynthesis which make the utilization of additional carbon dioxide impossible). The carboxylation equilibrium is assumed by Franck to lie very far on the association side, even at the lowest carbon dioxide pressures. This hypothesis implies that the free energy of carboxylation is even more negative than the above calculated value of -6 kcal per mole.

Experiments with radioactive C^*O_2 , to be described below, make it plausible that the complex $\{\text{CO}_2\}$ *can* be dissociated by evacuation; a direct manometric determination of its CO_2 tension could determine which of the two alternative hypotheses is to be preferred.

Ruben (1943) suggested that the strong affinity of the unknown acceptor for carbon dioxide may be caused by a coupling between its carboxylation and the hydrolysis of an "energy-rich" organic phosphate which occurs with the liberation of 10 to 12 kcal per mole (*cf.* Chapter 9, page 224). If the uptake of one molecule of carbon dioxide were coupled with the formation of one molecule of inorganic phosphate from an "energy-rich" phosphorylated molecule, the net change in free energy could be of the magnitude required for the explanation of the early carbon dioxide saturation of photosynthesis.

In chapter 5, the experiments of Vogler and Umbreit (1942) on *Thiobacillus thiooxidans* have been described. After a period of sulfur oxidation which is accompanied by a transfer of inorganic phosphate from the medium into the cells, these bacteria prove to be capable of absorbing a certain quantity of carbon dioxide in absence of sulfur and oxygen. It was suggested on page 114 that this absorption probably is a preliminary fixation (*e. g.*, carboxylation) rather than a reduction of carbon dioxide. It is accompanied by a release of inorganic phosphate by the cell, and this can be considered as an argument in favor of Ruben's

hypothesis. However, some quantitative discrepancies remain to be clarified. In the first place, the amount of carbon dioxide taken up by the bacteria appears to be at least one and perhaps two orders of magnitude larger than that absorbed by green plants. In the second place, the amount of liberated phosphate is only one-fiftieth of that of absorbed carbon dioxide. (To explain the latter fact, Vogler suggested that the release of inorganic phosphate into the medium may be only a small token of the large-scale transphosphorylation taking place inside the cell.)

Direct evidence pertaining to the nature of the $\{CO_2\}$ complex is scarce. Some important observations were, however, made with radioactive carbon dioxide, C^*O_2 , by Ruben and coworkers. The fixation of C^*O_2 in the dark was first observed by Ruben, Hassid, and Kamen (1939) in barley leaves and by Ruben, Kamen, Hassid, and Devault (1939) in *Chlorella*. The properties of the compound formed by this "dark fixation" of carbon dioxide were described in more detail by Ruben, Kamen, and Hassid (1940). (They used the term "reduction of carbon dioxide," which we prefer to avoid for the reasons given on page 187.)

The cell suspension was exposed to radioactive carbon dioxide for several minutes in the dark, acidified, and boiled vigorously. The part of the absorbed radioactive carbon dioxide which was *not* removed by this treatment was obviously present in an acid-resisting form, that is, not as carbonate or carbamate. Most of the radioactive carbon passed, upon boiling, into the aqueous solution, showing that the complex, $\{CO_2\}$, was water-soluble (at least, to a small extent—the quantity of $\{CO_2\}$ produced in these experiments was only of the order of 10^{-5} mole in one milliliter of algae). Figure 21 shows the uptake of carbon dioxide in the dark as a function of time. In this curve, an apparent saturation corresponds to about 0.2 ml. C^*O_2 per ml. of algae, or about 0.01 mole per liter of cell volume (about five times the amount of carbon dioxide dissolved in cell

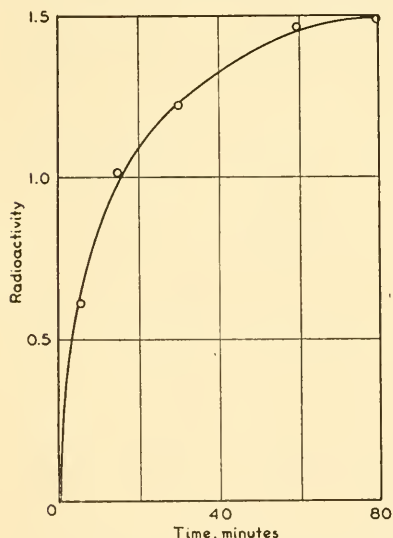

FIG. 21.—Radioactive carbon dioxide uptake by *Chlorella* in the dark. Measured in arbitrary units, 1.5 units corresponding to approximately 0.2 mm.³ carbon dioxide per mm.³ algae (after Ruben, Kamen, and Hassid 1940).

water under the conditions of the experiment). The uptake of C^*O_2 is reversible: flushing the algae with inactive carbon dioxide removes 5 or

10% of the absorbed activity. The uptake is an enzymatic process; it is brought almost to a standstill (more exactly, to 0.3% of its normal rate) by the presence of 10^{-2} mole per liter of potassium cyanide.

We referred to the saturation in figure 21 as "apparent" because of the observation that the maximum uptake can be further increased by alternative evacuation of the cell suspension and its exposure to radioactive carbon dioxide. The maximum absorption obtained in this way is about 0.03 mole per liter of cell volume. Ruben and coworkers assumed that figure 21 represents the rate of association of labeled carbon dioxide with the acceptor which was "denuded" of carbon dioxide by evacuation. If the stability of the $\{CO_2\}$ complex is such that it is only partially decomposed (decarboxylated) by evacuation, then rapid carboxylation with labeled carbon dioxide will extend only to the decarboxylated fraction. After this fraction has been recarboxylated, further entrance of radioactive C^*O_2 can occur only by *exchange* with the ordinary CO_2 already present in the complex, and this may be a much slower process. A second evacuation will decompose another batch of $\{CO_2\}$ complexes and leave them bare for reoccupation by labeled C^*O_2 , and so forth, until a uniform distribution of C^* between the gaseous phase and the $\{CO_2\}$ complex is reached. (However, this explanation requires that the same total absorption of C^*O_2 could also be obtained by waiting under a stationary C^*O_2 atmosphere for the same period of time which was employed in the evacuations.)

If this interpretation is correct, it means that the complex $\{CO_2\}$ has a finite dissociation pressure—a conclusion which was mentioned once before (page 201).

One remarkable feature of figure 21 is the slowness of the C^*O_2 uptake. The "pickup" observations, to be described later in this chapter, show that when, after a period of photosynthesis, the carbon dioxide acceptor finds itself "denuded" of CO_2 , the regeneration of the complex $\{CO_2\}$ is completed within 10 or 20 seconds; while the uptake of C^*O_2 requires a whole hour. We will encounter a similar situation later when speaking of the slow rate of reabsorption of the carbon dioxide liberated in the "gush" of this gas which was observed by Emerson and Lewis during the induction period of photosynthesis in *Chlorella*. If we insist in attributing the dark C^*O_2 uptake, the "pickup," and the CO_2 absorption after the "gush" to one and the same chemical reaction—formation of the complex $\{CO_2\}$ —we must assume that, in the first and last case, this process is slowed down, either by the inactivation of the carboxylating catalyst, E_A , in the dark, or by the inactivation of the acceptor—and that only in the second case does the carboxylation proceed at its full rate (meaning by this the rate which must be maintained in the steady state of photosynthesis in intense light).

The concentration of the complex, $\{\text{CO}_2\}$, is of the same order of magnitude as that of chlorophyll. (Chlorophyll constitutes as much as 5% of the dry weight of *Chlorella*, cf. page 411, corresponding to an average concentration of about 0.01 mole per liter.) However, the acceptor is not chlorophyll, for the aqueous cell extract (which contains all radioactive carbon) is colorless. Furthermore, cells with different chlorophyll concentrations show no differences in C^*O_2 -absorbing capacity, and etiolated plants also are able to absorb carbon dioxide.

Frenkel (1941) exposed *Nitella* plants to C^*O_2 for 25 minutes, and disintegrated the cells in 0.5 *M* glucose solution (*Nitella* cells disintegrate without grinding). He separated the cell sap and the cytoplasm from the (mostly intact) chloroplasts by centrifuging, and tested the activity of different fractions (after preliminary boiling with 12 *N* hydrochloric acid for the removal of carbonates). Surprisingly, no activity was found in the chloroplasts; 90% of the total activity was found in the colorless supernatant solution. When similar plants were exposed to radioactive carbon dioxide *in light*, four-fifths of the absorbed activity were found in the chloroplast fraction, and the active substance could not be extracted by a 0.5 *M* glucose solution. *Nitella* cells, crushed *before* exposure to radioactive carbon dioxide, formed none of the acid-resistant carbon dioxide complex whether they were exposed in dark or in light. When intact cells were first exposed to C^*O_2 in the dark and then crushed and exposed to light, no transfer of activity from the aqueous phase into the chloroplasts could be observed.

Thus, it appears that the carbon dioxide acceptor is either only loosely bound to the chloroplasts (so that it can be removed by a short contact with glucose solution) or, more probably, is not contained in the chloroplasts at all, but rather in the cytoplasm or in the cell sap. Furthermore, intact cells seem to be a prerequisite both for the formation of $\{\text{CO}_2\}$ and for its reduction in light.

The following information was obtained by Ruben and coworkers as to the chemical nature of the carbon dioxide-acceptor complex in *Chlorella* cells. Over 70% of the active substance is precipitated by barium ions in 80% ethanol, and 30–50% of the active barium salt is transformed into carbonate by dry distillation. The theoretical value for complete decarboxylation of a barium salt of a carboxylic acid, with C^* located in the carboxyl group, is 50%. It thus seems that most, if not all, of the carbon dioxide in the $\{\text{CO}_2\}$ complex is contained in a carboxyl group. In addition to the carboxyl group, the complex apparently contains one or several hydroxyl groups, whose presence was indicated by the Schotte-Baumann test (esterification with benzoyl chloride and extraction of the active esters with chloroform). More recently (1943),

Ruben suggested that the acceptor compound may be an *aldehyde*, and formulated the complex, $\{CO_2\}$, as RCOCOOH.

Attempts to identify the complex by coprecipitation with one of the familiar plant acids (ascorbic, citric, fumaric, maleic, succinic, oxalic, or tartaric) gave no positive results. This appears understandable in the light of the results obtained by the ultracentrifugation of the active solution. According to Ruben, Kamen, and Perry (1940), the radioactive product (obtained by the exposure of *Chlorella* for 20 minutes to C^*O_2 in the dark) has a sedimentation constant of 8.6×10^{-14} , or four times that of sucrose, indicating a molecular weight of about 1000. Ruben and Kamen (1940) have also measured the diffusion coefficient of the radioactive complex, and found $D = 0.44 \times 10^{-5}$ cm.²/sec.; from this they estimated the molecular weight as being close to 1500.

From all these experiments, Ruben and Kamen concluded that the first step in photosynthesis is an enzymatic carboxylation of a colorless molecule whose size and concentration is similar to that of chlorophyll. We may add to this that Frenkel's experiments indicate that this carboxylation takes place outside the chloroplasts.

Smith and Cowie (1941) also observed the absorption of radioactive carbon dioxide by plants in the dark. They used sunflower leaves and found that radioactive carbon dioxide can be used for the study of the carbon dioxide-bicarbonate equilibrium, as well as that of the $\{CO_2\}$ formation. Their results discussed on pages 192 to 195 have been confirmed; and, as a new result, Smith and Cowie found that some carbon dioxide is retained by the leaves upon acidification (in agreement with Ruben's observations on *Chlorella*); the acid-resistant complex accounted for about 0.3 ml. carbon dioxide per 10 g. fresh leaves. This absorption is almost entirely absent in *frozen* leaves, but freezing *after* absorption does not destroy the complex. This indicates that freezing affects the enzymatic system which catalyzes the carboxylation reaction. The authors confirmed also the observation of Ruben and coworkers that repeated evacuation and exposure to C^*O_2 increases the amount of absorbed activity (*e. g.*, from 0.03 to 0.08 ml. in 1.3 g. leaves, after three evacuations). The concentration of the acceptor in the leaves (assuming a stoichiometric ratio of acceptor : carbon dioxide as 1 : 1) is 4 to 5×10^{-3} mole per liter, that is, it is similar to the concentrations of chlorophyll in sunflower leaves (which is 3 to 5 times smaller than in *Chlorella* cells).

The radioactive complex, $\{C^*O_2\}$, formed in the dark is used up afterwards in light, thus confirming the assumption that its formation is a preparatory step in photosynthesis.

There is no reason why the formation of the complex, $\{CO_2\}$, should not also be detectable by ordinary analytical methods. However, ob-

servations of this kind have been made only accidentally, in the kinetic studies of photosynthesis, when conditions were such that the acceptor became "denuded" of carbon dioxide (because the enzymatic formation of the complex did not hold step with the consumption of carbon dioxide by photosynthesis). Under these conditions, a cessation of illumination

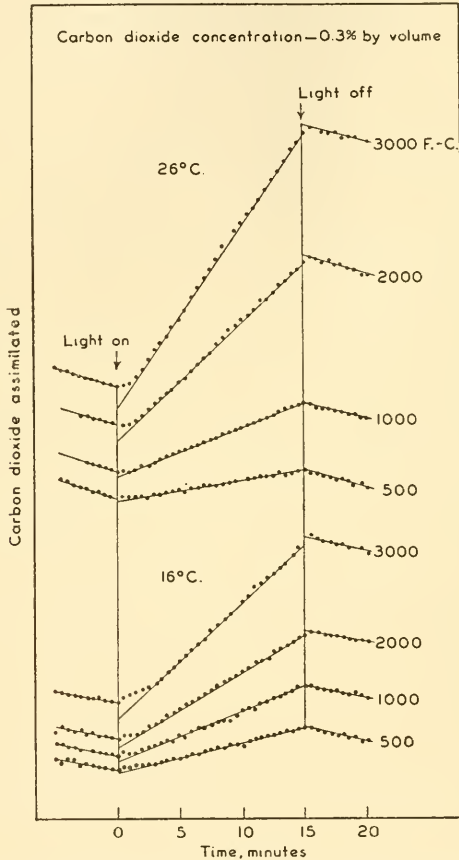

FIG. 22.—Time course of carbon dioxide assimilation at 16° and 26° C. for four light intensities. The "pickup" in the dark appears at the two higher light intensities (after McAlister 1939).

was followed by a carbon dioxide absorption in the dark, which lasted for seconds or even minutes. This phenomenon, called the "pickup," was observed by McAlister (1939), McAlister and Myers (1940) and Aufdemgarten (1939), who have followed photosynthesis by registering continuously the consumption of carbon dioxide, rather than (as is usually done) the evolution of oxygen.

Figure 22 taken from McAlister's paper on wheat, illustrates the pickup phenomenon. The ordinates represent the transmission of the gas at $4.25 \mu\mu$: the higher the ordinate, the smaller the concentration, $[CO_2]$. The first, downward section of the curves represents the increase in $[CO_2]$ in the dark caused by respiration; the upward section shows the decrease in $[CO_2]$ in light through photosynthesis. At the beginning of the upward section, an *induction period* of the order of 1 to 2 minutes is visible on all curves; at the end of the upward section, when illumination stops, respiration usually immediately succeeds photosynthesis. However, on the curves which correspond to the strongest illumination, the absorption of carbon dioxide continues for about 20 seconds in the dark.

The maximum amount of pickup after very intense photosynthesis was about one-half molecule of carbon dioxide per molecule of chlorophyll, *i. e.*, of the same order of magnitude as found by Ruben and Smith for the binding of radioactive carbon dioxide in *Chlorella* and sunflower leaves.

The pickup was observed also by McAlister and Myers (1940) with a different experimental setup (*cf.* Vol. II, Chapter 33). This time, no pickup was found at the high (saturating) concentrations of carbon dioxide, even in strong light, but positive results were obtained at low (limiting) CO_2 concentrations. The duration of the pickup was found to increase with decreasing concentration, reaching a full minute at 0.006% carbon dioxide.

Similar observations were made by Aufdemgarten (1939) with *Stichococcus bacillaris*. He noticed that the pickup is slowed down by the presence of cyanide, *e. g.*, from 30 to 150 seconds in a $1 \times 10^{-3} M$ potassium cyanide.

It seems that the pickup occurs whenever the concentration of the complex, $\{CO_2\}$, is depressed, either because of the high rate of its utilization by photosynthesis (McAlister), or because of the low rate of its replacement, the latter being caused either by a low concentration of carbon dioxide (McAlister and Myers), or by an inhibition of the catalyst E_A by cyanide (Aufdemgarten).

Another kinetic observation, which must be mentioned here is the "carbon dioxide gush" observed by Emerson and Lewis (1941) in the first few minutes of illumination of *Chlorella*. It was followed, in the dark, by a slow absorption of a quantity of carbon dioxide roughly equivalent to that lost in the gush. The details of this phenomenon will be discussed in chapter 33 (Vol. II), dealing with the induction phenomena. The total volume of the gush is about 0.2 ml. per ml. of cell volume; it can thus be attributed to a photochemical decomposition of the complex $\{CO_2\}$. (Details of this explanation, given by Franck in 1942, were discussed in chapter 7, page 167.) The reabsorption of carbon dioxide in the experiments of Emerson and Lewis is very slow (it may

require for completion 30 to 60 minutes). The implications of this fact have been mentioned before (page 203).

5. Carbon Dioxide Fixation by Heterotrophants

We found in the preceding section that, despite the difficulties encountered in attempts to reverse the decarboxylation of carboxylic acids *in vitro* in neutral media, carboxylation represents the most probable primary carbon dioxide fixation mechanism in photosynthesis. In addition to the direct evidence in favor of this theory, obtained in experiments with radioactive carbon, we will now mention indirect arguments provided by an increasing variety of nonphotochemical metabolic processes. In these processes, carbon dioxide plays an unexpectedly active part, and they are best explained by the incorporation of carbon dioxide into carboxylic groups. Until a few years ago, carbon dioxide was considered as an "inert" gas for all heterotrophants (even though it was known that many life processes, such as the germination of seeds, are inhibited by the total absence of this gas); but lately, examples of nonphotochemical carbon dioxide assimilation have multiplied rapidly, and have spread from the world of bacteria into those of the higher plants and animals.

The simplest case of carbon dioxide fixation by carboxylation is the synthesis of formic acid, *e. g.* (in alkaline solution):

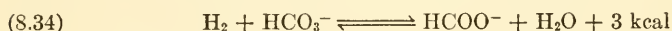

The standard free energy of this reaction is $\Delta F = +0.9$ kcal according to table 8.VIII (-0.4 kcal according to the calculations of Woods 1936). Of all carboxylations, it has the most valid claim to being considered as a *reduction* of carbon dioxide because it involves a complete hydrogenation of a C=O double bond, with one hydrogen atom becoming bound to oxygen and another to carbon.

In a formate solution which is in contact with air, reaction (8.34) will proceed in the direction of decarboxylation, but under sufficiently high partial pressures of hydrogen and carbon dioxide, this process can be reversed. *Escherichia coli*, which was shown by Stephenson and Stickland (1932, 1933) to bring about decarboxylation of formic acid, was proved by Woods (1936) to be capable of catalyzing the reverse reaction as well. Woods measured both the absorption of hydrogen and the formation of formic acid. The reaction is poisoned by cyanide (from 10^{-5} moles/l. on) and by narcotics (toluene, chloroform). It tends to an equilibrium, from whose position a standard free energy of -0.17 kcal was calculated by Woods, in satisfactory agreement with the values quoted above ($+0.9$ or -0.4 kcal) derived from nonbiological measurements.

Another example of biological carbon dioxide fixation by carboxylation is provided by the *propionic acid bacteria*, studied by Wood and Werkman (1936, 1938^{1,2}, 1940^{1,2}), Phelps, Johnson, and Peterson (1939), Carson and Ruben (1940), and Carson, Foster, Ruben, and Barker (1941). In the absence of carbon dioxide, these bacteria convert glycerol into propionic acid by dehydration:



In the presence of carbon dioxide, the products include *succinic acid*, $\text{CH}_2(\text{COOH})_2$, apparently formed by carboxylation of an intermediate C_3 product. If radioactive carbon dioxide is used, the activity is found, after the reaction, in the carboxylic groups of both propionic and succinic acid.

Numerous other examples of biological CO_2 uptake by bacteria, plant tissues (for example, ground barley roots), and animal tissues (pigeon and rat liver) have been found since 1935; many of them probably involve carboxylations, although some may be true reductions.

Van Niel, Ruben, Carson, Kamen, and Foster (1942) suggested that biological carboxylations are essential for growth and respiration because they contribute to the synthesis of the C_4 acids (fumaric, malic, succinic, oxalacetic), which play an important part in respiration (and perhaps also in photosynthesis).

Bibliography to Chapter 8

Fixation of Carbon Dioxide

A. Carbon Dioxide Fixation in vitro

- 1899 Bohr, C., *Ann. Physik*, **68**, 500.
- 1905 Bohr, C. in C. Bohr and W. Nagel, *Handbuch der Physiologie des Menschen*. Vol. 1, 1905, p. 54.
- Siegfried, M., *Z. physiol. Chem.*, **44**, 85.
- Siegfried, M., *ibid.*, **46**, 401.
- Siegfried, M., and Neumann, L., *ibid.*, **54**, 423.
- 1908 Siegfried, M., and Liebermann, M., *ibid.*, **54**, 437.
- 1909 Siegfried, M., and Howwjanz, S., *ibid.*, **59**, 376.
- 1911 Fichter, F., and Becker, B., *Ber. deut. chem. Ges.*, **44**, 3481.
- 1912 McBain, J. W., *J. Chem. Soc.*, **101**, 814.
- Tillmans, J., and Heublein, O., *Gesundh.-Ing.*, **35**, 669.
- Auerbach, F., *ibid.*, **35**, 869.
- 1914 Thiel, A., and Strohecker, R., *Ber. deut. chem. Ges.*, **47**, 945, 1061.
- 1916 Johnston, J., and Williamson, E. D., *J. Am. Chem. Soc.*, **38**, 975.
- Strohecker, R., *Z. Untersuch. Nahrungsmitt.*, **31**, 121.
- 1918 Willstätter, R., and Stoll, A., *Untersuchungen über die Assimilation der Kohlensäure*. Springer, Berlin, 1918.
- 1919 Warburg, O., *Biochem. Z.*, **100**, 238.

- Tillmans, J., *Z. Untersuch. Nahru. Genussm.*, **38**.
1921 Tillmans, J., *ibid.*, **42**.
Faurholt, C., *Z. anorg. allgem. Chem.*, **120**, 85.
Faurholt, C., *Kgl. Danske Videnskab. Selskab Math.-fys. Medd.*, **20**.
1922 Faurholt, C., *Z. anorg. allgem. Chem.*, **122**, 132.
1924 Faurholt, C., *Kgl. Veter. Landb. Aarskr.*, **1924**, 3.
Faurholt, C., *J. chim. phys.*, **21**, 400.
1925 Faurholt, C., *ibid.*, **22**, 1.
1927 Faurholt, C., *Z. physik. Chem.*, **126**, 72.
Faurholt, C., *ibid.*, **126**, 85.
Faurholt, C., *ibid.*, **126**, 211.
Faurholt, C., *ibid.*, **126**, 227.
1928 Henriquez, O. M., *Biochem. Z.*, **200**, 1.
1929 Widmer, O., *Z. physik. Chem.*, **A140**, 161.
Frear, G. L., and Johnston, J., *J. Am. Chem. Soc.*, **51**, 2086.
Kline, W. D., *ibid.*, **51**, 2093.
1931 Henriquez, O. M., *J. Biol. Chem.*, **92**, 1.
1932 Meldrum, N. U., and Roughton, F. J. W., *J. Physiol.*, **75**, 3.
1933 Faurholt, C., and Jespersen, I. C., *Z. physik. Chem.*, **A165**, 79.
Stadie, W. C., and O'Brien, H., *J. Biol. Chem.*, **103**, 521.
Brinkman, R., Margaria, R., and Roughton, F. J. W., *Trans. Roy. Soc. London*, **232**, 65.
MacInnes, D. A., and Belcher, D., *J. Am. Chem. Soc.*, **55**, 2630.
Margaria, B., and Green, A. A., *J. Biol. Chem.*, **102**, 611.
Meldrum, N. U., and Roughton, F. J. W., *J. Physiol.*, **80**, 143.
1934 Hirsbrunner, M., *Helv. Chim. Acta*, **17**, 477.
Roughton, F. J. W., *Ergeb. Enzymforsch.*, **3**, 289.
1935 Roughton, F. J. W., *Physiol. Revs.*, **15**, 241.
Kauko, Y., and Carlberg, J., *Z. physik. Chem.*, **A173**, 141.
1936 Quinn, E. L., and Jones, C. L., *Carbon Dioxide*. Reinhold, New York, 1936.
Stadie, W. C., and O'Brien, H., *J. Biol. Chem.*, **112**, 723.
1937 Smith, E. L., *J. Gen. Physiol.*, **20**, 807.
Kolthoff, I. M., *Acid-Base Indicators*. Macmillan, New York, 1937.
Stadie, W. C., and O'Brien, H., *J. Biol. Chem.*, **117**, 439.
1938 Thimann, K. V., *Science*, **88**, 506.
Roughton, F. J. W., and Booth, V. H., *Biochem. J.*, **32**, 2049.
1939 Mills, G. A., and Urey, H. C., *J. Am. Chem. Soc.*, **61**, 534.
1940 Roughton, F. J. W., unpublished.
Olsen, A. R., and Joule, P. V., *J. Am. Chem. Soc.*, **62**, 1027.
Mills, G. A., and Urey, H. C., *ibid.*, **62**, 1019.
Ruben, S., and Kamen, M. D., *ibid.*, **62**, 3451.
Baur, E., and Namek, M., *Helv. Chim. Acta*, **23**, 1101.
Wood, H. G., Werkman, C. H., Hemingway, A., and Nier, A. O.,
J. Biol. Chem., **135**, 789.
1941 Wood, H. G., Werkman, C. H., Hemingway, A., and Nier, A. O.,
ibid., **139**, 365.

- Carson, S. F., Foster, J. W., Ruben, S., and Barker, H. A., *Proc. Natl. Acad. Sci. U. S.*, **27**, 229.
- Carson, S. F., Ruben, S., Kamen, M. D., and Foster, J. W., *ibid.*, **27**, 475.
- Krampitz, O., and Werkman, C. H., *Biochem. J.*, **35**, 595.
- 1943 Krampitz, L. O., Wood, H. G., and Werkman, C. H., *J. Biol. Chem.*, **147**, 243.

B. Carbon Dioxide Fixation by Living Cells

- 1844 Draper, W., *Ann. chim. phys.*, **11**, 223.
- 1887 Berthelot, M., and André, G., *ibid.*, **10**, 85.
- 1907 Natansohn, A., *Ber. Verhandl. sächs. Akad. Wiss. Leipzig Math.-phys. Klasse*, **59**, 211.
- 1910 Natansohn, A., *Der Stoffwechsel der Pflanze*. Quelle and Meyer, Leipzig, 1910.
- 1911 Angelstein, U., *Beitr. Biol. Pflanz.*, **10**, 87.
- 1918 Willstätter, R., and Stoll, A., *Untersuchungen über die Assimilation der Kohlensäure*. Springer, Berlin, 1918.
- 1921 Wilmott, A. J., *Proc. Roy. Soc. London B*, **92**, 304.
- 1923 Spoehr, H. A., and McGee, J. M., *Carnegie Inst. Yearbook*, **22**, 53.
- 1924 Spoehr, H. A., and McGee, J. M., *ibid.*, **23**, 132.
- Spoehr, H. A., and McGee, J. M., *Science*, **59**, 513.
- 1925 Spoehr, H. A., and Newton, W., *Carnegie Inst. Yearbook*, **24**, 160.
- 1926 Spoehr, H. A., and Newton, W., *ibid.*, **25**, 177.
- Osterhout, W. J. V., and Dorcas, M. J., *J. Gen. Physiol.*, **9**, 255.
- 1927 Martin, S. H., *Protoplasma*, **1**, 522.
- Romell, L. G., *Flora*, **121**, 125.
- 1928 James, W. O., *Proc. Roy. Soc. London B*, **103**, 1.
- 1930 van der Honert, T., *Rec. trav. botan. néerland.*, **27**, 149.
- Arens, K., *Planta*, **10**, 814.
- 1932 van der Paauw, P., *Rec. trav. botan. néerland.*, **29**, 497.
- Stephenson, M., and Stickland, L. H., *Biochem. J.*, **26**, 712.
- 1933 Stephenson, M., and Stickland, L. H., *ibid.*, **27**, 1528.
- Arens, K., *Planta*, **20**, 621.
- 1936 Arens, K., *Jahrb. wiss. Botan.*, **83**, 513, 561.
- Burr, G. O., *Proc. Roy. Soc. London B*, **120**, 42.
- Woods, D. D., *Biochem. J.*, **30**, 515.
- Emerson, R., *Ergeb. Enzymforsch.*, **5**, 307.
- Wood, H. G., and Werkman, C. H., *Biochem. J.*, **30**, 48.
- 1937 Gessner, F., *Jahrb. wiss. Botan.*, **85**, 267.
- 1938 Emerson, R., and Green, L., *Plant Physiol.*, **13**, 157.
- Wood, H. G., and Werkman, C. H., *J. Bact.*, **36**, 5.
- Wood, H. G., and Werkman, C. H., *Biochem. J.*, **32**, 1262.
- Schafer, J., *Plant Physiol.*, **13**, 141.
- 1939 Aufdemgarten, H., *Planta*, **29**, 643.
- McAlister, E. D., *J. Gen. Physiol.*, **22**, 613.
- Neish, A. C., *Biochem. J.*, **33**, 300.

- Ruben, S., Hassid, W. Z., and Kamen, M. D., *J. Am. Chem. Soc.*, **61**, 661.
- Ruben, S., Kamen, M. D., Hassid, W. Z., and Devault, D. C., *Science*, **90**, 570.
- Phelps, A. S., Johnson, M. J., and Peterson, W. H., *Biochem. J.*, **33**, 726.
- 1940 McAlister, E. C., and Myers, J., *Smithsonian Inst. Pub. Misc. Collections*, **99**, No. 6.
- Smith, J. H. C., *Plant Physiol.*, **15**, 183.
- Wood, H. G., and Werkman, C. H., *Biochem. J.*, **34**, 7.
- Wood, H. G., and Werkman, C. H., *ibid.*, **34**, 129.
- Ruben, S., Kamen, M. D., and Hassid, W. Z., *J. Am. Chem. Soc.*, **62**, 3443.
- Ruben, S., Kamen, M. D., and Perry, L. H., *ibid.*, **62**, 3450.
- Rubens, S., and Kamen, M. D., *ibid.*, **62**, 3451.
- Carson, S. F., and Ruben, S., *Proc. Natl. Acad. Sci. U. S.*, **26**, 422.
- Mommaerts, W. F. H. M., *Proc. Acad. Sci. Amsterdam*, **43**, 1044.
- 1941 Frenkel, A. W., *Plant Physiol.*, **16**, 654.
- Emerson, R., and Lewis, C. M., *Am. J. Botany*, **28**, 789.
- Carson, S. F., Foster, J. W., Ruben, S., and Barker, H. A., *Proc. Natl. Acad. Sci. U. S.*, **27**, 229.
- Smith, J. H. C., and Cowie, D. B., *Plant Physiol.*, **16**, 257.
- 1942 Franck, J., *Am. J. Botany*, **29**, 314.
- van Niel, C. B., Ruben, S., Carson, S. F., Kamen, M. D., and Foster, J. W., *Proc. Natl. Acad. Sci. U. S.*, **28**, 8.
- Vogler, K. G., *J. Gen. Physiol.*, **26**, 103.
- Vogler, K. G., and Umbreit, U. W., *ibid.*, **26**, 157.
- 1943 Ruben, S., *J. Am. Chem. Soc.*, **65**, 279.

CHAPTER 9

THE NONPHOTOCHEMICAL PARTIAL PROCESS IN PHOTOSYNTHESIS

II. REDUCTION OF CARBON DIOXIDE*

This chapter is based on the assumption that the reduction of the complex, $\{\text{CO}_2\}$, is a nonphotochemical process involving an intermediate reductant (designated as $\{\text{H}\}$ or HX in Chapter 7), and not a direct photochemical reaction with reduced and excited chlorophyll, as postulated in the theory of Franck and Herzfeld.

In chapter 4, we stated that carbon dioxide, as well as the carboxyl group, can be reduced *in vitro* only by means of strong reductants which are unlikely to occur in living cells. However, the example of autotrophic bacteria shows that organisms can produce agents capable of reducing carbon dioxide, even without the help of light. We have as yet no knowledge of their nature, but we may assume as a possibility—perhaps even as a probability—that the same reductants are responsible for the reduction of carbon dioxide in the photosynthesizing higher plants as well.

To understand the thermodynamic difficulties of the reduction of carbon dioxide (or of the carboxyl group), it is useful to review some fundamental facts of the thermochemistry of organic compounds.

1. The Standard Bond Energies

The energy of a homopolar single bond is, to a first approximation, independent of the nature of other groups to which the bonded atoms are attached, and the energy content of a nonionic molecule is, to the same approximation, the sum of these bond energies. However, secondary influences often cause considerable deviations from additivity. For example, the standard energy of an *oxygen-hydrogen* bond is 110 kcal, one-half the total energy of the water molecule. However, the energies of dissociation of OH into O and H and of H_2O into OH and H , are known separately; and it turns out that 117 kcal is liberated in the formation of the first OH bond, and only 104 kcal in that of the second one (probably because of the mutual repulsion of dipoles associated with the oxygen-hydrogen bonds).

*Bibliography, page 244.

TABLE 9.I
ENERGY OF DISSOCIATION OF RH INTO R + H AT ROOM TEMPERATURE

Investigator	ΔH_D kcal/mole
Butler and Polanyi (1940); Baughan and Polanyi (1940)	103.6
Anderson, Kistiakowsky, and van Artsdalen (1942)	102 (R = Me), 98 (R = Et)
Stevenson (1942)	101 (R = Me), 96 (R = Et)

The energy of the *last carbon-hydrogen* bond in saturated hydrocarbons has been derived from experimental results (Table 9.I) and is close to 100 kcal. The energies of the other C—H bonds are not known separately, but their *average* strength can be calculated from the heat of formation of methane—if an assumption is made concerning the heat of sublimation of carbon, V_C . From spectroscopic considerations, the two values, $V_C = 123$ and 168 kcal per mole, have been derived as possible alternatives. Pauling (1940) thought the smaller value more plausible, while Baughan (1941) and Kynch and Penney (1941) argued in favor of the larger one. In Pauling's system, the average strength of the four C—H bonds in methane is 87 kcal, and thus considerably smaller than the energy of dissociation of methane into CH_3 and H; with $V_C = 168$ kcal, it becomes equal to 98 kcal, and thus practically identical with the methyl—hydrogen bond energy. However, even if the larger value is correct (Herzberg, in 1942, again advocated the alternative $V_C = 123$ kcal, and C—H = 87 kcal) this does not mean that all four stages in the dissociation of CH_4 require the same energy; rather, the equality of the strength of the last bond and of the average of all four of them must be considered as coincidental.

In the estimation of the heats of reactions, any consistent set of bond energies can be used, since the value of V_C cancels out in the calculation.

The greatest deviations from additivity are caused by *double bonds*, which may be either weaker or stronger than two single bonds, and whose strength is affected by conjugation and other resonance phenomena.

Table 9.II contains bond energies, based on $V_C = 168$ kcal, which may be useful in the discussion of the chemical mechanism of photosynthesis.

2. Reduction Level and Energies of Combustion, Dismutation, and Hydration

Table 9.II shows that all bonds directly involved in photosynthesis have strengths between 75 and 100 kcal, with the exception of the O—H bond, which is the strongest single bond in existence, and the

TABLE 9.II
 BOND ENERGIES IN KCAL/MOLE AT 291° K.^a

Bond	Energy liberated, kcal/mole	From the heat of formation of
O—H ^b	110	H ₂ O
C—H ^c	98	CH ₄
N—H	84	NH ₃
O—O ^d	36	H ₂ O ₂
C—O	77	CH ₃ OH
C=O	2 × 82	CH ₂ O
O—C=O ^e	3 × 90	HCOOH
O=C=O ^f	4 × 95	CO ₂
C—C ^g	78	C ₂ H ₆
C=C	2 × 70	C ₂ H ₄
C—C=C ^h	3 × 79	C ₆ H ₆
C—N	57	CH ₃ NH ₂

^a Calculated with $V_C = 163$, $D(H_2) = 103$, $D(O_2) = 118$ and $D(N_2) = 170$ kcal/mole, from heats of formation given by Bichowsky and Rossini (1936).

^b The energy of dissociation of OH into O and H is 117 kcal; the same value is obtained for the OH bonds in H₂O₂, if one assumes O—O = 22 kcal (cf. footnote d).

^c If one assumes C—C = 86 kcal (cf. footnote g), one obtains 96 kcal for the C—H bond in ethane.

^d The actual energy of dissociation of H₂O₂ into two OH radicals is 22 kcal. The value in the table is obtained by assigning the standard value (110 kcal) to the O—H bonds in hydrogen peroxide.

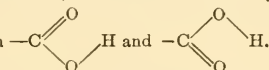
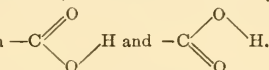
• Stabilized by resonance, mainly between  H and  H.

^f Resonance mainly between O=C=O, O⁺≡C—O⁻ and O⁻—C≡O⁺.

^g The actual energy of dissociation of C₂H₆ into 2 CH₃ is 86 kcal; the value in the table is based on C—H = 98 kcal.

^h One-third of the energy of the ring system in benzene, calculated with C—H = 98 kcal.

Footnotes *b*, *c*, *d*, and *g* illustrate the discrepancies between the "standard" bond energies and the actual energies of dissociation. There is, however, no way of improving table 9.II, without assigning different values to the same bond in different compounds. For example, if the energy of dissociation of H₂O₂ into two OH radicals (22 kcal) were adopted as the strength of the O—O bond, one would obtain 117 kcal for the strength of the average O—H bond in hydrogen peroxide, while the strength of the same H bond in water is only 110 kcal. Similarly, if one would adopt the dissociation energy of C₂H₆ into two CH₃ radicals (86 kcal) for the strength of the C—C bond, this would give 96 kcal for the average strength of a C—H bond in ethane, as against 98 kcal in methane. Multiplicity of bond values would defeat the purpose of a standard bond table, which is to provide a means for rapid—even if approximate—evaluation of the energy content of different molecules.

O—O bond, which is among the weakest ones. The strength of O—H bonds and the weakness of O—O bonds are the two reasons why photosynthesis is strongly endothermal: in the synthesis of a —CHOH group and of an oxygen molecule from CO₂ and H₂O, one O—H bond disappears and one O=O double bond is created.

According to table 9.II, the oxidation of a C—H bond by molecular oxygen to carbon dioxide and water should liberate 48 kcal; and that of

a C—C bond, 53 kcal. In a *first approximation*, we may thus expect 100 kcal to be released by the complete combustion of carbon—oxygen—hydrogen compounds (excepting the peroxides) for each oxygen molecule consumed in this process.

The ratio of the number of oxygen molecules consumed in the combustion of an organic molecule to the number of carbon atoms in it was designated on page 109 as the “reduction level,” and the following equation was given for its calculation:

$$(9.1) \quad L = \frac{2n_C + 0.5n_H - n_O}{2n_C}$$

n_C , n_H , and n_O being the numbers of carbon, hydrogen, and oxygen atoms, respectively. We now see that the heat of combustion of an organic compound is determined, in the first approximation, by its reduction level. If the heats of combustion of a number of organic compounds, reduced to one gram atom of carbon, are plotted against L , the points fall near a straight line, with a slope of about 110 kcal (*cf.* Fig. 23).

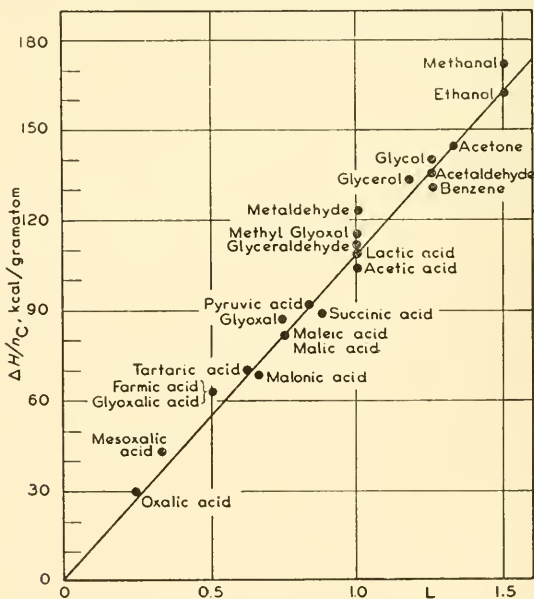

FIG. 23.—Heats of combustion of carbon—hydrogen—oxygen compounds per gram atom of carbon as a function of reduction level L .

The difference between this value and the expected slope of 100 kcal is caused by the fact that, in the second approximation, C—O bonds contribute up to 20 kcal to the heat of combustion, because of the extent to which they are stabilized in carbon dioxide (the average strength of a C—O bond in CO_2 is 95 kcal, as against only 77 kcal in alcohols, 82 kcal in aldehydes, and 90 kcal in carboxylic acids).

Dismutations, isomerizations and hydrations do not change the overall reduction level of the reacting system and should therefore have but small heat effects. However, because of the variations in the strength of C—O bonds mentioned above, the energies of some dismutations and isomerizations reach -10 , or even -20 kcal, as illustrated by table 9.III. The same effect explains why the energy of *carboxylation* ($\text{RH} + \text{CO}_2 \longrightarrow \text{RCOOH}$) is almost zero (*cf.* Table 8.III), instead

TABLE 9.III

TOTAL ENERGIES, ΔH , AND FREE ENERGIES, ΔF , OF SOME DISMUTATIONS, ISOMERIZATIONS AND HYDRATIONS

Type of reaction	Reaction	ΔH	ΔF
Dismutation	2 Methyl glyoxal (l.) \longrightarrow pyruvic acid (l.) + glycerol (l.)	- 4	
	2 Formaldehyde (aq.) \longrightarrow formic acid (aq.) + methanol (aq.)		-11
	2 Acetaldehyde (aq.) \longrightarrow acetic acid (aq.) + methanol (aq.)	-11	-20
	Glucose (s.) \longrightarrow 2 ethanol + 2 carbon dioxide (g.)	-20.6	-55
Isomerization	Glyceraldehyde (s.) \longrightarrow lactic acid (s.)	-12	
Hydration ^a	Fumaric acid (s.) + water \longrightarrow malic acid (s.)	0.7	- 2.9
	Fumarate ²⁻ (aq.) + water \longrightarrow malate ²⁻ (aq.)	0.7	0.7
	Pyruvate (phosphate) ⁻ (aq.) + water \longrightarrow glycerate (phosphate) ⁻ (aq.)		0.6

^a Hydration of $-\overset{\text{O}}{\underset{\text{O}}{\text{C}}}=\text{O}$ to $-\overset{\text{O}}{\underset{\text{O}}{\text{C}}}(\text{OH})_2$ is also known to occur with a very small thermochemical effect, so that a carbonyl group in aqueous solution often reacts as a dihydroxyl group.

of being negative (as it should be because of the greater strength of the O—H bonds compared to C—H bonds).

These considerations do not apply to *free radicals*, whose dismutation into saturated molecules may liberate very large amounts of energy (*cf.* section 6).

The heats of *polymerization* of carbohydrates can be derived from table 3.V, and are very small.

3. Energies of Hydrogenation and Oxidation-Reduction Potentials

According to table 9.II, the energy of hydrogenation of a standard, nonconjugated C=C double bond by molecular hydrogen is -30 kcal and that of a C=O bond, -17 kcal, while the hydrogenation of a C—C single bond should liberate 15 kcal. Examples 1, 2, 3, 4, 8, 9, 10, 12, and 13 in table 9.IV illustrate the approximate validity of these estimates.

TABLE 9.IV

TOTAL ENERGIES, ΔH , AND FREE ENERGIES, ΔF , OF HYDROGENATION ^a OF C—C AND C—O BONDS AND THE CORRESPONDING OXIDATION-REDUCTION POTENTIALS, E_0 (AT pH 0) AND E_0' (AT pH 7) ^b

Example no.	A (oxidant)	AH ₂ (reductant)	ΔH kcal	ΔF , kcal (298° K.)	E_0 , volt	E_0' (pH 7), volt
I. C—C BOND						
1a	Succinic acid (s.)	2 Acetic acid (l.)	- 8.2	-10.2	(-0.22)	(+0.20)
1b	Succinate ²⁻ (aq.)	2 Acetate ⁻ (aq.)		-14.4	(-0.30)	(+0.12)
IIA. C=C BONDS						
2	Ethylene (g.)	Ethane (g.)	-32.6	-24.4	(-0.53)	(-0.10)
3a	Fumaric acid (s.)	Succinic acid (s.)	-31.2	-22.1	(-0.48)	(-0.06)
3b	Fumarate ²⁻ (aq.)	Succinate ²⁻ (aq.)		-20.5	-0.45	-0.03
4	Cyclohexene (g.)	Cyclohexane (g.)	-29.1	-18.4	(-0.40)	(+0.02)
IIB. C=C—C=C GROUP						
5	Cyclohexadiene (g.)	Cyclohexene (g.)	-26.5	-17.7	(-0.39)	(+0.03)
6	Furan (g.)	Dihydrofuran (g.)	-11.4	- 2.5	(-0.06)	(+0.36)
7	Benzene (g.)	Cyclohexadiene (g.)	+ 5.8	+13.6	(+0.30)	(+0.72)
IIIA. C=O BONDS						
8a	Formaldehyde (g.)	Methanol (g.)	-19.7	-12.8	(-0.28)	(+0.14)
8b	Formaldehyde (aq.)	Methanol (aq.)		- 8.7	(-0.19)	(+0.23)
9a	Acetaldehyde (g.)	Ethanol (g.)	-13.0	- 6.7	(-0.15)	(+0.27)
9b	Acetaldehyde (aq.)	Ethanol (aq.)		- 8.3	-0.20	(+0.22)
IIIB. $\begin{array}{c} \text{C=O} \\ \\ \text{HO—C=O} \end{array}$ GROUP						
10a	Pyruvic acid (l.)	Lactic acid (l.)	-21.5			
10b	Pyruvate ⁻ (aq.)	Lactate ⁻ (aq.)	-18.4	-11.0	-0.24	+0.18
11	Oxalacetate ²⁻ (aq.)	Malate ²⁻ (aq.)		-15.5	-0.33	+0.10
IIIC. C=C—C=O GROUP						
12	Acrolein (l.)	Allyl alcohol (l.)	-19.4			
13	Benzaldehyde (l.)	Benzyl alcohol (l.)	-18.5			
IIID. $\begin{array}{c} \text{O} \\ \\ \text{C—OH} \end{array}$ GROUP						
14a	Formic acid (g.)	Formaldehyde (g.) + water (g.)	+ 2.2	+ 1.9	(+0.04)	(+0.46)
14b	Formic acid (aq.)	Formaldehyde (aq.) + water (l.)		+ 0.4	(+0.01)	(+0.43)
14c	Formate ⁻ (aq.) + H ⁺ aq.	Formaldehyde (aq.) + water (l.)		- 4.7	(-0.10)	(+0.53)
15a	Acetic acid (g.)	Acetaldehyde (g.) + water (g.)		+ 4.7	(+0.10)	(+0.52)
15b	Acetic acid (aq.)	Acetaldehyde (aq.) + water (l.)	+ 4.5	+ 5.9	(+0.12)	(+0.54)
15c	Acetate ⁻ (aq.) + H ⁺ aq.	Acetaldehyde (aq.) + water (l.)	- 4.7	- 0.6	(-0.01)	(+0.62)
IIIE. O=C=O GROUP						
16a	Carbon dioxide (g.)	Formic acid (g.)	+ 5.8	+12.0	(+0.26)	(+0.68)
16b	Carbon dioxide (aq.)	Formic acid (aq.)	- 1.0	+ 6.4	(+0.14)	(+0.56)
16c	Carbon dioxide (aq.)	Formate ⁻ (aq.) + H ⁺ aq.	- 5.7	+11.5	(+0.25)	(+0.46)
16d	Bicarbonate ⁻ (aq.)	Formate ⁻ (aq.) + water (l.)	- 3.6	+ 0.8	(+0.02)	(+0.44)
16e	Carbonate ²⁻ (aq.) + H ⁺ aq.	Formate ⁻ (aq.) + water (l.)	- 7.9	-13.3	(-0.30)	(+0.33)

^a Cf. bibliography on page 245.

^b The sign of the potential is chosen here to coincide with the sign of the change in free energy upon reduction. In European literature, a reverse convention prevails, with positive potentials assigned to strong oxidants, rather than, as here, to strong reductants.

As stated above, the C—O bond is stabilized in the carboxyl group and still more in carbon dioxide. As a result, the energy of hydrogenation of C=O bonds in carboxylic acids and in free carbon dioxide is positive (*cf.* examples 14a, 15b, 16a). Carbon-carbon double bonds also can be stabilized by resonance, which is commonly brought about by a conjugation of several such bonds. The effect on the energy of hydrogenation is illustrated by examples 5, 6 and 7. Conjugation between a C=O and a C=C bond has no marked effect on the hydrogenation energy of the former (*cf.* examples 12 and 13). (A stabilizing effect of this conjugation on the carboxyl group was noticed on page 184.) As a result of resonance stabilization, the molecules C₆H₆ and CO₂ are more difficult to hydrogenate than all other compounds in table 9.IV.

The thermodynamic measure of oxidizing power is the *free energy*, rather than the *total energy* of hydrogenation. Table 9.IV shows that ΔF of hydrogenation by molecular hydrogen usually is more positive than the total energy of the same process, by as much as 5 or 10 kcal, because this reaction is associated with the disappearance of a gas (H₂). Large deviations from this rule may occur in the hydrogenation of *ions* (in system No. 1b, for example, an increase in entropy is caused by the conversion of one divalent ion into two monovalent ions).

Instead of the free energy of hydrogenation, the oxidizing power often is characterized by the oxidation-reduction potential, E_0 . These potentials can be measured directly only for "electrode active" systems, *i. e.*, for compounds which can be reduced or oxidized electrochemically at a reversible electrode. Values measured in this way are shown by italics in table 9.IV. For all other oxidation-reduction systems, the oxidation-reduction potentials can be calculated from the free energy of hydrogenation, ΔF , by means of the relation

$$(9.2) \quad E_0 = \Delta F / 23.06 n \quad (pH = 0)$$

23.06 is the factor which converts electron-volts into kcal/mole, while the factor n ($n = 2$ for all examples in Table 9.IV) is the number of electrons which take part in the transformation.

This may be the appropriate place for a remark on the relation between hydrogenation, oxygenation, and electron transfer in oxidation-reduction reactions. In chapter 3, photosynthesis was described as hydrogen transfer from water to carbon dioxide, and in chapter 5, a similar definition was applied to bacterial photosynthesis. Some bacterial reductants (*e. g.*, sulfur) do not contain any hydrogen, while others (*e. g.*, sulfite) are unlikely to yield it. It is easy to show that electron transfer, combined with acid-base equilibria, is equivalent to hydrogen transfer:



By this combination of elementary processes, it is possible to achieve the hydrogenation of an oxidant even if the reductant is unable to donate hydrogen atoms, for example:

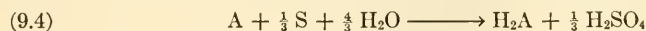
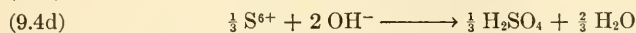
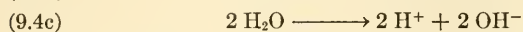
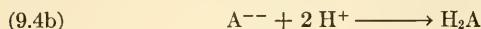
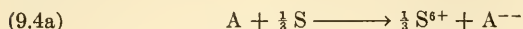

Similarly, the oxidation of sulfite to sulfate can be brought about by the loss of two electrons and addition of two hydroxyl ions.

The transfer of hydroxyl radicals can be brought about by a transfer of electrons and recombination with hydroxyl ions. The exchange of hydrogen atoms for hydroxyl radicals (once postulated by Franck as the primary process in photosynthesis, *cf.* page 151) is equivalent to the simultaneous transfer of *two* electrons, combined with the adjustment of acid-base equilibria:

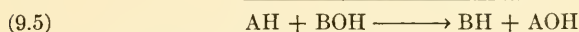
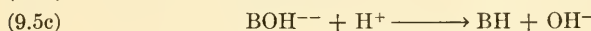
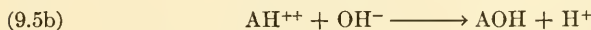
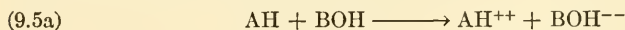

The free energies of reduction, listed in table 9.IV, are based on the conception that reduction is a transfer of *hydrogen atoms*; in cases in which this transfer is coupled with a change in acid dissociation (*e. g.* 14c, 15c, and 16e), the free energy change includes a term corresponding to this dissociation, calculated for standard activity of the hydrogen ions (*i. e.*, for $pH = 0$). The oxidation-reduction potentials, on the other hand, are based on the conception of reduction being primarily a transfer of *electrons*. If this transfer is associated with the addition or loss of hydrogen ions (hydrogenation being interpreted as a transfer of an equal number of electrons and H^+ ions), the normal potentials are dependent on pH . Thus, the potential of a hydrogen electrode ($H_2/2 H^+$) increases, at $25^\circ C.$, by 0.60 volt for each pH unit, and is, in neutral solution ($pH 7$), 0.42 volt higher than at $pH 0$. The potentials of systems whose reduction consists in the addition of hydrogen atoms (without binding or loss of H^+ ions) change with pH in the same way as the potential of the hydrogen electrode. In table 9.IV, the E_0 values have been calculated from the free energies of hydrogenation by means of equation (9.2), and the E_0' values of systems which do not change their acid dissociation upon hydrogenation, by the addition of 0.42 volt to E_0 .

For systems whose hydrogenation involves a change in ionization, the oxidation-reduction potentials increase more (or less) rapidly than the potential of the hydrogen electrode. For example, the potential of system No. 16c increases at the rate of 0.03 volt per pH unit only (because one hydrogen ion is *liberated* upon reduction); while the potentials of the systems carboxyl anion-carbonyl (14c and 15c, Table 9.IV) must increase at the rate of 0.09 volt per pH unit, because one hydrogen ion is *bound* simultaneously with the addition of two hydrogen atoms.

Since most tissues are approximately neutral, the best measure of the oxidizing or reducing power of different agents *in vivo* is given by their potentials at $pH 7$. Thus, we gain an adequate conception of the thermodynamical difficulty of the reduction of carbon dioxide or of the

carboxyl group *in vivo*, by noting that the reduction of bicarbonate to formate, in neutral solution, requires a potential in excess of 0.44 volt, and the reduction of formate to formaldehyde (also in aqueous solution), a potential of at least 0.53 volt.

Of all the systems listed in table 9.IV, only one (benzene-cyclohexadiene) has a more positive potential than the carbonyl-carboxyl system. Thus, a reductant whose reduction creates an aromatic system should be thermodynamically able to reduce bicarbonate or carboxyl even without the help of light.

While C=C and C=O double bond compounds are important in biochemistry as *substrates* of metabolic oxidation-reduction processes, other systems are of greater importance as intermediary oxidation-reduction *catalysts*, for example, the quinonoid-benzenoid systems, the pyridine-pyridinium systems, the sulfhydryl-sulfide systems and the ferri-ferro complex systems.

The property which makes all these compounds catalytically active, is their capacity for *reversible* reduction (or oxidation), *i. e.* their property of being reduced (or oxidized) at room temperature by any other (equally reversible) reductant (or oxidant) of more positive (or more negative) potential. This reversibility is often associated with *electrode activity*, *i. e.*, capacity of being oxidized (or reduced) by an inert electrode of appropriate potential.

Much confusion is caused by the twofold use of the term "reversibility." In addition to its use in the sense defined above, the adjective "reversible" is often used to mean that a reaction can actually be made to proceed in both directions. In the first sense, reversibility is a kinetic term (meaning absence of a large *activation energy*); in the second sense, it is a static term, meaning that the *free energy* of a reaction is so small that a moderate change in temperature or concentration, is sufficient to cause it to change its sign. Catalysts can improve kinetic reversibility, but cannot affect the static reversibility.

In the quinonoid-benzenoid systems, the reductant (*e. g.*, hydroquinone) has an aromatic structure, while the oxidant (*e. g.* benzoquinone) is stabilized by a different

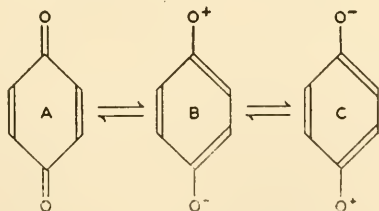

type of resonance, (which accounts for the dyestuff character of quinonoid compounds, *cf.* Vol. II, Chapter 21, and is illustrated by the structures A, B, and C).

The "aromatic" stabilization of the reductant (hydroquinone) tends to make quinones strong oxidants, but the efficient resonance stabilization of the oxidant (quinone) counteracts this tendency and allows the potential to increase, from -0.36 volt for *o*-benzoquinone to as much as $+0.39$ volt for rosindone sulfonate.

Biocatalysts of the dye-leuco dye type have potentials up to $+0.18$ volt (riboflavin). However, the potential of the latter compound decreases considerably when it is associated with a protein, as in the "yellow ferment" ($E_0' = +0.06$ volt).

The action of oxidation-reduction biocatalysts derived from *pyridine* ("pyridinium nucleotides") is based on the transition:

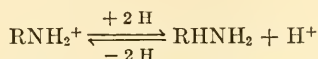

They have potentials in the region of $+0.25$ to $+0.30$ volt (at $\text{pH } 7$). Similar systems based on the oxidation of the *sulfhydryl group* ($\text{RS-SR} \xrightleftharpoons[-2\text{H}]{+2\text{H}} 2\text{RSH}$) may have potentials up to $+0.35$ and $+0.40$ volt (*e. g.* cysteine-cystine).

The normal potentials of systems based on the conversion of ferrous iron into ferric iron depend on the relative stabilization of the oxidant and reductant by complex formation. They are as low as -0.77 for nonassociated ions, and as high as $+0.24$ volt for the system ferriheme-ferroheme, with hemoglobin and cytochrome *c* midway between these two extremes ($E_0' = -0.21$ and -0.26 volt, respectively). No complex iron compounds are known which are thermodynamically capable of reducing carbon dioxide or carboxyl group in a neutral medium.

In chapter 6, mention was made of *hydrogenase*, an enzyme capable of reacting reversibly with molecular hydrogen. The potential of this enzyme must be close to that of the hydrogen electrode at $\text{pH } 7$, that is, $+0.42$ volt. Its chemical nature is as yet unknown. Its potential, although considerably higher than that of all known respiratory catalysts, is still hardly sufficient to reduce directly either carbon dioxide or a carboxyl group.

To sum up: in looking for a reductant which could serve for a non-photochemical reduction of carbon dioxide or of a carboxylic acid *in vivo*, we find ourselves facing the same difficulty as we did in chapter 8, when searching for an appropriate acceptor for carbon dioxide: All compounds which are likely to occur in the cells appear thermodynamically incapable of performing the desired function.

4. Formation of Carboxyl Groups in Respiration. The Role of Phosphorylation

In the case of decarboxylation, we found that the least difficult to reverse are the biological decarboxylations which form a part of the respiration mechanism, particularly that of oxalacetic acid. It may be of interest to look again at the mechanism of respiration and to inquire whether in this process the formation of carboxyl groups by the oxidation of carbonyl groups also approaches the ideal of reversibility. We may do this by considering schemes 9.I and 9.II, which represent one of the several mechanisms of aerobic glucose metabolism in the muscle.

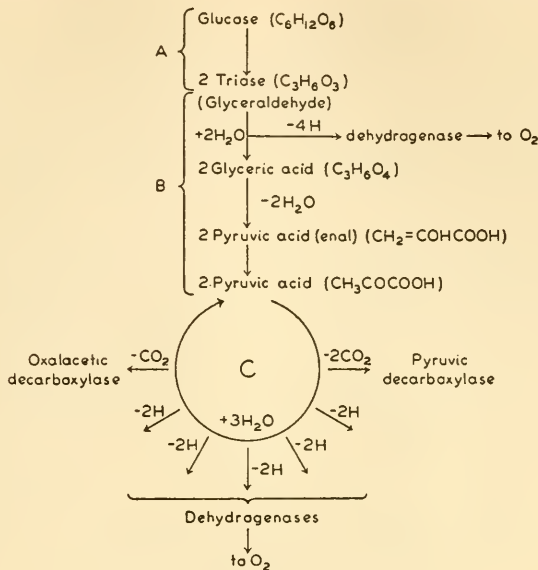

Scheme 9.I.—Respiration mechanism.

Net reaction: $\text{C}_6\text{H}_{12}\text{O}_6 + 3 \text{H}_2\text{O} \longrightarrow 3 \text{CO}_2 + 14 \text{H} + \text{C}_3\text{H}_4\text{O}_3$ (pyruvic acid).

In stage *A* of scheme 9.I, a hexose molecule is split into two molecules of a triose, which, in stage *B*, are oxidized to two molecules of pyruvic acid (via glyceric acid and enol-pyruvic acid). In stage *C*, a transformation of two molecules of pyruvic acid leads to the regeneration of one of them, and the disintegration of the other one into three carbon dioxide molecules (liberated through the intermediary of specific “decarboxylases”) and ten hydrogen atoms, which are transferred through specific “dehydrogenases” to oxygen as the final acceptor.

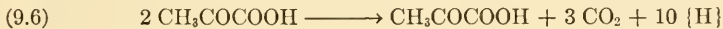

Not all details of cycle *C* have been worked out, and they may possibly vary from case to case; but scheme 9.II gives a simplified form of this cycle (based on suggestions by Thunberg).

According to schemes 9.I and 9.II, carboxyl groups are created in respiration by the oxidation of glycerinaldehyde to glyceric acid, and of acetaldehyde to acetic acid. The potentials of these carbonyl-carboxyl systems in neutral solution lie, according to table 9.IV, between + 0.5 and + 0.6 volt. The “dehydrogenases,” which accept the hydrogen atoms from glycerinaldehyde and acetaldehyde, are pyridinium nucleotides, whose potentials lie between + 0.2 and + 0.3 volt. Thus, the hydrogen transfer from the aldehydes to the dehydrogenases should liberate a considerable amount of free energy, and thus be practically irreversible.

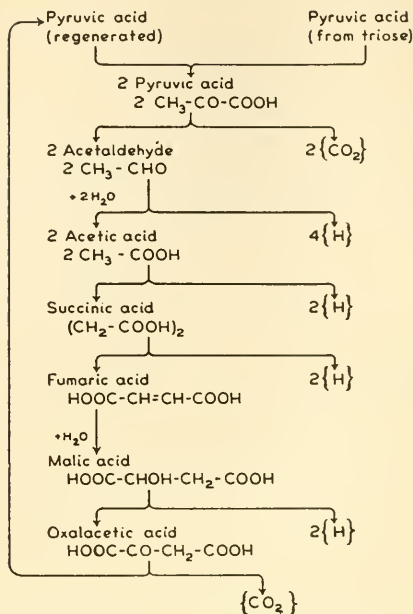

Scheme 9.II.—The C_4 -dibasic acid cycle (net reaction 9.6).

However, nature has found a way of conducting these two oxidations without a dissipation of energy—by coupling them with endergonic *phosphorylations* (*i. e.*, transfers of phosphoric acid from orthophosphate to an “energy rich” organic phosphate), or *transphosphorylations* (*i. e.*, transfers of phosphate from a low energy organic ester to a “high-energy” ester).

The effect of phosphorylation is to destroy the resonance which stabilizes the carboxyl group and thus to make its hydrogenation easier. *Carboxyl phosphates* belong to the “high-energy organic phosphates” which play an important role in the energy balance of many biochemical processes (*cf.* the reviews by Kalckar 1941, and Lipmann 1941). The hydrolysis of these esters liberates about 10 kcal per mole (while the hydrolysis of “low-energy” phosphates has a heat effect close to zero). *Carbonyl phosphates*, on the other hand, must be “normal” (since no resonance energy is gained by their hydrolysis); therefore, the reduction of a carboxyl phosphate to a carbonyl phosphate:

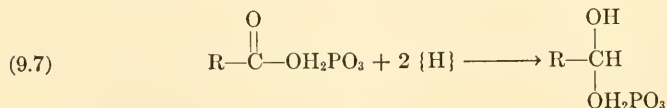

should require 10 kcal less total energy than the hydrogenation of a

free carboxyl to a free carbonyl. A corresponding difference probably exists also in the free energies of hydrogenation, with the consequence that the oxidation-reduction potentials of carboxyl phosphates must be more positive (probably by about 0.2 volt) than those of the corresponding free acids; this brings them into the region of +0.3 to +0.4 volt, and makes the reversal of their reactions with pyridine nucleotides or similar catalysts feasible.

It was shown by Meyerhof, Warburg, and coworkers that, in consequence of the phosphorylation of glyceraldehyde, practically all the free energy of its oxidation by pyridine nucleotide is retained in the oxidation product (enol-phosphopyruvate); and Lipmann has demonstrated a similar effect of phosphorylation on the transformation of pyruvic acid into carbon dioxide and acetic acid. Thus, both reactions by which carboxyls are created in schemes 9.I and 9.II can occur without energy dissipation, the oxidation energy being "stored" in the phosphorylated oxidation products.

The main purpose of this storage is to make possible the utilization of the oxidation energy by the contractile system. This is achieved by a transfer of phosphate from the oxidation product (*e. g.*, enol-phosphopyruvate) to adenosine diphosphate; the adenosine triphosphate formed by this transphosphorylation is decomposed back into adenosine diphosphate and free orthophosphate by interaction with myosin (the protein of the muscle); in this process the stored energy is released and converted partly into heat and partly into mechanical work. Since both the oxidation and the transphosphorylation are reversible, the net rate of these processes is regulated by the rate of the terminal, exergonic, myosin-catalyzed dephosphorylation; in this way, the rate of respiration is accelerated or slowed down depending on the amount of work performed by the muscle.

Only 30–35 kcal out of the 330 kcal combustion energy available in a triose are stored in the three high-energy phosphate molecules created in the two oxidation steps considered above. The other 90% are liberated in subsequent reaction steps, that is, according to scheme 9.II, in the dehydrogenation of succinic, fumaric, and malic acid by their specific dehydrogenases, and in the transfer of 12 hydrogen atoms from the dehydrogenases to oxygen, through the intermediary of alloxazine derivatives (yellow enzymes), hemin derivatives (cytochromes), and other reversible oxidation-reduction catalysts. Some of these processes may also be coupled with phosphorylations or transphosphorylations, and their energy made available in this way for muscular work. Indications of this coupling have been found, for instance, in the study of the oxidation of succinate to fumarate (which is a step in respiration). According to table 9.IV, the potential of the succinate–fumarate system is ± 0.0

volt; the succinate dehydrogenase transfers the hydrogen from succinate to cytochrome *c*, whose potential is much higher—namely, + 0.27 volt. The energy liberated in this transfer could well be used for the synthesis of one molecule of a high-energy phosphate.

In the respiration of dialyzed muscle extracts, five or six glucose molecules were found to be phosphorylated to diphosphates simultaneously with the oxidation of one glucose molecule to carbon dioxide. This indicates (Kalckar 1941) that ten, and perhaps all twelve hydrogen transfers to dehydrogenases, which occur in the oxidation of one glucose molecule ($C_6H_{12}O_6 + 6 H_2O + 12 E_D \longrightarrow 6 CO_2 + 12 H_2E_D$, where E_D = dehydrogenase), are associated with the production of one high-energy phosphate ester (glucose serves, in these experiments, as the final "phosphate acceptor," by taking phosphate over from the adenosine triphosphate).

In this way, as much as 20–25% of the combustion energy of glucose could be converted into phosphate energy, to be utilized for muscular work. The remaining 75–80% is liberated in the downward slide of the hydrogen atoms from reduced dehydrogenases (whose potentials lie between + 0.3 and 0 volt) to oxygen (whose potential at pH 7 is – 0.81 volt). Some evidence speaks in favor of phosphorylations also being associated with these stages of respiration (in which the largest part of the combustion energy is liberated), but the nature and extent of these phosphorylations is as yet unknown.

5. Phosphorylation and Photosynthesis

We found, in the preceding section, that phosphorylation permits the oxidation of carbonyl groups to carboxyl groups without dissipation of energy (and may have the same effect also on other steps in the transfer of hydrogen from sugars to oxygen). Thus, phosphorylation could help in bringing about the reversal of respiration in photosynthesis. The possible role of phosphoric acid in photosynthesis (and chemosynthesis) was mentioned twice before: in chapter 8, in discussing the mechanism of *preliminary carbon dioxide fixation in photosynthesis*; and in chapter 5 (page 114), in discussing the mechanism of *chemosynthesis in Thiobacillus thiooxidans*. We shall now see that phosphorylation could also be used in the interpretation of the *carbon dioxide reduction in photosynthesis*. This was first suggested by Ruben (1943), who thought that the carboxyl group in the complex $\{CO_2\}$ may be phosphorylated to facilitate its reduction. According to this hypothesis, the reductants, $\{H\}$ or HX , produced by the primary photochemical process (*cf.* Chapter 7) have reduction potentials of the order of those of the pyridinium nucleotides (*i. e.*, about + 0.3 volt), and are thus unable to reduce free carboxyl groups, but may be able to reduce carboxyl *phosphates*.

Ruben suggested that the high-energy phosphates required for the phosphorylation of $\{\text{CO}_2\}$ may be synthesized with the help of light energy. Since not more than four out of eight or ten primary photochemical oxidation products ($\{\text{OH}\}$ or Z) are utilized for the production of oxygen, Ruben thought that the remaining ones may be utilized for exergonic oxidation-reduction reactions (*e. g.*, a direct or indirect recombination with the primary reduction products, $\{\text{H}\}$ or HX) which are coupled with the synthesis of high-energy phosphate esters.

However, it is also possible that the high-energy phosphates used for the phosphorylation of $\{\text{CO}_2\}$ are produced, without the help of light, by oxidative metabolic reactions. (In other words, some of the combustion energy of the products of photosynthesis may be borrowed in advance to make photosynthesis possible.)

Whether the high energy phosphates are synthesized at the cost of light energy or oxidation energy, their role in photosynthesis, according to Ruben, is a subsidiary one—to assist in two thermodynamically difficult steps: in the carboxylation of an acceptor and in the reduction of a carboxyl group to a carbonyl group. One could, however, also attribute to the phosphorylation a more fundamental importance, in analogy with the expansion of the phosphorylation theory of respiration (page 226). One may assume that *all* light quanta utilized in photosynthesis (and all oxidation energy utilized in chemosynthesis) are first converted into the energy of unstable phosphates, and that the transfer of hydrogen from water to the $\{\text{CO}_2\}$ complex occurs by a sequence of easy steps, each requiring not more than 10 kcal, and made possible by a coupling, with the degradation, of these phosphates. Such a theory was suggested recently by Emerson, Stauffer, and Umbreit (1944). They attempted to support it by an experimental investigation of the phosphorus metabolism of *Chlorella*, which leads to the following results:

1. *Chlorella* cells are capable of utilizing phosphorylated compounds for respiration in the dark.

2. Dried *Chlorella* cells can be used for the preparation of a "Lebedev juice" which will catalyze the esterification of inorganic phosphate (in the presence of glucose, fluoride and pyruvate).

3. The phosphorylated compounds contained in *Chlorella* appear to be different from those which commonly occur in animal and most bacterial cells.

4. A 90-minute illumination of *Chlorella*, in the presence as well as in the absence of carbon dioxide, does not change appreciably the relative contents of inorganic and organic phosphorus in the cells.

5. A significant change can be noted in the composition of the fraction of organic phosphate which is precipitable by barium. (In other materials, this fraction was found to contain adenosine triphosphate,

adenosine diphosphate, phosphoglyceric acid, phytic acid, hexose diphosphate and inorganic phosphate.) This fraction was divided, by a seven-minute hydrolysis, into a "labile" and a "resistant" part. In the absence of carbon dioxide, the relative amount of "resistant" phosphorus was large in the dark, but decreased upon illumination (*e. g.*, from 38% to 10% of the total phosphorus content). In the presence of carbon dioxide the change was in the opposite direction, *e. g.*, from 10% "resistant" phosphorus in the dark to 23% in light.

The results under 1 and 2 prove that *Chlorella* does have a phosphorus metabolism—which is almost a trivial result, in consideration of the universal participation of phosphates in the metabolism of most if not all organisms. The results under 3 indicate, however, that the paths of the phosphorus metabolism of *Chlorella* may be significantly different from that of the animal tissues and bacteria.

The result under 4 represents a failure to prove a photochemical conversion of inorganic into organic phosphate. (It was hoped that, in the absence of carbon dioxide, at least, high energy phosphates would accumulate in light to an extent sufficient for analytical identification.)

The results under 5 show that carbon dioxide has an influence on the composition of the organic phosphorus compounds in *Chlorella* in the dark, and that this composition is further affected by illumination—the direction of the change being different in the absence and in the presence of carbon dioxide.

Although these results are interesting as first steps towards the investigation of the phosphorus metabolism of *Chlorella*, they obviously do not represent effective arguments in favor of the "phosphate storage" hypothesis of photosynthesis. Until more positive evidence is provided, we are inclined to consider as more convincing a general argument against this hypothesis, which can be derived from energy considerations. Photosynthesis is eminently a problem of energy *accumulation*. What good can be served, then, by converting light quanta (even those of red light, which amount to about 43 kcal per einstein) into "phosphate quanta" of only 10 kcal per mole? This appears to be a start in the wrong direction—toward *dissipation* rather than toward accumulation of energy.

The difficulty of the phosphate storage theory appears most clearly when one considers the fact that, in weak light, eight or ten quanta of light are sufficient to reduce one molecule of carbon dioxide (*cf.* Vol. II, Chapter 29). If each quantum would produce one molecule of high-energy phosphate, the accumulated energy would be only 80–100 kcal per einstein—while photosynthesis requires *at least* 112 kcal per mole, and probably more, because of losses in irreversible partial reactions. Of course, one light quantum contains enough energy to produce *two* (or more) molecules of high-energy phosphate—but this result is unlikely to

be achieved if phosphorylation is the primary photochemical process, as postulated by Umbreit and coworkers.

The phosphate storage hypothesis appears somewhat less improbable when applied to *chemosynthesis*. One may assume that the oxidation of hydrogen, sulfur, ferrous iron or other substrates by oxygen proceeds in easy steps (as in the oxidation of glucose in the muscle), each step being coupled with the production of a high-energy phosphate, and that the energy of these phosphates is utilized later to transfer hydrogen, by similar easy steps, from water to carbon dioxide. In the case of reductants as mild as ferrous ions, the free energy of oxidation of one gram atom is just about sufficient to produce one mole of high-energy phosphate, so that, in this case, the "phosphate storage" would involve no dissipation of the oxidation energy.

However, the metabolism of "iron bacteria" is not well known, and in the better investigated cases of hydrogen, sulfur or thiosulfate bacteria, the reductants have comparatively high potentials, and the intermediate dissipation of their oxidation energy in the form of "phosphate quanta" of 10 kcal each appears implausible.

The experiments of Vogler (1942) on the "delayed" carbon dioxide uptake by *Thiobacillus thiooxidans* (cf. page 114) provide the only experimental argument favoring the phosphate storage theory of chemosynthesis. However, it was mentioned on page 114 that the carbon dioxide uptake in Vogler's experiments may well be a reversible *fixation* of this gas (e. g., by carboxylation) rather than a *reduction* to a carbohydrate.

To sum up: we think it unlikely that the bulk of the light energy utilized in photosynthesis (or of the oxidation energy utilized in chemosynthesis) is first converted into phosphate energy. Furthermore, if phosphorylation does play an auxiliary role in photosynthesis (e. g., in the way envisaged by Ruben)—which is by no means certain—we think it much more probable that the required high-energy phosphates are supplied by nonphotochemical oxidation processes than that light quanta are diverted for their synthesis.

6. The Thermodynamics of Free Radicals

In the preceding section, we reached the conclusion that the primary photochemical reduction products, HX, probably serve directly for the reduction of the $\{\text{CO}_2\}$ complex, and that the chemosynthetic reductants (hydrogen, sulfur, hydrogen sulfide, thiosulfate, etc.) can be assumed to produce, in the course of their oxidation, reducing agents similar to, or identical with, HX. The example of the strongest catalytic reductants in the respiration mechanism—pyridinium nucleotides—caused Ruben to suggest that HX has a reduction potential $\leq +0.3$ volt, and that, therefore, a phosphorylation is required to enable it to reduce the car-

boxyl group in the complex $\{\text{CO}_2\}$. However, the reason why no auxiliary oxidation-reduction systems more positive than the pyridinium nucleotides occur in respiration may be that none are required, and there is no reason why HX (or its transformation products) could not be much stronger reductants, able to reduce carboxyl groups even without the assistance of phosphates. It was found above that no quinoid-benzenoid or ferri-ferro system is likely to have the required high potential. Systems of the type of hexadiene-benzene, while sufficiently positive (*cf.* page 221), are unlikely to be reversible (in the kinetic sense). A possibility worth considering is that HX may be a *free radical*, since the oxidation-reduction potentials of free radicals vary over a much wider range than those of the saturated systems considered on pages 217-222.

According to the standard bond strengths, the energies of free radicals should be so high that two of them could not be formed by the action of a single quantum of red light. For example, the transfer of a hydrogen

atom from a $\text{HC}-\text{CH}$ group to a $\text{C}=\text{C}$ double bond, leading to two $\text{HC}-\dot{\text{C}}$ radicals (the arrow representing a free valency) should

require 62 kcal, and a transfer of a hydrogen atom from a $\begin{array}{c} \diagup \\ \text{C}-\text{OH} \\ \text{H} \end{array}$

group to a $\begin{array}{c} \diagup \\ \text{C}=\text{O} \end{array}$ group, forming two $\begin{array}{c} \diagup \\ \text{C}-\text{OH} \\ \downarrow \end{array}$ radicals, should

consume as much as 75 kcal, while only 40-45 kcal are available in a quantum of red light. This energy should be liberated again in the dis-

mutation of two $\begin{array}{c} | \\ -\text{C}-\text{C}- \\ \text{H} \quad \downarrow \end{array}$ or $\begin{array}{c} | \\ -\text{C}-\text{OH} \\ \downarrow \end{array}$ radicals to saturated molecules.

Free radicals should be violent oxidants and strong reductants at the

same time. The standard energy of hydrogenation of a $\begin{array}{c} | \\ -\text{C}-\text{C}- \\ \text{H} \quad \downarrow \end{array}$ or

$\begin{array}{c} | \\ -\text{C}-\text{OH} \\ \downarrow \end{array}$ is -46 kcal, and the corresponding oxidation-reduction poten-

tial can be estimated to $E_0 \sim -1.5$ volt or $E_0' (p\text{H } 7) \simeq -1.1$ volt.

The standard energy of *dehydrogenation* of a $\begin{array}{c} | \\ -\text{C}-\dot{\text{C}}- \\ \text{H} \quad \downarrow \end{array}$ radical is -16

kcal, corresponding to a potential of about +0.7 volt at $p\text{H } 0$, or +1.1

volt at $p\text{H } 7$; while the dehydrogenation of an $\begin{array}{c} | \\ -\text{C}-\text{OH} \\ \downarrow \end{array}$ radical should

liberate 29 kcal, corresponding to an E_0 value of about + 1.3 volt, and an E_0' value as high as + 1.7 volt.

In the two-step hydrogenation of $C=C$ to $\begin{array}{c} | & | \\ -CH- & -CH- \end{array}$, or of $\begin{array}{c} | \\ -C=O \end{array}$ to $\begin{array}{c} | \\ -CHOH \end{array}$, the first step—the formation of a free radical—should consume 16 and 25 kcal, respectively, while the second step should liberate 46 kcal (the sums of the two steps being - 30 and - 17 kcal, respectively; cf. page 217). These estimates, derived from standard bond strengths, may be approximately correct for simple radicals whose energies are not strongly affected by resonance; but may be far off the mark for radicals of a more complex structure.

The general tendency in reaction kinetics is to resolve chemical reactions into steps involving the transfer of only *one* simple particle (electron, proton, or hydrogen atom). Michaelis suggested that hydrogenations and dehydrogenations of organic compounds take place in single steps, with one hydrogen atom (or one electron) transferred at a time. This mechanism would be impossible (except at high temperatures) if free radicals had the high energies calculated from standard bond strengths. Probably, prohibitively high energies of radicals derived from simple organic molecules (*e. g.*, $O=C-OH$ or $HO-CHOH$) are the reason why the corresponding saturated molecules (*e. g.*, CO_2 or H_2CO_2) cannot be reduced or oxidized reversibly at an electrode with an appropriately adjusted potential.

Reversible oxidation-reduction systems, on the other hand, have been found to form comparatively stable free radicals, whose occurrence can be proved by kinetic observations (two color changes, and transitory paramagnetism during oxidation), as well as by equilibrium measurements (analysis of the potentiometric titration curves).

The formation of free radicals in oxidation-reduction processes was discovered in 1931 by Friedheim and Michaelis, and by Elema, working with the same bacterial dyestuff, pyocyanine. Further investigations, mainly by Michaelis and coworkers (for reviews see Michaelis 1935, 1938, 1940; Michaelis and Schubert 1938) led to the realization that most, perhaps all, organic systems, both synthetic and natural, capable of (kinetically) reversible oxidation-reduction, form comparatively stable intermediate radicals, called *semiquinones*.

The equilibrium concentration of a semiquinone depends on its constant of dismutation K_d :

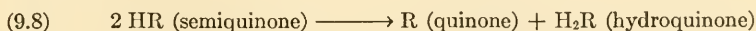

$$(9.9) \quad K_d = \frac{[\text{R}][\text{H}_2\text{R}]}{[\text{HR}]^2}$$

If the free energy of dismutation is ΔF_d , the constant of dismutation is:

$$(9.10) \quad \log K_d = - \Delta F_d / 2.3 RT$$

and is related to the single-step oxidation potentials E_1 (semiquinone-hydroquinone) and E_2 (quinone-semiquinone) by the equation:

$$(9.9) \quad \log K_d = 16.67 (E_1 - E_2) \quad (t = 25^\circ \text{C.})$$

If $E_1 = E_2$, $K_d = 1$; that is, when one-third of the compound is in the reduced state, one-third is in the intermediate state and one-third in the oxidized state. If $E_1 < E_2$ (*i. e.*, the quinone is a stronger oxidizing agent than the semiquinone), $K_d < 1$, and the equilibrium proportion of the semiquinone is more than one-third. If $E_1 > E_2$, $K_d > 1$, and the maximum proportion of the semiquinone is less than one-third.

The presence of a semiquinone can be observed by Michaelis' methods, if it forms at least 10% of the total dyestuff. In this case, the dismutation constant, K_d must be ≤ 20 and the free energy of dismutation must be $\leq \sim 1.8$ kcal at room temperature. In other words, whenever the presence of semiquinones is recognizable at equilibrium, the difference between the free energies of the first and second reduction step is less than 2 kcal, instead of about 50 kcal as deduced above from the standard bond strengths.

An explanation of the stability of semiquinones on the basis of the resonance theory has been attempted by Pauling and Wheland (1933) and Wheland (1940), who suggested that radicals are stabilized by a resonance made possible by the unsaturated valency. In the triphenyl methyl radical, for example, the structure usually assumed, Ph_3C is

↓
 supplemented by a number of other "resonating" structures, including the *o*-quinonoid forms, $\text{Ph}_2\text{C}=\langle \text{hexagon} \rangle \rightarrow$ and the *p*-quinonoid forms,

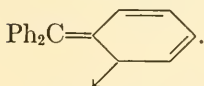

As mentioned before, the pairs, carbonate-formate, acetaldehyde-acetic acid, etc.—do not form electrode-active oxidation-reduction systems, probably because their "semiquinones" are not stabilized by resonance; the association with oxidation-reduction enzymes may stabilize these semiquinones and thus reduce the activation energy of the corresponding reactions.

To enable an oxidation-reduction to proceed smoothly at room temperature, it is sufficient for the energy of the semiquinone to be not larger than 10 kcal; this is compatible with a dismutation constant as high as 10^8 . Thus, a practically negligible equilibrium concentration of the semiquinone may be sufficient to bring about the desired catalytic effect.

The inclusion of free radicals enlarges the list of reversible oxidation-reduction systems, in both directions, beyond the interval from -0.4 to $+0.4$ volt (at *pH* 7), which is covered by valence-saturated organic compounds. Among "monovalent" organic systems, whose potentials have been measured, we find, for example, the porphyraxide, with a potential of -0.73 volt at *pH* 7 (here, the *oxidant* is a free radical) and

the viologens, whose potentials (independent of pH) are as high as $+0.44$ volt (in this case, the *reductants* are free radicals).

7. Free Radicals in Photosynthesis and Chemosynthesis

The realization of the wide range of stability of free radicals has several consequences for the mechanism of photosynthesis. *In the first place*, it shows that there is no need to avoid free radicals as intermediates in setting up reaction mechanisms (as was once thought by Franck, Herzfeld, and Stoll), provided they have a structure which permits an adequate resonance stabilization (one of the consequences of the formation of the complex, $\{CO_2\}$, may be such an improvement in the stability of the intermediate radicals).

In the second place, if free radicals are formed in the primary photochemical process (and the intermediate reductant, HX , as well as the intermediary oxidant, Z , postulated in 7.10a, probably are free radicals, because they are formed by the action of single light quanta), their energy will not necessarily be lost by conversion into saturated compounds. Let us consider, as an illustration, the thionine-ferrous iron reaction (*cf.* Eqs. 7.9). The first product of the light reaction is the radical, semithionine. At pH 3, the free energy of reduction of thionine by ferrous ions to semithionine is about $+15$ kcal, whereas that of dismutation is approximately -3 kcal (estimated from potentiometric data; *cf.* Michaelis, Schubert, and Granick 1940; Granick, Michaelis, and Schubert 1940; and Michaelis and Granick 1941). Thus, in the formation of one molecule of leuco thionine, by the cooperation of two light quanta, according to the mechanism (7.9), as much as 80% of the energy accumulated in the primary reaction is retained in the valence-saturated product.

It is thus possible that the first transformation of the primary photochemical reduction product, HX , is a dismutation into H_2X and X , and that only a comparatively small amount of energy is lost in this process, so that the reducing power of the saturated intermediate, H_2X , is not much less than that of the radical, HX .

However, what we were after in introducing free radicals into the chemistry of photosynthesis was a reductant with a potential *higher* than that of any valence-saturated system, and by assuming dismutation as the fate of the primary product, HX , we have lost this advantage. To regain it, one may assume that the radical, HX , is used *directly* for the reduction of $\{CO_2\}$ without preliminary dismutation, but more interesting appears to be a mechanism in which a second catalytic system, $Y-H_2Y$, is inserted between the systems $Z-HZ$ and $X-H_2X$ (*cf.* Scheme 7.I) because this mechanism opens a way for the utilization of the energy of *two* quanta for the formation of *one* radical, and thus for a new explanation of

how eight quanta can be utilized in photosynthesis for the reduction of one molecule of carbon dioxide. In chapter 7, two alternative hypotheses were suggested for the mechanism by which eight quanta could be used to move four hydrogen atoms from water to carbon dioxide: a twice repeated photochemical activation of the same four hydrogen atoms (as in Schemes 7.V and 7.VA); and the transfer of energy, initially conferred upon *eight* hydrogen atoms, to four of them, as illustrated by equation system (7.14) and scheme 7.VI. The introduction of a second intermediate system, $Y-H_2Y$, between the systems $H-H_2X$ and $Z-HZ$, permits an interpretation of the second alternative. For this, we have to assume that the *average* oxidation-reduction potential of system $Y-H_2Y$ is not very different from that of system $X-H_2X$, thus making reaction (9.10c), possible, but that the radical HX is much less stable than the radical HY thus making possible the "energy dismutation" by reactions (9.10d) and (9.10e):

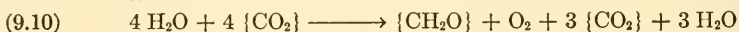
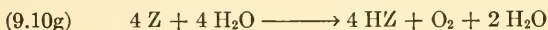
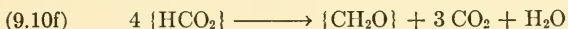
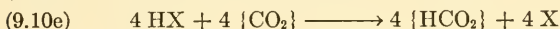
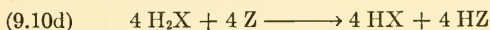
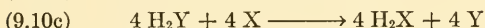
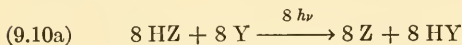

Reaction mechanism (9.10), represented in scheme 9.III, provides the desired elaboration of the hypothesis of "energy dismutation" (*cf.* equations 7.14, and Scheme 7.VI). The "coupled" reaction (7.14b), by which the "energy dismutation" was originally represented, is dissolved in (9.10), into the reaction sequence (9.10b, c, d, e), marked by double arrows in scheme 9.III. It is based on the assumption that the removal of one hydrogen atom from the intermediate H_2X by recombination with the oxidation intermediate, Z , leaves a radical, (semiquinone) HX , which is sufficiently unstable to react with the carboxyl group in $\{CO_2\}$. The radicals HY are produced by single quanta of light, but *two* quanta must cooperate to produce a single radical HX .

As mentioned on page 166, the "energy dismutation" theory is supported mainly by the analogy between the photosynthesis of green plants and the chemosynthesis of hydrogen bacteria, for which it offers a simple explanation.

To give this explanation, it is sufficient to assume that, in organisms which contain an active hydrogenase and an active oxidase, the system $X-H_2X$ can be hydrogenated by molecular hydrogen, and "half-oxidized"

by molecular oxygen so that, in these organisms, the HX radicals can be formed without the help of light.

It was pointed out once before that the interpretation of chemosynthesis leads to a problem of *energy accumulation* similar to that arising in photosynthesis, because the energy liberated by the oxidation

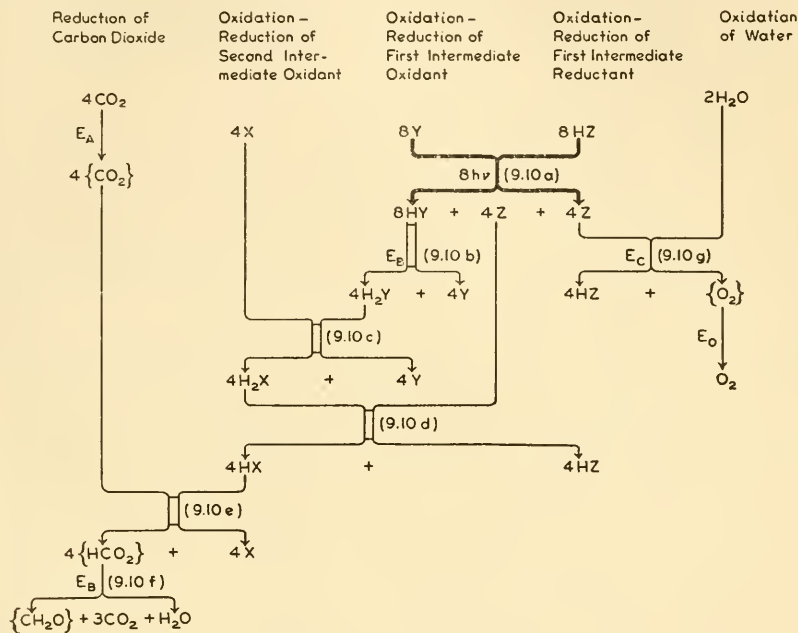

Scheme 9.III.—Photosynthesis according to reaction system (9.10) (according to chapter 19, page 552, HZ may stand for chlorophyll and Z for oxidized, *e. g.*, dehydrogenated, chlorophyll).

of several substrate molecules, has to be used for the reduction of one molecule of carbon dioxide. The hypothesis of “energy dismutation,” achieved by a coupled oxidation of the intermediate H₂X by oxygen and carbon dioxide, is intended to provide an answer to this problem.

The coupling between oxidative and reductive processes in autotrophic organisms has often been oversimplified. The oxidation processes were supposed to run to completion, and the liberated energy was assumed to be available for the chemically independent reduction of carbon dioxide by water. This picture may be used for calculating thermodynamic efficiencies (*cf.* Table 5.VII), but it does *not* represent the real mechanism of chemosynthesis. A pure “energy coupling” of two independent chemical reactions is impossible in the living cell. The explosion of a detonator may create a local temperature sufficient for the ignition of a charge of explosives; but no “heating” by the enzymatic combustion of

hydrogen or sulfur can create local conditions under which a spontaneous reaction between carbon dioxide and water becomes possible. Therefore, a true chemical coupling between autoxidation (e. g., $2 \text{H}_2 + \text{O}_2$) and oxidoreduction (e. g., $2 \text{H}_2 + \text{CO}_2$) must exist, that is, at a certain stage of the autoxidation intermediate products of high energy must be formed which can react with carbon dioxide and thus cause a "branching" of the reaction chain—one part of hydrogen being accepted by oxygen and another by carbon dioxide. Our suggestion is that this branching occurs in the oxidation of the intermediate H_2X .

The highest ratio between the rates of autotrophic reduction of carbon dioxide and of autoxidation is found when hydrogen serves as a reductant. According to Ruhland (1924), one molecule of hydrogen is utilized by *Bacillus pycnoticus* for the reduction of carbon dioxide for every 2.5 hydrogen molecules oxidized to water (cf. page 120). Gaffron (1944) concluded, from experiments on adapted algae, that the limiting value of this ratio is 2 (cf. page 140). In other words, out of twelve hydrogen atoms which enter into the enzymatic apparatus, four are "promoted" and react with carbon dioxide, while eight are "degraded" by union with oxygen. Similarly, in photosynthesis, according to reactions (7.14) and (9.10), eight reduction products HX are formed, and four of them are reoxidized by the oxidation products, Z , while the other four are "promoted" so as to be able to react with carbon dioxide. We may thus try to use scheme 9.III for the interpretation of chemosynthesis with hydrogen as a reductant by substituting molecular hydrogen for H_2Y as a hydrogen donor, and molecular oxygen for Z as the "promoting" oxidant. This leads to the following mechanism:

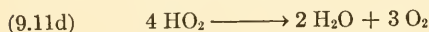
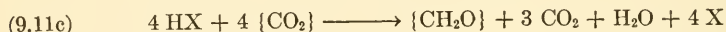
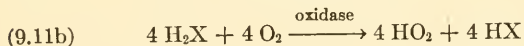
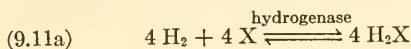

Reaction scheme (9.11) implies, in analogy to (9.10), a "half and half" split of hydrogen between the two oxidants (CO_2 and O_2) corresponding to a ratio of 4 for $\Delta\text{H}_2 : \Delta\text{O}_2$, while the largest experimental value of this ratio is 3. This difference can be explained in several ways, for instance, by the assumption that the radical HO_2 does not undergo a "double dismutation" into water and oxygen, as postulated in (9.11d), but is first reduced by hydrogen (through the intermediary of H_2Y) to a peroxide and then undergoes a single dismutation:

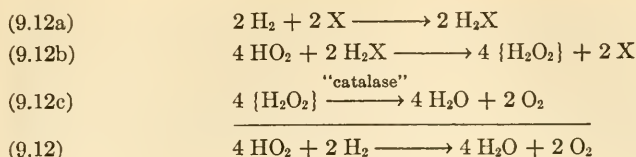

Alternatively, it may be first dismuted to oxygen and a peroxide and then reduced:

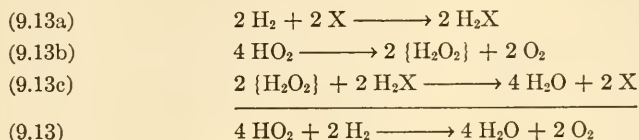

If we substitute (9.12) or (9.13) for (9.11), the over-all reaction of chemosynthesis becomes:

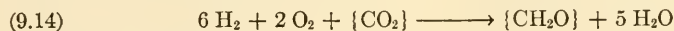

with the correct ratio $\Delta\text{H}_2 : \Delta\text{O}_2 = 3$.

Reaction (9.11), with the variation (9.12), is represented in scheme 9.IVA, whose similarity to scheme 9.III is easily recognizable.

Another possible explanation of the relation, $\Delta\text{H}_2 : \Delta\text{O}_2 > 2$, is that not all HX radicals react with $\{\text{CO}_2\}$, as assumed in (9.11c), but that some are lost by autoxidation:



or by dismutation:

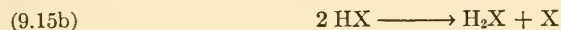

Finally, we can explain the ratio, $\Delta\text{H}_2 : \Delta\text{O}_2 = 3$ also by recalling the conclusion reached in chapter 6 (page 141), that the reduction of carbon dioxide is coupled (at least in adapted algae) only with the *second* step of oxygen reduction, the step which leads from a peroxide to water (*cf.* Eqs. 6.12). We may thus assume that, in the first stage of reaction between H_2X and oxygen and carbon dioxide, *both* hydrogen atoms go to oxygen, while in the second one they are shared between oxygen and carbon dioxide:

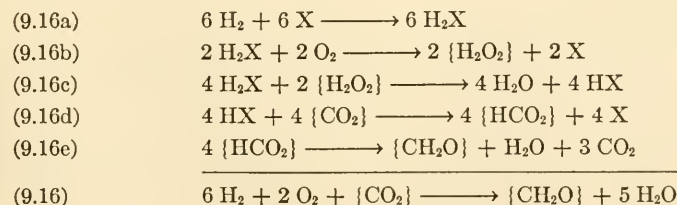

This mechanism is represented in scheme 9.IVB.

and "hydrogen chemosynthesis." In addition, however, they can also use molecular hydrogen (or organic hydrogen donors) for photosynthesis in the absence of oxygen. They must thus be capable of substituting hydrogen for the intermediary reductant, H_2Y , and oxygen for the intermediary oxidant, Z , as well as using either light energy or combustion energy for the reduction of carbon dioxide. In other words, their properties call for a combination of schemes 6.III, 9.III and 9.IVB. This synthesis is attempted in scheme 9.V. The intermediary reductant, H_2X , at which the "energy dismutation" was assumed to take place in schemes 9.III and 9.IV, is identified in scheme 9.V with the intermediary hydrogen acceptor H_2A_H of the hydrogenase system in scheme 6.III.

To avoid making scheme 9.V too complicated, we have adopted the condensed method of presentation used before in scheme 6.III, that is, we have written out the oxidation-reduction systems participating in the metabolism of adapted algae, and indicated by numbered arrows the hydrogen transfers occurring between them. One is compelled to omit in this presentation all steps (*e. g.*, dismutations) which are *not* intermolecular oxidation-reductions.

The three ways in which the carbon dioxide reduction can be brought about by *Scenedesmus* are explained in the legend. It is essential that these organisms can substitute, upon the activation of the hydrogenase and oxidase by fermentation, the reduced hydrogenase, H_2E_H , for the primary photochemical reduction product, H_2Y as a hydrogen donor, and the oxidized oxidase, E'_oO_2 , for the primary photochemical oxidation product, Z , as a hydrogen acceptor, and that these two substitutions are independent of each other.

8. Metal Complexes as Reduction Intermediates

It was stated on page 222 that iron complexes are unlikely to have potentials positive enough to play the part assigned above to the radical, HY (*i. e.*, to reduce a carboxyl group). However, iron (or other metal) complexes may conceivably play the part of the first, comparatively stable reduction product, HX . Speculations in this direction are encouraged by the conclusion of Hill (1939) and Hill and Scarisbrick (1941) (*cf.* Chapter 4, page 63) that *ferric* salts of organic acids can

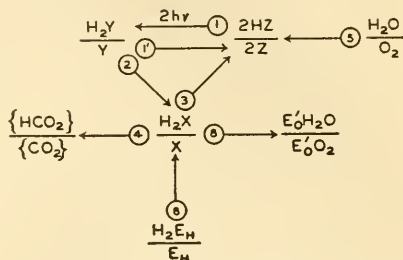

Scheme 9.V.—Metabolism of adapted algae. Arrows represent hydrogen transfer from one oxidation-reduction system to another, converting the oxidized form of the latter (bottom) into the reduced form (top). 5,1,2,{4,3}—photosynthesis, 6,3,1,2,{4,3}—photoreduction, 6{4,8}—chemosynthesis.

serve as oxidants in the chloroplast-sensitized photooxidation of water. The normal potentials of these complex salts are far above those of free ferric ions (-0.77 volt). However, it is doubtful whether they can be positive enough to allow the complex in the ferrous form to reduce the hydrogenase (whose potential at pH 7 must be about $+0.42$ volt), a reaction which was credited to the HX radicals in scheme 6.III.

In chapter 11, we shall consider the possibility that a *ferrous* iron compound serves as *reductant* in the primary photochemical process. This compound must have an exceptionally *negative* potential (even below that of free ferrous ions) in order to be able to recover its electron from water. This role of iron complexes is more in keeping with their function in respiration (where they occur close to the "oxygen end" of the "electron bucket brigade") than the above-suggested role as oxidants in the primary photochemical process. However, it may be worth while to keep in mind the possibility that the photochemical process in photosynthesis may be the *transfer of electrons from an iron (or other metal) complex of exceptionally negative potential to another such complex of an exceptionally positive potential*. An hypothesis of this type was suggested by Weiss (1937).

9. Transformations of the First Reduction Product of Carbon Dioxide

We have so far been concerned only with the *first step* of the reduction of carbon dioxide—which is probably the conversion of a carboxyl group in a large molecule $\{CO_2\} (=RCOOH)$ into a radical, $\{HCO_2\} (=RC(OH)_2)$. On page 158, we suggested that the rest of the reduction process may be ascribed to *dismutations* (*cf.* Eqs. 7.8b, c); and this hypothesis was retained in schemes 9.III and 9.IV. An alternative is that the photochemically produced reductants (*e. g.*, the radicals, HY), are again called upon to reduce the intermediate products, in a series of thermal oxidation-reduction processes similar to the sequence of photochemical reactions assumed by Franck and Herzfeld (*cf.* scheme 7.VA). This alternative allows the closest analogy between the processes of photosynthesis and respiration since, in the latter, the dehydrogenases (*e. g.*, the pyridine nucleotides) are instrumental in removing hydrogen atoms not only from keto groups (in the oxidation of glyceraldehyde to glyceric acid and of acetaldehyde to acetic acid in Schemes 9.I and 9.II), but also from the more stable $R'H-R''H$ — groups (in the oxidation of acetate and succinate) and $RHOH$ groups (in the oxidation of malate to oxalacetate in Scheme 9.II).

Pushing the analogy with respiration still further, one could suggest that an alternation of hydrogenations and carboxylations continues until a triose (*e. g.*, glyceraldehyde) can be separated from the carrier (*cf.*

with Smith's results (1943) described in chapter 3, page 37), and a little (about 0.06%) went into chlorophyll (*cf.* page 557). The fate of the large residue remained obscure.

More extensive experiments were carried out with *Chlorella* suspensions by Ruben, Kamen, Hassid, and Devault (1939), Ruben, Kamen, and Hassid (1940), and Ruben, Kamen, and Perry (1940). Figure 24 shows that the uptake of radioactive carbon in light proceeds for over

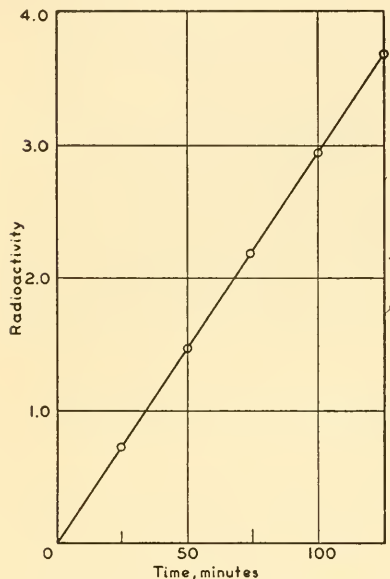

FIG. 24.—Uptake of radioactive carbon in light. The radioactive-carbon content of the algae is expressed in arbitrary units, one unit corresponding to the uptake of 6.3 mm.³ carbon dioxide per mm.³ of algae (after Ruben, Kamen, and Hassid 1940).

an hour at a constant rate of about 0.22 ml. C*O₂ per min. per milliliter of cells (in the dark, saturation was reached after 0.2 ml. was taken up in a single exposure to C*O₂ or 0.8 ml. in repeated exposures and evacuations; *cf.* Fig. 27). Manometric measurements proved that all radioactivity acquired in light was caused by assimilation of carbon dioxide (and not by an *exchange* of radioactive carbon for ordinary carbon). This was confirmed by experiments with cyanide and urethane, which showed identical effects on carbon dioxide absorption and on the increase of radioactivity. In attempts to identify the fate of the absorbed radioactive carbon, Ruben and coworkers made numerous "co-precipitation" and "coextraction" tests, which are customary in the work with small quantities of matter. After illumination periods of 1–5 min., they rapidly killed the cells, extracted them with water, and added different "carrier substances." They found, in this

way, that the active intermediate product formed in such *short* exposures is not identical with formaldehyde, acetaldehyde, propionaldehyde, glycolaldehyde, glyceraldehyde, methanol, ethanol, glycol, glycerol, erythrol, glucose, sucrose, starch, hexose monophosphate, glycine, alanine, arginine, histidine, albumin, acetone, or with any of the following acids: formic, acetic, propionic, butyric, oxalic, succinic, malic, citric, maleic, fumaric, glycolic, pyruvic, glyceric, tartaric, lactic, ascorbic, glucuronic, glutamic, aspartic, and glutaric. Fractionation experiments showed that the active intermediate is not volatile at 120° C. It is soluble in water (at least to the small extent required to account for results obtained with very dilute

preparations) and adsorbable on talcum, charcoal, or glass powder. It is not precipitated by protein-coagulating agents (heat, trichloroacetic acid), or by reagents which precipitate basic amino acids. It is colorless in solution, and not extractable from water by organic solvents.

In these rapid experiments (as contrasted with the first-mentioned experiments of longer duration), less than 1% of active carbon was found in sugars, and none at all in phosphorylated sugars, starch, or cellulose. Hydrazone tests revealed the absence of active carbonyl groups, while the Schotte-Baumann test with benzoyl chloride showed the presence of at least one alcoholic hydroxyl group. Most of the active material could be precipitated (from 80% alcoholic solution) by barium, calcium, or lead ions, thus indicating the presence of a carboxyl (or another acid) group. In decarboxylation experiments (heating dry barium salts to 250° C.), only 5% of the barium-precipitated active carbon was found convertible into barium bicarbonate. (As mentioned on page 204, a much higher yield in active barium bicarbonate—30–50%—was obtained in experiments with the C*O₂ absorption product formed in the *dark*.)

Ultracentrifugation revealed no essential difference between the active intermediates formed in light and in the dark. For example, the sedimentation velocity constants were 6.2, 6.1, 5.7, and 7.5×10^{-14} in *light* (after 4, 10, 10, and 20 min. exposure to C*O₂, respectively) and 8.6×10^{-14} (after 20 min. exposure to C*O₂) in the *dark*; the diffusion coefficients were 0.44, 0.35, 0.43, and 0.37×10^{-5} cm.² per sec. in light (10, 20, 30, and 30 min. exposure, respectively) and 0.44×10^{-5} in the dark (15 min. exposure). The calculated molecular weights were from 1000 to 1600 for the photochemical intermediate and 1500 for the complex obtained in the dark (Ruben and Kamen 1940).

It thus appears that the active intermediates present in *Chlorella* cells after a few minutes exposure to light are very similar to the complexes obtained in darkness with one important difference—that most, if not all, of the active carbon is no longer present in the carboxyl group. It seems natural to assume that this group has been reduced in light; but if so, we must account for the continuous precipitability of the complex by barium salts. The explanation may be trivial—the presence of a second carboxylic (or generally acidic) group not concerned in the carbon dioxide transformation; but another and more interesting possibility is that, after the first carboxyl group has been reduced, another one is formed by the addition of a second molecule of carbon dioxide, to be reduced in its turn, and so on—until a carbon chain of the length n_c has grown upon the acceptor molecule, and the proportion of radioactive carbon present in the form of carboxyl groups, has declined from 100% to $100/n_c\%$ (*cf.* reaction sequence 9.17).

Experiments of greater precision on the change in the proportion of radioactive carbon present in carboxylic groups as a function of the illumination time may make possible a decision between these two hypotheses, and perhaps give further information as to the reduction mechanism. The use of the weakly active but long-lived carbon isotope C^{14} , instead of the highly active but short-lived C^{11} , should make possible a less hurried and more thorough analytical work in this field, even though it will require more sensitive measuring devices.

Repeated carboxylation of the acceptor-bound substrate is not the only way in which the carbon chain may grow without ever forming free intermediates of low molecular weight. Carrier-bound intermediates may polymerize, each remaining attached to its original carrier, or may be transferred in the polymerization reaction to a common carrier molecule. Schemes of this type, in which the carbon skeleton is built up by the association of links of equal degree of reduction (instead of addition of nonreduced links to an already reduced chain) remind one of the earlier hypotheses of Maquenne and Wohl.

In the scheme of Maquenne (1923), a carbon chain was supposed to grow along a chain of chlorophyll molecules held together by the residual valencies of its magnesium atoms. Wohl (1937, 1940) thought that a synthesis of glucose can be achieved by the reduction of six carbonic acid molecules attached to six "reduction centers" on a circle, *e. g.*, six nitrogen atoms in a protein "cyclol" pattern. (The formation of a "cyclose" would be a logical outcome of such a process; it was mentioned on page 46 that Crato and Kōgel thought that inositol rather than glucose is the first product of photosynthesis.)

Bibliography to Chapter 9

The Mechanism of Reduction of Carbon Dioxide

- 1923 Maquenne, L., *Compt. rend.*, **177**, 853.
- 1924 Ruhland, W., *Jahrb. wiss. Botan.*, **63**, 321.
- 1931 Elema, B., *Rec. trav. chim. Pays-Bas*, **50**, 807.
Friedheim, E. A. H., and Michaelis, L., *J. Biol. Chem.*, **91**, 355.
- 1933 Pauling, L., and Wheland, G. W., *J. Chem. Phys.*, **1**, 362.
- 1935 Michaelis, L., *Chem. Revs.*, **16**, 243.
- 1937 Wohl, K., *Z. phys. Chem. (B)*, **37**, 169.
Weiss, J., *J. Gen. Physiol.*, **20**, 501.
- 1938 Michaelis, L., *Proc. 16 Intern. Physiol. Congr.*, Zürich, 1938.
Michaelis, L., and Schubert, M. D., *Chem. Revs.*, **22**, 437.
- 1939 Hill, R., *Proc. Roy. Soc. London (B)*, **127**, 192.
Ruben, S., Kamen, M. D., Hassid, W. Z., and Devault, D. C., *Science*, **90**, 570.
Ruben, S., Hassid, W. Z., and Kamen, M. D., *J. Am. Chem. Soc.*, **61**, 661.
- 1940 Ruben, S., Kamen, M. D., and Hassid, W. Z., *ibid.*, **62**, 3443.
Ruben, S., Kamen, M. D., and Perry, L. H., *ibid.*, **62**, 3450.
Ruben, S., and Kamen, M. D., *ibid.*, **62**, 3451.
Wohl, K., *New Phytologist*, **39**, 34.
Michaelis, L., Schubert, M. D., and Granick, S., *J. Am. Chem. Soc.*, **62**, 204.

- Pauling, L., *The Chemical Bond*. Cornell Univ. Press, Ithaca, 2nd ed., 1940.
- Wheland, G. W., *Ann. New York Acad. Sci.*, **40**, 77.
- Michaelis, L., *ibid.*, **40**, 39.
- Butler, E. T., and Polanyi, M., *Nature*, **146**, 129.
- Baughan, E. C., and Polanyi, M., *ibid.*, **146**, 685.
- Granick, S., Michaelis, L., and Schubert, M. P., *J. Am. Chem. Soc.*, **62**, 1802.
- 1941 Michaelis, L., and Granick, S., *ibid.*, **63**, 1636.
- Kalckar, H. M., *Chem. Revs.*, **28**, 71.
- Baughan, E. C., *Nature*, **147**, 542.
- Kynch, G. J., and Penney, W. G., *Proc. Roy. Soc. London (A)*, **179**, 214.
- Hill, R., and Scarisbrick, R., *Proc. Roy. Soc. London (B)*, **129**, 238.
- Lipmann, F., in *Advances in Enzymology*, Vol. 1. Interscience, New York, 1941, p. 99.
- 1942 Stevenson, D. P., *J. Chem. Phys.*, **10**, 291.
- Anderson, H. G., Kistiakowsky, G. B., and van Artsdalen, E. R., *ibid.*, **10**, 305.
- van Artsdalen, E. R., *ibid.*, **10**, 653.
- Vogler, K. G., *J. Gen. Physiol.*, **26**, 103.
- Herzberg, G., *J. Chem. Phys.*, **10**, 306.
- 1943 Ruben, S., *J. Am. Chem. Soc.*, **65**, 279.
- Gardner, T. S., *J. Org. Chem.*, **8**, 111.
- Smith, J. H. C., *Plant Physiol.*, **18**, 207.
- 1944 Emerson, R. L., Stauffer, J. F., and Umbreit, W. W., *Am. J. Botany*, **31**, 107.
- Gaffron, H., *Biol. Reviews Cambridge Phil. Soc.*, **19**, 1.

Thermochemic Data and Free Energy Tables

- 1929 Kharash, M. S., *Bur. Standards J. Research*, **2**, 359.
- 1931/1932 Roth, W. A., in Vols. II.2 and III.3 and v. Trautenberg, in Vol. III.3 of Landolt-Börnstein's *Physik.-Chem. Tabellen*, Springer, Berlin.
- 1932 Parks, G. S., and Huffman, H. M., *The Free Energy of Some Organic Compounds*. Reinhold, New York, 1932.
- 1933 Franke, W., *Biochem. Z.*, **258**, 280.
- 1935 Franke, W., *Tabulae biol.*, **5**, 120.
- 1936 Bichowsky, F. R., and Rossini, F. D., *The Thermochemistry of Chemical Substances*. Reinhold, New York, 1936.
- 1937 Conant, J. B., and Kistiakowsky, G. B., *Chem. Revs.*, **20**, 181.
- 1939 Fischer, F. G., *Ergebnisse der Enzymforschung*, **8**, 185.
- 1941 Kalckar, H. M., *Chem. Revs.*, **28**, 71.

CHAPTER 10

INTERMEDIATES IN THE REDUCTION OF CARBON DIOXIDE

A. THE PROBLEM OF INTERMEDIATES IN PHOTOSYNTHESIS; THE HYPOTHESES OF LIEBIG AND BAEYER *

In studying the transformation of carbon dioxide ($n_C = 1$, $L = 0$) into a carbohydrate ($n_C = 6$, $L = 1$) it appeared natural to look for intermediates among the compounds with carbon chains between $n_C = 1$ and 6, and reduction levels between $L = 0$ and 1; and much work has been spent on this search in the past.

It may be asked now, whether, in consideration of the probability of a mechanism of photosynthesis not involving a separation of the reduction substrate from a large carrier molecule during the whole reduction process, a discussion of the intermediates of photosynthesis, based on properties of molecules with short carbon chains, is of any use at all. The answer is that speculations of this kind certainly cannot be considered as important now as they once used to be, but that they are not entirely useless. Some of the chemical characteristics which the future carbohydrate molecule possesses at the different stages of its growth may be essentially the same whether it is free or attached to a carrier. Experiments with radioactive indicators (pp. 241 *et seq.*) indicate that separation of the substrate from the carrier occurs before its conversion into a sugar is completed. Finally, equilibria may exist between free and bound intermediates (similar to that between free carbon dioxide and the complex, $\{\text{CO}_2\}$). For example, if a large molecule of a carboxylic acid is reduced by hydrogenation first to an aldehyde and then to an alcohol, the corresponding small molecules—carbon dioxide, formic acid and formaldehyde—may be found in the free state in consequence of the equilibria:

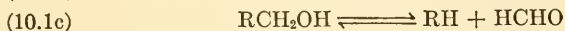
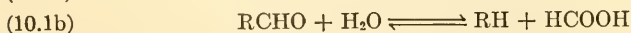

For the "old-fashioned" chemist or biochemist who had no sensitive spectroscopic, potentiometric or radioactive tools with which to discover fleeting intermediates, the way to identify intermediates was to *prove*

* Bibliography, page 273.

their presence by chemical analysis or to *make it plausible* by showing that they can be substituted for the normal substrates. Both methods have been attempted in the study of photosynthesis, but without much success.

The first chemical theory of photosynthesis was proposed by Liebig in 1843. He thought that the formation of acids must precede that of

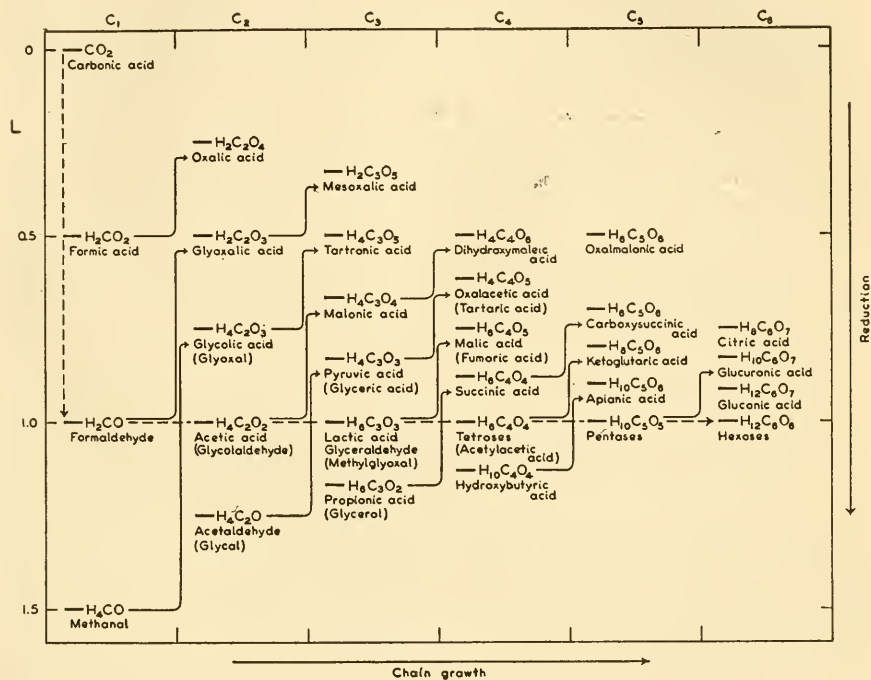

Scheme 10.I.—Low molecular weight intermediates between carbon dioxide and glucose. Compounds in parentheses have the same values of n_c and L , but differ in composition by an H_2O group, a difference which does not essentially affect their content of energy. Broken arrows illustrate the reaction scheme of Baeyer. Solid arrows correspond to carboxylations.

sugars, deriving this view from the example of ripening fruits which at first are acid and later become sweet. The common plant acids—oxalic, malic, tartaric, citric—stand between carbon dioxide and glucose in respect to their reduction level as well as to the length of the carbon chains.

Liebig's theory remained undisputed until Baeyer suggested, in 1870, that the first stage in photosynthesis is the reduction of carbon dioxide to *formaldehyde*, and is followed by the polymerization of the latter to sugar. This theory was based on Butlerov's observations of the polymerization of formaldehyde to formose. Baeyer argued that the sim-

plicity of the reaction sequence:

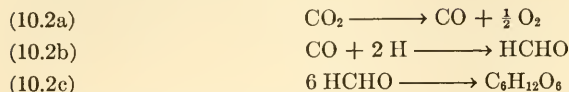

compares favorably with the complicated system of reactions needed to produce sugars through the intermediary of organic acids. Scheme 10.I serves to illustrate the theories of Liebig and Baeyer. Arrows pointing downwards correspond to reduction (hydrogenation); arrows directed to the right and upwards, to the addition of carbon dioxide (carboxylation); while a horizontal arrow means polymerization or condensation.

The column in which a compound stands in scheme 10.I indicates its carbon chain length, n_c , while the horizontal level determines its degree of reduction, L . Carboxylation increases n_c by 1, and reduces L in the ratio $n_c/(n_c + 1)$.

Baeyer's theory corresponds, in scheme 10.I, to the path along the left side down to the middle, and thence horizontally to glucose. Liebig's path goes zigzagging through the field of acids, until it reaches the apex of the table.

The compounds listed in scheme 10.I are only selected examples, since many other isomers can be formed (including unsaturated ones) by keto-enol transformations, hydrations, dehydrations, and dismutations. In chapters 7 and 9, we have repeatedly postulated that dismutations play an important part in photosynthesis. A similar suggestion was first made by Baur in 1913. He assumed that light is used in photosynthesis only for the reduction of carbon dioxide to oxalic acid, while the reduction of the latter compound to carbohydrates is brought about by dismutations.

B. LOW MOLECULAR WEIGHT COMPOUNDS IN GREEN PLANTS *

1. Review of Analytical Data

If one assumes that some intermediates (or their derivatives) accumulate, in the course of photosynthesis, in analytically recognizable quantities, one could expect help in their identification from ordinary chemical analysis. However, no significant progress has as yet been achieved in this way. This is not to say that compounds with a composition intermediate between carbon dioxide and the carbohydrates have never been found in green plants. The trouble is rather, that too many of them are present, and that none can be definitely associated with photosynthesis. To illustrate the variety of low molecular weight compounds found in green leaves, we have listed in table 10.I, most organic com-

* Bibliography, page 273.

pounds containing one or two carbon atoms, and the most common ones containing three, four, five or six carbon atoms, marking by asterisks those whose presence in green plant cells has been reported.

TABLE 10.I
LOW MOLECULAR WEIGHT COMPOUNDS IN LEAVES

Compound	Formula	Structure	Reduction level, <i>L</i>	Occurrence in green plants
C ₁ COMPOUNDS				
Formic acid	H ₂ C ₂ O ₂	HCOOH	0.50	*(1)
Formaldehyde	H ₂ CO	HCHO	1.00	*(2)
Methanol	H ₄ CO	CH ₃ OH	1.50	*(3)
Methane	H ₄ C		2.00	
C ₂ COMPOUNDS				
Oxalic acid	H ₂ C ₂ O ₄	(COOH) ₂	0.25	*(4)
Glyoxalic acid	H ₂ C ₂ O ₃	COOHCHO	0.50	*(5)
Glycolic acid	H ₄ C ₂ O ₃	CH ₂ OHCOOH	0.75	*(6)
Glyoxal	H ₂ C ₂ O ₂	(CHO) ₂	0.75	
Glycolaldehyde	H ₄ C ₂ O ₂	CH ₂ OHCHO	1.00	*(7)
Acetic acid	H ₄ C ₂ O ₂	CH ₃ COOH	1.00	*(8)
Acetaldehyde	H ₄ C ₂ O	CH ₃ CHO	1.25	*(9)
Glycol	H ₆ C ₂ O ₂	(CH ₂ OH) ₂	1.25	
Ethanol	H ₆ C ₂ O	C ₂ H ₅ OH	1.50	*(10)
Ethane	H ₆ C ₂	CH ₃ CH ₃	1.75	
C ₃ COMPOUNDS				
Mesoxalic acid	H ₂ C ₃ O ₅	(COOH) ₂ CO	0.33	*(11)
Tartronic acid	H ₄ C ₃ O ₅	(COOH) ₂ CHOH	0.5	
Malonic acid	H ₄ C ₃ O ₄	CH ₂ (COOH) ₂	0.66	
Pyruvic acid	H ₄ C ₃ O ₃	CH ₃ COCOOH	0.83	
Lactic acid	H ₆ C ₃ O ₃	CH ₃ CHOHCOOH	1.00	*(12)
Methylglyoxal	H ₄ C ₃ O ₂	CH ₂ COCHO	1.00	
Glyceraldehyde	H ₆ C ₃ O ₃	CH ₂ OHCHOHCHO	1.00	
Propionic acid	H ₆ C ₃ O ₂	C ₂ H ₅ COOH	1.16	
Glycerol	H ₈ C ₃ O ₃	CH ₂ OHCHOHCH ₂ OH	1.16	
Lactaldehyde	H ₆ C ₃ O ₂	CH ₃ CHOHCHO	1.16	*(13)
Acetone	H ₆ C ₃ O	(CH ₃) ₂ CO	1.33	
Propionaldehyde	H ₆ C ₃ O	CH ₃ CH ₂ CHO	1.33	*(14)
Propanol	H ₈ C ₃ O	CH ₃ CH ₂ CH ₂ OH	1.5	
Propane	H ₈ C ₃	CH ₃ CH ₂ CH ₃	1.66	

TABLE 10.I—Continued

Compound	Formula	Structure	Reduction level, <i>L</i>	Occurrence in green plants
C ₄ COMPOUNDS				
Dihydroxymaleic acid	H ₄ C ₄ O ₆	(COOHCOH)=(COHCOOH)	0.50	*(15)
Tartaric acid	H ₆ C ₄ O ₆	(COOHCHOH) ₂	0.625	*(16)
Malic acid	H ₆ C ₄ O ₅	COOHCHOHCH ₂ COOH	0.75	*(17)
Fumaric acid	H ₄ C ₄ O ₄	COOHCH=CHCOOH	0.75	*(18)
Succinic acid	H ₆ C ₄ O ₄	(COOHCH ₂) ₂	0.875	*(19)
Acetoacetic acid	H ₆ C ₄ O ₃	CH ₃ COCH ₂ COOH	1.00	
Butyraldehyde	H ₈ C ₄ O	CH ₃ CH ₂ CH ₂ COH	1.375	*(20)
Butenol	H ₈ C ₄ O	CH ₃ CH=CHCH ₂ OH	1.375	*(21)
C ₅ COMPOUNDS				
Valeraldehyde	H ₁₀ C ₅ O	CH ₃ (CH ₂) ₃ CHO	1.40	*(22)
Pentenol	H ₁₀ C ₅ O	CH ₃ CH ₂ CH=CHCH ₂ OH	1.40	*(23)
C ₆ COMPOUNDS				
Citric acid	H ₈ C ₆ O ₇	(COOHCH ₂) ₂ =COHCOOH	0.75	*(24)
Aconitic acid	H ₆ C ₆ O ₆	COOHCH=C(COOH)CH ₂ COOH	0.75	*(25)
Tri-carballylic acid	H ₈ C ₆ O ₅	COOHCH ₂ CH(COOH)CH ₂ COOH	0.83	*(25)
Glucuronic acid	H ₁₀ C ₆ O ₇	CHO(HCOH) ₄ COOH	0.83	*(26)
Ascorbic acid	H ₈ C ₆ O ₆	<i>Cf.</i> formula 10.I, p. 271	0.83	*(27)
Capraldehyde	H ₁₂ C ₆ O	CH ₃ (CH ₂) ₄ CHO	1.25	*(28)
α-Hexenic acid	H ₁₀ C ₆ O ₂	CH ₃ (CH ₂) ₂ CH=CHCOOH	1.25	*(29)
α-Hexenaldehyde	H ₁₀ C ₆ O	CH ₃ (CH ₂) ₂ CH=CHCHO	1.33	*(30)
α-Hexenol	H ₁₂ C ₆ O	CH ₃ (CH ₂) ₂ CH=CHCH ₂ OH	1.41	*(31)

Many of the asterisks in table 10.I refer to occasional, qualitative observations. The unreliability of such data can be judged from the critical reviews by Franzen and Stern (1921), who found that only four out of several hundreds of analyses purporting to prove the presence of lactic acid in plants were reliable, and by Franzen and Keyssner (1923¹), who approved unconditionally only 15 analyses out of 235 which allegedly proved the presence of malic acid.

No claim for completeness is made for table 10.I, and the following notes also represent only a small part of the material on which a complete review of the subject should be based. More material can be found, *e. g.*, in Czapek's *Biochemie der Pflanzen*, Volume III (1925), and in an article by Bennet-Clark (1933).

NOTES TO TABLE 10.I

(1) *Formic acid* was called by Bergmann (1882) "a common constituent of all leaves." Curtius and Franzen (1912², 1914) found it in hornbeam leaves. These

results were criticized by Fincke (1913); but Franzen and Wagner (1918) and Franzen (1920) confirmed the presence of HCOOH in distillates from chestnut and oak leaves.

(2) *Formaldehyde*: see page 255.

(3) *Methanol*: 0.02–0.05% found in *Hedera* leaves, Nicloux (1913); found in hornbeam leaves, Curtius and Franzen (1914); in chestnut leaves, Franzen and Wagner (1918); in oak leaves, Franzen (1920).

(4) *Oxalic acid*, one of the most common of the leaf acids. See page 262.

(5) *Glyoxalic acid*: found (but the test was probably unspecific) in the juice of green grapes and other green berries and in leaves, Brunner and Chuard (1886). In *Chlorella*, particularly after illumination, Kolesnikov (1940).

(6) *Glycolic acid*: found in *Amphelopsis hederacea*, Gorup-Besanez (1872). See also Ordonneau (1891), Shorey (1899), Stolle (1900), von Euler (1906), Fincke (1914).

(7) *Glycolaldehyde*: 0.01 g. found per 2 kg. of potato leaves, Rouge (1921). See Fincke (1914).

(8) *Acetic acid*: found in hornbeam leaves, Curtius and Franzen (1912, 1914); in chestnut leaves, Franzen and Wagner (1918); in oak leaves, Franzen (1920).

(9) *Acetaldehyde*: found in *Agave mexicana*, Rouge (1921); in more than 20 species of leaves, Mazé (1920); in hornbeam, chestnut and oak leaves ("most abundant leaf aldehyde next to hexenaldehyde"), Curtius and Franzen (1912, 1914), Franzen and Wagner (1918), Franzen (1920); 0.01–0.001% in succulent leaves, Bennet-Clark (1933), Gustafson (1934). According to Griebel (1924^{1, 2}, 1925) and Klein and Pirschle (1925, 1926), acetaldehyde is an intermediate product of plant *respiration*, and can be trapped, *e. g.*, by means of dimedon (*cf.* page 256) in respiring flowers and leaves.

(10) *Ethanol*: found in 29 leaf species, Mazé (1920).

(11) *Mesoxalic acid*: found in *Medicago sativa*, von Euler and Bolin (1909).

(12) *Lactic acid*: found in *Agave siciliana*, McGeorge (1912). According to Franzen and Stern (1921), only four out of hundreds of assays for lactic acid in plants, published before 1921, are reliable; one of them is in the leaves of *Agave*. Found in raspberry leaves by Franzen and Stern (1921, 1922); 0.8% of dry weight of blackberry leaves, Franzen and Keyssner (1921, 1923²); present in *Lactuca*, *Rubus*, *Rheum*, and *Vicia faba*, Schneider (1939).

(13) *Lactaldehyde*: present in poplar leaves, Mazé (1920).

(14) *Propionaldehyde*: found in chestnut leaves, Franzen and Wagner (1918).

(15) *Dihydroxymaleic acid*: probably present in *Chlorella*, Kolesnikov (1940); in *Glaucium*, Schmallfuss (1923).

(16) *Tartaric acid*. According to Franzen and Helvert (1923²), among 82 published assays only five are reliable and one probably correct; none of them refers to leaves. No tartaric acid was found in blackberry leaves by Franzen and Schumacher (1921); however, it is present in *Vitis vinifera* leaves, according to Klein and Werner (1925). Over 5% *l*-tartaric acid was found in leaves of *Bauhinia reticulata* by Rabaté and Gourévitch (1938).

(17) *Malic acid*: together with oxalic and citric acid, the most common plant acid, particularly in succulents and fruits, but also in ordinary green leaves. See page 262.

(18) *Fumaric acid*: in tobacco leaves. See Vickery and Pucher (1931).

(19) *Succinic acid*. According to Franzen and Ostertag (1923), out of 33 published assays only 10 are reliable and one probably correct; among them, 6 refer to leaves. Later results: 0.009% of dry weight in blackberry leaves, Franzen and Keyssner (1923); "small quantity" in raspberry leaves, Franzen and Stern (1922); up to 1% in some leaves, but present in traces in all, Pucher and Vickery (1940); 0.5% in tobacco; 0.2% in maize and *Bryophyllum*; 0.03% in buckwheat, Pucher and Vickery (1941).

(20) *Butyraldehyde*: in hornbeam leaves (next in abundance to hexenaldehyde), Curtius and Franzen (1912⁴, 1914); in chestnut leaves, Franzen and Wagner (1918); in oak leaves, Franzen (1920).

(21) *Butenol*: in hornbeam leaves, Curtius and Franzen (1912⁵, 1914).

(22) *Valeraldehyde*: in hornbeam, chestnut, and oak leaves, Curtius and Franzen (1912⁴, 1914), Franzen and Wagner (1918), Franzen (1920).

(23) *Pentenol*: in hornbeam leaves, Curtius and Franzen (1912⁵, 1914).

(24) *Citric acid*: after oxalic and malic, the most common plant acid. See page 262.

(25) *Aconitic and tricarballic acid* were found by Nelson and Hasselbring (1931) in green wheat, and by Nelson and Mottern (1931) in green barley, maize, oats, and rye.

(26) *Glucuronic acid*: in leaves of *Scutellaria altissima*, Palladin (1916). Other "uronic" acids also occur in plants.

(27) *Ascorbic acid*: present in all green plants. See page 269.

(28) *Capraldehyde*: present in chestnut and oak leaves, Franzen and Wagner (1918), Franzen (1920).

(29) α -*Hexenic acid*: in hornbeam leaves, Curtius and Franzen (1912², 1914).

(30) α -*Hexenaldehyde*: see below.

(31) α -*Hexenol*: in hornbeam, chestnut, and oak leaves, Curtius and Franzen (1912⁵, 1914), Franzen and Wagner (1918), Franzen (1920).

2. The Volatile Components of Green Leaves

Our knowledge of the low molecular weight components of green leaves is rudimentary; no attempts have been made to develop in this direction the analysis of the chloroplast matter, whose isolation is described in chapter 14. What we know about these compounds is due largely to a series of 29 papers "On the Constituents of Green Plants," initiated by Reinke (1881), continued by Curtius and Reinke (1897), Reinke and Braunmüller (1899), and Curtius and Franzen (1910, 1912¹⁻⁶, 1914¹⁻³, 1915, 1916) and completed by Franzen and coworkers (1918-1923). A few of these papers dealt with the nonvolatile acids in leaves and fruits; but the majority were devoted to a large-scale fractionation of the volatile components. The origin of the investigation was an observation of Reinke (1881), that steam distillation of green leaves yields a compound with the reducing properties of an aldehyde. Curtius and Reinke (1897) proved that it was not formaldehyde, as at first suspected. Reinke and Braunmüller (1899) determined the "leaf aldehyde" in different species, and observed an increase in its concentration during the day, suggestive of a relationship with photosynthesis. Curtius and Franzen (1910, 1912¹) distilled 600 kg. of leaves of *Carpinus betulus* (hornbeam) and obtained enough distillate to identify the aldehyde as the α -*hexenaldehyde*, C₁₆H₁₀O or CH₃CH₂CH₂CH=CHCHO.

The concentration of hexenaldehyde reaches 0.35 g. in 1 kg. of fresh leaves of *Vitis vinifera*, 0.29 g. in *Castanea vesca*, 0.11 g. in *Quercus sessiflora*, etc., corresponding to up to 0.1% of the dry weight of the leaves. Altogether, it was identified in 20 species. Subsequently, Curtius and Franzen (1912²⁻⁵, 1914¹) subjected 1500 kg. of hornbeam

leaves to steam distillation, while Franzen (1920) worked with a similar quantity of oak leaves. The distillates were fractionated, and it was found that hexenaldehyde is only the most abundant of many volatile components—acids, aldehydes, and alcohols—listed in table 10.II.

TABLE 10.II
VOLATILE COMPONENTS OF GREEN LEAVES

Component	L	Hornbeam	Chestnut	Oak
ACIDS				
Formic	0.50	+	+	+
Acetic	1.00	+	+	+
α -Hexenic	1.25	+		
Higher unsaturated		+	+	+
ALDEHYDES				
Formaldehyde	1.00	? ^a	?	?
Acetaldehyde	1.25	+	+	+
Propionaldehyde	1.33		+	
<i>n</i> -Butyraldehyde	1.375	+	+	+
Valeraldehyde	1.40	+	+	+
Capraldehyde	1.25		+	+
α -Hexenaldehyde	1.33	+	+	+
Higher unsaturated		+	+	+
ALCOHOLS				
Methanol	1.50	+	+	+
Butenol	1.375	+	Lower homologues	
Pentenol	1.40	+	of hexenol	
α -Hexenol	1.41	+	+	+
Higher unsaturated		+	+	+

^a Curtius and Franzen (1912, 1913) at first considered the presence of formic acid in Ag₂O-oxidized aldehyde-alcohol fraction as a proof of the occurrence of formaldehyde in leaves; but this conclusion was criticized by Fincke (1913). Later, Curtius and Franzen (1915) acknowledged that formic acid can be formed also by oxidation of methanol.

The acids were precipitated with baryta. The aldehydes in the filtrate were oxidized with silver oxide, and the acids formed in this way also precipitated as barium salts. The filtrate was distilled, and the oil drops in the distillate extracted with ether; this fraction contained the alcohols.

Franzen, Wagner, and Schneider (1921) found that the steam distillate (from 28 leaf species) also contains *basic* components, predominantly ammonia. Franzen and Wagner (1920) distilled small portions (1 kg.) of leaves of 40 species and found that in all of them the presence of

unsaturated alcohols (similar to those listed in table 10.II) is revealed by a characteristic pleasant smell.

The volatile constituents of green leaves also were studied by Mazé (1920), but on a much smaller scale. He distilled, under reduced pressure, leaves of 29 plant species and identified the following products: ethanol, C₂H₅OH ($L = 1.5$), and acetaldehyde, C₂H₄O ($L = 1.25$), in most species; glycolaldehyde, CH₂OHCOH ($L = 1.0$), and lactaldehyde, CH₃CHOHCHO ($L = 1.16$), in the leaves of poplar; acetoin, CH₃CHOHCOCH₃ ($L = 1.25$), in the leaves of green corn and peas, particularly if gathered in the evening.

In this connection, we may also recall the observations of Meyer (1917, 1918) on the occurrence of "oil droplets" in the chloroplasts of certain leaves and algae (*cf.* Chapter 3). As mentioned on page 43, Meyer interpreted these droplets (which may be nothing else but the grana, recently recognized as normal constituents of most chloroplasts) as an "assimilatory secretion." He did not determine the chemical composition of this "secretion," but compared its properties (volatility with steam, solubility in ether, insolubility in water, capacity to blacken silver nitrate in alkaline solution, smell, etc.) with the properties of the compounds isolated by Reinke, Curtius and Franzen, and concluded that they are nearest to those of hexenaldehyde. He suggested that hexenaldehyde is a component of the "assimilatory secretion" (only a component, because the quantity of hexenaldehyde found by Curtius and Franzen was much too small to account for the whole of the "assimilatory secretion").

Meyer's "assimilatory secretion" has since apparently not been investigated. However, Wieler (1936) made a renewed attempt to identify chlorophyll grana in chloroplasts with oil droplets. He suggested that the silver nitrate reduction by the chloroplasts (Molisch reaction, page 360) can be due to their content in hexenaldehyde; but this suggestion was opposed by Dischendörfer (1937).

Hexenol, hexenaldehyde, hexenic acid, and similar compounds are naturally suspect of being related to hexoses and this makes them interesting from the point of view of photosynthesis; and the same can be said of Mazé's acetoin. Since, however, both hexenaldehyde and acetoin are "overreduced" ($L > 1$), it is highly improbable that they may serve as *intermediates* of photosynthesis; they are more likely to be its *by-products*.

Nye (*cf.* Spoehr, Smith, Strain and Milner 1940), in a re-examination of the role of hexenaldehyde in leaves, found evidence that it is formed during the grinding of leaves. Whole leaves, or leaves which have been killed with hot water, toluene, or chloroform before grinding, yielded little or no hexenaldehyde upon distillation. If the grinding was carried

out in nitrogen or carbon dioxide, hexenaldehyde also was absent; it can thus be considered as an oxidation product. The material from which it is formed is unknown; but it must be even more strongly reduced than hexenaldehyde itself, and thus even less likely to be an intermediate of photosynthesis.

C. THE FORMALDEHYDE PROBLEM *

1. The Search for Formaldehyde in Leaves

Because of the popularity of Baeyer's "formaldehyde theory" (1870), no other compound has been so eagerly searched for in plants as formaldehyde—and with such uncertain results. Categorical statements that formaldehyde does occur in leaves have been answered by no less categorical denials. Since formaldehyde is poisonous to plants, nobody had ever expected to find a *large quantity* of this compound in leaves. It was therefore necessary either to apply very sensitive methods of assay, or to "trap" formaldehyde by a reagent which could be left in the cells for a certain time without disturbing photosynthesis.

Earlier investigations were made by the direct analytical method. When Reinke (1881) discovered the presence of an aldehyde in the products of steam distillation of leaves (*cf.* page 252), he at first thought it to be formaldehyde; but Curtius and Reinke (1897) showed that it lacked the specific properties of this compound. Pollacci (1899^{1,2}, 1907) obtained positive formaldehyde tests with distillates of green leaves; but his results were contested by Plancher and Ravenna (1904). Grafe (1906) also claimed positive results, with a new reagent, diphenylamine and sulfuric acid; but Curtius and Franzen denied that it gives a color reaction with formaldehyde at all. Curtius and Franzen (1912) obtained formic acid by the oxidation of the aldehyde fraction of leaf distillates, and considered this as an indirect proof of the presence of formaldehyde; but Fincke criticized this conclusion and Curtius and Franzen (1915) found later that oxidation by silver oxide can also produce formic acid from methanol (which is present in leaf distillates). Fincke (1913) used a new reagent (fuchsinsulfuric acid in the presence of hydrochloric acid), and concluded that the formaldehyde content of illuminated leaves is less than $5 \times 10^{-4}\%$. He found further that, if formaldehyde is supplied to the leaves from outside, it is not found in the analysis, but is destroyed by the plant cells.

Schryver (1910) claimed to have identified formaldehyde in chlorophyll preparations, extracted from leaves by alcohol, evaporated and again extracted with ether, by means of Rimini's reagent (phenylhydrazine hydrochloride, potassium ferriocyanide, and hydrochloric acid).

* Bibliography, page 275.

However, Willstätter and Stoll (1918) who repeated these experiments obtained negative results.

Sabalitschka and Riesenberg (1924³) too, were unable to find formaldehyde in leaves. Even in leaves fed with formaldehyde, they found only a small residue of the supplied material (in conformity with Fincke's observations).

Klein and Werner (1926) were the first to apply the method of *trapping* to the formaldehyde problem, using Vorländer's reagent for aldehydes (5,5-dimethyl-1,3-cyclohexanedione, also called "dimedon" or "methone"). They saturated the plants (*e. g.*, *Elodea canadensis*) with dimedon, left it in the illuminated plants for several hours, and then extracted again. The extract was distilled, the aldehyde-dimedon compound crystallized and identified by its crystal form and melting point. Formaldehyde quantities of the order of 10 mg. were isolated in this way from 100 g. of plant material, illuminated for 5 hours with 7000-8000 lux. This is only 1-2% of the carbohydrate normally formed by photosynthesis during the same period. Acetaldehyde, but no formaldehyde, was found in plants which were kept in the dark, as well as in chlorophyll-free tissues, and this was interpreted as a proof that acetaldehyde is an intermediate product of respiration.

The amount of formaldehyde trapped by dimedon in illuminated plants decreased upon the addition of phenylurethane or potassium cyanide—substances which inhibit photosynthesis.

Klein and Werner's conclusions were confirmed by van Goor (1926) and Pollacci and Bergamaschi (1929^{1,2}, 1930), who also used dimedon. Positive assays were also reported by Sommer, Bishop, and Otto (1933).

On the other hand, Barton-Wright and Pratt (1930) found themselves unable to reproduce Klein and Werner's experiments. Noack (1927) called attention to the narcotizing effect of dimedon on the photosynthetic apparatus and suggested that the formaldehyde found by Klein and Werner came from the photodecomposition of sugars (or other organic compounds) rather than from photosynthesis. Noack's objections were disputed by Klein (1927) and by Pollacci and Bergamaschi (1930), who asserted that formaldehyde can be identified under conditions when photosynthesis is not appreciably narcotized by dimedon.

Vorländer (1928) suggested that formaldehyde may come from the oxidation of dimedon by "nascent" oxygen. Pollacci and Bergamaschi (1930) answered that they were able to obtain a positive formaldehyde test with dimedon also by first illuminating the leaves, and *then* adding the reagent. However, this means an abandonment of the trapping technique and return to direct analysis, which, in the case of formaldehyde in plants, seems certain to fail; and in fact Klein and Werner have never found any formaldehyde in preirradiated leaves.

Thus, the results of formaldehyde assay in illuminated plants remain contradictory and inconclusive.

2. Formaldehyde Feeding Experiments

The second method used in biochemistry to identify the intermediates is the "substitution test." One could think of testing Baeyer's theory by investigating whether the plants would accept formaldehyde instead of carbon dioxide as a material for the synthesis of sugars.

Experiments of this type have been attempted for over fifty years; but many circumstances conspired to make the results indecisive. In the first place, it was known even in Baeyer's time that formaldehyde is poisonous to plants. Consequently, Loew and Bokorny (1887), who were the first to attempt the "formaldehyde feeding" of plants, used *methylal*, $\text{OC}(\text{OCH}_3)_2$, as a nonpoisonous substitute (they assumed that it hydrolyzes in the cells to formaldehyde and methyl alcohol). They observed that certain algae, *Spirogyra*, for example, can grow in the dark in methylal solutions. Bokorny (1888) found that starch is produced by the algae from methylal, but only in light. Later (1892), the same author observed that sodium formaldehyde sulfonate, $\text{HOCH}_2\text{SO}_3\text{Na}$, is used by algae in the same way as methylal. Bouilhac (1901, 1902) and Bouilhac and Giustiniani (1903) obtained similar results with the *Nostoc* algae, both in methylal solutions and in weak solutions of formaldehyde, but again only in light. Treboux (1903) obtained completely negative results in attempts to grow algae in formaldehyde or methylal solutions in darkness.

Bokorny (1908, 1909, 1911) found later that algae are less easily poisoned if the formaldehyde is in vapor form instead of solution; he found under these conditions, a production of starch from formaldehyde by illuminated *Spirogyra*. Grafe and Vorthcim (1909), Grafe and Wieser (1909), and Grafe (1911) observed that land plants, too, can stand comparatively high concentrations of formaldehyde vapor (up to 1.3% by volume) if their roots are protected, and are able to utilize it for the production of organic matter. Similar conclusions were reached by Baker (1913), who found that formaldehyde vapor is more poisonous to green plants in light than in the dark, and by E. and G. Nicolas (1922^{1,2}) who observed that formaldehyde is less poisonous to green pea plants than to seedlings not containing the green pigment. All these results indicate that, in the presence of chlorophyll, formaldehyde undergoes a photochemical decomposition which prevents poisoning. This conclusion agrees with the observation of Fincke (1913) that plants (or plant mash) rapidly destroy formaldehyde (*cf.* page 255). Whether this disappearance is due to *synthesis* (polymerization to carbohydrates), or to *decomposition* (*e. g.*, oxidation to formic acid, as in experiments on

photochemical oxidation of formaldehyde *in vitro*; cf. Spoehr 1913, 1916) is a difficult problem, because as long as air is present the formation of sugars or starch from formaldehyde in light can be explained by a preliminary oxidation (or photooxidation) to carbon dioxide, followed by normal photosynthesis, as was pointed out by Willstätter and Stoll (1918). Thus, to be entirely convincing, formaldehyde feeding experiments should be carried out in darkness, or in the absence of air. Of the earlier investigators, Bokorny, Bouilhac, and Grafe found that formaldehyde assimilation occurs only in light, while Baker's experiments indicated that it can take place in the dark as well.

More recently, a number of investigators obtained results apparently confirming Baker's conclusions. Jacoby (1920) found that leaves of *Tropaeolum majus*, kept in darkness for 24 hours in a stream of formaldehyde vapor, contained a 20–30% larger proportion of dry matter than the control leaves (*e. g.*, 13.5% dry matter in "formaldehyde leaves," and 11.2% in control leaves). However, the absolute quantity of dry matter (as compared with that of fresh leaves) was not increased. In a second paper (1922), Jacoby found that elimination of oxygen does not affect the results.

In a series of papers on "Aldehydes in Plants," Sabalitschka (1922, 1924, 1928), Sabalitschka and Riesenberg (1924^{1, 2, 3}), and Sabalitschka and Weidling (1926^{1, 2}) obtained results similar to those of Jacoby. They first worked with water plants (*Elodea canadensis*) in formaldehyde solutions; and observed poisoning only with concentrations above 0.02%, *i. e.*, considerably above the limit found by Bokorny (0.005%). Working below 0.02%, Sabalitschka (1922) found that formaldehyde was oxidized in light to formic acid, and the latter used for photosynthesis. In darkness, however, formaldehyde was converted directly into sugars or high polymers. Sabalitschka and Riesenberg (1924¹) made experiments with whole plants of *Phaseolus multiflorum* in a formaldehyde atmosphere, and found that the formaldehyde-fed plants contained three or four times more sugar and starch than starved control plants. The total dry weight was sometimes (but not always) larger than before the experiment.

In his next paper, Sabalitschka (1924) investigated the stimulating effects of formaldehyde on the germination of seeds, fermentation of glucose by yeast, etc., and concluded that the concentrations of formaldehyde which gave positive results in feeding experiments (0.001%) were not likely to affect the activity of the enzymatic system responsible for the polymerization process. Sabalitschka and Weidling (1926¹) returned to experiments on *Elodea* in formaldehyde solutions, and found that the highest concentration of starch is obtained by feeding a 0.024% formaldehyde solution (21.9% of dry weight in formaldehyde leaves, as

against 19.2% at the beginning of the experiment, and 15.7% in the starved control plants). Illumination had no effect on these results. Formaldehyde poisoning of photosynthesis in *Elodea* begins at about 0.024% and leads to a complete suppression at 0.033%; the catalase activity becomes affected in the same range of concentrations.

Positive results were obtained also by E. and G. Nicolas (1922^{1,2}, 1923) in experiments on the effect of formaldehyde (0.01%) on the growth of peas. They noticed that, in the absence of chlorophyll, the effect of formaldehyde was a purely toxic one.

Bodnár, Róth, and Bernauer (1927) criticized Sabalitschka's experiments for the lack of a direct proof that the difference in composition between the formaldehyde-fed and starved plants was due to an assimilation of formaldehyde rather than to the poisoning of respiration. (However, this objection does not apply to experiments in which the dry weight after formaldehyde feeding was *higher* than at the beginning of the experiment.) Bodnár and coworkers observed a significant increase in the percentage of dry matter in formaldehyde-fed leaves; although the respiration of these leaves was strongly inhibited (by about 50%), this inhibition could account only for a small part of the observed difference in dry weight. They found that no positive iodine test could be obtained with formaldehyde-fed leaves of *Tropaeolum*, and suggested that *sugars* (and not starch) are the only products of polymerization of formaldehyde by leaves.

That changes in water content did not affect the percentage of dry matter in "formaldehyde leaves," was shown by the observation that these leaves had a heavier dry weight and a larger sugar content than did the *fresh leaves* before the experiment—and not only than the starved control leaves.

Bodnár and coworkers finally found that the production of reducing sugars from formaldehyde is catalyzed also by leaf mash and dried leaf powder, thus indicating the presence in this mash of a polymerizing enzyme. No sugar was obtained from acetaldehyde with leaf mash; neither was acetaldehyde assimilated by leaves (*cf.* page 261). Boiling destroyed the activity of leaf powder or leaf mash, indicating the denaturation of the enzyme.

Experiments of West and Ney (page 273) indicate the possibility that Bodnár's polymerization catalyst may be *ascorbic acid*. (However, the West and Ney experiments dealt only with the polymerization of formaldehyde in *alkaline* solutions.) Results similar to those of Sabalitschka and Bodnár and coworkers were also obtained by Godnev and Korshevniski (1930) with leaves of *Tropaeolum*, *Pelargonium*, *Tilia*, and *Urtica*.

These investigations by several independent workers appeared to have settled definitely the question of the formaldehyde assimilation by

green leaves. One could discuss the weight of this fact as an argument in favor of Baeyer's hypothesis (*cf.* page 247); but the fact itself seemed to be established beyond doubt. Recently, however, the correctness of these results was challenged by Paechnatz (1938) in Noack's laboratory. She experimented with *Elodea*, *Chlorella* and *Tropaeolum*, and found no evidence whatsoever of the capacity of these plants to utilize formaldehyde for the synthesis of sugars. Even with concentrations as low as 0.003% (that is, considerably below Sabalitschka's optimum), she observed nothing but poisoning, both of respiration and of photosynthesis. The only positive effect was an increase in the *relative* quantity of sugars in the dry substance of formaldehyde-fed plants. However, this difference was caused by the fact that sugars were less affected by ex-osmotic processes caused by formaldehyde poisoning than other constituents of the cells. The *absolute* quantity of sugars was decreased rather than increased by formaldehyde "feeding." Attempts to repeat Bodnár's experiments on polymerization of formaldehyde by leaf powder also fell short of positive results. Formaldehyde was found to disappear in the presence of plant cells—as observed earlier by Fincke (1913)—but this was caused by catalytic *oxidation* rather than by polymerization.

Thus, the problem of formaldehyde assimilation by green plants remains open. Paechnatz' suggestion of errors which might have marred the results of earlier authors does not account for all of their positive experiments, especially those in which the "formaldehyde leaves" were found to possess a higher dry weight and a higher sugar content than fresh leaves.

Bottomley and Jackson (1903) asserted that *Tropaeolum majus* can grow if *carbon monoxide* is supplied to it instead of carbon dioxide, and saw in this result a confirmation of Baeyer's theory. Their observations have never been repeated, and one may venture to suggest that the measures taken to prevent the access of small quantities of carbon dioxide to the plants were not as efficient as the authors thought them to be.

3. Feeding of Plants with Other Low Molecular Weight Compounds

While the acceptance of formaldehyde as food by algae and other green plants remains a subject of controversy, doubts also arise as to whether even unquestionably positive results of formaldehyde feeding would carry much weight as arguments in favor of Baeyer's theory. These doubts derive from the fact that not only hexoses and pentoses (*cf.* Chapter 3) and their close derivatives (sugar alcohols, uronic acids, etc.), but also compounds with shorter carbon chains (C₂ to C₅) can be utilized by plants for conversion into starch in the dark. Thus, Meyer (1885) found that leaves can synthesize sugar from glycerol, and Bokorny (1897) gave a long list of compounds which algae can utilize for the production

of starch, including glycol, glycerol, methanol, phenol, acetate, lactate, and butyrate.

Treboux (1905) found that many algae, *Chlorella*, *Stichococcus*, and *Chlamydomonas*, for instance, can live in darkness on acetate (some thrive on this food even better than on glucose), and a few can use also lactate, butyrate, or citrate; but they all refuse to accept other organic acids, including formic, propionic, valeric, oxalic, malic, succinic and tartaric.

Sabalitschka and Weidling (1926²) found that *Elodea canadensis* also can form starch from *acetaldehyde*, both in darkness and in light, the optimal concentration being 0.032%, that is, somewhat higher than that of formaldehyde. (Acetaldehyde begins to retard the enzymatic activity of the plant—*e. g.*, respiration and catalase activity—only at concentrations above 0.3%.) Photosynthesis is stimulated by acetaldehyde concentrations up to 0.13% and retarded above this limit. Bodnár, Róth, and Bernauer (1927) and Bodnár (1928) opposed Sabalitschka's conclusions and insisted that formaldehyde alone is assimilated and thus can cause an increase in dry weight, while acetaldehyde merely reduces respiration, and thus makes the weight of the treated leaves higher than that of the starved control leaves (which lose more weight by respiration). It does not appear however, that this suggestion can account for all of Sabalitschka's results.

Whatever the truth about acetaldehyde is, there is little doubt that acetic acid, glycol, glycerol, and many other compounds can be used as foods to support plants in absence of photosynthesis. The preference of many organisms for *acetates* has been confirmed by Lwoff (Lvov) and coworkers. Lwoff (1932) and Lwoff and Dusi (1935) investigated the food requirements of green flagellates (*Chlamydomonas*, *Euglena*, *Chlorogonium*, etc.)—*Protozoa* of a predominantly "vegetative" character—which can develop in darkness provided they are supplied with an organic source of nitrogen and a simple source of carbon. Lwoff and Dusi found that some species thrive on propionate, butyrate, valerate, caproate, pyruvate or lactate, but that the only two organic compounds which *all* of them will accept are *acetate* and soluble *starch* (while even glucose, fructose, or sucrose are rejected by some of them). Lwoff and Dusi suggested that acetic acid may be the first product of carbohydrate synthesis not only in *Protozoa* but also in the higher algae and land plants.

In reviewing the list of simple compounds capable of supporting the growth of plants in the dark, we find that they almost invariably belong to reduction levels above, or equal to, that of the carbohydrates.

Treboux was surprised that acetic acid should be preferred to the common plant acids (*e. g.*, malic and oxalic); but consideration of the reduction levels gives a plausible explanation. Compounds which can be used for conversion into starch in the dark are those whose *L* values are ≥ 1 , for instance: for glycol, $L = 1.25$; butyric acid, $L = 1.25$; glycerol, $L = 1.16$; acetic acid, $L = 1$; lactic acid, $L = 1$; etc. Com-

pounds which are unsuitable as plant foods in the dark are usually those with L values less than unity, as: formic acid, $L = 0.5$; oxalic acid, $L = 0.25$; malic acid, $L = 0.75$; succinic acid, $L = 0.875$; and tartaric acid, $L = 0.625$.

Some exceptions from this rule have been reported, *citrate* being the most notable of them; and we shall consider their significance on page 266.

At present, we want only to stress that plants contain enzymatic systems which enable them to convert into carbohydrates in the dark most, if not all, simple organic compounds whose reduction level is so high that their conversion does not require a supply of energy. Thus, even if formaldehyde were definitely proved to be an acceptable food for plants, it would only join the large number of compounds of similar degree of reduction which possess the same property; nobody will claim that all these compounds should be considered as intermediates of photosynthesis (and few will agree with Lwoff that acetic acid should be picked out as the only such intermediate).

D. THE PROBLEM OF PLANT ACIDS*

The assumption that organic acids play the role of intermediates in photosynthesis, as suggested by Liebig one hundred years ago, is supported *indirectly* by three kinds of observations. In the first place, some of these acids are present in all green plants (although they are found also in colorless plant organs). In the second place, some plants, at least, can convert these acids in light into carbohydrates. In the third place, they are known to play the part of intermediates in respiration, which in its net result, is a reversal of photosynthesis.

1. Occurrence of Plant Acids in Leaves

Table 10.I lists, besides alcohols and aldehydes, a number of *organic acids* of low molecular weight (*e. g.*, *glyoxylic*, *glycolic*, *tartronic*) as occasionally present in green plants. Table 10.II shows *formic acid* and *acetic acid* among the volatile components of leaves. However, when one speaks of "plant acids" one commonly means not these comparatively rare constituents but the three or four acids which are widely distributed in plants, partly in the free form, and partly as salts. Omitting for the present *ascorbic acid*, whose role will be discussed in Section E, the three common plant acids are *oxalic*, *malic*, and *citric*.

Their distribution in the plant world is anything but uniform. Not only are there large variations from species to species and from tissue to tissue, but even from place to place in one and the same tissue. Strong

* Bibliography, page 277.

concentration changes can take place in a plant in the course of the season, or even of a single day.

We shall quote a few figures to show the range over which the concentration of plant acids may vary in different species. On the one extreme, Franzen and Keyssner (1923²) found, in the leaves of *Rubus fruticosus* (blackberry), in addition to 0.8% lactic acid and $9 \times 10^{-3}\%$ succinic acid, only $1.5 \times 10^{-4}\%$ malic acid and $3 \times 10^{-4}\%$ oxalic acid. On the other extreme, leaves have been observed to accumulate up to 10 or 20% citrate, oxalate, or malate.

The presence of microscopic crystals of *acid potassium oxalate* in *Oxalis acetosella* (clover sorrel) was known to Malpighi as early as 1686. The concentration of oxalate in the leaves of common sorrel (*Rumex*) and of rhubarb (*Rheum*) is over 1%, and in the leaves of beet, 4% (cf. Czapek 1925, p. 71). The leaves of *Begonia semperflorens* may contain up to 20% oxalate (Ruhland and Wetzel 1926); and in some cacti (e. g., *Pilocerus senilis*), the concentration of calcium oxalate, increasing with age, can finally reach 90% of the total dry matter. A list of typical "oxalate plants" was given by Bennet-Clark (1933).

Malic acid was first discovered in fruits, but Vauquelin (1800) found that it is also present in large quantities in succulent leaves, as in those of *Bryophyllum*. Early determinations of malic acid in leaves were made by de Fries (1884), Warburg (1886), and Ordonneau (1891). However, according to Franzen and Keyssner (1923¹), out of 235 assays for malic acid in plants only 15 were reliable (5 of them in leaves) and 11 probably correct (7 of them in leaves). However, there seems to be little doubt that small quantities of malic acid are present in most, if not all, leaves and algae. Franzen and Keyssner (1923²) found $1.5 \times 10^{-4}\%$ malic acid in blackberry leaves; Ruhland and Wetzel (1926) found 0.5% in *Begonia semperflorens*. Klein and Werner (1925) identified it in five species of nonsucculents; Zacharova (1934), in pine needles; Vickery and Pucher (1931) and Pucher, Wakeman, and Vickery (1937), in tobacco leaves; Pucher, Clark, and Vickery (1937^{1, 2}), in rhubarb leaves; Pucher, Wakeman, and Vickery (1939), in buckwheat leaves; and Kylin (1931), in brown algae.

The concentration of *calcium malate* in some succulents reaches 8% (*Agave siciliana*), 14% (*Mesembryanthemum crystallinum*), or even 25–50% (certain *Crassulaceae*) (Czapek 1925, pp. 80–82). In addition to succulents, malic acid is present in comparatively large concentrations also in many "oxalate plants," e. g., rhubarb. A list of "malate plants" was given by Bennet-Clark (1933).

The early assays of *citrates* in plants, were critically reviewed by Franzen and Helvert (1923) who recognized as reliable only 16 out of 137 published figures; however, small quantities of citrate are undoubtedly present in a majority of green plants. Citrate was found by Vickery and Pucher (1931), Pucher, Sherman, and Vickery (1936) and Pucher, Wakeman, and Vickery (1937) in tobacco leaves; by Pucher, Clark, and Vickery (1937) in rhubarb leaves; and by Pucher, Wakeman, and Vickery (1939) in buckwheat leaves. Wolf (1939), Guthrie (1934), and Borgström (1934) showed that citric acid replaces malic acid as the main product of acid metabolism in certain succulents; *Kleinia neriifolia*, for example, accumulates, according to Borgström, as much as 17% citrate.

Oxalate crystals grow steadily in many plants, and obviously represent excretions (although they can occasionally be redissolved). Of all the organic acids, oxalic acid has the lowest reduction level ($L = 0.25$); it thus contains the least chemical energy and can be discarded without much waste.

The role of *malic* and *citric* acid in the metabolism of plants is certainly a more active one, since even in plants which accumulate large quantities of these acids, their concentrations are subject to rapid fluctuations. They are to be considered as intermediary metabolites, and not as excretions.

Their precise metabolic function has not yet been definitely established, despite the extensive studies of Ruhland, Wetzel, and coworkers in Germany (Ruhland and Wetzel 1926; Ullrich 1926; Ruhland and Wetzel 1927; Wetzel 1927; Ruhland and Wetzel 1929; Bendrat 1929; Wetzel and Ruhland 1931; Wolf 1931; Schwartze 1932; Ruhland and Wolf 1934, 1936; Wolf 1937, 1939^{1,2}), as well as of Vickery, Pucher, and coworkers in America (tobacco leaves: Vickery and Pucher 1931, 1933^{1,2}, 1935; Pucher, Wakeman, and Vickery 1937; Pucher, Vickery, and Wakeman 1938; Vickery, Pucher, Wakeman, and Leavenworth 1937, 1938, 1939; Vickery and Pucher 1939; rhubarb leaves: Pucher, Clark, and Vickery 1937^{1,2}; Pucher, Wakeman, and Vickery 1938; Vickery and Pucher 1939; buckwheat leaves: Pucher, Wakeman, and Vickery 1939) and of Bennet-Clark in England (Bennet-Clark 1933, 1934; Bennet-Clark and Woodruff 1935). Cf. reviews by Ruhland and Wolf (1934, 1936), Bennet-Clark (1937), and Vickery and Pucher (1940).

There is considerable disagreement between these authors as to the interpretation of many results. Ruhland and Wetzel suggested that, in the plants of the so-called "acid type" (e. g., rhubarb and sorrel), both oxalic and malic acid are formed by deamination of aminoacids rather than by oxidation of carbohydrates; but Vickery and Pucher, as well as Bennet-Clark, opposed this view. They agreed, however, that fundamental differences exist between the acid metabolism of succulents, that of "acid-type plants," and that of other nonsucculents (of the latter, only tobacco and buckwheat have been investigated in some detail).

2. Acidification of Succulents

The question of the role of plant acids in photosynthesis arises most acutely in the interpretation of the acid metabolism of succulents. Its most striking characteristic is a *diurnal rhythm*. The accumulation of acids in succulents during the night and their disappearance during the day has attracted much attention since its discovery by Heyne in 1819. A table compiled by Bennet-Clark (1933) shows that in some plants the titratable acidity increases from evening to morning by as much as a factor of 12, whereas in others the increase is only of a few per cent. In some cases a nightly *decrease* in acidity was observed. (However, titratable acidity is not an entirely adequate measure of the production of plant acids, since other factors also may affect the *pH* of the sap.) The daily fluctuation of acidity in most succulents is due mainly to the formation and disappearance of *malic acid*, but in some species, *citric acid* accounts for the largest part of the effect. However, even acids present in a relatively small concentration, participate in the fluctuations together with malic and citric acid (Wolf 1939).

An explanation of the acidification cycle was suggested by Meyer in 1887. He pointed out that succulents, because of their relatively small surface, may have difficulty in obtaining from the outside an adequate

supply of carbon dioxide for photosynthesis. They may have therefore evolved a mechanism by which the products of respiration, formed during the night, can be utilized for photosynthesis during the next day: instead of burning carbohydrates completely to carbon dioxide, they interrupt the respiration at the stage of malic or citric acid and store these acids in the leaves until morning. Meyer's explanation implies that the plant acids are *respiration intermediates*; their disappearance in light can be interpreted as evidence that they also are *intermediates of photosynthesis*.

The first suggestion is supported by the fact that acidification occurs at the cost of carbohydrates (Kraus 1873; Wolf 1931; Bennet-Clark 1933²). Not more than one molecule of acid appears for each disappearing carbohydrate molecule (Wolf). Bennet-Clark suggested, however, that (at least in *Sedum*) the acidification occurs by the oxidation of sedoheptulose, rather than that of hexoses. Warburg (1886) asserted that acidification occurs only in air, but Bendrat (1929) observed that it can proceed also in absence of oxygen; it thus appears that acids may be produced by *fermentation* rather than (or as well as) by the autoxidation of the sugars.

The second part of our hypothesis—the attribution of deacidification to a resynthesis of carbohydrates in light—is supported by the observation of Meyer (1878) that succulents deprived of carbon dioxide nevertheless produce carbohydrates in light, until their reserve of acids is exhausted; and by the experiments of Warburg (1886) who found that *Bryophyllum* can synthesize carbohydrates in light from externally supplied malic acid. It is, however, difficult to choose between two possible mechanisms of resynthesis—the direct photochemical reduction of malic (or citric) acid (*i. e.*, photosynthesis with organic acids as substitutes for carbon dioxide), and an oxidation (or photooxidation) of the acids to carbon dioxide followed by ordinary photosynthesis. The possibility of indirect resynthesis was pointed out by Spoehr (1913) and Willstätter and Stoll (1918). Obviously the direct mechanism (if confirmed), would provide an argument (equivalent to a successful substitution test) in favor of organic acids as intermediates of photosynthesis.

Warburg (1886) and Astruc (1903) found that the rate of deacidification is reduced by an increase in the pressure of carbon dioxide; this may indicate a competition between carbon dioxide and the organic acids for the part of oxidants in photosynthesis and thus support the direct reduction theory. On the other hand, the simultaneous evolution of oxygen and carbon dioxide during deacidification, first noticed by Meyer (1878) and confirmed by Aubert (1890, 1891, 1892), can be quoted in favor of the "indirect reduction" theory, since direct photosynthesis of carbohydrates from acids, although it can reduce the carbon dioxide consumption during the deacidification period to zero, could not cause a

liberation of this gas. Since the carbon dioxide liberation is larger than ordinary "dark" respiration, an additional *photooxidation of accumulated acids* is clearly indicated by these observations (*cf.* Chapter 19). Another argument in favor of deacidification in light being an oxidative process is the observation of Kraus (1873) and Richards (1915) that it requires the presence of oxygen.

On the whole, evidence favors a primary oxidation or photooxidation of accumulated acids in succulents, rather than a direct photochemical reduction of these acids to carbohydrates; but the issue is not settled.

Another complication arises from the fact that deacidification is not necessarily a photochemical effect. De Fries (1884) found that, after eight or ten hours of acid accumulation, deacidification begins even if the plants remain in darkness. The decrease in acidity in artificially prolonged darkness was confirmed by Bennet-Clark (1933, 1934) and Thoday and Jones (1939). We do not know whether the "dark" deacidification also leads to a resynthesis of carbohydrates, or whether it is a purely oxidative process. From the point of view of the theories which assume that *all* reduction steps in photosynthesis between {CO₂} and {CO₂O} must be photochemical (*cf.* Franck and Herzfeld's scheme, 7.VA), a "dark" conversion of malic or citric acid into carbohydrates appears impossible. The reduction levels of these acids are less than unity, *i. e.*, they cannot be converted into carbohydrates without a supply of energy. However, we have also discussed, in chapter 7, reaction schemes in which only the first step in the reduction of carbon dioxide utilized light energy, while the energy required for the subsequent reduction steps was supplied by *dismutations*. Thus, malic and citric acid could be reduced to carbohydrates without the help of light, if one part of them were simultaneously oxidized. Such an enzymatic dismutation was deemed probable by Bennet-Clark (1933), and is supported by the fact that the respiratory quotient of succulents during dark deacidification is often much higher than 1.33, the value corresponding to the combustion of malic acid (Wolf 1939). (For pure dismutation, this coefficient should be infinity.) Other experimental facts can be quoted in connection with this discussion. It was mentioned on page 262 that in experiments on starch production by algae in the dark, the rule that only substances with $L \geq 1$ can be utilized for this purpose was found to allow of some exceptions. Bokorny (1897) listed succinic, citric, and tartaric acid ($L = 0.875, 0.75,$ and $0.625,$ respectively) as acceptable foods. Treboux (1903) found that, while succinates, malates, and tartrates are ineffective, citric acid ($L = 0.75$) is utilized by the algae; this was confirmed by Zumstein (1899). Similarly, Lwoff (1932) and Lwoff and Dusi (1935) found pyruvate ($L = 0.833$) to be a satisfactory source of carbon for the dark growth of some species of *Flagellata*.

All this makes plausible the theory that the dark deacidification of succulents is a *dismutation into carbon dioxide and carbohydrates* (thus lending indirect support to the "dismutation theory" of photosynthesis). The deacidification in *light*, too, may be a complex process, involving both photooxidation to carbon dioxide (with the latter becoming available for photosynthesis) and the formation of carbohydrates by reduction or dismutation of the acids without the substrate's passing through the stage of free carbon dioxide. It may be mentioned here that Spoehr (1913) and Volmar (1923) found that some formaldehyde is produced, together with formic acid and carbon dioxide, when oxalic, malic, or succinic acid is photooxidized in ultraviolet light *in vitro*.

Wolf (1931) suggested that the mechanism of deacidification in light is the same as in the dark, with light merely accelerating it by assisting in the removal of carbon dioxide. However, the irreversibility of the oxidation process argues against ascribing a retarding effect to the accumulated oxidation products.

3. Plant Acids in Nonsucculents

We have seen in the preceding section that a direct participation of malic and citric acid in the photosynthesis of succulents appears possible, but is by no means certain. The existence of a relationship between the metabolism of malic and citric acid and photosynthesis in nonsucculents is even less clear. It was mentioned above, that Ruhland and Wetzel (1929) attributed the acid formation in "oxalate plants" to the deamination of amino acids (rather than to an oxidation or fermentation of carbohydrates). In confirmation of this point of view, they mentioned that an equivalent quantity of ammonia is liberated simultaneously with the formation of malic acid. However, Pucher, Wakeman and Vickery (1938) found that rhubarb leaves can produce malic acid from externally supplied glucose; and Pucher, Clark, and Vickery (1937) denied the existence of a parallelism between the liberation of ammonia and the production of malic acid (or any other plant acid).

Even if we assume that malic and citric acid in nonsucculents are under all circumstances products of the carbohydrate metabolism, we do not know whether they are regular respiration intermediates, or by-products. Considerations as to the role of acids in plant respiration have usually been adaptations of the more thoroughly investigated mechanism of glucose oxidation in heterotrophic cells (muscle tissue, yeast cells) which were not supported by direct experimental evidence.

In the respiration cycle given in scheme 9.II, the conversion of pyruvic acid into malic acid is accompanied by an evolution of carbon dioxide. In the acidification of succulents, on the other hand, no carbon dioxide is liberated (*cf.* Wolf 1931, and Bennet-Clark 1933). This has

caused Wetzel and Ruhland (1932) to apply to the latter process the alternative respiration cycle, 10.II, originally suggested by Toenissen and Brinckman (1931) to explain the failure of attempts to induce certain tissues to use acetate (instead of pyruvate) for the formation of succinate—a substitution which should be possible according to scheme 9.II.

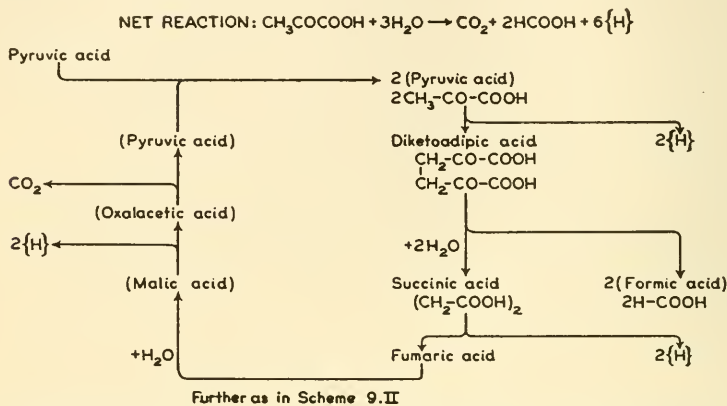

Scheme 10.II.—The respiration cycle after Toenissen and Brinckman.

Scheme 10.II avoids the formation of carbon dioxide between pyruvic and malic acid; but it calls instead for the formation of two molecules of formic acid, which has not been observed in succulents, and whose fate must be explained before the scheme can be considered as plausible.

Schemes 9.II and 10.II do not include citric acid. However, in the study of animal respiration, citric acid has also been found to play an important part. Krebs and Johnson (1937), Martius and Knoop (1937), and Martius (1937, 1938) have attempted to account for this part by a new cycle, which starts with one molecule each of oxalacetic acid and pyruvic acid, and ends with the restoration of oxalacetic acid and the decomposition of pyruvic acid. This cycle includes citric, aconitic, isocitric, oxalosuccinic, α -ketoglutaric and succinic acids as intermediates; the further transformation of succinic acid follows scheme 9.II. Since many details of this cycle are controversial, we do not reproduce it here. The essential point is that, according to it, both citric and malic acid are intermediates of respiration, with citric acid *preceding* malic acid in the cycle. It is thus tempting to apply this cycle to the formation of malic and citric acid in plants. Pucher, Clark, and Vickery (1937) noticed that the sum of the malic and citric acid in rhubarb is approximately constant throughout the leaf, but the proportion of citric acid increases and that of malic acid decreases from stem to tip, thus indicating an interconversion of the two acids. However, it seems that, in leaves, malic acid is

converted in the dark into citric acid (rather than vice versa), as if the Krebs-Martius-Knoop cycle were running in reverse. Thus, Mikhlin and Bakh (1938) found that tobacco leaves convert externally supplied pyruvic, malic, and oxalacetic acids into citric acid. Pucher, Wakeman, and Vickery (1937) added the observation that, in tobacco leaves, malic acid disappears in darkness and is replaced by an equivalent quantity of citric acid.

It is by no means certain that all glucose respiration in plants proceeds through a triose stage. To the contrary, evidence has been obtained of glucose oxidation processes which begin by direct oxidation to glucuronic acids (*cf.*, for example, Müller 1928, Boysen-Jensen 1931, and Harrison 1933). Recently, this mechanism was also discussed by Emerson, Stauffer and Umbreit (1944). It is possible that the formation of citric acid in plants occurs by a similar mechanism; at least this assumption has been found useful in the discussion of the way in which citric acids is produced from sugars by certain moulds, *Aspergillus niger*, for example (*cf.* Butkevich 1925; Butkevich and Gaevskaia 1935; Barinova and Butkevich 1936; Wells, Moyer and May 1936). Allsop (1937) suggested that oxalic acid, too, is formed by moulds by the way of uronic acids, and not by the intermediary of C_2 compounds.

E. ASCORBIC ACID IN GREEN PLANTS*

1. Ascorbic Acid in the Chloroplasts

The function of ascorbic acid (vitamin C) in plants is unknown, but its formula, which shows it to be a dehydrogenation product of hexoses, indicates the possibility of its being an intermediate product of either photosynthesis or respiration. On the other hand, the capacity of ascorbic acid for reversible oxidation-reduction may assign to it the part of an oxidation-reduction *catalyst*, rather than that of an *intermediate*.

Ascorbic acid was the subject of very extensive research, and only a few results can be communicated here. (For more ample information, we may refer to the monograph by Giroud 1938.) The compound is present in the green parts of all plants, and in many colorless plant tissues as well. Giroud, Ratsimamanga and Leblond (1934) and Giroud, Leblond and Ratsimamanga (1934) found a significant parallelism between the concentration of ascorbic acid and that of chlorophyll in different plants; this conclusion was later contested by Mirimanoff (1938, 1939), who suggested an association of ascorbic acid with *flavonols* in the cell sap; but Giroud's statistical relationships were confirmed by other investigators, *e. g.*, Reid (1938) and Moldtmann (1939). However, Neish's (1939) direct determinations of the ascorbic acid content of separated chloroplast matter (*cf.* Chapter 14) did not show much difference between its concentration in the chloroplasts and in the leaves as a whole, as shown by table 10.III. Bukatsch (1940) used dichlorophenol-

* Bibliography, p. 279.

TABLE 10.III
DISTRIBUTION OF ASCORBIC ACID IN LEAVES

Plant	In the chloroplast fraction, % of dry weight	In the nonchloroplast fraction, % of dry weight
<i>Trifolium pratense</i>	2.53	2.57
<i>Onoclea sensibilis</i>	0.57	0.13
<i>Elodea canadensis</i>	0.65	0.33
<i>Arctium minus</i>	0.50	0.77

indophenol as a reagent to prove the presence of ascorbic acid in the isolated chloroplastic material from different plants. He also found that *Elodea* press juice contains 0.008% of *dehydroascorbic* acid. Neish's figures (from 0.5–2.5% ascorbic acid in the chloroplast matter) are of the same order of magnitude as those given by Giroud (1938) and Moldtmann (1939) for the vitamin C concentration in different leaves. (Giroud's data range from 0.05–3% of the dry weight of the leaves.) The content varies greatly not only from species to species, but also with the age of the leaves, the season of the year, and the time of the day.

The proportion of ascorbic acid in the chloroplasts is, by weight, about equal to that of chlorophyll, and consequently several times larger if expressed in moles per liter.

If the results of Neish can be generalized and the ascorbic acid content of chloroplasts is, on the average, not higher than that of the surrounding cytoplasm, a new explanation must be sought for the histochemical experiment which has most often been quoted in support of the theory that ascorbic acid is accumulated in the chloroplasts. This is the blackening of chloroplasts by silver nitrate, a reaction discovered by Molisch (1918). It was attributed to the presence of different reducing agents: Molisch suspected formaldehyde or hydrogen peroxide, Meyer (1918), hexenaldehyde, and Wieler (1936), an essential oil; but Giroud, Ratsimamanga, and Leblond (1934) found that the reduction of silver nitrate by the chloroplasts can also be observed in an acid medium (*e. g.*, 10% silver nitrate + 1% acetic acid). This rules out a number of previously suggested reducing agents, and Giroud suggested that ascorbic acid is responsible for the reaction. He was opposed by Mirimanoff (1938, 1939), who stated that the reduction of silver nitrate in acid solution can also be caused by tannins, flavonols, etc. (Fehling reagent is, in Mirimanoff's opinion, a better indicator for ascorbic acid; and it is reduced by the cell sap rather than by the chloroplasts.)

On the other hand, Dischendorfer (1937) found that silver nitrate in acid solution is not reduced by aldehydes (*e. g.*, chlorophyll *b*, hexenaldehyde, formaldehyde, furfural, glucose, and other sugars) which are (or can be) present in the chloroplasts, but only by compounds with two OH- or NH₂- groups in para or ortho position (*e. g.*, hydroquinone, *p*-phenylenediamine, or pyrogallol). In his opinion, ascorbic acid is the only substance of this kind which is known to occur in the chloroplasts.

The black silver deposit in the chloroplasts resulting from Molisch's test often shows a splotchy structure which is strongly reminiscent of the granular structure of the intact chloroplasts (*cf.* Chapter 14). Weber (1937²) and Pekarek (1938) believed that

the stroma is blackened and the grana stand out colorless after treatment with silver nitrate, and interpreted this as an indication that the (water-soluble) ascorbic acid is accumulated in the hydrophylic stroma rather than in the more lipophylic chlorophyll grana.

However, in interpreting these results, two points must be kept in mind. In the first place, the structure revealed by the Molisch test is a *post mortem* effect, since silver nitrate kills the cells; in the second place, the granular structure is not the only one observed in silver nitrate experiments—in some plants, silver patterns of a different kind are observed (*cf.* Weber 1937¹, and Liebaltd 1938). If one insists on ascribing the Molisch reaction to ascorbic acid, and at the same time believes Neish's results showing an approximately uniform distribution of this acid between the chloroplasts and the rest of the leaves, one has to assume that some unknown factors preclude the reduction of silver nitrate by ascorbic acid in the cytoplasm and favor the same reaction in the chloroplasts.

Gauteret (1934, 1935) observed that the Molisch reaction occurs only in light; according to Giroud (1938) it is true that the reaction starts more rapidly in light; but it can proceed in the dark as well. Perhaps, then, the preferential reduction of silver nitrate by the chloroplasts is a photographic development process, with the nuclei being provided by a photochemical reaction, and chlorophyll playing the part of sensitizer. Rackshitt (1938) found an argument in favor of an association between chlorophyll and ascorbic acid in the observation that ascorbic acid is protected against auto-oxidation by 2×10^{-4} mole per liter of colloidal chlorophyll. Ascorbic acid also has a tendency of associating itself with proteins (compare von Euler 1937 and Reedman and McHenry 1938).

2. Ascorbic Acid—An Intermediate or Catalyst?

Ascorbic acid contains a six-membered carbon chain and a five-membered lactone ring ($C_6H_8O_6$; molecular weight, 176; $L = 0.33$) shown in the following formula 10.I. The close relation of ascorbic acid to

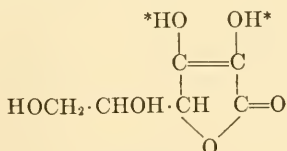

Formula 10.I
Ascorbic acid

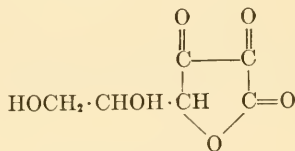

Formula 10.II
Dehydroascorbic acid

hexoses is indicated. The compound can be synthesized *in vitro* from glucose, mannose, and other sugars, and it is probable that plants produce it in the same way (*cf.* Ray 1934). Gaha and Ghosh (1935), Bukatsch (1940), Reid (1938), and Moldtmann (1939) found that the concentration of ascorbic acid in plants can be increased by supply of glucose. Conditions which indirectly increase the production of sugar, as an ample supply of carbon dioxide and good illumination, also tend to increase the concentration of ascorbic acid.

Ascorbic acid is characterized by its acidity and its capacity for reversible oxidation. The two H atoms marked by asterisks in the formula dissociate as H^+ ions with a first

dissociation constant of about 6.2×10^{-6} (pK 4.21) (*cf.* Ball 1937). (This is the extrapolated dissociation constant at the ionic strength $\mu = 0$; from measurements of the oxidation-reduction potential—see below—a value of 9.1×10^{-5} at $\mu = 0.1$ was obtained.) Consequently, the acid must be present in the tissues almost entirely as an anion (or as a metalloorganic complex). The large dissociation constant seems at first to contradict the accepted formula, since the latter shows no carboxyl group. However, the group, $-\text{COH}=\text{COH}-\text{CO}-$, apparently has an acid character similar to that of a carboxyl group (*cf.* Ball 1937). Ascorbic acid has an L value of 0.833, that is, it is a partially oxidized sugar. Its main tendency is to oxidize itself further, by losing two or even four hydrogen atoms. In a certain pH range, this loss is reversible, particularly as far as the first step is concerned. It transforms ascorbic acid into dehydroascorbic acid ($\text{C}_6\text{H}_6\text{O}_6$, $L = 0.75$, *cf.* Formula 10.II).

Many attempts have been made to determine the oxidation-reduction potential of the ascorbic acid–dehydroascorbic acid system, *i. e.* by Georgescu (1932), Wurmser and Loureiro (1933), Green (1933), Borsook and Keighley (1933), Fruton (1934), Borsook, Davenport, Jeffries, and Warner (1937), and Ball (1937). According to Ball (1937), the system is electrochemically sluggish, so that “electrode catalysts” (for example, thionine or methylene blue) must be added to accelerate the establishment of the electrode equilibrium. Furthermore, according to Borsook and Keighley (1933) and Ball (1937), the oxidant (dehydroascorbic acid) is unstable in neutral solution ($pH > 5.75$). Therefore, reliable potentials can be obtained only in the acid range. (Above pH 6 the “apparent” normal potential becomes more positive with time because the oxidant gradually disappears from the system).

Taking these complications into account, Ball was able to calculate the normal potentials of the ascorbic acid–dehydroascorbic acid system between pH 1 and pH 8.6, and obtained (for 30°C.) the values $E_0 = -0.329$ volt for pH 1, and $E_0' = -0.057$ for pH 7.

Neutral solutions of ascorbic acid reduce thionine ($E_0' = -0.06$ v.), cresyl blue ($E_0' = -0.047$ v.) and (slowly) methylene blue ($E_0' = -0.011$ v.), but not Nile blue or phenosafranine ($E_0' = +0.252$ v.). They can be titrated with 2,6-dichlorophenol-indophenol ($E_0' = -0.20$ v.). The oxidation by methylene blue can be accelerated by light, according to Mentzer and Vialard-Goudon (1937). Ascorbic acid also reduces silver nitrate (*cf.* page 270), cupric ions (*e. g.*, Fehling solution), mercuric ions, ferric ions, nitrites, quinones, indophenols, flavones, etc. (*cf.*, for example, King 1939). The reduction of dehydroascorbic acid to ascorbic acid can be achieved by hydrogen sulfide, at pH 3–4.

According to Kellie and Zilva (1938) and Arcus and Zilva (1940), ascorbic acid in solution is oxidized to dehydroascorbic acid by ultraviolet light in the absence of oxygen. The reaction must be either a reduction of water or a dismutation. Pure ascorbic acid is not oxidized directly by oxygen but numerous substances catalyze this reaction (*e. g.*, Cu^{++} ions, in both the free state and in organic complexes; *cf.* King 1939).

The increased production of ascorbic acid in the presence of glucose, as well as its formation in seedlings before the beginning of photosynthesis (*cf.* Rubin and Strachitzky 1936), indicate that it is formed by oxidation of sugars. Therefore, the increase in ascorbic acid concentration following intense assimilation (reported by Giroud 1938, Reid 1938, and Moldtmann 1939) does not necessarily mean that it is an intermediate of photosynthesis (although this possibility, first suggested by von Euler and Klusmann in 1933, cannot be excluded). Photosynthesis may

merely increase the quantity of sugar available for transformation into ascorbic acid.

Quite early, it was suggested that ascorbic acid, with its capacity for reversible oxidation, may play the part of an oxidation-reduction *catalyst*. A difficulty of this concept arises from the instability of the reduced form in the biological pH range. Conditions are somewhat more favorable in plant cells than in animal tissues because of the lower temperature and lower pH values prevailing in them.

As an oxidation-reduction catalyst, ascorbic acid may take part either in the photosynthetic process or in respiration, or both. For example, if chlorophyll is reversibly oxidized in photosynthesis (*cf.* Chapter 19, page 551), it could be reduced again by ascorbic acid, as was suggested by Bukatsch (1939).

Using Baur's language of "molecular electrochemistry," (*cf.* page 90), Bukatsch developed a scheme, which, translated into the language of ordinary photochemistry, has roughly the following meaning: Excited chlorophyll molecules either oxidize water to a peroxide, or reduce carbon dioxide to formaldehyde; in the presence of the "auxiliary redox system," ascorbic acid-dehydroascorbic acid, oxidized chlorophyll is reduced by ascorbic acid and reduced chlorophyll is reoxidized by dehydroascorbic acid, and in this way everything is "depolarized," and ready for the next cycle. We mentioned in chapter 4 (page 93) the experiments on artificial photosynthesis which Bukatsch (1939) made on the basis of this concept; he also claimed (1940) to have achieved a stimulation of natural photosynthesis by the addition of ascorbic acid (*cf.* Chapter 13). An independent experimental control of these results appears desirable.

That ascorbic acid may serve as a catalyst in the *respiration* of plants, was first suggested by Szent-Györgyi (1928, 1931). Catalytic effects of ascorbic acid on the oxidation of fatty acids and sugars *in vitro* were reported, among others, by Holtz (1936). Another catalytic activity of ascorbic acid, possibly related to photosynthesis, is indicated by experiments of West and Ney (1936) and Kuzin (1937), who found that ascorbic acid in alkaline solution accelerates the *polymerization of formaldehyde*.

Bibliography to Chapter 10

Intermediates of Photosynthesis

A. The Hypotheses of Liebig and Baeyer

- 1843 Liebig, J., *Ann. Chemie*, 46, 58.
 1870 v. Baeyer, A., *Ber. deut. chem. Ges.*, 3, 63.
 1913 Baur, E., *Naturwissenschaften*, 1, 474.

B. Low Molecular Weight Compounds in Green Plants

(except formaldehyde, oxalic, malic, citric, and ascorbic acid)

- 1872 Gorup-Besanez, E. V., *Ann. Chem. (Liebig)*, 161, 229.
 1881 Reinke, J., *Ber. deut. chem. Ges.*, 14, 2145.

- 1882 Bergmann, E., *Botan. Z.*, **40**, 731.
- 1886 Brunner, H., and Chuard, E., *Ber. deut. chem. Ges.*, **19**, 595.
- 1891 Ordonneau, E., *Bull. soc. chim.*, (3) **6**, 261.
- 1897 Curtius, Th., and Reinke, J., *Ber. deut. botan. Ges.*, **15**, 201.
- 1899 Reinke, J., and Braunnüller, E., *ibid.*, **17**, 7.
Shorey, E. C., *J. Am. Chem. Soc.*, **21**, 45.
- 1900 Stolle, F., *Z. ver. Rübenind.*, **1900**, 609.
- 1906 von Euler, H., *Ber. deut. chem. Ges.*, **39**, 50.
- 1909 von Euler, H., and Bolin, I., *Z. physiol. Chem.*, **61**, 1.
- 1910 Curtius, Th., and Franzen, H., *Sitzber. heidelberger Akad. Wiss. Math. naturw. Klasse*, **1910**, Abh. No. 20.
- 1912 Curtius, Th., and Franzen, H., *Ann. Chem. (Liebig)*, **390**, 89.
Curtius, Th., and Franzen, H., *Sitzber. heidelberger Akad. Wiss. Math. naturw. Klasse*, **1912**, Abh. No. 6.
Curtius, Th., and Franzen, H., *ibid.*, **1912**, Abh. No. 7.
Curtius, Th., and Franzen, H., *ibid.*, **1912**, Abh. No. 8.
Curtius, Th., and Franzen, H., *ibid.*, **1912**, Abh. No. 9.
McGeorge, W., *J. Am. Chem. Soc.*, **34**, 1625.
Curtius, Th., and Franzen, H., *Ber. deut. chem. Ges.*, **45**, 1715.
- 1913 Nieloux, M., *Bull. soc. chim.*, **13**, 939.
Fincke, H., *Biochem. Z.*, **52**, 214.
- 1914 Fincke, H., *ibid.*, **61**, 57.
Curtius, Th., and Franzen, H., *Ann. Chem. (Liebig)*, **404**, 93.
Curtius, Th., and Franzen, H., *Sitzber. heidelberger Akad. Wiss. Math. naturw. Klasse*, **1914**, Abh. No. 7.
Curtius, Th., and Franzen, H., *ibid.*, **1914**, Abh. No. 22.
- 1915 Curtius, Th., and Franzen, H., *ibid.*, **1915**, Abh. No. 5.
- 1916 Curtius, Th., and Franzen, H., *ibid.*, **1916**, Abh. No. 7.
Palladin, V. I., *Bull. acad. sci. St. Pétersbourg*, **1916**, 1021.
- 1917 Meyer, A., *Ber. deut. botan. Ges.*, **35**, 586, 674.
- 1918 Meyer, A., *ibid.*, **36**, 235.
Franzen, H., and Wagner, A., *Sitzber. heidelberger Akad. Wiss. Math. naturw. Klasse*, **1918**, Abh. No. 4.
- 1920 Mazé, P., *Compt. rend.*, **171**, 1391.
Franzen, H., and Wagner, A., *Sitzber. heidelberger Akad. Math. naturw. Klasse*, **1920**, Abh. No. 2.
Franzen, H., *Z. physiol. Chem.*, **112**, 301.
- 1921 Rouge, E., *Schweizer Apoth. Ztg.*, **59**, 157, 175.
Franzen, H., Wagner, A., and Schneider, A., *Biochem. Z.*, **116**, 208.
Franzen, H., and Schumacher, E., *Z. physiol. Chem.*, **115**, 9.
Franzen, H., and Stern, E., *ibid.*, **115**, 270.
Franzen, H., and Keyssner, E., *ibid.*, **116**, 166.
- 1922 Franzen, H., and Ostertag, R., *ibid.*, **119**, 150.
Franzen, H., and Stern, E., *ibid.*, **121**, 195.
- 1923 Franzen, H., and Keyssner, E., *Biochem. Z.*, **135**, 183.
Franzen, H., and Helvert, F., *ibid.*, **135**, 384.
Franzen, H., and Helvert, F., *ibid.*, **136**, 291.

- Franzen, H., and Ostertag, R., *Biochem. Z.*, **137**, 327.
 Franzen, H., and Keyssner, H., *Z. physiol. Chem.*, **129**, 309.
 Schmalfuss, H., *ibid.*, **131**, 166.
 1924 Griebel, C., *Z. Untersuch. Nahru. Genussm.*, **47**, 438.
 Griebel, C., *ibid.*, **48**, 218, 221.
 1925 Griebel, C., *ibid.*, **49**, 94, 105.
 Klein, G., and Werner, O., *Z. physiol. Chem.*, **142**, 141.
 Czapek, F., *Biochemie der Pflanzen*. Vol. 3, 3rd ed., G. Fischer, Jena, 1925, Chapters 58 and 68.
 Klein, G., and Pirschle, K., *Naturwissenschaften*, **13**, 22.
 1926 Klein, G., and Pirschle, K., *Biochem. Z.*, **168**, 340.
 1931 Nelson, E. K., and Hasselbring, H., *J. Am. Chem. Soc.*, **53**, 1040.
 Nelson, E. K., and Mottern, H. H., *ibid.*, **53**, 1909, 3046.
 Vickery, H. B., and Pucher, G. W., *J. Biol. Chem.*, **90**, 637.
 Vickery, H. B., and Pucher, G. W., Conn. Agr. Expt. Sta., *Bull.* **323**, 155.
 1933 Bennet-Clark, T. A., *New Phytologist*, **32**, 37, 128, 197.
 1934 Gustafson, F. G., *Biochem. Z.*, **272**, 172.
 1936 Wieler, A., *Protoplasma*, **26**, 295.
 1937 Dischendörfer, O., *ibid.*, **28**, 516.
 1938 Rabaté, J., and Gourévitch, A., *Rev. botan. appl. agr. trop.*, **18**, 604.
 Rabaté, J., and Gourévitch, A., *J. pharm. chim.*, **28**, 386.
 1939 Schneider, A., *Planta*, **29**, 747.
 1940 Kolesnikov, P. A., *Compt. rend. acad. sci. URSS*, **27**, 353.
 Pucher, G. W., and Vickery, H. B., *Plant Physiol.*, **16**, 771.
 Spoehr, H. A., Smith, J. H. C., Strain, H. H., and Milner, H. W., *Carnegie Inst. Yearbook*, **39**, 147.
 1941 Pucher, G. W., and Vickery, H. B., *Ind. Eng. Chem., Anal. Ed.*, **13**, 40.

C. The Formaldehyde Problem

- 1870 Baeyer, A. v., *Ber. deut. chem. Ges.*, **3**, 63.
 1881 Reinke, J., *ibid.*, **14**, 2145.
 1885 Meyer, A., *Botan. Z.*, **43**, 416.
 1887 Loew, O., and Bokorny, Th., *J. prakt. Chem.*, **36**, 272.
 1888 Bokorny, Th., *Ber. deut. botan. Ges.*, **6**, 116.
 1892 Bokorny, Th., *Landw. Jahrb.*, **1892**, 459.
 1897 Bokorny, Th., *Biol. Zentr.*, **17**, 1, 33.
 Curtius, Th., and Reinke, J., *Ber. deut. botan. Ges.*, **15**, 201.
 1899 Pollacci, G., *Atti Ist. Botan. Pavia*, **6**, 27.
 Pollacci, G., *ibid.*, **7**, 45.
 1901 Bouilhac, R., *Compt. rend.*, **133**, 751.
 1902 Bouilhac, R., *ibid.*, **135**, 1369.
 1903 Bouilhac, R., and Giustianini, *ibid.*, **136**, 1155.
 Bottomley, W. B., and Jackson, H., *Proc. Roy. Soc. London*, **72**, 130.
 Treboux, O., *Flora*, **92**, 49.
 1904 Plancher, G., and Ravenna, C., *Atti accad. Lincei*, **13**, II, 459.
 1905 Treboux, O., *Ber. deut. botan. Ges.*, **23**, 432.

- 1906 Grafe, V., *Oesterr. botan. Ztg.*, **56**, 289.
- 1907 Pollacci, G., *Atti accad. Lincei*, **16**, I, 199.
- 1908 Bokorny, Th., *Arch. ges. Physiol. (Pflüger)*, **125**, 467.
- 1909 Bokorny, Th., *ibid.*, **128**, 565.
Grafe, V., and Vortheim, L., *Oesterr. botan. Ztg.*, **59**, 19.
Grafe, V., and Vieser, E., *Ber. deut. botan. Ges.*, **27**, 431.
- 1910 Schryver, S. B., *Proc. Roy. Soc. London B*, **82**, 226.
- 1911 Bokorny, Th., *Biochem. Z.*, **36**, 83.
Grafe, V., *Ber. deut. botan. Ges.*, **29**, 19.
- 1912 Curtius, Th., and Franzen, H., *ibid.*, **45**, 1715.
- 1913 Baker, S. M., *Ann. Botany*, **27**, 411.
Spoehr, H. A., *Biochem. Z.*, **57**, 95.
Fincke, H., *ibid.*, **52**, 214.
- 1915 Curtius, Th., and Franzen, H., *Sitzber. heidelberger Akad. Wiss. Math. naturw. Klasse*, **1915**, Abh. No. 5.
- 1916 Spoehr, H. A., *Plant World*, **19**, 1.
- 1918 Willstätter, R., and Stoll, A., *Untersuchungen über die Assimilation der Kohlensäure*. Springer, Berlin, 1918.
- 1920 Jacoby, M., *Biochem. Z.*, **101**, 1.
- 1922 Jacoby, M., *ibid.*, **128**, 119.
Nicolas, E., and Nicolas, G., *Compt. rend.*, **175**, 1437.
Nicolas, E., and Nicolas, G., *Compt. rend. soc. biol.*, **87**, 1315.
Sabalitschka, Th., *Ber. deut. pharmakol. Ges.*, **32**, 278.
- 1923 Nicolas, E., and Nicolas, G., *Compt. rend.*, **176**, 404.
- 1924 Sabalitschka, Th., *Biochem. Z.*, **148**, 370.
Sabalitschka, Th., and Riesenberg, H., *ibid.*, **144**, 545.
Sabalitschka, Th., and Riesenberg, H., *ibid.*, **144**, 551.
Sabalitschka, Th., and Riesenberg, H., *ibid.*, **145**, 373.
- 1926 Klein, G., and Werner, O., *ibid.*, **168**, 361.
van Goor, A. C. J., *Atti accad. Fisiocritici Siena Sez. med.-fis.*, **1926**.
Sabalitschka, Th., and Weidling, H., *Biochem. Z.*, **172**, 45.
Sabalitschka, Th., and Weidling, H., *ibid.*, **176**, 210.
- 1927 Bodnár, J., Róth, L. E., and Bernauer, C., *ibid.*, **190**, 304.
Klein, G., *Z. Botan.*, **20**, 36, 43.
Noack, K., *ibid.*, **20**, 41.
- 1928 Sabalitschka, Th., *Biochem. Z.*, **197**, 193.
Bodnár, J., *ibid.*, **201**, 281.
Vorländer, D., *Planta*, **6**, 684.
- 1929 Pollacci, G., and Bergamaschi, M., *Atti accad. Lincei*, **10**, 687.
Pollacci, G., and Bergamaschi, M., *Atti ist. botan. Pavia*, (4) **1**, 152.
- 1930 Pollacci, G., and Bergamaschi, M., *ibid.*, (4) **2**, 1.
Godnev, T. N., and Korshenevski, S. K., *Planta*, **12**, 184.
Barton-Wright, E. C., and Pratt, M. C., *Biochem. J.*, **24**, 1210.
- 1932 Lwoff, A., *Recherches biochimiques sur la nutrition des protozoaires*. Paris, 1932.
- 1933 Sommer, A. L., Bishop, E. R., and Otto, I. G., *Plant Physiol.*, **8**, 564.

- 1935 Lwoff, A., and Dusi, M., *Compt. rend. soc. biol.*, **119**, 1260.
 1938 Paechnatz, G., *Z. Botan.*, **32**, 161.

D. *The Problem of Plant Acids (Oxalic, Malic, Citric)*

- 1686 Malpighi, M., *Opera omnia*. London, 1686.
 1800 Vauquelin, L. N., *Ann. chim.*, **34**, 127.
 1819 Heyne, B., *Trans. Linnean Soc.*, **9**, 213.
 1873 Kraus, C., *Neues Repert. Pharm.*, **22**, 273.
 1878 Meyer, A., *Landw. Vers.-Sta.*, **21**, 277.
 1884 de Fries, H., *Botan. Z.*, **42**, 337, 353.
 1886 Warburg, O., *Untersuch. botan. Inst. Tübingen*, **2**, 75.
 1887 Meyer, A., *Landw. Vers. Sta.*, **34**, 127.
 1890 Aubert, E., *Rev. gén. botan.*, **2**, 369.
 1891 Aubert, E., *Compt. rend.*, **112**, 674.
 Ordonneau, E., *Bull. soc. chim.*, (3) **6**, 261.
 1892 Aubert, E., *Rev. gén. botan.*, **4**.
 1897 Bokorny, Th., *Biol. Zentr.*, **17**, 1, 33.
 1899 Zumstein, H., *Jahrb. wiss. Botan.*, **34**.
 1903 Treboux, O., *Flora*, **92**, 49.
 Astruc, A., *Ann. sci. nat. Botan.*, **17**, 1.
 1913 Spoehr, H. A., *Biochem. Z.*, **57**, 95.
 1915 Richards, H. M., *Carnegie Inst. Wash. Pub.*, No. 209.
 1918 Willstätter, R., and Stoll, A., *Untersuchungen über die Assimilation der Kohlensäure*. Springer, Berlin, 1918.
 1923 Volmar, M., *Compt. rend.*, **176**, 742.
 Franzen, K., and Keyssner, E., *Biochem. Z.*, **135**, 183.
 Franzen, K., and Helvert, F., *ibid.*, **135**, 384; **136**, 291.
 Franzen, K., and Keyssner, E., *Z. physiol. Chem.*, **129**, 309.
 1925 Butkevich, W., *Jahrb. wiss. Botan.*, **64**, 637.
 Czapek, F., *Biochemie der Pflanzen*. Vol. 3, 3rd ed., G. Fischer, Jena, p. 1925, p. 71.
 Klein, G., and Werner, O., *Z. physiol. Chem.*, **142**, 141.
 1926 Ruhland, W., and Wetzel, K., *Planta*, **1**, 558.
 Ullrich, H., *ibid.*, **1**, 565.
 1927 Ruhland, W., and Wetzel, K., *ibid.*, **3**, 765.
 Wetzel, K., *ibid.*, **4**, 476.
 1928 Müller, D., *Biochem. Z.*, **199**, 136.
 1929 Ruhland, W., and Wetzel, K., *Planta*, **7**, 503.
 Bendrat, M., *ibid.*, **7**, 508.
 1931 Toenissen, E., and Brinkman, E., *Z. physiol. Chem.*, **187**, 137.
 Kylin, H., *ibid.*, **197**, 7.
 Boysen-Jensen, P., *Biochem. Z.*, **236**, 211.
 Wetzel, K., and Ruhland, W., *Planta*, **15**, 567.
 Wolf, J., *ibid.*, **15**, 572.
 Vickery, H. B., and Pucher, G. W., *J. Biol. Chem.*, **90**, 637.
 1932 Schwartze, P., *Planta*, **18**, 168.

- Lwoff, A., *Recherches biochimiques sur la nutrition des protozoaires*. Paris, 1932.
- 1933 Pucher, G. W., and Vickery, H. B., *Proc. Natl. Acad. Sci. U. S.*, **19**, 623.
- Vickery, H. B., and Pucher, G. W., Conn. Agr. Expt. Sta., *Bull.* **352**.
- Harrison, D. C., *Biochem. J.*, **27**, 382.
- Bennet-Clark, T. A., *New Phytologist*, **32**, 37, 128, 197.
- 1934 Bennet-Clark, T. A., *Biochem. J.*, **28**, 45.
- Ruhland, W., and Wolf, J., *Ann. Rev. Biochem.*, **3**, 501.
- Zacharova, T. M., *Biochem. Z.*, **270**, 281.
- Guthrie, J. D., *Am. J. Botany*, **21**, 706.
- Borgström, G. A., *Kgl. Fysiogt. Sällsk. Lund.*, **4**, No. 16 and 25.
- 1935 Bennet-Clark, T. A., and Woodruff, W. M., *New Phytologist*, **34**, 77.
- Vickery, H. B., and Pucher, G. W., Conn. Agr. Expt. Sta., *Bull.* **374**.
- Butkevich, V. S., and Gaevskaja, M. S., *Compt. rend. acad. sci. URSS*, **1935**, **III**, 405.
- Lwoff, A., and Dusi, M., *Compt. rend. soc. biol.*, **119**, 1260.
- 1936 Wells, P. A., Moyer, A. J., and May, O. E., *J. Am. Chem. Soc.*, **58**, 555.
- Barinova, S. A., and Butkevich, V. S., *Microbiology USSR*, **5**, 768.
- Ruhland, W., and Wolf, J., *Ann. Rev. Biochem.*, **5**, 985.
- Pucher, G. W., Sherman, C. C., and Vickery, H. B., *J. Biol. Chem.*, **113**, 235.
- 1937 Bennet-Clark, T. A., *Ann. Rev. Biochem.*, **6**, 579.
- Allsop, A., *New Phytologist*, **36**, 327.
- Pucher, G. W., Clark, H. E., and Vickery, H. B., *J. Biol. Chem.*, **117**, 599.
- Pucher, G. W., Clark, H. E., and Vickery, H. B., *ibid.*, **117**, 605.
- Pucher, G. W., Wakeman, A. J., and Vickery, H. B., *ibid.*, **119**, 523.
- Vickery, H. B., Pucher, G. W., Wakeman, A. J., and Leavenworth, C. S., Conn. Agr. Expt. Sta., *Bull.* **399**.
- Wolf, J., *Planta*, **26**, 516.
- Krebs, H. A., and Johnson, W. A., *Enzymologia*, **4**, 148.
- Martius, C., and Knoop, F., *Z. physiol. Chem.*, **246**, 1.
- Martius, C., *ibid.*, **247**, 104.
- 1938 Martius, C., *ibid.*, **257**, 29.
- Pucher, G. W., Wakeman, A. J., and Vickery, H. B., *J. Biol. Chem.*, **126**, 43.
- Pucher, G. W., Vickery, H. B., and Wakeman, A. J., *Plant Physiol.*, **13**, 621.
- Mikhlin, D. M., and Bakh, A. N., *Bull. acad. sci. URSS*, **1938**, 991.
- Vickery, H. B., Pucher, G. W., Wakeman, A. J., and Leavenworth, C. S., Conn. Agr. Expt. Sta., *Bull.* **407**, 111.
- 1939 Vickery, H. B., Pucher, G. W., Wakeman, A. J., and Leavenworth, C. S., *ibid.*, **424**, 7.
- Vickery, H. B., and Pucher, G. W., *ibid.*, **424**, 107.
- Vickery, H. B., and Pucher, G. W., *J. Biol. Chem.*, **128**, 685.

- Pucher, G. W., Wakeman, A. J., and Vickery, H. B., *Plant Physiol.*, **14**, 333.
 Wolf, J., *Planta*, **28**, 60.
 Wolf, J., *ibid.*, **29**, 314, 450.
 Thoday, D., and Jones, M. K., *Ann. Botany*, **3**, 677.
- 1940 Vickery, H. B., and Pucher, G. W., *Ann. Rev. Biochem.*, **9**, 529.
 1941 Pucher, G. W., and Vickery, H. B., *Ind. Eng. Chem., Anal. Ed.*, **13**, 412.
 1944 Emerson, R. L., Stauffer, J. F., and Umbreit, W. W., *Am. J. Botany*, **31**, 107.
- E. Ascorbic Acid in Green Plants**
- 1918 Molisch, H., *Sitzber. Akad. Wiss. Wien Math.-naturw. Klasse, Abt. I*, **127**, 449.
 Mayer, A., *Ber. deut. botan. Ges.*, **36**, 235.
- 1928 Szent-Györgyi, A., *Biochem. J.*, **22**, 1387.
 1931 Szent-Györgyi, A., *J. Biol. Chem.*, **90**, 385.
 1932 Georgescu, I.-D., *J. chim. phys.*, **29**, 217.
 1933 Wurmser, R., and Loureiro, *Compt. rend. soc. biol.*, **113**, 543.
 Green, D. E., *Biochem. J.*, **27**, 1044.
 Borsook, H. S., and Keighley, G., *Proc. Natl. Acad. Sci. U. S.*, **19**, 875.
 von Euler, H., and Klussmann, E., *Z. physiol. Chem.*, **219**, 215.
- 1934 Giroud, A., Ratsimamanga, R., and Leblond, C. P., *Compt. rend. soc. biol.*, **117**, 612.
 Giroud, A., Leblond, C. P., and Ratsimamanga, R., *ibid.*, **117**, 614.
 Gauteret, R., *Compt. rend.*, **198**, 1252.
 Ray, S. N., *Biochem. J.*, **28**, 996.
 Fruton, J. S., *J. Biol. Chem.*, **105**, 79.
- 1935 Gauteret, R., *Rev. gén. botan.*, **47**, 401, 484.
 Gaha, B. C., and Ghosh, A. R., *Nature*, **135**, 234, 871.
- 1936 Wieler, A., *Protoplasma*, **26**, 295.
 West, E., and Ney, L. F., *Science*, **84**, 294.
 Holtz, P., *Arch. exptl. Path. Pharmacol.*, **182**, 98, 109.
 Rubin, B. A., and Strachitzky, K., *Biochimia USSR*, **1**, 343.
- 1937 Mentzer, C., and Vialard-Goudon, A., *Bull. soc. chim.*, **19**, 707.
 Borsook, H. S., Davenport, H. W., Jeffreys, C. E. P., and Warner, R. C., *J. Biol. Chem.*, **117**, 237.
 Ball, E. G., *ibid.*, **118**, 219.
 von Euler, H., "Les regulations hormonales," *Rapp. journées méd. int. Paris*, **1937**.
 Weber, F., *Protoplasma*, **218**, 283.
 Kuzin, A. M., *Biochimia USSR*, **2**, 127.
 Dischendorfer, O., *Protoplasma*, **28**, 516.
 Weber, F., *ibid.*, **29**, 516.
- 1938 Reid, M. E., *Am. J. Botany*, **25**, 701.
 Pekarek, J., *Protoplasma*, **30**.
 Rackshit, P. C., *Biochem. Z.*, **297**, 153.

- Liebaladt, E., *Protoplasma*, **31**, 267.
- Reedman, E. J., and McHenry, E. W., *Biochem. J.*, **32**, 85.
- Giroud, A., *L'acide ascorbique dans la cellule et les tissus*. Borntraeger, Berlin, 1938.
- Mirimanoff, G., *Compt. rend.*, **206**, 766, 1038.
- Kellie, A. E., and Zilva, S. S., *Biochem. J.*, **32**, 1561.
- 1939 King, C. G., *Cold Spring Harbor Symposia Quant. Biol.*, **7**, 137.
- Neish, A. C., *Biochem. J.*, **38**, 300.
- Bukatsch, F., *Planta*, **30**, 118.
- Mirimanoff, M. A., *Rev. cytol. cytophys. végét.*, **3**, 115.
- Moldtmann, H. G., *Planta*, **30**, 297.
- 1940 Bukatsch, F., *ibid.*, **31**, 209.
- Arcus, C. L., and Zilva, S. S., *Biochem. J.*, **34**, 61.



CHAPTER 11

THE NONPHOTOCHEMICAL REACTIONS IN PHOTOSYNTHESIS

III. LIBERATION OF OXYGEN *

In chapter 7, it was assumed that one—and perhaps the only—primary photochemical process in photosynthesis consists in a direct oxidation of water (or in the oxidation of an intermediate reductant, HZ, which in its turn oxidizes water) by an intermediate oxidant, X (which in its turn reduces carbon dioxide). In chapters 8 and 9, we dealt with the *catalytic mechanism of reduction of carbon dioxide* by the “primary reduction product,” HX. Now, we shall deal with the *catalytic mechanism of oxidation of water*, that is, the evolution of oxygen from the “primary photochemical oxidation product,” designated by {OH} or Z in chapter 7.

In chapter 6, we concluded from the phenomena of “adaptation” and “de-adaptation” of green algae that the conversion of the primary photochemical oxidation product into free oxygen involves the formation of (at least) one intermediate (which was designated there as {O₂}), and therefore requires the assistance of (at least) two catalysts, which were designated as E_C and E_O, respectively (*cf.* Gaffron 1944). We are at present concerned with the nature of these intermediates and enzymes.

1. The Peroxide Problem

The problem of the conversion of the primary oxidation product into oxygen can be called the “peroxide problem” because the main question is whether the intermediate in this transformation is a free peroxide and, if so, whether it is hydrogen peroxide or another compound containing an O—O bond. A similar problem is encountered in the study of the reverse processes (respiration and combustion). There, the transfer of hydrogen atoms to oxygen leads, in the simplest case, to the primary formation of *hydrogen peroxide*:



which is either *reduced* to water in a second oxidation-reduction step:



* Bibliography, page 298.

or (more commonly) *dismuted* to water and oxygen:



Instead of hydrogen peroxide, *organic peroxides* may be formed and decomposed by reactions analogous to (11.1), (11.2) and (11.3).

In many metabolic oxidations, the formation of free peroxides is avoided by the action of enzymes (*oxidases*), which bind oxygen and release water:



Oxygen evolution in photosynthesis may proceed by the reversal of any of these mechanisms. We shall thus consider the following possibilities:

(a) the intermediary formation of *hydrogen peroxide*, *e. g.*, by a photochemical reversal of reaction (11.2), followed either by the reduction of this peroxide by a reversal of reaction (11.1), or (more probably) by its dismutation according to equation (11.3);

(b) similar processes involving *organic peroxides*; and

(c) oxygen evolution without the intermediate formation of free peroxides, *i. e.*, a reversal of reaction (11.4).

2. The Hydrogen Peroxide Hypothesis

If the primary photochemical oxidation product is an oxidized intermediate, Z (*cf.* Eq. 7.10a), the formation of hydrogen peroxide by the next step in photosynthesis can be formulated as follows:

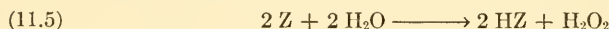

If, on the other hand, water participates directly in the photochemical process, in the form of a complex, {H₂O}, the formation of hydrogen peroxide can be interpreted as dimerization of the primary radicals:

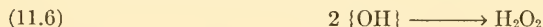

Whether hydrogen peroxide occurs as an intermediate in respiration is of considerable importance for the utilization of energy released in this process, because the dismutation of one mole of hydrogen peroxide according to reaction (11.3) liberates as much as 23 kcal and this energy must be considered as lost for the organism.

In discussing the thermochemical background of photosynthesis in chapter 9, we stated that, as a rule, the energies of dismutations are small. However, in the case of hydrogen peroxide, the difference between the strength of two single O—O bonds (72 kcal) and that of a double O=O bond (118 kcal) is so large that the dismutation of this compound into water and oxygen is strongly exothermal (*cf.* Table 11.I).

TABLE 11.1
THERMODYNAMIC DATA ON HYDROGEN PEROXIDE AND WATER

Reaction	ΔH	ΔF (298° C.)	E_0 (pH 0)	E_0' (pH 7)
(11.1') $O_2(g.) + H_2 \longrightarrow H_2O_2(aq.)$	- 45.7	- 31.5	-0.69	-0.27
(11.2') $H_2O_2(aq.) + H_2 \longrightarrow 2 H_2O(l.)$	- 91.1	- 81.7	-1.77	-1.35
(11.1',2') $O_2(g.) + 2 H_2 \longrightarrow 2 H_2O(l.)$	-136.7	-113.1	-1.23	-0.81
(11.3) $H_2O_2(aq.) \longrightarrow H_2O(l.) + \frac{1}{2} O_2(g.)$	- 22.7	- 25.1		

Because of the instability of hydrogen peroxide, oxygen acts in reaction (11.1') as a comparatively weak oxidant ($E_0' = -0.27$ volt), and the larger part of the energy of oxidation is released in the second oxidation step (11.2'), which corresponds to $E_0' = -1.35$ volt, or in the dismutation of the peroxide (Eq. 11.3). For example, when a standard

$\begin{array}{c} | & | \\ -C & -C- \\ | & | \\ H & H \end{array}$ bond is oxidized by oxygen to a $\begin{array}{c} | & | \\ -C & =C- \\ | & | \end{array}$ bond, the first oxidation step

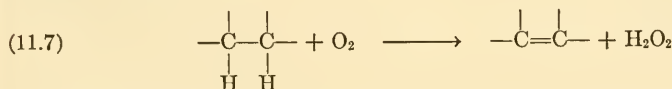

liberates only 5 kcal, while 23 kcal is released by the subsequent dismutation of hydrogen peroxide, and 50 kcal by the oxidation of a second

$\begin{array}{c} | & | \\ -C & -C- \\ | & | \\ H & H \end{array}$ group by H_2O_2 . If, in the oxidation of a triose, all hydrogen

would pass through the stage of hydrogen peroxide, the energy liberation would be divided as follows:

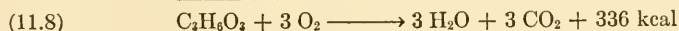
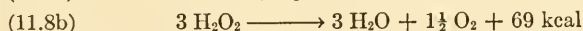
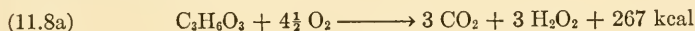

The main channels of animal respiration by-pass hydrogen peroxide (although it can be formed by certain side reactions, as in the direct autoxidation of yellow respiration enzymes). One reason for the avoidance of hydrogen peroxide may be that the energy of peroxide dismutation cannot be utilized for muscular work as easily as is possible with the energy of various oxidation-reductions (by coupling them with transphosphorylations, cf. page 224). Another reason may be that the formation within the cells of oxidants with a potential as negative as

that of hydrogen peroxide is undesirable, even though, in the absence of peroxidase, hydrogen peroxide is a rather inert compound (probably because of the high energy of the radical, H_2O_2 , which is the first product of its stepwise reduction).

If hydrogen peroxide were formed as an intermediate in *photosynthesis*, this would add 46 kcal or 40% to the energy requirement of the over-all process (*cf.* Chapter 3, page 48). Furthermore, it would mean the production in the cells of an oxidant with an extremely negative potential (-1.35 volt) on a scale ten or twenty times larger than that at which it could ever be produced by respiration. These two considerations argue *a priori* against the assumption (repeatedly made in the literature) that hydrogen peroxide is an intermediate of photosynthesis. We shall show presently that experimental evidence also speaks against the "hydrogen peroxide hypothesis."

It is well known that all green plants contain catalase. Warburg thought that, if the dismutation of hydrogen peroxide were the rate-limiting enzymatic reaction in photosynthesis, the capacity of plants for photosynthesis (in strong light and in the presence of abundant carbon dioxide) would be equal to their capacity for catalatic decomposition of externally supplied hydrogen peroxide. In support of this view, Warburg and Uyesugi (1924) quoted the observation that the catalytic activity of *Chlorella* is affected by *cyanide* and *urethane* in approximately the same way as the efficiency of photosynthesis. The same is true according to Kohn (1935), of *hydrogen sulfide* and *iodoacetic acid*. Yabusoe (1924), working in Warburg's laboratory, found that the rate of the hydrogen peroxide decomposition by *Chlorella* shows the same peculiar linear increase with temperature which Warburg had previously attributed to photosynthesis (*cf.* Vol. II, Chapter 31).

The similarity in the response of photosynthesis and catalase activity to different poisons was emphasized anew by Shibata and Yakushiji (1933), Yakushiji (1933) and Nakamura (1938). The first-named authors were led to investigate the sensitivity of photosynthesis to *hydroxylamine* by the fact that this compound was known to be an inhibitor of catalase; having found that it is also a specific poison for photosynthesis, they became convinced that the rate-limiting dark reaction in photosynthesis is the catalase-promoted dismutation of hydrogen peroxide. Nakamura (1938) has given a comparison (Table 11.II) of the effects of different poisons on photosynthesis and on the catalase activity of *Scenedesmus nanus*. The table shows, however, that the effects of poisons on catalase activity and photosynthesis are only approximately the same. According to Warburg and Uyesugi, urethanes are 50% more effective in inhibiting the catalase action of *Chlorella* than in reducing its photosynthesis. Emerson and Green (1937) found that

TABLE 11.II

INHIBITION OF PHOTOSYNTHESIS OF *SCENEDESMUS NANUS* AND OF CATALASE ACTIVITY BY DIFFERENT POISONS (AFTER NAKAMURA)

Compound (10 ⁻⁴ m./l.)	Inhibiting action, %	
	Of photosynthesis	Of catalase activity
HCN	78	85
NH ₂ OH	95	100
H ₂ S	94	96
CH ₃ COOH	68	86

Chlorella vulgaris is only half as efficient in photosynthesis as *C. pyrenoidosa*, but ten times more efficient in peroxide decomposition. *Chlorella* cells grown in iron-deficient solutions, and containing reduced quantities of chlorophyll (*cf.* Vol. II, Chapter 32) differed markedly in their photosynthetic efficiency, but had the same capacity for peroxide decomposition.

In contradiction to Yabusoe, the effects of temperature on catalase activity and photosynthesis were also found to be different by Emerson and Green.

Van Hille (1938) observed that the decrease in the rate of photosynthesis of *Chlorella* with age was not accompanied by a similar decrease in the capacity for hydrogen peroxide decomposition. Gaffron (1937) found that the low cyanide sensitivity of the photosynthetic apparatus of certain strains of *Scenedesmus* (*cf.* page 305) was not shared by the mechanism decomposing hydrogen peroxide.

All these experiments speak against the identification of the *rate-limiting* catalytic reaction in photosynthesis with the decomposition of hydrogen peroxide by catalase. However, in recent years it became evident—mainly through the work of Franck, Gaffron and coworkers—that not one but several dark catalytic reactions are involved in photosynthesis, and that the reaction which determines the maximum rate of this process in strong light in most plants, including *Chlorella*, is *not* the one which leads directly to the evolution of oxygen. Thus, arguments against the hydrogen peroxide theory based on the comparison of the maximum rates of photosynthesis and hydrogen peroxide decomposition in *nonpoisoned plants* (Emerson and Green, van Hille) have become invalid. Comparisons of the inhibition of photosynthesis and of catalase activity by *poisons* may still be significant, but only if the poisons in question affect specifically the oxygen-liberating enzyme in photosynthesis. This is not true of *cyanide*, which affects primarily the carbon dioxide fixation (*cf.* page 307). Thus, the similarity of the cyanide

effects in the two processes in table 11.II must be considered fortuitous. More significant are the results obtained with hydroxylamine, since this poison affects the oxygen-liberating reaction (*cf.* page 313). However, since this reaction is not rate limiting in nonpoisoned cells, no *quantitative* parallel between the effects of hydroxylamine on photosynthesis and hydrogen peroxide decomposition can be expected, even if the two effects were due to one and the same reaction. On the other hand, a mere *qualitative* similarity, as revealed by table 11.II, does not prove that the affected enzymes are identical. The hydroxylamine-sensitive enzyme in photosynthesis may be, for example, a "catalase" specifically adapted to the dismutation of an *organic* peroxide, or even an *oxidase* (since many oxidases contain hemin and are therefore capable of complex formation with hydroxylamine).

Thus, of all the arguments given above for or against the intermediary formation of hydrogen peroxide in photosynthesis, there remains only Gaffron's observation of the continued photosynthesis of certain *Scenedesmus* strains in which the catalase was completely inhibited by cyanide. This experiment provides a direct experimental support for the conception—held plausible on general grounds on page 284—that the catalatic decomposition of hydrogen peroxide does *not* form a part of the chemical mechanism of photosynthesis. Gaffron (1944) found indications that hydrogen peroxide also does not occur as an intermediate in the *oxy-hydrogen reaction* in adapted algae.

If catalase does not take part in photosynthesis, what is the purpose of its presence in all green plants? Gaffron suggested that its function may be protection of the photosynthetic apparatus from injury which can be caused by hydrogen peroxide (formed, for instance, by the autoxidation of a yellow respiration enzyme). In confirmation of this view, he reported that cyanide-treated *Scenedesmus* cells, which are ordinarily able to continue photosynthesis indefinitely, ceased to evolve oxygen upon the addition of a trace of hydrogen peroxide. This observation was confirmed by Weller and Franck (1941), who suggested that the part of the photosynthetic apparatus which is destroyed by hydrogen peroxide is the carboxylating enzyme, E_A (*cf.* page 318).

Knoll, Matthews and Crist (1938) had claimed that the evolution of oxygen by *Chlorella* can be enhanced by the addition of catalase; but this result—which, if correct, would strongly support the hydrogen peroxide hypothesis—has never been elaborated upon or confirmed.

3. The Organic Peroxide Hypothesis

Several hypotheses in which *organic peroxides*, rather than hydrogen peroxide, were assumed as intermediates have been discussed in the literature on photosynthesis. The earliest of them—the hypothesis of

Willstätter and Stoll (1918) as well as its elaboration by Franck and Herzfeld (1937), must now be considered as obsolete because it was based on hydroxyl-hydrogen exchange as the elementary photochemical process, a concept which has been proved false by the demonstration that all oxygen evolved in photosynthesis originates in water (*cf.* Chapter 3, page 55).

In consideration of the historical importance of these theories, we shall give a brief account of them. Willstätter and Stoll suggested that photosynthesis consists of two photochemical hydrogen-hydroxyl exchanges in the carbonic acid molecule, alternating with the catalytic dismutations of the two peroxides—performic acid and performaldehyde—formed by these exchanges.

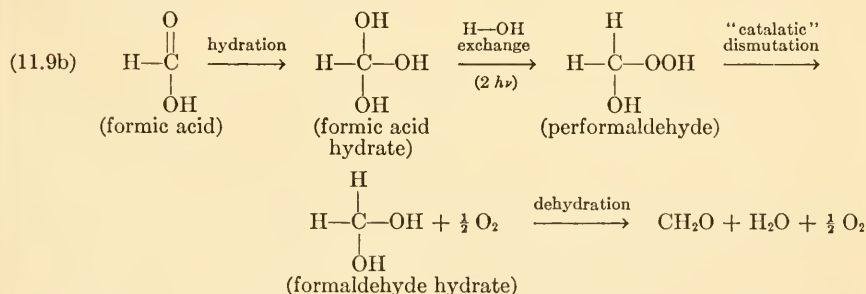
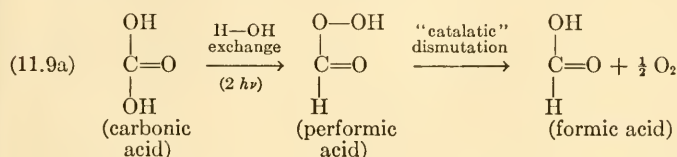

Willstätter and Stoll added to hypothesis (11.9) another and independent hypothesis—that of a reversible *chlorophyll-carbonic acid association* (*cf.* Chapter 16):

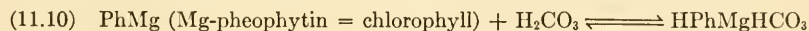

and the H—OH exchange, carried out in (11.9) with *free* H₂CO₃ molecules, was applied to the chlorophyll-carbonic acid compound. The reduction product was supposed to separate itself from chlorophyll after the last photochemical step:

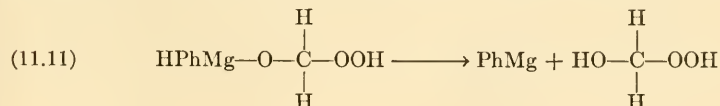

Franck and Herzfeld (1937) have attempted to elaborate scheme (11.9) by dividing each two quanta process into two thermochemically feasible single quantum reactions. Since they thought free radicals would present insurmountable energy barriers, these authors introduced an intermediary hydrogen donor, ROH, which they substituted for water as the first hydrogen donor and hydroxyl acceptor, and suggested that, if the R—OH bond in this catalyst is considerably weaker than the H—OH bond in water,

none of the photochemical steps in reaction sequence (11.12) will require more energy than is available in a quantum of red light.

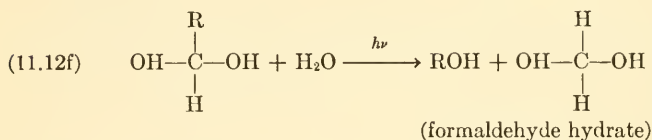
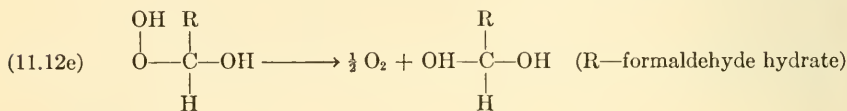
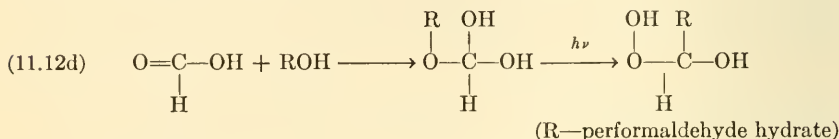
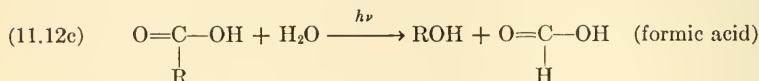
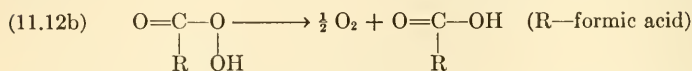
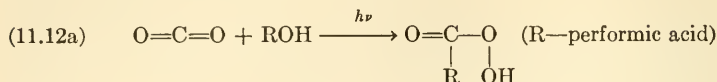

Of the four photochemical reactions in (11.12), two are intramolecular H—OH exchanges, and two intermolecular H—R exchanges. Franck and Herzfeld thought the assumption of a weak R—OH bond is sufficient to equalize the energies of photochemical steps (11.12a), (11.12b), (11.12d), and (11.12f); however, if R is an organic radical, the C—R bond in (11.12a) is a C—C bond, which is 20 kcal weaker than a C—H bond. Thus, while according to table 9.II the substitution of ROH for HOH could bring a *gain* of 32 kcal in the energy required for dissociation into R and OH, it should at the same time bring a *loss* of 20 kcal in the energy gained by the addition of R and OH to C=O. Consequently, step (11.12a) should require about 73 kcal and step (11.12c) only 13 kcal, a far cry from the desired equalization.

These estimates are brought here in order to illustrate the difficulties which “four quanta theories” of photosynthesis must invariably encounter—particularly if an attempt is made to interpret all intermediates as valence-saturated molecules (instead of resonance-stabilized radicals, as suggested in chapter 9, page 230).

Two other schemes of photosynthesis also were based on the formation of peroxides by the reduction substrate. Baur (1937) suggested that the first step in photosynthesis may be the formation of *percarbonic acid*:

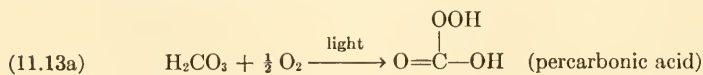

which then decomposes into formic acid, and oxygen:

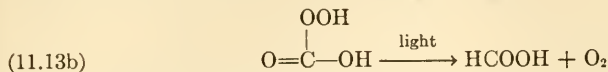

As an experimental basis for this hypothesis, Baur quoted Thunberg's and his own experiments on the formation of formaldehyde by distillation of percarbonates in the presence of lead dioxide (*cf.* page 79).

The second scheme was suggested by Gaffron and Wohl (1936), after Gaffron (1927) found evidence for the formation of amine peroxides in the chlorophyll-sensitized photooxidation of amines (*cf.* page 511). Gaffron and Wohl suggested that amine

peroxides, $\text{RN}-\begin{array}{c} \text{O} \\ \diagup \quad \diagdown \\ \text{O} \end{array}$ or $\text{RN}-\begin{array}{c} \text{OH} \\ | \\ \text{O}-\text{OH} \end{array}$ (with R possibly standing for a protein radical), may occur as precursors of oxygen in photosynthesis, *e. g.*, according to the reaction scheme:

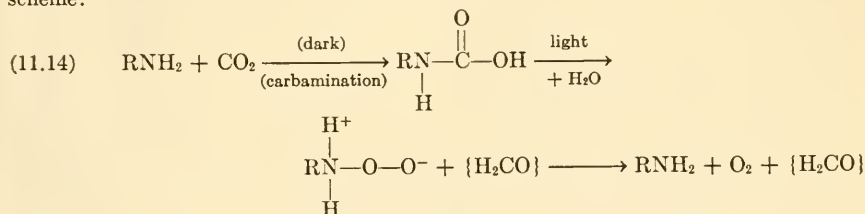

These theories fail to conform with the requirement, derived from experiments with radioactive carbon dioxide, that all oxygen should originate in water. They therefore claim only an historical interest. However, the concept of organic peroxides as intermediates can be utilized in modern oxidation-reduction theories of photosynthesis as well, although the separation between the oxidant (CO_2) and the reductant (H_2O), which characterizes these theories, leads one to the consideration of *catalyst peroxides*, instead of the *peroxides derived from the reduction substrate itself*.

When Franck and Herzfeld (1941) abandoned the hydrogen-hydroxyl exchange mechanisms (11.12) for the hydrogen transfer mechanism (7.12), they retained the assumption that an organic peroxide, ROOH , is formed by the substitution of an organic compound, ROH , for water as hydrogen donor in the primary photochemical reaction (*cf.* Scheme 7.VA). In some other schemes in chapter 7, a water-acceptor complex, designated by $\{\text{H}_2\text{O}\}$, was postulated as the primary reductant, and its oxidation product, $\{\text{OH}\}$, was assumed to form a peroxide $\{\text{OH}\}_2$ before decomposing into free acceptor, water and oxygen. These are two examples of theories which postulate "catalyst peroxides" as intermediate oxidation products.

The difference between the hypothesis of a complex, $\{\text{H}_2\text{O}\}$, and the assumption of Franck and Herzfeld of an intermediary catalyst, ROH , consists in the reversal of the order of two reactions. To show this, let us assume that the "water acceptor" is an organic double bond compound, $\text{R}'=\text{R}''$, so that the reaction, $\text{H}_2\text{O} \rightleftharpoons \{\text{H}_2\text{O}\}$, becomes:

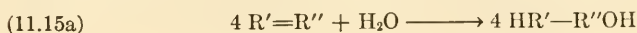

With this compound as hydrogen donor, the primary photochemical process (7.2) becomes:

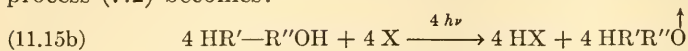

with the arrow indicating a free valency. X is used in equation (11.15b) as the designation for the oxidant (instead of Z, as in Eq. 7.2), because the position of the catalyst Z-HZ in Scheme 7.I is occupied in Franck and Herzfeld's scheme, by the system RO-ROH.

The peroxide formation (7.4a) is now described by equation:

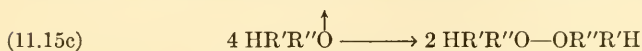

and the peroxide decomposition (7.4b), by equation:

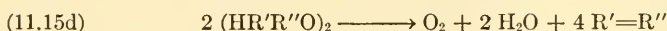

The reaction cycle is completed by regeneration of the water-acceptor complex by reaction (11.15a).

Comparison of equations (11.15a-d) with the Franck-Herzfeld reaction mechanism (7.12) shows that, in the latter, the abbreviation ROH is used for $\text{HR}_1\text{R}_2\text{OH}$, and the order of reactions (11.15d) and (11.15a) is reversed, that is, the organic peroxide is assumed first to react with water to form an organic hydroperoxide:

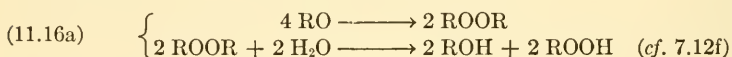

and then to liberate oxygen:

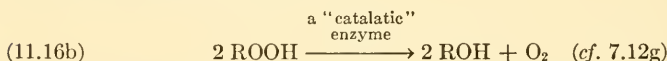

The primary photochemical reaction (11.15b) is, in the formulation of Franck and Herzfeld:

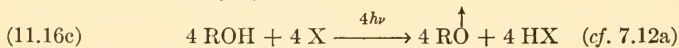

and water is thus removed one step away from the primary photochemical process.

The reaction of an organic peroxide group RO-OR with water, assumed by Franck and Herzfeld, is thermochemically possible (cf. below), but the same is also true of the addition of water to C=C double bonds, as assumed in (11.15a) (cf. Table 9.III). Thus, both the order of reactions suggested in (11.15), and that assumed in (11.16) are not implausible.

To sum up, the formation of organic peroxides as precursors of free oxygen can easily be fitted into the picture of photosynthesis as a hydrogen transfer from water to carbon dioxide. However, if we inquire into the proofs of this hypothesis, all we find are inhibition experiments with hydroxylamine (and certain other poisons) which indicate that one of

the enzymes active in photosynthesis has a certain similarity with ordinary catalase, and the suggestion that this similarity may be explained by assuming that this enzyme is a kind of "catalase," adapted to the dismutation of an *organic* peroxide. However, sensitivity to hydroxylamine may be caused also by noncatalatic enzymes containing a heavy metal, *e. g.* a "deoxidase" which brings about the liberation of oxygen *without the intermediate formation of free peroxide*.

One may ask whether the substitution of organic peroxides for hydrogen peroxide could be advantageous from the point of view of the energy balance of photosynthesis. The answer is that organic peroxides of the type R'O—OR'', as well as hydroperoxides of the type RO—OH, share fully the instability of hydrogen peroxide. D'Ans and Frey (1914) measured the equilibrium of the reactions:

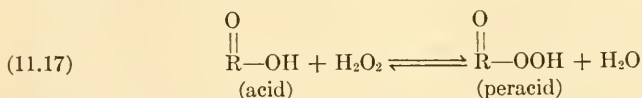

for R = methyl, ethyl, propyl, etc., and obtained, for the equilibrium constant:

$$(11.18) \quad K = \frac{[\text{peracid}]}{[\text{hydroperoxide}][\text{acid}]}$$

values ranging from $K = 2$ (for performic acid) to $K = 5$ (for the higher members of the series). This shows that the formation of peracids from hydrogen peroxide and acid has a free energy of less than 1 kcal. The peracids are thus only insignificantly more stable than hydrogen peroxide. Probably, *all* peroxides of the type RO—OH and R'OOR'' decompose *bimolecularly* (by dismutation), into alcohols, ethers, acids or aldehydes, and oxygen, with the liberation of an amount of energy similar to that liberated in the decomposition of hydrogen peroxide into water and oxygen.

An important difference between organic peroxides and hydrogen peroxide appears when one considers the possibility of a *monomolecular decomposition* (into RH and O₂, or R'R'' and O₂). The monomolecular decomposition of hydrogen peroxide:

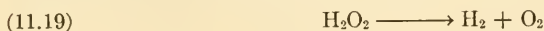

consumes 35 kcal. A similar decomposition of an organic hydroperoxide:



requires, with the standard bond energies, only 7 kcal, while the decomposition of a purely organic peroxide:



should liberate 6 kcal; reactions of these two types could thus be reversible.

Reversible peroxide formation appears possible also in the case of "double bond peroxides." According to the standard bond values, the reaction:

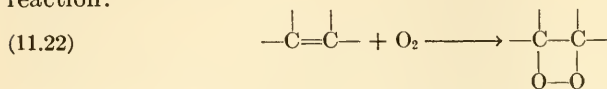

should liberate 9 kcal; but the resonance stabilization of the $\begin{array}{c} | \quad | \\ -\text{C}=\text{C}- \\ | \quad | \end{array}$ double bond may make the energy of oxygenation smaller or may even change its sign. The same may be true for the peroxides of quinones, and other conjugated double bond systems, as, for example:

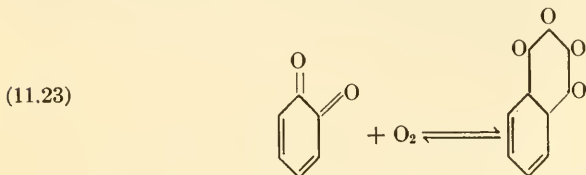

Our knowledge regarding the actual existence of peroxides of the type of (11.22) or (11.23) is very limited. So-called "mloxides," whose intermediate formation has often been assumed in the oxidation of ethylenic double bond compounds, probably belong to the type (11.22). However, they exhibit the tendency to split into aldehydes or ketones:

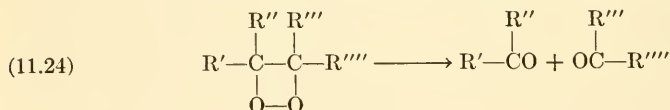

or to polymerize (*cf.* Rieche 1931, 1936). The catalytic effect of oxygen on the polymerization of double bond compounds, *e. g.*, of drying oils, is probably due to the primary formation of peroxides of this type (*cf.* Milas 1932).

One of the few experimentally known *reversible* organic peroxides is the colorless peroxide of the red hydrocarbon *rubrene* (or "rubene") discovered by Moureu, Dufraisse, and Dean (1926).

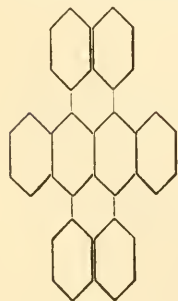

Rubrene

Moureu, Dufraisse, and Girard (1928) found that rubrene peroxide has, at 16° C., a dissociation pressure of about 0.5 mm. This corresponds to $\Delta F = 6.3$ kcal; direct calorimetric measurements by Dufraisse and Enderlin (1930) gave for the heat of dissociation a value of $\Delta H = 23$ kcal (which seems to be much too high for a reversible reaction).

As described in chapter 20, *carotene* and its derivatives, which contain long chains of conjugated double bonds, absorb considerable amounts of oxygen; it is probable that, in this case too, double bond peroxides are

the primary products. According to Baur (1936, 1937), carotene peroxide is formed only in light, and its formation is at least partially reversible.

Peroxides of quinonoid dyes have often been mentioned in the literature, but have not been well investigated. It has been suggested, for example, that the autoxidation of *organic dyes* proceeds through primary peroxide formation (*cf.* page 499). Gaffron (1927) observed the formation of reversible peroxides of *organic amines* in experiments on chlorophyll-sensitized photoxidation (*cf.* Table 18.I).

In the case of *chlorophyll*, evidence of oxygen absorption as the cause of so-called "allomerization" (*cf.* page 459) was presented by Conant, Hyde, Moyer, and Dietz (1931). This absorption was attributed to the formation of a chlorophyll peroxide by Conant and H. Fischer. Fischer represented it as an alkyl hydroperoxide R—O—OH, with the peroxidic group in position 10 (*cf.* Formula 16.III). Certain difficulties of this hypothesis (in particular the fact that oxygen absorption can be observed only in alcohol) are discussed in chapter 16. No definite proofs have as yet been found that the oxygen uptake in the allomerization process is reversible.

The formation of a reversible (or almost reversible) peroxide, capable of monomolecular decomposition, could be of great advantage for photosynthesis if it would permit the saving of energy otherwise lost in bimolecular dismutation. However, the question arises as to the way in which such peroxides could be fitted into the reaction cycle of photosynthesis. The primary photochemical oxidation products, Z or {OH}, probably are *free radicals* in which *one* hydrogen atom is "missing"; *four* such radicals must cooperate in the direct liberation of *one* molecule of oxygen (while the recombination of *two* radicals is sufficient to produce one-half an oxygen molecule by dismutation). The mechanism by which four radicals could transfer two oxygen atoms to a catalyst to form a "reversible" peroxide, for example:

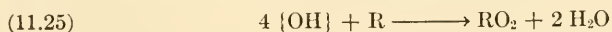

is difficult to visualize, especially if the peroxide-forming catalyst is an organic molecule with a double bond, or a quinonoid ring system. It is somewhat easier to devise a similar mechanism if the peroxide-forming catalyst is a *hemin complex* capable of reacting with four radicals in as many "univalent" steps. The next section will be devoted to this possibility.

4. The Oxidase Hypothesis

It was stated before that, in the main course of respiration, the formation of *free* peroxides is avoided by the action of "oxidases," and that a reversal of the oxidase action may be the mechanism of oxygen

liberation in photosynthesis. To oxidize water to hydrogen peroxide, the primary oxidation product must have an oxidation potential < -1.35 volts, but if water (bound to a suitable catalyst) could be oxidized in four approximately equal steps, the required potential would be ≤ -0.81 volt, a value approximated, for example, by organic radicals of the type of porphyrin (cf. page 232).

The mechanism of oxidase action is unknown, but apparently most, if not all, oxidases (*e. g.*, the cytochrome oxidase) are hemin derivatives. Since ferri-ferro systems are "univalent," it is probable that, in the oxidase action, four hydrogen atoms (or electrons) are transferred one at a time, and that the structure of the oxidases is such as to equalize approximately the energies of these four steps. Ferro and ferri ions have four or five unsaturated homopolar valences; even if two of them are saturated in hemin by complex formation, two or three remain free, and this may permit a chemical association with oxygen (as in oxyhemoglobin), and may also help in the addition and internal transfer of electrons. For instance, we may consider the following sequence of transformations:

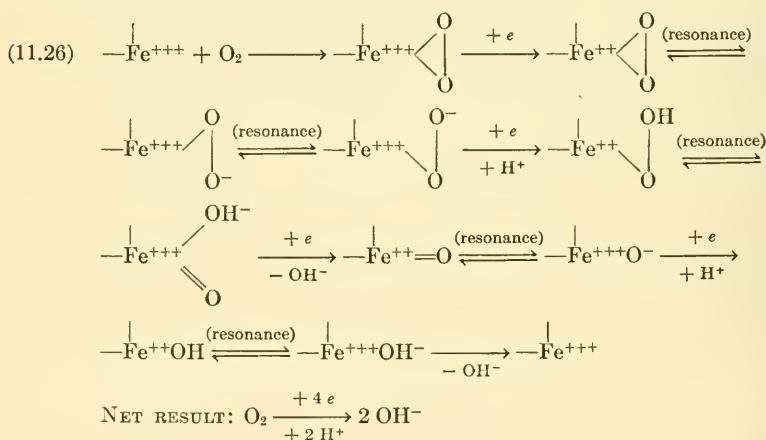

The essential point in this (otherwise arbitrary) scheme is that the intermediates of peroxidic character are supposed to be stabilized by resonance between the forms containing ferrous and ferric iron, respectively; this may equalize the potentials of the four reduction steps.

In photosynthesis, the evolution of oxygen may occur by a mechanism of type (11.26) running in reverse, with four primary oxidation products, Z, serving as acceptors for the four electrons taken away from water in its oxidation to oxygen. (For the first suggestion that water is oxidized in photosynthesis by ferric iron, cf. Weiss 1937.) The primary oxidation product, Z, may itself be a hemin derivative; it seems more probable,

however, that it is a radical derived from chlorophyll, and that a hemin complex is the next hydrogen (or electron) donor in the series, which restores oxidized chlorophyll (Z) to its original state (HZ). Possibly not one, but several, reversibly oxidizable hemin derivatives are interpolated between the primary oxidation product Z and the terminal "deoxidase," occupying positions similar to those of the cytochromes in respiration.

Thus, the intermediate, $\{O_2\}$, postulated in chapter 6 (Scheme 6.I), may be not a "free" peroxide, but a complex of the type of ferricytochrome or one of the series of intermediates in (11.26) which, even if they contain O—O bonds, do not have the characteristic instability of hydrogen peroxide and the common organic peroxides.

As described in chapter 16, chlorophyll *in vitro* reacts with excess ferric chloride and is restored by excess ferrous chloride. This seems to indicate a reversible oxidation, and a normal potential close to that of the ferro-ferri system. The latter is, in neutral solution, only 0.03 volt more positive than the potential of an oxygen electrode. It is thus conceivable that, *in vivo*, a photochemically produced "oxychlorophyll" radical may oxidize a complex iron compound, which in turn is capable of oxidizing water through the intermediary of a deoxidase.

5. Experiments with Heavy Water

One could expect to obtain some information as to the catalytic mechanism of water oxidation in photosynthesis from experiments with water containing the rare isotopes of hydrogen or oxygen. Experiments with *radioactive oxygen* have already been discussed (in Chapter 3) because they provided the main experimental basis for the interpretation of photosynthesis as hydrogen transfer from water to carbon dioxide. The results of experiments with *heavy hydrogen* have been mentioned in passing, in chapter 7 (page 157). We shall now describe them in more detail.

Reitz and Bonhoeffer (1935¹) found that deuterium is assimilated by algae (*Chlamydomonas* and *Scenedesmus*), grown in mixtures of ordinary and heavy water, at a rate 2.3 times smaller than that of the assimilation of ordinary hydrogen. Later (1935²), they observed that *Scenedesmus* cannot grow in 38.4% heavy water. On the other hand, Meyer (1936) found that *Chlorella* grows well even in 99% heavy water; this was confirmed later by Trelease and coworkers. In good agreement with Reitz and Bonhoeffer, Curry and Trelease (1935) found that the rate of photosynthesis of *Chlorella* in pure deuterium oxide is 2.5 times smaller than in ordinary water. (Shibata and Watanabe, 1936, found, with *Chlorella ellipsoidea*, only a difference of 20%.) The change in the rate was complete after a 30-minute immersion into heavy water, and re-

mained reversible, even after 15 hours. Craig and Trelease (1937) made measurements in various water mixtures, and over a wide range of temperatures, light intensities and carbon dioxide concentrations. The yield was found to decline smoothly with increasing concentration of deuterium oxide: analysis of this function showed that the three kinds of water (H_2O , HDO , D_2O) participate in photosynthesis independently of each other. The effect of deuterium oxide is strongest at the *high light intensities*, and disappears in weak light (Fig. 25). The *temperature coefficient* is unaffected by heavy water below 30°C ., but is changed in the region between 30° and 46° ; the maximum rate is reached at 35° in ordinary water and at 39° in heavy water.

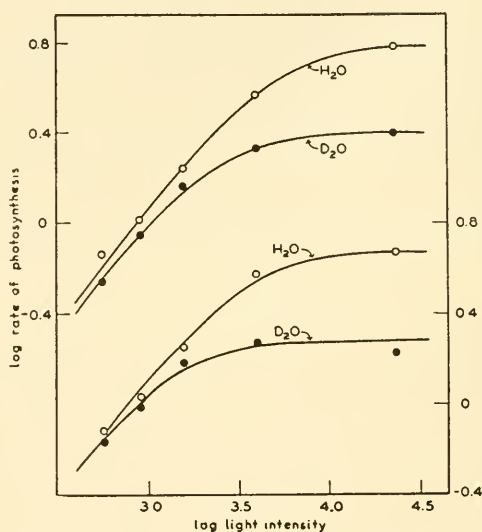

FIG. 25.—The rate of photosynthesis of *Chlorella* as a function of light intensity in ordinary water and heavy water (after Craig and Trelease 1937).

Pratt, Craig, and Trelease (1937), and Pratt and Trelease (1938) used flashing light to distinguish between the effects of deuterium on the photochemical reaction and on the dark reactions in photosynthesis (*cf.* Vol. II, Chapter 34). Flashes of 0.005-second duration were interrupted by dark intervals of 0.012–0.086 seconds. With the shorter dark periods, the yield per flash in heavy water was 40% of that in ordinary water (*i. e.*, the ratio was the same as in continuous light); but with dark periods of 0.028 second, the ratio rose to 0.57; and with 0.062 and 0.086 seconds, it became practically equal to 1 (Fig. 26).

The influence of light intensity, and the results obtained in flashing light, point to the influence of heavy water on the rate of a *dark catalytic reaction*, which limits the rate in strong light, and can be brought to completion during dark intervals between the flashes. (The unchanged temperature coefficient of photosynthesis in heavy water may mean that the substitution of D for H affects the "collision factor" in the rate equation, rather than the activation energy.)

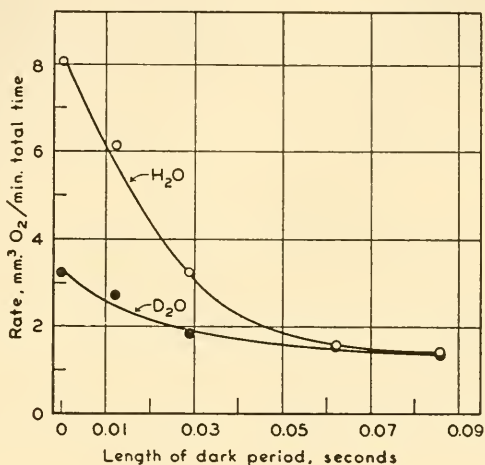

Fig. 26.—Yield of photosynthesis of *Chlorella* in flashing light per unit total time as a function of the length of the dark intervals, in ordinary water and heavy water (after Pratt and Trelease 1938).

What catalytic reaction is reduced in rate by the substitution of deuterium oxide remains to be elucidated. Of the three groups of catalytic reactions defined on page 172, one—the formation of a complex from an acceptor and free carbon dioxide—is not likely to be affected by this change; while the other two—the conversion of the primary oxidation product into free oxygen, and the transformation of the primary reduction product into carbohydrate—should be so affected because they are dismutations or oxidation-reductions, and as such probably involve transfers of hydrogen atoms. In the theory of Franck and Herzfeld, it is assumed that, normally, a reaction of the third group limits the rate of photosynthesis in strong light (*cf.* Vol. II, Chapter 28). It is thus natural to assume that the participation of deuterium in this reaction is responsible for the effect of heavy water on the maximum rate of photosynthesis in strong light (unless we assume that some other reaction, which is not limiting in ordinary water, is slowed down by heavy water so strongly as to become the limiting one).

It was pointed out in chapter 7 that the equality of rates in heavy and ordinary water *in weak light* does not constitute an argument against the participation of water in the primary photochemical process. There is no reason why the slight difference between the energy contents of the molecules, H_2O and D_2O , should affect the probability of their photochemical transformation, and thus the rate of photosynthesis in the "light-limited" state.

To sum up: experiments with heavy water have not yet given new clues to the mechanism of water oxidation in photosynthesis, but this does not mean that their further development could not reveal important new facts about this mechanism.

Some experiments on photosynthesis in *tritium oxide* will be described in chapter 19 (page 557).

Bibliography to Chapter 11

The Mechanism of Oxygen Liberation

- 1914 d'Ans, J., and Frey, W., *Z. anorg. Chem.*, **84**, 145.
- 1918 Willstätter, R., and Stoll, A., *Untersuchungen über die Assimilation der Kohlensäure*. Springer, Berlin, 1918.
- 1924 Warburg, O., and Uyesugi, T., *Biochem. Z.*, **146**, 486.
Yabusoe, M., *ibid.*, **152**, 498.
- 1926 Moureu, Ch., Dufraisse, Ch., and Dean, P. M., *Compt. rend.*, **182**, 1584.
- 1927 Gaffron, H., *Ber. deut. chem. Ges.*, **60**, 2229.
- 1928 Moureu, Ch., Dufraisse, Ch., and Girard, L., *Compt. rend.*, **186**, 1166.
- 1930 Dufraisse, Ch., and Enderlin, L., *ibid.*, **191**, 1321.
- 1931 Conant, J. B., Hyde, J. F., Moyer, W. W., and Dietz, E. M., *J. Am. Chem. Soc.*, **53**, 359.
Rieche, A., *Alkylperoxide und Ozonide*. Steinkopff, Dresden and Leipzig, 1931.
- 1932 Milas, N., *Chem. Revs.*, **10**, 295.
- 1933 Yakushiji, E., *Acta Phytochim. Japan*, **7**, 93.
Shibata, K., and Yakushiji, E., *Naturwissenschaften*, **21**, 267.
- 1935 Kohn, H. I., *J. Gen. Physiol.*, **19**, 22.
Reitz, O., and Bonhoeffer, K. F., *Z. physik. Chem.*, **A172**, 369.
Reitz, O., and Bonhoeffer, K. F., *ibid.*, **A174**, 424.
Curry, J., and Trelease, S. F., *Science*, **82**, 18.
- 1936 Rieche, A., *Die Bedeutung der organischen Peroxide für die chemische Wissenschaft und Technik*. Enke, Stuttgart, 1936.
Gaffron, H., and Wohl, K., *Naturwissenschaften*, **24**, 81.
Meyer, H., *ibid.*, **24**, 346.
Shibata, K., and Watanabe, A., *Acta Phytochim. Japan*, **9**, 107.
Baur, E., *Helv. Chim. Acta*, **19**, 1210.
- 1937 Emerson, R., and Green, L., *Plant Physiol.*, **12**, 537.
Franck, J., and Herzfeld, K. F., *J. Chem. Phys.*, **5**, 237.

- 1937 Gaffron, H., *Biochem. Z.*, **292**, 241.
Craig, F. N., and Trelease, S. F., *Am. J. Botany*, **24**, 332.
Baur, E., *Helv. Chim. Acta*, **20**, 387, 398.
Baur, E., *ibid.*, **20**, 402.
Weiss, J., *J. Gen. Physiol.*, **20**, 501.
Pratt, R., Craig, F. N., and Trelease, S. F., *Science*, **85**, 271.
- 1938 van Hille, J. C., *Rec. trav. botan. néerland.*, **35**, 680.
Knoll, A. F., Matthews, F. L., and Crist, R. H., *J. Chem. Phys.*, **6**, 109.
Pratt, R., and Trelease, S. F., *Am. J. Botany*, **25**, 133.
Nakamura, H., *Acta Phytochim. Japan*, **10**, 259.
- 1941 Weller, S., and Franck, J., *J. Phys. Chem.*, **45**, 1359.
Franck, J., and Herzfeld, K. F., *ibid.*, **45**, 978.
- 1944 Gaffron, H., *Biol. Rev. Cambridge Phil. Soc.*, **19**, 1.

CHAPTER 12

INHIBITION AND STIMULATION OF PHOTOSYNTHESIS

I. CATALYST POISONS AND NARCOTICS

Photosynthesis is strongly affected by many so-called inhibitors or stimulants, substances which change the rate without participating directly in the reaction. Recently it has become increasingly clear, mainly through the work of Gaffron, that certain poisons inhibit specific steps in the photosynthetic process, and that a skillful use of such selective inhibitors may help to differentiate between the component reactions of photosynthesis, to retard at will some of them, and to direct the process into alternative channels. Thus, the use of specific poisons promises to become an important tool in the disentanglement of the complex chemistry of photosynthesis.

The addition of almost any new substance to the medium in which a plant lives (or the removal of a substance usually present in it) is likely to affect its photosynthetic efficiency. The list of effective agents ranges from poisons, through narcotics, to aldehydes, sugars, organic and inorganic acids and salts, oxygen, and water. The action of some substances is highly specific; they obviously possess affinities with certain components of the photosynthetic apparatus. Other substances act in a less specific way, as, for example: all urethans, by their surface activity; all acids, by their common constituent, the hydrogen ion; and all solutes in general, by their effect on osmotic pressure. The present chapter is concerned, in the first part, with specific "catalyst poisons" (hydrocyanic acid, hydroxylamine, hydrogen sulfide, etc.) and, in the second part, with "narcotics," of the type of chloroform, ether, and urethan. Chapter 13 will deal with the effects of oxygen, carbohydrates, salts and other miscellaneous physical and chemical inhibitors and stimulants.

Many typical *catalyst poisons* (e. g., cyanide) owe their toxicity to the formation of a complex with metal atoms, contained in the prosthetic groups of many enzymes. Others (e. g., dinitrophenol or acetyl iodide) probably react with specific groups in catalytically active proteins. *Narcotics*, on the other hand, are supposed to act by blocking active surfaces rather than by attaching themselves to individual atoms or groups.

A. CATALYST POISONS*

1. Cyanide Inhibition of Photosynthesis

Experiments on cyanide poisoning have usually been carried out with algal suspensions in aqueous solutions (although it is also possible to poison land plants by gaseous hydrocyanic acid). The poisonous molecular species is the nondissociated acid, HCN, and many measurements—as those of Warburg and Emerson—have been referred to its concentration rather than to the total concentration of the cyanide. At a given pH , the concentrations of HCN molecules in a solution whose total cyanide concentration is $[Cy]$ can be calculated from the equation:

$$(12.1) \quad [HCN] = \frac{[H^+][Cy]}{K + [H^+]}$$

where K (the dissociation constant of hydrocyanic acid) is approximately 5×10^{-10} (at $20^\circ C.$). Consequently, $[HCN]$ is almost equal to $[Cy]$ for $pH < 8.5$; the difference becomes marked only in more alkaline solutions, as in carbonate-bicarbonate buffers (*cf.* page 178). The assumption that only the neutral molecules, HCN, are poisonous, reminds one of the postulate that only the neutral molecules, CO_2 , take an active part in photosynthesis (*cf.* page 195), and can be explained in a similar way, that is, by selective cell penetration by neutral molecules.

The sensitivity of photosynthesis to cyanide was discovered by Warburg in 1919. (The poisonous effect of cyanide on the respiration of plants was known before.) Warburg found that 3.8×10^{-5} mole per liter HCN decreases the rate of photosynthesis in *Chlorella* (in strong light and in the presence of abundant carbon dioxide) by almost 50%. Equally strong is the cyanide effect on the *respiration of nonchlorophyllous* plants (*e. g.*, yeast); but the respiration of *Chlorella*, instead of being poisoned by 3.8×10^{-5} m./l. HCN, was *stimulated* by about 57%. The lowest cyanide concentration which produced inhibition (by -18%) was 10^{-2} m./l. Even in 0.1 molar hydrocyanic acid, the respiration of *Chlorella* still proceeded at 40% of its normal rate. Thus, the presence of

TABLE 12.I

INHIBITION OF PHOTOSYNTHESIS IN CHLORELLA BY HCN (AFTER WARBURG 1920)
 $[CO_2] = 9.1 \times 10^{-5}$ m./l., $25^\circ C.$; P = rate of photosynthesis in relative units

Light intensity, lux	P , with- out HCN	P , with 10^{-4} m./l. HCN	Inhibition, %
1,800	61	61	0
19,000	540	192	65

* Bibliography, page 324.

from 10^{-4} to 10^{-2} m./l. of cyanide will completely paralyze the photosynthesis of *Chlorella*, but will leave respiration unaffected or even stimulated.

Warburg (1919, 1920) found, and other observers confirmed, that photosynthesis in *weak* light is indifferent to cyanide (*cf.* Table 12.I and Fig. 27), showing that cyanide does not interfere with the photochemical process proper but affects an enzymatic "bottleneck" reaction which limits the rate of the over-all process in poisoned cells in strong light.

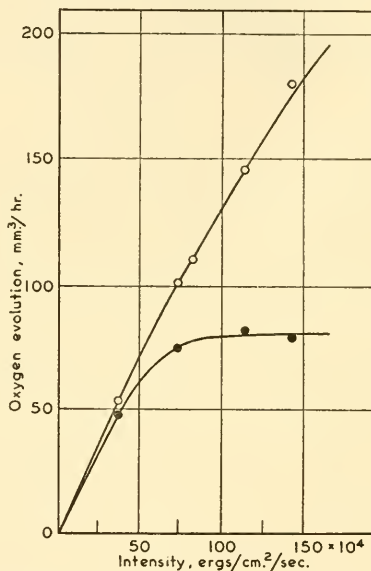

FIG. 27.—Effect of cyanide on photosynthesis of *Chlorella* at different light intensities (after Wassink, Vermeulen, Reman, and Katz 1938). ○: not inhibited; ●: inhibited by 0.05 ml. of 0.03% KCN per ml., corresponding to about 1×10^{-3} m./l.

Warburg (1920) made another interesting observation—that cyanide reduces photosynthesis only to the compensation point (where the *net* gas exchange is zero) but leaves unaffected the fraction of photosynthesis which merely compensates for respiration (*cf.* Table 12.II).

The last column in table 12.II shows a "residual photosynthesis" which is unaffected by 0.8×10^{-3} m./l. of cyanide. These experiments were carried out in very dilute carbon dioxide, so that the rate of photosynthesis in the noninhibited state was very small, and the existence of a cyanide-indifferent residual photosynthesis could be demonstrated most strikingly. However, Warburg gave table 12.III as a proof that cyanide-resistant residual photosynthesis exists also under the conditions of abundant carbon dioxide supply. The proof lies in the fact that none

TABLE 12.II

INHIBITION OF PHOTOSYNTHESIS (*P*) IN CHLORELLA BY CYANIDE IN THE REGION OF THE COMPENSATION POINT (AFTER WARBURG)

Low [CO₂] (4×10^{-7} m./l.), strong light, 10° C.; *R* = respiration

Expt. No.	[HCN]	Oxygen pressure, change per hour, mm.		
		Dark (<i>R</i>)	Light (<i>P</i> - <i>R</i>)	<i>P</i>
I	0	-11	+13	24
	0.8×10^{-4}	-13	+3	16
	0.8×10^{-3}	-17	-2	15
II	0	-16	+8	24
	0.4×10^{-4}	-16	+3	19
	0.8×10^{-4}	-18	+7	19
	0.8×10^{-3}	-25	-5	20

of the figures in table 12.III is negative—not even the value obtained in 0.005 molar cyanide solution.

TABLE 12.III

EFFECT OF HCN ON OXYGEN LIBERATION BY CHLORELLA (AFTER WARBURG)

[CO₂] = 9.1×10^{-5} m./l., 25° C., 19,000 lux; *R* = -30 to -40 mm./h.

[HCN], m./l.	0	10^{-3}	2×10^{-3}	5×10^{-3}	
	Oxygen pressure, change per hour, mm.				
<i>P</i> - <i>R</i> {	Expt. I	444	16	—	—
	Expt. II	480	—	4	—
	Expt. III	294	—	—	0

Before discussing the interpretation of this interesting result, we shall first describe the influence of cyanide on other algae. The results show wide variations, both in the absolute sensitivity of the photosynthesizing apparatus, and in the relative sensitivity of photosynthesis and respiration. Van der Paauw (1930) found, for example, that the photosynthesis of *Hormidium flaccidum* was stimulated by cyanide in concentrations up to 2×10^{-4} m./l., and inhibited only above this concentration. The effect of cyanide on photosynthesis was roughly equal to its effect on respiration: no cyanide-resistant residual photosynthesis could be observed. The inhibition was equally strong in intense and in weak light. All these results differed from Warburg's observations on *Chlorella*. Van der Paauw suggested that, in *Hormidium*, cyanide affects the

“general vitality” of the protoplasm—hence its uniform influence on respiration and photosynthesis, whereas, in *Chlorella*, it acts directly and independently on each of these two processes. That the behavior of two closely related species should be so different seems implausible; we shall see below that a simpler explanation can be suggested.

In a subsequent investigation (1935), van der Paauw used *Stichococcus bacillaris*, an alga which is resistant to alkaline buffer solutions and could therefore be studied in Warburg’s manometric apparatus, instead of in van der Honert’s gas flow apparatus (*cf.* Vol. II, Chapter 25) which had to be used for work on *Hormidium*. The results were described by van der Paauw as “intermediate between those obtained with *Chlorella* and *Hormidium*.” On the one hand, *Stichococcus*, similarly to *Hormidium*, showed a *stimulation* of photosynthesis by small quantities of cyanide (up to 10^{-5} m./l.), and inhibition only above 10^{-4} m./l. HCN. On the other hand, the photosynthesis of *Stichococcus*, similarly to that of *Chlorella*, could not be reduced by cyanide below the compensation point. The ratio of the “residual photosynthesis” of poisoned algae to that of the nonpoisoned ones is expressed by P/P_0 in table 12.IV. *Respiration*

TABLE 12.IV

EFFECT OF HCN ON PHOTOSYNTHESIS OF STICHOCOCCUS (AFTER VAN DER PAAUW)

[HCN] m./l.	0.004	0.005	0.01	0.02
$P - R$	7.0	0.4	0	0
P/P_0	7%	5%	5%	5%

in *Stichococcus* is doubled by cyanide stimulation, without a sign of incipient inhibition even at 0.02 m./l. HCN; the resistance of its respiratory system to cyanide is thus even stronger than that of *Chlorella*.

Emerson (1929) has investigated the effect of cyanide on *Chlorella pyrenoidosa* with an artificially reduced chlorophyll content. A concentration of 9×10^{-6} m./l. HCN reduced the rate of photosynthesis by 40% in cells with a chlorophyll content of 0.037 relative units, by 30% in cells with $[\text{Chl}] = 0.060$, and by 25% in cells with $[\text{Chl}] = 0.083$. Thus, *Chlorella* cells poor in chlorophyll were more sensitive to cyanide than those with a normal chlorophyll content. This was interpreted by Emerson as an indication that a reduction in chlorophyll concentration reduces the capacity of *Chlorella* for an enzymatic reaction. Together with other observations (*e. g.*, those on the temperature coefficient of photosynthesis in chlorophyll-deficient cells; *cf.* Vol. II, Chapter 31) these results have been taken by Emerson as indicating the participation of chlorophyll in a nonphotochemical, catalytic reaction in photosynthesis.

However, iron-deficient nutrient solutions, which Emerson used to grow cells with a subnormal content in chlorophyll, may well have caused also a deficiency in other, cyanide-sensitive catalysts.

Table 12.V contains some typical results taken from the above-mentioned investigations of Warburg, van der Paauw, and Emerson,

TABLE 12.V
CYANIDE POISONING OF PHOTOSYNTHESIS AND RESPIRATION
IN DIFFERENT SPECIES OF ALGAE
Strong light, abundant CO₂ supply

Plant species	[HCN] or [Cy] × 10 ⁴	Inhibition (-) or stimulation (+) %	
		R	P
GREEN ALGAE			
<i>Chlorella vulgaris</i> , Warburg (1919)	0.38	+ 57	- 46
<i>Chlorella pyrenoidosa</i> (high [Chl]), Emerson (1929)	0.09		- 40
<i>Chlorella pyrenoidosa</i> (low [Chl]), Emerson (1929)	0.09		- 25
<i>Chlorella</i> , Gaffron (1937)	2		- 50
<i>Hormidium flaccidum</i> , van der Paauw (1939)	1	+ 33	± 10
<i>Stichococcus bacillaris</i> , van der Paauw (1935)	1	+100	- 40
<i>Scenedesmus</i> species, Gaffron (1937)	1	- 85	- 10
<i>Scenedesmus obliquus</i> Strain D, Gaffron (1939)	1.25	+ 75	- 50
<i>Scenedesmus</i> species, Gaffron (1939)	2	- 75	- 8
<i>Scenedesmus nanus</i> , Nakamura (1938)	1		- 78
RED ALGAE			
<i>Gigartina harveyana</i> , Emerson and Green (1934)	1		- 60
BROWN ALGAE AND DIATOMS			
<i>Nitzschia closterium</i> , Gaffron (1937)	1	- 90	-100
<i>Nereocystis</i> , Lund and Holt (1923)	0.8		-100

together with those of Lund and Holt (1923), Emerson and Green (1934), Gaffron (1937, 1939), and Nakamura (1938). As nearly as possible, values have been chosen which show the effect of approximately 10⁻⁴ mole per liter of cyanide. If we designate strong sensitivity to cyanide by + and weak by 0, table 12.V is found to contain all possible combinations:

R	P	EXAMPLE:
+	+	<i>Nitzschia</i>
+	0	<i>Scenedesmus</i> D1 (Gaffron)
0	+	<i>Chlorella</i> , <i>Stichococcus</i>
0	0	<i>Hormidium</i>

The main result of Gaffron's work on *Scenedesmus* was to provide the first example of a plant whose respiration can be suppressed by cyanide

without injury to photosynthesis—a reversal of conditions prevailing in *Chlorella* and *Stichococcus*. The addition of 2×10^{-4} m./l. potassium cyanide will leave photosynthesis in Gaffron's *Scenedesmus* D1 unaffected, but will suppress respiration almost completely. The "compensation point" of *Scenedesmus* D1 is shifted by cyanide towards lower light intensities, so that, in weak light, consumption of oxygen may be replaced, upon the addition of cyanide, by an evolution of this gas. The effect of higher concentrations of cyanide on the photosynthesis of *Scenedesmus* D1 is shown by table 12.VI. Low concentrations of HCN (*e. g.*, 5×10^{-5}

TABLE 12.VI
INHIBITION OF PHOTOSYNTHESIS BY HCN IN SCENEDESMUS SPECIES D1
(AFTER GAFFRON)

[HCN], m./l.	2×10^{-5}	1×10^{-4}	5×10^{-4}	1×10^{-3}	3.3×10^{-3}	1×10^{-2}
Inhibition at:						
5000 lux	0	0	-38%	-50%	-83%	-94%
400 lux	0	0	0	—	—	—

m./l.), which have no effect on photosynthesis in *Scenedesmus* D1 at 5000 or even 10,000 lux, will cause an inhibition if the light intensity is increased still further, approaching the "saturating" value (which lies at about 30,000 lux).

Nakamura (1938), who believed that catalase plays an important part in photosynthesis (*cf.* page 284), refused to admit the existence of plants whose photosynthesis is resistant to cyanide (since catalase is invariably inhibited by this poison). He suggested that the results of Gaffron on *Scenedesmus* D1 (and implicitly—also those of van der Paauw on *Hormidium*) should be attributed to experimental errors (for example, a rapid decomposition of the cyanide). In support of this criticism, he quoted his own results with *Scenedesmus nanus*. However, table 12.V reveals such wide variations in the cyanide sensitivity of different algae, that conclusions by analogy, not only from species to species, but even from strain to strain, are unconvincing, and we see no reason to doubt Gaffron's results more than any others. As a matter of fact, we have even used these results in chapter 11 (page 286) as a decisive argument against the hypothesis that hydrogen peroxide is an intermediate in photosynthesis.

Differences in absolute and relative sensitivity to cyanide of photosynthesis and respiration in different plants can be caused either by *qualitative* factors—as variations in the chemical structure of the relevant enzymes—or by differences in the available *quantities* of otherwise identical enzymes. Although the second explanation seems to be more plau-

sible, it faces certain difficulties. If the cyanide-affected enzyme were the one which limits the rate of photosynthesis under ordinary conditions, (*i. e.* in strong light and in the presence of abundant carbon dioxide but in the absence of inhibitors), differences in the available quantity of this enzyme could not explain why a hundred or a thousand times more cyanide is required to produce a certain proportional inhibition in *Hormidium* than is necessary to bring about the same results in *Scenedesmus*. Since the cyanide is always added in a *large excess* compared with the enzyme, a certain added concentration, $[\text{HCN}]_0$, should always deactivate the same fraction of the enzyme, regardless of the absolute concentration of the latter:

$$(12.2) \quad \frac{E_{\text{inhibited}}}{E_{\text{free}}} = K [\text{HCN}] \simeq K [\text{HCN}]_0$$

where K is the dissociation constant of the enzyme-inhibitor complex.

If we want to explain the different response of different species to cyanide by differences in enzyme concentration, *we must assume that the cyanide-sensitive enzyme is not responsible for rate limitation under ordinary conditions, but becomes limiting when its active concentration is reduced by poisoning.* If we assume, for example, that both *Hormidium* and *Scenedesmus* contain the cyanide-sensitive enzyme in excess of the maximum requirement of photosynthesis, but that this excess is larger in the second organism, then we can understand why a larger fraction of this enzyme can be inactivated by cyanide in the second species before the rate of photosynthesis becomes affected by its deficiency.

This point of view has been stressed by Franck (*cf.*, for example, Franck, French, and Puck 1941). Its importance for the understanding of the effects of inhibitors in all complex biochemical processes, is obvious. In the case of photosynthesis, this explanation is supported by independent considerations of Weller and Franck (1941), based on experiments in flashing light. These observations confirmed that the catalytic reaction which limits the rate of photosynthesis in strong light in absence of inhibitors is *not* sensitive to cyanide, and that the source of cyanide sensitivity of the photosynthetic process as a whole is the inhibition of an ordinarily nonlimiting catalytic process, more specifically, of the formation of the acceptor-carbon dioxide complex, $\{\text{CO}_2\}$.

The complete argument will be presented in volume II, chapter 34, dealing with phenomena in flashing light. The basic fact (discovered by Emerson and Arnold in 1932) is that cyanide does not affect the oxygen yield *per light flash*, provided the dark intervals between the flashes are sufficiently long. Two interpretations of this fact will be discussed in chapter 34; and it will be shown that the shape of the curves representing the yield per flash as a function of the length of the dark interval

with and without cyanide clearly favors the interpretation of Weller and Franck (further confirmed by experiments of Rieke and Gaffron 1943) according to which a full yield can be obtained whenever the dark intervals are long enough to allow the photosynthetic mechanism to be "recharged" with a new quantity of carbon dioxide. This recharging involves a reaction which was not rate limiting in the absence of the poison, but became limiting when inhibited by cyanide. The suggestion that this reaction is the primary fixation of carbon dioxide is supported by the experiments of Ruben, Kamen, and Hassid (1940) on the effect of cyanide on the reversible fixation of radioactive carbon dioxide in the dark (*cf.* page 203) and the observation of Aufdemgarten (1939) that the "pickup" of carbon dioxide by leaves in the dark after intense photosynthesis also is slowed down by 10^{-3} m./l. of cyanide, from the usual 20–30 seconds to two or three minutes (*cf.* page 207). Thus, the assumption that the cyanide-sensitive component of the photosynthetic apparatus is the carboxylating enzyme E_A (Franck's "catalyst A") is well supported by circumstantial evidence.

The conclusion we derive from this discussion is that differences in the cyanide sensitivity of photosynthesis in different species can be attributed to variations in the content of an enzyme which is not rate limiting under ordinary conditions, but becomes limiting when a large fraction of it is inhibited by cyanide. In the case of *respiration*, the explanation may be similar; but certain observations (see below) make it probable that this process can proceed through different enzymatic channels, some less sensitive to cyanide than others; and this also may explain—at least in part—variations in the over-all sensitivity of respiration to cyanide in different species.

We now return to the alleged existence of *cyanide-resistant residual photosynthesis* which, according to Warburg and van der Paauw, is just sufficient to compensate for respiration. It is known (*cf.*, for example, the review of Commoner 1940) that many cells possess beside the main, cyanide-sensitive respiration, a cyanide-insensitive respiration of comparatively minor importance. In *Chlorella*, the additional respiration, caused by glucose feeding, proves to be much more sensitive to cyanide than normal respiration (Génévois 1927, Emerson 1937). This points to the existence of two alternative enzymatic channels of respiration. Gaffron suggested that a similar situation may exist also in photosynthesis. From this point of view, the coincidence between the extent of cyanide-resistant photosynthesis and that of respiration must be fortuitous. However, another hypothesis is possible, which would make this coincidence significant. This hypothesis suggests that a certain fraction of photosynthesis is insensitive to cyanide *because it uses a different substrate*—namely, unfinished products of respiration (rather than

free carbon dioxide)—and not because it proceeds through a different enzymatic channel. It was stated above that the cyanide-sensitive stage in photosynthesis is the formation of the complex, $\{\text{CO}_2\}$, probably by carboxylation of an organic acceptor. On the other hand, it is known (page 222) that carbon dioxide evolution in respiration occurs by decarboxylation of organic acids. *If these acids could be utilized in photosynthesis before they are decarboxylated, the cyanide-sensitive stage could be avoided.*

The problem of the cyanide-insensitive "residual" photosynthesis certainly requires more experimental study; but if the results of Warburg and van der Paauw were to be confirmed, this would throw new light on the internal relationship between respiration and photosynthesis, by showing that respiration products may become available for photosynthesis before they assume the form of free carbon dioxide.

This interpretation of the cyanide-resistant residual photosynthesis leads to a simple explanation of the discrepancy between the results obtained with *Chlorella* and *Stichococcus* on the one hand, and *Hormidium* and *Scenedesmus* on the other. Since the respiration of the last two algae is more sensitive to cyanide than is their photosynthesis, no cyanide-resistant photosynthesis can be expected in them—and none was found.

Another disagreement between Warburg and van der Paauw remains to be clarified, namely, the assertion of the latter that cyanide poisoning is almost equally efficient in weak as in strong light. The shape of poisoning curves, given by van der Paauw for *Stichococcus* in weak light, is peculiar: They show an inhibition of 50% at 5×10^{-4} m./l. HCN, followed by a renewed increase in rate at the higher concentrations of the inhibitor until, at 5×10^{-3} m./l. HCN, the rate surpasses its normal value. No stimulation of photosynthesis by high cyanide concentrations has ever been observed by other investigators; and the reliability of van der Paauw's curve seems doubtful.

Since cyanide is poisonous to many (although not all) catalysts containing a heavy metal, and several such catalysts are probably involved in photosynthesis, there is no reason to assume that the carboxylating enzyme, E_A , is the *only* cyanide-sensitive component of the photosynthetic apparatus. The "catalase" or "deoxidase" which catalyzes the evolution of oxygen in photosynthesis should, too, be subject to cyanide poisoning. (It was mentioned in chapter 11 that the sensitivity of photosynthesis to cyanide was the first argument in favor of the interpretation of the "Blackman reaction" as the decomposition of a peroxide by the action of catalase; but we have also seen, on page 286, that this argument was reversed by Gaffron when he found an organism in which a complete suppression of catalatic activity by cyanide could be achieved *without* inhibiting photosynthesis.) Apparently, the effect of cyanide on the oxygen-liberating enzyme (or enzymes) remains hidden, because the "preparatory" enzyme, E_A , is less abundant than

the "finishing" enzymes, E_C and E_O , so that its inactivation reduces the rate of the over-all reaction before other cyanide effects become apparent. We shall see in volume II, chapter 33, that inactivation of the enzyme, E_O , may be responsible for most of the *induction* phenomena; therefore cyanide effects observed during the induction period are likely to be due to the poisoning of this enzyme.

2. Effect of Cyanide on Hydrogen-Adapted Algae

The hydrogen-adapted algae, whose metabolism was described in chapter 6, provide an illustration of the fact that several partial processes can be affected by the same inhibitor. According to Gaffron (1944), the two cyanide-sensitive processes are *adaptation* (the process by which the hydrogenase system becomes "activated" during anaerobic incubation) and *carboxylation* (which was held to be mainly or exclusively responsible for the cyanide sensitivity under ordinary conditions).

Cyanide is a highly specific poison for the "adaptation reaction." A concentration of 1×10^{-4} m./l. HCN, which only slightly reduces the rate of normal photosynthesis or respiration in *Scenedesmus* D1 (cf. Table 12.V) completely prevents its adaptation to hydrogen. The same amount, added *after* adaptation, has no immediate effect on the rate of hydrogen consumption. Larger concentrations affect it in the same way as normal photosynthesis, *i. e.*, probably through the inactivation of the carboxylating enzyme, E_A . Cyanide *accelerates de-adaptation*, probably by the following indirect mechanism: The adapted state is maintained by continuous "re-adaptation" of oxidized hydrogenase molecules; in the presence of cyanide, this re-adaptation is blocked, and the enzymatic system gradually slides back into the "oxidized" state.

The *oxyhydrogen reaction*, too, is affected by cyanide, but much less strongly than is the "*chemosynthetic*" reduction of carbon dioxide which may be coupled with it. This, too, agrees with the hypothesis that cyanide affects primarily the enzyme, E_A , which catalyzes the fixation of carbon dioxide preliminary to its reduction (by photosynthesis or by chemosynthesis).

According to Rieke and Gaffron (1943), the effect of cyanide on the photoreduction of adapted algae in *flashing light* is the same as in ordinary photosynthesis, a result which also is in agreement with Franck's hypothesis. The identity of cyanide effects in photosynthesis (*with* evolution of oxygen) and photoreduction (which proceeds *without* this evolution) provides the best proof that the oxygen-liberating enzyme is *not* responsible for the cyanide inhibition.

The effect of cyanide on the *fluorescence* of chlorophyll *in vivo* was studied by Kautsky and Hirsch (1937), Wassink, Vermeulen, Reman, and Katz (1938), Wassink and Katz (1939), and Franck, French, and Puck (1941). It will be dealt with in volume

II, chapter 24. The effect of cyanide on *photosynthesis in flashing light* will be discussed in more detail in chapter 34 (Vol. II); the influence of cyanide on *photooxidation* (Myers and Burr 1940) will be mentioned on page 536, and the effect of this poison on *respiration*, discussed earlier in the present chapter, will be considered again in chapter 20.

3. Inhibition by Hydroxylamine

Hydroxylamine (NH_2OH) is an even stronger poison for photosynthesis than is cyanide, as first shown by Shibata and Yakushiji (1933), who found that 2.2×10^{-4} m./l. $\text{NH}_2\text{OH} \cdot \text{HCl}$ suppresses all photosynthesis in *Chlorella ellipsoidea* (in strong light and in the presence of abundant carbon dioxide), leaving respiration unaffected. Similar results were obtained by Nakamura (1938), who found a 95% inhibition of photosynthesis by 1×10^{-4} m./l. NH_2OH (cf. Table 11.II). The claim of Shibata and Yakushiji that the effect of hydroxylamine proves the role played in photosynthesis by catalase (cf. Chapter 11, page 284) cannot be accepted as valid. *In the first place*, even if the poisoning were due to catalase, the effect could be an *indirect* one (as was once suggested by Gaffron for cyanide): the presence of hydroxylamine could allow hydrogen peroxide, produced by respiration, and normally destroyed by catalase, to accumulate until it destroys one of the photosynthetic enzymes. *In the second place*, it is not true that hydroxylamine inhibits only catalase and no other enzymes. The work of Gaffron, which was discussed in chapter 11, and which showed that, in some algae, catalase can be completely inhibited without a decline of photosynthesis, proves convincingly that the effect of hydroxylamine on photosynthesis is caused by the poisoning of another enzyme, and not of catalase. This hydroxylamine-sensitive enzyme may bear a certain similarity to catalase in that its function, too, is to assist in the liberation of oxygen. This is indicated by experiments on the effect of hydroxylamine on the metabolism of hydrogen-adapted algae (e. g., *Scenedesmus* D1). The photoreduction of carbon dioxide by these algae is much less sensitive to hydroxylamine than is the normal photosynthesis of the same species. While the latter is inhibited completely by 5×10^{-4} m./l. NH_2OH , the reaction with hydrogen is reduced by less than 50%, even in a 3×10^{-2} molar solution. The reduction of carbon dioxide by *bacteria* (with hydrogen or hydrogen sulfide as reductants) is also comparatively indifferent to hydroxylamine. According to chapters 6 and 7, these processes share with ordinary photosynthesis a common (or similar) primary photochemical process which leads to the formation of a "primary oxidation product," $\{\text{OH}\}$ or Z . They differ, however, in the fate of this primary oxidation product—which is decomposed with the liberation of oxygen in normal photosynthesis, but is reduced by hydrogen, hydrogen sulfide, or other reductants, in the photoreduction of bacteria and adapted algae. The

comparative indifference of the last-named process to hydroxylamine clearly indicates that the *hydroxylamine-sensitive enzyme participates only in the oxygen-liberating stage of photosynthesis*.

Weller and Franck (1941) measured the hydroxylamine inhibition of photosynthesis of *Chlorella* in continuous light of varying intensity. Figure 28 shows the unexpected result: The inhibition was found to be

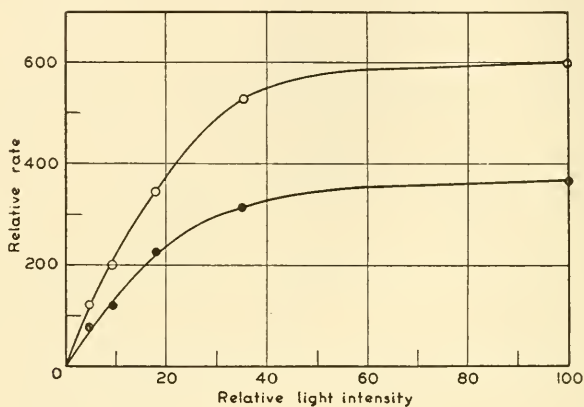

FIG. 28.—Continuous light saturation curves of *Chlorella* with and without hydroxylamine hydrochloride (after Weller and Franck 1941). ○: not inhibited; ●: inhibited by 2.5×10^{-4} m./l. of $\text{NH}_2\text{O}\cdot\text{HCl}$.

independent of light intensity, and thus similar to the effect of narcotics (cf. page 320 *et seq.*) rather than to that of typical “enzyme poisons.” This confronted one with the alternatives: either to consider hydroxylamine as a “narcotic,” thus renouncing the simple interpretation of its ineffectiveness in photoreduction, or to find an explanation of the way in which an enzyme poison can affect photosynthesis *in weak light*. Weller and Franck (1941) suggested that such an explanation is possible if one assumes that the available quantity of the hydroxylamine-sensitive enzyme is *proportional to the intensity of illumination*. In other words, this enzyme must be continuously produced (or activated) by light, and inactivated by a dark reaction, so that its stationary concentration is proportional to the intensity of illumination. This assumption is made less arbitrary by the fact that Gaffron had previously arrived at the same conclusion while attempting to explain the induction phenomena (cf. Vol. II, Chapter 33).

We thus assume, with Weller and Franck, that, in the presence of hydroxylamine, the rate-limiting catalyst is *not* the one which causes light saturation in nonpoisoned cells (“catalyst B” in Franck’s theory), and *not* the one which limits the over-all reaction in the presence of

cyanide (the "carboxylase," E_A), but the oxygen-liberating enzyme (E_C or E_O); and that the limitation imposed on the over-all process by the inactivation of this enzyme is lower the weaker the illumination, thus leading to the same relative inhibition of photosynthesis in strong and in weak light. According to this concept, the effect of hydroxylamine is an indefinite extension of the state which usually prevails only during the "short induction period" (*i. e.*, in the first 2-5 minutes of illumination).

Weller and Franck found that hydroxylamine reduces the oxygen yield per flash in flashing light in a constant proportion, independently of length of the dark intervals between flashes (while cyanide causes a characteristic change in the shape of the flash yield *vs.* dark interval curve; *cf.* p. 307 and Vol. II, Chapter 34). This observation is in agreement with the assumption that these poisons act on two different enzymes.

It was mentioned above that the hydrogen-adapted algae are comparatively insensitive to hydroxylamine. *The capacity for adaptation* is reduced by hydroxylamine to the same extent as normal photosynthesis; but if hydroxylamine is added *after* adaptation, it has only a very slight effect not only on photoreduction, but also on the oxyhydrogen reaction (and a somewhat stronger one on the coupled reduction of carbon dioxide). The most striking effect of larger quantities of hydroxylamine is the *prevention of de-adaptation*. As shown by figure 29, 10^{-3} m./l. NH_2OH prevents photochemical de-adaptation even at 6000 lux.

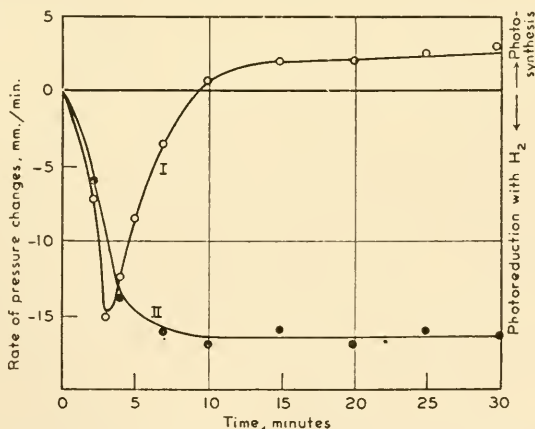

FIG. 29.—Protection of the hydrogen-adapted state in *Scenedesmus* by hydroxylamine against re-adaptation by strong light (6300 lux) (after Gaffron 1942). Curve I: no inhibitor. Curve II: 1×10^{-3} m./l. $\text{NH}_2\text{OH} \cdot \text{HCl}$.

According to Gaffron (1942, 1944), the effects of hydroxylamine on adapted algae can best be understood if one assumes that this poison affects *both* reactions which lead from the primary oxidation product to

free oxygen (*cf.* Scheme 6.I). Apparently, the more sensitive of these two reactions is the evolution of oxygen from the intermediate $\{O_2\}$; this is why ordinary photosynthesis is inhibited by very small quantities of hydroxylamine. Larger quantities, however, also inhibit the reaction by which the intermediate $\{O_2\}$ is *formed* from the primary oxidation products, $\{OH\}$ or Z . This explains the protection of the adapted state by hydroxylamine: in the presence of a sufficient quantity of this poison, the primary oxidation products, which are not transformed by the hydrogenase system, are prevented from being converted into the "de-adapting" oxidants, $\{O_2\}$, and instead disappear harmlessly, probably by back reactions with the primary reduction products, $\{H\}$ or HX .

The comparatively high concentrations of hydroxylamine used in some of Gaffron's experiments made it possible that certain of the observed effects could be due to compound formation with the carbonyl groups in the *metabolites*, rather than to *enzyme* poisoning. However, Gaffron (1944¹) found that all effects caused by hydroxylamine can also be obtained by means of comparatively small quantities of *o*-phenanthroline or *phthiocol* (2-Me-3-hydroxy-1,4-naphthaquinone), which have no affinity for carbonyl groups; they are thus probably all due to specific interactions with photosynthetic enzymes. Phthiocol is a compound related to vitamin K, known to be present in green plants.

Experiments with *o*-phenanthroline, as well as with *phthiocol*, have confirmed an interesting observation (made earlier with hydroxylamine, but considered uncertain because of the high concentration of the poison which had to be used), that the rate of photoreduction in *Scenedesmus* can be reduced by these poisons to one-half its usual value, but not any further (Gaffron 1944²). The quotient $\Delta H_2/\Delta CO_2$ remains equal to 2, so that the over-all process still is that represented by equation (5.6), but its quantum yield is only 1/16 (if the normal value was 1/8). Thus, poisons of this type either block only one of two equally efficient channels of photoreduction, or, more probably, block the normal path completely, but leave open an alternative path which is half as efficient as the one normally used. Gaffron suggested that this alternative mechanism may be related to the mechanism of chemosynthesis in the same algae. It was stated in chapter 9 (page 239) that the properties of hydrogen-adapted algae indicate their capacity to use oxygen instead of the primary photochemical oxidation product (Z or $\{OH\}$), and hydrogen instead of the primary reduction product (HX or $\{H\}$). Chemosynthesis of hydrogen bacteria was attributed on page 236 to a coupled reaction of hydrogen with oxygen and carbon dioxide, which may be formulated as follows by combining equations (6.11a) and (6.12):

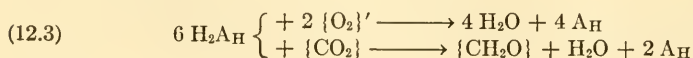

Here, $\{O_2\}'$ is the primary oxygen-acceptor compound of the oxidase system, and H_2A_H the primary hydrogen-acceptor compound of the hydrogenase system.

If we replace in the first of the two coupled reactions, $4 H_2A_H$ by $8 HX$, and $2 \{O_2\}'$ by $8 Z$, and assume that two quanta are required (as usual) for the production of the pair HX and Z (whether by a two-step photochemical transfer, or by a one-step transfer followed by "energy dismutation," is irrelevant), we obtain the following reaction system:

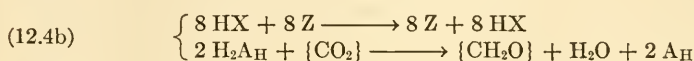
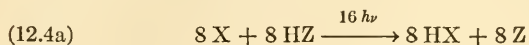

This is the suggested mechanism of photoreduction of phthiocol- (or phenanthroline-) poisoned algae. It requires 16 quanta, instead of the 8 which are sufficient for the normal mechanism of photoreduction:

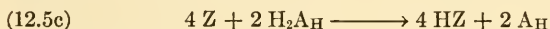
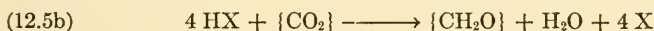
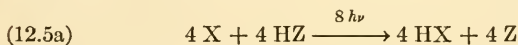

This explanation implies that the poisons under consideration inhibit reaction (12.5c). It was suggested before that hydroxylamine affects, in the first place, the reaction $\{O_2\} \longrightarrow O_2$ (thus preventing the liberation of oxygen), and, in larger quantities, also the reaction $2 Z + \{H_2O\} \longrightarrow 2 HZ + \frac{1}{2} \{O_2\}$, thus preventing de-adaptation by intense light in adapted algae. We have now to postulate a third effect of the same poison, an inhibition of reaction (12.5c). However, this third effect may be related to the second one, since both can be caused by an association of the poison with the substrate Z , or with a catalyst which brings about a preliminary transformation of this substrate, and without which the latter undergoes immediate recombination (as in 11.4b). We may recall in this connection a previous discussion of the probable necessity of stabilizing, in photosynthesis, both the primary reduction product (by means of catalyst E_B) and the primary oxidation product (either by the same or by another catalyst).

4. Hydrogen Sulfide and Other Inorganic Poisons

(a) Hydrogen Sulfide

This compound is a poison for most, if not all, enzymes containing a heavy metal. Its effect on photosynthesis, discovered by Negelein (1925), is even stronger than that of cyanide. A concentration of 10^{-6} m./l. of hydrogen sulfide reduces the photosynthesis of *Chlorella* (in

strong light) by 12%, and of 10^{-5} m./l. by 72%; 10^{-4} m./l. causes a complete stoppage of oxygen production. The respiration of *Chlorella* is stimulated by a concentration of 10^{-4} m./l. H_2S (oxygen consumption is increased by a factor of 1.8; whereas the respiration of yeast is completely suppressed by the same sulfide concentration). These results are closely parallel to those obtained by Warburg with hydrocyanic acid. Nakamura (1938) pointed out the analogy between the effects of hydrogen sulfide on photosynthesis and on catalase activity (cf. Table 11.II). It is plausible that the H_2S -sensitive factor in photosynthesis is the oxygen-liberating enzymatic system, since plants which do not liberate oxygen in light (sulfur bacteria, H_2S -adapted algae) are not only uninhibited by hydrogen sulfide, but even utilize this compound as an oxidation substrate, as described in chapters 5 and 6. If this interpretation is correct, experiments made with hydroxylamine should be repeated with hydrogen sulfide.

(b) *Carbon Monoxide*

Padoa and Vita (1929) observed a partial or complete inhibition by carbon monoxide of photosynthesis in *Plantago major* and in the aquatic plants, *Lemna minor* and *Elodea canadensis*; their respiration was stimulated rather than inhibited. These authors assumed that carbon monoxide is absorbed by chlorophyll in the same way as by hemoglobin. Later (1932), they described reversible changes in the absorption spectra of chlorophyll solutions in benzene, caused by saturation with carbon monoxide, and considered these results as proofs of the existence of a labile addition compound of chlorophyll and carbon monoxide. However, their photometric curves are not convincing (cf. Vol. II, Chapter 21); and in the opinion of Gaffron (1935), their data on the inhibition of photosynthesis by carbon monoxide also are unreliable.

Gaffron has investigated the effect of this gas on different algae (*e. g.*, *Phormidium tenue*), and found that carbon monoxide has no effect or only a very slight effect on ordinary photosynthesis. On the other hand, he found strong carbon monoxide effects—ranging from a reversible stoppage of gas exchange to an irreversible injury—when this gas was allowed to act on certain algae after a period of anaerobic incubation. As described in chapter 6, Gaffron later (1942) found that this incubation caused the transition from ordinary photosynthesis to “photoreduction” involving molecular hydrogen or intercellular hydrogen donors. Gaffron suggested, therefore, that carbon monoxide (in concentrations of the order of 20%) is a *specific inhibitor of the hydrogenase* (whose activation is responsible for the oxidation-reduction processes in adapted algae), and does not interfere with the enzymatic system of normal photosynthesis. By inhibiting hydrogen absorption and not interfering with photosynthesis, carbon monoxide prevents the adaptation and accelerates

the de-adaptation of *Scenedesmus*. An inhibition of hydrogenase by carbon monoxide also was found by other investigators, *e. g.*, in experiments with *Azotobacter*.

(c) *Sulfur Dioxide, and Nitrous Oxides*

The poisoning of the photosynthetic apparatus by sulfur dioxide and by the oxides of nitrogen was investigated by Noack and coworkers from a point of view somewhat different from that adopted in the investigations discussed so far. Noack (1925) started his research with the concept that the iron contained in the chloroplasts plays a catalytic part in photosynthesis—not (or not only) the small part of it which is contained in organic complexes, but also that larger part which gives the hematoxylin color test and is therefore present in the form of noncomplex organic or inorganic salts (*cf.* Chapter 14, page 376). A second assumption of Noack was the hypothesis (*cf.* Chapter 19, part A) that, when photosynthesis is inhibited, the light energy absorbed by chlorophyll is diverted towards destructive “photodynamic” reactions which oxidize and destroy both the protoplasm and the pigment. Starting from these two concepts, Noack set out to study the destructive effect on plant cells and pigments of reagents known to react with noncomplex iron. The effect of sulfurous and nitrous gases on vegetation is well known, and it is also known that the assimilating tissues are the first to be damaged. Noack found that, by proper caution (*e. g.*, in experiments with the water moss *Fontinalis*, by using a $5 \times 10^{-4}\%$ solution of sodium bisulfate), the damage caused by sulfur dioxide can be restricted to the chloroplasts without affecting the protoplasm. The moss was treated with the bisulfate solution *in the dark*, then washed and illuminated. It showed a gradual deterioration of photosynthetic efficiency; after 24 hours of illumination, oxygen evolution was replaced by oxygen consumption, and the chloroplasts began to show decoloration, which Noack attributed to a “photodynamic” oxidation.

In a subsequent investigation by Wehner (1928), similar treatments by nitrous, sulfurous and hydrochloric acid gases, and ammonia, were applied not only to *Fontinalis*, but also to whole land plants (clover) and detached leaves (tobacco and spinach). A treatment with sulfur dioxide or nitrogen oxides in the dark made all these plants liable to photooxidation, even though the poison was washed out before illumination. Hydrogen chloride acted less strongly, while ammonia showed no effect at all (that is, its damaging influence was not enhanced by subsequent illumination). Very small quantities of sulfur dioxide and of nitrogen oxides acted as stimulants.

Since Noack ascribed the effect of all these poisons to the binding of iron, Wehner attempted to “cure” the poisoned plants by the adminis-

tration of iron salts. He claimed some success: for example, immersing *Fontinalis* into a $5 \times 10^{-3}\%$ ferrous ammonium citrate solution (after this water moss was poisoned by fuming nitric acid) produced an increase in photosynthesis from 35 to 51% of the normal rate. Poisoning by phenylurethane (which, according to Noack, also promotes photooxidation) was not relieved by iron salts.

In another paper (1930), Noack attempted to support his theory by experiments of a different kind: he tried to show that sulfur dioxide and the nitrogen oxides actually affect the state of the iron in the chloroplasts. These experiments (which will be described in Chapter 14) showed that the percentage of water-soluble iron in the leaves is increased from 6 to 12% by the action of sulfur dioxide. Potassium cyanide caused an increase to 10%, and potassium thiocyanide (according to Noack this compound, too, is a specific poison for photosynthesis) to 12.6%.

Noack saw in these experiments the confirmation of his theory that simple iron compounds, rather than hemoprotein complexes, serve as catalysts in photosynthesis. In this extreme form, Noack's hypothesis certainly is incorrect, since true enzymes undoubtedly play an important part in photosynthesis (the phenomena of reversible poisoning—*e. g.*, by cyanide or dinitrophenol—clearly indicate the participation of such enzymes). Another and still open question is whether, *in addition to true enzymes*, simple organic or inorganic iron salts also play a catalytic part in photosynthesis.

(d) *Hydrogen Peroxide and Sodium Azide*

The effect of *hydrogen peroxide* was described in chapter 11. It can be observed only when catalase is inhibited, as by cyanide (which can be achieved in some strains of *Scenedesmus* without a simultaneous inhibition of photosynthesis). It was stated on page 286 that the peroxide-sensitive part of the photosynthetic apparatus is probably the oxygen-liberating enzyme. The inhibition may be due either to *oxidations* brought about by the high oxidation potential of the peroxide (*cf.* page 283) or, as suggested by Gaffron, to *complex formation* with the affected enzyme (in competition with the normal substrate, but without catalytic decomposition, in the same way as this was observed in the inhibition of catalase by ethyl peroxide).

Sodium azide also inhibits photosynthesis, even in algae which are insensitive to cyanide (Gaffron 1944).

5. Iodoacetyl and Other Organic Poisons

Kohn (1935) found that the *iodoacetyl* radical is a specific poison for photosynthesis in *Chlorella pyrenoidosa*. He used iodoacetic acid, (ICH_2COOH), or its amine, ($\text{ICH}_2\text{COONH}_2$). The action was slow

(complete inhibition required one or two hours). The free acid acted particularly slowly in alkaline buffers and somewhat more rapidly in acid solution (because of the greater ease with which neutral molecules, which are present at the lower pH, can penetrate through cell membranes). The amine, which does not dissociate, acts with the same velocity in acid and in alkaline solutions. Its inhibiting effect becomes manifest in concentrations from 10^{-4} m./l. upwards; concentrations below 10^{-5} m./l. may cause a slight stimulation. A concentration of 10^{-3} m./l. of the amine is sufficient for an almost complete suppression of photosynthesis. Respiration is inhibited only above 10^{-3} m./l. Inhibition is more complete in saturating than in "half-saturating" light. This characterizes iodoacetyl as an "enzyme poison," similar to cyanide, rather than as a narcotic. Kohn pointed out that iodoacetyl has no tendency to form complexes with heavy metals, so that it should affect other enzymes than those inhibited by cyanide. He suggested an effect on sulfhydryl groups (with which iodoacetyl is known to react irreversibly). However, according to Nakamura (Table 11.I), iodoacetyl is also a strong inhibitor of catalase, which is a hemoprotein. Obviously, an enzyme molecule may contain more than one grouping whose transformation can cause an inactivation of the molecule as a whole.

Dinitrophenol affects strongly both photosynthesis and photoreduction; it has no specific effect on the adaptation reaction. Gaffron (1942) found that dinitrophenol also inhibits *hydrogen fermentation* in the dark, but does not affect hydrogen evolution *in light* (or even stimulates it), which proves that the latter process is independent of an enzyme which takes part in hydrogen production in the dark (*cf.* page 143). Dinitrophenol has no affinity for heavy metals and is therefore supposed to act on enzymatically active *proteins*. Apparently, it affects photosynthesis by inhibiting the *transfer of hydrogen* from an intermediary reduction product to carbon dioxide, since this stage is common to both photosynthesis and photoreduction. (Catalytically active proteins may be used to transfer hydrogen *atoms*, while heavy metal complexes transfer *electrons*.) However, the influence of dinitrophenol on hydrogen fermentation requires an independent explanation.

Since dinitrophenol inhibits both photosynthesis and photoreduction, it leaves the *photochemical hydrogen liberation* as the only light reaction in adapted algae. The apparent *stimulation* of this reaction by dinitrophenol may be due to the prevention of losses usually caused by the reaction of hydrogen with carbon dioxide (formed by fermentation, and not absorbed rapidly enough by alkali).

o-Phenanthroline and *phthiocol* were found by Gaffron (1944) to produce in *Scenedesmus* effects very similar to those of hydroxylamine—including inhibition of photosynthesis in small concentrations and of de-

adaptation in somewhat larger quantities, and reduction of the quantum yield of photoreduction with hydrogen by a factor of 1/2 (*cf.* p. 314).

Green, McCarthy, and King (1939) investigated the effect on the metabolism of *Chlorella* of poisons which are known to affect specifically the catalytic activity of enzymes containing copper, *e. g.*, *thiourea*, *allylthiourea*, *8-hydroxyquinoline* and *sodium diethyl dithiocarbamate*, and found that all of them inhibit both photosynthesis and respiration of this organism.

B. NARCOTICS *

It was stated on page 300 that narcotization is a capillary phenomenon—blocking of “active surfaces” by surface-active compounds. A relation between narcotization and surface activity was noted by Traube forty years ago: he found that, in homologous series of organic compounds, the efficiency of narcotization increases with the length of the carbon chain, and thus parallels surface activity.

Narcotic poisoning is, in general, less specific than enzymatic poisoning, both in regard to the molecular structure of the poison and to the constitution of the catalytic systems affected by it. However, the field of narcotization is wide and also includes the action of such powerful poisons or stimulants as morphine, strychnine and quinine, whose effect on biocatalytical processes is more likely to be due to specific interactions with definite catalysts, than to an indiscriminate surface-blocking action.

True narcotization of animals is characterized by *reversibility*. However, large quantities of narcotics, or a prolonged exposure to any one of them, usually cause irreparable damage or even death. Many substances which have a narcotic effect on higher animals also inhibit photosynthesis in plants; in this case, too, the initially reversible inhibition can lead to an irreversible injury, if exposure lasts too long. Overdosage, as well as differences in the sensitivity of different species (and perhaps even individuals), have caused a considerable confusion in this field of study.

The narcotization of photosynthesis by *chloroform* was discovered by Bernard in 1878. He found that photosynthesis is *reversibly inhibited* by chloroform even before the latter affects respiration. On the other hand, Schwartz (1881) found that the suppression of photosynthesis by ether is associated with *irreversible destruction* of the tissue. Bonnier and Mangin (1886) contradicted Schwartz and stated that, when used carefully, ether as well as chloroform, causes only a reversible inhibition of photosynthesis; similar results were obtained by Ewart in experiments on the effect of ether on different mosses (1896) and of chloroform on *Elodea* (1898). He found that even a short exposure of mosses to high concentrations of narcotics leads to death, but that, if low concentrations

* Bibliography, page 325.

are used, the inhibition of photosynthesis is reversible. Kny (1897) went to another extreme, and asserted that even plants which are almost dead from chloroform poisoning continue to liberate oxygen; but his experiments were sharply criticized by Ewart (1898). Kegel (1905) and von Körösy (1914) made quantitative studies of the narcotization of water plants, using the bubble counting method (*cf.* Vol. II, Chapter 25). This work was analyzed by Schmucker (1928), who stressed the errors to which bubble counting—which is never very reliable—can lead in the presence of surface-active substances. Schmucker confirmed the reversibly inhibiting effect of *low concentrations* of chloroform and ether, but attributed to an error the assertion of Kegel that *high concentrations* of these narcotics may cause *stimulation* of photosynthesis. Schmucker's own data (obtained mainly with *Cabomba caroliniana*) are given in table 12.VII. Irving (1911), using excised cherry laurel and barley

TABLE 12.VII
EFFECT OF NARCOTICS ON CABOMBA CAROLINIANA

<i>Chloroform:</i>	<i>No stimulation</i> by low concentrations. <i>Reversible inhibition</i> by 0.025–0.1% by vol. (0.0032–0.063 m./l.) <i>Injury and death</i> by 0.1% by vol.
<i>Ether:</i>	<i>Weak stimulation</i> by 0.1% by vol. <i>Reversible inhibition</i> by 0.2–2.5% by vol. (0.02–2.4 m./l.)
<i>Ethanol:</i>	<i>Weak stimulation</i> by 0.3–1% by vol. <i>Reversible inhibition</i> by 1–3% by vol. (0.17–0.52 m./l.)

leaves, observed a much higher sensitivity to chloroform than that found by Kegel and Schmucker with water plants. In her experiments, 0.001% by volume of chloroform vapor in the air stream was enough to cause a complete stoppage of photosynthesis; a slightly larger concentration made the injury irreversible. Wallace (1932), also working with detached leaves (of *Acer negundo*), renewed the assertions of Schwartz that chloroform and ether always cause an irreversible injury.

Some observations on the effect of *thymol* on the photosynthesis of *Chlorella* can be found in a paper by Emerson and Arnold (1932).

Inhibition of photosynthesis by *alkaloids* (quinine, strychnine, morphine) was observed by Marcacci (1895) and Treboux (1903). According to Treboux, complete inhibition is caused by 0.15% quinine chloride.

Warburg, in 1919, introduced *phenylurethan* into the study of photosynthesis. From then on, compounds of this class became favorites in all experiments on the narcotization of photosynthesis. The urethans

are ethyl esters of alkyl carbamic acids: $\text{RNH}-\overset{\text{O}}{\parallel}{\text{C}}-\text{OC}_2\text{H}_5$. Their

surface activity increases regularly with the increase in size of the radical R; and the narcotization efficiency increases parallel with it. According to Warburg, the quantities of urethan required to reduce respiration in *Chlorella* are about three times as large as those which cause a similar reduction of photosynthesis (cf. Table 12.VIII).

TABLE 12.VIII

INHIBITION OF RESPIRATION AND PHOTOSYNTHESIS IN CHLORELLA BY URETHANS

$\text{RNH}-\overset{\text{O}}{\parallel}{\text{C}}-\text{OC}_2\text{H}_5,$ where R is	Concentration, millimoles/liter, required for a 50% reduction	
	Of respiration	Of photosynthesis
Methyl	1200	400
Ethyl	780	220
Propyl	100	50
Isobutyl	43	17
Isoamyl	32	12
Phenyl	6	0.5

Figure 30 shows the effect of increasing quantities of phenylurethan on photosynthesis. The respiration of *Chlorella* is *stimulated* by phenylurethan in quantities from 0.001 to 0.025%; it reverts to its normal rate at 0.05%, and is inhibited by higher concentrations. Noack (1925) found that *Fontinalis*, pretreated with urethan, becomes susceptible to photooxidation even in the presence of carbon dioxide (cf. page 528).

According to Warburg (1920) and Wassink, Vermeulen, Reman, and Katz (1938), urethans inhibit photosynthesis equally efficiently at *all intensities of illumination*. This is illustrated by figure 31. The influence of urethan is, according to Warburg, also independent of the *concentration of carbon dioxide*.

The inhibition of photosynthesis in weak light shows that urethan prevents the transfer of excitation energy from chlorophyll to the reaction substrate, thus interfering with the primary photochemical process. It can do this either by enveloping chlorophyll molecules (or catalytic complexes of which chlorophyll forms a part), or by protecting in a similar way the "acceptors" on which the substrates are fixed while awaiting photochemical transformation. The enhancing effect of urethan on chlorophyll *fluorescence* in living *Chlorella* cells (which will be described in Vol. II, Chapter 24) shows that urethan does come into contact with chlorophyll during the excitation period of the latter. We may assume either that urethan associates itself with chlorophyll, or that chlorophyll molecules encounter, during their excitation period, photoactive substrates with which they can react if they are not protected by urethan

molecules. The first picture is the simpler of the two, and was used particularly by Franck and coworkers. Its correctness could possibly be tested by an investigation of the effect of urethan on the *absorption spectrum* of chlorophyll in the cells (an association could reveal itself in changes in this spectrum). The inhibiting effect of urethan and other narcotics *in strong light*, where the reaction rate is limited by an enzymatic reaction, was interpreted by Ornstein, Wassink, Reman, and Vermeulen (1938) as an indication that these substances interfere not only with the

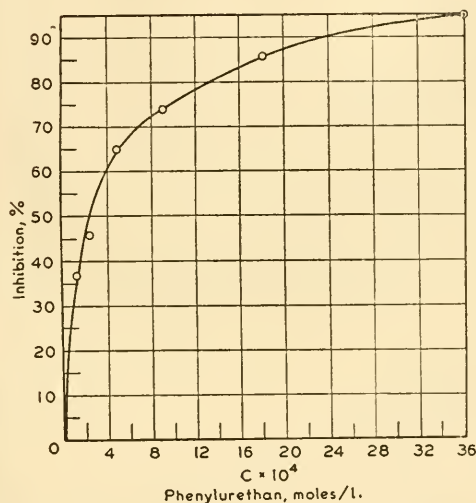

FIG. 30.—Inhibition of photosynthesis in *Chlorella* by phenylurethan (after Warburg).

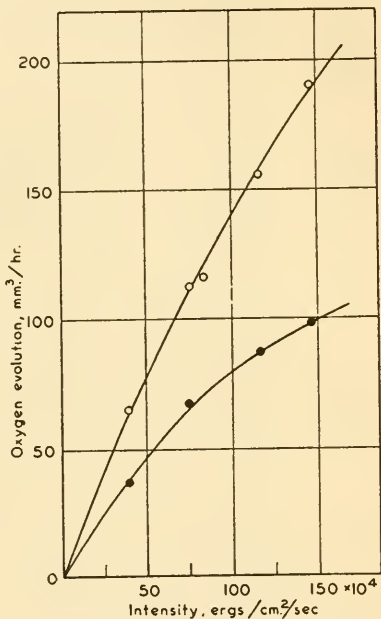

FIG. 31.—Light curves of photosynthesis in *Chlorella* with and without ethylurethan (after Wassink, Vermeulen, Reman, and Katz 1938). \circ : not inhibited; \bullet : inhibited by 0.05 ml. 50% urethan in ml.

sensitization process, but also with the enzymatic mechanism of photosynthesis, by blocking enzymes responsible for light saturation. In consideration of the nonspecific capillary nature of narcotic inhibition, this hypothesis is not plausible. However, another interpretation of the same phenomenon also is feasible. The true saturation rate of photosynthesis in the presence of narcotics may be the same as in their absence, but it may require a much more intense illumination (because a large fraction of chlorophyll is enveloped by the narcotic and light absorbed by it is lost for photosynthesis). If this hypothesis is correct, a full yield

of photosynthesis could be obtained also in the presence of narcotics, by increasing the light intensity far above the value sufficient for light saturation under normal conditions.

Bibliography to Chapter 12

Catalyst Poisons and Narcotics

A. Catalyst Poisons

- 1919 Warburg, O., *Biochem. Z.*, **100**, 230.
- 1920 Warburg, O., *ibid.*, **103**, 188.
- 1923 Lund, E. J., and Holt, G. A., *Proc. Soc. Exptl. Biol. Med.*, **20**, 232.
- 1925 Noack, K., *Z. Botan.*, **17**, 481.
Negelein, E., *Biochem. Z.*, **165**, 203.
- 1927 Génévois, L., *ibid.*, **186**, 274.
- 1928 Wehner, O., *Planta*, **6**, 543.
- 1929 Emerson, R., *J. Gen. Physiol.*, **12**, 623.
Padoa, M., and Vita, N., *Ann. chim. applicata*, **19**, 141.
- 1930 Noack, K., *Z. Botan.*, **23**, 957.
van der Paauw, F., *Rec. trav. botan. néerland.*, **29**, 149.
- 1932 Padoa, M., and Vita, N., *Biochem. Z.*, **244**, 296.
Emerson, R., and Arnold, W., *J. Gen. Physiol.*, **15**, 391.
- 1933 Shibata, K., and Yakushiji, E., *Naturwissenschaften*, **21**, 267.
- 1934 Emerson, R., and Green, L., *J. Gen. Physiol.*, **17**, 817.
- 1935 Kohn, H. I., *ibid.*, **19**, 23.
Gaffron, H., *Biochem. Z.*, **280**, 337.
van der Paauw, F., *Planta*, **24**, 353.
- 1937 Emerson, R., *Ann. Rev. Biochem.*, **6**, 53.
Kautsky, R., and Hirsch, A., *Biochem. Z.*, **277**, 250.
Gaffron, H., *ibid.*, **292**, 241.
- 1938 Wassink, E., Vermeulen, D., Reman, G. H., and Katz, E., *Enzymologia*, **5**, 100.
Nakamura, H., *Acta Phytochim. Japan*, **10**, 271, 343.
- 1939 Gaffron, H., *Biol. Zentr.*, **59**, 302.
Aufdemgarten, H., *Planta*, **29**, 643.
Wassink, E. C., and Katz, E., *Enzymologia*, **6**, 145.
Green, L. F., McCarthy, J. F., and King, C. G., *J. Biol. Chem.*, **128**, 447.
- 1940 Myers, J., and Burr, G. O., *J. Gen. Physiol.*, **24**, 45.
Commoner, B., *Biol. Rev. Cambridge Phil. Soc.*, **15**, 168.
Ruben, S., Kamen, M. D., and Hassid, W. Z., *J. Am. Chem. Soc.*, **62**, 3443.
- 1941 Franck, J., French, C. S., and Puck, T. T., *J. Phys. Chem.*, **45**, 1268.
Weller, S., and Franck, J., *ibid.*, **45**, 1359.
- 1942 Gaffron, H., *J. Gen. Physiol.*, **26**, 195, 241.
Gaffron, H., and Rubin, J., *ibid.*, **26**, 219.
- 1943 Rieke, F. F., and Gaffron, H., *J. Phys. Chem.*, **47**, 299.

- 1944 Gaffron, H., *Biol. Rev. Cambridge Phil. Soc.*, 19, 1.
 1945 Gaffron, H., *J. Gen. Physiol.*, 28, 259, 269.

B. Narcotics

- 1878 Bernard, Claude, *Leçons sur les phénomènes de la vie communs aux animaux et aux végétaux*, Vol. 1, Baillière, Paris, 1878.
 1881 Schwartz, F., *Untersuch. Botan. Inst. Tübingen*, 1881, 102.
 1886 Bonnier, G., and Mangin, L., *Ann. sci. nat. Botan.*, (7) 3, 1.
 1895 Marcacci, A., *Nuovo gior. botan. ital.*, 2, 222.
 1896 Ewart, A. J., *J. Linnean Soc. Botany*, 31, 364, 554.
 1897 Kny, L., *Ber. deut. botan. Ges.*, 15, 388.
 1898 Ewart, A. J., *Ann. Botany*, 12, 415.
 1903 Treboux, O., *Flora*, 92, 56.
 1905 Kegel, W., *Dissertation*, Univ. Göttingen, 1905.
 1911 Irving, A. A., *Ann. Botany*, 25, 1077.
 1914 von Kőrösy, K., *Z. physiol. Chem.*, 93, 145.
 1919 Warburg, O., *Biochem. Z.*, 100, 230.
 1920 Warburg, O., *ibid.*, 103, 188.
 1925 Noack, K., *Z. Botan.*, 23, 957.
 1928 Schmucker, Th., *Biochem. Z.*, 195, 149.
 1932 Wallace, R. H., *Am. J. Botany*, 19, 847.
 Emerson, R., and Arnold, W., *J. Gen. Physiol.*, 15, 391.
 1938 Wassink, E., Vermeulen, D., Reman, G. H., and Katz, E., *Enzymologia*, 5, 100.
 Ornstein, L. S., Wassink, E. C., Reman, G. H., and Vermeulen, D., *ibid.*, 5, 110.

CHAPTER 13

INHIBITION AND STIMULATION OF PHOTOSYNTHESIS

II. VARIOUS CHEMICAL AND PHYSICAL AGENTS

A. INFLUENCE OF OXYGEN ON PHOTOSYNTHESIS *

The influence of oxygen in photosynthesis has two aspects: complete *absence* of oxygen often brings photosynthesis to a standstill; while an *excess* of oxygen invariably reduces the rate of this process.

The *necessity for traces of oxygen* for photosynthesis has been much discussed but not yet completely clarified. Boussingault (1865) and Pringsheim (1887) were the first to notice that plants lose their capacity for photosynthesis after a sojourn in hydrogen, nitrogen, or methane. Willstätter and Stoll (1918) observed that some species (*e. g.*, *Pelargonium*) lost almost all their capacity for photosynthesis after only two hours in an oxygen-free atmosphere, while others (*e. g.*, *Cyclamen*) required as much as 15 hours of "anaerobic incubation." The small residual capacity of anaerobically treated leaves for photosynthesis was sufficient to restore the aerobic conditions and thus to remove the inhibition after several hours of exposure to light. Willstätter and Stoll noted that, when this "autocatalytic" restoration of photosynthesis was achieved, the partial pressure of oxygen still was exceedingly low—much lower than that required for the resumption of respiration. This fact, and the length of the anaerobic treatment necessary for inhibition, led Willstätter and Stoll to the belief that photosynthesis requires the saturation of an oxygen-acceptor complex in the cells rather than the presence of free oxygen in the atmosphere. They suggested that this complex dissociates slowly in an oxygen-free atmosphere, and is regenerated by photosynthesis before any oxygen can escape from the cells. A similar point of view was taken by Kautsky (1931, 1939), who thought that the energy absorbed by all sensitizers must be transferred to oxygen or (in the case of photosynthesis) to an oxygen-acceptor complex before it can be utilized for chemical transformations. Since this altogether implausible hypothesis was based on observations of fluorescence, we shall discuss it in chapter 24 (Vol. II), which deals with the fluorescence phenomena in living plants.

Another explanation of anaerobic inhibition was suggested by Willstätter (1933) and Franck (1935), who thought that the first step in

* Bibliography, page 347.

photosynthesis may be the photochemical dehydrogenation of chlorophyll by oxygen, leading to the formation of a photochemically active "monodehydrochlorophyll." (This hypothesis has a certain similarity to the concept of "energy dismutation" described in chapter 9.)

However, the need for a special explanation of the role of oxygen in photosynthesis, became doubtful when the reality of the phenomenon itself was challenged. Harvey, in 1928, used the extremely sensitive luminous bacteria to show that algae start evolving oxygen within a second after the beginning of illumination, even in a medium deprived of all traces of oxygen; and, more recently, Franck and Pringsheim (unpublished) found, by observing the quenching of phosphorescence of adsorbed dyestuffs, that algae produce oxygen by the very first light flash, even after two hours incubation in purest nitrogen.* After the similarity of the photochemical processes in green plants and purple bacteria was established, Gaffron (1933, 1935) pointed out that many purple bacteria thrive only under strictly anaerobic conditions. This too, indicates that oxygen is not necessary for photosynthesis.

As to the undoubtedly real anaerobic inhibition phenomena, Gaffron pointed out that the length of the required incubation period points to a slow accumulation of fermentation products rather than to dissociation of a labile oxygen compound (compare the instantaneous dissociation of oxyhemoglobin!). Green plants deprived of oxygen ferment, producing alcohols and organic acids (*cf.* Chapter 6, page 130); some of these products may well be poisonous to the photosynthetic apparatus. Experiments of Gaffron (1935), of Noack, Pirson, and Michels (1939), and of Michels (1940) showed that anaerobic inhibition is strong only in acid solution, and is less pronounced, or even entirely absent, in alkaline buffers. (For a detailed description of these experiments, see chapter 33 in volume II.) Consequently, Noack and coworkers attributed it to free fermentation acids (*e. g.*, lactic acid).

As mentioned before, different species respond differently to anaerobic treatment. In the higher plants, prolonged anaerobic incubation usually causes, in addition to reversible inhibition, an irreversible injury. The moss *Mnium undulatum*, on the other hand, was described by Briggs (1933) as capable of withstanding 24 hours of anaerobic incubation without permanent injury (although an induction period of two hours was required afterwards for the resumption of photosynthesis). Equally resistant are algae, which can withstand even several days of anaerobiosis. In some algae, as, for instance, *Chlorella*, the only result of a prolonged anaerobic incubation, is an extension of the induction period of normal photosynthesis. In others—*Scenedesmus*, *Ankistrodesmus*, and *Raphi-*

* It was too late to include here a detailed discussion of the new experiments of Franck and coworkers on photosynthesis under anaerobic conditions; they will be discussed in volume II.

dium (Gaffron 1940)—the same treatment produces the phenomena of hydrogen fermentation and “photoreduction,” described in chapter 6, attributed by Gaffron to activation of hydrogenase by fermentation products.

None of these experiments prove that the absence of oxygen *during* the illumination—without previous anaerobic incubation—has an inhibiting effect on photosynthesis; and the results of Harvey, Franck and Pringsheim, and Gaffron can be quoted as evidence against such an assumption.

Kautsky and Eberlein (1939) argued against the “fermentation theory” of anaerobic incubation by pointing out: (1) that characteristic changes in chlorophyll fluorescence can be observed after an incubation of only 1–1.5 hours; (2) that the aerobic state can be restored within one minute after the admission of oxygen; and (3) that the effect depends

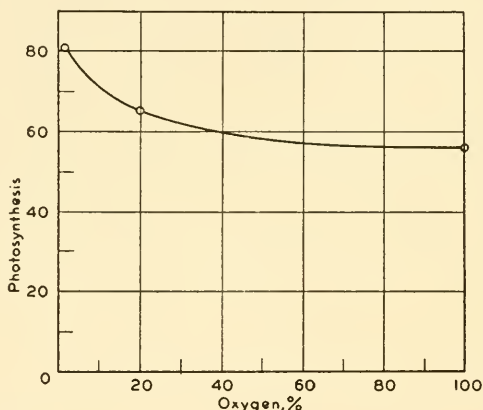

FIG. 32.—Inhibition of photosynthesis of *Chlorella* by excess oxygen (after Warburg). Marked inhibition by 20% O_2 .

on the specific oxygen pressure used. However, an incubation period of one hour suffices to develop fermentation, and an oxidation period of one minute may suffice to destroy photochemically the fermentation poisons in the chloroplasts. As to point (3), the extent (and even the qualitative character) of fermentation may well depend on the residual oxygen pressure, particularly in the region in which the rate of respiration is a function of this pressure.

The inhibition of photosynthesis by excess oxygen was discovered by Warburg (1920) and studied by Wassink, Vermeulen, Reman, and Katz (1938), and McAlister and Myers (1940). Warburg and McAlister and Myers found a decrease of about 30% in the maximum rate of photosynthesis (in strong light and abundant carbon dioxide) of *Chlorella* (Fig. 32) and wheat (Vol. II, Chapter 33) when the oxygen concentration was increased from 0.5 to 20%. Wassink and coworkers, on the other

hand, found no difference between the rates in pure nitrogen and in air (20% O₂) but a considerable difference between the rates in air and pure oxygen (Fig. 33).

In attempting to explain the oxygen inhibition, one naturally thinks of the fact that high oxygen pressure promotes photooxidation (*cf.* Chapter 19), which could consume a part of the oxygen liberated by photosynthesis. However, it will be shown in chapter 19 that oxygen produc-

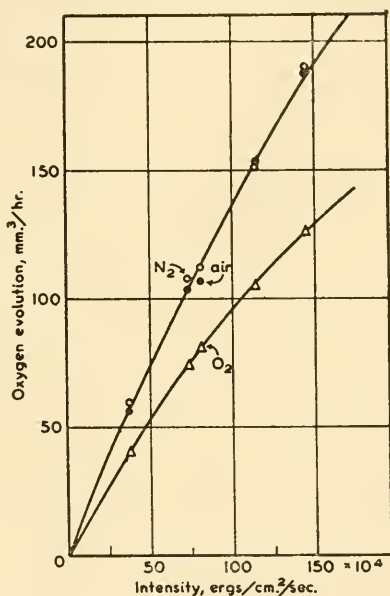

FIG. 33.—Inhibition of photosynthesis of *Chlorella* by excess oxygen (after Wassink, Vermeulen, Reman, and Katz). No inhibition by 20% O₂. △, O₂; ○, N₂; ●, air.

tion by photooxidation (which can be measured under the same partial pressure of oxygen, in the absence of carbon dioxide, *cf.* Fig. 56) is *ten times smaller* than the loss of oxygen production by photosynthesis. Thus, oxygen *inhibits* photosynthesis and does not merely *balance* it by photooxidation. Franck and French (1941) assumed that this effect is caused by the photooxidation of an *enzymatic component* of the photosynthetic apparatus. The inhibition of photosynthesis by *excess light*, (*cf.* Chapter 19, page 532) was assumed by Myers and Burr (1940) and Franck and French (1941) to be brought about in a similar way, that is, by photooxidation of one of the "photosynthetic enzymes." Specifically, Franck and French suggested that the oxygen-sensitive catalyst is the carboxylating enzyme, E_A . In very strong light, the supply of {CO₂} complexes, which is controlled by catalyst E_A , lags behind the velocity

of their photochemical transformation; consequently, some of the sensitizer becomes idle and can supply energy for photooxidations; and the catalyst E_A may become the first victim of this photooxidation. Thus, the inhibition effect grows "autocatalytically," and, in sufficiently strong light, photosynthesis may come to a complete standstill. In moderate light, the inhibition remains incomplete, despite its autocatalytic acceleration, because catalyst E_A is continuously restored by the organism, so that, after some time, an equilibrium is reached between the rate of its destruction by photooxidation and of its restoration by metabolic processes. From then on, photosynthesis can run steadily at a rate corresponding to the stationary concentration of the active catalyst, E_A .

B. EFFECT OF EXCESS CARBON DIOXIDE *

The effect on photosynthesis of the partial pressure of carbon dioxide will be discussed in volume II, chapter 27. We shall find there that the rate increases with the concentration of carbon dioxide, until the latter reaches about 0.1% (corresponding to a partial pressure of about 0.8 mm.), and then becomes constant. However, photosynthesis has often been found to *decrease* at very high concentrations of carbon dioxide. This was first observed by de Saussure (1804), then by Boussingault (1868), Böhm (1873), and Ewart (1896), and interpreted by Chapin (1902) as a case of narcotic poisoning. However, if narcotization is attributed to a competition between the reactants and the narcotic for the catalytically active surfaces in the photosynthetic apparatus, one may ask how carbon dioxide can "compete with itself." An answer is that the full efficiency of photosynthesis is achieved when the different catalysts are occupied by their respective substrates, which include carbon dioxide, water, and various intermediates. An excessive concentration of carbon dioxide can cause a "squeezing out" of the intermediates, and thus hinder the completion of the transformation. Another possible effect of high concentrations of carbon dioxide—which also may affect the rate of photosynthesis—is the acidification of the cell fluids, whose buffering capacity is not unlimited.

The sensitivity to excess carbon dioxide varies widely from species to species. Blackman and Smith (1911) found no decline in the rate of photosynthesis of *Elodea* and *Fontinalis*, even in water equilibrated with an atmosphere containing 35% carbon dioxide. Jaccard and Jaag (1932) found some leaves to be indifferent to carbon dioxide concentrations of 15% or more; and Ewart (1896) observed that mosses can survive in an atmosphere of pure carbon dioxide (which is lethal to other plants). Singh and Kumar (1935) reported, on the other hand, that a maximum of the photosynthesis of radish leaves occurs at 5% carbon dioxide, and

* Bibliography, page 348.

is followed by a sharp decline. Livingston and Franck (1940) found that detached leaves of *Hydrangea otaksa* are strongly, but not completely, inhibited by 20% carbon dioxide; young leaves and leaves rich in sugar are more tolerant than old or starved leaves. Leaves can be "conditioned" to high carbon dioxide concentrations by increasing the concentration in small increments; "conditioned" leaves retain one-half their maximum capacity for photosynthesis in 20% carbon dioxide and one-sixth in 50% carbon dioxide, but are less efficient than before at the lower concentrations.

One clue to the behavior of plants in excess carbon dioxide is furnished by the observation of Chapman, Cook, and Thompson (1924) that a high pressure of carbon dioxide induces closure of the stomata. It is therefore advisable to make quantitative experiments on carbon dioxide inhibition with stomata-free mosses and algae. The observation of Spoehr (1939) that a high concentration (> 10%) of carbon dioxide stops the dissolution of starch in the chloroplasts may explain the closure of the stomata (*cf.* page 47).

According to Ballard (1941) the effect of excess carbon dioxide on photosynthesis is strongly dependent on temperature. In *Ligustrum*, the depression can be observed at 6° C., beginning with 2-2.5% carbon dioxide, while at 16° no effect is noticeable even at 5%. The effect is stronger in intense light than in weak light, showing that excess carbon dioxide obstructs an enzymatic reaction and does not merely displace intermediates from the association with chlorophyll (as one could suggest on the basis of scheme 7.VA).

C. EFFECT OF CARBOHYDRATES ON PHOTOSYNTHESIS *

Accumulated assimilation products have long been assumed to exercise an important influence on photosynthesis. As early as 1868, Boussingault suggested that this effect was responsible for the decline of photosynthesis in detached leaves. Sapozhnikov (1893) found that the photosynthesis of detached leaves of *Vitis vinifera* stops when the carbohydrate concentration had risen to 23-29% of the dry weight. Warburg (1919), Henrici (1921), Kursanov (1933), von Guttenberg and Buhr (1935), and Mönch (1937) were of the opinion that the accumulation of carbohydrates is at least partially responsible for the decline in photosynthesis after prolonged illumination, as well as for the so-called "mid-day depression" (Vol. II, Chapter 26). Kursanov (1933) made laboratory experiments with leaves and algae, some of which were starved while others were fed on 1% glucose solution in the dark. Upon illumination, starved leaves showed a higher rate of photosynthesis and a less pronounced midday minimum than the leaves supplied with sugar.

* Bibliography, page 348.

The inhibiting effect of carbohydrates can be explained either by the blocking of enzymes or "active surfaces" or by the diversion of light energy to photoxidative processes (*cf.* Chapter 19)—in short, either by an inhibition of photosynthesis, or by an acceleration of reverse reactions.

However, the view than an accumulation of carbohydrates invariably leads to a decrease in photosynthesis has not remained unchallenged. Boysen-Jensen and Müller (1928), Chesnokov and Bazyrina (1930) and Kjar (1937) asserted that there is no relation whatsoever between the concentration of carbohydrates in leaves and the rate of photosynthesis, especially insofar as the "midday depression" is concerned; Toshchevikova (1936) observed that an excess in carbohydrates may cause both an increase and a decrease in the rate of photosynthesis; and Spoehr and McGee (1923) asserted positively—in direct contradiction to Kursanov's conclusions—that plants starved in the dark for several hours are *less* efficient in photosynthesis than those fed on glucose during the dark period. Spoehr thought that the presence of carbohydrates accelerates respiration, and the latter in its turn stimulates photosynthesis. Van der Paauw (1932), who observed an increase in photosynthesis of *Hormidium* (to the extent of 5–12% in strong light and 50–100% in weak light) by the addition of 0.7–1% glucose to the nutrient solution, agreed with the Spoehr–McGee explanation, and saw in this effect an example of the "indirect regulation" of photosynthesis held so important by Kostychev (*cf.* Vol. II, Chapter 26). Van Hille (1938) grew *Chlorella* in glucose-free solutions, starved them in the dark for 12 hours and then subjected them to prolonged illumination. After 25 hours, the starch content and the rate of photosynthesis continued to increase steadily. Whether the increase in photosynthesis was a *consequence* of the carbohydrate accumulation is not clear, but there is certainly no evidence in these experiments that the accumulation of carbohydrates was *harmful* to photosynthesis. Gaffron (unpublished) found no difference between the photosynthesis of *Chlorella* in water and in 1% glucose (except under anaerobic conditions in which the presence of glucose accentuated the inhibition of photosynthesis after a period of dark anaerobiosis. According to the observations of Gaffron, sugar does not interfere with algal photosynthesis as long as it is utilized for growth; but if growth is inhibited, photosynthesis too, soon becomes affected. In this connection, the experiments of Brown and Escombe (1905) may also be recalled. They found that *detached leaves* of *Catalpa bignonioides* assimilate, in 4–5 hours, from 50–120% *more* carbon dioxide than similar leaves attached to the plants, despite the disrupted translocation of the carbohydrates. (Brown and Escombe ascribed this unexpected result to the wider opening of stomata in detached leaves.)

Obviously, several independent phenomena are involved in the effect of carbohydrates on photosynthesis. It depends on the species, light intensity, temperature, and other factors. The form in which the carbohydrates are accumulated must be of importance too—plants capable of “immobilizing” excess carbohydrates in the form of starch can be expected to be less affected than plants which produce only soluble sugars.

Because of the strong influence which the addition of sugars has on *respiration* and *fermentation*, their effect on *photosynthesis* is closely related to the coupling between these processes (as mentioned above in connection with the results of Spoehr, van der Paauw and Gaffron). We shall return to this problem in chapter 20, when dealing with the relation between photosynthesis and respiration.

D. INFLUENCE OF DEHYDRATION ON PHOTOSYNTHESIS *

Although water is a reactant in photosynthesis, the effect of water content on the rate of photosynthesis cannot be treated as a “concentration effect” according to the law of mass action, since water is present abundantly under all circumstances; the considerable influence exercised by the removal of even a small part of it must be caused by changes in the structure of the protoplasm (shrinking or swelling) rather than by direct effects on the kinetic mechanism of photosynthesis.

The water content of plant tissues can be changed either by drying or by immersion into solutions of high osmotic pressure. Observations on the effect of dehydration on photosynthesis were made, for example, by Iljin (1923), Dastur (1924, 1925), Brilliant (1924, 1925), Meyer and Plantefol (1926), Walter (1928, 1929), Wood (1929), Dastur and Desai (1933), Alexeev (1935), Danilov (1935, 1936, 1937, 1940), Chrelashvili (1940), and Brilliant and Chrelashvili (1941). As a rule, dehydration decreases the rate of photosynthesis. However, Brilliant (1924) has found that the photosynthesis of *Hedera helix* and *Impatiens parviflora* rises to a maximum at a water deficiency of 5 to 15% (and drops to almost zero at a deficiency of 41 to 63%). Similarly, Alexeev (1935) found that the photosynthesis of apple leaves has a maximum at 28% water deficiency; and analogous results were obtained by Chrelashvili (1940) with *Allium*, *Primula*, and *Zea mais*. Brilliant and Chrelashvili (1941) found that the stimulating effect of moderate dehydration can be observed only at high light intensities, while the inhibiting effect of strong dehydration is apparent in weak, as well as in intense, light.

Dastur (1924, 1925) suggested that a decreasing water supply is responsible for the loss in photosynthetic efficiency of aging leaves (an effect first described by Willstätter and Stoll). He found that the maximum rate of assimilation of different leaves of one

* Bibliography, page 348.

and the same species is proportional to their water content. Dastur and Desai (1933) observed that the relative photosynthetic efficiency of the species, *Abutilon asiaticum*, *Ricinus communis*, and *Helianthus annuus*, is proportional to the average water content of their leaves.

One mechanism by which water deficiency affects photosynthesis concerns the stomata. Kreuzler had shown, in 1885, that the stomata close in dry air. This indicates their primary function—regulation of transpiration. The enormous leaf surface, developed as a device to catch effectively both light and carbon dioxide, represents a danger as an overefficient evaporation system. The stomata keep the evaporation within reasonable limits, allowing at the same time for the gas exchange required for photosynthesis and respiration. The stomata close during the night, when no photosynthesis takes place, and are usually open during the day. However they also close in daytime when evaporation becomes too rapid (*cf.* Iljin 1923; Stålfelt 1927, 1929, 1932; and Scarth 1932). The closure of stomata, induced by water deficiency, was suggested by Iljin (1923) and Geiger (1927) as a possible cause of the "midday depression."

The operation of the stomata is based on equilibrium between starch and sugars in the "guard cells." In these cells, water deficiency leads to increased starch production (*cf.*, however, Spoehr and Milner 1940); the drop in sugar concentration causes a decrease of the turgor and a closure of the slits. This effect is reversible, unless desiccation has injured permanently the enzymatic mechanism of polymerization and depolymerization of starch. If such an injury has occurred, the leaves may recover their healthy aspect, but the response of the guard cells to changes in humidity is lost and many stomata remain permanently closed.

Stomata-free land plants (mosses, ferns, lichens) are much less sensitive to desiccation than are higher plants. According to Spoehr (1926), lichens and mosses can be dried to a powder and remain capable of resuming photosynthesis upon moistening. However, closure of the stomata is not the only way in which dehydration affects photosynthesis. This is proved by the effects of water deficiency on the photosynthesis of aquatic plants. Water can be extracted from these plants by increasing the osmotic pressure of the medium. To avoid complications, the solutes used for the adjustment of the osmotic pressure must not exercise specific inhibiting or stimulating effects on photosynthesis. Treboux (1903) found that the photosynthesis of algae decreases in an 0.1% solution of potassium nitrate, as well as in similarly concentrated solutions of other electrolytes, sucrose, and glycerol. Since the effects of isotonic solutions were similar, Treboux interpreted them as purely osmotic in origin. The inhibition was reversible, up to the point at which plasmolysis set in. Walter (1928, 1929) conducted experiments on *Elodea* in

sugar solutions: photosynthesis was found to decrease by 30% when the concentration of sucrose reached 0.35 m./l.; from there on, plasmolysis set in and the rate of photosynthesis decreased rapidly until a complete inhibition was reached in an 0.5 molar sucrose solution. Returned into pure water, the plants regained their capacity for photosynthesis only very slowly, even though no permanent effects of plasmolysis were visible. Greenfield's curve (Fig. 34, Curve 4) also shows the beginning of inhibition at 0.35 m./l. of sucrose, but a complete inhibition only at 0.9-1.0 m./l. Walter suggested that the osmotic inhibition of photosynthesis is the consequence of the shrinking of the protoplasm. Photosynthesis seems to be more sensitive to changes in the colloidal state of the protoplasm than are all other metabolic processes (*e. g.*, respiration).

Chrelashvili (1940) found that the removal of a certain proportion of water by osmotic methods may have an effect on photosynthesis which differs not only in magnitude, but sometimes even in sign, from that caused by an equivalent direct desiccation.

Greenfield (1941, 1942) noticed that osmotic effects can be observed only in strong light. This indicates that desiccation affects the efficiency of enzymatic reactions, and not the primary photochemical process. Danilov (1935, 1936, 1937, 1940) asserted that dehydration effects are different in light of different colors.

The effect of *heavy water* was discussed in chapter 11. We may repeat here that the carbon dioxide assimilation in pure heavy water is (in strong light) from 2-2.5 times slower than in ordinary water. This can be attributed to the slower rate with which deuterium oxide is transformed by photosynthesis, and is thus not an *inhibition* effect in the proper sense of this word. In mixtures of heavy and ordinary water, the rate of oxidation of H_2O is not affected by the presence of D_2O .

E. INORGANIC ELEMENTS AND IONS *

This is an extensive field which includes problems of plant nutrition and fertilization which cannot be discussed here. We are interested primarily in the *direct* effects of certain inorganic ions on the rate of photosynthesis. However, we must also mention some indirect effects, caused by ions whose deficiency affects the formation of chlorophyll (or other components of the photosynthetic mechanism). In contrast to direct (positive or negative) "catalytic" effects, indirect "deficiency effects" cannot be relieved *instantaneously* by a supply of the deficient element.

In addition to distinguishing between *direct* and *indirect* effects, we may classify the ions according to the *order of magnitude* of concentrations which are required to produce a marked change in photosynthesis. Ions which inhibit photosynthesis in concentrations of 0.01 m./l. or less

* Bibliography, page 349.

(e. g., Cu^{++} on Hg^{++}) may be considered as true poisons. Other ions become active in concentrations of the order of 0.01–0.1 m./l.; while the remainder act only above 0.1 m./l. The latter can be considered as indifferent; they affect photosynthesis only by changing the osmotic pressure (as described in the preceding section).

Even more than in the case of typical enzyme poisons, the sensitivity of individual plants to inorganic ions is a question of (phylogenetic and sometimes even ontogenetic) adaptation. The behavior of salt-water algae is different from that of soft-water algae, while algae living in mineral springs probably are adapted to the specific composition of their natural media.

Fromageot (1923) studied the influence of salt concentration on the photosynthesis of marine algae. The highest rate was observed in natural sea water; deviations in salinity in either direction caused a decline in photosynthesis. The algae retained a certain capacity for photosynthesis even in distilled water, but this was very weak; respiration, on the other hand, proved to be indifferent to changes in salinity.

Considering the variety of "salt effects" in photosynthesis, it is obviously impossible to give a common explanation for all of them. Some ions affect only photosynthesis in strong light, *i. e.*, they influence the enzymatic mechanism of photosynthesis; while others reduce or stimulate photosynthesis under all conditions. This is true, according to Briggs (1922), of a deficiency in potassium, phosphorus, magnesium, and iron; and according to Greenfield (1941, 1942), of an excess of copper sulfate, cobaltous sulfate, potassium iodide, boric acid, and ammonium sulfate.

Pirson (1937, 1938, 1940) and Greenfield (1941, 1942) have discussed the mechanisms by which ions may affect photosynthesis, in particular their relation to the colloidal properties of the protoplasm. Ustenko (1941) considered the influence of salts on the disposal of the carbohydrates as a possible cause of their effect on the rate of photosynthesis.

1. Ionic Deficiency Effects

(a) *Potassium*

Potassium is one of the elements whose deficiency often affects the plants; one of the consequences of this deficiency is *chlorosis* (insufficient development of chlorophyll) and therefore a depressed rate of photosynthesis. It seems, however, that in addition to this indirect effect, potassium has also a *direct* effect on photosynthesis, since an addition of this element to the medium may cause an *immediate* increase in the rate of photosynthesis.

The importance of potassium for photosynthesis was first stressed by Stoklasa and coworkers (1916, 1917, 1920, 1929), who pointed out that potassium fertilization is particularly beneficial to sugar-producing plants; they also noticed an accumulation of potassium in chlorophyllous tissues. (However, according to table 14.VI, potassium does not accumulate within the chloroplasts, but is more abundant in the cytoplasm.)

Stoklasa made the fantastic suggestion that the radioactivity of potassium may contribute its energy to photosynthesis; even stranger was the idea of Jacob (1928) that the primary effect of light in photosynthesis may be a photoelectric liberation of electrons from potassium!

Briggs (1922) found that a deficiency in potassium affects photosynthesis in the carbon dioxide-limited, as well as in the light-limited and in the light-saturated, state. That the effect of potassium on photosynthesis goes beyond the improvement attributable to an increase in chlorophyll concentration was shown by Gassner and Goeze (1934), and confirmed by Eckstein (1939) and Tiedjens and Wall (1939). According to Müller and Larsen (1935), the photosynthesis of *Sinapis alba* is doubled concurrent with an increase of potassium concentration in the leaves from 1.1 to 3.8 mg. per 50 cm.²; this change cannot be attributed to an increase of chlorophyll content.

Pirson (1937, 1938, 1940) found that supplying potassium to *Chlorella* cells grown in a potassium-deficient medium causes an *instantaneous* increase in the rate of photosynthesis (both in weak and in strong light). In this direct action—which Pirson attributed to changes in the colloidal structure of the protoplasm, potassium can be replaced by *rubidium*, and (less efficiently) by *cesium*. In the delayed, secondary effect of potassium on photosynthesis, which is associated with an increase in chlorophyll concentration, no replacement by cesium is possible, and even rubidium proves to be a poor substitute. Improvement in photosynthesis with increased supply of potassium continues only up to a certain concentration (Gassner and Goeze 1934, Brilliant 1936, and Alten and Goeze 1937). This limit is higher if the supply of nitrogen is abundant; when the nitrogen supply is low, an increase in potassium concentration may cause a *decline* instead of a rise in photosynthesis. Inversely, an abundant supply of nitrogen can become detrimental to photosynthesis if the supply of potassium is low (*cf.* Gassner and Goeze 1934; Rohde 1936^{1,2}; Maiwald and Frank 1935; and Alten and Goeze 1937).

(b) *Magnesium*

Magnesium is a component of chlorophyll; it is therefore natural that plants grown without magnesium are chlorotic and incapable of photosynthesis (*cf.* page 428). Briggs (1922) observed that magnesium deficiency depresses photosynthesis in the light-limited and in the light-saturated state, as well as in the carbon dioxide-limited state. Fleischer (1935) found that changes in magnesium concentration affect the chlorophyll concentration of *Chlorella* in a range in which they have only a slight effect on the rate of photosynthesis, and alter the rate of photosynthesis in the concentration range in which the quantity of chlorophyll remains practically constant, thus indicating that the two effects are

independent of each other. This conclusion was contradicted by van Hille (1937), but was confirmed by Kennedy (1940), who found that the low yields of photosynthesis, observed in magnesium-deficient media when the chlorophyll content is close to normal, can be improved by the use of flashing light with comparatively long intervals between the flashes. Thus, with intervals of approximately 0.02 sec., the yield per flash was about twice as large in a culture grown with abundant magnesium supply than in one grown with only 1 mg. magnesium per liter; when the dark intervals were increased to 0.4 sec., the yield per flash was only insignificantly smaller in the magnesium-deficient solution. This result is similar to that observed in cyanide-poisoned algae (*cf.* Vol. II, Chapter 34), and indicates that magnesium deficiency affects the rate of a dark reaction in photosynthesis.

(c) *Iron*

The deprivation of *iron* is the best known way to produce *chlorotic* plants (*cf.* Chapter 15, page 428). Briggs (1922) observed that iron-deficient plants show a depressed photosynthetic activity in the light-limited, light-saturated, and carbon dioxide-limited states.

Emerson (1929) and Fleischer (1935) found that the maximum photosynthesis of *Chlorella* cells which became chlorotic by growth in iron-deficient solutions was proportional to their chlorophyll content, and interpreted this as a proof of the absence of a *direct* effect of iron on photosynthesis. Kennedy (1940) quoted, in support of this view, the observation that iron-starved, chlorotic leaves show no increase in oxygen yield per light flash with increased dark intervals between the flashes—as was observed in the case of magnesium deficiency. On the other hand, Willstätter and Stoll (1918) found that the photosynthesis of iron-deficient, chlorotic leaves was even lower than one would expect from their content of chlorophyll, and assumed that iron deficiency influences photosynthesis directly, and not merely through its effect on chlorophyll concentration. This discrepancy with the results of Emerson and Fleischer will be discussed in more detail in chapter 32 (Vol. II). It seems probable that, in varying the concentration of chlorophyll by limiting the supply of iron, one varies also the concentration of other enzymatic components of the photosynthetic mechanism.

(d) *Manganese*

The importance of manganese for photosynthesis has been suspected by McHargue (1922) and Bishop (1928). According to Pirson (1937), the photosynthesis of manganese-starved *Chlorella* cells is inhibited despite the absence of visible chlorosis; this inhibition can be relieved instantaneously by the addition of manganese to the medium. Emerson

and Lewis (1940) observed that manganese deficiency affects the maximum quantum yield of photosynthesis in weak light. The effect of manganese (similarly to that of nitrate) depends on the available supply of potassium—the more potassium, the higher the quantity of manganese required to bring about the full rate of photosynthesis.

(e) *Nitrate and Phosphate*

In addition to the investigations mentioned on page 337 on the interrelation of the effects of nitrogen and potassium, we may quote the observations of Müller (1932), Hermer (1936), and Pirson (1937) on the importance of an adequate nitrogen supply for photosynthesis. According to Müller, a reduction in nitrogen supply (from 1 g. to 0.05 g. calcium nitrate per liter) leaves photosynthesis in weak light unaffected, but reduces the rate in strong light by almost 50%. Emerson (1929) and Fleischer (1935) found that the capacity for photosynthesis of *Chlorella* cells made chlorotic by nitrate deficiency was proportional to their content of chlorophyll, and concluded that nitrate has no effect on photosynthesis except through the medium of chlorophyll; this conclusion is open to the same objections as mentioned in the preceding discussion of the effects of iron deficiency. According to Müller and Larsen (1935) the rate of photosynthesis of *Sinapis alba* at 15,000 lux was twice as large when the content of nitrogen in the leaves was 7 mg. per 50 cm.² than when it was 3.5 mg. per 50 cm.²; this difference was not caused by a different content of chlorophyll. The existence of a nitrate effect on photosynthesis which is *not* dependent on chlorophyll was confirmed by Pirson (1937), who found that the addition of this anion to a nitrate-deficient medium causes an immediate rise in the rate of photosynthesis. Van Hille (1938) observed that "aging" *Chlorella* suspensions which have lost much of their efficiency in photosynthesis despite an unchanged content of chlorophyll, can be "rejuvenated" by a renewed supply of nitrogen.

The inhibition of photosynthesis by phosphorus deficiency has been observed, for example by Briggs (1922).

2. Ionic Inhibition Effects

As mentioned on page 000, many inorganic ions inhibit photosynthesis, some in very low, others only in comparatively high, concentrations. Even the ions whose deficiency retards photosynthesis may become inhibitors if present in excess.

(a) *Hydrogen and Hydroxyl Ions*

The photosynthesis of algae is not particularly sensitive to changes in the acidity of the medium, but experiments in carbonate buffers have

revealed a certain damaging effect of hydroxyl ions. Wilmott (1921) found that the photosynthesis of *Elodea* is not affected by the substitution of a bicarbonate solution ($pH \simeq 9$) for a carbonic acid solution ($pH \simeq 6$) (assuming that the concentration of the molecular species CO_2 remains the same). Emerson and Green (1938) stated that the photosynthesis of *Chlorella* is independent of pH in phosphate buffers (pH 4.6–8.9) and probably also in the moderately alkaline carbonate buffers; but carbonate-bicarbonate buffers of higher alkalinity affect the photosynthesis even in this very resistant organism (*cf.* also Matusima 1939). Some other unicellular algae, *e. g.*, *Hormidium* (van der Paauw 1932), are injured by all alkaline buffers.

Treboux (1903) observed a *stimulation* of photosynthesis in the aquatic higher plants by dilute *acids*; but this probably was caused by an improved supply of carbon dioxide (*cf.* page 343) and not by the hydrogen ions as such.

(b) Alkali Ions

Some data in the literature suggest a specific inhibiting influence of *ammonium ions* in photosynthesis. Ewart (1896) found, and Willstätter and Stoll (1918) confirmed the fact, that the rate of photosynthesis in ammonium bicarbonate solutions is lower than in equivalent solutions of other bicarbonates. Benecke (1921) observed that ammonium salts in concentrations as low as 0.01% reduce the formation of starch and the evolution of oxygen by *Elodea*. This was confirmed by Græenfield (1941), who found that ammonium ions inhibit photosynthesis both in strong light and in weak light (*cf.* page 336). An unfavorable effect of *sodium ions* on photosynthesis was noticed by Pirson (1937). According to Pratt (1943) the rate of photosynthesis of *Chlorella* declines by 60% after 24 hours in a 0.1 molar solution of sodium bicarbonate, as compared with an increase by 25–30% in an equivalent potassium bicarbonate solution. In a mixture of 0.035 m./l. $KHCO_3$ and 0.065 m./l. $NaHCO_3$, the rate remains constant for 15 hours.

(c) Heavy Metal Ions

Greenfield (1941, 1942) bathed *Chlorella* cells in different salt solutions for 20 minutes, washed them out, and studied their photosynthesis by manometric methods in light of five different intensities. Copper sulfate proved to be toxic even in concentrations as low as 10^{-7} m./l., mercuric chloride in concentrations of 2×10^{-5} m./l., and cobaltous sulfate in concentrations of 10^{-4} m./l., (*cf.* Fig. 34, Curve 1), whereas 0.1 m./l. of manganous sulfate had no perceptible effect (Fig. 34, Curve 6). Higher concentrations of the "nontoxic" salts also caused inhibition, but this could be attributed to nonspecific osmotic effects, since it occurred in the

same region (osmotic pressure of about 15 atm.) in which photosynthesis was inhibited by sucrose (cf. page 334 and Fig. 34, Curve 6). Zinc sulfate and nickel sulfate produced inhibition at concentrations of the order of 0.1 m./l., that is, somewhat before it should occur if it were purely osmotic in origin (Fig. 34, Curve 2). Zinc sulfate and nickel

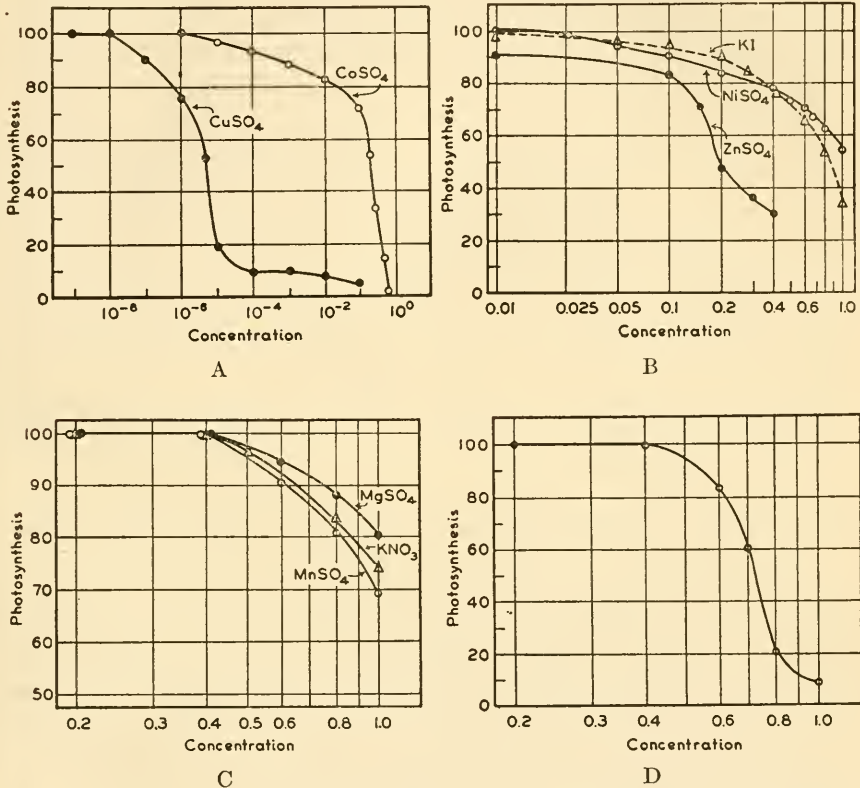

FIG. 34.—Inhibition of photosynthesis of *Chlorella* by different ions and by sucrose (22,000 lux) (after Greenfield 1942). A, specific poisons; B, weak inhibitors; C and D, osmotic effects. (C, indifferent salts; D, sucrose in buffer.)

sulfate inhibited the dark reaction only; whereas cupric and cobaltous sulfates reduced the oxygen production in strong, as well as in weak, light (cf. Fig. 35).

(d) Anions

Greenfield (1941, 1942) observed the inhibiting effect of *iodides* and *borates* on the photosynthesis of *Chlorella*; it occurred only in strong light. He also noticed that 0.1 m./l. potassium *chloride* inhibits photo-

synthesis, while an equal concentration of potassium *nitrate* has no effect at all.

F. MISCELLANEOUS CHEMICAL STIMULANTS *

Numerous data on the stimulation of photosynthesis by chemicals can be found in the literature, but most are based on occasional observations under conditions which are not well defined. In the preceding sections, while dealing with the inhibition phenomena we found that the action of a number of "poisons" can be attributed to their interaction

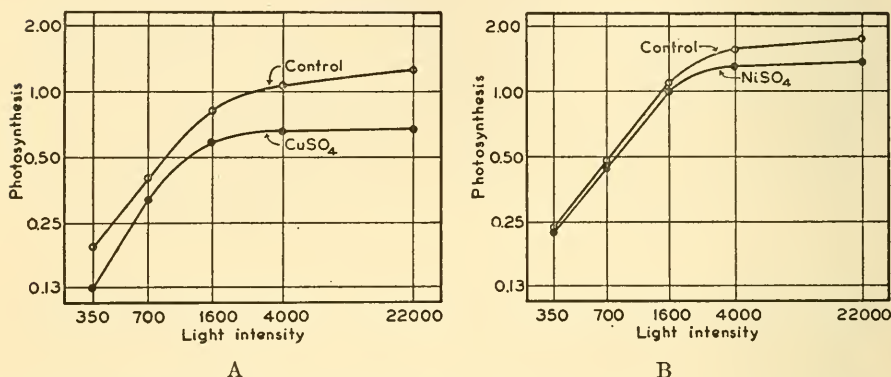

FIG. 35.—Effect of ions on photosynthesis in weak and strong light (after Greenfield 1942). A, inhibition at all intensities; B, inhibition in strong light only.

with specific components of the photosynthetic apparatus. So far, no such specific agents have been identified in the reverse case—that of the *acceleration* of photosynthesis. Here, we still must be content with the vague notion of "protoplasmic stimulation." Gaffron (1939) suggested that stimulation of photosynthesis may be caused by an *inhibition of back reactions* (meaning, not ordinary respiration, but oxidation processes in the chloroplasts which are postulated in certain kinetic theories—*cf.* Vol. II, Chapter 33—and represent a direct reversal of photosynthesis).

From the data presented in chapter 12, it appears as though almost any inhibitor becomes a stimulant if used in sufficiently low concentration. This is true, for example, of hydrocyanic acid, iodoacetic acid, sulfur dioxide, hydrogen sulfide, ether, and urethan. Among alleged stimulants of photosynthesis which are not known as inhibitors we may mention *acetaldehyde*. Sabalitschka and Weidling (1926) found that the rate of oxygen liberation by *Elodea canadensis* is doubled by 0.001–0.128% of aldehyde. However, Schmucker (1928) failed to confirm this result in experiments with *Cabomba caroliniana*.

* Bibliography, page 350.

A large variety of stimulation effects caused by almost infinitesimal quantities of different chemical agents was described by Bose (1923, 1924). His investigation originated in a casual observation: The rate of photosynthesis of certain water plants was observed to increase sharply during a thunderstorm. Bose attributed this phenomenon to the oxides of nitrogen produced by electric discharges in the atmosphere; this conclusion induced him to investigate the effects on photosynthesis of various stimulants. He found that the photosynthesis of *Hydrilla verticillata* was trebled by approximately $5 \times 10^{-8}\%$ of *nitric acid* and doubled by $10^{-6}\%$ of a *thyroid gland extract*. *Iodine* ($10^{-7}\%$) caused a rate increase by 60%, and *formaldehyde* ($10^{-7}\%$), by 80%. These curious results certainly are in need of confirmation and elaboration.

Kholodny and Gorbovsky (1939, 1941) observed that the rate of photosynthesis of *Hydrangea* and hemp is temporarily doubled by 0.1% of β -indoleacetic acid (this compound—the so-called “heteroauxin”—is an “artificial growth hormone”).

Bukatsch (1939) described a similar stimulation of photosynthesis by *ascorbic acid*. (It was mentioned on page 273 that ascorbic acid may play a part in photosynthesis; Bukatsch's experiments were intended to test this hypothesis.)

Treboux (1903) observed a strong stimulation of photosynthesis of aquatic plants by dilute (*e. g.*, 10^{-4} normal) acids. However, Wilmott (1921), while confirming the experimental results of Treboux, found the interpretation to be erroneous. The increase in photosynthesis was caused, not by stimulation, but by the dissolution of incrustations of solid carbonate which often occur in plants grown in hard water, and by the consequent increase in the supply of carbon dioxide. No “stimulation” could be observed if plants were grown in soft water; even in hard water the effect disappeared if the supply of external carbon dioxide was made ample.

The effect of *mechanical injury* on photosynthesis also must be mentioned in this chapter, because it is probably due to the internal production of stimulating chemical agents or “wound hormones.” The effect of wounding was first investigated by Kostychev (1921), who was unable to find any stimulation; to the contrary, leaves of *Betula pubescens*, shredded by a needle, showed a somewhat reduced rate of photosynthesis. Lubimenko and Sheheglova (1933) attributed Kostychev's result to a loss of active leaf surface, and repeated his experiments (with leaves of wheat and barley) by punching holes of known area and comparing photosynthesis *per unit surface* of wounded and intact leaves. They found a marked stimulation which, however, became apparent only two or three days after the injury. The authors attributed this “induction period” to the water loss caused by wounding. After the

wounds healed, stimulation gained over inhibition, and remained noticeable for several weeks. If the perimeter of the wounds was too large, the stimulating effect was pronounced even in the first two of three days; but after this the photosynthesis sank rapidly below the normal level. The wave of photosynthesis after injury ran parallel with a wave of respiration. Lubimenko considered this as a demonstration of the dependence of both processes on "protoplasmic stimulation," and thus as an argument in favor of Kostychev's theory of protoplasmic control of the photosynthetic apparatus (*cf.* Vol. II, Chapter 26).

G. PHYSICAL STIMULANTS AND INHIBITORS *

1. Ultraviolet Light

The absorption bands of chlorophyll extend into the ultraviolet as far as the absorption has been investigated—*i. e.*, down to 220 $m\mu$ (*cf.* Vol. II, Chapter 21). However, many other components of the cells also absorb strongly in the ultraviolet—particularly below 300 $m\mu$; and this absorption often is injurious to the organism as a whole, and also destroys its capacity for photosynthesis. What one would like to know is whether the ultraviolet light absorbed by chlorophyll (or by the carotenoids) also has this destructive effect, or whether it can be utilized for photosynthesis in the same way as blue and violet light (*i. e.*, in all probability, by an immediate conversion of the excessively large quanta into the smaller quanta of red light, and dissipation of the residual energy as heat, *cf.* the discussion in Vol. II, Chapter 21). This question cannot be answered without a quantitative analysis of the cell absorption in the ultraviolet, and apportionment of the absorbed energy between the several absorbing agents—a method whose application to visible light will be described in chapter 22 (Vol. II). At present, we possess only scattered data concerning oxygen liberation and starch formation in ultraviolet light. More systematic information is available concerning the lethal action of ultraviolet light on plants—but without an identification of the compounds whose absorption is responsible for the injury.

Photosynthesis, *i. e.*, oxygen liberation and consumption of carbon dioxide, undoubtedly still proceeds briskly in the near ultraviolet (*cf.*, for example, Gessner 1938). Starch formation was observed down to 300 $m\mu$ by Ursprung and Blum (1917), and below 300 $m\mu$ by Richter (1932, 1935). In the latter case, however, the formation of starch appeared to be a delayed consequence of light stimulation, rather than a direct result of increased photosynthesis. (A short exposure to very intense ultraviolet light caused an increased production of starch in the dark for hours afterwards.)

* Bibliography, page 350.

There is no doubt that in the spectral region used by Richter ($<300\text{ m}\mu$) any but a very short exposure is fatal to the organism in general and to the photosynthetic apparatus in particular.

Meier (1936) has studied the action of ultraviolet rays of different wave length and intensity on *Chlorella*, and constructed spectral toxicity curves, in which the duration of exposure required for the lethal effect (at an intensity of $1000\text{ erg/cm.}^2\text{/sec.}$) was plotted against wave length. At $302\text{ m}\mu$, this duration was of the order of 10^4 sec. ; it decreased very rapidly below $300\text{ m}\mu$, and reached a minimum (110 sec.) at $260\text{ m}\mu$. At still shorter waves, the effect became somewhat weaker, with a secondary peak around $240\text{ m}\mu$.

Killing the cells by ultraviolet light of course means complete cessation of photosynthesis, even if the location of the primary attack is not in the photosynthetic apparatus proper. An indication that ultraviolet light ($\lambda = 236\text{ m}\mu$) does attack a colorless component of this apparatus (either directly, or through chlorophyll as sensitizer) can be seen in the experiments of Arnold (1933). He irradiated *Chlorella pyrenoidosa* suspensions with the light from a low-voltage mercury arc consisting mainly of the resonance line $253.6\text{ m}\mu$. Figure 36 shows the decrease in the rate of photosynthesis of irradiated cells with time, and also the comparative indifference of the respiratory system to this irradiation. The abscissae are logarithms of the maximum rates of photosynthesis after exposure to ultraviolet light relative to the rate prior to inhibition. Arnold interpreted this ratio as the proportion of "reduction centers" (enzyme molecules?) which have survived irradiation.

The linear decrease in $\log(N/N_0)$ with time shows that the rate of deactivation is proportional to the number of surviving "centers" (as in a radioactive decay process); this indicates that deactivation is achieved by a single absorption act, and does not require a cumulative effect of several quanta. Arnold determined the absorption of ultraviolet light by the irradiated suspension, and calculated that complete deactivation requires the absorption of about six quanta for each chlorophyll molecule in the suspension. This figure—which does not claim any precision beyond that of the order of magnitude—indicates that the number of

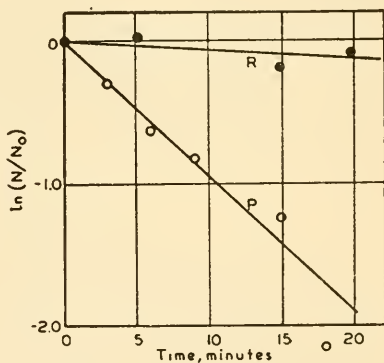

FIG. 36.—Effect of ultraviolet light on *Chlorella* (after Arnold 1934). R, respiration (no effect); P, photosynthesis (exponential decline of rate with time).

"reduction centers" is similar to that of the chlorophyll molecules. However, Arnold found that, even after prolonged irradiation and considerable deactivation, chlorophyll is still unbleached and apparently unchanged chemically. This reminds us of observations on the "CO₂ acceptor" described in chapter 8; both the radioactive indicator method (page 204) and the study of the "pickup" phenomenon (page 207) have indicated that this acceptor, although not identical with chlorophyll, is present in a concentration approximately equal to that of the green pigment. We may thus tentatively ascribe the sensitivity of photosynthesis to ultraviolet light to the destruction of the carbon dioxide acceptor. The observation of Ruben, Kamen, and Hassid (1940) that ultraviolet light ($\lambda = 253.6 \text{ m}\mu$) destroys the capacity of *Chlorella* cells for taking up radioactive carbon dioxide in the dark fits well into this picture.

In a second paper, Arnold compared the effects of ultraviolet radiations on the rates of photosynthesis in continuous and flashing light, and found that both are reduced in the same proportion. The bearing of this result on the theory of the kinetic mechanism of photosynthesis will be discussed in volume II, chapter 34.

2. Electric Fields and Currents

Some rather unreliable information has been gathered on the effect of *electric currents and potentials* on photosynthesis. Thouvenin (1896) claimed that the passage of direct current through *Elodea* stimulates photosynthesis. Pollacci (1905, 1907) and Koltonski (1908) observed that the effect depends on the direction of the current, stimulation occurring when the apex of the shoot was positive and inhibition when it was negative. Chouchak (1929) asserted that corn leaves assimilated more carbon dioxide than ordinarily when they were positively charged, and less when the charge was negative. Gorski (1931) found that, if *Elodea* sprigs are made to assimilate in water through which a direct current (0.2–0.8 ma./cm.²) is passed, no change in the rate of oxygen evolution could be observed in 0.5% potassium acid carbonate, calcium nitrate, potassium chloride, magnesium sulfate, or sodium dihydrogen phosphate solutions, but a slight increase in rate occurred in an ammonium sulfate solution.

3. Radioactive Rays

Henrici (1921) noticed the effect of radioactive radiations on the rate of photosynthesis. In her experiments, the plants were protected from the direct action of the rays so that the effect had to be ascribed to the ionization of the air. In weak light, ionization sometimes increased the rate of photosynthesis by as much as a factor of 4; the effect disappeared

in strong light or in presence of abundant carbon dioxide. Alpine plants continued to show stimulation at higher light intensities than plants from the plains. Schiller (1937) observed that *Spirogyra* produced more starch in radioactive water of Gastein springs than in a nonradioactive medium.

Stoklasa, Hruban, and Penkava (1930) found that alpha rays inhibit photosynthesis, beta rays inhibit it at first and stimulate it upon prolonged irradiation, and gamma rays stimulate photosynthesis and retard respiration.

The strange hypothesis of Stoklasa that potassium affects photosynthesis by its radiation was mentioned on page 337.

Nisina, Nakamura, and Nakayama (1940) observed the reduction in photosynthesis by about 50% in *Chlorella ellipsoidea* after three hours of irradiation with neutrons from a beryllium source. With *Scenedesmus nanus*, no effect was observed after 10 min., a stimulation of a few per cent after 30 min., and an inhibition of - 37% after two hours, while respiration was unaffected even after three hours of irradiation.

Bibliography to Chapter 13

Inhibitors and Stimulants

A. Effect of Oxygen in Photosynthesis

- 1865 Boussingault, J. B., *Compt. rend.*, **61**, 493, 605, 657.
- 1887 Pringsheim, N., *Sitzber. preuss. Akad. Wiss. Physik-math. Klasse*, **1887**, 763.
- 1918 Willstätter, R., and Stoll, A., *Untersuchungen über die Assimilation der Kohlensäure*. Springer, Berlin, 1918.
- 1920 Warburg, O., *Biochem. Z.*, **103**, 188.
- 1928 Harvey, E. N., *Plant Physiol.*, **3**, 85.
- 1931 Kautsky, H., *Naturwissenschaften*, **19**, 964.
- 1933 Willstätter, R., *ibid.*, **21**, 252.
Gaffron, H., *Biochem. Z.*, **260**, 1.
Briggs, G. E., *Proc. Roy. Soc. London B*, **113**, 1.
- 1935 Gaffron, H., *Biochem. Z.*, **280**, 337.
Franck, J., *Chem. Revs.*, **17**, 433.
- 1938 Wassink, E. C., Vermeulen, D., Reman, G. H., and Katz, E., *Enzymologia*, **5**, 100.
- 1939 Noack, K., Pirson, A., and Michels, H., *Naturwissenschaften*, **27**, 645.
Kautsky, H., and Eberlein, R., *Biochem. Z.*, **302**, 137.
- 1940 Gaffron, H., *Am. J. Botany*, **27**, 273.
Michels, H., *Z. Botan.*, **35**, 241.
Myers, J., and Burr, G. O., *J. Gen. Physiol.*, **24**, 45.
McAlister, E. D., and Myers, J., *Smithsonian Inst. Pub. Misc. Collections*, **99**, No. 6.
- 1941 Franck, J., and French, C. S., *J. Gen. Physiol.*, **25**, 309.

B. The Influence of Excess Carbon Dioxide

- 1804 de Saussure, T., *Recherches chimiques sur la végétation*. Nyon, Paris, 1804.
- 1868 Boussingault, J. B., *Agronomie, chimie agricole et physiologie*. Vol. IV, Mallet-Buchelier, Paris, 1868.
- 1873 Böhm, J., *Sitzber. Akad. Wiss. Wien Math.-naturw. Klasse*, **67**, I, 219.
- 1896 Ewart, A. J., *J. Linnean Soc. Botany*, **31**, 364.
- 1902 Chapin, P., *Flora*, **91**, 348.
- 1911 Blackman, F. F., and Smith, A. M., *Proc. Roy. Soc. London B*, **83**, 389.
- 1924 Chapman, R. E., Cook, W. R. I., and Thompson, N. L., *New Phytologist*, **23**, 50.
- 1932 Jaccard, D., and Jaag, O., *Ber. deut. botan. Ges.*, **50**, 167.
- 1935 Singh, B. N., and Kumar, K., *Proc. Indian Acad. Sci.*, **1B**, 909.
- 1939 Spoehr, H. A., *Proc. Am. Phil. Soc.*, **81**, 37.
- 1940 Livingston, R., and Franck, J., *Am. J. Botany*, **27**, 449.
- 1941 Ballard, L. A. T., *New Phytologist*, **40**, 276.

C. The Influence of Carbohydrates

- 1868 Boussingault, J. B., *Agronomie, chimie et agricole et physiologie*. Vol. IV, Mallet-Buchelier, Paris, 1868, pp. 286 and 312.
- 1893 Sapozhnikov, V., *Ber. deut. botan. Ges.*, **11**, 391.
- 1905 Brown, H. T., and Escombe, F., *Proc. Roy. Soc. London B*, **76**, 29.
- 1919 Warburg, O., *Biochem. Z.*, **100**, 230.
- 1921 Henrici, M., *Verhandl. Naturforsch. Ges. Basel*, **30**, 43.
- 1923 Spoehr, H. A., and McGee, J. M., *Carnegie Inst. Wash. Pub.*, No. 325.
- 1928 Boysen-Jensen, P., and Müller, D., *Jahrb. wiss. Botan.*, **70**, 493.
- 1930 Chesnokov, V. A., and Bazyrina, E. N., *Bull. acad. sci. USSR*, **1930**, 499.
- Chesnokov, V. A., and Bazyrina, E. N., *Planta*, **11**, 473.
- 1932 van der Paauw, F., *Rec. trav. botan. néerland.*, **29**, 497.
- 1933 Kursanov, A. L., *Planta*, **20**, 535.
- 1935 von Guttenberg, H., and Buhr, H., *ibid.*, **24**, 163.
- 1936 Toshchevikova, A. G., *Trudy Botan. Inst. Acad. Sci. USSR*, Ser. IV (Exptl. Botany), **2**, 13.
- 1937 Kjar, A., *Planta*, **26**, 595.
- Mönch, I., *Jahrb. wiss. Botan.*, **85**, 506.
- 1938 van Hille, J. C., *Rec. trav. botan. néerland.*, **35**, 680.

D. The Effect of Dehydration

- 1885 Kreuzler, U., *Landw. Jahrb.*, **14**, 913.
- 1903 Treboux, O., *Flora*, **92**, 53.
- 1923 Iljin, V. S., *ibid.*, **116**, 360.
- 1924 Brilliant, V. A., *Compt. rend.*, **178**, 2122.
- Dastur, R. H., *Ann. Botany*, **38**, 779.
- 1925 Dastur, R. H., *ibid.*, **39**, 769.
- Brilliant, V. A., *Ber. botan. Garten Leningrad*, **1**, 1.

- 1926 Spoehr, H. A., *Photosynthesis*. Chemical Catalog Co., New York, 1926, p. 155.
- Meyer, A., and Plantefol, L., *Ann. physiol. physicochim. biol.*, 2, 564.
- 1927 Geiger, M., *Jahrb. wiss. Botan.*, 67, 635.
- Stälfelt, M. G., *Flora*, 121, 236.
- 1928 Walter, H., *Ber. deut. botan. Ges.*, 46, 530.
- 1929 Walter, H., *Protoplasma*, 6, 113.
- Wood, J. G., *Australian J. Exptl. Biol. Med. Sci.*, 6, 127.
- Stälfelt, M. G., *Planta*, 8, 287.
- 1932 Stälfelt, M. G., *ibid.*, 17, 22.
- Scarth, G. W., *Plant Physiol.*, 7, 481.
- 1933 Dastur, R. H., and Desai, B. L., *Ann. Botany*, 47, 69.
- 1935 Alexeev, A. M., *J. Botany USSR*, 20, 227.
- Danilov, A. N., *Sovet. Botanika*, 1935, No. 4, p. 3.
- 1936 Danilov, A. N., *ibid.*, 1936, No. 2, p. 5.
- 1937 Danilov, A. N., *ibid.*, 1937, No. 3.
- 1939 Spoehr, H. A., and Milner, H. W., *Proc. Am. Phil. Soc.*, 81, 37.
- 1940 Danilov, A. N., *Sovet. Botanika*, 1940, No. 5/6, p. 28.
- Chrelashvili, M. N., *Comm. Georgian Branch Acad. Sci. USSR*, 1, 445.
- 1941 Brilliant, V. A., and Chrelashvili, M. N., *Trudy Botan. Inst. Acad. Sci. USSR*, Ser. IV (Exptl. Botany), 5, 88.
- Greenfield, S. S., *Science*, 93, 550.
- 1942 Greenfield, S. S., *Am. J. Botany*, 29, 121.

E. Effect of Inorganic Elements and Ions

- 1896 Ewart, A. J., *J. Linnean Soc., Botany*, 31, 364.
- 1903 Treboux, O., *Flora*, 92, 49.
- 1916 Stoklasa, J., and Matoušek, A., *Beiträge zur Kenntniss der Ernährung der Zuckerrübe*. Fischer, Jena, 1916.
- 1917 Stoklasa, J., *Biochem. Z.*, 82, 310.
- 1918 Willstätter, R., and Stoll, A., *Untersuchungen über die Assimilation der Kohlensäure*. Springer, Berlin, 1918.
- 1920 Stoklasa, J., *Biochem. Z.*, 108, 310.
- 1921 Benecke, W., *Z. Botan.*, 13, 417.
- Wilmott, A. J., *Proc. Roy. Soc. London B*, 92, 304.
- 1922 Briggs, G. E., *ibid.*, 94, 20.
- McHargue, J. S., *J. Am. Chem. Soc.*, 44, 1592.
- 1923 Fromageot, C., *Compt. rend.*, 177, 779, 892.
- 1928 Jacob, A., *Z. angew. Chem.*, 41, 298.
- Bishop, W. B. S., *Australian J. Exptl. Biol. Med. Sci.*, 5, 125.
- 1929 Stoklasa, J., Penkava, J., and Petrova, J., *Ernähr. Pflanze*, 25, 97.
- Emerson, R., *J. Gen. Physiol.*, 12, 609.
- 1932 Müller, D., *Planta*, 16, 1.
- van der Paauw, F., *Rec. trav. botan. néerland.*, 29, 497.
- 1934 Gassner, F., and Goeze, G., *Z. Pflanzenernähr. Düngung Bodenk.*, A36, 61.
- 1935 Maiwald, K., and Frank, A., *ibid.*, 41, 8.

- Müller, D., and Larsen, P., *Planta*, **23**, 501.
 Fleischer, W. E., *J. Gen. Physiol.*, **18**, 573.
- 1936 Brilliant, V. A., *Trudy Botan. Inst. Acad. Sci. USSR*, Ser. IV (Exptl. Botany), **2**.
 Hermer, K. C., *Botan. Gaz.*, **97**, 744.
 Rohde, G., *Z. Pflanzenernähr. Düngung Bodenk.*, **44**, 1, 247.
 Rohde, G., *ibid.*, **45**, 499.
- 1937 Alten, F., and Goeze, G., *Ernähr. Pflanze*, **33**, 21.
 Pirson, A., *Z. Botan.*, **31**, 193.
 van Hille, J. C., *Proc. Acad. Sci. Amsterdam*, **10**, 792.
- 1938 Emerson, R., and Green, L., *Plant Physiol.*, **13**, 157.
 van Hille, J. C., *Rec. trav. botan. néerland.*, **35**, 680.
 Pirson, A., *Planta*, **29**, 231.
- 1939 Matusima, S., *Botan. Mag. Tokyo*, **53**, 221.
 Eckstein, O., *Plant Physiol.*, **14**, 113.
 Tiedjens, V. A., and Wall, M. E., *Proc. Am. Soc. Hort.*, **36**, 740.
- 1940 Emerson, R., and Lewis, C. M., *Carnegie Inst. Yearbook*, **39**, 159.
 Pirson, A., *Ernähr. Pflanze*, **36**, 25.
 Kennedy, S., *Am. J. Botany*, **27**, 68.
- 1941 Ustenko, G. P., *Compt. rend. acad. sci. URSS*, **32**, 661.
 Greenfield, S. S., *Science*, **93**, 550.
- 1942 Greenfield, S. S., *Am. J. Botany*, **29**, 121.
- 1943 Pratt, R., *Am. J. Botany*, **30**, 626.

F. Miscellaneous Chemical Stimulants

- 1903 Treboux, O., *Flora*, **92**, 49.
- 1921 Wilmott, A. J., *Proc. Roy. Soc. London B*, **92**, 304.
 Kostychev, S. P., *Ber. deut. botan. Ges.*, **39**, 328.
- 1923 Bose, J. C., *Nature*, **112**, 95.
- 1924 Bose, J. C., *Physiology of Photosynthesis*. Longmans, Green, London, 1924.
- 1926 Sabalitschka, Th., and Weidling, H., *Biochem. Z.*, **176**, 210.
- 1928 Schmucker, Th., *ibid.*, **195**, 149.
- 1933 Lubimenko, V. N., and Shcheglova, O. A., *Planta*, **18**, 383.
- 1939 Bukatsch, F., *ibid.*, **30**, 118.
 Kholodny, N. G., and Gorbovskij, A. G., *Compt. rend. acad. sci. USSR*, **22**, 452.
 Kholodny, N. G., and Gorbovskij, A. G., *Science*, **90**, 41.
 Gaffron, H., *Biol. Zentr.*, **59**, 302.
- 1941 Kholodny, N. G., and Gorbovskij, A. G., *J. Inst. Botan. Acad. Sci. USSR*, **1941**, No. 21/2, p. 369.

G. Physical Inhibitors and Stimulants

- 1896 Thouvenin, M., *Rev. gén. botan.*, **8**, 433.
- 1905 Pollacci, G., *Rend. ist. lombardo sci.*, (2) **38**, 354.
 Pollacci, G., *Rend. ist. botan. R. Univ. Pavia*, **11**, 7.
- 1907 Pollacci, G., *ibid.*, **13**, 1.

- 1908 Koltonski, A., *Botan. Centr. Beihefte*, (1) **23**, 204.
1917 Ursprung, A., and Blum, G., *Ber. deut. botan. Ges.*, **35**, 385.
1921 Henrici, M., *Arch. sci. phys. nat.*, (5) **3**, 276.
1929 Chouchak, D., *Rev. gén. botan.*, **41**, 465.
1930 Stoklasa, J., Hruban, J., and Penkava, J., *Biochem. Z.*, **218**, 361.
1931 Gorski, F., *Bull. intern. acad. polon. sci. Classe sci. math. nat.*, **B I**, 85.
1932 Richter, O., *Denkschr. Akad. Wiss. Wien Math.-naturw. Klasse*, **103**,
165, 172.
1933 Arnold, W., *J. Gen. Physiol.*, **17**, 135, 145.
1935 Richter, O., *Sitzber. Akad. Wiss. Wien Math.-naturw. Klasse, Abt. I*,
144, 157.
1936 Meier, F. E., *Smithsonian Inst. Pub. Misc. Collections*, **95**, No. 2.
1937 Schiller, J., *Planta*, **27**, 159.
1938 Gessner, F., *Jahrb. wiss. Botan.*, **86**, 491.
1940 Ruben, S., Kamen, M. D., and Hassid, W. Z., *J. Am. Chem. Soc.*,
62, 3443.
Nisina, J., Nakamura, H., and Nakayama, H., *Bull. Inst. Phys. Chem. Research Tokyo*, **19**, 1343.

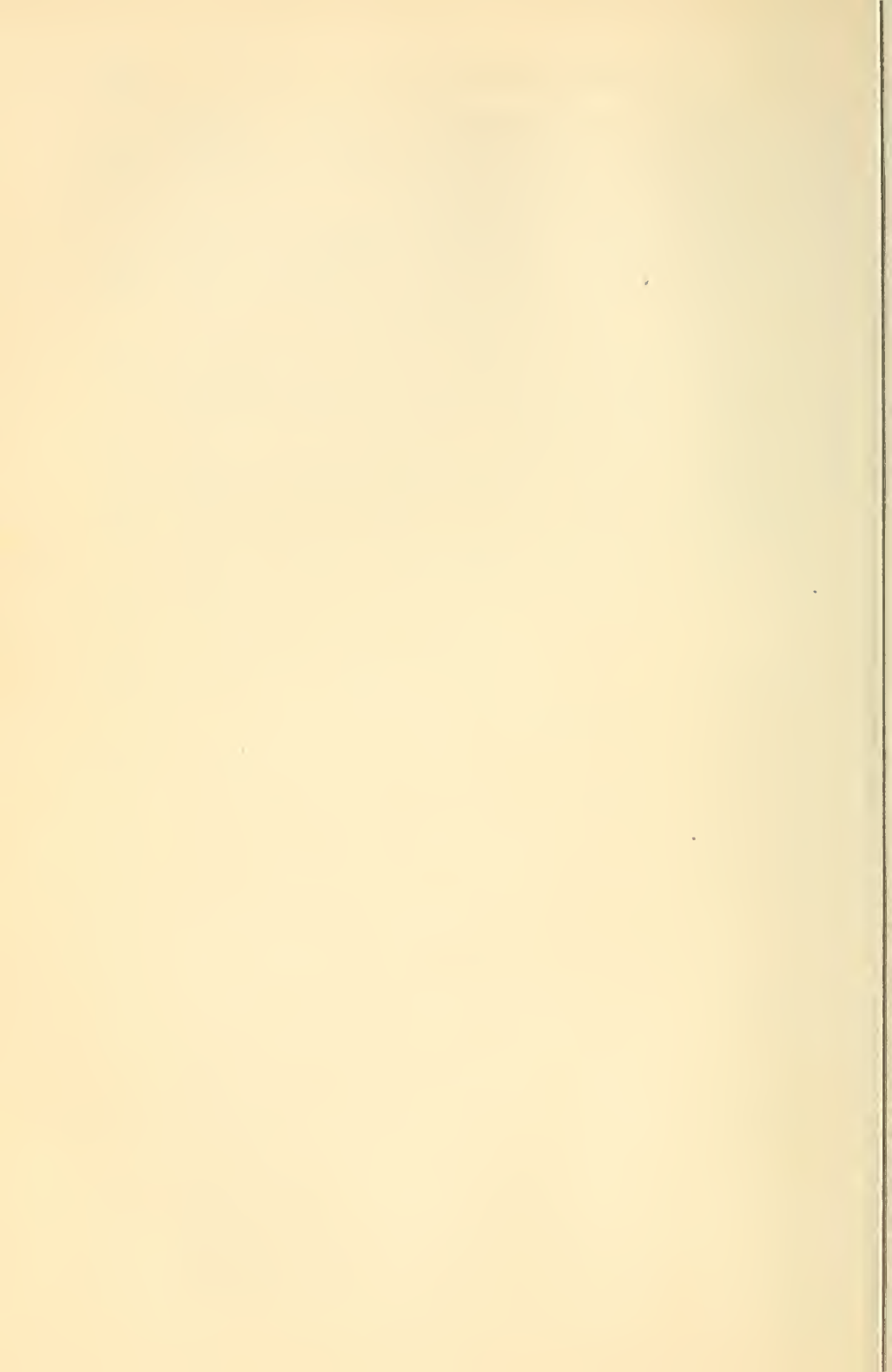

PART TWO

THE STRUCTURE AND CHEMISTRY OF THE
PHOTOSYNTHETIC APPARATUS

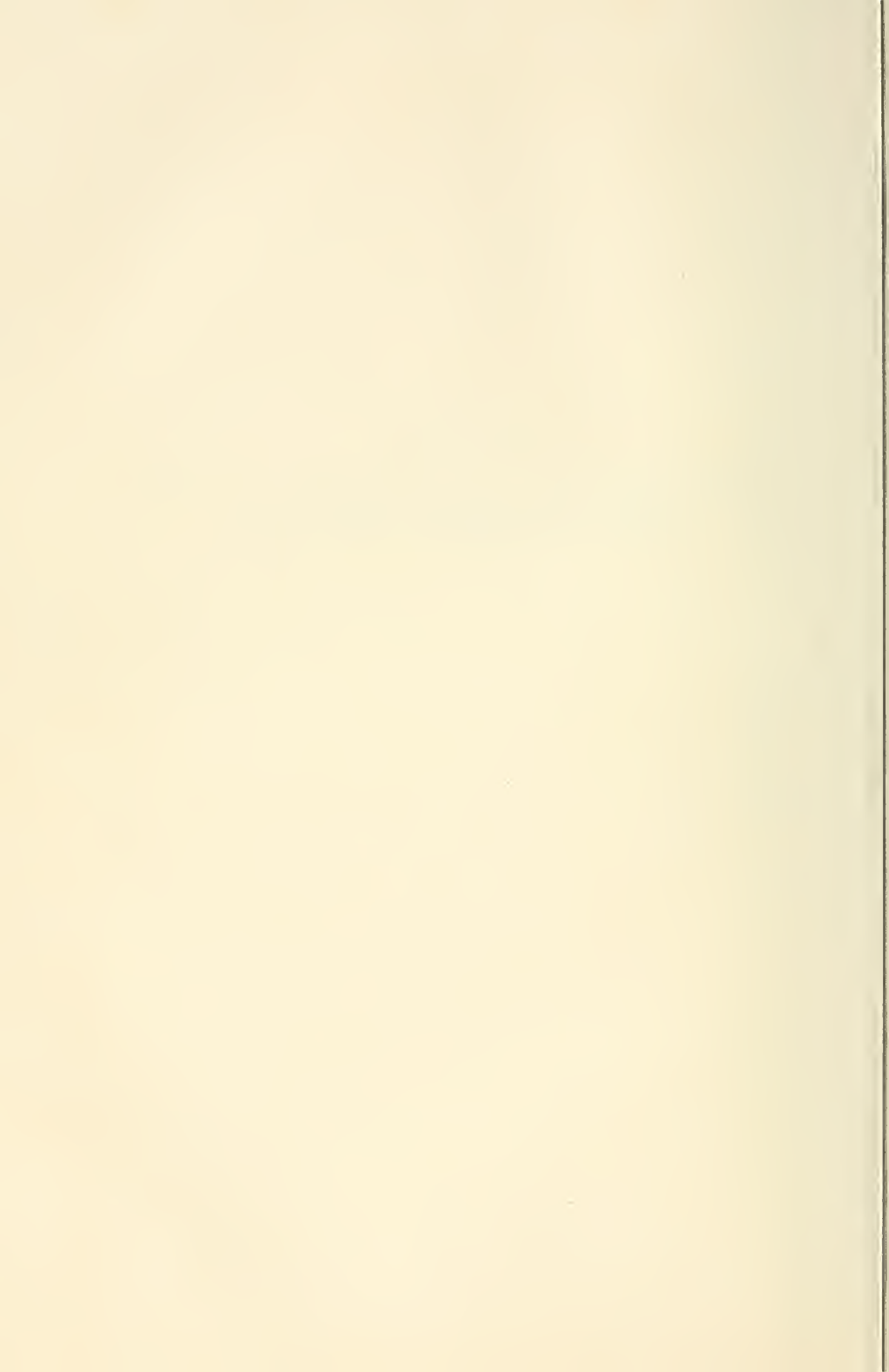

CHAPTER 14

THE CHLOROPLASTS AND CHROMOPLASTS

A. STRUCTURE OF THE CHLOROPLASTS *

1. Number, Size, and Shape

Chloroplasts are small green bodies enclosed in the cytoplasm of the higher plants and green algae. Together with the corresponding organs of red and brown algae, they are included in the more general term *chromoplasts*. Blue-green algae do not contain any chromoplasts at all, and the same is probably true of green and purple bacteria (*cf.* Metzner 1922).

The importance of chromoplasts for photosynthesis is indicated by the fact that all chlorophyll (as well as the other pigments related to photosynthesis—the carotenoids and phycobilins) are concentrated in them. (Only pigments of the blue-green algae are distributed more or less uniformly in the “chromatoplasm” of these primitive organisms.) Sachs asserted, in 1862, that the formation of starch grains inside the chloroplasts during photosynthesis proves that these bodies are the site of the photosynthetic process. Reinke (1883) remarked that this proof is not convincing, because chloroplasts can convert externally supplied sugars into starch as well (*cf.* page 47). He agreed, however, that the observation of Engelmann (1882, 1883) that oxygen-sensitive motile bacteria are attracted by the chloroplasts gives an indisputable proof of the production of oxygen in these bodies.

It has been generally accepted since the time of Engelmann and Reinke, that the reaction sequence of photosynthesis begins and ends in the chloroplasts, despite the occasional, rather vague discussion of a “protoplasmic factor” as a regulating influence in photosynthesis. However, the inability of isolated—even if apparently intact—chloroplasts to carry out photosynthesis (*cf.* Chapter 4, page 62) is an indication that this process requires the cooperation of the cytoplasm. Experiments of Frenkel, described on page 204, make it appear probable that the preliminary dark fixation of carbon dioxide may take place outside the chloroplasts. Hill’s observation (*cf.* page 63) that isolated chloro-

* Bibliography, page 394.

plasts can evolve oxygen from water in light, but are unable to use carbon dioxide as oxidant in this reaction, agrees well with this hypothesis.

The *chromoplasts of the algae* are of varied size and shape, *e. g.*, stars (Fig. 37c), bands (Fig. 37d), or discs (Fig. 37a and e); giants with

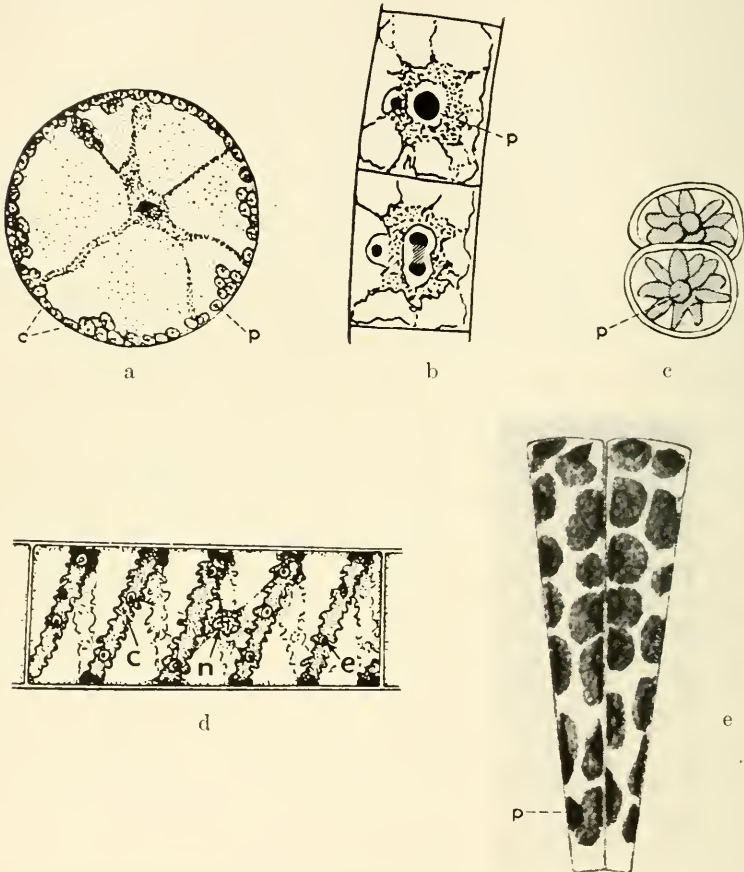

FIG. 37.—Chromoplasts (c) and pyrenoids (p) in algae. a. Disc-shaped chloroplasts (*Eremosphaera*, after Moore); b. Division of a pyrenoid (*Zygnema pectinatum*, after Czurda); c. Star-shaped chloroplasts (*Prasiola*); d. Band-shaped chloroplast; e. Disc-shaped chloroplasts in a diatom (*Cocconeis placentula* Ehrenb.). (All drawings except d from Fritsch 1935.)

linear dimensions up to $100\ \mu$ have been observed in some species. *Chlorella*, the unicellular green alga widely used in the study of photosynthesis, contains a single, bell-shaped chloroplast which covers the inside of the cell walls, leaving only a narrow entrance into the interior of the cell.

A characteristic feature of the chromoplasts of most algae are the so-called *pyrenoids*, irregular-shaped bodies which are supposed to consist of reserve proteins and are often surrounded by a starch sheath (cf. Fig. 37a, b, c. According to Bose (1943) the oil droplets produced by photosynthesis in algae first appear in these sheaths.

The *chloroplasts of the higher plants* are contained mainly in the palisade and sponge tissues of the leaves (Fig. 38), and are quite uniform in size and shape. They are discs or flat ellipsoids, 3–10 μ across. Möbius (1920) measured hundreds of them, in many different species, and found 5 μ as the most common size. Meyer (1912) measured the three axes of numerous chloroplasts of *Tropaeolum majus* and found: the

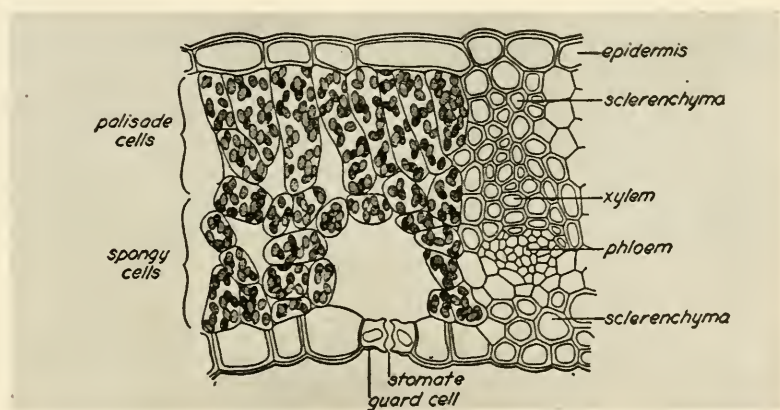

FIG. 38.—Chloroplasts in a leaf (from Meyer and Anderson 1939). Cross section of a leaf of the tulip tree (*Liriodendron tulipifera*). (Courtesy of D. Van Nostrand Company, Inc.)

major axis from 3.0–4.9 μ (average 3.9 μ); the medium axis from 2.3–4.0 μ (average 2.9 μ); the minor axis from 1.3–2.3 μ (average 1.6 μ); and the volume (assuming an ellipsoidal shape) an average of 9.4 μ^3 . According to Godnev and Kalishevich (1940), the average dimensions of the chloroplasts of *Mnium* are 6.4 \times 5.4 μ ; the average surface, 28 μ^2 and the average volume, 41 μ^3 .

The number of chloroplasts in a single cell varies, in the higher plants, from a few to a hundred or more. Haberlandt (1882) found an average of 36 chloroplasts in each palisade cell, and 20 in each spongy parenchyma cell of *Ricinus communis*, while Godnev and Kalishevich (1940) counted an average of 106 chloroplasts per cell in over 7000 cells in a leaf of *Mnium*. According to Haberlandt, the average number of chloroplasts per cm.² of leaf surface, in six species, was between 3 and

5×10^7 ; the corresponding figure for *Mnium*, according to Godnev and Kalishevich, was 9×10^7 .

The chloroplasts have been diversely described as *liquid* or *solid* systems. They are more adequately defined as *thixotropic gels*—see, for example, Menke (1938)—that is, solid colloids which can be liquefied by weak mechanical forces. This temporary liquefaction enables the chloroplasts to change their shape, grow pseudopodia, propagate by division, and occasionally discharge their contents through holes in the cell walls.

The existence of a chloroplast *membrane* was suggested by Tschirch (1884), who stated that it prevents chloroplasts from coalescing, and protects chlorophyll from being destroyed by organic acids present in the sap of many plants. Others, for instance, Schmitz (1883), considered the membrane an optical illusion. More recently, Wieler (1936) reaffirmed the existence of a chloroplast membrane in *Elodea canadensis*, and Granick (1938¹) stated that a semipermeable membrane permits maintaining isolated chloroplasts of tobacco and tomato intact for several hours in a 0.5 molar glucose solution. When isolated chloroplasts are placed in distilled water, they swell, become vacuolated, and disintegrate (*cf.* Neish 1939).

2. The Grana

Earlier investigators, *e. g.* Pringsheim (1881), Schmitz (1883), Tschirch (1884), and Bredow (1891), stated that chloroplasts have a structure which they described as a “sponge” (Pringsheim) or “net” (Schmitz). Meyer (1883) and Schimper (1885) called the structure “granular,” with dark “grana” surrounded by a lighter colored “stroma.” Then came a change in opinion. Liebaldt (1913) and Ponomarev (1914) described chloroplasts as homogeneous bodies; this interpretation received strong support from the then prevalent concept of the structure of the living protoplasm, which was considered as an homogeneous colloidal system—hydrogel or hydrosol—without microscopic differentiation. All structural details, often observed in the protoplasm under the microscope, were supposed to be artefacts, indicating a denaturation of the living matter. This point of view was extended to chloroplasts; and in all textbooks up to 1935 they were pictured as homogeneous, optically empty, colloidal bodies. Zirkle (1926) asserted that chloroplasts often contain a vacuole, connected by channels with the cytoplasm, and that these channels can give the chloroplast an apparent granular structure which may have deceived earlier observers.

In 1932, however, the hypothesis of chlorophyll grana was revived by Heitz (1932). It was confirmed by photographs (Doutreligne 1935) clearly showing the dark grana among lighter-colored “stroma” in the chloro-

plasts of *Mnium*, *Vallisneria*, *Cabomba*, and *Myriophyllum*, as well as by the observations of Wieler (1936) on *Elodea* and Weier (1936) on more than 100 species, particularly beet. Especially convincing were numerous photographs reproduced in a second investigation by Heitz (1936), in which the grana were observed and measured in the higher plants of all classes—including *cryptogams*, *monocotyledons*, and *dicotyledons*. Some of Heitz' photographs are reproduced in figure 39. His material did not include *algae*. Earlier investigators have reported that algal chromo-

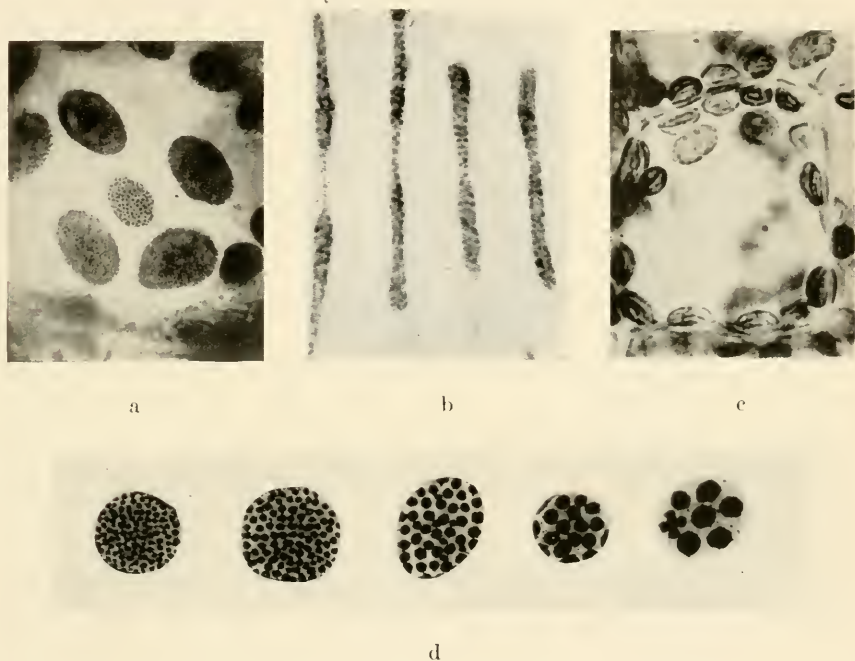

FIG. 39.—Grana (after Heitz 1936). a. *Agapanthus umbellatus*, horizontal slice through the spongy parenchyma; b. *Selaginella Watsoniana*, giant chloroplasts in intact young leaflets of the sporophyll stalks, leaf surface cells; c. *Todea superba*, side view of the chloroplasts; d. Sizes of grana in different species (drawing), the last one being in the state of division.

plasts are homogeneous. It is, therefore, important that Geitler (1937) and Hygen (1937) found that grana can be observed also in algae—even the blue-green algae, which have no chromoplasts at all. True, Geitler failed to discern grana in certain species of algae; but since the smallest observed grana were close to the limit of microscopic visibility—about 0.3μ —one could assume that, in these species, they fell below this limit. However, grana are not equally clearly visible in the chloroplasts of all the higher plants also. Some appear homogeneous under all conditions

(Weier 1938; Beauverie 1938), while in others, the grana become clearly outlined only after a special treatment (*e. g.*, in clover, according to Weier, after the leaves have been kept in darkness for 15 hours). Chemical treatment, which tends to make the protoplasmic structure coarser (as, for example, treatment with 20% ethanol according to Wieler 1936), often makes the granular structure more pronounced. Chodat (1938) obtained a similar result by heating the starch-bearing chloroplasts of *Pellionia daveanana* to 80° C.

As a result of these varying observations, some authors, *e. g.*, Heitz (1936), consider the grana as obligatory structural elements of all normal chloroplasts, while others (Weier 1936; Menke 1938) think that some chloroplasts are granular and others genuinely homogeneous.

Heitz (1936) found that the grana remain intact in chloroplasts treated by fixatives, as well as in dried cells, and can be therefore identified even in leaves from an herbarium.

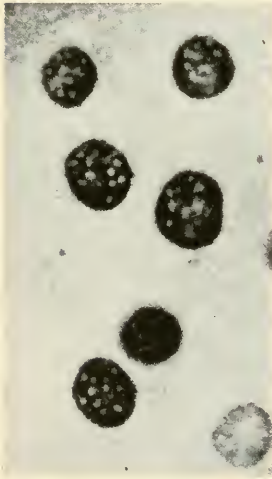

FIG. 40.—Granular silver deposits in chloroplasts (after Weber 1932).

Additional evidence in favor of the granular structure of chloroplasts has been derived from experiments on the reduction of silver nitrate by these bodies (the Molisch reaction mentioned on pages 254 and 270). In some of these experiments (*cf.* Fig. 40), silver deposits were found to enclose lighter colored islands (Wieler 1936; Weber 1937; Dischendorfer 1937); and it was suggested that these are identical with the chlorophyll grana. According to Pekarek (1938), silver is deposited on the boundary between stroma and grana, forming a netlike pattern. However, Weber (1937) and Weier (1938¹) warned against uncritical identification of the silver-surrounded islands with chlorophyll grana, pointing out that silver patterns of a different type are often obtained in the Molisch experiment, and that the location of silver has never been directly demonstrated. The silver nitrate treatment kills the cells, and can thus produce all kind of artefacts.

Some earlier authors, *e. g.*, Timiriazev (1903) and Priestley and Irving (1907), assumed that all grana are concentrated on the surface of the chloroplast. More recently, Wieler (1936), too, thought the grana to be embedded in the surface layer of the stroma. However, the photographs by Heitz (1936) and Doutreligne (1935) show the grana to be distributed more or less uniformly throughout the chloroplast. Heitz observed that sometimes the grana form several layers, so that the chloroplasts appear striated when looked upon from the side (*cf.* Fig. 39e). Certain reagents (10% acetone, for instance) cause the grana to clump together in one corner of the chloroplast (Wieler 1936).

According to Heitz (1936), the grana are flat discs. This can best

be seen on photographs showing them from the side (*e. g.*, Fig. 39c). The large diameter of the grana is from 0.3 to 2 μ according to Heitz (1936) and Baas-Becking and Hanson (1937). They are larger in shade plants than in sun plants; in a given leaf, their dimensions are larger in the spongy parenchyma than in the palisade tissue. The drawing in figure 39d shows the variations in the sizes of the grana in various plants. On the far right, in the specimen with the few large grana, one is shown in the process of division. (According to Heitz, grana generally propagate by division.)

Heitz' and Doutreligne's photographs show that the number of grana in a chloroplast can vary from ten to a hundred. Hanson (1939) has counted grana in 50 chloroplasts of *Hormidium flaccidum*; the average was 26 grana per chloroplast.

According to Neish (1939), when chloroplasts are allowed to swell in distilled water, they disintegrate, and the chlorophyll-bearing grana (disks or spheres, with a size of about one-sixth of the whole chloroplast) are set free; these swell very slowly and do not rupture for weeks. Heitz (1936), Neish (1939), and Mommaerts (1938) asserted that chloroplast preparations made by grinding the leaves in pure water and fractionating the triturate, contain free grana rather than whole chloroplasts or their fragments; but this view was opposed by Menke (1940) (*cf.* page 370).

What is the difference in composition between grana and stroma? Menke (1938) suggested that it is quantitative rather than qualitative—that the grana are vaguely outlined regions in which the concentration of certain components (*e. g.*, pigments) is higher than in the rest of the chloroplast (*cf.* page 363). It is known (*cf.* page 371 *et seq.*) that proteins form about 50% of the chloroplast matter, and lipoids (ether-soluble compounds) about 30%. It is thus natural to assume that the grana differ from the stroma in the relative proportion of these two types of materials. Wieler (1936) observed that grana can be dissolved in alcohol, leaving cavities in the stroma; he therefore considered the grana as the more lipophilic part of the chloroplast. Wieler (1936) on the other hand, thought, that only the pigments are extracted by alcohol, leaving behind discolored grana (rather than cavities); he suggested that the grana consist mainly of hydrophilic (proteinaceous) material.

An accumulation of lipoids in the grana, assumed by Wieler, is supported by staining experiments (according to Strugger 1936, and Wieler 1936, the grana are preferentially stained by lipophilic dyestuffs, *e. g.*, rhodamine B, and Sudan red III) and, according to Frey-Wyssling (1938), by the observation (attributed by him to Metzner) that grana melt upon heating. This transition is accompanied by a sudden increase in the intensity of fluorescence, which can be noticed under the fluorescence microscope (*cf.* Vol. II, Chapter 24).

Older investigators (Meyer 1883; Schimper 1885) were not certain whether *all* pigments are segregated in the grana or not. The grana undoubtedly were darker than the stroma, but the latter did not appear quite colorless. Doutréigne (1935) made photographs in monochromatic light, in the hope that, if chlorophyll were concentrated in the grana, the contrast would be strong in red and blue, and absent in green and infrared. There was (as expected) almost no contrast in infrared light, but the pictures taken in green light were not very different from those in red and blue light. However, this may be due to the fact that chlorophyll absorbs much more strongly in the green than in the infrared (*cf.* Vol. II, Chapter 21).

Heitz (1932) found that the stroma of many chloroplasts is entirely colorless. In other species, the picture was less clear—probably because of light scattering, rather than because of an actual coloration of the stroma.

The distribution of chlorophyll between stroma and grana also can be studied by means of a fluorescence microscope. Lloyd (1923) asserted that only the stroma fluoresces, while the grana remain dark. This result has not been confirmed by Metzner (1937), who asserted that on the contrary, the grana alone are fluorescent, and claimed that this difference can be used to detect the grana in specimens which do not show them clearly by transmitted light. The settlement of this controversy is desirable, since it would help to understand the state and distribution of chlorophyll in the chloroplasts (*cf.* Vol. II, Chapter 24). Lloyd's observation could be quoted in support of the concept of Seybold and Egle that chlorophyll exists in plants in two forms—in a concentrated, nonfluorescent form in the grana, and in a diluted, strongly fluorescent form in the stroma (*cf.* page 392); while Metzner's result supports the alternative (and more plausible) hypothesis that all chlorophyll is contained in the grana and is in a weakly fluorescent form.

3. The Lamina

It was stated above that, according to Heitz (1936), the grana usually are arranged in layers. Menke (1938) has concluded from the birefringence of the chloroplasts (*cf.* pages 365 *et seq.*) that these organs have a laminar structure; and Menke and Koydl (1939) observed the disintegration of microtome slices of *Anthoceros* chloroplasts into stacks of laminae, pushed apart—particularly in the middle of the chloroplasts—by the pressure of accumulated assimilates. They counted from 20 to 40 of these laminae in each slice; and since the assimilate-free chloroplasts were only 1–2 μ thick, the thickness of a single lamina must have been of the order of 0.05 μ (that is, below the limit of dissolution of an ordinary microscope). That they could be seen at all must have been due to the

fact that they were looked upon slightly obliquely, so that their larger dimensions parallel to the surface of the chloroplast could contribute to visibility. *Anthoceros* chloroplasts contain no visible grana; but a similar

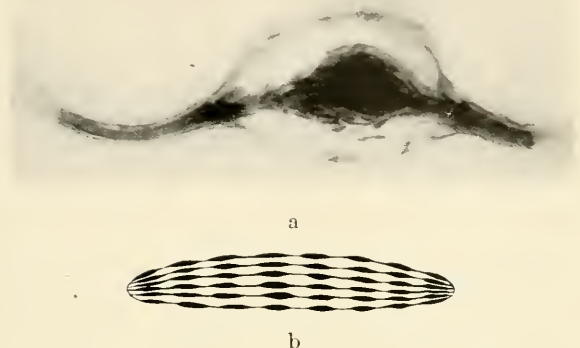

FIG. 41.—a, Laminar structure of a grana-free *Anthoceros* chloroplast (microphotograph in ultraviolet light: $\lambda = 275 \text{ m}\mu$; magnification $\times 1000$) (after Menke 1940). b, Laminar structure of a grana-carrying chloroplast (after Menke 1940).

disintegration into laminae was observed also with the granular chloroplasts of other plants. Menke concluded that the grana are parts of the lamina, in which certain components (*e. g.*, the pigments) are accumulated.

This concept was further strengthened by observations in ultraviolet light and under the electron microscope. Figure 41a shows a slice of a grana-free *Anthoceros* chloroplast photographed by Menke (1940) in ultraviolet light. The structure of grana-bearing chloroplasts, observed by Menke with slices from *Selaginella grandis* and *Phaseolus multiflorus*, is represented in the schematic figure 41b. The strong absorption of grana in the ultraviolet, revealed by this figure, may be caused by chlorophyll or the carotenoids (*cf.* Vol. II, Chapter 21); but other compounds, for example, nucleic acid, may contribute to it. Photographs in ultraviolet light of different wave length could perhaps disclose the distribution of various ultraviolet absorbing compounds in the chloroplasts.



FIG. 42.—Edge of a chloroplast of *Nicotiana tabacum* ($\times 10,000$) (after Kausche and Ruska 1940).

The results obtained by microphotography in the ultraviolet were confirmed by the electron microscope observations of Kausche and Ruska (1940), shown in figure 42. The thin discs or laminae revealed by this photograph vary in diameter from $0.4-2.5 \mu$, that is, they are of the same size as, or larger than, the grana—but their *thickness* is only

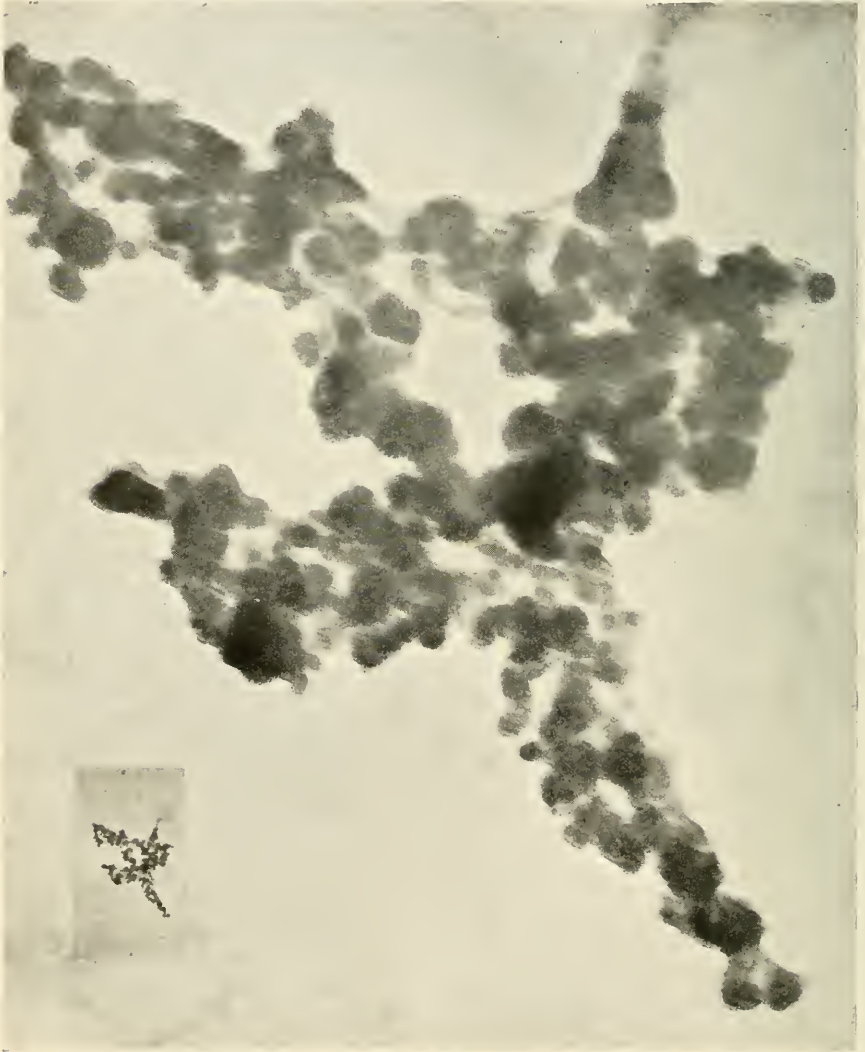

FIG. 43.—Portion of a chloroplast of *Elodea canadensis*, showing units (after Roberts 1942²). * Inset, $\times 10,000$; main figure, $\times 100,000$.

* Thanks are due to the Radio Corporation of America for use of the electron microscope and to Miss Nina Zworykin for taking this electron micrograph.

0.01–0.02 μ . Kausehe and Ruska agreed with Menke that these laminae may be of an even more fundamental importance for the structure of chloroplasts than the grana.

The submicroscopic structure of chloroplasts was also investigated by Roberts (1940, 1942). Using an optical microscope, she observed first the presence in the chloroplasts of various species of ferns, *thallophytes*, *bryophytes*, and *spermatophytes* of a small number (*e. g.*, 3 or 4) of “plastidules” into which a chloroplast can easily disintegrate, each plastidule containing several (4–40) “granules” about 1 μ in diameter

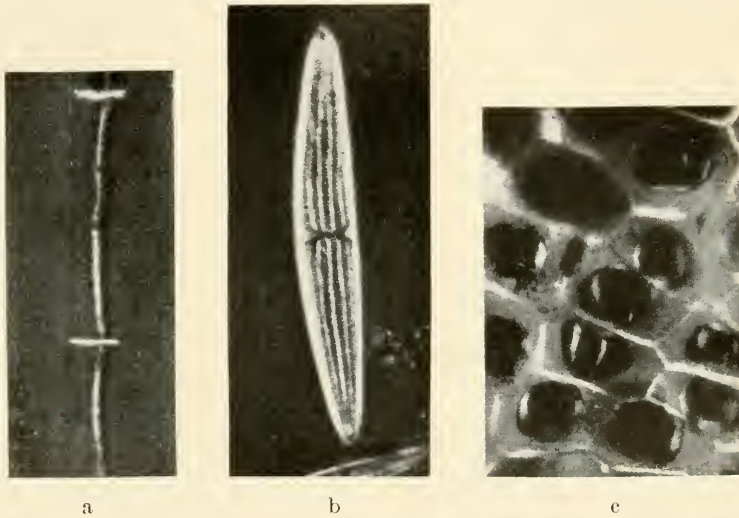

FIG. 44.—Birefringence of chloroplasts. a: *Mougeotia*, the end walls of the cells, and the chloroplasts (seen in profile) are bright; b: *Closterium lunula* (after Menke), the chloroplast, in particular its ribs, is bright; c: *Anthoeros* (after F. Weber), gametophyte cells, each containing one chloroplast, are bright at the upturned edges of the latter (from Schmidt 1937).

(these were probably identical with the Heitz grana). In a subsequent study with the electron microscope, the granules were found to consist of “primary,” “secondary,” “ternary,” “quaternary,” and “quintary” subunits, whose sizes were 0.4–0.5, 0.25, 0.1, 0.04 and 0.02 μ , respectively. Figure 43 shows a chloroplast of *Elodea canadensis*, magnified 10,000 and 100,000 times, revealing “subunits” of different order. The relation between these subunits and the laminae shown in figure 42, is not clear.

4. The Birefringence of Chloroplasts

It has been mentioned above that the laminar structure of the chloroplasts was first postulated as a means of explaining their double refraction.

The *birefringency* of chloroplasts was discovered by Searth in 1924 and rediscovered by Küster (1933, 1936), Menke (1934), and Weber (1936).

In the living cell, the chloroplasts exhibit a *negative* monoaxial double refraction (the optical axis being normal to the surface of the chloroplast). Figure 44 illustrates this phenomenon, while the position of the index ellipses is shown by figure 45. The negative double refraction disappears upon imbibition with glycerol, and is thus a *morphic* birefringence, which can be explained by a laminar structure, the planes of the laminae being oriented normally to the short axis of the chloroplasts.

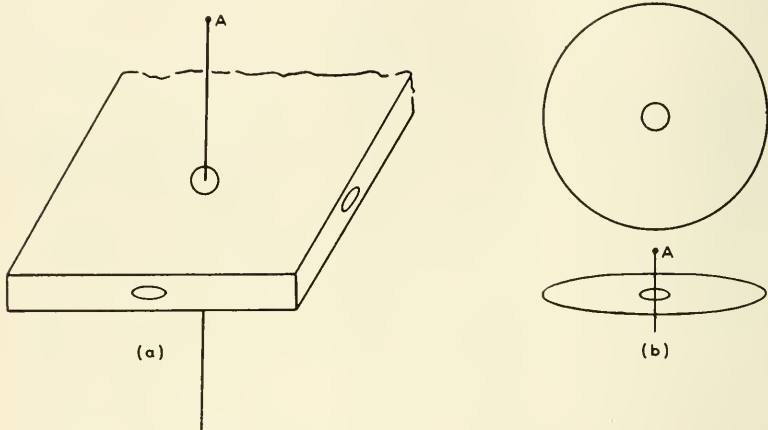

FIG. 45.—Morphic birefringence of chloroplasts (after Menke 1938). (a) Position of index ellipses in a chloroplast of *Mougeotia*; (b) same in a chloroplast of a higher plant in front view and in profile. A is the optical axis.

Further proofs of this structure were derived by Menke (1938) from observations of *dichroism*. The dichroism of the chloroplasts in the natural state is weak but detectable, particularly in monochromatic red light where the birefringence has its maximum (at $681\text{ m}\mu$). Chloroplasts fixed by Menke and Küster (1938) with osmic acid and then impregnated with gold chloride exhibited a stronger dichroism. They appeared bluish when their short axes were parallel to the plane of polarization of light, and orange when they were perpendicular to this plane. This result can be explained by the assumption of submicroscopical laminae upon which gold is deposited in thin layers.

When the chloroplasts are imbibed with glycerol, the *negative* double refraction caused by the laminar structure disappears (because of the equalization of the refractive indices of the laminae and of the interstices). Instead, a *positive* double refraction appears which must be an intrinsic property of some regularly arranged anisotropic molecules. Menke and Frey-Wyssling ascribed it to an array of elongated lipid molecules. *Dried chloroplast matter* shows a positive double refraction; extraction of

lipides with ether makes it negative. Thus, in living cells, the negative morphic birefringence overcompensates the positive intrinsic birefringence of the lipides, while the relation in dried chloroplasts is reversed, probably because of a distortion of the laminar structure.

Strugger (1936) showed that the leaves of *Elodea* can be stained with the lipophilic dyestuff rhodamine B, without affecting their vitality (as shown by unimpaired photosynthetic activity). According to Menke (1938), chloroplasts stained in this way exhibit a strong dichroism, whose character indicates that the long axes of the lipide molecules are arranged normally to the surface of the chloroplast. Thus, the laminae probably consist of a forest of long molecules aligned parallel to the short axis of the chloroplast.

Pirson and Alberts (1940) could not fully confirm the observation of Strugger that staining with rhodamine B does not impair the photosynthetic efficiency of *Elodea*. Gessner (1941) found that staining causes no ill effect in the dark, but that a "photodynamic" injury occurs in light absorbed by the dye. This light is not utilized for photosynthesis. The respiration of stained algae is not affected.

It has been suggested that the flat, two-dimensional construction is carried consequently through the whole leaf, beginning with the blade, through chloroplasts and grana, down to the submicroscopical laminae—in the same way in which the elongated, one-dimensional construction is carried through the whole stem, through single fibers down to the long-chain molecules of cellulose. However, the two-dimension principle certainly is absent from the structure of many algae, whose thalli are cylindrical rather than flat. Similarly, the chromoplasts of many algae are hollow spheres, or amoeba-like bodies rather than flat discs or bands. It would be interesting to know whether chromoplasts of this type also contain laminae. Menke and Koydl (1939) mentioned that the chromoplasts of brown and red algae show a *positive* double refraction; this may indicate the absence of laminar structure.

At present, we cannot be sure whether any of the structural units observed in photosynthesizing cells is indispensable for photosynthesis. *Chloroplasts* are absent in blue-green algae; *grana* seem to be present in plants of all phyla—including even the *Cyanophyceae*—but have been found missing in some species and individuals. *Lamina*, which, according to Menke, and Kausehe and Ruska, are more important structural units than the grana, have not yet been observed in the chromatoplasts of red and brown algae, not to speak of their probable absence in the chromatoplasm of blue algae and purple bacteria.

The existence in chloroplasts of proteinaceous and lipid laminae, and of a regular array of long-shaped, ether-soluble molecules whose axes are parallel to the plane of these laminae, was deduced by legitimate specu-

lation from experimental data. Hubert (1936) and Frey-Wyssling (1937, 1938) went beyond this, and attempted to give a detailed picture of the arrangement of proteins, lipides and pigments in the chloroplasts. Hubert suggested that chlorophyll molecules are attached by their hydrophilic porphin "heads" to the protein layers, while their lipophilic phytol "tails" are associated with lipid molecules; the entirely lipophilic carotenoids are aligned between the lipid molecules. The resulting picture is shown in figure 46. For reasons described below (page 376),

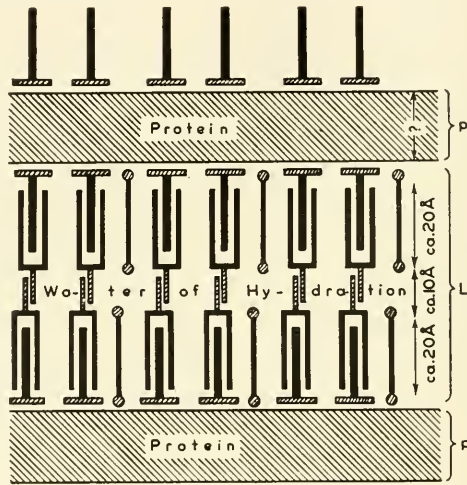

FIG. 46.—Hypothetical structure of chloroplasts according to Hubert. Rectangular hatched bars represent hydrophilic groups, black bars—lipophilic groups; combination of the two at right angles—chlorophyll molecules. The dumbbell-shaped structures represent carotenoid molecules. Phospholipide molecules are indicated by the black magnet-shaped structure attached to a hatched "handle."

the lipid molecules are assumed to form pairs (by mutual esterification); in this way, a protein layer can alternate with a double pigment-lipide layer. Although the general character of the scheme of Hubert and Frey-Wyssling appears plausible, its details are in no way proved and the correctness of some of them is doubtful. We shall return to its criticism on page 393 *et seq.*

B. COMPOSITION OF THE CHLOROPLASTS *

1. Separation and Total Quantity of Chloroplastic Matter

The best known components of the chromoplasts are the pigments—chlorophyll *a*, chlorophyll *b*, the phycobilins and the carotenoids. Their properties will be described in chapters 15–20 of this volume and 21–24

* Bibliography, page 396.

of volume II. However, pigments represent only a fraction of the total dry matter of the chloroplasts, of the order of 5 or 10%, as we shall see later. Until 1938, not much attention was paid to the nature of the remaining 90–95%. Since then, however, several attempts have been made to carry out a quantitative separation and analysis of chloroplastic matter, by Chibnall (1924, 1939), Menke (1938^{1,2,3}, 1940^{1,2}), Granick (1938^{1,2}), Mommaerts (1938, 1940), Neish (1939^{1,2}), Krossing (1940), Bot (1942), Comar (1942), and Galston (1943).

The first stage in the isolation of chloroplast matter is the *grinding* of leaves, either in distilled water or in a hypertonic, 0.5 molar sugar solution. The fractionation of the green suspension obtained in this way can be carried out by different methods. The cell wall debris is removed by centrifugation. The remaining suspension contains the water-soluble components (originating in the cell sap, cytoplasm, and chloroplasts), whole or broken nuclei and chloroplasts, forming a more or less stable suspension, and the cytoplasm, in the form of a colloidal solution. Chibnall (1924, 1939) separated the chloroplastic matter (together with a small quantity of nuclear matter) from the cytoplasmic and vacuolar material by filtration through paper pulp. Menke (1938³), Granick (1938¹), Bot (1942), Comar (1942), and Galston (1943) used fractional centrifugation, in which nuclear, chloroplastic and cytoplasmic matter were precipitated in that order. Instead of utilizing differences in the size and density of the particles, as in the mechanical precipitation and filtration methods, the separation of chloroplastic matter from the cytoplasmic material can also be based on the larger content of the former in hydrophobic (lipoid) compounds, which causes it to be preferentially salted out. Menke (1938³) used fractional coagulation by ammonium sulfate, hydrochloric acid, or carbonic acid, while Neish (1939¹) and Comar (1942) used calcium chloride.

To check whether the composition of the "chloroplastic matter," separated by fractionation is identical with that of intact chloroplasts, Menke (1938¹) prepared by centrifugation, a small fraction (containing only 1–2% of the total chloroplastic material), consisting entirely of whole chloroplasts or large chloroplast fragments. He found in this fraction 48% proteins and 37% "lipides," while the salted-out "chloroplast fraction" contained 56% protein and 32% "lipides." Menke concluded that as much as 15% of cytoplasmic matter was coprecipitated by ammonium sulfate with the "chloroplastic matter," and applied a corresponding correction to all analyses.

An uncertain point in some of these fractionations is the fate of the colorless "stroma" of the chloroplasts. If by grinding the leaves one obtains whole chloroplasts, or large fragments of these bodies, then the stroma must follow the grana—certainly in centrifugation and probably in coagulation as well. On the other hand, if the grinding

breaks the chloroplasts and releases the grana, then upon fractionation the stroma may follow either the grana or the cytoplasm, depending on its state of dispersion and the relative strength of its hydrophobic character. Since the stroma probably contains less hydrophobic material than the grana (*cf.* page 361), it may have a tendency to associate itself with the cytoplasm in fractional coagulation.

This uncertainty casts some doubt on the published analytical data. Obviously, much depends on how the grinding was carried out. Neish (1939¹) asserted that grinding *under water* produces free grana (because chloroplasts swell and rupture in distilled water), while grinding in *glucose solution* keeps the chloroplasts intact. Granick, who used a 0.5 molar glucose solution, described his "chloroplastic matter" as consisting of whole and broken chloroplasts. Menke (1938²), who carried out the grinding under water, nevertheless obtained a small fraction consisting of more or less intact chloroplasts (*cf.* Table 14.III B). He had no doubts that the "chloroplastic matter" obtained by fractional coagulation included *all* constituents of the chloroplasts (together with 15% of the cytoplasm); while Mommaerts (1938) and Bot (1942) have asserted that they have obtained preparations which consisted entirely of free grana. However, the fact that the chlorophyll content of these allegedly pure grana fractions was not higher (and sometimes even lower) than the chlorophyll concentration in the chloroplastic matter as a whole (*cf.* Table 14.X), supports the opinion of Menke (1940¹) that no separation of stroma and grana takes place in the fractionation.

Determination of the *total quantity of chloroplastic matter* in the leaves can be carried out either *directly*, by weighing the fractions obtained

TABLE 14.I
PROPORTION OF CHLOROPLASTIC MATTER IN GREEN LEAVES
A. AFTER MENKE

Method	Per cent of total dry weight of spinach leaves				
	<i>a</i> Water soluble	<i>b</i> Cell walls	<i>c</i> Chloroplastic matter ^a	<i>d</i> Cytoplasmic matter	$\frac{c}{b + c + d}$
By weighing (1938 ³)	39	26.5	18	16.5	30
By chlorophyll estimation (1940 ¹)	—	—	14.5–18.4	—	—

B. AFTER NEISH

Plant	Per cent chloroplastic matter in leaves dried at 60° C. <i>in vacuo</i>				Av.
	By weighing	By photometric estimation of			
		Chlorophyll	Carotene	Xanthophyll	
<i>Trifolium pratense</i> (clover)	22	25–34	26–32	41–50	33
<i>Arctium minus</i> (burdock)	11	33	34	54	33
<i>Onoclea sensibilis</i> (fern)	13		37	37	29
<i>Elodea canadensis</i> (water pest)	31	36	17	10	24

^a Corrected for 15% coprecipitated cytoplasm; *cf.* page 369.

from a known quantity of leaves, or *indirectly*, as in the method used by Neish (1939¹) and Menke (1940¹). They extracted chlorophyll (or the carotenoids) from the flocculated "chloroplastic fraction" on the one hand, and from an equal mass of whole leaves on the other hand; knowing that all pigments were originally associated with the chloroplasts, they calculated the total quantity of chloroplastic matter from a comparison of the concentration of the pigments in the two extracts. Table 14.I shows the results.

According to Menke's data, the proportion of chloroplastic matter in dry spinach leaves is 30% (if water-soluble components—carbohydrates, acids, salts, etc.—are excluded from the total). Since most of the soluble compounds are contained in the vacuolar sap or in the cytoplasm, chloroplastic matter must constitute about 20% of the *total* dry weight of spinach leaves. Neish's figures are somewhat higher, 25 to 35% of the total dry weight. These results can be further compared with an estimate of the relative *volume* of the cytoplasm, the chloroplast, and the nucleus in a palisade cell of *Tropaeolum majus* made by Meyer (1917) on the basis of microscopic measurements. He found for the *chloroplasts*—an average volume of $9.4 \mu^3$; average number in a cell, 54; average total volume, $508 \mu^3$; for the *nucleus*—an average volume of $54 \mu^3$; and for the *cytoplasm*—an average volume of $244 \mu^3$. This corresponds to a volume ratio of 2 : 1 between the chloroplasts and the cytoplasm. Menke's value for the corresponding mass ratio in spinach leaves is closer to 1, while Chibnall (1939) gave a value of 2.3 (for the same species).

2. Proteins and Lipoids in the Cytoplasm and the Chloroplasts

The main constituents of the chloroplasts are proteins and "lipoids." The latter term is used in a very wide sense, embracing all compounds soluble in ether or in an ether-alcohol mixture. It was previously assumed that chloroplasts are the main protein carriers in plants, since a statistical parallel was found between the size of the chloroplasts and the nitrogen content of the leaves. The correctness of this rule was, however, contested by Schumacher (1929); and the analytical data of Menke, Neish, Bot, and Comar show that, while the chloroplasts contain about 40–50% protein, the cytoplasm is almost pure protein, so that

TABLE 14.II

DISTRIBUTION OF PROTEINS BETWEEN SPINACH LEAF CONSTITUENTS (AFTER MENKE)

Fraction	Per cent of total dry weight	Content of proteins, %	Per cent of total protein
Cell walls	26.5	6	6
Cytoplasm	16.5	90	59
Chloroplasts	18	50	35

only one-third to one-half the total leaf proteins are contained in the chloroplasts (one-half, if we assume Chibnall and Meyer's ratio of chloroplasts : cytoplasm as 2 : 1 and one-third if we accept Menke's ratio of 1 : 1). Granick (1938) and Galston (1943) found 30-40% of the nitrogen in tomato, tobacco, and oat leaves to be associated with the

TABLE 14.III
PROTEINS AND LIPOIDS IN DIFFERENT PARTS OF THE LEAF
A. AFTER CHIBNALL (1939)

Analysis of spinach leaf	Cytoplasmic matter	Chloroplastic matter
Proteins, %	96.5	39.6
Lipoids, %	1.9	25.1
Ash, %	1.6	16.9
Residue, %	—	18.4

B. AFTER MENKE (1938)

Portion of spinach leaf:	Cell walls	Cytoplasmic matter			Chloroplastic matter			Iso- lated chloro- plasts		
Method of separation:	Centri- fuge	Precipitation with			Precipitation with			Centri- fuge	Centri- fuge	
		(NH ₄) ₂ SO ₄	HCl	H ₂ CO ₃	(NH ₄) ₂ SO ₄	HCl	H ₂ CO ₃			
"Lipoids," %	2.5	{	0.1	0.2	0.4	26	24	24	31	37
Ether-soluble Ether-alcohol soluble ^b										
Proteins, %	6	92	96	85	53	58	54	48	48	
Ash, %	19	7.5	4	3	14	13	6	18	8	
Rest (includes carbohydrates), %	73	—	—	11	—	—	10	4	7	

C. AFTER BOT (1942), NEISH (1939), AND COMAR (1942)

Species	Chloroplastic matter				
	Observer	Proteins, %	Lipoids, %	Rest, %	Ash, %
<i>Latyrus odoratus</i>	Bot	33-50 ^c	18-30 ^c	26-44 ^c	7
<i>Spinacia oleracea</i>	Bot	42-54 ^c	26-32 ^c	16-25 ^c	
<i>Trifolium pratense</i>	Neish	50	22		
<i>Onoclea sensibilis</i>	Neish	32	7		
<i>Spinacia oleracea</i>	Comar	54	34		

^a Water-soluble fraction: organic matter, 57% (many flavones); inorganic, 43%.

^b Contains chlorophyll (mostly chlorophyll a).

^c Depending on age of plant and time of year.

chloroplasts (in all growth periods). According to Galston, this is equally true of green and of chlorotic leaves. According to Granick's analysis, 80% of the chloroplast nitrogen is contained in proteins, 7% in compounds soluble in trichloroacetic acid (amino acids), 10% in chlorophyll (a very high value!) and 3% in alcohol-ether soluble compounds (nucleophosphatides?). Comar (1942) found 11% of total chloroplast nitrogen in "lipoids" (including the pigments), of which less than one-third was a part of chlorophyll.

Granick's figures indicate that between 24 and 32% of all spinach leaf proteins are contained in the chloroplasts; Hanson (1941) found a similar figure (36%) for *Phalaris tuberosa*. Table 14.II gives the more detailed results of Menke (1938). Chibnall (1939) estimated that cytoplasm and chloroplasts contribute equal amounts to the total protein content of spinach leaves.

The proportions of proteins and "lipoids" in different parts of the leaf are shown in table 14.III, which includes the results of Chibnall, Menke, Bot, Hanson, and Comar.

Table 14.III shows an approximate agreement between the data of Chibnall, Menke, Bot and Comar on spinach leaves, and those of Bot on *Lathyrus* and Neish on *Trifolium*; the chloroplasts of all these species contain 35-55% proteins and 18-32% "lipoids." The large chloroplasts of the sensitive fern, on the other hand, which carry 8.4% starch, differ considerably in composition—they contain only 7% of ether-soluble materials.

The study of the specific nature of the chloroplast proteins has hardly begun. An analysis of the amino acids residues, given by Chibnall (1939), is reproduced in table 14.IV.

TABLE 14.IV
ANALYSIS OF SPINACH LEAVES FOR AMINO ACIDS (AFTER CHIBNALL)

Analysis	Per cent of total protein nitrogen	
	Cytoplasmic proteins	Chloroplastic proteins
Amide nitrogen	5.6	5.1
Arginine	14.1	13.9
Histidine	2.2	3.5
Lysine	6.2	4.7
Tyrosine	2.7	2.6
Tryptophane	1.7	1.7
Cystine	1.4	1.2
Methionine	1.3	1.3
Aspartic acid	5.5	5.8
Glutamic acid	6.5	6.5

Additional data on the composition of leaf proteins can be found in the investigations of Lugg (1938, 1939, 1940), Tristram (1939) and Smith and Wang (1941). According to Hanson, Barrien, and Wood (1941), the chloroplast proteins are rich in sulfur (about 70% of total leaf protein sulfur being concentrated in the chloroplasts).

Menke (1938) suggested that the thread-forming capacity of the chloroplasts, described by Küster (1935), points to the presence of long-chain molecules. He found that 80% of the chloroplast proteins are insoluble in water, hydrochloric acid and aqueous alkali; to extract them one must use 60% alcohol with 0.3% sodium hydroxide. This protein fraction is free of phosphorus. The small protein fraction which is soluble in water contains some phosphorus (nucleophosphatides?).

FORMULA 14.1. *Phosphatidic Acid*

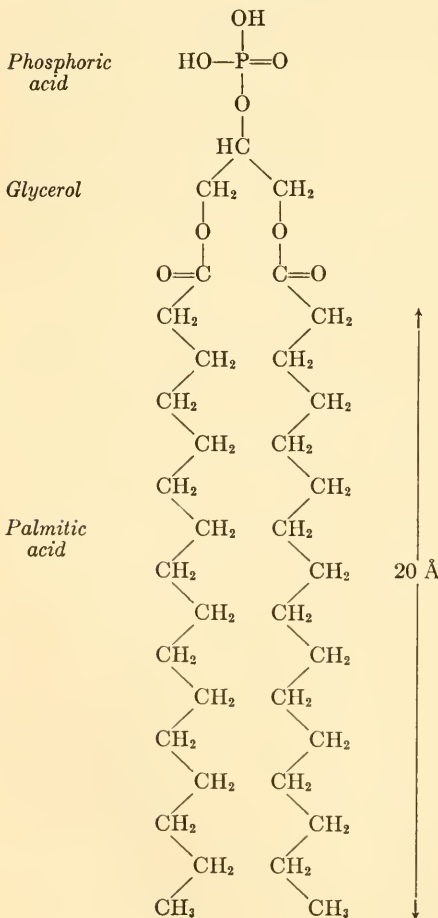

Observations on the flocculation and electrophoresis of suspended chloroplastic material (Neish; Fishman and Moyer) indicate isoelectric points between 3.7 and 4.7 (*cf.* page 386).

The so-called "lipoid" fraction (the ether extract and the ether-alcohol extract) of chloroplastic matter contains the pigments (5-10% chlorophyll and 2-4% carotenoids; *cf.* Chapter 15, page 411, for detailed data). The rest of this fraction may include fatty acids, aldehydes, fats, hydrocarbons, phytosterols, and phospholipides. The latter are of special interest because of the important role which Hubert (1936) ascribed to them in the structure of the chloroplasts (*cf.* Fig. 46).

Phospholipides are glycerides which differ from fats in that the glycerol is combined with only *two* fatty acid radicals, the third hydroxyl being esterified by phosphoric acid (*cf.* Formula 14.1). The first investigations into the composition of the leaf lipoids have been carried out by Channon and Chibnall (1927), Chibnall and

TABLE 14.V
 "LIPOIDS" IN LEAVES (AFTER CHIBNALL)

Analysis	Percentage of total ether extract	
	Cabbage (<i>Brassica oleracea</i>)	Cocksfoot (<i>Dactylis glomerata</i>)
Chlorophyll <i>a</i> + <i>b</i>	9.3	19.0
Carotene	0.5	0.9
Carotenols	0.8	1.75
Fatty acid glycerides (fats)	17.5 ^a	38.0 ^b
Waxes	12.3	23.3
Sterols	4.5	3.0
Undetermined	13.3	8.4
Calcium phosphatide ^c	18.4	0.9
Lecithin	—	} 0.6
Cephalin	—	

^a Iodine value 200 } (showing a high degree of unsaturation).
^b Iodine value 150. }

^c Phosphatidic acid (Formula 14.1) is the parent substance of lecithin and cephalin (lecithin contains an additional choline group bound to phosphoric acid).

^d Considerable losses suffered in fractionation.

Channon (1929), and Smith and Chibnall (1932), and summarized by Chibnall (1939) in table 14.V. These data refer to leaves as a whole; but since, according to table 14.III, almost all leaf lipoids are concentrated in the chloroplasts, they should be considered as valid also for the isolated chloroplasts.

Table 14.V shows that a considerable part of the lipid fraction is fats of a highly unsaturated character; the proportion of phospholipides is considerable in cabbage leaves, but comparatively small in cocksfoot. Menke (1940¹) and Bot (1942) also found only a small amount of phospholipides in the lipid fraction of leaves (0.5–1.5% of total dry weight of spinach leaves, according to Menke). This shows how arbitrary is the specific picture of the protein–chlorophyll–phospholipide association in the chloroplasts, suggested by Hubert and reproduced in figure 46.

Prior to any direct analysis, the presence of phospholipides in chloroplasts was deduced from some qualitative observations (*cf.* Frey-Wyssling 1937, 1938). In addition to staining with lipophilic dyes (*cf.* page 361), which does not necessarily require the presence of true lipides, Frey-Wyssling referred to the formation of so-called myelin figures. Lecithin (and certain other compounds) have the property of swelling in water with the formation of peculiar protuberances called "myelin tubes." Weber (1933) and Menke (1934) observed that similar outgrowths can be produced in chloroplasts (*cf.* fig. 47)

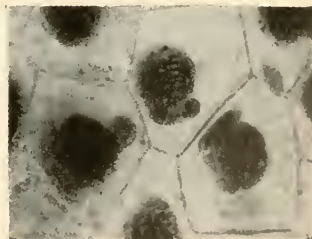

FIG. 47. Myelin tubes growing from chloroplasts (after Weber).

although only with the help of detergents such as sodium oleate, glycine, or urea. To explain the necessity for detergents, Frey-Wyssling suggested that the chloroplast lipides have no *free* hydroxyl groups. He assumed that their molecules are arranged in mutually esterifying pairs (as shown in Fig. 46).

The occurrence in the chloroplasts of *acetone-extractable phosphorus* may also be considered as an indication of the presence of phospholipides. The concentration of phosphorus in the dry matter of clover chloroplasts is, according to table 14.VI, about 0.7%.

3. The Chloroplast Ash

Earlier analyses of the mineral components of green plant tissues, *e. g.*, the analyses of Colin and Grandsire (1925), dealt with whole green leaves. Neish (1939) made the first attempt to analyze the ash of chloroplasts separately from that of the cytoplasm. His results are given in table 14.VI, together with those of Menke (1940²).

According to Neish, the *alkaline ions* (and chlorine ions) are concentrated in the cytoplasm and the cell sap; but Menke denied the absence of potassium in the chloroplasts, and attributed Neish's results to losses incurred in the washing of the chloroplastic matter. He pointed to the immediate effect of potassium supply on the photosynthesis of potassium-starved algae (Chapter 13, page 336) as an evidence for the penetration of potassium into the chloroplasts. According to Neish, the *alkaline earth metals*, including *magnesium*, are also more abundant outside than inside the chloroplasts. (This result has a bearing on the problem of the location of the alkaline earth carbonates, discussed in chapter 8.) According to Javillier and Goudchaux (1940), the proportion of leaf magnesium concentrated in the chloroplasts can vary between 0.9% (*Pinus maritima*) and 26% (*Triticum vulgare*). Even in chloroplasts, most of the magnesium is extractable by trichloroacetic acid and is thus not a part of chlorophyll.

Phosphorus is slightly more abundant in the chloroplasts than in other parts of the leaf. A considerable part of phosphorus is extractable by acetone, and may be a component of phospholipides. According to Grańiek, 40% of the lipide-bound phosphorus of the leaves is found in the chloroplasts.

Important is the accumulation of the heavy metals, *iron* and *copper*, in the chloroplasts, shown by table 14.VI. The presence of iron was first demonstrated by Moore (1914), who stained chloroplasts with hematoxylin (after having extracted chlorophyll by means of alcohol). The hematoxylin reaction is characteristic of simple iron salts, and is not given by complex organic compounds, *e. g.*, hemin derivatives. Noack (1930) found that 6% of leaf iron is soluble in water and can be identified by means of potassium thiocyanate. Griessmeyer (1930) and Wieler (1938) observed that the proportion of water-soluble iron in leaves can

TABLE 14.VI
ANALYSIS OF ASH OF CHLOROPLASTS AND WHOLE LEAVES

Plant	Material ^a	Ash in dry matter, %	Per cent of ash (Neish 1939)								
			Fe	Ca	Mg	P	K	Na	Cu	Cl ⁻	SO ₄ ⁼⁼
<i>Trifolium pratense</i>	C.M.	8.04	0.44	6.15	1.99	9.20	0.48	0.101	11.11
	Leaf	9.91	0.27	20.87	3.08	3.84	20.01	3.21	0.042	1.11	7.31
<i>Arctium minus</i>	C.M.	5.32	1.18	9.62	3.00	6.39	0.39	0.160	0.74	8.09
	Leaf	11.75	0.59	14.02	4.86	2.64	21.68	3.35	0.031	3.54	5.21
<i>Onoclea sensibilis</i>	C.M.	5.23	1.08	6.33	3.04	4.90	0.74	0.332	2.12	8.23
	Leaf	9.75	0.44	13.31	5.12	3.80	21.01	2.14	0.077	5.63	10.58
<i>Elodea canadensis</i>	C.M.	9.74	2.56	2.07	4.01	2.57	0.165	6.89
	Fronde	12.89	1.14	3.41	3.56	25.28	5.16	0.068	6.21
			Per cent of dry matter (Menke 1940 ²)								
<i>Spinacia oleracea</i>	C.	7.2-8.6	1.0-1.3	0.5	1.1	-1.5	0.6-1.07
	C.M.	8.5-9.4	0.5-0.7	0.6-0.8	0.35-0.27	2.2-2.8
	Leaf	25-29	0.8-1.3	0.8-1.1	0.6	-0.8	8-10

^a C.M.—chloroplastic matter; C.—isolated chloroplasts; for difference between these two materials, see page 369.

be increased by treatment with catalyst poisons (hydrocyanic acid or sulfur dioxide); the simultaneous increase in the intensity of the hematoxylin staining of the chloroplasts indicated that these agents act on chloroplastic iron. (However, Noack's suggestion that *only* chloroplastic iron is affected by sulfur dioxide was proved to be incorrect by Wieler's experiments on variegated leaves.) The mechanism of this "unveiling" (a term used by Wieler) of iron in the leaves is unknown, but it must consist in the decomposition of complex organic iron compounds. According to Wieler, insoluble "organic" sulfur is also transformed into a soluble "inorganic" form simultaneously with the "unveiling" of iron. Mineral acids and—more slowly—organic acids (*e. g.*, glacial acetic acid or concentrated oxalic acid) also bring organic iron in the leaves into a soluble form.

According to Wieler, the inorganic iron liberated by acids is in the divalent state when sulfur dioxide, nitric acid, or tartaric acid is used, and in the trivalent state in the case of other acids (sulfuric, hydrochloric, phosphoric, and acetic). In certain leaves, hydrochloric acid liberates both ferric and ferrous iron.

According to Noack (1930) and Griessmeyer (1930), the proportion of noncomplex, soluble iron in barley leaves can be increased from 6 to 12% by sulfur dioxide and to 10% by cyanide. The same limit (12%) can be reached also by boiling the leaf powder.

Hill and Lehmann (1941) found four times more iron in the chloroplasts of *Claytonia* than in the leaf as a whole. The molecular ratio of iron : chlorophyll was between 1 : 4 and 1 : 10 in most plants. A large part of chloroplast iron reacts immediately with 2,2'-bipyridine (it is thus present in the form of free ferrous ions); another part reacts only after boiling with acids, and still another only after ashing. Noack and Liebich (1941) have determined iron in separated *chloroplasts*, and in the *chloroplastic matter* (coagulated by ammonium sulfate or precipitated by centrifugation from a suspension of ground spinach leaves). The chloroplasts were found to contain as much as 82% of all leaf iron (0.05% of dry weight, in agreement with Neish's data in table 14.VI); the cytoplasm 5%; and the water-soluble fraction 13%. The nuclear matter and the cell walls were iron-free. About 18% of iron in spinach chloroplasts was water-soluble, 32% could be extracted by 0.01 molar hydrochloric acid (this was probably bound to phosphorus-free proteins), and the remaining 60%, which was not extractable with 0.01 molar hydrochloric acid, was probably bound to nucleic acid or to phosphorylated proteins. The latter fraction, which must include also the hemin iron of different enzymes, proved to be more resistant to iron starvation than the more loosely bound 40%. The soluble iron is divalent and the insoluble trivalent; the lipide fraction contains no iron. These results do

not quite agree with Neish's statement that 60% of the chloroplast iron (from *Trifolium pratense*) is soluble in dilute (10%) acetic acid.

As to the chloroplast *copper*, Neish (1939²) found that most of it (90–100%) is insoluble in 10% acetic acid and is probably present in the form of organic complexes.

4. The Chloroplast Enzymes

In chapters 6, 7, 8, and 10, we discussed the catalytic reactions in photosynthesis and found that the photosynthetic apparatus probably contains (at least) the following catalysts: (1) E_A , a cyanide-sensitive carboxylase (Franck's "catalyst A," possibly located outside the chloroplasts); (2) an enzymatic system (including Franck's "catalyst B") involved in the transformations which lead from the carbon dioxide-acceptor complex to carbohydrates (mutases, oxidoreductases, polymerizing enzymes), part of which system is specifically affected by dinitrophenol; and (3) an enzymatic system involved in the conversion of the primary photochemical oxidation product into free oxygen (Franck's "catalyst C"). The latter system includes (at least) two enzymes which, in several of our schemes in chapter 7, have been designated by E_C and E_O , respectively. Both these catalysts appear to be specifically affected by hydroxylamine and *o*-phenanthroline.

What is known *empirically* about the enzymes in green plant cells has not much relation to these hypothetical catalysts. The available evidence deals with the well-known enzymes like catalase, carbonic anhydrase, phosphorylase, amylase, maltase, and invertase, which either have no relation to the synthesis of carbohydrates at all, or intervene only in its ultimate stages (formation and decomposition of sucrose and starch). The occurrence of carbohydrate-transforming enzymes in green leaves was briefly discussed in chapter 3. Here, we shall add a few data on other enzymes, taken mainly from the work of Neish (1939) and Krossing (1940) on separated chloroplastic matter.

(a) *Catalase and Peroxidase*

Catalase, the enzyme which causes the dismutation of hydrogen peroxide, is found in both colorless and green plant organs. The relation between photosynthesis and catalase activity was discussed in chapter 11 (page 284). Neish (1939²) has measured the catalatic activity of separated chloroplast matter and compared it with that of whole mashed leaves (Table 14.VII). According to this table, all the catalase of green leaves is concentrated in the chloroplasts. Krossing (1940) on the other hand, found catalase both in the chloroplasts and in the cytoplasm.

The efficiency of catalase is about 10^5 moles hydrogen peroxide decomposed per sec. per gram atom iron. The liberation of 12 mm.³ oxygen per 2 min. per 1 mg. chloro-

TABLE 14.VII
 CATALATIC ACTIVITY OF LEAVES (AFTER NEISH)

Sample	O ₂ released by 1 mg. material in 2 min. from 0.01 M H ₂ O ₂ at 27° C., mm. ³		
	<i>Trifolium pratense</i>	<i>Arctium minus</i>	<i>Onoclea sensibilis</i>
Chloroplasts	7.1	12.1	13.6
Whole leaves	1.8	3.8	4.8
Proportion of total activity concentrated in the chloroplasts, %	107	112	105

plast matter thus requires the presence of only 2.5×10^{-9} g. catalase iron in 1 g. chloroplast matter. Since the content of iron in 1 g. dry chloroplast matter is from 3×10^{-4} (*Trifolium pratense*) to 2.5×10^{-3} g. (*Elodea canadensis*), an infinitesimal part of the available iron is sufficient to build up the amount of catalase revealed by these experiments.

Peroxidase is present, according to Krossing (1940), mainly in the water-soluble fraction of green leaves. Lubimenko (1928) postulated a relation between the peroxidase activity of leaves and the formation and decomposition of chlorophyll (*cf.* Chapter 15, page 431).

(b) Carbonic Anhydrase

Carbonic anhydrase catalyzes the hydration and dehydration of carbon dioxide (page 176). Burr (1936) and Mommaerts (1940) found no carbonic anhydrase in mashed leaves. Burr explained its absence by the fact that all respiring plant cells are directly exposed to air, and that therefore no necessity exists for an artificial increase in the velocity of the carbon dioxide exchange between liquid and gas (this necessity arises in the respiratory organs of animals, where carbon dioxide collected from the whole body must be exchanged through a small surface). Neish (1939²), on the other hand, observed a certain carbonic anhydrase activity in separated chloroplastic matter and (to a lesser extent) also in the cytoplasm, as shown by table 14.VIII.

(c) Chlorophyllase

This enzyme was discovered by Willstätter and Stoll (1913); it is an esterase which catalyzes the exchange of phytyl for other alkyl radicals, *e. g.*, methyl or ethyl. In solutions which contain water, hydrolysis of phytyl chlorophyllide may occur, leading to the corresponding monocarboxylic acid (chlorophyllin). The enzyme is present in leaves; the observation that alcoholic extracts of leaves left standing in contact with

TABLE 14.VIII
CARBONIC ANHYDRASE IN LEAVES (AFTER NEISH)

Sample	CO ₂ released in 30 sec. by 1 mg. dry tissue at 27° C., mm. ³		
	<i>Trifolium pratense</i>	<i>Arctium minus</i>	<i>Onoclea sensibilis</i>
Chloroplasts	14	58	50
Whole leaves	15	25	38
Proportion of total activity in the chloroplasts, %	24	78	48

the leaf pulp gradually lose their phytol led to its discovery. When leaves rich in chlorophyllase (for example, those of *Heracleum spondylium*) are kept in aqueous methyl alcohol for several hours, chlorophyll is converted into methyl chlorophyllide, which forms crystalline aggregates in the cells (Borodin's and Monteverde's "crystalline chlorophyll").

Grass, nettle, and certain other plants are poor in chlorophyllase, and are therefore particularly suitable for the extraction of intact chlorophyll.

The enzyme can be used both for the preparation of alkyl chlorophyllides from chlorophyll and for the reverse reaction, the synthesis of chlorophyll from alkyl chlorophyllide (or free chlorophyllin) and phytol (Willstätter and Stoll 1913; Fischer and Schmidt 1935).

Meyer (1930) studied chlorophyllase in Noack's laboratory. His enzyme preparations were made by extracting chlorophyll with dry acetone from centrifuged chlorophyll-protein precipitates. The remaining colorless material was used for the hydrolysis of chlorophyll and its derivatives in buffered aqueous acetone solutions of known pH. An optimum of activity was found at pH 6. The enzyme acts equally strong on chlorophyll and on pheophytin, but about four times more slowly on allomerized chlorophyll. Pure chlorophyll *a* is hydrolyzed 18 times more quickly than the pure *b* component.

Preparations which are liberated from electrolytes by protracted washing lose the greater part of their activity, which can be restored by the addition of salts, *e. g.*, lithium chloride, potassium chloride, cupric chloride, iron lactate, etc. Ferrous salts have an effect even in a dilution of 0.001 mole per liter. Addition of potassium cyanide to electrolyte-containing preparations has no effect; but its addition to preparations from which salts have been removed by washing causes a complete loss of activity. The enzyme is resistant to absolute alcohol, even when hot, and to hydrochloric acid, but is easily deactivated by ammonia.

Meyer gives tables of the relative chlorophyllase content of different plants, as well as its variations with age, season, etc. The preparation of the enzyme from Noack's "chloroplast matter" precipitates (*cf.* also Krossing 1940) indicate its presence in the chloroplasts; but white parts of variegated leaves, and even certain roots, also contain chlorophyllase.

C. PIGMENTS IN THE CHLOROPLASTS *

1. Association of Pigments with Proteins and Lipoids in the Cell

The composition of the chloroplast pigment system and the properties of the single pigments will be discussed in chapters 15 to 20 and in chapters 21 to 24 of volume II. In the present chapter, we shall deal only with the state of the pigments in the chloroplasts and their relation to proteins and lipoids.

A chloroplast is perhaps one-half water (no exact data on water content appear to be available; *cf.* Menke 1938), the other half consisting of 50% protein, 30% "lipoids" (*i. e.*, ether- or ether-alcohol soluble compounds) and up to 10% pigments. The concentration of matter in the chloroplasts is so high that each pigment molecule is continually in interaction with several neighbors. The problem arises whether this interaction leads to *associations* of a more or less permanent nature and, if so, whether these associations occur in *stoichiometric* proportions, or are more in the nature of "adsorptions"—a variable number of smaller molecules being bound by one larger molecule or attached to a colloidal interface.

Chlorophyll molecules are similar to tadpoles, with a flat, slightly hydrophilic head (porphine nucleus) and a hydrophobic tail (phytol chain). The "head" may have the tendency to associate itself with protein molecules; the "tail" may have an affinity for other paraffin chains and thus tend to associate itself with other hydrophobic "lipoid" molecules. The *carotenoid* molecules are all tail and no head; they are either completely nonpolar (carotenes) or slightly polar (carotenols). Their strongest tendency is for association with lipides, which is why they are often designated as "lipochromes"—although the carotenols are occasionally also found in association with proteins. The *phycobilin* molecules are all head and no tail; their tendency for association with proteins can therefore assert itself without interference by the lipides; they belong to the class of "chromoproteids." The result of these gradations in polarity is that of all plastidic pigments only the phycobilins can be dissolved directly from the cells by water, forming a colloidal pigment-protein solution, and are not extracted from the latter by organic solvents.

The behavior of chlorophyll in the living cell is much more complex. Grinding of leaves with pure water produces a green suspension, consisting of broken cells, chloroplasts, or single grana, which is more or less stable depending on the grinding procedure and the species, but does not represent a true colloidal solution. The particles in the suspension are comparatively large and nonuniform and contain proteins, lipoids, and

* Bibliography, page 397.

pigments. Probably they are kept floating by the hydrophilic properties of the proteins. Dilution with organic solvents breaks the pigment-protein link, denatures and precipitates the proteins, and dissolves the chlorophyll and the carotenoids.

Pure organic solvents—*e. g.*, ether, water-free acetone, or alcohol—do not dissolve chlorophyll from the leaves. One could suggest that the solvents are unable to break the pigment-protein link so long as no water is present to take care of the proteins. However, the immersion of leaves into ether causes a shift in the position of the absorption bands and an increase in fluorescence, which seems to indicate that the pigment has been liberated from the protein complex and has passed into a lipid phase. What forces still prevent it from diffusing from the cells into ether is not immediately clear.

The only efficient way to extract chlorophyll and other pigments from the cells is by using *aqueous organic solvents*, water disintegrating the proteinaceous fraction of the chloroplast structure, and the organic solvent taking care of the lipid fraction, including the pigments. Once separated from the cell structure, the pigments become easily soluble in pure organic solvents.

Several other observations speak for the association of chlorophyll with some "carrier" in the cell. One is the position of its absorption bands, which are shifted 10–20 $m\mu$ towards longer waves relative to their position in solution (*cf.* Vol. II, Chapter 22); *e. g.*, the main absorption peak in the red is situated at 675–680 $m\mu$ in the living cells, as against 660–670 $m\mu$ in organic solvents. The *fluorescence band* also is shifted towards the red (*cf.* Vol. II, Chapter 24), and the fluorescence is at least ten times weaker than that of dissolved chlorophyll. The absorption bands of the carotenoids are shifted even more strongly than those of chlorophyll (*cf.*, for example, Menke 1940).

Chlorophyll in the living cell is much less sensitive to acids than is chlorophyll in solution. (According to Hilpert, Hofmeier, and Wolner 1931, it is *more* sensitive to cold dilute alkali.) It is also much more resistant to bleaching (photooxidation or photoreduction; *cf.* Chapter 19, page 537). This stability, too, points to the protective action of a "carrier," probably a protein. Inman and Crowell (1939) found that trypsin causes the conversion of chlorophyll in the cells into pheophytin, and suggested that magnesium serves as a link between chlorophyll and protein. Zirkle (1926) found that proteins in etiolated chloroplasts are easily digested by enzymes, while those in green chloroplasts are more resistant; thus while chlorophyll is protected chemically by the proteins, the proteins are protected by chlorophyll.

When leaves are put into ether, or cooled by liquid air, or boiled in water, the absorption band is shifted toward its position in true solution,

thus indicating the probable decomposition of the protein-chlorophyll complex (Willstätter and Stoll 1918; Seybold and Egle 1940). Chlorophyll in leaves killed in this way is much more sensitive to oxygen and acids than it was before killing.

It thus seems certain that chlorophyll (and the other chloroplast pigments) are associated, in the living cell, with the cell proteins, and probably also with some lipophilic compounds. We now ask: is this an association in stoichiometric proportions; and does it involve uniformly *all* the chlorophyll contained in the cell?

That the association of porphine derivatives with proteins *can* lead to the formation of stoichiometric compounds is well known from the example of hemoglobin and cytochrome, in which one porphyrin molecule is associated with one so-called "Svedberg unit" of protein (molecular weight $\sim 17,000$). Whether an association with *lipides*, which is produced by nonpolar, van der Waals' forces, also can result in stoichiometric relations is less certain.

As early as 1886, Reinke speculated that chlorophyll (and the yellow pigments) may be bound to proteins in the leaf in the same way as hemin is bound to globin in hemoglobin. Since then, it has become evident that most biological catalysts (enzymes) consist of similar combinations of a protein "carrier" with an active ("prosthetic") molecule. Since chlorophyll may be considered as an enzyme which becomes active in light, the hypothesis that it has a similar "chromoproteic" constitution appears natural. However, this hypothesis still lacks definite confirmation. Many different chlorophyll-protein suspensions and colloidal solutions have been prepared, both by disintegration of plant material and by the interaction of pure pigment with proteins *in vitro*; but none had a simple and reproducible composition similar to that of hemoglobin or cytochrome. Difficulties have been encountered also in reproducing in chlorophyll-protein complexes the two above-mentioned properties of "natural" chlorophyll—the position of its absorption band and its fluorescence.

2. Pigment-Protein Suspensions and Solutions

The preparation of green aqueous extracts from leaves was first described by Herlitzka in 1912. He obtained them by the grinding of spinach leaves, and described them as possessing the unchanged spectral properties of chlorophyll in the leaves. Lubimenko (1921, 1927) found that certain species, *e. g.*, *Aspidistra elatior* and *Funkia*, are particularly suitable for extraction by water, and give stable clear "solutions" which are not precipitated by centrifugation. The spectrum of these solutions was "identical with that of the leaf"; they were stable in sunlight; and acetone or alcohol precipitated from them the protein-chlorophyll

complex, and then dissolved the chlorophyll from the precipitate. Similar extracts prepared from other plants were turbid and unstable.

Lubimenko found that the aqueous complex contained not only the chlorophyll but also the carotenoids of the leaves, and considered it as a chemical compound which he called "natural chlorophyll."

Noack (1927) also prepared a green extract by centrifuging triturates of different leaves. These extracts were fluorescent, decomposed upon heating above 70° C., and were precipitated by heavy metal salts and ammonium sulfate.

Price and Wyckoff (1938) and Loring, Osborne, and Wyckoff (1938) obtained green aqueous solutions by the centrifugation of press juices of cucumber and green pea leaves. The colored protein particles were very heavy (molecular weight $\sim 500,000$, judging by the high velocity of their precipitation in the ultracentrifuge).

Stoll and Wiedemann (1938) prepared green aqueous extracts from spinach, nettle, wheat, rye, grass, sunflower, and many other plants, by grinding them at low temperature in distilled water, avoiding contact with metal. Suspensions prepared from different leaves were similar, and resembled living leaves in respect to spectrum, fluorescence, and stability to light, oxygen, and carbonic acid. They could be freed by centrifuging from larger cell fragments, and, by twice-repeated salting out with ammonium sulfate, from different colorless and brown, water-soluble admixtures. At 0° C., not much substance was lost by denaturation in the course of this purification. A final purification was carried out by precipitation of the colored protein in a high-speed centrifuge (45,000 r.p.m.), and dialysis through a cellophane membrane into distilled water. The product was designated by Stoll and Wiedemann as "chloroplastin."

The green colloidal "solution" of chloroplastin, obtained by resuspending the purified product in distilled water, remains stable for months at pH 7.2-7.4, and 0.2° C. It is denatured by changes in pH, drying, or warming. Light and air do not affect it—an illumination of 40,000 lux for 25 hours in contact with air caused no damage, although this treatment would have destroyed completely any molecular or colloidal solution of chlorophyll. No particles can be detected in chloroplastin suspensions under the microscope, even with powerful immersion systems. In the ultramicroscope, the solutions sometimes appear optically empty, but sometimes show particles engaged in a lively Brownian motion. Stoll and Wiedemann considered these particles as accidental agglomerations of the invisible "chloroplastin molecules." Shaking with ether does not extract chlorophyll from these suspensions, unless salts are added (the chloroplastin complex is easily broken by salts, for example, sodium chloride). The purified, resuspended chloro-

plastin contained about 80% protein, 10–20% lipoids, and 5% pigments (including chlorophyll *a*, chlorophyll *b*, carotene, and the carotenols, in the same proportion as in the intact leaves).

Preparations similar to those of Stoll and Wiedemann were obtained by many other investigators. Katz and Wassink (1939) prepared them by grinding unicellular green and blue algae (*Chlorella* and *Oscillatoria*). Cataphoresis experiments showed that the particles of these suspensions were negatively charged: they became positive in 0.002 normal hydrochloric acid. The isoelectric point was at or near 3.7 (confirmed by Neish 1939). Fishman and Moyer (1942) studied the electrophoresis of suspensions obtained by grinding of *Aspidistra elatior* and *Phaseolus vulgaris* leaves. In agreement with the results of Stoll and Wiedemann, they were found to be fluorescent and photostable, but temperature-sensitive. The Brownian motion of the particles was clearly visible in the dark field, and they were large enough to observe electrophoresis. They were negatively charged. The isoelectric point was at *pH* 4.7 for the suspension from *Phaseolus* (as against *pH* 4.22 for the cytoplasmic proteins from the same source); that of *Aspidistra* was at a much lower *pH* (~ 3.9). Moyer and Fishman (1943) found that the isoelectric points of chloroplastic suspensions from ten species of legumes varied between 4.6 and 5.0.

Lubimenko, and Stoll and Wiedemann, had a tendency to stress the "molecular" character of the protein-pigment complex: it was asserted by them to be uniform in composition, and the size of its particles below the limit of ultramicroscopic visibility, except for cases of agglomeration. However, the observation of Fishman and Moyer that the particles are generally visible in the dark field, and the fact—confirmed by Stoll and Wiedemann—that they can be precipitated in an ordinary high-speed centrifuge, places their size well above that of the largest known protein molecules. Anson (1941) recalled the assertion of Lubimenko that stable solutions can be obtained only with leaves of certain species, and used one of them (*Funkia*) for his experiments; but he obtained merely an opalescent suspension which was completely sedimented at 20,000 r.p.m.—that is, a suspension whose particles were much larger than the gigantic molecules of the tobacco mosaic virus.

The conclusion that the "chloroplastin solutions" obtained by the grinding of leaves in distilled water are merely suspensions of particles of comparatively large and nonuniform size was reached also by Smith (1938, 1940, 1941), who studied the effect of different detergents on extracts from *Spinacia* and *Aspidistra*, and found that "solutions" obtained directly by grinding leaves under water produce no sharp sedimentation boundary in the ultracentrifuge, and are usually large enough to cause turbidity. (This applies also to preparations made from

Aspidistra leaves, recommended by Lubimenko.) After separation from the dissolved cytoplasmic proteins (by centrifugation or filtration through paper pulp), the green chloroplast matter was resuspended by Smith in pure water. It was precipitated by heating above 60° C. or by adding half-saturated ammonium sulfate, and coagulated by dilute acids (pH 4.5). The latter do not convert the chlorophyll in these suspensions into pheophytin (as they would in absence of the protein), so that the acid precipitate gives a pure green solution upon resuspension. However, it cannot be resuspended in pure water, but only in dilute alkali (pH 9). The absorption spectrum of the suspension (reproduced in Vol. II, Chapter 21) was similar to that of the living leaf. Smith called his preparations "nonfluorescent," while Noack (1927), Stoll and Wiedemann (1938), and Fishman and Moyer (1942) have described similar suspensions as "weakly fluorescent."

Smith's turbid chlorophyll-protein suspensions were clarified instantaneously by various detergents (digitonin, sodium dodecyl sulfate, sodium desoxycholate or bile salts) and thus probably converted into true macromolecular solutions. (The detergents have the same effect on colloidal solutions of pure chlorophyll.) The clarified solutions have been studied by Smith and Pickels (1940, 1941) by means of the ultracentrifuge. Their properties depend on the nature of the detergent. Digitonin (as well as sodium desoxycholate and bile salts) splits the pigment from the protein; the pigments sediment together with the digitonin micelles; while the pigment-free protein forms another boundary, corresponding to a sedimentation constant of 13.5×10^{-13} and a molecular weight (calculated from Stokes' law) of approximately 265,000 (that is, about one-half of Wyckoff's value). Sodium dodecyl sulfate, on the other hand, leaves the pigment attached to the protein, but splits the latter into smaller units. Furthermore, in acid solution, chlorophyll becomes converted into pheophytin, showing that dodecyl sulfate destroys the protection which magnesium enjoys in the natural chloroplastin complex, even though large fractions of the original protein molecule remain attached to the pigment.

The absorption spectrum of the colloidal chlorophyll solutions clarified by detergents remains similar to that of the living cell (except in the far red; cf. Chapter 21, Vol. II). They are nonfluorescent.

All these experiments, while confirming the association of chlorophyll with the chloroplast proteins, do not prove the existence of a chlorophyll-protein compound of a constant stoichiometric composition, comparable to hemoglobin. Determinations of the average chlorophyll-protein mass ratio in chloroplasts (cf. page 389 *et seq.*) prove that there is not enough protein available to provide each chlorophyll molecule with a "protein unit" of the same size as in hemoglobin.

Differences between the absorption spectra of different leaves have led Lubimenko (1927) to believe that they contain slightly different—perhaps isomeric—green pigments; however, many of these variations may be caused by scattering and by varying proportions of components *a* and *b* (Chapter 23, Vol. II). If, however, it should be proved that genuine spectroscopic differences exist between the green cells of different species, one should think first of association with different proteins (rather than variations in the structure of the pigment molecule). This view is supported by observations on the spectrum of bacteriochlorophyll-protein extracts (*cf.* Chapter 22, Vol. II) and on the isoelectric points of suspended chloroplast matter from different plants (*cf.* above, page 386).

Mention should be made here of attempts to prepare artificial protein-chlorophyll complexes from chlorophyll solutions in organic solvents. Eisler and Portheim (1922) precipitated chlorophyll from alcoholic extracts with horse serum. The green precipitate was water-soluble; its spectrum was described as “similar to that of chlorophyll in the leaves.” It was slightly fluorescent (according to Eisler and Portheim 1923, it was even photosynthetically active!). Noack (1927) adsorbed chlorophyll on proteins (albumin, casein, legumin, hordenin, and clupein sulfate), and on peptones. Some of these precipitates were weakly fluorescent, but Seybold and Egle (1940), who repeated Noack’s experiments, suspected that their fluorescence was a sign of the presence of lipid impurities (*cf.* Chapter 24, Vol. II).

In all of Smith’s experiments (1940–1941), the *carotenoids* apparently followed chlorophyll, thus supporting Lubimenko’s view that the natural complex (“chlorophylle naturelle”) contains not only chlorophyll and protein but also the yellow pigments. However, Lubimenko’s contention that the carotenoids do not exist as such in the natural state (because their absorption peaks are absent in the leaf spectrum) must be rejected. Not only is it *a priori* implausible, but the absorption maxima of the carotenoids actually *can* be recognized in many absorption curves of green leaves and algae, and particularly clearly in those of purple bacteria (*cf.* numerous figures in Chapter 22, Vol. II).

The association of *bacteriochlorophyll* in purple bacteria with proteins has been proved by experiments similar to those described above for the higher plants. Levy, Tessier, and Wurmser (1925) obtained aqueous extracts of a colored protein by grinding purple bacteria (*Chromatium*); while French (1938, 1940) used ultrasonic waves to break the bacteria (*Streptococcus varians*, *Rhodospirillum rubrum*, *Rhodovibrio*, and *Phaeomonas*) and to release their cell content. The mixture obtained in this way was separated by centrifugation from cell fragments, and a clear colloidal solution remained which contained both the bacteriochlorophyll and the bacterial carotenoids, together with the proteins. The absorption spectrum of the extract was very similar to that of intact bacteria.

Wassink, Katz, and Dörrestein (1939) made extensive spectroscopic investigations of colored colloidal extracts obtained by grinding purple bacteria (*Thiorhodoceae* and *Athiorhodoceae*) (cf. Chapter 21, Vol. II). The spectrum of a suspension in egg albumen, in particular, was found to be practically identical with that of intact bacteria.

Whereas the spectra of alcoholic solutions of bacteriochlorophyll were identical for all strains, the spectra of intact cells and of colloidal protein-pigment solutions varied considerably from strain to strain. In solution, bacteriochlorophyll has only one absorption peak in the infrared, but the cell suspensions and colloidal extracts showed two such peaks, with humps indicating additional bands. This can be interpreted as evidence of complex formation by one and the same pigment with several different proteins.

3. The Chlorophyll-Protein Ratio

On the strength of the experiments described in the preceding section, many authors have assumed the existence of a chlorophyll-protein compound in the chloroplast as definitely established, and have suggested different names for it. Mestre (1930) proposed the name *phyllochlorin*, which is, however pre-empted for a compound of the chlorin class. As mentioned on page 385, Stoll (1936) introduced the name *chloroplastin*, while French (1940) preferred *photosynthin*, because chloroplastin suggests a limitation to chloroplast-bearing plants, with the exclusion of algae and bacteria. Perhaps *chloroglobin* (or *chromoglobin*) would be a better name because of its analogy with hemoglobin.

However, before any such name is adopted, a proof of constant and reproducible size and composition of the chlorophyll-protein complex appears desirable. As we have mentioned in the preceding section, the *size* of the protein-lipoid-pigment particles prepared by the disintegration of the chloroplasts in water varies widely from experiment to experiment. We shall now consider the *composition* of these particles, particularly their chlorophyll-protein ratio. Smith (1941) suggested that three molecules of chlorophyll *a* and one molecule of chlorophyll *b* are associated with one Svedberg unit of protein (molecular weight $\sim 17,000$) in leaf extracts (prior to their "clarification" by detergents). This conclusion was based on analyses showing 16.3 g. chlorophyll per 100 g. protein in the chloroplastic matter from *Spinacia* and 15.5-16.5 g. per 100 g. protein in that from *Aspidistra*, and on the fact (cf. Chapter 15) that the average ratio $[a] : [b]$ in the higher plants is close to 3. However, very different chlorophyll-protein ratios have been found by other observers, and the $[a] : [b]$ ratio also can vary widely (the *b* component being altogether absent in most algae; cf. page 405).

TABLE 14.IX
CHLOROPHYLL-PROTEIN RATIO IN THE CHLOROPLASTS

Author	Source	Preparation	Mass ratio Chl: protein	Molecular ratio ^a	
				Chloro- plasts	Grana
→ Granick (1938)	Tomato, tobacco	Chloroplasts	0.33	5.5	22
Mommaerts (1938)	Clover, spinach, etc.	Free grana (?)	0.053	—	0.9
Menke (1938 ²)	Spinach	Chloroplasts	(0.11) ^b	(2)	(8)
Neish (1939 ²)	Clover, burdock, fern, <i>Elodea</i>	Free grana (?)	(0.06) ^b	—	(1)
→ Smith (1940)	Spinach, <i>Aspidis- tra</i>	Chloroplastic matter	0.16	3	12
Hanson, Bar- rien, Wood (1941)	Sudan grass	Chloroplastic matter		5-10 ^c	
→ Bot (1942)	Spinach, <i>Lathyrus odoratus</i>	Grana (?)	0.07- 0.15 ^d	1-3	4-12
French (1940)	Purple bacteria	Colloidal pigment- protein extract	0.0005	0.08	

^a Molecules chlorophyll per Svedberg unit of protein (molecular weight 17,000).

^b Calculated by assuming 1% chlorophyll in total dry matter.

^c About 10 in young leaves; about 5 in old leaves.

^d Depending on age and season.

Table 14.IX shows the results of the determination of the ratio of protein to chlorophyll in the chloroplastic matter by different observers. The last two columns give the number of chlorophyll molecules for each Svedberg unit of protein. The results disagree considerably. The values which are supposed to apply to chloroplasts as a whole are higher (instead of lower) than those purported to represent the composition of the grana alone. If we believe the conclusions of Mommaerts and Neish, each chlorophyll molecule in the grana could be associated with an individual protein unit (as in hemoglobin and cytochrome *c*). If Menke, Granick, Bot and Hanson are right, there is not even enough protein in the whole chloroplast to provide each chlorophyll molecule with its own protein "unit."

An independent estimate of the ratio of chlorophyll to protein can be obtained from microphotographs which show that not more than 20% of the total leaf volume is taken up by chloroplasts; Menke's value (18% chloroplast matter in the leaf) may be near the truth. According to figure 39 (and similar pictures found elsewhere in the literature), not more than 30-40% of the chloroplast volume is taken up by grana (100 grana with a diameter of 0.5 μ must occupy about 5 μ^3 in an average chloroplast whose total volume is 20 μ^3); thus, the grana should contain not more than 10% of the total material of the leaf. This makes it

improbable that the 30–40% of the dry material of leaves which constituted Neish's "chloroplast fraction" could represent free grana. To justify the opposite point of view, Mommaerts (1938) and Hanson, Meeuse, Mommaerts, and Baas-Becking (1938) spoke of "chloroplasts tightly packed with grana," and identified the volume of the grana with the total volume of the chloroplast—an assumption which defies the evidence of microphotography.

According to page 411, the chlorophyll content of a single chloroplast of *Mnium* is of the order of 2.5×10^{-12} gram. Assuming that this chloroplast has a volume of $40 \mu^3$, and contains 2×10^{-11} g. dry matter, of which 1×10^{-11} g. is protein, the mass ratio of chlorophyll : protein becomes 0.25, in approximate agreement with the figures of Granick, Smith and Bot in table 14.IX.

The outcome of this discussion is: *first*, that although the association of chlorophyll with proteins in chloroplasts is highly probable, the existence of a chlorophyll-protein complex of uniform composition is not proved by experiments; and *second*, that the chlorophyll : protein ratio in the grana is at least four times larger than in hemoglobin or cytochrome.

The values for the protein : chlorophyll ratio in table 14.IX may have to be further increased if one assumes (as suggested on page 361) that the concentration of lipoids in the grana is higher (and that of the proteins correspondingly lower) than in the stroma. In fact, there is enough lipid material in most chloroplasts to fill the grana completely, thus increasing the chlorophyll : protein ratio in the grana to infinity.

4. Role of Lipides in Chloroplasts; the Model of Hubert

On page 371 *et seq.*, we discussed the occurrence of proteins and lipides in the chloroplasts, and stated that the pigments may be associated with either or both of these components. We then reviewed (page 382 *et seq.*) the evidence of chlorophyll-protein association. The possible association between the pigments and lipides will now be considered. While the pigment-protein link may be a true chemical bond and thus lead to stoichiometric relations, the pigment-lipide association is more likely to be of a "physical" nature, with the lipide molecules tending to surround the pigment molecule and bring it into solution.

Liebaldt (1913), who thought the chloroplasts to be microscopically homogeneous, suggested that they may contain a submicroscopic emulsion of a lipide in which the pigments are dissolved. She observed that, when surface-active substances are introduced into the cell, small oil drops appear in the chloroplasts, and assumed this to be the result of the coalescence of submicroscopic lipide drops. (Zirkle, 1926, suggested,

however, that the drops may consist of free phytol, displaced from the chlorophyll molecule by the alcohols used as surface-active agents.)

Liebaldt's view was shared by Stern (1920, 1921), who considered the fluorescence of chlorophyll *in vivo* as the most important indication of its state, and observed that nonfluorescent colloidal chlorophyll solutions can be made fluorescent by the addition of a lipide (soap, oleic acid, lecithin, etc.) which converts the colloid into an emulsion with the pigment in true solution in the lipid drops. Wakkie (1935) found that the presence of sodium oleate prevents the fluorescence of chlorophyll from disappearing upon dilution of a molecular alcoholic solution by water, showing that oleate and chlorophyll associate in colloidal particles, and that this association protects fluorescence from quenching. The oleate-chlorophyll complex can be precipitated from the colloidal solution as a "coacervate" by salting out; the precipitate is fluorescent and birefringent, thus showing a regular arrangement of the molecules. The result of fluorescence experiments was considered by Stern as a decisive evidence that chlorophyll in the cell is dissolved in a lipide. However (as stressed by Hubert, 1936), the absorption peaks of chlorophyll-lipide preparations are situated far on the short-wave side of the absorption peaks of the living cells. This could perhaps be explained simply by a higher pigment concentration in the cell (*cf.* Chapter 21, Vol. II); but other and perhaps more plausible solutions of the dilemma have been suggested. One was to assume that chlorophyll in the cell is divided into two parts—the first responsible for the absorption spectrum, and the second for fluorescence; another to associate each chlorophyll molecule with both a protein—to explain the position of the absorption bands—and a lipide—to explain the capacity for fluorescence.

Noack (1925) was the first to suggest that the larger part of chlorophyll in the cells is in a nonfluorescent (protein-bound) colloidal state, while a smaller part forms a fluorescent solution in a lipide. This suggestion was elaborated by Seybold and Egle (1940), who thought the correct position of the absorption band can be achieved only in *colloidal* systems, while fluorescence can occur only in *molecular solution*. (The fluorescence of some chlorophyll adsorbates was ascribed by them to the presence of lipoid impurities which dissolve a small amount of chlorophyll.) They prepared a model consisting of a gelatin block containing colloidal chlorophyll. The block was covered by an evaporated layer of a chlorophyll solution in lecithin-containing ether. This block showed an absorption maximum at 680 $m\mu$ characteristic of colloidal chlorophyll, and had a fluorescent surface layer.

However, there is one drawback to this concept of chlorophyll divided between a fluorescent and a nonfluorescent phase: *the fluorescence band of chlorophyll in the cell is shifted to the red by about the same amount*

as the absorption band (cf. Chapter 23, Vol. II). Seybold and Egle suggested that the chlorophyll solution in lecithin may have its absorption band in a position (668 $m\mu$) typical of true solutions but its fluorescence band in a position typical of living cells (*i. e.*, close to 680 $m\mu$); but this suggestion was based on insufficient evidence and is not very plausible. Probably, the same chlorophyll molecules account for both absorption and fluorescence *in vivo*. The "dualistic" theory of Noack and of Seybold and Egle also fails to give a simple explanation of the effect of heat on leaf fluorescence. The latter disappears upon short immersion into boiling water and re-appears after several minutes (Vol. II, Chapter 24). A plausible explanation of this phenomenon is that a weakly fluorescent chlorophyll-protein complex is decomposed by denaturation of the protein, with the chlorophyll first left in a nonfluorescent colloidal form, and then slowly passing into solution in the molten lipides, and thus becoming fluorescent again. Similarly, the disappearance of fluorescence upon drying is most conveniently explained by an influence of drying on the proteinaceous phase. (Seybold and Egle suggested that dried proteins attract chlorophyll from the lipid solution—an hypothesis which does not appear particularly plausible.)

It thus seems as if the weak fluorescence of chlorophyll *in vivo* must be attributed, not to chlorophyll freely dissolved in a lipid phase, but to chlorophyll bound in a complex to a protein.

Hubert (1936) suggested that a chlorophyll adsorbate on protein may become fluorescent if the hydrophobic end of the pigment molecule is protected by a lipide. Singh and Anantha Rao (1942) observed that the fluorescence of chloroplasts can be destroyed by trypsin as well as by lipase, thus indicating that the fluorescent state is brought about by the association of chlorophyll with both proteins and lipides.

In Hubert's chloroplast model, represented in figure 46, layers of protein carry rows of adsorbed chlorophyll molecules with their porphyrin rings facing the proteins, while the hydrophobic phytol tails of the chlorophyll molecules are attached to the equally hydrophobic molecules of lipides. Hubert's model accounts satisfactorily for the optical properties of chloroplasts (pp. 365 *et seq.*), but it remains highly speculative. We have found above that the concentration of phospholipides in chloroplasts often is insufficient for the role ascribed to them by Hubert. According to table 14.V, one must assume that fats, at least, must participate in the formation of the lipide layer together with the phospholipides. Hubert's assumption that the carotenoids are associated only with the lipid constituents of the chloroplasts also appears to be incorrect (cf. Menke 1940).

In the Hubert model, all chlorophyll molecules are assumed to be in the same state, except perhaps those situated in the outer layers of the grana, in contact with the

stroma. If a granum consists of 20-30 pigment layers, only 5% of chlorophyll can be contained in these surface layers (10% if we assume the chlorophyll molecules in the surface layers to stand "on edge," instead of the inclined position they assume in monolayers; cf. page 449). These chlorophyll molecules may be bound to the proteins in the stroma and remain attached to them when the grana are disintegrated by aqueous lipophilic solvents. This may account for the observation of Neish (1939¹), who found that the greater part of chlorophyll can be extracted from the "chloroplast matter" by means of 85% acetone, but that some chlorophyll remains in the precipitate and can be dissolved in acetone only after a preliminary extraction with 10% trichloroacetic acid.

Attempts have been made to prepare artificial protein-pigment-lipide "sandwiches" of the type postulated by Hubert. According to Stenhagen and Rideal (1939), porphyrins react specifically with protein monolayers ("tanning" them) and penetrate lipide monolayers by a weaker and less specific interaction between the hydrophobic parts of the interacting molecules. Studies of chlorophyll films on globin from ox blood and phospholipides (commercial ovoidlecithin and plancitin) were made by Nicolai and Weurman (1938). Globin was found to provide a good basis for chlorophyll deposition; alternative chlorophyll-lecithin layers could be formed if chlorophyll was deposited by raising, and not by dipping the supporting frame through the surface film. However, none of the multifilms prepared in this way showed fluorescence, and no birefringence could be detected with films consisting of 180 chlorophyll monolayers.

Bibliography to Chapter 14

Chloroplasts and Chromoplasts

A. Structure of the Chloroplasts

- 1862 Sachs, J., *Botan. Z.*, **20**, 365.
 1881 Pringsheim, N., *Jahrb. wiss. Botan.*, **12**, 288.
 1882 Haberlandt, G., *ibid.*, **13**, 84, 179.
 Engelman, T. W., *Botan. Z.*, **40**, 419.
 1883 Engelman, T. W., *ibid.*, **41**, 1.
 Reinke, J., *ibid.*, **41**, 697, 713, 732.
 Schmitz, G. J. F., *Verhandl. Naturhist. Ver. Rheinland-Westfalen*, **40**.
 Meyer, A., *Das Chlorophyll Korn*. Felix, Leipzig, 1883.
 1884 Tschirch, A., *Morphologie der Chlorophyllkörner*. Parey, Berlin, 1884.
 1885 Schimper, A. F. W., *Jahrb. wiss. Botan.*, **16**, 1.
 1891 Bredow, H., *ibid.*, **22**, 349.
 1903 Timiriazev, C., *Proc. Roy. Soc. London B*, **72**, 424.
 1907 Priestley, J. H., and Irving, A. A., *Ann. Botany*, **21**, 407.
 1912 Meyer, A., *Ber. deut. botan. Ges.*, **35**, 658.
 1913 Liebaltd, E., *Z. Botan.*, **5**, 65.
 1914 Ponomarev, A. P., *Ber. deut. botan. Ges.*, **32**, 483.
 1920 Möbius, M., *ibid.*, **38**, 224.
 1922 Metzner, P., *ibid.*, **40**, 125.
 1923 Lloyd, F. E., *Science*, **58**, 91, 229.

- 1924 Scarath, G. W., *Quart. J. Exptl. Physiol.*, **14**.
- 1926 Zirkle, C., *Am. J. Botany*, **13**, 301, 321.
- 1932 Heitz, E., *Planta*, **18**, 616.
- 1933 Küster, E., *Ber. deut. botan. Ges.*, **51**, 523.
- 1934 Menke, W., *Protoplasma*, **22**, 56.
- 1935 Doutreligne, Soeur J., *Proc. Acad. Sci. Amsterdam*, **38**, 886.
Fritsch, F. E., *The Structure and Reproduction of Algae*. Macmillan, London, 1935.
- 1936 Heitz, E., *Ber. deut. botan. Ges.*, **54**, 362.
Heitz, E., *Planta*, **26**, 134.
Hubert, B., *Rec. trav. botan. néerland.*, **32**, 323. *wavy*
Küster, E., *Z. wiss. Mikroskop.*, **202**, 677.
Weber, F., *Protoplasma*, **26**, 312.
Weber, F., *Z. Mikrochem.*, *Molisch Festschrift*, p. 447.
Weber, F., *Protoplasma*, **27**, 280, 460.
Wieler, A., *ibid.*, **26**, 295.
Weier, E., *Am. J. Botany*, **23**, 645.
Strugger, S., *Flora*, **31**, 113, 324.
- 1937 Geitler, L., *Planta*, **26**, 463.
Baas-Becking, L. G. M., and Hanson, E. A., *Proc. Acad. Sci. Amsterdam*, **40**, 752.
Hygen, G., *Planta*, **27**, 378.
Dischendorfer, O., *Protoplasma*, **28**, 516.
Metzner, P., lecture quoted by Frey-Wyssling, *cf.* below under 1938.
Schmidt, W. J., *Die Doppelbrechung von Karyoplasma, Zytoplasma and Metaplasma*. Bornträger, Berlin, 1937.
Frey-Wyssling, A., *Protoplasma*, **29**, 279.
Weber, F., *ibid.*, **29**, 427.
- 1938 Weier, E., *Am. J. Botany*, **25**, 501.
Weier, E., *Botan. Rev.*, **4**, 497.
Frey-Wyssling, A., *Submikroskopische Morphologie des Protoplasmas und seiner Derivate*. Springer, Berlin, 1938.
Beauverie, J., *Rev. cytol. cytophys. végét.*, **3**, 80.
Menke, W., *Kolloid-Z.*, **85**, 256.
Granick, S., *Am. J. Botany*, **25**, 558, 561.
Menke, W., and Küster, J. H., *Protoplasma*, **30**, 283.
Chodat, F., *Compt. rend. soc. phys. hist. nat. Genève*, **55**, 112.
Mommaerts, W. F. H., *Proc. Acad. Sci. Amsterdam*, **41**, 896.
Pekarek, J., *Protoplasma*, **30**, 534.
- 1939 Hanson, E. A., *Rec. trav. botan. néerland.*, **36**, 180.
Meyer, B. S., and Anderson, D. B., *Plant Physiology*. D. Van Nostrand, New York, p. 157.
Neish, A. C., *Biochem. J.*, **33**, 293, 300.
Menke, W., and Koydl, U., *Naturwissenschaften*, **27**, 29.
- 1940 Roberts, E. A., *Bull. Torrey Botan. Club.*, **67**, 535.
Kausche, G. A., and Ruska, H., *Naturwissenschaften*, **28**, 303.
Menke, W., *ibid.*, **28**, 158.

- 1940 Godnev, T. N., and Kalishevich, S. V., *Compt. rend. acad. sci. USSR*, **27**, 832.
 Pirson, A., and Alberts, F., *Protoplasma*, **35**.
 1941 Gessner, F., *Planta*, **32**, 1.
 1942 Roberts, E. A., *Am. J. Botany*, **29**, 165 (Abstract).
 Roberts, E. A., *ibid.*, **29**, 10.
 1943 Bose, S. R., *Botan. Gaz.*, **104**, 633.

B. Composition of the Chloroplasts

- 1913 Willstätter, R., and Stoll, A., *Untersuchungen über das Chlorophyll*.
 Springer, Berlin, 1913.
 1914 Moore, B., *Proc. Roy. Soc. London B*, **87**, 556.
 1917 Meyer, A., *Ber. deut. botan. Ges.*, **35**, 658.
 1924 Chibnall, A. C., *J. Biol. Chem.*, **61**, 303.
 1925 Colin, H., and Grandsire, A., *Compt. rend.*, **181**, 133.
 1927 Channon, H. J., and Chibnall, A. C., *Biochem. J.*, **21**, 1112.
 1928 Lubimenko, V., *Rev. gen. botan.*, **40**, 146, 415, 486.
 1929 Chibnall, A. C., and Channon, H. J., *Biochem. J.*, **23**, 176.
 Schumacher, W., *Jahrb. wiss. Botan.*, **70**, 383.
 1930 Meyer, H., *Planta*, **11**, 294.
 Noack, K., *Z. Botan.*, **23**, 957.
 Griessmeyer, H., *Planta*, **11**, 331.
 1932 Smith, A. M., and Chibnall, A. C., *Biochem. J.*, **26**, 1345.
 1933 Weber, F., *Protoplasma*, **19**, 455.
 1934 Menke, W., *ibid.*, **21**, 279.
 1935 Küster, E., *Ber. deut. botan. Ges.*, **53**, 834.
 Fischer, H., and Schmidt, W., *Ann.*, **519**, 249.
 1936 Hubert, B., *Rec. trav. botan. néerland.*, **32**, 323.
 Burr, G. O., *Proc. Roy. Soc. London B*, **120**, 42.
 1937 Frey-Wyssling, A., *Protoplasma*, **29**, 279.
 1938 Frey-Wyssling, A., *Submikroskopische Morphologie des Protoplasmas*.
 Springer, Berlin, 1938.
 Wieler, A., *Jahrb. wiss. Botan.*, **86**, 387.
 Menke, W., *Z. physiol. Chem.*, **257**, 43.
 Menke, W., *Kolloid-Z.*, **85**, 256.
 Menke, W., *Z. wiss. Botan.*, **32**, 273.
 Mommaerts, W. F. H., *Proc. Acad. Sci. Amsterdam*, **41**, 896.
 Granick, S., *Am. J. Botany*, **25**, 558.
 Granick, S., *ibid.*, **25**, 561.
 Lugg, J. W. H., *Biochem. J.*, **32**, 2114, 2123.
 1939 Neish, A. C., *ibid.*, **33**, 293.
 Neish, A. C., *ibid.*, **33**, 300.
 Chibnall, A. C., *Protein Metabolism in the Plant*. Yale Univ. Press,
 New Haven, and H. Milford, Oxford Univ. Press, London, 1939.
 Katz, E., and Wassink, E. C., *Enzymologia*, **7**, 97.
 Lugg, J. W. H., *Biochem. J.*, **33**, 10.
 Tristram, G. R., *ibid.*, **33**, 1271.

- 1940 Lugg, J. W. H., *Biochem. J.*, **34**, 1549.
 Mommaerts, W. F. H., *Proc. Acad. Sci. Amsterdam*, **43**, 1044.
 Krossing, G., *Biochem. Z.*, **305**, 359.
 Menke, W., *Z. physiol. Chem.*, **263**, 100, 104.
 Javillier, M., and Goudchaux, S., *Ann. agron.*, **10**, 9.
- 1941 Smith, A. M., and Wang, T., *Biochem. J.*, **35**, 404.
 Hanson, E. A., Barrien, B. S., and Wood, J. G., *Australian J. Exptl. Biol. Med. Sci.*, **19**, 231.
 Noack, K., and Liebich, H., *Naturwissenschaften*, **29**, 302.
 Hanson, E. A., *ibid.*, **19**, 157.
 Hill, R., and Lehmann, H., *Biochem. J.*, **35**, 1190.
- 1942 Bot, G. M., *Chronica Botan.*, **7**, 66.
 Comar, C. L., *Botan. Gaz.*, **104**, 122.
- 1943 Galston, A. W., *Am. J. Botany*, **30**, 331.

C. State of Pigments in the Chloroplasts

- 1886 Reinke, J., *Botan. Z.*, **44**, 241.
- 1912 Herlitzka, A., *Biochem. Z.*, **38**, 321.
- 1913 Liebaltd, E., *Z. Botan.*, **5**, 65.
- 1918 Willstätter, R., and Stoll, A., *Untersuchungen über die Assimilation der Kohlensäure*. Springer, Berlin, 1918.
- 1920 Stern, K., *Ber. deut. botan. Ges.*, **38**, 28.
- 1921 Stern, K., *Z. Botan.*, **13**, 193.
 Lubimenko, V., *Compt. rend.*, **173**, 365.
- 1922 Eisler, M., and Portheim, L., *Biochem. Z.*, **130**, 497.
- 1923 Eisler, M., and Portheim, L., *ibid.*, **135**, 293.
- 1925 Levy, R., Tessier, G., and Wurmser, R., *Ann. physiol. physicochim. biol.*, **1**, 298.
 Noack, K., *Z. Botan.*, **17**, 481.
- 1926 Zirkle, C., *Am. J. Botany*, **13**, 301, 321.
- 1927 Lubimenko, V., *Rev. gén. botan.*, **39**, 619.
 Noack, K., *Biochem. Z.*, **183**, 135.
- 1930 Mestre, H., *Contrib. Marine Biol. Stanford Univ.*, **1930**, p. 170.
- 1931 Hilpert, S., Hofmeier, H., and Wolner, A., *Ber. deut. chem. Ges.*, **64**, 2570.
- 1935 Wakkie, J. G., *Proc. Acad. Sci. Amsterdam*, **38**, 1082.
- 1936 Hubert, B., *Réc. trav. botan. néerland.*, **32**, 323.
 Stoll, A., *Naturwissenschaften*, **24**, 1.
- 1938 Menke, W., *Kolloid-Z.*, **85**, 256.
 Menke, W., *Z. Botan.*, **32**, 273.
 Stoll, A., and Wiedemann, E., *Atti Congr. intern. Chim., 10th Congr., Rome, 1938; Chim. ind. agr. biol.*, **16**, 356.
 Stoll, A., and Wiedemann, E., *Fortschritte der Chemie organischer Naturverbindungen*, **1**, 159.
 French, C. S., *Science*, **88**, 60.
 Frey-Wyssling, A., *Submikroskopische Morphologie des Protoplasmas und seiner Derivate*. Springer, Berlin, 1938.

- 1938 Smith, E. L., *Science*, **88**, 170.
Price, W. C., and Wyckoff, R. W. G., *Nature*, **141**, 685.
Loring, H. S., Osborn, H. T., and Wyckoff, R. W. G., *Proc. Soc. Exptl. Biol. Med.*, **38**, 239.
Nicolai, M. F. E., and Weurman, C., *Proc. Acad. Sci. Amsterdam*, **41**, 904.
Granick, S., *Am. J. Botany*, **25**, 561.
Mommaerts, W. F. H., *ibid.*, **41**, 896.
Hanson, A. E., Meeuse, A. J. D., Mommaerts, W. F. H., and Baas-Becking, L. G. M., *Chronica Botan.*, **4**, 104.
- 1939 Neish, A. C., *Biochem. J.*, **33**, 293, 300.
Stenhagen, E., and Rideal, E. K., *ibid.*, **33**, 1591.
Granick, S., *Am. J. Botany*, **25**, 558, 561.
Katz, E., and Wassink, E. C., *Enzymologia*, **7**, 97.
Wassink, E. C., Katz, E., and Dörrestein, R., *ibid.*, **7**, 113.
Inman, O. L., and Crowell, M., *Plant Physiol.*, **14**, 388.
- 1940 French, C. S., *J. Gen. Physiol.*, **23**, 469.
Menke, W., *Naturwissenschaften*, **28**, 31.
Seybold, A., and Egle, K., *Botan. Arch.*, **41**, 578.
Smith, E. L., *Science*, **91**, 199.
Smith, E. L., and Pickels, E. G., *Proc. Natl. Acad. Sci. U. S.*, **26**, 272.
- 1941 Smith, E. L., and Pickels, E. G., *J. Gen. Physiol.*, **24**, 753.
Smith, E. L., *ibid.*, **24**, 565.
Smith, E. L., *ibid.*, **24**, 583.
Anson, M. L., *Science*, **93**, 186.
Hanson, E. A., Barrien, B. S., and Wood, J. G., *Australian J. Exptl. Biol. Med. Sci.*, **19**, 231.
- 1942 Singh, B. N., and Anantha Rao, N. K., *Current Sci.*, **11**, 442.
Fishman, M., and Moyer, L. S., *Science*, **95**, 128.
Fishman, M., and Moyer, L. S., *J. Gen. Physiol.*, **25**, 755.
Bot, G. M., *Chronica Botan.*, **7**, 66.
- 1943 Moyer, L. S., and Fishman, M. M., *Botan. Gaz.*, **104**, 449.



CHAPTER 15

THE PIGMENT SYSTEM

A. GENERAL COMPOSITION *

When pigments are encountered in animal or plant tissues, their presence never fails to attract attention, even though their color may be irrelevant from the point of view of their biochemical function. The deep red color is a striking attribute of blood, which makes it so much more exciting than the colorless lymph—although the capacity of hemoglobin to absorb visible light has no direct bearing on its biological activity, the transportation of oxygen. In photosynthesizing cells, the presence of a colored substance acquires special significance. Knowing that, in these cells, light is converted into chemical energy, we ask: Does this pigment participate in conversion, or is its color, in analogy with the red color of blood, only a coincidence?

The pigment system of photosynthesizing plants is a complex mixture whose analysis presents many difficulties. Extraction disrupts the chemical units, containing the plastid pigments in the natural state, dilutes them with the pigments (which have no relation to photosynthesis) from the vacuoles and cell walls, and allows them to come into contact with cell components which may affect them chemically (*e. g.*, acids and enzymes). The separation of the extracted mixture into its constituents can easily lead to further "denaturation" by contact with air, solvent, or adsorber. Complete separation is made difficult by the fact that the pigment mixture contains isomers or other components which differ only slightly in solubility and chemical properties.

We cannot enter here into details of the methods which have been perfected to overcome these difficulties. The two main procedures are *distribution between immiscible solvents* and *fractional adsorption* on columns of talcum, sugar, urea, or other adsorbing powders ("chromatographic analysis"). The first method was used by Stokes in 1864 in the historic investigation which proved that the pigment of green leaves consists of four major constituents. It has been further developed by Willstätter and Stoll (1913, 1918) and more recently by Schertz (1928), Meyer (1939), and Hanson (1939). Chromatographic analysis, which is

* Bibliography, page 432.

the more rapid and versatile of the two methods, was invented by Tswett in 1906. Several monographs have been devoted to it (*e. g.* Zechmeister and von Chohnoky 1937, and Strain 1942¹). Specific applications of chromatography to plant pigments have been described by Winterstein and Stein (1934), Strain (1938, 1942²), Seybold and Egle (1938), Masood, Siddiqi, and Qureshi (1939), Zscheile and Comar (1941), and Zscheile (1941). Meyer (1939) and Hanson (1939) found that an "allomerization" of chlorophyll (*cf.* page 459) may occur during the chromatographic procedure and therefore suggested that the Willstätter-Stoll "all-liquid" method is preferable to the adsorption method. A simple separation method which combines the use of immiscible solvents with chromatography was described by Spohn (1935).

As mentioned above, great care must be exercised in working with plant pigments in order to avoid decomposition during the separation. Low temperature, neutral adsorbers, rapid working, absence of oxygen and light—all have been recommended by Hanson (1939), Zscheile (1941), and other authors. According to Zscheile, *drying* is to be avoided in the preparation of pure chlorophyll (*cf.* however, Vol. II, Chapter 21). It is particularly dangerous to leave chlorophyll in contact with other plant constituents after the leaves have been killed, since killing breaks down permeability barriers, denatures the proteins, and deprives the pigments of protection which they enjoy in the living cells. Strain and Manning (1942) mention that, after fresh plant material has been left standing in dilute alcohol for a single day, not less than 15 distinct green bands could be observed in the "chromatogram," indicating the presence of as many different transformation products of the two original green pigments.

Without a complete separation of the pigments, their presence and often their relative and absolute concentrations can be determined by a spectrophotometric analysis of the extracts (*cf.* Vol. II, Chapter 21).

A fundamental result of the analytical study of the pigments of green plants and colored algae is the proof of the invariable presence of at least one green pigment.

The importance of green color for the regeneration of foul air by plants was recognized by Ingen-Housz, who, in 1776, wrote (*cf.* page 19) that "this office is not performed by the whole plant, but only by the leaves and the green stalks." (He considered the establishment of this fact as one of his most important achievements.) With the recognition of the role of photosynthesis in the nutrition of plants and animals, the green pigment of leaves (to which the name of chlorophyll, from *χλωρος*, green, was given by Pelletier and Caventou in 1818) appeared as a true "philosopher's stone" of organic synthesis, a veritable "elixir of life" (Dutrochet 1837).

In recent years, attention has been increasingly drawn to the part played in photosynthetic production by marine plants, particularly the microscopic algae of the plankton. The majority of algae are yellow, brown, olive, red, or blue, but not green. On land, too, a few plant species have yellow or red, instead of green, leaves. However, our belief in the importance of the green pigment for photosynthesis is not shaken by these facts because, whenever the pigment system of a "colored" (that is, nongreen) photosynthesizing organism has been analyzed, it has been found to contain chlorophyll. No case of "photosynthesis without chlorophyll" has as yet come to light. Even though light absorbed by other pigments may also be utilized in photosynthesis (*cf.* Vol. II, Chapter 30), this utilization seems to be impossible without the co-operation of chlorophyll.

Yellow, orange, red, or blue "accessory pigments," combined with green chlorophyll, determine the appearance of leaves and algae. Even in *green leaves*, chlorophyll is regularly accompanied by several yellow *carotenoids*, whose presence remains concealed because their absorption bands, situated in the blue and violet part of the spectrum, are blotted out by the near-by absorption bands of the more abundant chlorophyll. The presence of these yellow pigments (for which the name "xanthophyll," from *ξανθος*, yellow, was suggested by Berzelius in 1837) is revealed in autumn when chlorophyll undergoes decomposition into colorless products. The color of the leaves of the "aurea" varieties of certain trees and bushes, which are poor in chlorophyll, is also caused by the carotenoids.

A second group of yellow pigments present in green leaves are the water-soluble *flavones*, contained mainly in the vacuoles (while the carotenoids are associated with chlorophyll in the plastids). In some species, or in certain periods of development, the flavones are supplemented by their oxidation products, the red *anthocyanins*. This brings about the transient red coloration of some young or decaying leaves, as well as the permanent red color of the leaves of the "purpurea" varieties. In contrast to "aurea" leaves, "purpurea" leaves are not necessarily deficient in chlorophyll (addition of a green pigment to a red one does not change the color as strongly as does its addition to a yellow pigment).

Yellow and red leaves form only a few bright spots on the green cover which vegetation spreads in summer over the surface of land. In the sea, olive, brown, and red algae predominate among the vegetation. Their colors are caused by the mixture of chlorophyll with accessory pigments of two types: *carotenoids* and *phycobilins*. Chemically, the carotenoids of the algae are not very different from those of green leaves; but some, particularly the *fucoxanthol* of the *Phaeophyceae* (brown algae)

and *Diatomeae*, absorb some green light transmitted by chlorophyll, and thus change the pure green color of the latter into a dull olive or brown.

The colors of *Rhodophyceae* and *Cyanophyceae* are brought about by mixtures of chlorophyll with *phycobilins*, so called because of their similarity to the bile pigments (*e. g.*, bilirubin). They have absorption maxima in the middle of the visible spectrum—in green and yellow—between the two main absorption bands of chlorophyll. This explains why many of these organisms show a vivid red color (*Florideae*), while others are purple or blue (*Cyanophyceae*).

Purple and green bacteria contain green pigments closely related to chlorophyll (bacteriochlorophyll and bacterioviridin) and a large assortment of carotenoids, similar to, but not identical with, the carotenoids of the higher plants and algae.

Of the four types of pigment mentioned above, two—the chlorophylls and the phycobilins—are strongly fluorescent in extracts, and also fluoresce (although much more weakly) in the living cells. The carotenoids and the flavones, on the other hand are usually described as non-fluorescent (*cf.*, however, Vol. II, Chapter 23).

B. THE CHLOROPHYLLS *

1. Chlorophylls *a* and *b* and their Ratio

As early as 1832, Pelletier and Caventou suspected that chlorophyll was a mixture. This hypothesis was proved 32 years later, in 1864, when the physicist Stokes, while investigating the phenomenon of fluorescence, beat the plant chemists to the discovery that both the green and the yellow leaf pigment are mixtures of at least two major constituents. Another 42 years later, Tswett, a botanist, showed chemists how to separate pigment mixtures efficiently. He devised analysis by chromatography and at once put it to practical use, achieving the first separation of the two chlorophyll components of green leaves. Tswett gave to the two green pigments the names of chlorophyll α and β , which later became plain *a* and *b*. Chlorophyll *a* gives blue-green solutions; those of chlorophyll *b* are yellow-green.

Zscheile (1934, 1935) thought that he had found, in the chromatograms from leaf extracts, a third component, "chlorophyll *c*," with properties intermediate between those of *a* and *b*. His conclusions were, however, criticized by Winterstein and Schön (1934) and Mackinney (1938); and Zscheile himself later (1941) agreed that the adsorption layer attributed to chlorophyll *b* was due to pheophytin (*cf.* Chapter 21, Vol. II).

Willstätter and Stoll (1913) proclaimed the identity of chlorophylls *a* and *b* in all green plants, in contrast to earlier authors who believed that

* Bibliography, page 432.

different kinds of chlorophyll may be prepared from different species. Willstätter and Stoll obtained their proof with *extracted* chlorophylls, and thus left the possibility open that different chlorophyll-bearing colloidal systems may exist in various species (*cf.* Chapter 14, page 388).

Strain and Manning (1942) found, in the chromatograms of extracts from the higher green plants and algae, "companion bands" to the bands of chlorophylls *a* and *b*, which they attributed to two new isomeric forms, *a'* and *b'*. Their spectra were very similar to those of the ordinary forms *a* and *b*, and they appeared to be reversibly convertible into the "old" chlorophylls. In a propanol solution at 95–100° C., 80% of the old isomers were in an apparent equilibrium with 20% of the new ones. Rapid extraction at low temperature (– 80° C.) gave no trace of isomers *a'* and *b'*; it is thus possible that they do not exist as such in nature, but are formed from *a* and *b* during the extraction at ordinary temperature. On the other hand, the ease with which the old isomers could be converted into the new ones *in vitro* argues for their presence in the living plants, particularly at the higher temperatures.

Inman and Blakeslee (1938) found that the absorption spectrum of the chlorophyll extract from an x-ray mutant of *Datura* was different from that of ordinary chlorophyll. Apart from this isolated observation, the chlorophyll of all investigated *higher land plants* has been found to consist of the same two components—the blue-green component *a* and the yellow-green component *b*. As shown by table 15.I (page 409), the ratio of [a]:[b] is remarkably constant, varying for most normal leaves between 2.5 and 3.5. Limited, but systematic changes in this ratio have been related by Seybold and Egle (1937, 1938) to the "light field" to which individual plants were exposed during growth, or to which the species as a whole has become adapted. The proportion of chlorophyll *b* is larger in "shade plants" than in "sun plants." Most *green algae* behave as extreme shade plants, with the average ratio of [a]:[b] going down to 1.4, while alpine plants represent the extreme sun type, with the average ratio of [a]:[b] rising to 5.5 (*cf.* pages 422–424 and Table 15.VIII, page 423). An abnormally large ratio (about 7) of [a]:[b] was found in the chlorophyll-deficient *aurea* leaves (*cf.* Seybold and Egle 1938).

More recently, Seybold (1941) suggested that the most important factor in the determination of the ratio [a]:[b] is the intensity of primary starch synthesis, rather than light adaptation. This new hypothesis was based on less extensive experimental material than the older adaptation theory (*cf.* page 422). Seybold's assumption that chlorophyll *b* is a specific sensitizer for the polymerization of sugars to starch (rather than for photosynthesis proper) appears highly improbable. Whether the correlation of chlorophyll *b* content with starch production

is, nevertheless, correct, and if so, whether this effect is related to, or independent of, the sun or shade character of the plants, remains to be seen.

The hypothesis of Smith (*cf.* page 389) that the two chlorophylls are parts of a stoichiometric complex, in which three molecules of chlorophyll *a* are associated with one molecule of chlorophyll *b*, finds no support in analytical data.

2. Protochlorophyll

Seeds and etiolated plantules (*i. e.* seedlings of the higher plants sprouted in darkness) are sometimes faintly green, although they contain no chlorophyll. They begin to turn green immediately upon exposure to light; and it has been assumed that the pale green substance contained in them is a "chlorophyll precursor" capable of rapid conversion into chlorophyll. Monteverde (1893) prepared alcoholic extracts of this compound and called it *protochlorophyll*. The best known source of protochlorophyll is pumpkin seeds. Noack and Kiessling (1929, 1930, 1931) proved its chemical similarity to chlorophyll (the presence of magnesium and phytol). Seybold (1937) obtained from squash seeds two chromatographic fractions, one bluish-green and one pure green, and he interpreted these as the protochlorophylls *a* and *b*. Fischer, Mittenzwei, and Oestreicher (1939) prepared, by partial synthesis, a crystallized compound which proved to be identical with a derivative of natural protochlorophyll. Fischer was thus able to identify protochlorophyll as an *oxidation product* of chlorophyll differing from it only by two hydrogen atoms (*cf.* page 445).

This result is significant for speculations as to the role of protochlorophyll in nature. Preisser assumed, as early as 1844, that chlorophyll is formed in young plants by the *oxidation* of a precursor; and this concept has been further developed by Monteverde and Lubimenko (1911, 1913) and Lubimenko (1927, 1928). The realization that protochlorophyll is an *oxidation product* of chlorophyll eliminates it, according to this theory, as a chlorophyll precursor. Lubimenko had postulated, as early as 1928, that protochlorophyll is not a precursor of chlorophyll, but a by-product of its synthesis, for which he suggested the following scheme:

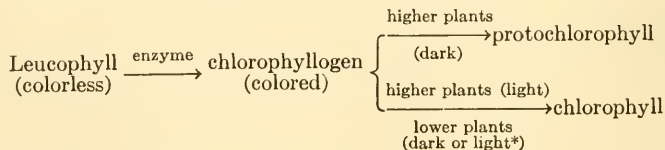

According to this scheme, protochlorophyll is formed only in the dark, when chlorophyllogen cannot be converted into chlorophyll.

* See page 430.

On the other hand, Noack and Kiessling (1929, 1930, 1931) and Scharfnagel (1931), among others, thought that protochlorophyll is converted by illumination into chlorophyll. If this is correct, the last stage of chlorophyll formation is a *reduction* rather than an oxidation—which is possible in itself, but incompatible with the Preisser-Lubimenko theory.

The existence of "leucophyll" and "chlorophyllogen," included in the scheme of Lubimenko and Monteverde, is a matter of speculation. The whole problem of chlorophyll development in seedlings certainly is in need of renewed analytical study.

3. The Chlorophylls of the Algae

It was mentioned above that green algae behave as extreme shadow plants, with an exceptionally large proportion of chlorophyll *b* (cf. Table 15.II, page 410). "Colored" algae normally live in much deeper water than the green algae, and could thus be expected to contain even more chlorophyll *b*. Instead, no chlorophyll *b* is found in them at all. Willstätter and Page (1914) left the possibility open that *brown algae* may contain a little (less than 5%) of chlorophyll *b*; but Fischer and Breitner (1936), Seybold and Egle (1938), Montfort (1940), Seybold, Egle and Hülsbruch (1941) and Strain and Manning (1942¹) lowered this limit to less than 1%. They also extended the experimental proof of the absence of chlorophyll *b* to *diatoms*, *red algae* and *blue algae*. Pace (1941) asserted recently that diatoms may contain up to 10% of the *b* component, but Strain and Manning (1942¹) attributed his results to a confusion with chlorofucin or "chlorophyll *c*," whose existence will be discussed further below. The deficiency of chlorophyll *b* is easily shown, according to Wilschke (1914) and Dhéré and Fontaine (1931), by the absence of its band in the fluorescence spectrum of brown algae (cf. Vol. II, Chapter 24).

Seybold and Egle (1937), Montfort (1940) and Seybold, Egle, and Hülsbruch (1941) found that the fresh-water alga, *Vaucheria*, although green, also contains no chlorophyll *b* at all. Seybold and coworkers saw in this an argument in favor of reclassification of this alga (as a *Heterocontae* rather than *Chlorophyceae*); they suggested that all *Heterocontae* may be devoid of chlorophyll *b*. The same authors found that some *Flagellatae* (e. g., *Volvox* and *Chlamydomonas*) contain components *a* and *b* in normal proportions, while others (e. g., *Euglena viridis*) contain only a very small amount (< 3%) of chlorophyll *b*, or none at all (e. g., *Peridinium tabulatum*).

Seybold, Egle, and Hülsbruch suggested that plants may be divided into two large classes: "*a* plants" and "*a + b* plants." The division may have first occurred at the level of the *Flagellatae*, since some of

these unicellular organisms belong to the first and some to the second class. *Heterocontae*, *Phaeophyceae*, *Rhodophyceae*, *Cyanophyceae*, and *Diatomeae* may be descendants of the first group of the flagellates, while *Chlorophyceae* and all the higher green plants may be genetically related to the second group.

Seybold (1941) noticed that green algae deficient in chlorophyll *b* do not form starch as a direct assimilation product. *Vaucheria*, for example, is known to store *oil* and not starch. A review of other algal classes showed no direct contradictions to this rule. (Whenever starch was found in *b*-deficient colored algae, it could be interpreted, according to Seybold, as a "secondary" product.) Seybold suggested that only chlorophyll *a* participates in the synthesis of sugar, while chlorophyll *b* is a specific sensitizer for starch synthesis, a suggestion with which few will agree.

It has been asserted that at least some (and perhaps all) *b*-deficient colored algae contain another chlorophyll component, designated as "chlorofucin" by Sorby, and "chlorophyll γ " by Tswett. (Since the nonexistence of a third chlorophyll component in leaves has now been agreed upon, this compound may also be designated without ambiguity as "chlorophyll *c*.") The "third chlorophyll" was first observed by Stokes in 1864 in extracts from brown algae, and its presence was later confirmed by Sorby (1873) and Tswett (1906). Willstätter and Page (1914) asserted, however, that it occurs only in extracts from algal material which has been kept in storage—even if for only a short time—and suggested that it is a decomposition product of chlorophyll *a*. Wilschke (1914) and Dhéré and Fontaine (1931) found, in extracts from the brown alga *Fucus*, an *absorption band* at 631 $m\mu$, which could not be attributed to either chlorophyll *a* or *b*. A similar result was obtained by Bachrach and Dhéré (1931) with extracts from the diatom, *Navicula*. Dhéré and Fontaine also found an extra band in the *fluorescence spectrum* of extracts from brown algae, even fresh ones, but this band was not observed by Dhéré and Raffy (1935) in living algae. This caused Dhéré to agree with Willstätter's hypothesis that "chlorophyll *c*" is a *post-mortem* product. However, this concept was challenged by Strain and Manning (1942¹), who found that the absorption spectra of extracts from diatoms (*Nitzschia closterium*) and brown algae (*Fucus furcatus* and eight other species), prepared in many different ways, always show the same deviation from the absorption spectrum of pure chlorophyll *a*. The component responsible for this change was obtained in the pure state by chromatographic separation, and proved to be a pale green pigment with an absorption spectrum similar to that given by Tswett for "chlorophyll γ " and a fluorescence spectrum similar to that reported for chlorofucin by Wilschke and Dhéré and Fontaine. It is not identical

with any one of the numerous transformation and decomposition products of chlorophyll *a* which can be separated by chromatographic methods.

The same pigment also was found by Strain, Manning, and Hardin (1943) in a dinoflagellate (*Peridinium cinctum*). Strain and Manning concluded that chlorofucin is a normal component of at least three major classes of algae (*Phaeophyceae*, *Diatomeae*, *Flagellatae*) and perhaps serves as a substitute for chlorophyll *b*. The proportion of "chlorophyll *c*" has not been determined, but it appears from the published absorption curves that it cannot exceed 10% of the total quantity of chlorophyll.

Chlorophyll *c* is not found in red algae, which contain, however, according to Manning and Strain (1943), still another pigment, a "chlorophyll *d*," characterized by an absorption band far in the red, at 696 μ (in methanol). An isomeric form, *d'*, of this pigment also was found.*

4. Bacteriochlorophyll and Bacterioviridin

The green pigments of sulfur bacteria, *bacterioviridin* and *bacteriochlorophyll*, are close relatives of the chlorophylls of the higher plants and algae. Bacterioviridin is as yet almost unknown; but bacteriochlorophyll has been much studied recently. Fischer and coworkers (*cf.* Fischer 1940) found only one component of this pigment whose chemical structure makes it an analogue of chlorophyll *a*. Seybold and Egle (1939) found *three* components in the chromatograms of extracts from *Thiocystis*—a steel-blue "bacteriochlorophyll *a*," a green "bacteriochlorophyll *b*" and a "bacteriochlorophyll *c*"—but held it possible that the "b" and "c" components were secondary products, formed while the pigment was allowed to stand for several hours in methanol solution.

5. Concentration of Chlorophyll in Leaves

The concentration of chlorophyll in leaves and algae can be referred to fresh weight, dry weight, cell volume, or surface. None of these methods is entirely satisfactory. Reference to unit surface, favored in many studies of the leaves of the higher plants, and suitable when a measure of their color density is desired, is inappropriate for algae, especially the unicellular ones. Reference to unit fresh weight, or cell volume, may be deceiving in the case of plants with an abnormally large water content (compare Fig. 48). For plant organs containing a large proportion of colorless tissue, *e. g.*, the fleshy leaves of the succulents, the reference to either fresh or dry weight may give deceptively low figures.

The first determinations of chlorophylls *a* and *b* in a large number of higher plants were carried out by Willstätter and Stoll (1913, 1918); a second extensive study was made by Seybold and Egle (1937, 1938,

* Further details of these new results will be found in Vol. II, Chap. 21.

1939) and Seybold, Egle, and Hülbruch (1941). Table 15.I contains a selection from the results of these investigations. It shows the "normal" concentration of chlorophyll and the "normal" ratio [a]:[b] in plants of different types. Finer differences, which can be interpreted as adaptations to different "light fields," are discussed on pages 422 *et seq.*

Table 15.I shows that the total chlorophyll content of most leaves—with the exception of *aurea* varieties—is of the order of 0.7–1.3% of dry weight (Willstätter and Stoll). This average content does not depend on geographical latitude (Lubimenko 1928), although the range of its

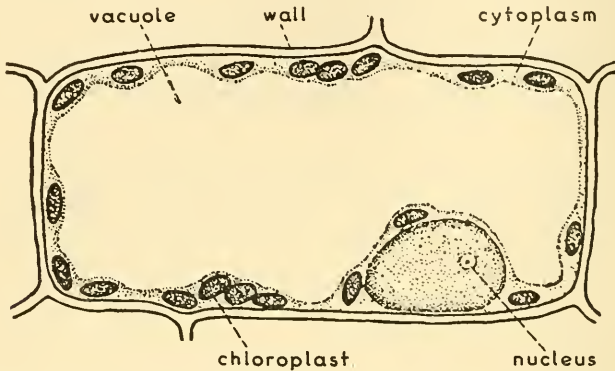

FIG. 48.—Section through a cell of *Elodea*, showing the largest part of it occupied by the vacuole (from Robbins and Rickett 1939). (Courtesy of D. Van Nostrand Company, Inc.)

variations is far larger in the tropics than in moderate zones (*cf.* page 422). Contrary to earlier results of Henrici (1919), alpine plants were found by Seybold and Egle (1939) to contain not less total chlorophyll (referred to unit surface) than plants from the lowlands. The only leaves in table 15.I whose chlorophyll content is a whole order of magnitude smaller than that of all others are those of the *aurea* variety of the elm; the same was found to be true also for other yellow summer leaves investigated by Willstätter and Stoll.

6. Chlorophyll Content of Algae

As shown by table 15.II, earlier investigators (Willstätter and Stoll 1913, and Lubimenko 1925) found that algae are less rich in chlorophyll than land leaves. The appearance of such bright-green algae as *Ulva lactuca* does not support this conclusion. Newer studies of Seybold and Egle failed to confirm it; they found the content of most algae in chlorophyll to be similar to that of green plants, that is, 0.5–1.5% of the dry weight. Unicellular green algae (*e. g.*, *Chlorella*) may contain up to 4 or 5% chlorophyll (*cf.* below). Seybold and Egle (1938) suggested that

TABLE 15.I
CHLOROPHYLL CONTENT OF LAND PLANTS

Species	Per cent of dry weight				Source*			
	[a] + [b]	[a]	[b]	[a] : [b]				
<i>Sambucus nigra</i>								
Sun leaves	0.80	0.58	0.22	2.6	W.S. (1913)			
Shade leaves	1.18	0.79	0.39	2.0	W.S. (1913)			
<i>Platanus acerifolia</i>								
Sun leaves	0.68	0.53	0.15	3.5	W.S. (1913)			
Shade leaves	1.12	0.85	0.27	3.2	W.S. (1913)			
<i>Laurus nobilis</i>								
New, light leaves	0.41				W.S. (1918)			
Last year dark leaves	0.43				W.S. (1918)			
<i>Ulmus</i>								
Ordinary leaves	0.56				W.S. (1918)			
Aurea leaves	0.05				W.S. (1918)			
<i>Pelargonium zonale</i> leaves	1.30				W.S. (1918)			
<i>Helianthus annuus</i> leaves	1.27				W.S. (1918)			
<i>Ailanthus glandulosa</i> leaves	1.31				L. (1928)			
<i>Pinus</i> needles	0.26	0.19	0.07	2.7	W.S. (1913)			
Grass blades	0.67	0.46	0.21	2.2	W.S. (1913)			
	[a] + [b] % of fresh weight							
	Maximum		Minimum		Average			
200 spp., Northern Russia (60° N)	0.38		0.10		0.24	L. (1928)		
200 spp., Crimea (45° N)	0.48		0.10		0.25	L. (1928)		
200 spp., Java (6° S)	0.79		0.09		0.27	L. (1928)		
	Mg. per 100 cm. ²							
	[a]			[b]			[a] : [b] av.	
	Max.	Min.	Av.	Max.	Min.	Av.		
6 alpine spp.	3.0	4.4	3.6	0.47	1.05	0.74	5.1	S.E. (1939)
7 lowland spp.	2.6	5.5	3.8	0.70	1.6	1.07	3.6	S.E. (1939)

* W.S. = Willstätter and Stoll; L. = Lubimenko; S.E. = Seybold and Egle.

the low figures of Willstätter and Page may have been due to the rapid decomposition of chlorophyll in algae which were not freshly gathered.

Lubimenko (1925) found that the concentration of chlorophyll is especially low in red marine algae from great depths (*e. g.*, 40 meters), while the concentration of the red pigment (phycoerythrin) increases with depth (*cf.* Table 15.VII, page 421). Seybold and Egle found a

TABLE 15.II
CHLOROPHYLL CONTENT OF ALGAE

A. GREEN ALGAE (<i>Chlorophyceae</i>)					
Species	Per cent of dry weight			[a] : [b]	Source ^a
	[a] + [b]	[a]	[b]		
<i>Ulva lactuca</i>	0.16	0.09	0.07	1.3	W.S. (1913)
<i>Ulva lactuca</i>	0.21				L. (1928)
<i>Codium tomentosum</i>	0.32			2.2	L. (1928)
<i>Ulva lactuca</i>	0.48	0.33	0.15		S.E. (1938)
<i>Chaetomorpha melagonium</i>	1.53				S.E. (1938)
<i>Chlorella vulgaris</i>					
Strong light	1.8				W.N. (1922)
Weak light	4.0				W.N. (1922)
<i>Chlorella pyrenoidosa</i>					
Strong light	2.7				N.E. (1939)
Weak light	4.9				N.E. (1939)
Strong light	0.4 ^b				E.A. (1932)
Weak light	1.7 ^b				E.A. (1932)
<i>Chlorella pyrenoidosa</i>	2.55	2.00	0.55	3.6	H. (1942)

B. BROWN ALGAE (*Phaeophyceae*)
Only chlorophyll *a*

Species	Per cent of dry weight	Source	Species	Per cent of dry weight	Source ^a
<i>Fucus serratus</i>	0.17	W.S. (1913)	<i>Fucus serratus</i>	0.45	S.E. (1938)
<i>Laminaria</i>	0.19	W.S. (1913)	<i>Laminaria</i>	0.23	S.E. (1938)
<i>Dictyota fasciola</i>	0.13	L. (1928)	<i>Dictyota dichotoma</i>	0.78	S.E. (1938)
<i>Padina pavonia</i>	0.26	L. (1928)			

C. RED ALGAE (*Rhodophyceae*)
Only chlorophyll *a*

Species	Per cent of dry weight	Source	Species	Per cent of dry weight	Source ^a
<i>Corallina mediterranea</i> (surface)	0.17	L. (1925)	<i>Phyllophora palmettoides</i> (in 40 m. depth)	0.05	L. (1925)
<i>Jama rubens</i> (surface)	0.15	L. (1925)	(in 51 m. depth)	0.07	L. (1925)
<i>Gelidium corneum</i> (grotto)	0.11	L. (1925)	<i>Phyllophora rubens</i>	0.15	L. (1928)
<i>Plocamium coccineum</i> (grotto)	0.06	L. (1925)	<i>Laurentia coronopus</i>	0.03	L. (1928)
			<i>Porphyra laciniata</i>	0.44	S.E. (1938)

TABLE 15.II—Continued

D. BLUE-GREEN ALGAE (<i>Cyanophyceae</i>)		
Only chlorophyll <i>a</i>		
Species	Per cent of dry weight	Source ^a
<i>Gloeocapsa montana</i>		
Strong light	0.3	Sa. (1940)
Weak light	0.7	Sa. (1940)

^a W. S. = Willstätter and Stoll; L. = Lubimenko; W. N. = Warburg and Negelein; S. E. = Seybold and Egle; N. E. = Noddack and Eichhoff; E. A. = Emerson and Arnold; Sa = Sargent; H. = Haskin.

^b Relative to fresh weight.

considerably higher chlorophyll content in *Porphyra laciniata* than was given by Lubimenko for any of the red algae. It remains to be seen whether the decrease in chlorophyll concentration with increasing depth, asserted by Lubimenko, will be confirmed by new analyses.

7. Chlorophyll Concentration in Single Cells and Chloroplasts

The highest chlorophyll concentrations (up to 1.7% of fresh weight and 5% of dry weight) have been found in the unicellular green alga, *Chlorella*, particularly in cultures grown in weak light. This must be due to the absence of "dilution" by colorless cells and structures, which is inevitable in multicellular organisms. (The concentration of chlorophyll in single palisade cells of green leaves may be as high as in *Chlorella*.)

The concentration of chlorophyll *within the chloroplasts* must be two or three times higher than in the cell as a whole. In the case of *Chlorella*, it should reach 10–15% of the *dry* weight. Several empirical estimates of this quantity have been attempted. Von Euler, Bergman, and Hellström (1934) calculated that 1.7×10^9 molecules of chlorophyll are present in a single chloroplast of *Elodea densa*; this corresponds to a concentration of about 0.1 mole per liter, or about 10% relative to the *fresh* weight of the chloroplast.

Godnev and Kalishevich (1940) found that a leaf of *Mnium* contained an average of 2.4×10^{-12} g. or 1.3×10^9 molecules of chlorophyll in each chloroplast. Since the volume of an average chloroplast of *Mnium* is 4.1×10^{-11} ml., the concentration of chlorophyll in it is 0.065 mole per liter, or about 5.8% of the fresh weight of the chloroplasts.

Other estimates have been derived from the analysis of the "chloroplastic matter" isolated by methods described in chapter 14. Granick (1938) found as much as 16% chlorophyll (relative to dry weight) in the chloroplastic matter from spinach. The results of other analyses were somewhat smaller. Menke (1940) found between 7.6 and 8.3% chlorophyll in the centrifuged chloroplast fraction from spinach leaves, and 5.3

to 6.4% in the precipitated "chloroplastic matter"—which he therefore considered as contaminated by 15% cytoplasm (*cf.* page 369). Smith's analysis (1941) of the same material gave 8% chlorophyll, while Bot (1942) found only 4 to 6% chlorophyll in the dry chloroplastic matter from *Lathyrus* and *Spinacia*.

If all chlorophyll is concentrated in the grana, its concentration there must be about twice that in the chloroplast as a whole, and five or six times that in the whole cell, *i. e.*, 10–30% of the dry weight, or 0.06–0.2 moles per liter, depending on whether the average concentration in the dry chloroplastic matter is 5 or 15%. The bearing of these figures on the problem of the state of chlorophyll in the chloroplasts was discussed in chapter 14 (page 390).

C. THE CAROTENOIDS *

Berzelius (1837) made the first attempt to extract the yellow pigment—which he called *xanthophyll*—from autumnal leaves. He considered it at first as a decomposition product of chlorophyll, but found later (1838) that it exists as such also in summer leaves (as was suspected as early as 1827 by Guibourt, Robinet, and Derheim). Confirmations of this fact were given by Frémy (1860) and Stokes (1864), who fractionated the leaf extracts by means of immiscible solvents.

Stokes (1864) recognized that the yellow pigment consists of two main constituents. One of them is called *carotene* because of its identity with the pigment of the carrot. The name *xanthophyll* was retained for the other. Chemical studies have shown that carotene is a carbohydrate which exists in several isomeric forms, while "xanthophyll" is a mixture of several isomeric and homologous alcohols derived from the carotenes. It seems best to call them by the generic name of *carotenols* (*cf.* page 471).

The introduction of chromatographic analysis has been of great help in the separation of carotene and carotenol mixtures. According to Strain (1938), about a dozen of these pigments are regularly present in green leaves, while others are encountered in algae and bacteria.

The first data on the concentration of the carotenoids in plants were obtained by Willstätter and coworkers (*cf.* Willstätter and Stoll 1913, 1918). Some of their results, together with the more recent ones of Seybold and Egle (1938, 1939), are given in table 15.III, which shows the contents in carotene, [c], and carotenols, [x], and the ratios, [x]:[c] and ([a] + [b]):([c] + [x]).

The average ratio of [x]:[c] is between 4 and 6 both in the higher plants and algae (if fucoxanthol is included in the carotenol total).

* Bibliography, page 434.

However, individual variations in this ratio are wider than those in the $[a]:[b]$ ratio. In 24 alpine plants investigated by Seybold and Egle (1939), the $[x]:[c]$ varied between 2 and 15. Even wider variations have been observed in algae. Table 15.III shows, for example, a ratio of 20 for *Laminaria*. Seybold, Egle, and Hülbruch (1941) found

TABLE 15.III
CAROTENOIDS IN PLANTS

Species	Per cent of dry weight			Ratio			Source ^a
				$[x]:[c]$ (mass)	$\frac{[a]+[b]}{[c]+[x]}$		
	[c] + [x]	[c]	[x]		(mass)	(mol.)	
A. LAND PLANTS							
<i>Sambucus nigra</i>							
Sun-exposed leaves	0.147	0.052	0.095	1.8	5.4	3.3	W.S. (1913)
Shade leaves	0.156	0.038	0.118	3.1	7.5	4.6	W.S. (1913)
<i>Aesculus hippocastanum</i>							
Sun-exposed leaves	0.207	0.082	0.125	1.5	4.6	2.8	W.S. (1913)
Shade leaves	0.148	0.037	0.111	3.0	8.0	4.7	W.S. (1913)
<i>Platanus acerifolia</i>							
Sun-exposed leaves	0.135	0.043	0.092	2.1	4.6	2.8	W.S. (1913)
Shade leaves	0.176	0.051	0.125	2.5	6.3	3.3	W.S. (1913)
B. ALGAE							
Green algae (<i>Chlorophyceae</i>)							
<i>Ulva lactuca</i>	0.093	0.016	0.077	5.0	3.1		S.E. (1938)
<i>Chaetomorpha melagonium</i>	0.051	0.014	0.037	2.6	2.6	2.0	W.S. (1913)
<i>Chlorella pyrenoidosa</i>	0.41				3.7		S.E. (1938)
Brown algae (<i>Phaeophyceae</i>)	0.313	0.045	0.268	6.0	7.9	5.4	H. (1942)
<i>Fucus serratus</i>	0.083	0.016	0.067 ^b	4.2	5.4	3.6	S.E. (1938)
<i>Laminaria</i>	0.121	0.031	0.090 ^b	2.9	1.4	0.95	W.S. (1913)
<i>Dictyota dichotoma</i>	0.057	0.008	0.049 ^b	6.1	4.1	2.8	S.E. (1938)
<i>Porphyra laciniata</i>	0.082	0.004	0.078 ^b	19.5	1.5	0.9	W.S. (1913)
<i>Porphyra laciniata</i>	0.191	0.028	0.163 ^b	5.8	4.6	2.7	S.E. (1938)
Red algae (<i>Rhodophyceae</i>)							
<i>Porphyra laciniata</i>	0.129	0.029	0.100 ^c	3.4	3.4	2.1	S.E. (1938)

^a W.S. = Willstätter and Stoll; S.E. = Seybold and Egle; H. = Haskin.

^b Including fucoxanthol.

^c Including phylloredin.

variations between 5 and 50 in 12 green fresh-water algae; in three flagellates, the ratios of $[x]:[c]$ were 5.4, 6.0 and 11.4, respectively; and in seven fresh-water *Rhodophyceae* (some of them green and some brown or reddish), it varied between 3.4 and 8.3.

The ratio of $[\text{total chlorophyll}]:[\text{total carotenoids}]$ also varies over a wide range. In table 15.III, the values for the higher plants are between 4.6 and 8.0. However, the Seybold-Egle (1939) list of 24 alpine plants contains values between 1.6 and 3.7, and the list of seven lowland plants, values from 2.6 to 4.3. The low values (~ 1) of the quotient $([a] + [b]):([c] + [x])$ for "fucoxanthol algae," found by Willstätter and Stoll, were revised by Seybold and Egle (1938) to 4 or 5, in consequence of the larger chlorophyll concentrations which they found in these organisms (*cf.* page 408). The figures given by Seybold, Egle, and Hülsbruch (1941) for 12 fresh-water *Chlorophyceae* varied between 0.5 and 3.5, and those given for seven fresh-water *Rhodophyceae*, from 0.76 to 1.9. On the whole, it seems that the concentration of carotenoids relative to that of chlorophyll is somewhat higher in algae than in land plants; but this rule is by no means general, and the brown color of *Phaeophyceae*, for example, is brought about not so much by a quantitative preponderance of carotenoids as by the spectroscopic difference between the yellow leaf "xanthophylls" and the fucoxanthol, which, although also yellow in solution, appears to be orange in the living cell.

The only known nonchlorotic and nondecaying plants with an abnormally low ratio of $[\text{chlorophyll}]:[\text{carotenoids}]$ are leaves of the *aurea* varieties, which contain about ten times less chlorophyll (and only slightly less carotenoids) than the corresponding green varieties. The ratio $([a] + [b]):([x] + [c])$ in the *aurea* variety of *Sambucus nigra*, for example is only 0.3, as against 4.8 in green leaves of the same species (Willstätter and Stoll 1913). The *aurea* leaves also contain, according to Seybold and Egle (1938), a large excess of carotenols ($[x]:[c] = 7$). Montfort (1936) thought that the pigment relations in brown algae are similar to those in *aurea* leaves, but this similarity disappears if the newer data of Seybold and Egle (1938) are substituted for those of Willstätter and Page (1914).

A certain similarity exists, however, between *aurea* leaves and the yellow autumn leaves—not only in respect to the ratio $([a] + [b]):([x] + [c])$, but also in respect to the specific nature of the most abundant carotenoids. Strain (1938) found that the yellow leaves of *Evonymus japonica* are characterized by a preponderance of zeaxanthol, and that the same is true of yellow autumn leaves, while the main carotenoid constituent of normal summer leaves is luteol. *Chlorotic* pear leaves, on the other hand, have been found by Strain to contain the normal assortment of carotenols.

The carotenes are isomeric hydrocarbons. The most common one in leaves is β -carotene. Mackinney (1935) found it in all of the 59 species he investigated; in 40 of them he also found α -carotene, in concentrations up to one-half that of β -carotene.

TABLE 15.IV
CONCENTRATION OF CAROTENOLS IN RELATIVE UNITS

Carotenol	Formula	Concentration
Luteol	$C_{40}H_{56}O_2$	250
Neoxanthol	?	80
Violaxanthol <i>b</i>	$C_{40}H_{56}O_4$	26
Flavoxanthol <i>c</i>	$C_{40}H_{56}O_3$	22
Flavoxanthol <i>b</i>	$C_{40}H_{56}O_3$	19
Zeaxanthol	$C_{40}H_{56}O_2$	8
Isoluteol	$C_{40}H_{56}O_2$	5

Table 15.IV shows the composition of a typical carotenol mixture from green leaves, as analyzed by Strain (1938). Several bands in Strain's chromatogram remained unidentified, so that the mixture probably contained additional components, in quantities similar to those of violaxanthol. Luteol, although undoubtedly the most common of the leaf carotenols, does not form more than one-half the mixture. In autumnal leaves, the carotenoids undergo changes whose nature is not yet well understood. Shortly before the leaves are shed, zeaxanthol (the pigment of yellow corn) becomes the main component of the carotenol mixture. According to Strain, it is not formed from other carotenoids, but merely survives them because of its greater stability.

The algae contain the same ubiquitous carotenes (α and β) as the higher plants, but often a different assortment of carotenols and other carotene derivatives. After the first survey of the field by Kylin (1927) and Borech (1932), the analysis of algal carotenoids was carried out by Tischer (1936, 1937, 1938) and Heilbron (*cf.* Heilbron and Phipers 1935; Heilbron and Lythgoe 1936; and Carter, Heilbron, and Lythgoe 1940). The last-named authors investigated algae from seven of the eleven main algal classes. Table 15.V is a condensation of their results.

Fucoxanthol, the carotenol pigment most characteristic of *Phaeophyceae*, *Chrysophyceae* and *Bacillariophyceae* (diatoms) also was found in a few green algae (*e. g.*, *Zygnema pectinata*) and red algae (*e. g.*, *Polysiphonia negrescens*), but it has never been discovered in land plants. With these exceptions, the carotenoids of green and red algae are similar to those of the higher plants (that is, they consist mainly of carotene and luteol), while blue-green algae contain at least two carotenoids not

TABLE 15.V
CAROTENOIDS OF THE ALGAE

Algae	Carotene	Myxoxanthol	Xanthophyll (mainly luteol)	Fucoxanthol ¹	Violaxanthol	Flavoxanthol	Myxoxanthophyll
<i>Chlorophyceae</i> (9 sp.)	+		+	+ ²	+ ²		
<i>Xanthophyceae</i> (1 sp.)	+					+	
<i>Bacillariophyceae</i> (diatoms) (1 sp.)	+		+	+			
<i>Chrysophyceae</i> (3 sp.)	+		+	+			
<i>Phaeophyceae</i> (12 sp.)	+		+ ²	+			
<i>Rhodophyceae</i> (15 sp.)	+		+	+ ²			
<i>Myxophyceae</i> (or <i>Cyanophyceae</i>) (3 sp.)	+	+	+				+ ²

¹ Fucoxanthol occurs in several isomeric forms; cf., for example, Strain and Manning (1942).

² Only in a few species.

encountered in other plants. Strain and Manning (1943) found in the diatom *Navicula torquatam*, a new carotene, whose spectrum was similar to that of violaxanthol.*

TABLE 15.VI
CAROTENOLS OF BROWN ALGAE

Species	Per cent of dry weight		[f] : [l]	Source
	Luteol	Fucoxanthol		
<i>Fucus</i>	0.031	0.059	1.8	W.P. (1914)
	0.0084	0.0584	7	S.E. (1938)
<i>Laminaria</i>	0.025	0.053	2.1	W.P. (1914)
	0.0041	0.0448	9	S.E. (1938)
<i>Dictyota</i>	0.0325	0.130	4	S.E. (1938)

Quantitative data are available only for brown algae. Table 15.VI contains figures given by Willstätter and Page (1914) and Seybold and Egle (1938).

In *purple bacteria*, bacteriochlorophyll is accompanied by several carotenoids different from those of the higher plants. Karrer and Solmssen (1935, 1936) have identified in the *Rhodovibrio* two hydrocarbons (flavorhodin and rhodopurpurin) and three oxygen-containing carotenoids—rhodoviolascin, rhodopol and rhodovibrin (cf. p. 473).

* New results of these authors (1944) will be described in Vol. II, Chap. 21.

D. THE PHYCOBILINS *

A water-soluble blue pigment was discovered in blue-green algae by von Eisenbeck in 1836. Seven years later, Kützing (1843) extracted a similar red pigment from red algae and called it *phycoerythrin*, suggesting at the same time the name *phycocyanin* for von Eisenbeck's blue compound. The spectroscopic properties and the (very intense) fluorescence of these pigments were first studied by Schütt (1888). Molisch (1894, 1895) showed that the reactions of the aqueous extracts to heat, alcohol, and salts were those of colloidal protein solutions. The separation of the chromophoric groups from the carrier protein was achieved by Lemberg (1929), who introduced the name "phycobilins" because of the similarity between these chromophores and the bile pigments, *e. g.* bilirubin. Kützing (1843) found that phycoerythrin is present also in the blue-green algae; and this was confirmed by Boresch (1921) and Wille (1922). Similarly, the red algae often contain some phycocyanin. It may be fair to say, therefore, that the two pigments usually occur together (similar to the occurrence of the two chlorophylls, or of carotene and the carotenols). According to Kylin (1931), the *Florideae*, which live below 3-5 meters under the sea, contain only phycoerythrin and are therefore bright red, while those growing nearer to the surface also contain phycocyanin and are therefore brownish, purplish, or violet.

The relation between phycocyanin and phycoerythrin is similar to that between the two chlorophylls and between carotene and carotenol in that one is, according to its formula, an oxidation product of the other. The "oxidized" pigment (phycocyanin) occurs in several varieties, distinguished by their shades—green-blue, blue, purple-blue (Molisch 1906; Kylin 1910, 1911, 1912, 1931) and reminding one of the different carotenols. The "reduced" pigment (phycoerythrin) appears to be the same in red and blue algae, although Kylin (1912) noticed some variations in fluorescence and later (1931) also in the absorption spectra of phycoerythrins from different sources. The identification of the different varieties of the phycobilins is complicated by two facts: In the first place, many observations of allegedly different phycocyanins have been probably due to variable admixtures of phycoerythrin; and, in the second place, changes in the extinction curves of the chromoproteids may be due to variations in the nature of the proteins rather than of the chromophores.

It seems that the occurrence of phycobilins in the plant world is restricted to the two classes of algae mentioned above, the *Rhodophyceae* and *Cyanophyceae*; however, similar pigments are found, according to Lemberg, in fishes, and perhaps also in sponges and bacteria.

* Bibliography, page 435.

Despite the solubility of the chromoproteids in water, which makes their extraction easy (it is sufficient to kill the cells, chemically or mechanically, and allow the pigment to diffuse into distilled water), their purification and separation involves considerable difficulties; and only few data exist as to their absolute concentration in the algae. According to Lemberg (1928), the red alga, *Ceramium rubrum*, in winter, contains 1.9% of pigment (relative to dry weight), one-fourth of which is phycoerythrin. In summer, the content of pigment is 0.9%, with one-third phycoerythrin. Kylin (1910) calculated, for the same species, 0.67% phycoerythrin in April (relative to dry weight after subtraction of ash) and 1.5% in March. Lubimenko (1925) gives the figures in table 15.VII for the ratio of [phycoerythrin]:[chlorophyll] for red algae of different origin.

TABLE 15.VII
PHYCOERYTHRIN-CHLOROPHYLL RATIO (AFTER LUBIMENKO)

Species	Origin	Ratio	Group
<i>Corallina mediterranea</i>	Surface	0.06	I
<i>Corallina mediterranea</i>	0.5 m.	0.10	II
<i>Jama rubens</i>	Surface	0.12	
	0.5 m.	0.13	
<i>Chrysimenia varia</i>	Open air Grotto	0.21	III
<i>Glaicladia furcata</i>		0.24	
<i>Gelidium corneum</i>		0.24	
		0.25	
<i>Peyssonnellia squamania</i>		0.34	IV
<i>Phyllophora palmettoides</i>	40 m.	0.45	V
	51 m.	0.42	
<i>Plocamium coccineum</i>	Grotto	0.66	VI

Lubimenko classified all algae in six groups, with ratios 0.06, 0.12, 0.24, 0.36, 0.42 and 0.66, respectively (Table 15.VII), and stressed the gradual increase in relative proportion of the red pigment with increasing depth of the habitat (*cf.* page 421).

All these determinations indicated that the concentration of the red pigment is of the same order of magnitude as, or even smaller than, that of chlorophyll. According to Lemberg (1928), the chromophore constitutes only 2% by weight of the chromoproteid. Thus, a mass ratio of 1:1 of chlorophyll and phycoerythrin corresponds to a molecular ratio of about 50:1 (assuming that the molecular weight of the chromophores are equal). This predominance of the green pigment seems to be

in contradiction with the relative prominence of the absorption maxima of the two pigments in living algae, as illustrated by a figure in chapter 22 (Vol. II). (This figure refers to *phycocyanin*, rather than phycoerythrin, but the pure red color of many *Florideae* indicates that these algae, too, must contain much more than two molecules of the red pigment for 100 molecules of the green.)

E. INFLUENCE OF EXTERNAL FACTORS*

1. The Adaptation Phenomena

Various external factors may affect the composition of the pigment system. The two kinds of relationship which fall under this heading can be called *phylogenetic* and *ontogenetic*, respectively. On the one hand, the composition of the pigment system of a certain class or species is related to the conditions under which it usually lives. For example, red algae abound in the "blue-green shadow" deep under the sea, whereas green algae predominate near the surface. Species with a high content of chlorophyll prefer shady sites, while species with comparatively pale leaves thrive in direct sunlight. These differences are usually treated as "adaptation phenomena"—it is assumed that each class or species of plants has acquired in its phylogenetic development the pigments which are most suitable for its needs, in particular, for the most efficient absorption of light for photosynthesis.

On the other hand, many plants are capable of individual variations of the pigment system. Unicellular green algae, for example, *Chlorella*, become deep green if grown in dim light, and light green if grown in strong light. Red *Florideae* become olive-brown; or even green, when exposed to direct sunshine. In some cases, these "ontogenetic" adaptations are slow and permanent, in others, they are comparatively rapid and reversible. The most striking case is that of certain blue-green algae which change their color, chameleon-like, in response to variations in the color of light (*cf.* pages 424-427).

The occurrence of similarly rapid changes in the concentration of chlorophyll in the higher plants is a matter of controversy. Willstätter and Stoll (1918) found, in a much quoted experiment, that the chlorophyll concentration and the $[a]:[b]$ ratio remain unchanged after an exposure of leaves to intense light for several hours (*cf.* Table 19.II). It is generally assumed, mainly on the strength of this result, that the pigment system of the higher plants is invariable, except for the periods of rapid growth in spring and decomposition in fall. Recently, however, Bukatsch (1939, 1940) and Wendel (1940) have claimed that large diurnal variations

* Bibliography. page 435.

in the concentration of chlorophyll (doubling or trebling in the course of 2-3 hours!) may occur in many species, particularly those of alpine plants (*e. g.*, *Rumex alpinus*, and *Adenostyles albifrons*). The alpine species showed a minimum of chlorophyll at midday and a maximum in the morning, while lowland plants contained more chlorophyll in the middle of the day. Seybold (1941) doubted the correctness of Bukatsch's measurements because of their contradiction with the above-mentioned result of Willstätter and Stoll. Wendel has denied that such a contradiction exists. He asserted that the "diurnal rhythm" can be observed also if the plants are kept in artificial darkness, so that this phenomenon (if at all real) is not directly related to photosynthesis but represents an example of diurnal periodicity in biochemical processes which defies explanation in terms of simple photochemical effects. (A similar example was encountered in chapter 10, when the periodic acidification of succulents was mentioned; and another will be met in volume II, chapter 26, when dealing with the so-called "midday depression" of photosynthesis).

All adaptation phenomena—whether phylogenetic or ontogenetic—must be based on the effects of external factors on the rates of formation and decomposition of the pigments. The stationary concentration of a pigment—and of any other component of the living cell—is the result of a balance between formative and destructive processes. If a "sun plant" contains less chlorophyll than a "shade plant," this means that, in the first organism, this pigment is formed more slowly (or destroyed more rapidly) than in the second one. However, we know as yet very little about the chemical mechanism by which the pigments are synthesized in the plants (*cf.* page 404) and next to nothing about the mechanism by which they are decomposed. We shall therefore treat the adaptation phenomena from the usual "teleological" point of view, that is, we shall consider that we have "explained" a certain variation in pigmentation if we can point out the advantage to the plant which may accrue from it.

2. Phylogenetic Adaptation of the Pigment System

The concept of phylogenetic adaptation of plants to the prevailing intensity and color of light has its origin in observations of the *vertical distribution of marine algae*, which is characterized by the predominance of the green *Chlorophyceae* in shallow waters and of the red *Florideae* in deep waters, with the brown *Phaeophyceae* in an intermediate position. Engelmann (1883, 1884) attributed this distribution to the adaptation of the algae to the predominant *color* of the light. Sunlight becomes bluish green after passage through several meters of water (*cf.* Vol. II, Chapter 22). Consequently, plants living deep under the sea do not receive much light which could be absorbed by green chlorophyll (or by yellow

carotenoids). Fucoxanthol absorbs at least some green light, while the red phycoerythrin is eminently suitable for the absorption of the spectral region transmitted by thick layers of sea water.

In order to absorb efficiently the light transmitted by the surrounding medium, a pigment must have a color *complementary* to that of the medium. Therefore, Engelmann called this phenomenon *complementary chromatic adaptation*, to distinguish it from mimicry, a chromatic adaptation in which organisms acquire a color which *blends* with the surroundings. Oltmanns (1893, 1905) opposed Engelmann's theory and suggested that the vertical distribution of algae is determined by the *intensity*, rather than by the *color* of the prevailing light. This controversy has continued for 50 years, and extended from the initial problem of algal distribution to two related problems: (a) the participation of phycobilins as sensitizers in photosynthesis (without which the chromatic adaptation of algae would have no *raison d'être*); and (b) the "re-adaptation" of colored algae in artificial light. In this discussion, Gaidukov (1903, 1904, 1906), Boreseh (1919), Harder (1917, 1922, 1923), Ehrke (1932), Seybold (1934), and Montfort (1934, 1936) have supported Engelmann's hypothesis, whereas von Richter (1912) and Sargent (1934), among others, have supported the concept of Oltmanns and denied the reality of chromatic adaptation (and incidentally also the capacity of the phycobilins to serve as sensitizers in photosynthesis).

The discussion of ontogenetic re-adaptation is postponed to the next section of this chapter (page 424), and that of the active participation of phycobilins in photosynthesis—to which a positive answer seems certain—to volume II, chapter 30. As to the original problem, Harder (1923) was probably right in his suggestion that both intensity *and* color of light play a part in the adaptation of algae to deep waters. According to volume II, chapter 22, the light field in a depth of 20 meters is not only free from red and violet radiations, but is also reduced in total intensity by a factor of 20 or more. No wonder that deep sea algae are typical "shade plants," with a high content of pigments, and are susceptible to injury when exposed to direct sunlight. However, the composition of the pigment system of these algae corresponds not only to the low general light intensity, but also to the relative weakness of red and violet rays. The situation is complicated by an interplay of heredity (which tends to impose on the organism a rigid composition of the pigment system) and of the capacity for individual variations, which tends to adjust the pigments of a species or individual to the concrete conditions under which it finds itself. Brown or red algae found on the surface often are almost pure green. According to Lubimenko (1926, 1928), the comparison of red algae of one and the same species found at different levels shows a systematic increase in the concentration of all

pigments with increasing depth—a typical ontogenetic intensity adaptation; while the comparison of species usually found at different levels shows an increase in the ratio of [phycoerythrin]:[chlorophyll] with increasing depth of their habitats—a typical example of phylogenetic chromatic adaptation.

Among *land plants*, intensity adaptation is more important than chromatic adaptation because variations in the intensity of light are more pronounced than those in its spectral composition. Correspondingly, the land plants have not much means to change their color—variations in the ratio of [a]:[b] or of [carotenoids]:[chlorophyll] can cause a minor change in the absorption spectrum of the leaves, but can have no color effects comparable with those caused by phycoeyanin, phycoerythrin, or even fucoxanthol in algae.

The light intensity adaptation of land plants reveals itself in the existence of shade and sun species (“ombrophilic” and “heliophilic” plants). Lubimenko (1905, 1907, 1908, 1928) first pointed out the distinction between these two types, both in the structure of their leaves and in the kinetic properties of their photosynthetic apparatus. Ombrophilic leaves are thinner and their chloroplasts are larger and richer in chlorophyll, so that the average concentration of chlorophyll is higher despite the more numerous chloroplasts of the heliophilic plants. Examples of typical ombrophilic plants are *Aspidistra elatior*, with a chlorophyll content of 0.40% of the fresh weight of the leaves, *Tilia parvifolia* with 0.44%, and *Theobroma cacao* with 0.79%; typical heliophilic plants are *Larix europea* with 0.12%, and *Pinus silvestris* with 0.11% chlorophyll. In table 15.I Lubimenko's figures were quoted for the average chlorophyll content of several hundred species in the tropics, subtropics and temperate zones and the wider spread of the individual values in the tropics was pointed out. Lubimenko ascribed this to the extreme differences in the intensity of illumination to which plants are exposed in direct tropical sunlight and on the floor of the tropical forest.

The pigment systems of plants associated with sun-exposed and sheltered sites were investigated by Harder (1933), Harder, Simonis, and Bode (1938), Seybold and Egle (1937, 1938²), and Egle (1937). These workers found that the leaves of “shade plants” contain not only more total chlorophyll but also relatively more chlorophyll *b*, and interpreted the latter phenomenon as a chromatic adaptation.

It will be shown in volume II, chapter 22 that chlorophyll *b* can improve the utilization of light between 450 and 480 m μ ; light of these wave lengths is comparatively abundant in the “blue-green shade” of overhanging foliage. Egle (1937) called chlorophyll *b* “the typical shadow pigment.” Seybold and Egle (1938, 1939) found the average values of the ratio of [a]:[b] given in table 15.VIII.

TABLE 15.VIII
INFLUENCE OF THE "LIGHT FIELD" ON PIGMENTS IN GREEN PLANTS

Plant type or habitat	[a]: [b]	[x]: [c]	$\frac{([a] + [b])}{([x] + [c])}$
Alpine	5.5	4.6	2.4
Emersed, water	4.4	4.0	3.0
Sun-exposed, land	4.36	3.6	3.1
In "blue shade" (diffuse sky light)	3.01	5.5	2.7
In "green shade"	2.60	5.3	2.6
Submersed, water	2.27	5.7	2.7
Green algae	1.39	6.4	3.15

It was mentioned on page 405 that the systematic investigation of marine algae has revealed the limitation of the conception of the ratio of [a]:[b] as an expression of chromatic adaptation. Instead of very large relative concentrations of chlorophyll *b*, almost all deep-sea algae were found to contain no chlorophyll *b* whatsoever. However, from the point of view of light absorption, the deficiency of chlorophyll *b* in brown algae is compensated for by the presence of fucoxanthol.

Seybold and Egle (1938¹) found that chlorophyll *a* is produced in light more rapidly than chlorophyll *b*, so that the ratio of [a]:[b] can attain very large values in the first period of illumination of etiolated seedlings. The same factor may perhaps account for the larger stationary concentration of chlorophyll *a* in sun-exposed leaves. Willstätter and Stoll (1918) found, however, (as mentioned before) no indication of an increase in the ratio of [a]:[b] after 10–20 hours of intense illumination.

The effect of environment on the concentration of the *carotenoids* and on the ratio of [chlorophyll]:[carotenoids] also has been probed by Rudolph (1934), Seybold and Egle (1937, 1938^{1,2}), Simonis (1938), and Strott (1938). Seybold and Egle (1937) thought at first that "shade plants" contain relatively more carotenoids. Later (1938²), they found (*cf.* Table 15.VIII) that the ratio of $([a] + [b]):[x] + [c]$ is not affected systematically by the intensity of illumination; but that the ratio of [x]:[c] is larger in shade plants, although less consistently so than that of [a]:[b]. Thus, the relative concentrations of the "oxidized" pigments (chlorophyll *b* and the carotenols) are lower in plants adapted to strong light. The different composition of the carotenoid mixture in shade plants and sun plants can hardly be attributed to chromatic adaptation, since the substitution of luteol for carotene does not increase the efficiency of light absorption.

Recently, Seybold (1941) suggested that chlorophyll *b* is associated with *starch production*, and absent from plants which form only soluble sugars. The basis of this theory was the observation that *Vaucheria*,

which almost alone among green algae does not contain any chlorophyll *b*, is also characterized by the production of oil instead of starch. A review of algal families for primary starch production and chlorophyll *b* content brought no striking confirmations of this hypothesis but also no contradictions to it. Seybold then proceeded to investigate the chlorophyll composition of monocotyledons which produce no starch (*e. g.*, members of the *Allium* family) and found a deficiency in chlorophyll *b* (while the ratio of [carotenol]:[carotene] and of [chlorophyll]:[carotenoids] did not show systematic deviations from the usual average).

TABLE 15.IX
PIGMENTS OF SEVERAL MONOCOTYLEDONS

Monocotyledon	[a]: [b]	[x]: [c]	$\frac{([a] + [b])}{([x] + [c])}$
<i>Allium cepa</i>	6.5	3.6	3.4
<i>Allium fistulosum</i>	7.0	2.6	2.4
	9.3	5.1	2.1
<i>Asphodelus luteus</i>	9.5	4.4	2.2
<i>Iris germanica</i>	7.5	3.7	3.1
<i>Gladiolus</i>	4.4	3.1	3.8

Seybold suggested that, even in dicotyledons, the gradation in the [a]:[b] ratio with light exposure, illustrated by table 15.VIII, may be associated with a gradation in the capacity for starch synthesis. This conclusion awaits confirmation by more extensive experimentation; even if confirmed, it would not in itself disprove the earlier theory of Seybold and Egle that the increased concentration of chlorophyll *b* is the result of chromatic adaptation to weak bluish light, since heliophilic character and absence of starch production may sometimes go hand in hand. However, the adaptation theory would have to be discarded if one accepts also Seybold's suggestion that chlorophyll *b* does not participate in photosynthesis at all, but is a specific sensitizer for the photochemical polymerization of sugars to starch; but (as mentioned on page 150) we consider this suggestion highly implausible.

3. Ontogenetic Adaptation of the Pigment System

The capacity of individual organisms to adjust themselves to external conditions is superimposed upon their hereditary inclination to produce a certain pigment mixture. These individual adaptations extend to both quantity and spectroscopic quality of the pigments. As in the case of phylogenetic adaptation, the most spectacular example is provided by colored algae. Engelmann and Gaidukov (*cf.* Engelmann and Gaidukov 1902, and Gaidukov 1903) found that the color of these

algae, particularly of some species of *Cyanophyceae*, can be changed by illumination with colored light.

As mentioned above, this phenomenon became the subject of a protracted controversy. Engelmann did not doubt that it was due to "complementary chromatic adaptation." The algae became green in red light, blue in green light, yellow in blue-green light, and blue in yellow light. These changes occurred only in living cells, and were different from (often opposite to) the discoloration effects observed in dead cells and pigment extracts. The color acquired in a certain colored light often was maintained for months in white light. In a later paper, Gaidukov (1906) described the rapid chromatic adaptation of *Phormidium tenue* (blue) and *Porphyra laciniata* (red) when placed on the plate holder of a spectrograph and illuminated with the light of a carbon arc. Ten hours were sufficient to produce a complete change in color.

The conclusions of Gaidukov were confirmed by Boresch (1919, 1921), who repeated the experiments because he thought that his own studies, as well as those of Schindler (1913) on color changes induced in algae by nitrogen or iron deficiency, made the interpretation of Gaidukov's experiments doubtful. However, working under controlled conditions of nutrition, Boresch (1919) confirmed the occurrence of chromatic re-adaptation, although only a few out of a large number of species investigated by him showed this phenomenon. While Gaidukov originally thought that color variations reflect changes in the nature of the pigments, Boresch ascribed them to changes in their relative concentrations, particularly in the ratios of the different forms of phycoeyanin. Mothes and Sagromsky (1941) found that the diatom, *Chaetoceras*, changes from dark brown in green light to yellow in red light, and that this change is caused by a shift in the [chlorophyll]:[carotenoid] ratio; a similar change was observed in *Chlorella*.

Extension of the theory of Berthold and Oltmanns from algae living in different depths to algae in differently colored artificial light led some investigators to the belief that, in the latter case, too, intensity of light rather than its spectral composition is responsible for the color changes. This problem was studied, by Nadson (1908), Harder (1917, 1922, 1923), and Sargent (1934). Nadson found that *Cyanophyceae* become yellowish brown in direct sunlight, and regain their blue color in the shadow. Harder (1922) found that, although change is correlated with the color of the light, as suggested by Engelmann and Gaidukov, a certain minimum intensity is required to bring it about. Harder thought that the individual re-adaptation of algae, similarly to their phylogenetic adaptation, is a combination of intensity adaptation and chromatic adaptation; algae may respond with color changes to changes in either color or intensity of light, thus using the same regulating

mechanism for two different purposes. Sargent (1934), on the other hand, denied that the color of light has any importance at all and asserted that algae respond in the same way to changes in intensity of light of any color. *Gloeocapsa montana*, for example, becomes blue in weak light and yellow (or light green) in strong light—whether this light be blue or green.

Despite Sargent's experiments, it appears illogical to deny the existence of any other but intensity adaptation. The development of red pigments in algae living in the blue-green light filtered through thick layers of sea water is so obviously a reaction to the color rather than to the low intensity of illumination that the existence of chromatic adaptation seems proved beyond doubt by this fact alone. The recent confirmation of the availability for photosynthesis of the light energy absorbed by the phycobilins (*cf.* Vol. II, Chapter 30) removes the last objection which could be raised to Engelmann's concept—the doubt concerning the practical usefulness of chromatic adaptation for the photosynthesis of algae.

On page 430, we shall find indications that the *formation* of chlorophyll and of the carotenoids proceeds most rapidly in the light absorbed by these pigments themselves. The photochemical *decomposition* of each pigment also will occur most efficiently in the light absorbed by it. The combination of photochemically autocatalyzed pigment synthesis with photochemical decomposition may be the basis of both chromatic and intensity adaptation; but we can expect a more detailed understanding of the mechanism of these phenomena only from a quantitative study, using truly monochromatic (instead of filtered) light and calculating (as precisely as possible) the absorption of energy by each pigment (*cf.* Vol. II, Chapter 22).

To sum up, both chromatic adaptation and intensity adaptation appear to be real phenomena, even though the superposition of both, together with the influence of heredity, lead to a confusing variety of phenomena. Although Engelmann's far-reaching conclusions were based on an apparently insufficient experimental evidence, his intuition has proved correct. The intensity adaptation of Oltmanns and Lubimenko provides a corollary, but not an alternative, to Engelmann's chromatic adaptation.

The advantages of chromatic adaptation for plants will be discussed in volume II, chapter 22, in terms of additional energy available to the plants because of their content of chlorophyll *b*, carotenoids, and phycobilins, and in volume II, chapter 30, in terms of the contribution to photosynthesis of the light absorbed by these pigments.

It has been asked whether nature's choice of chlorophyll as the main sensitizing pigment in photosynthesis itself is a chromatic adapta-

tion, that is, whether the absorption spectrum of the green pigment is particularly suitable for this purpose. Timiriazev (1883), in particular, saw a proof of this adaptation in the (alleged) coincidence of the absorption peak of chlorophyll with the intensity peak of the solar spectrum. He has been rebuked by Engelmann (1884), because only by an arbitrary interpretation of the solar energy distribution curve (*cf.* Vol. II, Chapter 22) can the maximum of the latter be placed near 670–680 $m\mu$. (This criticism did not prevent Timiriazev and his pupils from continuing to assert that the coincidence of the absorption maximum of chlorophyll with the intensity maximum of the sun spectrum is a striking argument in favor of Darwinian theory.)

A more elaborate attempt to explain the color of plants as the result of chromatic adaptation was made by Stahl (1909), who suggested that the existence of the two absorption peaks of chlorophyll—one in the *red* and one in the *violet*—is particularly favorable because of the two types of illumination to which the plants are subjected—direct sunlight with its maximum in the *yellow*, and sky light with its maximum at the *violet*, end of the visible spectrum. Stahl attributed the fact that the first absorption maximum of chlorophyll lies in the red rather than in the yellow to the desire of the plant to balance the light energy absorbed in the sun and in the shade. An absorption maximum too near the intensity maximum of the sun would cause the absorption of an excessive amount of energy, thus leading to overheating and injury. However, an equally ingenuous explanation could probably be found for any other arrangement of the absorption bands. Such speculations can be answered simply by pointing out that the intensity of sunlight changes comparatively slightly over the whole visible spectrum, and that average leaves absorb 50 to 80% of the light throughout this whole region (*cf.* figures in Chapter 22, Vol. II). The only spectroscopic property of chlorophyll—apart from the basic fact that it is a pigment—which could be considered as especially favorable for its function in the plants is transparency in the near infrared. This transparency prevents the cells from absorbing light which would be useless for photosynthesis (because of the insufficient energy content of its quanta). For the rest, the choice of chlorophyll as the main photosynthetic pigment must be due to its *photochemical properties* rather than to its *absorption spectrum*.

4. Influence of Different Factors on Pigment Formation

A higher plant, growing from seeds, must synthesize all its pigments (except for a small quantity of carotenoids available in the seed). The pigment synthesis is a complex process, and what is usually observed is only the last stage, the “greening,” *i. e.*, the transformation of a colorless “precursor” into the pigment. The efficiency of pigment synthesis—

and thus indirectly also the stationary concentration of the pigment in the mature plant—depends on a number of chemical and physical factors.

(a) *Nutrient Elements*

The absence of certain nutrient elements makes plants *chlorotic*, that is, deficient in chlorophyll. Among these are *potassium*, *nitrogen*, and *magnesium*, as well as the heavy metals, *iron* and *manganese*. These effects were mentioned in chapter 13, in the discussion of inhibition and stimulation of photosynthesis by inorganic ions. It was stated there that deficiencies in mineral nutrients may produce both a *direct* and an *indirect* inhibition of photosynthesis. The first is removed immediately by the supply of the deficient element, while the second one, being associated with chlorosis, can be remedied only more slowly by the increased formation of chlorophyll (and probably also of other catalytic components which are deficient in the photosynthetic apparatus of chlorotic plants).

Potassium.—An inadequate supply of potassium causes chlorosis, but an excessive quantity of this element may have the same effect if the supply of nitrogen is not large enough. These interrelations between potassium and nitrogen fertilization, investigated by Gassner and Goeze (1934) and Eckstein (1939), among others, were mentioned in chapter 13. According to Pirson (1937, 1938, 1940), rubidium is only an imperfect substitute for potassium in relieving chlorosis, while sodium or cesium cannot be used as substitutes at all (*cf.* page 337).

Nitrogen.—Nitrogen deficiency also causes chlorosis (*cf.*, for example, Pirson 1937). Fleischer (1935) used varying degrees of nitrogen deficiency to produce *Chlorella* cells with different contents of chlorophyll.

Magnesium.—This element is present in chlorophyll, and its complete absence in the diet must inevitably lead to chlorosis. Emerson and Arnold (1929) used magnesium-deficient nutrient solutions to produce *Chlorella* cells with a low chlorophyll content. Fleischer (1935) and Kennedy (1940) confirmed these results, and also found that much more magnesium is required to bring about the full rate of photosynthesis of *Chlorella* (*cf.* page 337) than to prevent chlorosis. The influence of magnesium on chlorophyll has also been investigated by Mameli (1918) and Zaitseva (1929).

Iron.—The chlorosis of iron-deficient plants is a well-known fact, but no satisfactory explanation of the necessity of iron for the formation of chlorophyll has as yet been given. Pollacci and Oddo (1915), Oddo and Polacci (1920), Polacci (1935), and Lodoletti (1938) asserted that both phanerogams and algae can produce chlorophyll in iron-free nutrient solutions if they are supplied with α -pyrrole carbonate, and concluded that iron is only necessary for the synthesis of the pyrrole group; but Deuber (1926), Godnev (1927), and Aronoff and Mackinney (1943) were

unable to confirm these conclusions. Hill and Lehmann (1941) found that changes in the chlorophyll content of leaves with the season of the year are preceded by changes in their content of iron. Boresch (1913, 1921) observed that iron deficiency also has a chlorotic effect on *Cyanophyceae*, affecting both the chlorophyll and the phycocyanin contents.

Other heavy metals.—The importance of *manganese* for the formation of chlorophyll was asserted by McHargue (1922), Bishop (1928), and Ulvin (1934). Pirson (1937), on the other hand, observed no chlorosis in *Chlorella* cells grown in the absence of manganese, even though the photosynthesis of these cells was inhibited (*cf.* page 338). Hoffman (1942) found a stimulating effect of *uranium* on the greening of seeds.

(b) *Oxygen, Water, and Sugars*

The role of *oxygen* in greening has been investigated by Gortikova and Lubimenko (1934) and Gortikova and Sapozhnikov (1939), who based their studies on Lubimenko's theory of greening as an oxidation process (*cf.* page 431). They found that the greening of etiolated wheat plantules does not occur in absence of an oxidant, but that molecular oxygen can be replaced, for example, by 2,6-dichlorophenol-indophenol. Gortikova and Sapozhnikov (1940²) have studied the influence of water on this process.

With the oxidation theory of Lubimenko as a guide, Gortikova and Sapozhnikov (1940¹) also have investigated the effect of *sugars* on greening. They observed a retardation of greening by some of these compounds and attributed it to their reducing power. However, this hypothesis does not explain why glucose and fructose had almost no effect, while sugars not usually present in the plant, *e. g.*, galactose, arabinose, and particularly mannose, produced a strong inhibition, as illustrated by table 15.X.

TABLE 15.X
EFFECT OF SUGARS ON GREENING
(milligrams chlorophyll synthesized within a given period of time)

Sugar concentration, %	0	0.1	0.5	3
Fructose	100	98	99	98
Mannose	168	100	62	12

(c) *Light and Heat*

Seedlings of the higher plants, sprouted in darkness, remain colorless, "etiolated," but begin to turn green immediately upon being brought into light. This phenomenon has been much studied, and there is no doubt that the formation of chlorophyll in etiolated plants is a photochemical reaction. However, as early as 1885, Schimper discovered

that *lower* plants (up to the *Bryophyta*) are capable of synthesizing chlorophyll without the help of light. Myers (1940) found no difference between the composition and photosynthetic efficiency of the pigments formed by *Protococcus* and *Chlorella* in darkness and in light. The capacity for chlorophyll synthesis in the dark extends also to *conifers* (see, for example, Lubimenko 1928, and Seybold and Egle 1938), although light *accelerates* the formation of chlorophyll in them, as is illustrated by table 15.XI.

TABLE 15.XI
RATE OF GREENING (AFTER LUBIMENKO)

Seedlings	Formation of chlorophyll in			
	Direct light	Light filtered through paper		Darkness
		2 sheets	6 sheets	
Pine	100	72	46	25
Wheat	100	90	53	0

The rate of formation of chlorophyll depends not only on the *intensity* of light, but also on its *spectral* composition. Emerson and Arnold (1932) and Emerson, Green and Webb (1940) used light of different color to effect the growth of *Chlorella* cells with varying contents of chlorophyll. According to Sayre (1928), Rudolph (1934), Seybold and Egle (1938¹), Simonis (1938), and Strott (1938), the synthesis of chlorophyll occurs in *red* light more rapidly than in blue or green light of the same intensity. This phenomenon deserves a closer study. The higher efficiency of red light may be due to its absorption by a chlorophyll precursor, or it may be the result of an "autosensitization" by the reaction product (chlorophyll), *i. e.*, to a photochemical counterpart to autocatalysis.

Johnston (1932) found *less* chlorophyll in plants grown in red light; Lease and Tottingham (1935) noted that the chlorophyll production increased when blue-violet light was added to red light; and Stoklasa (1915) asserted that the formation of chlorophyll occurs more rapidly in ultraviolet light than in visible sunlight.

Lubimenko and Hubbenet (1932) have studied the effect of *temperature* on the rate of formation of chlorophyll, and have found a tenfold increase between 5° and 15° C., and an increase by a factor of 1.5–2 between 18° and 28°. They associated this influence of temperature with the enzymatic transformation of leucochlorophyll into chlorophylligen (*cf.* page 404).

The development of *carotenoids* is also affected by light. According to Strain (1938), seeds contain almost no carotene but several carotenols. On the other hand, Seybold and Egle (1938) found both carotene and

the carotenols in chromatograms of pigments from squash seeds. According to Seybold and Egle, the carotenols in etiolated seedlings are developed in white light more quickly than are the carotenes. Rudolph (1934) and Simonis (1938) found that the carotenoids are formed in blue light more rapidly than in red light; again, as in the case of chlorophyll, this might be due either to the position of the absorption bands of the "precursors," from which the carotenoids are formed, or to an "autosensitization" by the pigments themselves. Simonis found that, in *Elodea* grown in red light, the ratio of $([a] + [b]) : ([x] + [c])$ is 23% larger than in a similar plant grown in blue light. Strott (1938) disagreed with Rudolph and Simonis, and asserted that not only chlorophyll but also the carotenoids are formed in red light more efficiently than in blue light of the same intensity.

The chemical nature of the processes which lead to the pigment formation is a matter of conjecture. It was mentioned on page 404 that Preisser first assumed, a hundred years ago, that chlorophyll is formed by oxidation, and Lubimenko (1928) suggested that the formation and decay of pigments in green leaves is connected with changes in the oxidation-reduction potential. Lubimenko found a steady increase in "peroxidase activity" (?) of leaves with age, and considered this development as characteristic of the oxidation state of the cell. At first, in young leaves, this activity is low, and the pigment system is in an almost colorless, "reduced," state; later, the activity increases, and the pigments pass one after another into the colored, "oxidized," state; in autumn, the pigments are oxidized further and are converted into colorless products. The stationary concentration of pigments in summer leaves corresponds to a certain favorable "intensity of oxidation processes," which strikes the balance between the rates of oxidation of a chlorophyll precursor to chlorophyll and of chlorophyll to a colorless oxidation product. This balance is maintained, according to Lubimenko, by a "protective reducing substance," allegedly present in the chloroplasts, which he calls "antioxidase."

Lubimenko's picture of a continuous oxidation process, in which the colored pigments form a transient stage, as well as his assumptions concerning the functions of the colorless leucophyll and the pigments chlorophyllogen and protochlorophyll (illustrated by the scheme on page 404), may be plausible, but have as yet not much experimental foundation.

It was mentioned on page 405 that, if protochlorophyll is a precursor of chlorophyll (which is by no means certain), the last stage in chlorophyll synthesis is a *reduction* rather than oxidation.

(d) *Heredity*

Albinism is an hereditary characteristic subject to the laws of Mendel. It would lead us too far to discuss here the relation of chlorophyll deficiency to heredity. We may refer, however, to the work of von Euler and coworkers (1929-1935), who found a close relationship between the inheritance of chlorophyll and of catalase. Chlorophyll-deficient mutants have been regularly found to be catalase-deficient as well. A certain, but less uniform, relationship apparently exists also between the inheritance of chlorophyll and of the carotenoids.

Bibliography to Chapter 15

Pigment System

A. General Composition

- 1776 Ingen-Housz, J., *Experiments upon Vegetables*. Johnson, London, 1776.
- 1818 Pelletier, J., and Caventou, J. B., *Ann. chim. phys.*, (2) 9, 194.
- 1837 Dutrochet, R. J. H., *Mémoires pour servir à l'histoire anatomique et physiologique des végétaux et des animaux*. Bruxelles, 1837.
- Berzelius, J. J., *Ann. Chemie (Liebig)*, 21, 257, 262.
- 1864 Stokes, G. G., *Proc. Roy. Soc. London*, 13, 144. *J. Chem. Soc.*, 2, 304.
- 1906 Tswett, M., *Ber. deut. botan. Ges.*, 24, 316, 384.
- 1913 Willstätter, R., and Stoll, A., *Untersuchungen über das Chlorophyll*. Springer, Berlin, 1913.
- 1918 Willstätter, R., and Stoll, A., *Untersuchungen über die Assimilation der Kohlensäure*. Springer, Berlin, 1918.
- 1928 Schertz, F. M., *Plant Physiol.*, 3, 211.
- 1934 Winterstein, A., and Stein, G., *Z. physiol. Chem.*, 220, 263.
- 1935 Spohn, H., *Planta*, 23, 657.
- 1937 Zechmeister, L., and Cholnoky, L. von, *Die chromatographische Adsorptionsanalyse*. Springer, Wien, 1937.
- 1938 Strain, H. H., "Leaf Xanthophylls," *Carnegie Inst. Wash. Pub.*, No. 490.
- Seybold, A., and Egle, K., *Planta*, 29, 114.
- 1939 Masood, S., Siddiqi, A. W., and Qureshi, M., *J. Osmania Univ.*, 7, 1.
- Meyer, K. P., *Helv. Phys. Acta*, 12, 349.
- Hanson, E. A., *Rec. trav. botan. néerland.*, 36, 183.
- 1941 Zscheile, F. P., *Botan. Rev.*, 7, 587.
- Zscheile, F. P., and Comar, C. L., *Botan. Gaz.*, 102, 463.
- 1942 Strain, H. H., *The Chromatographic Adsorption Analysis*. Interscience, New York, 1942.
- Strain, H. H., and Manning, W. M., *J. Biol. Chem.*, 144, 625.
- Strain, H. H., *J. Phys. Chem.*, 46, 1151.
- Haskin, H. H., *J. Biol. Chem.*, 144, 149.

B. The Chlorophylls

- 1832 Pelletier, J., and Caventou, J. B., *Ann. chim. phys.*, (2) 51, 182.
- 1844 Preisser, F., *J. prakt. Chem.*, 32, 129.
- 1864 Stokes, G. G., *Proc. Roy. Soc. London*, 13, 144; *J. Chem. Soc.*, 2, 304.
- 1873 Sorby, H. C., *ibid.*, 21, 442.
- 1893 Monteverde, N. A., *Scripta horti petropol.*, 13, 201.
- 1906 Tswett, M., *Ber. deut. botan. Ges.*, 24, 316, 384.
- 1911 Monteverde, N. A., and Lubimenko, V. N., *Bull. acad. sci. USSR*, (VI) 5, 73.
- 1913 Willstätter, R., and Stoll, A., *Untersuchungen über das Chlorophyll*. Springer, Berlin, 1913.
- Monteverde, N. A., and Lubimenko, V. N., *Bull. acad. sci. USSR*, (VI) 7, 1007.

- 1914 Wilschke, A., *Z. wiss. Mikroskop.*, **31**, 338.
Willstätter, R., and Page, H. G., *Ann. Chemie (Liebig)*, **404**, 237.
- 1918 Willstätter, R., and Stoll, A., *Untersuchungen über die Assimilation der Kohlensäure*. Springer, Berlin, 1918.
- 1919 Henrici, M., *Verhandl. Naturforsch. Ges. Basel*, **30**, 43.
- 1922 Warburg, O., and Negelein, E., *Z. physik. Chem.*, **102**, 235.
- 1925 Lubimenko, V. N., *Compt. rend.*, **179**, 1073.
- 1927 Lubimenko, V. N., *Rev. gén. botan.*, **39**, 619.
- 1928 Lubimenko, V. N., *ibid.*, **40**, 88, 146, 415.
- 1929 Noack, K., and Kiessling, W., *Z. physiol. Chem.*, **182**, 13.
- 1930 Noack, K., and Kiessling, W., *ibid.*, **193**, 97.
- 1931 Dhéré, Ch., and Fontaine, M., *Compt. rend. soc. biol.*, **107**, 1098.
Noack, K., and Kiessling, W., *Z. angew. Chem.*, **44**, 93.
Scharfnagel, W., *Planta*, **13**, 716.
Dhéré, Ch., and Fontaine, M., *Ann. inst. océanograph.*, **10**, 245.
Baehrach, E., and Dhéré, Ch., *Compt. rend. soc. biol.*, **108**, 385.
- 1932 Emerson, R., and Arnold, W., *J. Gen. Physiol.*, **16**, 191.
- 1934 Euler, H. v., Bergman, B., and Hellström, H., *Ber. deut. botan. Ges.*, **12**, 458.
Zscheile, F. P., *Botan. Gaz.*, **95**, 529.
Winterstein, A., and Schön, K., *Z. physiol. Chem.*, **230**, 139.
- 1935 Zscheile, F. P., *Cold Spring Harbor Symposia Quant. Biol.*, **3**, 108.
Dhéré, Ch., and Raffy, A., *Compt. rend. soc. biol.*, **119**, 232.
- 1936 Fischer, H., and Breitner, S., *Ann. Chemie (Liebig)*, **522**, 151.
- 1937 Seybold, A., and Egle, K., *Planta*, **26**, 491.
Seybold, A., *ibid.*, **26**, 712.
- 1938 Seybold, A., and Egle, K., *Jahrb. wiss. Botan.*, **86**, 50.
Seybold, A., and Egle, K., *Planta*, **29**, 119.
Mackinney, G., *Plant Physiol.*, **13**, 123, 427.
Granick, S., *Am. J. Botany*, **25**, 558, 561.
Inman, O. L., and Blakeslee, A. F., *Science*, **87**, 428.
- 1939 Seybold, A., and Egle, K., *Sitzber. heidelberger Akad. Wiss. Math. naturw. Klasse*, **1939**, 7.
Seybold, A., and Egle, K., *Botan. Arch.*, **40**, 560.
Noddack, W., and Eichhoff, H. J., *Z. physik. Chem.*, **185**, 222.
Fischer, H., Mittenzwei, H., and Oestreicher, A., *Z. physiol. Chem.*, **257**, IV.
Robbins, W. J., and Rickett, H. W., *Botany*. Van Nostrand, New York, 1939.
- 1940 Sargent, M. C., *Plant Physiol.*, **15**, 275.
Montfort, C., *Z. physik. Chem.*, **A 186**, 57.
Godnev, T. N., and Kalishevich, S. V., *Compt. rend. acad. sci. URSS*, **27**, 832.
Fischer, H., *Naturwissenschaften*, **28**, 401.
Menke, W., *Z. physiol. Chem.*, **263**, 100.
- 1941 Pace, N., *J. Biol. Chem.*, **140**, 483.
Seybold, A., Egle, K., and Hülsbruch, W., *Botan. Arch.*, **42**, 239.

- 1941 Seybold, A., *ibid.*, **42**, 254.
Zscheile, F. P., *Botan. Gaz.*, **103**, 401.
Smith, E. L., *J. Gen. Physiol.*, **24**, 565.
- 1942 Strain, H. H., and Manning, W. M., *J. Biol. Chem.*, **144**, 625.
Strain, H. H., and Manning, W. M., *ibid.*, **146**, 275.
Bot, G. M., *Chronica Botan.*, **7**, 66.
Haskin, H. H., *J. Biol. Chem.*, **144**, 149.
- 1943 Strain, H. H., Manning, W. M., and Hardin, G., *ibid.*, **148**, 655.
Manning, W. M., and Strain, H. H., *J. Biol. Chem.*, **151**, 1.

C. The Carotenoids

- 1827 Guibourt, G., Robinet, S., and Derheim, J., *J. pharm. chim.*, **13**, 26.
- 1837 Berzelius, J. J., *Ann. Chemie (Liebig)*, **21**, 257, 262.
Berzelius, J. J., *Ann. Physik*, **42**, 422.
- 1838 Berzelius, J. J., *Ann. Chemie (Liebig)*, **27**, 296.
- 1860 Frémy, E., *Compt. rend.*, **50**, 405.
- 1864 Stokes, G. G., *Proc. Roy. Soc. London*, **13**, 144.
- 1913 Willstätter, R., and Stoll, A., *Untersuchungen über das Chlorophyll*.
Springer, Berlin, 1913.
- 1914 Willstätter, R., and Page, H., *Ann. Chemie (Liebig)*, **404**, 237.
- 1918 Willstätter, R., and Stoll, A., *Untersuchungen über die Assimilation
der Kohlensäure*. Springer, Berlin, 1918.
- 1927 Kylin, H., *Z. physiol. Chem.*, **166**, 39.
- 1932 Boresch, K., in Klein's *Handbuch der Pflanzenanalyse*. Springer,
Berlin, 1932.
- 1935 Mackinney, G., *J. Biol. Chem.*, **111**, 75.
Karrer, P., and Solmssen, U., *Helv. Chim. Acta*, **18**, 1306.
Heilbron, I. M., and Phipers, R. F., *Biochem. J.*, **29**, 1369.
- 1936 Karrer, P., and Solmssen, U., *Helv. Chim. Acta*, **19**, 3.
Heilbron, I. M., and Lythgoe, B., *J. Chem. Soc.*, **1936**, 1376.
Montfort, C., *Jahrb. wiss. Botan.*, **84**, 1, 483.
Tischer, J., *Z. physiol. Chem.*, **239**, 257; **243**, 103.
- 1937 Tischer, J., *ibid.*, **250**, 147.
- 1938 Seybold, A., and Egle, K., *Jahrb. wiss. Botan.*, **86**, 50.
Tischer, J., *Z. physiol. Chem.*, **251**, 109.
Strain, H. H., "Leaf Xanthophylls," *Carnegie Inst. Wash. Pub.*,
No. 490.
- 1939 Seybold, A., and Egle, K., *Botan. Arch.*, **40**, 560.
- 1940 Carter, P. W., Heilbron, I. M., and Lythgoe, B., *Proc. Roy. Soc.
London B*, **128**, 82.
- 1941 Seybold, A., Egle, K., and Hülsbruch, W., *Botan. Arch.*, **42**, 239.
Pace, N., *J. Biol. Chem.*, **140**, 483.
- 1942 Strain, H. H., and Manning, W. M., *J. Am. Chem. Soc.*, **64**, 1235.
Haskin, H. H., *J. Biol. Chem.*, **144**, 149.
- 1943 Strain, H. H., and Manning, W. M., *J. Am. Chem. Soc.*, **65**, 2258.
- 1944 Strain, H. H., Manning, W. M., and Hardin, G., *Biol. Bull.*, **86**, 169.

D. *The Phycobilins*

- 1836 Eisenbeck, N. von, *Ann. Chemie (Liebig)*, **17**, 75.
 1843 Kützing, F. T., *Phycologia generalis*. Leipzig, 1843.
 1888 Schütt, F., *Ber. deut. botan. Ges.*, **6**, 36, 305.
 1894 Molisch, H., *Botan. Z.*, **52**, 177.
 1895 Molisch, H., *ibid.*, **53**, 131.
 1906 Molisch, H., *Sitzber. Akad. Wiss. Wien Math.-naturw. Klasse, Abt. I*,
 95.
 1910 Kylin, H., *Z. physiol. Chem.*, **69**, 169.
 1911 Kylin, H., *ibid.*, **74**, 105.
 1912 Kylin, H., *ibid.*, **76**, 396.
 1921 Boresch, K., *Ber. deut. botan. Ges.*, **39**, 93.
 Boresch, K., *Biochem. Z.*, **119**, 167.
 1922 Wille, N., *Ber. deut. botan. Ges.*, **40**, 188.
 1925 Lubimenko, V. N., *Compt. rend.*, **179**, 1073.
 1928 Lemberg, R., *Ann. Chemie (Liebig)*, **461**, 46.
 1929 Lemberg, R., *Naturwissenschaften*, **17**, 541.
 1931 Kylin, H., *Z. physiol. Chem.*, **197**, 1.

E. *Influence of External Factors*

- 1883 Timiriazev, C., *Compt. rend.*, **96**, 375.
 Engelmann, Th. W., *Botan. Z.*, **41**, 18.
 1884 Engelmann, Th. W., *ibid.*, **42**, 81, 97.
 1885 Schimper, A. F. W., *Jahrb. wiss. Botan.*, **16**, 1.
 1893 Oltmanns, F., *ibid.*, **23**, 349.
 1902 Engelmann, Th. W., and Gaidukov, N. I., *Arch. Anat. Physiol.:*
Physiol. Abt., **1902**, p. 333.
 1903 Gaidukov, N. I., *Ber. deut. botan. Ges.*, **21**, 484, 517.
 Gaidukov, N. I., *Scripta horti petropol.*, **22**.
 1904 Gaidukov, N. I., *Ber. deut. botan. Ges.*, **22**, 23.
 Gaidukov, N. I., *Hedwigia*, **43**.
 1905 Lubimenko, V. N., *Rev. gén. botan.*, **17**, 381.
 Oltmanns, F., *Morphologie und Biologie der Algen*. Fischer, Jena,
 1905.
 1906 Gaidukov, N. I., *Ber. deut. botan. Ges.*, **24**, 1.
 1907 Lubimenko, V. N., *Compt. rend.*, **145**, 1347.
 1908 Lubimenko, V. N., *Ann. sci. nat. Genève*, (9) **7**, 321.
 Lubimenko, V. N., *Rev. gén. botan.*, **20**, 162, 217, 253, 285.
 Nadson, G., *Bull. jardin botan. St. Pétersbourg*, **8**.
 1909 Stahl, E., *Zur Biologie des Chlorophylls*. Fischer, Jena, 1909.
 1912 Richter, A. v., *Ber. deut. botan. Ges.*, **30**, 280.
 1913 Schindler, B., *Z. Botan.*, **5**, 497.
 Boresch, K., *Jahrb. wiss. Botan.*, **52**, 145.
 1915 Pollacci, G., and Oddo, B., *Atti accad. Lincei*, **24 II**, 37.
 Pollacci, G., and Oddo, B., *Gazz. chim. ital.*, **45**, III, 197.
 Stoklasa, J., *Strahlentherapie*, **6**, 119.

- 1917 Harder, R., *Z. Botan.*, **9**, 224.
- 1918 Mameli, E., *Atti ist. botan. Univ. Pavia*, **II 15**, 151.
Willstätter, R., and Stoll, A., *Untersuchungen über die Assimilation der Kohlensäure*. Springer, Berlin, 1918.
- 1919 Boresch, K., *Ber. deut. botan. Ges.*, **37**, 25.
- 1920 Oddo, B., and Pollacci, G., *Gazz. chim. ital.*, **50**, I, 54.
- 1921 Boresch, K., *Z. Botan.*, **13**, 65.
Boresch, K., *Arch. Protistenk.*, **44**, 1.
- 1922 Harder, R., *Ber. deut. botan. Ges.*, **40**, 26.
McHargue, J. S., *J. Am. Chem. Soc.*, **44**, 1592.
- 1923 Harder, R., *Z. Botan.*, **15**, 305.
- 1926 Lubimenko, V. N., *Bull. inst. sci. Lesshaft*, **12**, 5.
Deuber, C. G., *Am. J. Botany*, **13**, 276.
- 1927 Godnev, T., *Bull. Polytechn. Inst. Ivanovo-Voznesensk*, **10**, 87.
- 1928 Lubimenko, V. N., *Rev. gén. botan.*, **40**, 146, 415, 486.
Lubimenko, V. N., *Arb. biol. Sta. Sebastopol*, **1**, 153.
Sayre, J. D., *Plant Physiol.*, **3**, 71.
Bishop, W. B. S., *Australian J. Exptl. Biol. Med. Sci.*, **5**, 125.
- 1929 Zaitseva, A. A., *Bull. inst. sci. Lesshaft*, **15**, 137.
Emerson, R., and Arnold, W., *J. Gen. Physiol.*, **12**, 609.
von Euler, H., and Nilsson, H., *Arkiv Kemi Mineral. Geol.*, **B 10**, No. 6.
von Euler, H., and Nilsson, H., *Naturwissenschaften*, **17**, 289.
von Euler, H., Hellström, H., and Runehjelm, D., *Z. physiol. Chem.*, **182**, 205.
von Euler, H., Steffenburg, S., and Hellström, H., *ibid.*, **183**, 113.
von Euler, H., and Hellström, H., *ibid.*, **183**, 177.
von Euler, H., and Runehjelm, D., *ibid.*, **185**, 74.
von Euler, H., and Runehjelm, D., *Arkiv Kemi Mineral. Geol.*, **B 10**, No. 10.
- 1930 von Euler, H., Davidson, H., and Runehjelm, D., *Z. physiol. Chem.*, **190**, 247.
- 1931 von Euler, H., Forssberg, A., Runehjelm, D., and Hellström, H., *Z. Indukt. Abstam. Vererbungslehre*, **50**, 131.
- 1932 von Euler, H., Hellström, H., and von Kohler, B., *Z. physiol. Chem.*, **212**, 53.
von Euler, H., Hellström, H., and von Kohler, B., *Arkiv Kemi Mineral. Geol.*, **B 11**, No. 38.
Emerson, R., and Arnold, W., *J. Gen. Physiol.*, **16**, 191.
Johnston, E. S., *Smithsonian Inst. Pub. Misc. Collections*, **87**, No. 14.
Lubimenko, V. N., and Hubbenet, E. R., *New Phytologist*, **31**, 26.
Ehrke, G., *Planta*, **17**, 650.
- 1933 Harder, R., *ibid.*, **20**, 699.
von Euler, H., Hellström, H., and Burström, D., *Z. physiol. Chem.*, **218**, 241.
- 1934 Ulvin, G. B., *Plant Physiol.*, **9**, 59.
Gortikova, N. N., and Lubimenko, V. N., *Beitr. Biol. Pflanzen*, **22**, 235.

- 1934 Gassner, G., and Goeze, G., *Z. Botan.*, **27**, 257.
Sargent, M. C., *Proc. Natl. Acad. Sci. U. S.*, **20**, 251.
Montfort, C., *Jahrb. wiss. Botan.*, **79**, 493.
Rudolph, H., *Planta*, **21**, 104.
Seybold, A., *Jahrb. wiss. Botan.*, **79**, 593.
- 1935 Fleischer, W. E., *J. Gen. Physiol.*, **18**, 573.
Euler, H. v., Hellström, H., and Löfgren, N., *Z. physiol. Chem.*, **234**, 151.
Lease, E. J., and Tottingham, W. E., *J. Am. Chem. Soc.*, **52**, 2613.
Pollacci, G., *Ber. deut. botan. Ges.*, **53**, 540.
- 1936 Montfort, C., *Jahrb. wiss. Botan.*, **84**, 1, 483.
- 1937 Egle, K., *Planta*, **26**, 546.
Seybold, A., and Egle, K., *ibid.*, **26**, 491.
Pirson, A., *Z. Botan.*, **31**, 193.
- 1938 Seybold, A., and Egle, K., *Planta*, **28**, 87; **29**, 114, 119.
Seybold, A., and Egle, K., *Jahrb. wiss. Botan.*, **86**, 50.
Harder, R., Simonis, W., and Böde, O., *Nachr. Ges. Wiss. Göttingen VI*, **3**, 135.
Simonis, W., *Planta*, **29**, 129.
Strain, H. H., "Leaf Xanthophylls," *Carnegie Inst. Wash. Pub.*, No. 490.
Strott, A., *Jahrb. wiss. Botan.*, **86**, 1.
Pirson, A., *Planta*, **29**, 231.
Lodoletti, A., *Boll. chim.-farm.*, **11**, 609.
- 1939 Seybold, A., and Egle, K., *Botan. Arch.*, **40**, 560.
Bukatsch, F., *Z. ges. Naturw.*, **5**, 263.
Gortikova, N. N., and Sapozhnikov, D. I., *Sovet. Botan.*, **1939**, 99.
Eckstein, O., *Plant Physiol.*, **14**, 113.
- 1940 Myers, J., *ibid.*, **15**, 575.
Gortikova, N. N., and Sapozhnikov, D. I., *Sovet. Botan.*, **1940**, **79**, 338.
Kennedy, S. R., *Am. J. Botany*, **27**, 68.
Pirson, A., *Ernähr. Pflanze*, **36**, 25.
Emerson, R., Green, L., and Webb, J. L., *Plant Physiol.*, **15**, 311.
Bukatsch, F., *Z. ges. Naturw.*, **6**, 197.
Wendel, K., *ibid.*, **6**, 327.
- 1941 Seybold, A., *Botan. Arch.*, **42**, 254.
Hill, R., and Lehmann, H., *Biochem. J.*, **35**, 1190.
Mothes, K., and Sagromsky, H., *Naturwissenschaften*, **29**, 271.
- 1942 Hoffman, J., *Chem. Ztg.*, **66**, 181.
- 1943 Aronoff, S., and Mackinney, G., *Plant Physiol.*, **18**, 713.

CHAPTER 16

CHLOROPHYLL

A. MOLECULAR STRUCTURE*

1. Historical Remarks

The part played by chlorophyll in the pigment system of plants has been described in chapter 15. The gradual unveiling of the structure of this compound, one of the most important in nature, is an admirable example of patient systematic work in organic chemistry. The versatile genius of Berzelius, who in his long life analyzed, or tried to analyze, every compound which came into his hands, stands at the beginning of this development, a little over a century ago (1838). The ease with which chlorophyll decomposes and the difficulty of its purification, have led to many initial errors in its analysis. An important step forward was the realization of the similarity between chlorophyll and hemin, the red blood pigment, first suspected by Verdeil in 1851, and later confirmed by Hoppe-Seyler (1879, 1880, 1881), who transformed chlorophyll into a red "porphyrin" similar to those obtainable from hemin. However, further progress in the elucidation of the chemical structure of both chlorophyll and hemin remained slow, until the subject was taken up by Willstätter in 1905. His fundamental work has been developed further by Stoll in Switzerland, Conant in America and, most persistently and successfully, by Hans Fischer in Germany.

The investigations of Willstätter and his coworkers (published in twenty separate papers between 1905 and 1913), were summarized by Willstätter and Stoll in their well-known book, *Untersuchungen über Chlorophyll* (1913, American edition 1928). A second book by the same authors, *Untersuchungen über die Assimilation der Kohlensäure*, appeared in 1918; it described the work carried out during the war years of 1914 to 1918 and not published elsewhere, and dealt with the state of the pigments in nature and their participation in photosynthesis. It has been repeatedly quoted in the preceding chapters.

The fourteen *Studies in the Chlorophyll Series* of Conant and coworkers appeared in 1929-1934. The results of Fischer and coworkers were presented in a series of papers, *Zur Kenntnis des Chlorophylls*, the first published in 1928 and the hundredth in 1940; closely related to this series is another one, *Die Synthese der Porphyrine*. Short summaries were given by Fischer in 1936, 1937, and 1940. A complete review by

* Bibliography, page 467.

Fischer and Stern, is in the second volume of *Chemie des Pyrrols* (Fischer and Orth 1940). Other reviews of chlorophyll chemistry have been given by Marchlewski (1904), Tswett (1910), Treibs (1932), Linstead (1935, 1937), Stoll and Wiedemann (1938), and Steele (1937, 1943).

The fundamental work of Willstätter and the systematic painstaking research of Fischer rank among the outstanding contributions to the organic chemistry of natural compounds, and have been recognized as such by the award of the Nobel prize to Willstätter in 1915 and to Fischer in 1930.

The scope of the present book does not permit a detailed discussion of the results obtained in the chemical studies of chlorophyll and its derivatives; we must be content with a few fundamental facts and hypotheses. Consequently, we shall refrain from quoting original papers, and refer the reader to the above-mentioned comprehensive presentations of the subject; a complete bibliography can be found in the book of Fischer and Stern.

2. Structural Formula

We mentioned in chapter 15 that chlorophyll of the higher plants and green algae consists of two components, chlorophyll *a* and chlorophyll *b*, distinguished by their spectra, and separable because of their different solubilities and adsorbabilities. Colored algae contain no chlorophyll *b*, whose place seems to be taken by two related pigments, "chlorophyll *c*" in brown algae and diatoms, and "chlorophyll *d*" in red algae (*cf.* Chapter 15, page 406). The composition of these two pigments is as yet unknown. That of the two original chlorophylls is as follows:

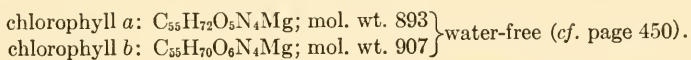

This composition was established by Willstätter and coworkers; previously, iron and phosphorus had often been mentioned as probable components of chlorophyll. Willstätter found that the chlorophylls are *esters of two dibasic acids* which he called *chlorophyllins*:

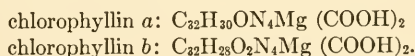

The esterifying alcohols are *methanol* (CH_3OH) and *phytol* ($\text{C}_{20}\text{H}_{33}\text{OH}$). The latter is a long-chain alcohol with one double bond; its structure (Formula 16.I) has been confirmed by synthesis by F. G. Fischer and Löwenberg (1929).

The arrangement of methyl groups in phytol shows a relation to isoprene. The chain length (C_{20}) is one-half that of the carotenoids; a genetic relationship of phytol to these compounds has often been postulated. However, in contrast to the carotenoids,

phytol is an almost saturated compound and, because of the absence of conjugated double bonds, it is a colorless oil, not a pigment. The same factor deprives the phytol molecule of rigidity; it can be twisted or bent without strain.

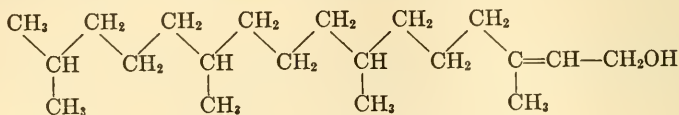

Formula 16.I. Phytol ($\text{C}_{20}\text{H}_{39}\text{OH}$).

The two chlorophylls can be formulated as *phytyl-methyl chlorophyllides*:

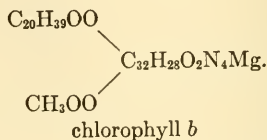
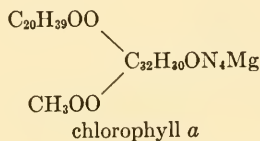

Willstätter found that plants contain an enzyme, *chlorophyllase*, which, in the presence of methanol or ethanol, causes the exchange of phytol for these short-chain alcohols (*cf.* Chapter 14, p. 377). The resulting products, the *methyl (or ethyl) chlorophyllides*, are more easily crystallizable than the chlorophylls, but similar to them in many other properties, *e. g.*, spectrum. (Borodin 1882 and Monteverde 1893, first described them as "crystalline chlorophyll.")

Experiments on the degradation of chlorophyll have shown that chlorophyllin contains *four pyrrole nuclei*:

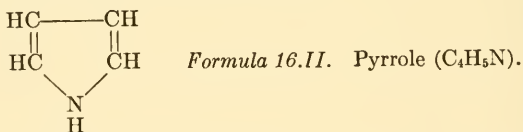

and one atom of nonionizable *magnesium*, probably situated in the center of the molecule. The oxygen atoms unaccounted for by the two carboxyl groups belong to carbonyl groups (one in chlorophyll *a*, two in chlorophyll *b*).

It has been mentioned that a relationship between chlorophyll and hemin has been considered probable since the time of Verdeil (1851). Willstätter showed that hemin, too, contains four pyrrole nuclei, arranged around an *iron* atom. Apart from this difference in metal, the formula of chlorophyllin *a* differs from that of hemin only by one additional oxygen atom. In 1913, Willstätter and Stoll rejected as improbable a structural formula of hemin, suggested a year earlier by Küster (1912), which later proved to be fundamentally correct. It showed the four pyrrole nuclei linked by four =CH— bridges into one large ring system. Willstätter and Stoll thought that a closed ring containing twelve carbon

atoms and four nitrogen atoms would not be stable enough; but subsequent experiments have shown that this structural unit occurs not only in hemin and chlorophyll, but also in many other natural compounds, and, with a slight alteration (nitrogen atoms instead of CH— groups), in the very stable synthetic dyes of the phthalocyanin class.

We cannot discuss here the development of Küster's scheme into a complete structural formula of chlorophyll. Formula 16.III is the latest formulation of Hans Fischer (1940), accepted by most workers in the field of chlorophyll chemistry. The three alternative structures, *A*, *B* and *C*, differ only in the routing of the eighteen-membered, "aromatic" (*i. e.*, all-around conjugated) system of alternating single and double bonds (designated by heavy lines) and in the direction of magnesium-nitrogen bonds (which is determined by this routing).

In formula 16.III, the four pyrrole nuclei numbered I, II, III and IV, are linked by CH— bridges α , β , γ , δ . An additional homocyclic (cyclopentanone) ring, V, carries a carbonyl oxygen in position 9, and a methanol-esterified carboxyl group in position 10; nucleus I carries a vinyl group, and nucleus IV a propionic acid side chain esterified by phytol. Other substituents are ethyl and methyl groups. In chlorophyll *b*, the methyl group in position 3 is replaced by methoxyl.

An important characteristic of formula 16.III is the presence of two hydrogen atoms in positions 7 and 8 in nucleus IV. Partial hydrogenation of the double-bond system in chlorophyll was first suspected by Conant (on the strength of spectroscopic analogies), as well as by Stoll, and confirmed by Fischer by the observation of the optical activity of chlorophyll and its derivatives, which proves the presence of an asymmetric carbon atom. In chlorophyll itself, this could be atom 10, but activity is retained also by chlorophyll derivatives deprived of the side chain in position γ ; thus, the asymmetry must lie in one of the pyrrole nuclei. This means that at least one ring carbon must be free from double bonding.

The presence of two hydrogen atoms in nucleus IV reduces the number of double bonds in the nuclear system of chlorophyll to ten (as against 11 in the porphyrins); but an eleventh C=C bond is present in the vinyl side chain. In Fischer's earlier work (1937), the two "extra" hydrogen atoms were placed in positions 5 and 6 in nucleus III. (Spectroscopic data which favored this assignment will be given in Volume II, Chapter 21); but later (1940), Fischer decided, on the basis of observations on the oxidative degradation of chlorophyll, that the hydrogenated nucleus must be nucleus IV.

Of the ten double bonds in the ring system of chlorophyll, nine form a closed conjugated system of the "aromatic" type (indicated by heavy lines), while the tenth is in a "one-sided" conjugation with it (a position

similar to that of the vinyl group). The location of this "semi-isolated" double bond distinguishes formulations *A*, *B*, and *C*. Each of these formulae represents two structures, analogous to the two Kékulé structures

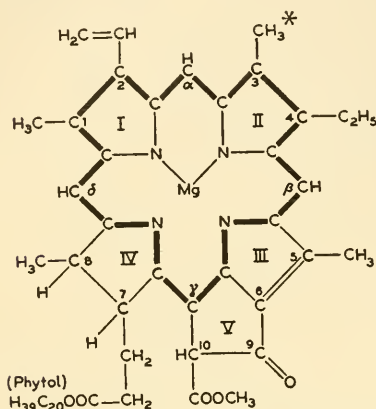

A. Semi-isolated double bond in nucleus III; Mg bound to nuclei I and II.

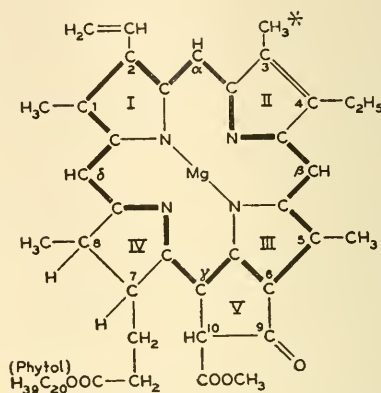

B. Semi-isolated double bond in nucleus II; Mg bound to nuclei I and III.

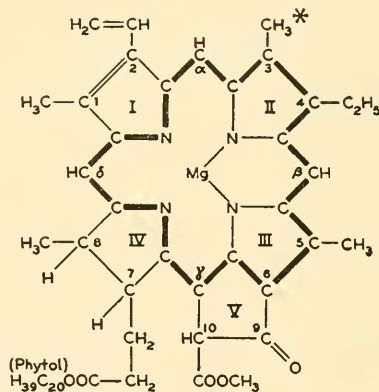

C. Semi-isolated double bond in nucleus I; Mg bound to nuclei II and III.

Formula 16.III.

Chlorophyll *a* structure according to Hans Fischer. *A*, *B*, and *C* are three isomeric (or mesomeric) structures distinguished by the routing of the all-round conjugated ring system (heavy line), and the position of the "semi-isolated" double bond and the directions of the Mg—N bonds which depend on this routing.

The asterisk designates the position of a carbonyl group in chlorophyll *b*.

of benzene. These pairs of structures are "mesomeric," *i. e.*, they correspond to the same spacial arrangement of atomic nuclei, and differ only in the distribution of electrons. In such cases, the true structure

of the molecule can be described, according to the quantum theory, as a "mixture" of the two mesomeric forms, and the heavy lines in 16.III represent equivalent bonds of an average strength of about 1.5.

One could ask whether structures *A*, *B*, and *C* too, are mesomeric. The answer depends on whether the magnesium is situated exactly in the center of the molecule, and whether the equilibrium configurations of all pyrrole nuclei are the same. If, in *A* and *C*, the equilibrium position of the magnesium atom were closer to those two nitrogen atoms to which it is bound by true valency bonds, this should prevent mesomerism. However, from the probable size of the central "hole" and the radius of magnesium in atomic binding (*cf.* page 448), there appears not to be enough space for magnesium to be markedly displaced from the central position; consequently the magnesium-nitrogen bonds probably can be switched from nitrogen to nitrogen without a change in the position of the nuclei, and thus do not interfere with mesomerism.

However, Fischer suggested that structure *A* is more stable than *B* and *C*, because, in the latter, ring V is under strain. This implies that the equilibrium configuration of the pyrrole nucleus with the semi-isolated double bond is different from that of the other two nuclei. If this difference is real, a mesomerism of structures *A*, *B*, and *C* becomes impossible.

The question of differences between the structures of the four pyrrole nuclei in chlorophyll was debated between Haurowitz (1935, 1938) and Fischer and Stern. Haurowitz argued in favor of a "biradical" formula with a symmetrical all-round conjugated double-bond system (as in 16.VII *B*), and of *all four* pyrrole nuclei being in the same state. Since we assumed that nucleus IV contains two extra hydrogen atoms, the biradical formula is impossible, and the controversy reduces itself to the question of identical or different structure of the *three nonhydrogenated nuclei*, I, II, and III.

Stern presented evidence that the introduction of certain substituents (*e g.*, carbonyl) has a different effect on the spectrum, depending on whether they enter nucleus I, II, or III, and saw in this a proof of their different double-bond structure (*cf.* however, Aronoff and Calvin 1943). Although one may argue (with Haurowitz) that this difference arises only *after* the introduction of the substituents, we are inclined to agree with Fischer and Stern that the semi-isolated double bond is localized in one of the three pyrrole nuclei. However, in trying to identify this nucleus, we find that Stern's spectroscopic evidence favors nucleus II (structure *B*), while Fischer's stability considerations point to nucleus III (structure *A*). The spectroscopic data (discussed in more detail in Chapter 21, Volume II) show a similarity between nuclei I and III, as opposed to nucleus II, which is best expressed by formula 16.III *B*.

A comparison with the structure of bacteriochlorophyll (Formula 16.IV) also speaks in favor of formulation *B*, since the semi-isolated double bond (3-4 in structure *B*) offers itself as a natural location of the next hydrogenation step. Another argument in favor of structure *B* is the absence of a large dipole moment—which should be present if two polar magnesium–nitrogen bonds would not point in opposite directions. (Of course, this fact can also be explained by *nonlocalized* magnesium–nitrogen bonds, *i. e.*, by a mesomerism of structures *A*, *B*, and *C*).

To sum up, it seems that, if one must choose between the structures *A*, *B*, and *C* as isomers (and not mesomers), evidence speaks in favor of structure *B* rather than *A*. The other two structures may correspond to tautomers with a slightly higher energy. One is free to speculate on a possible relationship between these structures and the chlorophyll isomers *a'*, *b'*, and *d'*, described by Strain and Manning (*cf.* page 403).

In a complete analysis of the ground state of the chlorophyll molecule, many more mesomeric structures should be considered, *e. g.*, those with the magnesium atom bearing a positive charge (according to Pauling, a Mg–N bond is about “50% ionic”), as well as structures with positive nitrogen and negative carbon.

The ionic contribution to a carbon–nitrogen single bond is only about 6%; but in the case of pyrrole, Pauling estimated a 24% contribution of the four ionic structures:

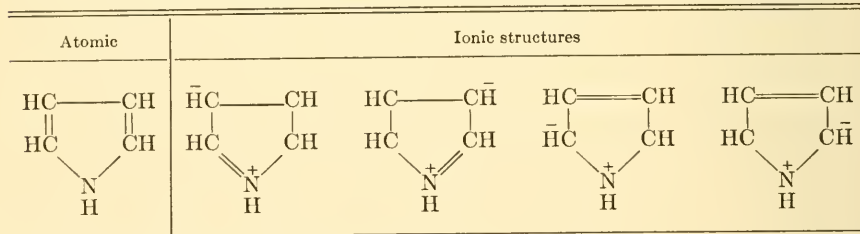

The keto group in the homocyclic ring V can be enolized by the hydrogen atom in position 10. This tautomerism probably accounts for some chemical reactions of chlorophyll, particularly in alkaline media.

3. Bacteriochlorophyll and Protochlorophyll

The *bacteriochlorophyll* of purple sulfur bacteria was investigated by Schneider (1934) and in more detail by Fischer and coworkers (1940). According to Fischer, it differs from chlorophyll *a* by oxidation of the vinyl group, —CH=CH₂, in position 2 to an acetyl group, —CO—CH₃, and the hydrogenation of a second double bond in one of the pyrrole nuclei, probably the one in position 3-4 (*cf.* Formula 16.IV). This makes bacteriochlorophyll formally a *hydrate* of chlorophyll *a*, with the composition, C₅₅H₇₄O₆N₄Mg. Hydrogenation of nucleus II fixes the conjugated double-bond system in bacteriochlorophyll in the “diagonal” arrangement shown in formula 16.IV, and makes this compound appear

as the hydrogenation product of chlorophyll *a* in the form 16.III B. Bacteriochlorophyll can easily be oxidized, with the removal of the two excess hydrogen atoms in positions 3 and 4, giving 2-acetyl-chlorophyll *a*. Fischer and Stern (1940) suggested that this compound, with a structure intermediary between bacteriochlorophyll and ordinary chlorophyll, may be identical with *bacterioviridin*, the natural pigment of green sulfur bacteria.

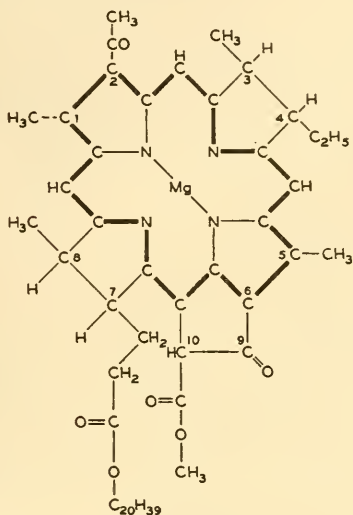

Formula 16.IV.

Bacteriochlorophyll structure according to Hans Fischer. The routing of the all-round conjugated system is fixed by the hydrogenation of a second nucleus (nucleus II, positions 3 and 4).

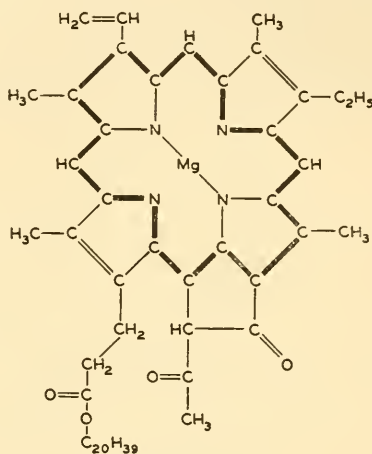

Formula 16.V.

Protochlorophyll structure after Hans Fischer. (One of six possible structures distinguished by the routing of the conjugated double bond system; the structure represented here is the one derived from structure B in formula 16.III).

Protochlorophyll, whose possible role in the synthesis (or decomposition) of chlorophyll in nature was discussed in chapter 15 (page 404) is, according to Fischer (1940), an *oxidation product* of chlorophyll *a*, with the two hydrogen atoms in positions 7 and 8 removed, as shown by formula 16.V.

4. Porphins, Chlorins, Phorbins, Phytins, and Phyllins

Protochlorophyll, chlorophyll, and bacteriochlorophyll belong to *three successive reduction levels* of Küster's system. It will be noted that the eighteen-membered, conjugated ring system is maintained in all three of them. The parent substances of these three groups are *porphin*, *dihydroporphin*, and *tetrahydroporphin*. The first has been prepared synthetically by Fischer (in 1935) and by Rothemund (1936).

In Rothemund's method (*cf.* also Aronoff and Calvin 1943), pyrrole and formaldehyde are condensed in methanol:

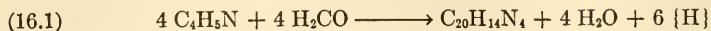

The product contains 11 double bonds, as against eight in the four pyrrole nuclei; condensation is thus accompanied by the removal of six hydrogen atoms. Of the 11 double bonds in porphin, nine form a closed conjugated system, and two are "semi-isolated." This allows of several structures, which may be mesomeric or isomeric, depending on the position of the imino hydrogens.

In the porphin formula (16.VI), the two structures, *A* and *B*, are isomeric—one is a "lateral," another a "diagonal." Each consists of two mesomeric "Kékulé structures." It may be, however, that the two central hydrogen atoms are situated symmetrically between two adjacent nitrogen atoms. This would make structures *A* and *B* mesomeric.

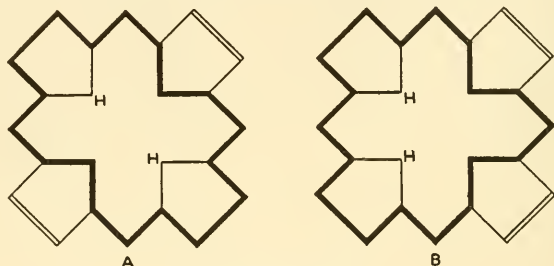

Formula 16.VI.

The "diagonal" and "lateral" forms of porphin.

It is interesting that the structure with nine conjugated double bonds arises in preference to the more symmetric structures with eight or ten conjugated double bonds, represented by 16.VII *A* and 16.VII *B*.

The derivatives of porphin are called *porphyrins*; hemin is an iron complex of a porphyrin; protochlorophyll is a magnesium complex of another porphyrin. Chlorophyll is derived (as mentioned above) from

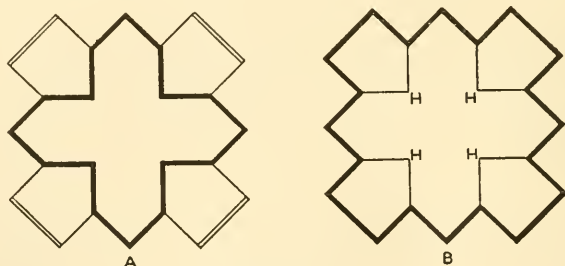

Formula 16.VII.

Ring systems $C_{20}N_4H_{12}$ (*A*, with eight conjugated double bonds), and $C_{20}N_4H_8$ (*B*, with ten conjugated double bonds), which appear to be less favorable than the porphin system $C_{20}N_4H_{10}$ with nine double bonds.

dihydroporphin, and *bacteriochlorophyll* from *tetrahydroporphin*, compounds in which one or both of the semi-isolated double bonds, present in porphin, are hydrogenated, while the conjugated bond system is left intact.

Fischer designates dihydroporphin derivatives as *chlorins* if they do not contain the cyclopentanone ring V, and *phorbins* if they do. The presence of magnesium is indicated by the term *phyllin*, the presence of phytol by the term *phytin*. The accompanying scheme may help to retain the meaning of these terms.

Term	Magnesium	Phytol	Cyclopentanone ring	Two extra H atoms
Phyllin	+	+	+	+
Phytin	-	+	+	+
Phorbide	-	-	+	+
Chlorin	-	-	-	+
Porphin	-	-	-	-

Compounds with an ethyl instead of a vinyl group in nucleus I are indicated by the prefix *meso*; compounds of the *b*-series are sometimes referred to as *rhodins* (instead of *chlorins*).

Specific compounds of each of these groups are designated by prefixes. The compounds which have the same substituents as chlorophyll are designated by the prefix *pheo*—*e. g.*, *pheophytin* (*a* or *b*), and *pheophorbide* (*a* or *b*). The following scheme illustrates the relationship between these compounds, the chlorophylls, and the chlorophyllides.

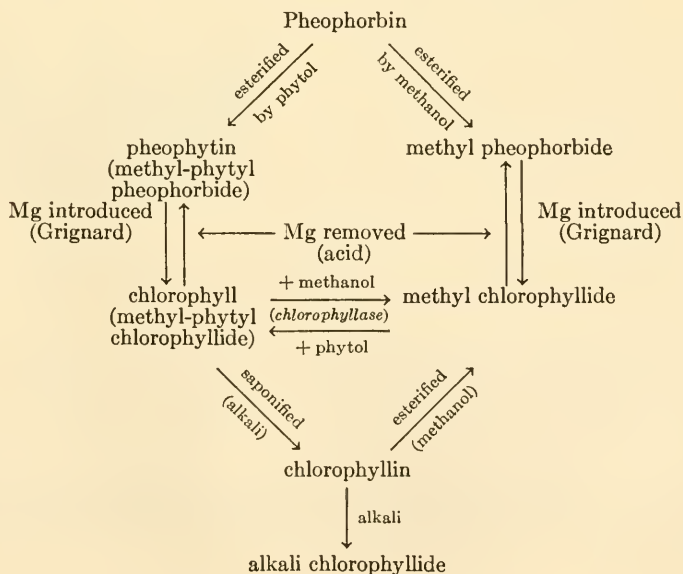

5. Shape and Size of the Chlorophyll Molecule

Formulas 16.III and 16.I show that chlorophyllin forms a large, flat, almost square, "head" of the chlorophyll molecule, to which phytol is attached as a long flexible "tail." From the standard nuclear distances and bond angles, one can estimate that the approximately square porphyrin "disc" has an area of 100–110 square angstroms; the "hole" between the four nitrogen atoms, where the magnesium is located, is approximately 2.5 Å in diameter. The covalent diameter of magnesium in crystals is 2.4 Å, so that it fits snugly into the hole.

X-ray experiments by Ketelaar and Hanson (1937) and Hanson (1939) showed that the actual area of chlorophyllin, with all its substituents, is much greater than the value estimated above. Because of the waxy nature of chlorophyll, these experiments were carried out with *ethyl chlorophyllide*. Its crystals are trigonal hemiedric (symmetry class C_3). The elementary cell has a length of 38.4 Å (along the *c*-axis), and a volume of 2660 Å³. The pycnometrically determined density is 1.28. This shows that the elementary cell contains three molecules—an assumption which leads to a calculated density of 1.23. Each molecule thus occupies 887 Å³. The planes of maximal density are 2116, 1216, and 1126, inclined by about 55° to the basal plane of the elementary cell. These planes must be occupied by the porphyrin plates. The latter are thus stacked obliquely, like books on a partly empty shelf (Fig. 49a).

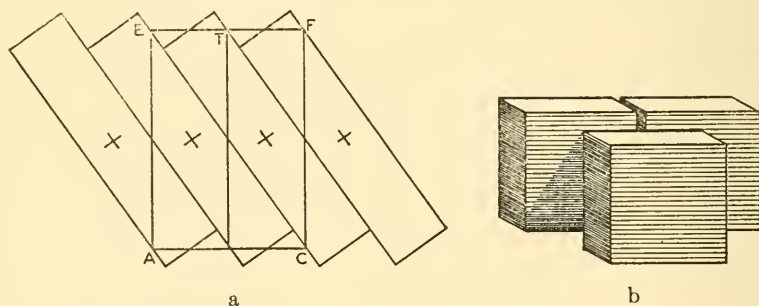

FIG. 49.—Crystal structure of chlorophyllide (after Hanson 1939).

Each plate is, however, displaced against its neighbor by one-half of its width (as shown in Fig. 49b). The frontal area of the porphyrin plates is $15.48 \times 15.62 = 242 \text{ Å}^2$. This gives $887/242 = 3.66 \text{ Å}$ for their thickness.*

* Hanson gives 3.87 Å for the thickness of the ethyl chlorophyllide molecule, but does not explain the discrepancy between the volume of the molecule, $15.48 \times 15.62 \times 3.87 = 936 \text{ Å}^3$, calculated from this thickness, and the smaller value (887 Å³) which follows from density.

The narrow sides of the chlorophyllin plates have areas of $3.66 \times 15.48 = 56.6 \text{ \AA}^2$; but, because of the 55° inclination, each molecule requires an area of 69.2 \AA^2 on the basal plane. A monomolecular layer consisting of such obliquely stacked chlorophyllide molecules is 12.8 \AA thick. In the crystal, a second layer, situated on top of the first, has all its molecules rotated around the *c*-axis by 120° ; a third consists of molecules rotated by 240° , while the fourth layer is a repetition of the first (thus, the height of the elementary cell is three times the thickness of a single layer). In other words, the crystal contains a threefold screw axis.

The area of 242 \AA^2 , deduced from x-ray measurements, is more than twice the $100\text{--}110 \text{ \AA}^2$ estimated above for the nonsubstituted porphin system. This difference shows that, although the side chains probably stick out from the plane of the porphin plate, they nevertheless increase considerably the area occupied by the molecule in this plane.

Experiments on ethyl chlorophyllide monolayers on water (Hanson 1937, 1939) showed that the extrapolated surface which such a layer occupies at zero osmotic pressure (at *pH* 5.4) is 70 \AA^2 . This value agrees well with the value of 69 \AA^2 derived above from the x-ray analysis for the area taken by an ethyl chlorophyllide molecule in the basal plane of the crystal. Hanson concluded that films of ethyl chlorophyllide on water are crystalline monolayers, composed of flat molecules stacked obliquely to form an angle of 55° with the surface of water. He suggested that the active, hydrophilic part of the molecule is the cyclopentanone ring V, with its easily enolizable keto group (*cf.* page 444).

In the case of waxy chlorophyll (as distinct from chlorophyllide) the only result which could be derived from x-ray experiments was the occurrence of a periodicity of 4.2 \AA , which must be interpreted as the thickness of the chlorophyll molecule. Experiments with chlorophyll surface films showed that the surface requirement of chlorophyll increases with increasing *pH*, probably because of a progressive enolization and consequent hydration of the cyclopentanone ring. At *pH* 4.1 (the lowest *pH* at which experiments can be performed without converting chlorophyll into pheophytin), the extrapolated surface requirement at zero osmotic pressure is 106 \AA^2 . It appears that hydration is negligible at this low *pH*. Thus, phytol increases by 37 \AA^2 the area occupied by the chlorophyll molecule in the surface film. At the higher *pH*, the surface requirement of chlorophyll is considerably larger, but the film is also more compressible; both effects can be ascribed to hydration. (Hanson calls the layer formed at *pH* 4.1 "dry" or "crystalline," and that formed in alkaline media—*e. g.*, at *pH* 7.6—"viscous.")

B. CHEMICAL PROPERTIES*

We know that chlorophyll sensitizes the reduction of carbon dioxide by water. It is probable that, in carrying out this function, it enters into reversible reactions with the substrates of photosynthesis (*cf.* Chapter 19). Two types of such reactions can be envisaged—complex formation, and oxidation-reduction. In the first case, chlorophyll would serve as an “acceptor” for carbon dioxide (*cf.* Chapter 8) or water (*cf.* Chapter 11), or both. In the second case, chlorophyll would play the part of an oxidation-reduction catalyst (*i. e.*, an acceptor for hydrogen atoms or electrons). The hypothetical complex formation of chlorophyll with carbon dioxide or water should be a “dark” reaction, while the reversible oxidation-reduction of chlorophyll should be a photochemical reaction, with light activating either the “forward” or the “back” step, or both.

In considering the chemical properties of chlorophyll in relation to the role of this pigment in photosynthesis, we are thus interested, *first* in the interaction of chlorophyll with water and carbon dioxide and *second* in the capacity of chlorophyll for reversible oxidation-reduction.

1. Chlorophyll and Water

Willstätter and Stoll (1913) and Fischer and Stern have assumed that both chlorophyll and the alkyl chlorophyllides contain one-half mole of water per mole. Rabinowitch (1938) has noted, however, that ethyl chlorophyllide (and, to a smaller extent, chlorophyll as well) has “zeolitic” properties (*i. e.*, it reversibly absorbs different gases, including water vapor, the absorbed quantity being a smooth function of temperature and of the partial pressure of the gas). At room temperature and in contact with saturated water vapor, ethyl chlorophyllide takes up about one-half mole of water per mole; but this is probably much less than the saturation value; the latter may correspond to one or even two moles per mole.

Additional data about the affinity of chlorophyll for water have been contributed by Hanson (1939). As mentioned above, he found, in studying chlorophyll monolayers on water, that their surface requirement increases with increasing alkalinity, and attributed this to a “swelling” of the molecules by water. Progress in swelling which follows a decrease in $[H^+]$ can be interpreted as a tendency of the film to lose hydrogen ions in water and to gather water dipoles around the negative charges. Hanson concluded that negative groups must be responsible for hydration; this ruled out magnesium as the hydration center (which seemed at first to be the most likely assumption, especially since the surface requirement of magnesium-free compounds was found to be independent

* Bibliography, page 468.

of pH). Other arguments against magnesium as the hydration center are the hygroscopicity of magnesium-free derivatives of chlorophyll and the position of magnesium in the monolayer (marked by a cross in Fig. 49a) which should preclude its contact with water. Considering probable negative hydration centers, Hanson decided in favor of the cyclopentanone ring V, with its enolizable carbonyl group. (The pH -dependence of the surface area of allomerized chlorophyll—which, according to page 459, has no capacity for enolization—is quite different from that of the nonallomerized compound.) The hygroscopicity is somewhat larger in chlorophyll *b* than in chlorophyll *a*, and may be ascribed to the effect of a second carbonyl group. Hanson interpreted the disappearance of the pH effects in magnesium-free compounds as an *indirect* influence of magnesium on the properties of the cyclopentanone ring, an influence which has been noticed on several occasions (see pages 454 and 462). Hanson treated the whole theory of photosynthesis from the point of view of the primary formation of a chlorophyll–water complex, stressing that the pH of the chloroplasts is probably alkaline ($pH = 7.0$ to 7.5 , according to Menke), and that this is the region in which chlorophyll hydration reaches its maximum.

In chapter 7 we have considered, with van Niel (and others) the decomposition or oxidation of water as a possible primary photochemical process in photosynthesis; Hanson's concept of a chlorophyll–water complex obviously fits into this theory. However, hygroscopicity is such a common property of organic compounds that the hygroscopicity of chlorophyll can scarcely be considered as an important argument in favor of this specific chemical theory of photosynthesis. Furthermore, if the hygroscopicity of chlorophyll in the cell is not larger than that of solid chlorophyll *in vitro*, less than one-half of all chlorophyll molecules in the chloroplast are hydrated at room temperature—and if this is so, how can light quanta absorbed by *all* chlorophyll molecules, be utilized for photosynthesis? (This remark is not meant as an argument *against* the primary water decomposition theory of photosynthesis, but merely as an indication that observations of the hygroscopicity of chlorophyll *in vitro* cannot be quoted as arguments *for* this theory.)

2. Chlorophyll and Carbon Dioxide

In chapter 7 we have also considered, as an alternative to the hypothesis of a primary photochemical oxidation of water, the hypothesis of a primary photochemical reduction of carbon dioxide. The first detailed theory of this type was suggested by Willstätter and Stoll (1918), and was described on page 287. These authors thought that the proof of a chemical association between chlorophyll and carbon dioxide would be an important argument in favor of their theory. They found

that *molecular* solutions of chlorophyll are not affected by carbon dioxide, but that *colloidal* solutions in water show a twofold interaction with carbonic acid: a *reversible absorption* and a superimposed *irreversible chemical reaction*—the latter being the well-known conversion of chlorophyll into the magnesium-free pheophytin (page 447), caused by all acids. The reversible binding of carbon dioxide is increased, and the velocity of the irreversible transformation is decreased, when the solutions are cooled to 0°. Under these conditions, approximately 0.25 mole of carbon dioxide is reversibly absorbed by one mole of chlorophyll, from an atmosphere of pure carbon dioxide.

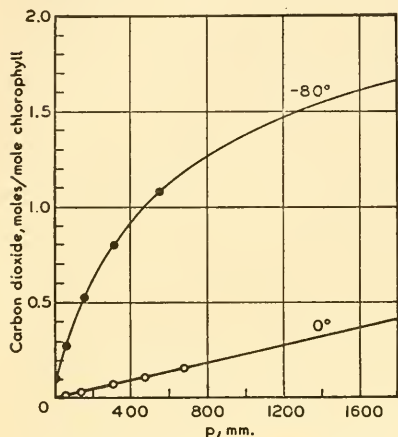

FIG. 50.—Sorption isotherms for carbon dioxide in solid ethyl chlorophyllide (after Rabinowitch 1938).

sorption is reversible and equilibrium is established in a few seconds. The data can be represented by equation (16.2), in which S_p is the sorption under pressure p and S_0 the extrapolated maximum sorption under high pressure:

$$(16.2) \quad \frac{S_p}{S_0 - S_p} = \text{const.} \times p$$

The (extrapolated) saturation S_0 corresponds to the uptake of approximately two moles of carbon dioxide by one mole of chlorophyllide.

When *chlorophyll* was used instead of the crystalline ethyl chlorophyllide, a much weaker and slower sorption of carbon dioxide was found. This can be attributed to the waxy consistency of the material, which causes many crystal channels to be blocked and makes many sorption centers unavailable. Smith (1940) also found that only 0.08 mole of carbon dioxide is taken up by one mole of solid chlorophyll under a pressure of one atmosphere; the sorption is proportional to the pressure, which shows that saturation is far away.

Pheophytin absorbs about 50% less carbon dioxide than ethyl chlorophyllide, as shown by table 16.I, which summarizes the results of the three investigations mentioned above. The table shows that the reversible binding of carbon dioxide by colloidal chlorophyll is probably identical in nature with the sorption of this gas by solid chlorophyllide.

TABLE 16.I
 REVERSIBLE CARBON DIOXIDE SORPTION AT 0° C.
 (1 ATM. PARTIAL PRESSURE)

Compound	Moles per mole		
	Rabinowitch	Willstätter-Stoll	Smith
Ethyl chlorophyllide	0.22	0.25	
Colloidal chlorophyll			
Solid chlorophyll	0.05		0.06
Pheophytin	0.10		0.08

The existence of a certain affinity of chlorophyll for carbon dioxide is thus established beyond question. This affinity may be "chemical" or "physical." Willstätter and Stoll (1918) suggested that the reversible binding of carbonic acid constitutes the first step in the conversion of chlorophyll into pheophytin:

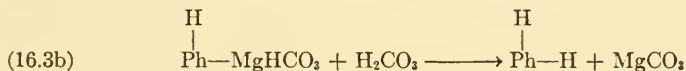
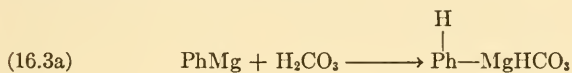

where Ph stands for the phytin radical, PhMg for chlorophyll, PhH₂ for pheophytin, and PhHMgHCO₃ for an intermediary "chlorophyll bicarbonate." Reaction (16.3) can be written as follows to show its ionic mechanism:

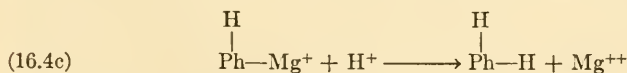
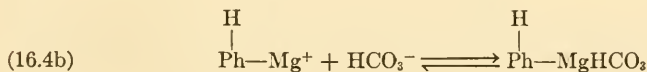
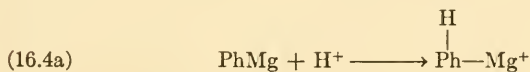

Willstätter and Stoll saw a confirmation of absorption mechanism (16.3a) or (16.4b) in the fact that chlorophyll does not bind carbon dioxide in organic solutions (which contain no carbonic acid molecules or bicarbonate ions). However, if we assume the identity of the carbon dioxide absorption by solid chlorophyll and by colloidal chlorophyll solutions, the ionic mechanism is ruled out, and the lack of sorptive power of chlorophyll solutions must be explained in a different way, for example, by the saturation of the sorption centers by solvent molecules.

Chapter 8 described several chemical mechanisms by which chlorophyll could conceivably bind carbon dioxide in a nonionic reaction. One of them is *carboxylation*—*e. g.*, entrance of the $-\text{COO}-$ group between the carbon atom in position 10 and the

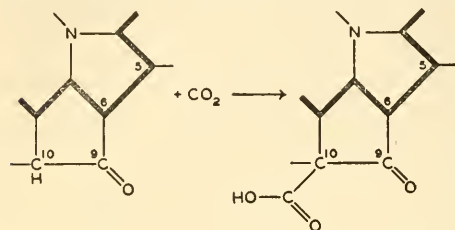

“labile” hydrogen attached to it (equation 16.5). However, no such carboxylation has been observed so far. To the contrary, many chlorophyll derivatives have a tendency for *decarboxylation*: for instance, pheophorbide a can lose the $-\text{COOCH}_3$ group in position 10 by prolonged standing in 20% hydrochloric acid. It was mentioned on pp. 91 *et seq.* that Baur, in one of his hypotheses concerning the chemical mechanism of photosynthesis, suggested that the immediate substrate of photoreduction is a carboxyl group in chlorophyll, which is eliminated after reduction and restored by means of a new molecule of carbon dioxide. However, no case of *reversible* decarboxylation is as yet known in chlorophyll chemistry.

In addition to reversible carboxylation, a chemical binding of nonionized carbon dioxide could conceivably be brought about by a reaction of the *carbamation* type. Chlorophyll has no nitrogen–hydrogen groups; but it was pointed out on page 183 that, in analogy to carbon–metal bonds, nitrogen–metal bonds may have a higher affinity for carbon dioxide than have the nitrogen–hydrogen bonds. We may thus think of equilibria of the following type:

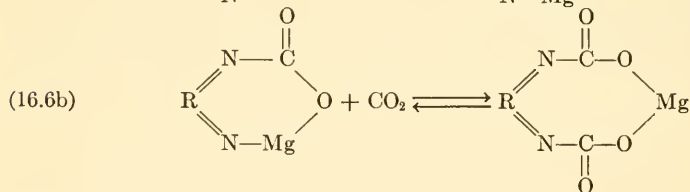
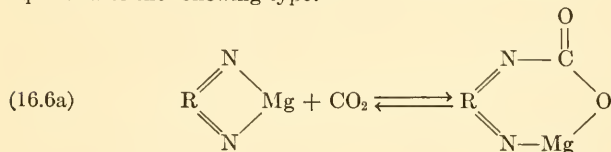

Reaction (16.6a, b) could explain the absorption of *two* molecules of carbon dioxide by one molecule of chlorophyll (as extrapolated on page 452).

In the case of pheophytin, the absorption of carbon dioxide could be attributed, by analogy with (16.6), to a carbamation of the *imino* groups. The capacity of pheophytin for carbon dioxide absorption is smaller than that of ethyl chlorophyllide, but so is its capacity for hydration. The lower hygroscopicity of pheophytin was attributed by Hanson (page 451) to the influence of magnesium on the tendency of the cyclopentanone ring for enolization. One could ask whether a similar hypothesis could be applied also to the absorption of carbon dioxide—thus locating this absorption in the cyclopentanone ring. (The hypothesis of a carboxylation in position 10 would fit into this picture.) However, it seems more probable that the two species, CO_2 and H_2O , are attracted to different regions of the chlorophyll molecule. Rabinowitch has observed that the capacity for binding carbon dioxide does not depend on whether the chlorophyllide molecules contain water or have been desiccated in high vacuum. The fact that carbon dioxide is bound by colloidal chlorophyll under water also indicates that

the two sorption phenomena do not interfere with each other. If we assume, with Hanson, that hydration is associated with an enolization in position 9, hydrated molecules should be incapable of absorbing carbon dioxide in position 10. Perhaps the water molecules are attracted by the cyclopentanone ring, while the carbon dioxide molecules are bound by the magnesium in chlorophyll or by the imino groups in pheophytin.

It must be realized that, even if the existence of a stoichiometric ratio between chlorophyll and carbon dioxide (in the saturated state) were definitely established (so far, it is only made plausible by extrapolation), this would not prove that the binding of carbon dioxide is due to a true chemical reaction (*e. g.*, of one of the reactions 16.3, 16.5, or 16.6). When gases are taken up by crystals, they enter channels and holes in the regular lattice, each of which has room for one or a small number of sorbate molecules. Thus, stoichiometric ratios may arise even if the sorption is due to "nonchemical" attraction forces. Several observations indicate that the sorption of carbon dioxide (and water) by chlorophyll is "zeolitic" in nature. In the first place, the sorption isotherms are smooth (Fig. 50) and similar to those of the zeolites. (However, it may be argued that smooth isotherms can occur also in a chemical equilibrium, if the binding of a gas does not destroy the crystal lattice of the solid, that is, does not create a new phase.) In the second place, one may quote observations on the binding by solid chlorophyll of gases other than carbon dioxide and water: Rabinowitch (1938) found, for example, that nitrous oxide, N_2O (whose volatility is similar to that of carbon dioxide), is absorbed by ethyl chlorophyllide in roughly the same quantity as carbon dioxide. Similarly, Smith has observed the uptake of small quantities of hydrogen and nitrogen by solid chlorophyll (3-4% of the quantity of carbon dioxide taken up under the same pressure). Both observations indicate an indiscriminate "zeolitic" affinity to gases, in the reverse order of their volatilities, rather than a selective chemical affinity for carbon dioxide. To sum up—the uptake of carbon dioxide by chlorophyll and its derivatives can be explained by two or three different chemical reactions, as well as by an indiscriminate physical absorption.

Whatever explanation will ultimately prove to be the correct one, it seems doubtful whether the affinity of chlorophyll *in vitro* to carbon dioxide bears any relation to photosynthesis at all. It was shown in chapter 8 that leaves possess two mechanisms of reversible carbon dioxide absorption—one of large capacity but weak affinity, and one of small capacity but strong affinity. The first mechanism, which accounts for the bulk of the carbon dioxide absorbed under carbon dioxide pressures of the order of one atmosphere, certainly has no connection with chlorophyll, since it operates equally well in nonchlorophyllous tissues, and is capable of binding twenty times as much carbon dioxide as there is

chlorophyll in green leaves. (According to page 194, this absorption is caused by buffer equilibria with phosphates and bicarbonates.) The second mechanism (revealed by experiments with radioactive $C^{*}O_2$, cf. page 201, and "pickup" phenomena, page 206) is based on the presence of a carbon dioxide absorber, whose concentration is of the same order of magnitude as that of chlorophyll, but whose affinity for carbon dioxide is many times stronger. In short, while chlorophyll is present in *quantities* roughly equal to those of the "strong" carbon dioxide acceptor, its *affinity* for carbon dioxide is not larger than that of the "weak" absorber; consequently, it cannot contribute markedly to the uptake of carbon dioxide either under low or under high pressures.

One could suggest that chlorophyll *in vivo* has a stronger affinity for carbon dioxide than chlorophyll *in vitro*, e. g., because of its association with a protein. However, the capacity of *Chlorella* for carbon dioxide fixation in the dark was found not to be affected by variations in chlorophyll content; and radioactive indicator experiments showed that the carbon dioxide-acceptor complex can be extracted by hot water, while chlorophyll remains in the cells (page 204). If one adds that some experiments point to the location of the carbon dioxide acceptor in the cytoplasm *outside* the chloroplasts (page 204), one can scarcely avoid the conclusion that chlorophyll probably bears no relation at all to the primary fixation of carbon dioxide in photosynthesis, and that the approximate equality in concentration between the acceptor and chlorophyll is fortuitous.

Thus, contrary to the conclusions of Willstätter and Stoll, the results of the study of the interaction of chlorophyll with carbon dioxide *in vitro* discourage the development of chemical theories based on the combination of chlorophyll with carbon dioxide, whether by physical sorption, carboxylation, or "chlorophyll bicarbonate" formation.

This conclusion does not affect the hypothesis, expressed by equations (16.3), that the elimination of magnesium from chlorophyll by carbonic acid includes, as a preliminary step, the formation of a chlorophyll magnesium bicarbonate (it only denies the importance of such a compound for photosynthesis). On page 493, we will find some photochemical evidence in favor of this two-step mechanism of "pheophytinization."

3. Oxidation and Reduction of Chlorophyll

We shall discuss here, not the irreversible oxidative decomposition of chlorophyll, or the equally irreversible catalytic hydrogenation of its double bond system, but only milder changes, which could conceivably bear some relation to the reversible transformation of chlorophyll in photosynthesis.

Despite a considerable number of investigations dealing with the oxidation and reduction of chlorophyll, this problem has not yet been

satisfactorily solved. Many organic dyestuffs—*e. g.*, indigo, methylene blue, thionine—are among the best-known examples of reversible oxidation-reduction systems. The colored form, which usually possesses a “quinonoid” structure, is an oxidant, while the reductant is colorless or only weakly colored (*e. g.*, indigo white, leuco methylene blue, etc.). Seldom is the reductant the colored form and the oxidant the colorless form (as in Michaelis’ “viologens”).

It has often been suggested that chlorophyll, too, may possess a colorless or weakly colored reduced form, a “leuco chlorophyll,” from which it can be re-formed by oxidation. It has also been postulated that chlorophyll is formed in the plants by oxidation (or photooxidation) of a colorless “precursor,” and many investigators have attempted to isolate the latter from seeds or etiolated seedlings (*cf.* Chapter 15, page 404). However, the only compound which has been isolated in sufficient quantity to make its analysis possible—the “protochlorophyll” from pumpkin seeds—has proved to be an *oxidation product*, rather than a reduction product of chlorophyll (page 445). This leaves us with only the “etiolin,” “chlorophyllogen,” “leucophyll,” and other hypothetical chlorophyll “precursors,” which have never been isolated and studied in the pure form, as alleged *reduced* forms of chlorophyll in nature.

Attempts to prepare a “leuco chlorophyll” *in vitro* also have not been completely successful. Many porphyrins can be reduced to colorless “porphyrinogens” with the uptake of two, four, or six hydrogen atoms by the conjugated porphin system, and restored by oxidation, *e. g.*, by atmospheric oxygen. A similar reversible reduction of chlorophyll and its derivatives has been described by Timiriazev (1903) and Kuhn and Winterstein (1933). Timiriazev reduced chlorophyll in pyridine solution by means of zinc and organic acids, and obtained a colorless solution which slowly became green again upon exposure to air. Kuhn and Winterstein found that the product obtained from chlorophyll by reduction and reoxidation gave a positive “phase test” (*cf.* below), and had the unchanged elementary composition and absorption spectrum of chlorophyll. However, Albers, Knorr, and Rothemund (1935) found that its fluorescence spectrum is different from that of the original pigment, and Rothemund (1935) found differences in the absorption spectra as well. The “cleavage test” (disruption of the cyclopentanone ring by alkali) gave a product different from “chlorin *e*” (which is the product of cleavage of intact chlorophyll *a*). The irreversibility of chlorophyll reduction by zinc and acids was confirmed by Godnev (1939).

What changes were caused in these experiments by reduction and re-oxidation is not known. Conant and Hyde (1931) found porphyrins among products of reduction by hydrosulfite or $\text{Pd} + \text{H}_2$ and oxidation by air. It seems likely that hydrogenation of the vinyl group in posi-

tion 2 is an important source of complications. This group is usually the first to be attacked by reductants—*e. g.*, the reduction of methyl or ethyl chlorophyllide by palladium-hydrogen in dioxane can be carried out so as to cause the uptake of only one molecule of hydrogen—and this molecule goes to the vinyl group. The catalytic hydrogenation product of chlorophyll *a*, whose fluorescence and absorption spectra were studied by Knorr and Albers (1942), probably also is a meso derivative. The reduction can be pushed further, until a colorless “leuco” compound is obtained, but a subsequent reoxidation, while restoring the conjugated double bond system (and thus the color) fails to restore the vinyl group. The net result is the retention of two hydrogen atoms and the transformation of the original unsaturated compound into the corresponding saturated meso derivative. This is probably what happened also in the experiments of Timiriázev and Kuhn and Winterstein.

The hydrogenation of the semi-isolated double bond in the nuclear system, whose presence is shown by formulas 16.III, also could occur before the attack on the conjugated double-bond system. (Stoll and Wiedemann, 1932, had interpreted in this way the phenomena which were later attributed to the hydrogenation of the vinyl group.) This reaction would convert compounds of the chlorophyll class into the corresponding compounds of the bacteriochlorophyll class; it could be reversible, since bacteriochlorophyll derivatives are known to lose their two excess hydrogen atoms easily.

Besides its several *reducible* groups, chlorophyll and its derivatives contain at least two potential centers of *oxidation*—the two “extra” hydrogen atoms in positions 7 and 8, and the “lone” hydrogen atom in position 10. In addition, the vinyl group may again cause complications, this time by its oxidation to a $-\text{CO}-\text{CH}_3$ group (so-called “oxo reaction”).

By an internal oxidation-reduction mechanism, the hydrogen atoms in positions 5 and 6, can be lost even in reduction experiments. Fischer and Bub (1937) found that, when pheophorbide *a* is reduced by palladium and hydrogen in glacial acetic acid, the resulting leuco compound is optically inactive, that is, it does not contain the hydrogen atoms which made the carbon atoms 7 and 8 asymmetric. Upon reoxidation, these hydrogen atoms do not re-appear in their original positions; since, at the same time, two hydrogen atoms remain attached to the vinyl group (as was described above) the net result of reduction and reoxidation is an *isomerization*, the original chlorin or phorbide having been converted into an isomeric mesoporphyrin.

The treatment of chlorophyll derivatives with hydriodic acid usually has the same isomerizing effect. One may imagine that, while hydrogen iodide reduces the vinyl group, the liberated iodine oxidizes the hydrogen

atoms in positions 5 and 6, so that the net result is a hydrogen iodide-catalyzed internal oxidation-reduction. This interpretation implies that the oxidation-reduction potential of the system porphin-dehydroporphin is more positive than that of the system vinyl chlorin-mesochlorin.

The oxidation of the H atom in position 10 is supposed to play an important part in the so-called *allomerization* of chlorophyll and its derivatives. This transformation occurs when alcoholic solutions of the pigments are exposed to air. The solution color remains the same, and the absorption spectrum is unchanged (at least in the first approximation, *cf.* Conant, Dietz, Bailey, and Kamerling 1931; no reliable extinction curve of allomerized chlorophyll has yet been published). The main difference between allomerized and intact chlorophyll is in the behavior towards alkali. Ether solutions of intact chlorophyll give the so-called "Molisch phase test"—transient apparition of a brownish yellow color (in chlorophyll *a*) or a brownish red color (in chlorophyll *b*) upon the addition of alcoholic alkali (in the cold and in the presence of air). The color soon reverts to green: and the final result of the phase reaction turns out to be the severance of the cyclopentanone ring between carbon atoms 9 and 10, by alcoholysis, *i. e.*, the conversion of a phorbins into a chlorin. According to Fischer, Elser, and Plötz (1932) and Fischer and Siebel (1933), the phase test is initiated by the enolization of the carbonyl group in position 9, induced by alkali:

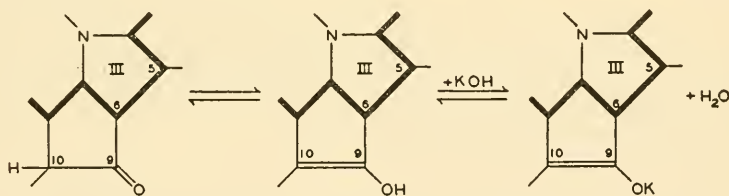

Thus, a double bond is formed between C(10) and C(9); it causes a strain in the cyclopentanone ring, so that this ring becomes subject to disruption by alcoholysis. The alkali salt of the enolized form is supposed to be present in the brown phase. If the alkali is extracted at once by shaking the brown ether-alcohol solution with water, chlorophyll can be regenerated from the ether fraction, and is found to be unchanged. The first stage of the phase test is thus reversible; but after the green color has returned, the reaction cannot be reversed except possibly by special methods by which chlorins can be converted into phorbins.

Although attributing the "brown phase" to an enolate of chlorophyll seems plausible from the chemical point of view, a certain difficulty is encountered in the interpretation of the color change. The spectrum of the brown phase is unknown, but there can be no doubt that the main red absorption band of chlorophyll is either absent or strongly reduced

in intensity. From what we know about the occurrence of this band in chlorins and phorbins (*cf.* Vol. II, Chapter 21), one would not expect it to disappear as long as the three chromophoric factors—the conjugated double bond system, the hydrogenated nucleus IV, and the magnesium atom—remain intact. Enolization in a side chain can scarcely be expected to affect the spectrum to such an extent.

One could suggest that the alkali enolate is ionized, and recall that ionization often changes the color of dyes (acid-base indicators); but this occurs only when ionization affects the resonance in the chromophoric system, and there is no reason why any such effect should be produced by the ionization of chlorophyll in the cyclopentanone ring. It looks as if something must happen to the two hydrogen atoms in nucleus IV during the “brown phase.” Perhaps these atoms can slide from positions 7 and 8 to positions 9 and 10, thus creating a tautomeric equilibrium between the structures:

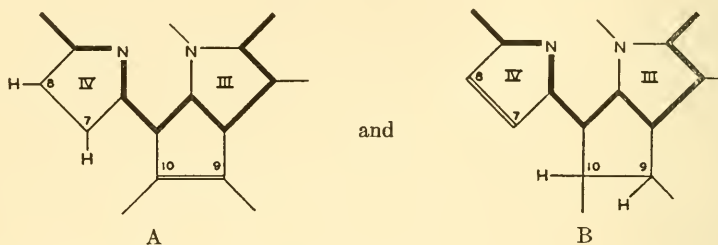

Form (B) may be responsible for the brown color, and form (A) (which needs only to be present in a small proportion) for the gradual conversion into chlorins and consequent disappearance of the brown phase. Another hypothesis, described on page 493, postulates that the brown phase is a product of a reversible dismutation of enolized and ordinary chlorophyll (*cf.* Eq. 18.11 a, b, c), or of a reversible oxidation-reduction reaction between enolized chlorophyll and the solvent.

The phase test has often been used to control the freshness of chlorophyll preparations (although in its usual qualitative form, it obviously does not detect *partial* allomerization). Apart from incapacity to give the “brown phase,” allomerized chlorophyll is characterized by the different products it gives in the “cleavage test” (*cf.* page 457). In the case of the chlorophyllides, allomerization also causes the loss of good crystallizability.

If the “brown phase” is caused by an enolization of the carbonyl group in position 9 involving the hydrogen atom from the neighboring atom C(10), it is natural to attribute the nonoccurrence of this phase in allomerized chlorophyll to the removal or binding of this hydrogen atom, *i. e.*, to an oxidation of the CH— group. Conant, Hyde, Moyer, and Dietz (1931) were the first to interpret allomerization as an oxidation, and Conant, Dietz, Bailey, and Kamerling (1931) proved that one mole of oxygen is consumed in the slow allomerization of one mole of chloro-

phyll in air. They suggested that two atoms of hydrogen are lost in this process (with the formation of one mole of hydrogen peroxide). As mentioned above, allomerization was later attributed (by Stoll and Fischer) to the oxidation of the "lone" hydrogen atom in position 10. To explain how a molecule of oxygen can be consumed by the oxidation of *one* atom of hydrogen, Fischer suggested the formation of a "chlorophyll peroxide":

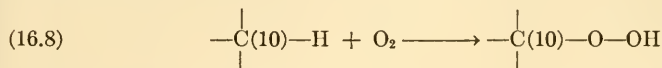

He found that allomerization can be achieved also by means of *quinone* (instead of air), and interpreted this as a result of the formation of a hydroquinone ether (instead of peroxide):

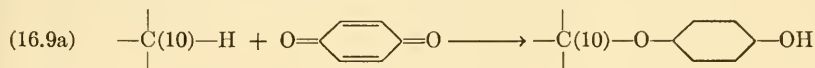

and subsequent alcoholysis:

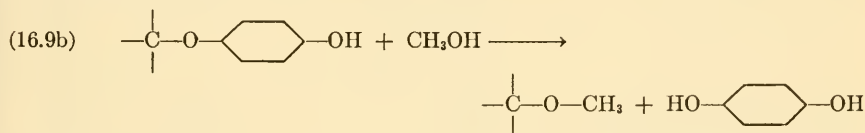

The final products are hydroquinone and a compound with a $\text{CH}_3\text{O}-$ group in position 10 (10-methoxychlorophyll).

The chlorophyll peroxide assumed in (16.8), has not been isolated in substance; but the autoxidation of the carbon atom in position 10 is proved by the fact that hydriodic acid converts allomerized chlorophyll into a porphyrin (so-called pheoporphyrin a_7) which contains an hydroxyl group in position 10. Since no allomerization occurs in the absence of alcohol (see Table 16.II), while even 3% alcohol in pyridine is sufficient to bring it about, it is possible that the chlorophyll peroxide postulated in (16.8) is only an unstable intermediate (analogous to the hydroquinone ether in 16.9a), and that reaction (16.8) is completed by the transfer of oxygen to alcohol:

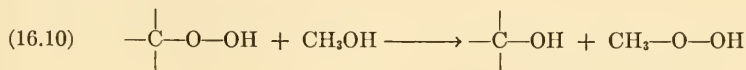

leading to the formation of methyl hydroperoxide, and of a 10-hydroxychlorophyll.

In addition to the solvent effect, table 16.II also shows the importance of *magnesium* for the oxygen absorption by chlorophyll and its derivatives. While elimination of phytol has no influence on allomerization, the latter is prevented by the elimination of magnesium.

TABLE 16.II
 OXYGEN ABSORPTION BY CHLOROPHYLL DERIVATIVES
 (FISCHER AND RIEDMEIER, 1933)

(A) Substitution Effect in Ethanol.

Compound	Moles oxygen per mole	Duration of experiment, hrs.
Chlorophyll (<i>a + b</i>)	0.96	8
Methyl chlorophyllide <i>a</i>	0.93	11
Methyl chlorophyllide <i>b</i>	1.08	19
Pheophorbide <i>a</i>	0	30
Methyl pheophorbide <i>a</i>	0	24

(B) Solvent Effect (with Methyl Chlorophyllide).

Compound	Solvent	Moles oxygen per mole	Duration of expt., hrs.
Methyl chlorophyllide <i>a</i>	C ₂ H ₅ OH (100%)	0.93	8
Methyl chlorophyllide (<i>a + b</i>)	C ₂ H ₅ OH (85%) + pyridine (15%)	1.11	24
Methyl chlorophyllide (<i>a + b</i>)	C ₂ H ₅ OH (3%) + pyridine (97%)	0.68	120
Methyl chlorophyllide (<i>a + b</i>)	Pyridine (100%)	Traces	120
Methyl chlorophyllide (<i>a + b</i>)	<i>n</i> -Propanol	1.10	16

If the absorption of oxygen is localized in position 10, as assumed by Fischer, the necessity of magnesium for this reaction is another illustration of the influence of magnesium on the properties of the cyclopentanone ring, mentioned several times above.

While it seems definite that allomerization consists of an oxidation of the CH— group in position 10, it is less certain whether the allomerized product is a "chlorophyll peroxide" or an "hydroxychlorophyll." The chemical structure and spectrum of allomerized chlorophyll certainly deserve closer study, since it is the simplest oxidation product of chlorophyll. It would also be important to know whether this oxidation can be conducted in a reversible way; so far, allomerization has usually been treated as an irreversible change (although Stoll and Wiedemann, 1932, asserted that the allomerization of compounds of the *b*-series can be reversed by mild reductants).

Allomerization can be delayed or prevented by small quantities of acid (Willstätter and Stoll) or by the presence of reducing substances (Stoll and Wiedemann). Allomerized chlorophyll still reacts with cold alkali under the conditions of the phase test, but gives green chlorins directly, without the intermediate formation of a "brown phase." In preparation for a later discussion (pages 465 and 493), it may be useful

to point out that the absence of a visible brown phase does not necessarily prove that no colorless intermediate product is formed in the alkali cleavage of allomerized chlorophyll. This result may also be explained by a *slower rate of formation* of the brown intermediate, combined with an *unchanged* (or even accelerated) *rate of its disappearance*.

It will be noted that, while the hydrogen atom in position 10 is "labile" in the sense that it is easily shifted to the oxygen atom in position 9, and allows an addition of oxygen or quinone, it is not necessarily easily *removable* from the chlorophyll molecule. It was stated in chapter 9 that the oxidation-reduction potential of an organic system of the type RH_2/R depends on the degree of resonance stabilization of the double bond formed by oxidation. Even if the free energy of hydrogenation is small or negative, the capacity for reversibly reduction may be absent because of the high energy of the "odd" reduction intermediate. Only those pairs RH_2/R can act as reversible oxidation-reduction systems whose intermediate radicals ("semiquinones") are stabilized by resonance (page 231). Thus, the "lone" hydrogen atom which chlorophyll possesses in position 10 could be available for easy, reversible oxidation-reduction only if the radical formed by its removal (10-monodehydrochlorophyll) were stabilized by resonance. In equations (16.8) and (16.10), the oxidation of the $CH-$ group was supposed to be brought about by additions and substitutions not involving the formation of free radicals. Oxidants of moderate oxidation potential, acting by straightforward transfer of hydrogen atoms or electrons (*cf.* Chapter 9) are likely to leave the $CH-$ group unaffected, and to remove instead the hydrogen atoms in positions 7 and 8, whose loss can be compensated for by the formation of a double bond. They convert phorbides into the corresponding porphyrins (*i. e.*, remove two hydrogen atoms in nucleus IV), leaving the cyclopentanone ring intact. Two hydrogen atoms can be removed from chlorophyll, according to Conant, Dietz, Bailey, and Kamerling (1931), by *potassium molybdicyanide*, and according to Fischer and Lautsch (1936) by *silver oxide* and *silver acetate*; with some chlorins, the same effect can be achieved also by means of molecular oxygen if copper acetate is used as a catalyst (Fischer and Herrle 1936).

According to Fischer's interpretation of the nature of protochlorophyll, the oxidation of chlorophyll by the above-mentioned dehydrogenizing agents should lead to protochlorophyll (provided the hydrogen atoms in positions 7 and 8 are removed without side reactions). A confirmation of this conclusion would be of great interest.

Even more interesting would be a direct reduction of protochlorophyll back to chlorophyll. However, the conversion of porphyrins into chlorins (or phorbins) by hydrogenation is one problem of chlorophyll synthesis which has not yet been successfully solved. Thus, although the system

chlorophyll–protochlorophyll appears as a possible reversible oxidation-reduction system in the living cell, no proof of the reversibility of this (or any other dihydrophorbin–phorbin) system has as yet been obtained *in vitro*.

Another reaction which must be mentioned here is that of chlorophyll with *ferric chloride*, described by Rabinowitch and Weiss (1937). When ferric salts are added to a methanol solution of chlorophyll (or alkyl chlorophyllide), the solution instantaneously changes its color from green to yellow. Spectroscopic observation of the product shows (*cf.* Fig. 51a) a practically complete disappearance of the red absorption band.

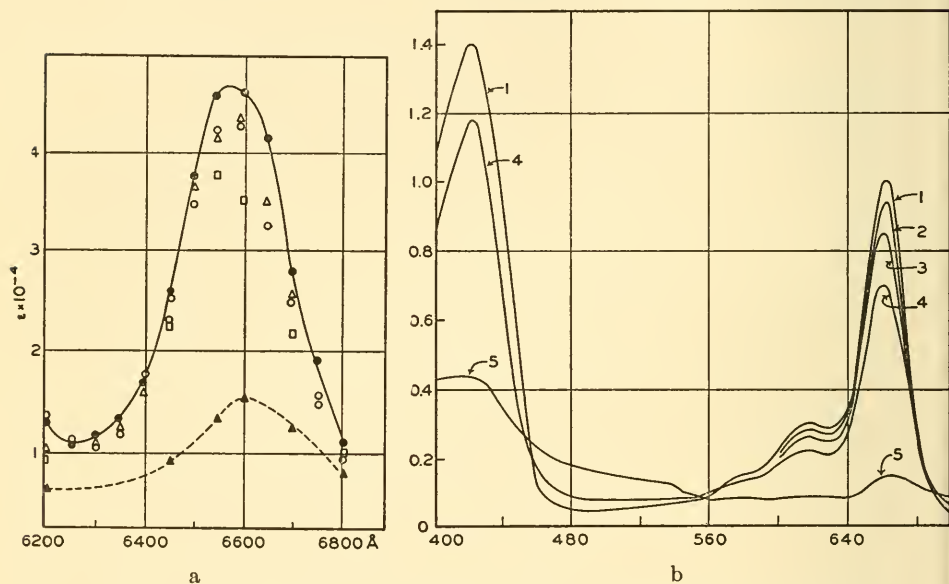

FIG. 51.—Spectrum of “oxychlorophyll” (after Rabinowitch and Weiss 1937).
a. Disappearance and restoration of the red band of ethyl chlorophyllide *a* in methanol.

● before the reaction; ▲ immediately after the reaction with ferric chloride; △ after restoration by ferrous chloride; ○ after restoration by excess sodium chloride; □ after standing.

b. Disappearance of the red band of chlorophyll *a* in methanol by the addition of increased quantities of ceric ammonium nitrate (beginning with 1 mole ceric salt per mole chlorophyll in curve 1 and ending with 12 moles per mole chlorophyll in curve 5).

The yellow solution can be changed back into the green form by the addition of *ferrous chloride* or another reductant. If this restoration is carried out immediately, the extinction curve of the restored product is identical with that of the original chlorophyll, the “phase test” is unimpaired, and the reaction with ferric chloride can be repeated again.

Rabinowitch and Weiss suggested that the reaction of chlorophyll with ferric ions is a *reversible oxidation*:

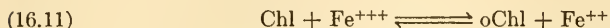

where oChl ("oxychlorophyll") denotes a yellow, oxidized form of chlorophyll. This explanation is supported by the fact that Fe^{++} ions can be identified in the reaction products by means of a spot test with 1,1'-bipyridyl (which forms a red complex with divalent iron). Reversible bleaching of chlorophyll can also be caused by other strongly oxidizing ions, *e. g.*, ceric or thallic ions (*cf.* Fig. 51b).

The "oxychlorophyll," assumed to be present in chlorophyll solutions decolorized by ferric ions, is unstable. Illumination by blue or violet light causes a rapid irreversible transformation: the solution becomes straw yellow and cannot be restored again to the green form. "Oxychlorophyll" is also irreversibly affected by water.

Additional proof seems to be needed to establish the correctness of interpretation (16.11). Some observations speak against it. For example, the green color can be restored not only by ferrous chloride, but also by other methanol-soluble salts (*e. g.*, CaCl_2 or NaCl), if used in a comparatively large quantity and (although much more slowly) by standing (in this case, the red band never reaches its original intensity). Outwardly, the reaction bears a striking resemblance to the phase test, and one is therefore tempted to explain it in a similar way, that is, by an enolization in position 9, induced by the highly charged ions Fe^{+++} or Ce^{++++} . The return of the green color upon standing could then be explained in the same way as in the phase test, that is, by a disruption of the carbocyclic ring and formation of a green chlorin; while the restoration of apparently intact chlorophyll by immediate addition of ferrous chloride or other salts can be considered as a "salt effect," which shifts the enolization equilibrium. Rabinowitch and Weiss decided for the oxidation-reduction hypothesis, because of the above-mentioned analytical proof of the formation of ferrous ions, because of the small concentration of ferrous chloride sufficient for the restoration of green color, and most of all because chlorophyll which was completely allomerized by standing in methanol solution still proved capable of reacting with ferric chloride. Since the hydrogen atom in position 10 has supposedly already been oxidized by allomerization, the oxidation by ferric chloride can plausibly be attributed to nucleus IV; the disappearance of the red absorption band fits well into this hypothesis. On the other hand, we have stated that the brown phase may not be visible in the reaction of allomerized chlorophyll with alkali merely because of unfavorable kinetic constants of its formation and decomposition. In the reaction

with ferric chloride, these conditions may be more favorable, allowing one not only to observe the formation of the brown phase, but also to reverse the reaction before the beginning of its second, irreversible stage.

An additional argument in favor of the oxidation-reduction hypothesis (16.11) is provided by the effect of *light* on the reaction between chlorophyll and ferric chloride, to be described on page 488. An oxidation reaction of chlorophyll is likely to be accelerated by light absorption, while an effect of illumination on the allomerization equilibrium (16.7) is much less probable. Because of the importance a definite proof of reversible oxidation of chlorophyll could have for the explanation of the role of this pigment in photosynthesis, the reaction of chlorophyll with ferric chloride certainly deserves further study. It must be proved, for example, that this reaction leaves the magnesium in the chlorophyll molecule unaffected, and does not cause a replacement of this metal by iron or hydrogen.

Altogether, the chlorophyll molecule appears to be a very delicate system, with several groupings (vinyl group, CH— group in position 10, the two extra hydrogen atoms in positions 7 and 8) easily susceptible to oxidation and reduction. Interesting, and far from understood, internal relations exist between these spacially separated groups; and a close interaction is apparent also between them and the complexly bound magnesium.

For none of these groups has a capacity for *reversible* oxidation or reduction been definitely proved by experiments *in vitro*. Such a proof would be very valuable, since it would indicate that chlorophyll can serve as an oxidation-reduction catalyst and would thus provide a firm basis for speculations as to the part which it plays in photosynthesis (*cf.* Chapter 19). A first confirmation that chlorophyll can act as such a catalyst (even in the dark) can be seen in the observation of Rabinowitch and Weiss (1937) that, when ethyl chlorophyllide is left standing with ferric chloride in methanol, ferric chloride is reduced slowly in quantities far in excess of that of the chlorophyll present in solution. Probably chlorophyll catalyzes the oxidation of methanol by ferric chloride; but this explanation has yet to be confirmed by analysis.

We have considered so far the oxidation-reduction systems formed by phorbini-dihydrophorbin, dihydrophorbin-tetrahydrophorbin and vinyl phorbin-ethyl phorbin, as well as the transformation of chlorophyll into the radical (monodehydrochlorophyll) by the loss of the hydrogen atom in position 10. Another oxidation-reduction system is represented by the pair chlorophyll *a*-chlorophyll *b* (since according to Fischer these two pigments differ only by the replacement of the methyl side chain in modification *a* by a methoxyl chain in modification *b*). However, the interconversion of these two forms is difficult, if at all possible (*cf.* Stoll and Wiedemann 1932³).

4. Elimination of Magnesium and Phytol

The best investigated chemical reaction of magnesium in chlorophyll and similar compounds is its elimination by acids (substitution of two hydrogen atoms leading to the formation of two imino groups) which produces pheophytins (if phytol is intact) or pheophorbides (if phytol has been eliminated).

The kinetics of the conversion of chlorophyll into pheophytin can be followed spectrophotometrically by observing the gradual weakening of the red absorption band, as has been done by Joslyn and Mackinney (1938, 1940) and Mackinney and Joslyn (1941). They found the reaction to be of the first order with respect to $[H^+]$, and probably also with respect to chlorophyll. Chlorophyll *a* reacts eight to nine times more rapidly than chlorophyll *b*. They assume that the entrance of the first hydrogen atom is the slow rate-determining process.

That "pheophytinization" is a two-step reaction (as envisaged in equations 16.3) was confirmed by observations by Rabinowitch and Weiss on the effect of light on this reaction (see page 493). While the removal of magnesium from chlorophyll occurs very easily (it can be replaced not only by hydrogen, but also by other divalent metals, *e. g.*, copper, zinc, iron), the reintroduction of magnesium into pheophorbide is much more difficult, although it can be achieved by means of Grignard reagents.

Ruben, Frenkel, and Kamen (1942) found that pure chlorophyll does not exchange its magnesium for radioactive magnesium in the presence of magnesium salts, but that this exchange can be observed in crude leaf extracts.

Another part of the chlorophyll molecule which can be reversibly replaced, is phytol. This can be achieved by means of the enzyme chlorophyllase, whose presence in plants was discovered by Willstätter and Stoll (1913) (*cf.* Chapter 14, page 380). It is plausible that the purpose of chlorophyllase is to assist in the synthesis of chlorophyll rather than to participate in the photosynthetic process.

Bibliography to Chapter 16

Molecular Structure and Chemical Properties of Chlorophyll

A. Molecular Structure

Books and Reviews

- 1909 Marchlewski, L., *Die Chemie des Chlorophylls*. F. Vieweg and Son, Braunschweig, 1909.
- 1910 Tswett, M., *Chromophylls in the Plant and Animal World* (in Russian), Warsaw, 1910.
- 1913 Willstätter, R., and Stoll, A., *Untersuchungen über Chlorophyll*. Springer, Berlin, 1913; *Investigations on Chlorophyll*. Science Press, Lancaster, Pa., 1928.

- 1918 Willstätter, R., and Stoll, A., *Untersuchungen über die Assimilation der Kohlensäure*. Springer, Berlin, 1918.
- 1932 Treibs, A., in Klein's *Handbuch der Pflanzenanalyse*. Vol. III, Springer, Wien, 1932, p. 1351.
- 1935 Linstead, R. P., in *Annual Reports on the Progress of Chemistry*. Gurney and Jackson, London, 1935, p. 362.
- 1936 Fischer, H., *Molisch Festschrift der Zeitschrift für Mikrochemie*, p. 67.
- 1937 Linstead, R. P., in *Annual Reports on the Progress of Chemistry*. Gurney and Jackson, London, 1937, p. 369.
- Steele, C. C., *Chem. Revs.*, **20**, 1.
- Fischer, H., *ibid.*, **20**, 41.
- 1938 Stoll, A., and Wiedemann, E., in *Fortschritte der Chemie der org. Naturstoffe*, **1**, 159.
- 1940 Fischer, H., *Naturwissenschaften*, **28**, 401.
- Fischer, H., and Stern, A., in Fischer and Orth's *Chemie des Pyrrols*. Vol. II, 2, Akadem. Verlagsgesellschaft, Leipzig, 1940.
- 1943 Steele, C. C., in Gilman's *Organic Chemistry*. Vol. II, 2nd ed., Wiley, New York, 1943, p. 1293.

Original Literature

(For complete bibliography see Fischer and Stern's book)

- 1838 Berzelius, J. J., *Ann. Chemie (Liebig)*, **27**, 296.
- 1851 Verdeil, F., *Compt. rend.*, **33**, 689.
- 1879 Hoppe-Seyler, F., *Z. physiol. Chem.*, **3**, 339.
- 1880 Hoppe-Seyler, F., *ibid.*, **4**, 193.
- 1881 Hoppe-Seyler, F., *ibid.*, **5**, 75.
- 1882 Borodin, I., *Botan. Z.*, **40**, 608.
- 1893 Monteverde, N. A., *Acta Horti Petropol.*, **13**, No. 123.
- 1912 Küster, W., *Z. physiol. Chem.*, **82**, 463.
- 1929 Fischer, F. G., and Löwenberg, K., *Ann. Chemie (Liebig)*, **475**, 183.
- 1934 Schneider, E., *Z. physiol. Chem.*, **226**, 243.
- 1935 Haurowitz, F., *Ber. deut. chem. Ges.*, **68**, 1795.
- 1936 Rothmund, P., *J. Am. Chem. Soc.*, **58**, 625.
- 1937 Ketelaar, J. A. A., and Hanson, E. A., *Nature*, **140**, 196.
- Hanson, E. A., *Proc. Acad. Sci. Amsterdam*, **40**, 281.
- 1938 Haurowitz, F., *Ber. deut. chem. Ges.*, **71**, 1404.
- 1939 Hanson, E. A., *Rec. trav. botan. néerland.*, **36**, 183.
- 1943 Aronoff, S., and Calvin, M., *J. Org. Chem.*, **8**, 205.

B. Chemical Properties of Chlorophyll

- 1903 Timiriazev, C. A., *Proc. Roy. Soc. London B*, **72**, 424.
- 1913 Willstätter, R., and Stoll, A., *Untersuchungen über Chlorophyll*. Springer, Berlin, 1913.
- 1918 Willstätter, R., and Stoll, A., *Untersuchungen über die Assimilation der Kohlensäure*. Springer, Berlin, 1918.
- 1931 Conant, J. B., and Hyde, J. F., *J. Am. Chem. Soc.*, **52**, 1233.

- Conant, J. B., Hyde, J. F., Moyer, W. E., and Dietz, E. M., *J. Am. Chem. Soc.*, **53**, 359.
- Conant, J. B., Dietz, E. M., Bailey, C. F., and Kamerling, S. E., *ibid.*, **53**, 2383.
- 1932 Fischer, H., Elser, L., and Plötz, E., *Ann. Chemie (Liebig)*, **495**, 8.
Stoll, A., and Wiedemann, E., *Helv. Chim. Acta*, **15**, 1128, 1280.
Stoll, A., and Wiedemann, E., *Naturwissenschaften*, **20**, 706, 791.
Stoll, A., and Wiedemann, E., *ibid.*, **20**, 889.
- 1933 Fischer, H., and Siebel, H., *Ann. Chemie (Liebig)*, **499**, 93.
Kuhn, R., and Winterstein, A., *Ber. deut. chem. Ges.*, **66**, 1741.
Gaffron, H., *Biochem. Z.*, **264**, 251.
Fischer, H., and Riedmair, J., *Ann. Chemie (Liebig)*, **506**, 107.
- 1935 Rothmund, P., *Cold Spring Harbor Symposia Quant. Biol.*, **3**, 71.
Albers, V. M., Knorr, H. V., and Rothmund, P., *Phys. Rev.*, **47**, 198.
- 1936 Stoll, A., *Naturwissenschaften*, **24**, 53.
Fischer, H., and Lautsch, W., *Ann. Chemie (Liebig)*, **525**, 259.
Fischer, H., and Herrle, K., *ibid.*, **527**, 138.
- 1937 Fischer, H., and Bub, K., *ibid.*, **530**, 213.
Rabinowitch, E., and Weiss, J., *Proc. Roy. Soc. London A*, **162**, 251.
- 1938 Rabinowitch, E., *Nature*, **141**, 39.
Joslyn, M. A., and Mackinney, G., *J. Am. Chem. Soc.*, **60**, 1132.
- 1939 Hanson, E. A., *Rec. trav. botan. néerland.*, **36**, 183.
Godnev, T. N., *Uchenye Zapiski Beloruss. Univ.* (Ser. Chem.), **1939**, No. 1, p. 15.
- 1940 Smith, J. H. C., *Plant Physiol.*, **15**, 183.
Joslyn, M. A., and Mackinney, G., *J. Am. Chem. Soc.*, **62**, 230.
- 1941 Mackinney, G., and Joslyn, M. A., *ibid.*, **63**, 2530.
- 1942 Ruben, S., Frenkel, A. W., and Kamen, M. D., *J. Phys. Chem.*, **46**, 710.
Knorr, H. V., and Albers, V. M., *Phys. Rev.*, **61**, 546.

CHAPTER 17

THE ACCESSORY PIGMENTS

A. THE CAROTENOIDS *

The occurrence and concentration of carotenoids in leaves and algae was described in chapter 15. The present chapter deals with their chemical properties. For general information and bibliography, reference should be made to the monographs of Palmer (1922), Zechmeister (1934), Lederer (1934), and Bogert (1938); and for the xanthophylls to Strain (1938).

1. Chemical Structure

Carotenoids are pigments—usually yellow, red or orange—whose chemical structure is characterized by a long, straight, unsaturated carbon chain, often terminated at one or both ends by an *ionone* ring (hexamethylene ring with one double bond). The carbon chain has an affinity for similar chains in fats and lipides and accounts for the lipophilic properties of the carotenoids. Some carotenoids contain no polar groups at all; others possess one or several hydroxyls or carbonyls in the terminal groups, which increase their solubility in alcohols, but are not enough to bring about solubility in water.

Most carotenoids contain 40 carbon atoms, and 11 or more double bonds. Most or all of the double bonds are conjugated. The long chain of conjugated double bonds (so-called "polyene chain") is a chromophore and is responsible for the color of the carotenoids.

The nomenclature of the carotenoids is somewhat confused. This applies particularly to the term "xanthophyll." This name, meaning "leaf-yellow," was introduced by Berzelius (1837) as a counterpart to chlorophyll, the "leaf-green." Later, one of the two yellow pigments of the leaves was found to be identical with carotene from carrot roots, and the use of the name xanthophyll was restricted to the other one. Still later, pigments similar to leaf xanthophyll were found in algae and in many animal tissues, and also were called xanthophylls. On the other hand, the "leaf xanthophyll" itself proved to be a mixture of several pigments, the most common of them being identical with luteol, the coloring matter of egg yolk. Strain (1938) suggested that all carote-

* Bibliography, page 480.

noids not containing oxygen (hydrocarbons, $C_{40}H_{56}$) be called *carotenes*; all carotenoids containing oxygen (in a carbonyl or hydroxyl group) be called *xanthophylls*; and the most abundant compound of this class in leaves, $C_{40}H_{54}(OH)_2$, be called *luteol*. Bogert (1938), on the other hand, proposed that the term *carotenol* be used as a generic name for all hydroxyl derivatives of carotenes, while the term xanthophyll should either be eliminated altogether or reduced to its original meaning ("leaf-xanthophyll"). This suggestion has been followed in the present discussion. Furthermore, we are using the ending *-ol* (rather than *in*) also in the designation of individual carotenols (*e. g.*, luteol and not lutein; fucoxanthol and not fucoxanthin).

Carotene, $C_{40}H_{56}$, occurs in several isomeric forms. Only two have been definitely identified in green leaves, according to Mackinney's (1935) analysis of 59 species. Both contain 11 double bonds and two ionone rings. In the most abundant isomer, β -carotene, all double bonds are conjugated (formula 17.I). The α -carotene, with a double bond in one ionone ring displaced into the 5-6 position, and thus not conjugated with the rest, has been identified by Mackinney (1935) in 40 species, in concentrations up to 35% of the total carotene. Other carotenes, found for example in flowers, and perhaps present in traces in leaves as well (γ -carotene, lycopene) have one or both ionone rings open, with one or two additional double bonds accounting for the isomerism with β -carotene.

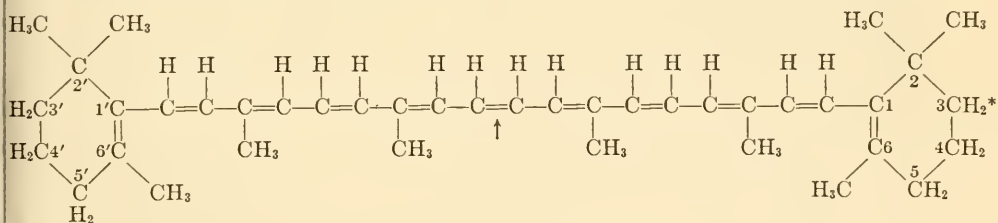

Formula 17.I. β -Carotene.

The asterisks indicate the positions of OH groups in luteol.

The splitting by hydrolysis of the middle double bond in β -carotene (indicated by arrow) produces vitamin A. This vitamin may be present as such in green leaves, as suggested, for instance, by Joyet-Lavergne (1937). The alternation of single and double bonds and the arrangement of methyl side chains in carotene suggest a relationship with isoprene, $CH_2=C(CH_3)-CH=CH_2$, the parent substance of rubber, terpenes, and probably also of phytol (page 439). Phytol has the same carbon skeleton (C_{20}) as has vitamin A. A genetic relation between phytol and the carotenoids was deemed possible by Willstätter and Mieg (1907) and

made plausible by syntheses carried out by Karrer, Helfenstein, and Widmer (1928).

The *carotenols* are a more diversified class than the carotenes; there are several groups of them with one to six oxygen atoms, and each has numerous isomers. As mentioned above, the species most common in green leaves is *luteol*, a 3,3'-dihydroxy- α -carotene, with hydroxyl groups in positions indicated by asterisks in formula 17.I. However, according to Strain (1938), almost a dozen other carotenols are regularly found in green leaves. One of these is *zeaxanthol* (dihydroxy- β -carotene), which is an isomer of luteol. It is the coloring matter of yellow corn. Table 15.IV showed a sample of the composition of the "leaf xanthophyll."

All *algae* contain carotene, and almost all contain luteol. In addition, a number of carotenols not encountered in the higher plants was isolated from algae (*cf.* Table 15.V). The most important of them is *fucoxanthol*, occurring mainly in brown algae and diatoms. The formula of fucoxanthol has been variously written as $C_{40}H_{64}O_6$ (Willstätter and Page 1914), $C_{40}H_{56}O_6$ (Karrer 1929; Karrer, Helfenstein, Wehrli, Pieper, and Morf 1931), and $C_{40}H_{60}O_6$ (Heilbron and Phipers 1935). It contains, according to Karrer, ten double bonds; of the six oxygen atoms, four are hydroxyl oxygens (as shown by Zerewitinoff's test for "active" hydrogen atoms). Heilbron and Phipers (1935) assumed that the two remaining are carbonyl oxygens, although certain carbonyl tests gave negative results. They suggested the accompanying formulation for the end-groups of fucoxanthol, which they thought may account for the inactivity of the carbonyl groups, as well as for the transformation of fucoxanthol into zeaxanthol which takes place in dried algae. (Zeaxanthol has end

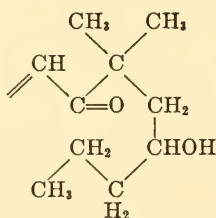

Formula 17.II. End groups of fucoxanthol.

groups similar to 17.II, but without the carbonyl oxygen, and with a closed ionone ring.) Other algal carotenoids are, for example, the "myxoxanthone" and "myxoxanthophyll" of blue-green algae. The first one, $C_{40}H_{64}O$, contains 12 double bonds and one ionone ring, and one carbonyl group; myxoxanthophyll contains seven oxygen atoms, that is, one more than fucoxanthol (Heilbron, Lythgoe, and Phipers 1935; Heilbron and Lythgoe 1936).

Zechmeister (1934) remarked that the absence of the more highly oxidized of the two chlorophylls (chlorophyll *b*) in brown algae, and the presence in them of a strongly oxidized carotenoid (fucoxanthol) may be more than a coincidence.

Carotenoids are also present in purple bacteria, as was first shown by Molisch (1907). Spirilloxanthin, $C_{48}H_{66}O_3$, with 15 double bonds, was found in *Spirillum rubrum* by van Niel and Smith (1935). Karrer and Solmssen (1935, 1936) found five new carotenoids in *Rhodovibrio*: rhodoviolascin, rhodopin, rhodopurpurin, flavorhodin, and rhodovibrin. Rhodoviolascin is the easiest to obtain in the pure state; according to Karrer and Solmssen (1936), it contains 13 double bonds and has the formula $C_{40}H_{54}(OCH_3)_2$, thus being an ester rather than a hydrocarbon or alcohol, as are most other carotenoids. Rhodoviolascin is an open-chain compound. Its first absorption band lies comparatively far toward the red, at $573\text{ m}\mu$ in carbon disulfide and at $526\text{ m}\mu$ in ethanol. Since it is known (Vol. II, Chapter 21) that the lengthening of the conjugated double-bond chain causes a shift of the absorption band towards the red, rhodoviolascin probably has a chain of 13 conjugated double bonds (as against 11 in β -carotene and luteol). Rhodopin, which should more correctly be called rhodopol, ($C_{40}H_{57}OH$, cf. Karrer and Solmssen 1936, Karrer, Solmssen, and Koenig 1938) is a tertiary alcohol with one hydroxyl group and 12 double bonds. Rhodovibrin contains two oxygen atoms; its formula is probably $C_{40}H_{68}O_2$. Flavorhodin and rhodopurpurin are hydrocarbons, their names should thus be written as flavorhodene and rhodopurpurene.

It is worth noting that the absorption bands of bacterial carotenoids are situated further towards the red than those of the carotenoids of the green plants, thus paralleling the relationship between chlorophyll and bacteriochlorophyll.

Apparently, carotenoid pigments are present also in *green* bacteria (see, for example, Katz and Wassink 1939).

2. Oxidation and Reduction

Molecular solutions as well as colloidal solutions of carotene are quickly bleached by light. This bleaching is due to *oxidation*, and oxidizability is a general characteristic of the carotenoids. Strain (1938) has found, for instance, that, unless special precautions are taken, up to 50% of the leaf carotenoids may be lost by oxidation during the grinding of leaves in air. Once the pigments have been extracted, the danger of oxidation becomes less acute. Oxidation during extraction can be prevented by heating the leaves before grinding; Strain therefore attributes it to a heat-sensitive enzyme.

The carotenoids are also capable of *reduction*. Eleven molecules of

hydrogen can be added catalytically to the 11 double bonds of carotene or luteol. Usually, hydrogenation of double bonds by molecular hydrogen does not take place spontaneously in the absence of a catalyst, but noncatalytical hydrogenation has actually been observed in colloidal solutions of certain carotenoids.

Formally, the relation between carotene and the carotenols is that of an oxidation-reduction pair. Willstätter and Stoll (1913) were struck by the occurrence of leaf pigments in pairs (chlorophyll *a* and chlorophyll *b*; carotene and xanthophyll). The second compound is in both cases an oxidation product of the first one, so at least it appears on paper. One could thus suggest that the two pairs form an oxidation-reduction system, for example, that illuminated chlorophyll *a*, converted into chlorophyll *b* by reducing carbon dioxide, can be restored by carotene—the latter being, in its turn, converted into xanthophyll. Hypotheses of this type will be discussed in chapter 19 (page 554). They were abandoned by Willstätter and Stoll (1918) because all attempts to convert xanthophyll into carotene (or vice versa) have remained unsuccessful. Ewart (1918) said that zinc dust reduces luteol in alcohol to carotene; but Strain (1938) was unable to find any carotene in the reduction products of luteol obtained by this or similar treatments.

Even if we do not consider carotene and xanthophyll as two forms of an oxidation-reduction catalyst, we can still speculate about the role of these substances in photosynthesis. We may, for example, turn our attention to their unsaturated nature and capacity to bind hydrogen, and consider that they might serve as *hydrogen transmitters*. Another interesting possibility is that the carotenoids may play an active part in the *liberation of oxygen*.

It has been known since Arnaud (1889) that carotenoids are easily autoxidizable. Carotene exposed to air for several weeks takes up about 12 oxygen atoms per molecule. The process probably begins with the formation of peroxides, but it does not stop there. When about 11 atoms of oxygen have been taken up, the carbon chain begins to crack, with the liberation of low-molecular volatile compounds. Glyoxal (HOC=COH) has been identified among these products by Pummerer, Rebmann, and Reindel (1931), and carbon dioxide by Escher (1932). From 0.6 to 0.8 mole of carbon dioxide was liberated in eight weeks by one mole of carotene. The absorption of oxygen by carotenoids is probably caused by the formation of "double-bond peroxides":

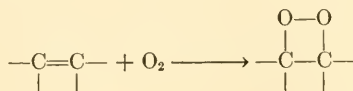

These peroxides might be able to transfer oxygen to other acceptors, thus explaining the carotene-catalyzed oxidation of unsaturated compounds. Olcovich and Mattill (1931), Olcott (1934), Monaghan and Schmitt (1932), and Franke (1932) found that traces of carotene accelerate the oxygen absorption by many autoxidizable substances, *e. g.*, linoleic acid.

This capacity of carotenoids to serve as reversible oxygen acceptors has caused U. and H. von Euler and Hellström (1928), von Euler and Ahlström (1932) and Joyet-Lavergne (1935) to discuss the possibility that carotene (or the related vitamin A) may have a catalytic function in the *binding of oxygen* in respiration. Equally feasible is their participation in the reverse process—the liberation of oxygen in photosynthesis (*cf.* Chapter 11, page 292).

It has recently been proved (*cf.* Vol. II, Chapter 30) that light absorbed by the carotenoids can be fully or partially utilized for photosynthesis—probably by a primary transfer of excitation energy to chlorophyll. However, this subsidiary function of the carotenoids is unlikely to provide an adequate explanation of their ubiquitous occurrence in all photosynthesizing cells, since in many of them—particularly the green cells of the higher plants—the contribution of the carotenoids to the total light absorption is almost negligible.

3. Carotenoids, Lipides, and Proteins

The affinity of carotenoids for lipides, which has led to their designation as “lipochromes,” should cause them to associate with lipides in the chloroplasts. If it is true that the lipides are concentrated in the grana (arguments in favor of this assumption have been mentioned in chapter 14), the carotenoids also must be accumulated in the grana.

The association of carotenoids with lipides is indicated, *e. g.*, by the protective action of lecithin on carotene colloids (Karrer and Strauss 1938). Zechmeister (1934) suggested that this association may be caused by esterification of the polyene alcohol by the fatty acid. He even spoke of the possible existence in leaves of a carotenoid–chlorophyll ester, with chlorophyll as the acid component, and carotenol replacing phytol as the esterifying alcohol. However, carotene cannot form esters, yet associates itself with lipides; and luteol, although able to esterify, must be present in leaves in the free state, since it can be extracted without saponification. It thus appears that the carotenoid–lipide binding in lipochromes is of a less “chemical” character than the alcohol–acid link in an ester; it is probably due to “van der Waals’ attraction” between the long carbon chains in the carotenoids and in the lipides.

The carotenoids are also capable of forming complexes with proteins. Such complexes are known in nature (the brown pigment of lobsters is an example), and can be obtained artificially, by coprecipitating carotenoids with proteins from colloidal solutions. The pigment cannot be extracted from these precipitates by means of the usual organic solvents. In contrast to carotene–lecithin complexes, carotene–protein complexes are not protected from oxidation; nor does this association appreciably shift the position of the absorption bands of carotene (in contrast to the behavior of chlorophyll in artificial chlorophyll–protein complexes; *cf.* page 388).

Various observations on the extraction of carotenoids from leaves and their oxidation in the process of extraction indicate that the carotenoids are actually associated with lipides and proteins in the living plant cells. In the case of chlorophyll, we have quoted the strong shift of the absorption bands towards the red as a sign of an association with proteins. The bands of the carotenoids in the living cells are shifted even more strongly than those of chlorophyll—as shown for instance by the brown color of *Pheophyceae* (*cf.* Vol. II, Chapter 22). Whether this shift is due to the interaction with proteins, or with lipides, remains an open question. The above-mentioned behavior of artificial protein-carotenoid complexes speaks against the first alternative; while the change of the spectrum of brown algae caused by heating (*cf.* Menke 1940) tends to support it, since it indicates a disruption of the complex by denaturation of the proteins.

Carotenoids remain bound to proteins and chlorophyll in colloidal extracts of leaves and algae, described on pages 383 *et seq.* Figure 46 showed the place which Hubert assigned to the carotenoids in the regular pattern of molecules in the chloroplasts. This assignment is hypothetical; however, a close association between chlorophyll and the carotenoids in the living cell is confirmed by the phenomenon of carotenoid-sensitized fluorescence of chlorophyll *in vivo*, which was observed by Dutton, Manning, and Duggar (1943), and will be discussed in Volume II, Chapter 24. This association probably is responsible for the carotenoid-sensitized photosynthesis, and may also be a contributing cause of the strong shift of the carotenoid bands *in vivo*.

B. THE PHYCOBILINS *

The occurrence of the phycobilins (phycocyanin and phycoerythrin) in the blue-green and red algae was discussed in chapter 15. Here some information will be given as to their as yet incompletely known chemical structure.

As described in chapter 15, phycocyanin was discovered by von Eisenbeck (1836) and phycoerythrin by Kützing (1843); the latter gave both pigments their names. Their proteinaceous nature was noticed by von Eisenbeck; its confirmation came from Molisch (1894, 1895) and Kylin (1910). Kylin was probably the first to prepare these chromoproteids in the crystalline state. Among the more recent investigators of the phycobilins, one may name Kitasato (1925) and particularly Lemberg (1928, 1929, 1930), who succeeded in separating the chromophoric group from the carrier protein, and gaining some insight into the nature of the chromophore. Because of their similarity to the bile pigments, Lemberg suggested for these chromophores the name *phycobilins*.

* Bibliography, page 481.

The protein-pigment bond is particularly strong in the phycobilins. It is not disrupted by organic solvents, which cause the denaturation of the proteins, quite unlike the chlorophyll-protein bond. Even after digestion with pepsin, parts of the broken-down protein molecules still cling to the pigment. Lemberg suggested therefore that the pigment is bound to the protein by a true chemical bond, for example, a peptide link, $R'CO-NHR''$, where $R'COOH$ is the pigment and $R''NH_2$ is the protein.

Lemberg (1930) split this link by hot hydrochloric acid. The absorption bands were shifted by this treatment towards the violet end of the spectrum, by as much as $60 m\mu$; but the chromophore seemed otherwise intact. It can be dissolved in chloroform or alcohol, but is insoluble in water and benzene. The elementary analysis of the protein-free "phycocyanobilin" by Lemberg (1929) gave values in agreement with the formula, $C_{34}H_{44}O_8N_4$ (molecular weight, 636). The "phycocerythrobilin" is probably closely related in its structure to the "phycocyanobilin." Kylin (1910) and Kitasato (1925) found that this red pigment turns blue upon digestion of the protein with pepsin; Lemberg (1930) proved that this change occurs only in the presence of oxygen, and that it is accelerated by ferric chloride; it seems likely that the blue oxidation product of erythrobilin is identical with cyanobilin. Thus, once again, as in the case of the two chlorophylls, or of carotene and xanthophyll, we have to deal with a pair of pigments which stand to each other in the relation of an oxidation product to a reduction product; and here, at least, a direct conversion appears possible.

The phycobilin chromoproteids are amphoteric, although somewhat more acidic; but they are easily esterified. They form complexes with zinc and copper, but do not contain any metal in the natural state. Small amounts (0.25%) of calcium, found by Lemberg (1928) in their ash, were probably due to adsorbed calcium sulfate; magnesium and iron are definitely absent.

Lemberg's analysis of phycocyanobilins makes it probable that they are *tetrapyrrole derivatives*, similar to porphyrins, chlorins, phorbins, and bile pigments. The structure of the absorption spectra (*e. g.*, the absence of a strong band in the region of $400-430 m\mu$), and the chemical properties, speak against a porphin structure, and in favor of a so-called *bilan* structure—an open chain of four pyrrole nuclei linked by CH_2 —or CH —bridges. Formula 17.III shows the "bilan," the hypothetical mother substance of the bile pigments. Genetic relationships between

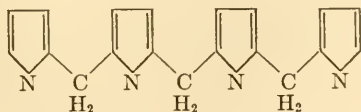

Formula 17.III. Bilan $C_{19}H_{16}N_4$.

porphyrins and bile pigments in the animal organisms are not only possible but probable, and one may suspect that a similar relationship exists between chlorophyll and the phycobilins in the algae.

The proteins associated with the phycobilins are probably globulins, with isoelectric points at pH 4 to pH 5. Roche (1933) found 4.30 for the phycoerythrin from *Ceramium rubrum*, and 4.75 for the phycocyanin from *Aphanizomenon flos aquae*. Because of the convenience with which the sedimentation of colored proteins can be observed, phycoerythrin and phycocyanin were among the first substances investigated by means of Svedberg's ultracentrifuge. The papers by Svedberg and Lewis (1928), Svedberg and Katsurai (1929), Svedberg and Eriksson (1932), and Eriksson-Quensel (1938) brought much information as to the molecular weights and other properties of these chromoproteids under different conditions. At first, Svedberg and Lewis (1928), working at pH 6.8–7.0, found that the phycoerythrin protein was twice as large as the phycocyanin protein (molecular weights, 208,000 and 106,000, respectively). They calculated from the sedimentation constant of phycoerythrin a diffusion constant of 7.0×10^{-7} cm.² (at 30° C.), a value consistent with the assumption that the phycoerythrin molecules are spheres obeying Einstein's diffusion law, having a density of 1.33 and a radius of 39.5 Å.

Later, experiments by Svedberg and Katsurai (1929) showed that, if measured near the isoelectric point (pH 4–5), both phycoerythrin and phycocyanin have molecular weights of about 208,000. The phycocyanin molecule is, however, more easily split at the higher pH values than the phycoerythrin molecule. At pH 6.8, the phycoerythrin molecules are still intact, whereas most of the phycocyanin molecules from *Porphyra* are split into halves, and those from *Aphanizomenon* consist of 65% "full-size" molecules and 35% "half-size" molecules. At pH 11, phycoerythrin is also partly split into smaller molecules (75% 208,000 and 25% 34,700), and phycocyanin (from *Aphanizomenon*) is completely divided into molecules with a molecular weight of 34,700. Svedberg and Eriksson (1932) made experiments with fresh algal extracts and showed that their molecular weight was the same as that of products purified by crystallization. The molecular weight of phycocyanin from *A. flos aquae* was again found to be 208,000, that of the phycoerythrin from *Polysiphonia urceolata*, 196,000. The phycocyanin breaks into half-size molecules both on the alkaline and on the acid side of the stable region (pH 2.5–5.0). Below pH 1.5 and above pH 8.0, it breaks into inhomogeneous products.

The observation of the sedimentation equilibrium gives the molecular weight, M ; the measurement of the sedimentation velocity gives the coefficient of viscosity, f ; by combination with M , it is possible to calculate

the coefficient of diffusion D . On the other hand, diffusion can be measured directly, as this was done by Tiselius and Gross (1934) for the phycobilins. They obtained values for D at pH 5 of about 4.0×10^{-7} cm.²/sec.—considerably lower than the values calculated from sedimentation experiments. The agreement was restored by new measurements of the sedimentation equilibrium by Eriksson-Quensel (1938), which gave for the molecular weights values almost 50% larger than those reported previously (and thus correspondingly reduced the diffusion coefficients). The new molecular weights are:

Compound	pH	M
Phycocerythrin (<i>Ceramium</i>).....	3-10	291,000
Phycocyanin (<i>Ceramium</i>).....	2.5-6	273,000
	7-8.5.....	138,000

Assuming with Svedberg that protein molecules are built up of "units" with a weight of about 17,600, the phycobilins must be classed with the protein molecules consisting of 16 units (molecular weight, 282,000).

The chromoproteids contain, according to Lemberg (1929), about 2% pigment and 98% protein. This corresponds to one molecule of pigment per two Svedberg units of protein, a whole order of magnitude less than what we found in chapter 14 for the hypothetical chlorophyll-protein complex. We shall find in Volume II, Chapter 21, indications that Lemberg's estimate of the ratio of pigment to protein may be too low.

Light absorbed by the phycobilins undoubtedly is used for photosynthesis (*cf.* Vol. II, Chapter 30); and this may well be the main function of these pigments in algae (in contrast to what was said above about the carotenoids). Whether the sensitization of photosynthesis by phycobilins occurs directly, or by a preliminary energy transfer to chlorophyll, remains to be elucidated.

C. FLAVONES AND ANTHOCYANINS *

Carotenoids are the most lipophilic and least hydrophilic of the leaf pigments; the chlorophylls, and even more so the phycobilins, are less hydrophobic, particularly in association with proteins. Leaves also contain, in addition to chlorophyll and the carotenoids, pigments which form true aqueous solutions, and are therefore concentrated in the cell sap rather than in the chloroplasts. These are yellow pigments of the *flavone* class; and since their distribution in the leaves makes a relation to photosynthesis improbable, we shall be satisfied with only a few words about them.

Flavones are derivatives of benzopyrone. They occur in all parts of plants, often in the form of glucosides. One of the most common of

* Bibliography, page 482.

them is *quercetin* (Formula 17.IV). Information on flavones can be

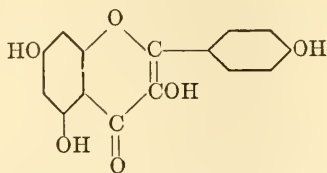

Formula 17.IV. Quercetin $C_{15}H_{10}O_7$

found in the books and reviews of Mayer (1935), Karrer (1932), and Perkin and Everest (1918), and in an article by Link (1938).

Anthocyanins are red reduction products of yellow flavones. Normally, leaves do not contain anthocyanins, but they occur in certain varieties (*purpurea* leaves), and also in certain development stages of ordinarily green leaves (*e. g.*, in very young leaves, which often appear red before they turn green). Noack (1922) suggested that flavones and anthocyanins may form reversible oxidation-reduction systems which are somehow related to photosynthesis. This system is normally in the oxidized state (flavones) but may be transformed into the reduced state (anthocyanins) when photosynthesis is inhibited. This suggestion is purely speculative; but it is noteworthy that in flavones and anthocyanins, we encounter another example of pigments which can occur in an oxidized and a reduced form, similarly to the chlorophylls, the carotenoids, and the phycobilins.

Bibliography to Chapter 17

Accessory Pigments

A. Carotenoids

- 1837 Berzelius, J. J., *Ann. Chemie (Liebig)*, **21**, 257.
 Berzelius, J. J., *Ann. Physik*, **42**, 422.
- 1889 Arnaud, F., *Compt. rend.*, **109**, 911.
- 1907 Molisch, H., *Die Purpurbakterien*. Fischer, Jena, 1907.
 Willstätter, R., and Miege, W., *Ann. Chemie (Liebig)*, **355**, 1.
- 1913 Willstätter, R., and Stoll, A., *Untersuchungen über Chlorophyll*.
 Springer, Berlin, 1913.
- 1914 Willstätter, R., and Page, H. J., *Ann. Chemie (Liebig)*, **404**, 237.
- 1918 Willstätter, R., and Stoll, A., *Untersuchungen über die Assimilation der Kohlensäure*. Springer, Berlin, 1918.
 Ewart, A. J., *Proc. Roy. Soc. Victoria*, **30**, 178.
- 1922 Palmer, L. S., *Carotenoids and Related Pigments*. Chemical Catalog Co., New York, 1922.
- 1928 Karrer, P., Helfenstein, A., and Widmer, R., *Helv. Chim. Acta*, **11**, 1201.
 von Euler, V., von Euler, H., and Hellström, H., *Biochem. Z.*, **203**, 370.
- 1929 Karrer, P., *Z. angew. Chem.*, **42**, 918.

- 1931 Olcovich, H. S., and Mattill, H. A., *J. Biol. Chem.*, **91**, 105.
Karrer, P., Helfenstein, A., Wehrli, H., Pieper, B., and Morf, R.,
Helv. Chim. Acta, **14**, 614.
Pummerer, R., Rebmann, L., and Reindel, W., *Ber. deut. chem. Ges.*,
64, 492.
- 1932 Escher, H. H., *Helv. Chim. Acta*, **15**, 1421.
Monaghan, B. R., and Schmitt, F. O., *J. Biol. Chem.*, **96**, 387.
Franke, W., *Ann. Chemie (Liebig)*, **498**, 129.
Franke, W., *Z. physiol. Chem.*, **212**, 234.
von Euler, H., and Ahlström, L., *ibid.*, **204**, 168.
- 1934 Olcott, H. S., *J. Am. Chem. Soc.*, **56**, 2492.
Zechmeister, L., *Carotinoide*. Springer, Berlin, 1934.
Lederer, E., *Les caroténoides des plantes*. Herrmann, Paris, 1934.
- 1935 Mackinney, G., *J. Biol. Chem.*, **111**, 75.
van Niel, C. B., and Smith, J. H. C., *Arch. Mikrobiol.*, **6**, 219.
Joyet-Lavergne, Ph., *Protoplasma*, **23**, 50.
Karrer, P., and Solmssen, U., *Helv. Chim. Acta*, **18**, 1306.
Heilbron, I. M., and Phipers, R. F., *Biochem. J.*, **29**, 1369.
Heilbron, I. M., Lythgoe, R. G., and Phipers, R. F., *Nature*, **136**, 989.
- 1936 Heilbron, I. M., and Lythgoe, R. G., *J. Chem. Soc.*, **1936**, 1376.
Karrer, P., and Solmssen, U., *Helv. Chim. Acta*, **19**, 3, 1019.
- 1937 Joyet-Lavergne, Ph., *Protoplasma*, **28**, 131.
- 1938 Karrer, P., and Strauss, W., *Helv. Chim. Acta*, **21**, 1624.
Strain, H. H., "Leaf Xanthophylls," *Carnegie Inst. Wash. Pub.*,
No. 400.
Bogert, M. T., "Carotenoids," in Gilman's *Organic Chemistry*. Vol.
II, Wiley, New York, 1938, p. 1138.
Karrer, P., Solmssen, U., and Koenig, H., *Helv. Chim. Acta*, **21**, 454.
- 1939 Katz, E., and Wassink, E. C., *Enzymologia*, **7**, 97.
- 1940 Menke, W., *Naturwissenschaften*, **28**, 31.
- 1943 Dutton, H. J., Manning, W. M., and Duggar, B. M., *J. Phys. Chem.*,
47, 308.

B. *Phycobilins*

- 1836 von Eisenbeck, Nees, *Ann. Chemie (Liebig)*, **17**, 75.
- 1843 Kützing, F. T., *Phycologia generalis*. Brockhaus, Leipzig, 1843, p. 21.
- 1894 Molisch, H., *Botan. Z.*, **52**, 177.
- 1895 Molisch, H., *ibid.*, **53**, 131.
- 1910 Kylin, H., *Z. physiol. Chem.*, **69**, 169.
- 1925 Kitasato, Z., *Acta Phytochim. Japan*, **2**, 75.
- 1928 Svedberg, Th., and Lewis, N. B., *J. Am. Chem. Soc.*, **50**, 525.
Lemberg, R., *Ann. Chemie (Liebig)*, **461**, 46.
- 1929 Svedberg, Th., and Katsurai, T., *J. Am. Chem. Soc.*, **51**, 3573.
Lemberg, R., *Naturwissenschaften*, **17**, 541.
- 1930 Lemberg, R., *Ann. Chemie (Liebig)*, **477**, 105.
Lemberg, R., *Biochem. Z.*, **219**, 255.
- 1932 Svedberg, Th., and Eriksson, I. B., *J. Am. Chem. Soc.*, **54**, 3998.

- 1933 Roche, J., *Arch. phys. biol.*, **10**, 91.
1934 Tiselius, A., and Gross, D., *Kolloid-Z.*, **66**, 11.
1938 Eriksson-Quensel, I. B., *Biochem. J.*, **32**, 585.

C. Flavones and Anthocyanins

- 1918 Perkin, A. G., and Everest, A. E., *Natural Organic Colouring Matters*.
Longmans, Green, London, 1918.
1922 Noack, K., *Z. Botan.*, **14**, 1.
1932 Karrer, P., in Klein's *Handbuch der Pflanzenanalyse*. Vol. III,
Springer, Wien, 1932, p. 941.
1935 Mayer, F., in *Chemie der organischen Farbstoffe*. 3rd ed., Vol. II,
Springer, Berlin, 1935, p. 134.
1938 Link, K. P., in Gilman's *Organic Chemistry*. Vol. II, Wiley, New
York, 1938, p. 114.

CHAPTER 18

THE PHOTOCHEMISTRY OF PIGMENTS *IN VITRO*

A. THE PRIMARY PHOTOCHEMICAL PROCESS *

The division of this treatise into a "chemical" and a "physical" part makes necessary a discussion of the photochemical reactions of chlorophyll before the description of its spectrum (*cf.* Vol. II, Chapters 21 and 22) and fluorescence (*cf.* Vol. II, Chapters 23 and 24). A close relation exists, however, between these phenomena, in particular between *fluorescence* and the *primary photochemical process*, which often represent two alternative ways of utilization of light energy:

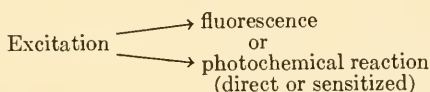

However, it will be shown in chapter 23 (Vol. II) that the fluorescence of chlorophyll in solution is not affected by certain compounds (*e. g.*, isoamylamine or thiourea) whose autoxidation is sensitized by this pigment; and that oxygen affects it only when its partial pressure exceeds 100 mm.—while a much lower concentration is sufficient to obtain a full efficiency of sensitized autoxidation. This demonstrates that, in the case of chlorophyll, the primary process of sensitized autoxidation *does not compete with fluorescence*. To explain this rather unusual relationship (for other similar cases, see Shpol'skij and Sheremetev 1936), one can assume that excited chlorophyll molecules have a choice between fluorescence and transformation into long-lived, active products, whose secondary reactions can bring about sensitization:

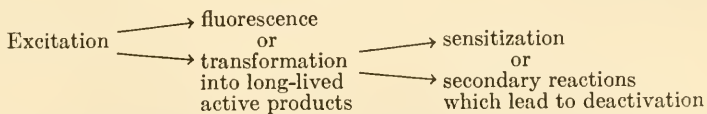

The comparatively long life of these active products explains why sensitized autoxidation can have a high quantum yield even at very low concentrations of the autoxidation substrates and of oxygen. These relations will be discussed in more detail elsewhere (*cf.* Chapter 19); what

* Bibliography, page 523.

is important for us here is the statement that light absorption by chlorophyll in solution may lead to the formation of *long-lived active products*. Weil and Malherbe (1944) suggested that strong self-quenching may explain the nonquenching of fluorescence by sensitization substrates; but this explanation is not applicable when the quantum yield of sensitization is high.

1. Long-Lived Activated States

In the photochemistry of *simple molecules in the gas phase*, the only alternative to short-lived *electronic excitation* (duration $\sim 10^{-7}$ sec.) is primary *photochemical dissociation*. If this dissociation is reversible, and the dissociation products are capable of catalyzing autoxidations, this mechanism can account for the lack of relationship between fluorescence and sensitization, since the "long-lived activation state" can be identified with the *state of dissociation*. However, in a *complex molecule in solution*, several other processes—*e. g.*, *tautomerization*, or *reversible photochemical reaction with the solvent*—also may lead to "long-lived activation." We shall discuss these alternatives presently.

(a) Primary Dissociation

Excited dyestuff molecules may dissociate, *e. g.*, lose a hydrogen atom (Franck and Wood 1936).

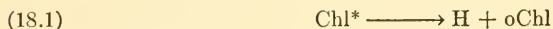

(o for oxidized, *e. g.*, dehydrogenated chlorophyll). One may object that, if such dissociation would occur, chlorophyll solutions would not fluoresce at all; in diatomic gases (like iodine vapor), direct photochemical dissociation takes place within one vibrational period of the molecule ($\sim 10^{-13}$ sec.), thus reducing fluorescence to zero. However, in polyatomic molecules, photochemical dissociation may be delayed until sufficient thermal energy has accumulated (by energy fluctuation within the molecule) in the degree of freedom where it is needed for decomposition (Franck and Herzfeld 1937); and the delay may give to some excited molecules the chance to fluoresce.

However, a direct photochemical dissociation of chlorophyll appears unlikely for a different reason, the insufficiency of available energy. In the lowest fluorescent state, *Y*, reached by absorption of red light (*cf.* Vol. II, Chapter 21), chlorophyll contains only about 40 kcal per mole of excitation energy, hardly sufficient to break a carbon-hydrogen bond. (According to table 9.II, a standard R—H bond has a strength of about 100 kcal; stabilization of radical R by resonance could bring it to 70, perhaps even to 60 kcal—as in the case of viologens, mentioned on page 233—but hardly any lower.)

In the nonfluorescent excited state *B* which is reached by the ab-

sorption of blue or violet light, chlorophyll contains about 67 kcal of excitation energy, an amount which may, with the assistance of thermal energy, suffice to bring about dissociation. The lower yield of fluorescence (Prins, *cf.* Vol. II, Chapter 23) and the higher yield of bleaching (Wurmser, *cf.* page 496) observed in chlorophyll solutions in blue light (as compared with red light) may be symptoms of such a direct photochemical dissociation; but these results need experimental confirmation.

(b) *Tautomerization*

An excited organic molecule may pass, by means of a nonradiant internal transformation, into the ground state of a tautomeric form:

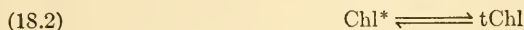

(t for tautomeric). Often, the result of tautomerization is "delayed fluorescence," or phosphorescence (*cf.* Vol. II, Chapter 23). Chlorophyll solutions, as a rule, do not show this effect. However, this does not prove the absence of tautomerization; the energy of the tautomer may merely be too low to allow its return into the normal form by a reversal of the process by which it was formed (that is, by means of the back reaction in 18.2, and emission of delayed fluorescence) while the direct transformation of the tautomer back into the ordinary pigment, may occur by a nonradiant rather than with the emission of phosphorescence process (*cf.* Vol. II, Scheme 23.I).

(c) *Reversible Chemical Reaction*

Excited chlorophyll molecules may react with the *solvent*, the most probable reaction being an *oxidation-reduction*. (An electronically excited molecule has an increased tendency for giving away an electron, as well as a capacity for acquiring an electron to replace the one which was removed from its normal level; *cf.* Weiss 1938).

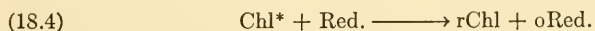
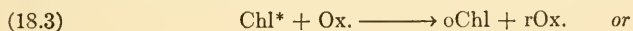

(Ox. for oxidant, Red. for reductant, o for oxidized, r for reduced.) In impure, or concentrated solutions, an *impurity*, or a second molecule of the *pigment*, may replace the solvent as partner in the oxidation-reduction. In the last case, the primary photochemical reaction is a *photodismutation*:

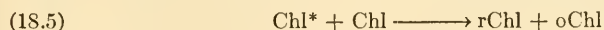

Since the quantum yield of the irreversible photochemical decomposition of chlorophyll in solution is very small (*cf.* page 496), any of the above reactions, if it occurs with a high quantum yield, must be almost completely reversible.

To sum up—in considering the fate of excitation energy in illuminated chlorophyll solutions, we may neglect the probability of monomolecular

dissociation, at least when dealing with the excitation by yellow or red light, but have to keep in mind the possibilities of tautomerization, reversible oxidation (or reduction), and dismutation.

Kautsky, Hirsch, and Flesch (1935), when they first suggested the existence of long-lived excited states in dyestuff solutions, thought of *metastable electronic states* (similar to those of free atoms). But because of the density and mutual overlapping of energy levels of complex molecules, states of this type are unlikely to be long-lived in organic molecules. Kautsky (1937) thought electronic excitation may become long-lived, in concentrated dyestuff solutions, in consequence of a continuous exchange of excitation energy between colliding molecules. However, a photon cannot avoid being re-emitted in this way any more than a man can increase his life expectancy by changing his address often. The hypothesis of metastable (triplet) electronic states of organic molecules has been revived by Lewis and Kasha (1944); however, it seems that if the rule which prohibits singlet-triplet transitions does not preclude the formation of the triplet state from the excited singlet state within $< 10^{-7}$ sec., it is unlikely to delay its transformation into the singlet ground state for as long as several seconds or even minutes.

2. Reversible Photochemical Reactions

When light absorption leads to a chemical change, we may assume that the reaction product does not absorb light in exactly the same spectral region as the original species. The color of intensely illuminated dyestuff solutions which undergo reversible photochemical transformations, must therefore be different from their color in dim light. In extreme cases (high yield of decolorization, slow back reaction) the result may be a complete (but nevertheless reversible) loss of color in light (as observed in illuminated thionine solutions in presence of ferrous ions; *cf.* pages 77 and 152). Since the maximum light absorption, realizable in photochemical experiments with intensely colored pigments, is of the order of ten absorption acts per molecule per second (*cf.* Vol. II, Chapter 25), decolorization can be observed visually only if the back reaction requires at least a tenth of a second. If the back reaction occurs in 0.01 sec., decolorization can still be detected by photometry.

Air-saturated chlorophyll solutions (in methanol) do not show reversible bleaching. But if oxygen is driven out by pure nitrogen, a reversible bleaching becomes detectable by photometric methods (Porret and Rabinowitch 1937; Livingston 1941). Porret and Rabinowitch, using a 2000-watt carbon arc, observed, in a 2×10^{-5} M chlorophyll solution, a reversible bleaching of about 1% (measured in red light). Thus:

(18.6)

$$n_{h\nu}\alpha\gamma\tau \approx 0.01$$

where $n_{h\nu}$ stands for the frequency of light absorption, α for the reduction in absorbing power in the red caused by bleaching, γ for the quantum yield, and τ for the mean life of the bleached state. The frequency, $n_{h\nu}$, was approximately 1 (*i. e.*, each molecule absorbed once in a second). The speed with which the color returned in the dark indicated that τ

was of the order of 10 seconds. Thus, $\alpha\gamma$ must have been of the order of 0.001. This means $\gamma = 10^{-3}$, if the bleached product absorbs no red light at all, and $\gamma > 10^{-3}$, if the red absorption band is only weakened. In Livingston's experiment, a 500-watt carbon arc was used, and approximately 4×10^{15} quanta were absorbed per sec. in 10 ml. of a 2×10^{-5} molar solution of chlorophyll, corresponding to $n_{hv} = 0.03$. The stationary bleaching was correspondingly weaker—of the order of 0.1%. The back reaction was slower than in the experiments of Porret and Rabinowitch—its half period was of the order of 100 seconds. This leads to $\alpha\gamma$ values of the order of 3×10^{-4} . Similar quantum yields were obtained by direct evaluation of the rate of bleaching (from the initial slope of the curves in Fig. 52).

According to Porret and Rabinowitch, stationary bleaching is proportional to the *square root* of light intensity. This can be understood if one assumes that the rate of bleaching is proportional to light intensity, while the rate of the back reaction is proportional to the *square* of the concentration of the bleached product. Livingston confirmed this by a direct determination of the rate of the back reaction (by analysis of the declining sections of the curves in Fig. 52), which he found to obey a second-order law. However, the bimolecular constant of the equation:

$$(18.6a) \quad d[\text{Chl}]/dt = k[\text{bChl}]^2$$

(b for bleached) varied strongly with the purity of the solvent (the values corresponding to the three curves in figure 52 were 0.65×10^5 , 5.9×10^5 , and 8.3×10^5 , respectively).

Addition of *hydroquinone* or *allylthiourea*, compounds whose autoxidation is sensitized by chlorophyll, or even the substitution of a 50% methanol and 50% isoamylamine mixture for pure methanol as solvent,

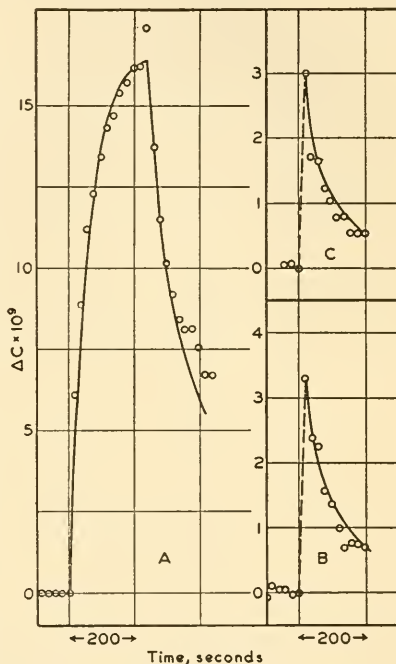

FIG. 52.—Reversible bleaching of chlorophyll in oxygen-free methanol (after Livingston 1941). Curve A shows the approach to a photostationary state after an illumination period of 200 seconds. Curves B and C correspond to very short illumination periods. The regeneration of color occurs by a second-order reaction (rate of restoration of color proportional to the square of bleaching), as shown by the shape of the descending sections of curves A, B, and C.

had no effect on bleaching. Oxygen, on the other hand, suppressed the bleaching entirely, even in a concentration as low as 10^{-6} mole per liter. It must be stressed that oxygen *inhibits* reversible bleaching, and does not merely *make it irreversible*: the quantum yield of irreversible photooxidation of chlorophyll in methanol ($< 10^{-4}$; *cf.* below, page 497) is at least one order of magnitude smaller than that of reversible bleaching ($> 10^{-3}$; *cf.* above, page 487).

Carbon dioxide had no effect on reversible bleaching, while *formic acid* was found by Porret and Rabinowitch to increase it from 1% to as much as 10 to 30%. These very strong bleaching effects still were practically completely reversible and could be suppressed by traces of oxygen. Livingston, too, found that the rate of restoration of bleached chlorophyll

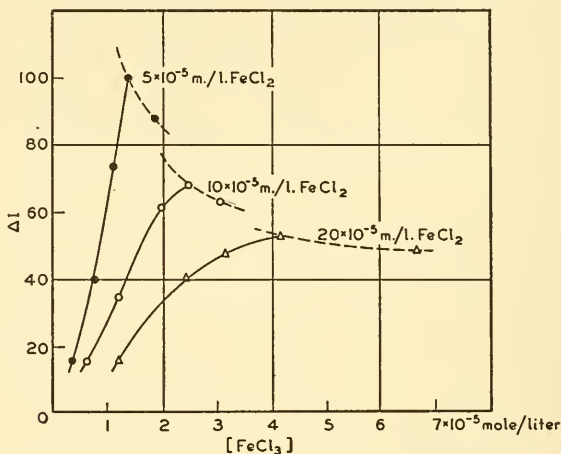

Fig. 53.—Reversible bleaching of chlorophyll in methanol by ferric chloride (after Rabinowitch). Extent of bleaching in the photostationary state plotted as function of $[\text{FeCl}_3]$ concentration, for various amounts of FeCl_2 . Broken curves indicate the probable effect of the dark reaction.

is made three or four times slower by the addition of 10^{-4} mole per liter of formic acid. Experiments with other acids proved that these effects are specific for formic acid (and not due to hydrogen ions).

In addition to oxygen, the reversible bleaching of chlorophyll solutions also is inhibited by *ferrous chloride*. This reminds one of the reversible discoloration of chlorophyll by ferric chloride in the dark, which, too, can be inhibited by ferrous salts (page 464). Observations by Rabinowitch (unpublished) showed that the equilibrium between chlorophyll and ferric and ferrous chloride (in methanol) is displaced in light: chlorophyll solutions containing ferric and ferrous chloride in proportions which do not cause marked discoloration in the dark are reversibly

bleached in light. This bleaching is of the same order of magnitude as that observed in pure, oxygen-free, chlorophyll solutions (*i. e.*, $\sim 1\%$), but it is *not* suppressed by oxygen. The bleaching experiment with ferric chloride can be repeated indefinitely with one and the same solution (provided that only red light is used, since blue light causes an irreversible decomposition of the "oxychlorophyll," *cf.* page 465). Figure 53 shows the stationary bleaching as a function of the concentration of ferric chloride. A saturation at $[\text{FeCl}_3]$ values as low as 5×10^{-5} mole per liter is exhibited. At the larger $[\text{FeCl}_3]$ values, the bleaching becomes weaker, probably because the *thermal* equilibrium between chlorophyll, ferri and ferro ions is shifted towards oxidation.

According to pages 484 *et seq.* reversible bleaching of chlorophyll could be caused by its *tautomerization*, *dismutation*, *oxidation*, or *reduction*. It was mentioned previously that the effect in pure, oxygen-free solutions is proportional to the *square root* of light intensity. If bleaching were caused by tautomerization, the back reaction would be *monomolecular*, and the effect would be proportional to the *first power* of light intensity, as shown by the following equations (t for tautomeric):

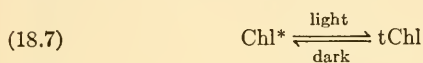

$$(18.8a) \quad - \frac{d[\text{Chl}]}{dt} = kI \quad (\text{bleaching})$$

$$(18.8b) \quad + \frac{d[\text{Chl}]}{dt} = k'[\text{tChl}] \quad (\text{back reaction})$$

$$(18.8c) \quad [\text{tChl}] = \frac{kI}{k'} \quad (\text{stationary state})$$

It was stated above that a proportionality of the stationary bleaching with the *square root* of light intensity indicates a *bimolecular back reaction*, *e. g.*:



$$(18.10a) \quad - \frac{d[\text{Chl}]}{dt} = kI \quad (\text{bleaching})$$

$$(18.10b) \quad + \frac{d[\text{Chl}]}{dt} = k'[\text{A}] \times [\text{B}] = k'[\text{A}]^2 \quad (\text{back reaction})$$

$$(18.10c) \quad \Delta[\text{Chl}] = [\text{A}] = \sqrt{\frac{kI}{k'}} \quad (\text{stationary state})$$

where $\Delta[\text{Chl}]$ is the amount of chlorophyll missing during the illumination. While the effect of light intensity excludes *tautomerization* as the cause of reversible bleaching, the low concentration of chlorophyll ($\sim 10^{-5}$ mole per liter) seems to exclude *dismutation*. (The results of Weiss and Weil-Malherbe, 1944, seem to indicate that dismutation is not entirely impossible even at these low concentrations.) This seems to leave an *oxidation-reduction* reaction with the solvent (or an impurity?) as the

only possible explanation of reversible bleaching. This hypothesis will be discussed below (page 491).

First, however, we shall consider the suggestion of Franck and Livingston (1941), and Livingston (1941), that a *combination of tautomerization and dismutation* may explain the facts which could not be interpreted by any one of these processes separately:

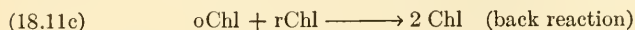
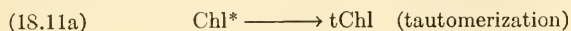

In this scheme, tautomerization leads to an intermediary state which is long-lived enough to provide an opportunity for dismutation; but the bleached state is represented, not by tautomerized chlorophyll, but by the products of dismutation, oChl + rChl, and therefore requires a bimolecular reaction for its termination. The inhibiting effect of *oxygen* was attributed by Franck and Livingston to a catalytic acceleration of the back reaction (18.11c), *e. g.*:

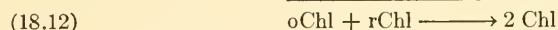
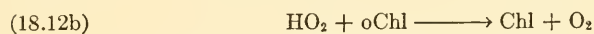
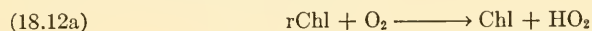

In a similar way, the inhibiting effect of *ferrous ions* can be attributed to a catalytic acceleration of reaction (18.11c) by the system $\text{Fe}^{+++}\text{-Fe}^{++}$. The bleaching of chlorophyll by *ferric ions* was attributed by Rabinowitch and Weiss (1937) to its reversible oxidation (*cf.* page 465). Franck and Livingston suggested that in this case, too, tautomerization is a preliminary step:

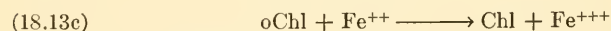
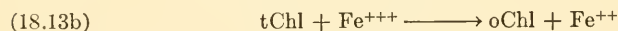

The low concentration of Fe^{+++} ions, which is sufficient to obtain a maximum effect (*cf.* Fig. 53), supports this point of view. Measurements of the effect of ferric chloride on fluorescence should show whether the reaction of Chl^* with Fe^{+++} competes with fluorescence, or whether this competition is eliminated by the intermediate formation of a tautomer, as assumed in (18.13a). Reaction (18.13c) can be accelerated by ferrous salts but—in contrast to (18.11c)—it cannot be affected by oxygen. This gives a plausible explanation of why the reversible bleaching caused by ferric chloride is insensitive to oxygen.

Although these schemes explain satisfactorily the reversible bleaching of chlorophyll solutions (as well as the quenching phenomena mentioned on page 483 and described in more detail in Vol. II, Chapter 23),

one must remember that they are based on experiments of an exploratory character, and that only precise measurements with chemically well-defined preparations, in different pure solvents, could provide a basis for a more definitive theory.

The effect of the solvent, in particular, must be studied more closely. Phenomena ascribed by Franck and Livingston to a primary tautomerization (and subsequent dismutation or oxidation), could equally well be explained by a *primary reversible reaction with the solvent*. For example, the bleaching of chlorophyll in oxygen-free methanol, could be attributed (instead of reactions 18.11) to one of the following processes:

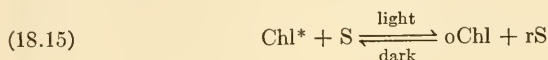
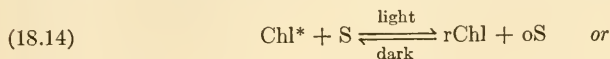

(where S is the solvent). Similarly to (18.11c), these equations indicate a bimolecular back reaction, and thus lead to a proportionality of stationary bleaching with the *square root* of light intensity.

If bleaching is a *reduction*, as assumed in (18.14), its inhibition by oxygen can be attributed either to the reoxidation of reduced chlorophyll:

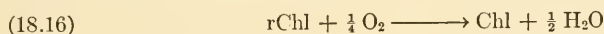

(leaving oxidized solvent as a net product), or to a catalysis of the back reaction in (18.14) by the system $\text{O}_2\text{-HO}_2$, as suggested by Franck and Livingston in (18.12). On the other hand, if bleaching is an *oxidation*, as postulated in (18.15), the oxygen effect can be explained *only* by a catalytic acceleration, according to (18.12), since an oxidation of the reduced product, rS, by oxygen would leave *oxidized chlorophyll* as a net reaction product. (This is a possible mechanism of *irreversible photooxidation* of chlorophyll, which will be discussed on pages 494 *et seq.*; but because of the low quantum yield of the latter process, it can account only for a small fraction of the products of reversible bleaching.)

In the interpretation of the reversible bleaching by *ferric chloride*, too, a reaction with the solvent can be substituted for tautomerization. For example, one may write, instead of (18.13):

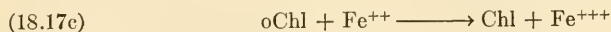
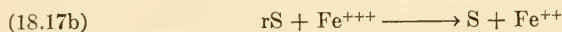
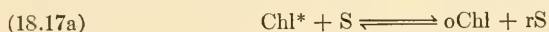

Ferric ions remove the product, rS, according to (18.17b), and can thus prevent the catalytic acceleration of the back reaction in (18.17a) by oxygen. This makes the bleaching independent of oxygen (presumption being that the Fe^{++} ions reduce oChl much more slowly than the radicals, HO_2).

This discussion was not intended to show that a reversible photochemical reaction with the solvent provides a *better* explanation of the sensitization by chlorophyll and of its bleaching than does a reversible tautomerization; but merely to suggest that neither explanation can as yet be accepted as final.

Photochemical reactions between chlorophyll and solvent were made plausible also by experiments of Knorr and Albers on changes in chlorophyll fluorescence with time (described on pages 497 and 501). These investigators found that photodecomposition occurs, in certain chlorophyll solutions, even in an atmosphere of pure nitrogen or carbon dioxide, and that in one case (chlorophyll *a* in acetone) it is even *inhibited* by oxygen. This reminds one of the oxygen inhibition of reversible bleaching, and can be explained by the assumption that the primary reaction in light is a reversible reaction with the solvent (acetone), whose reversal is catalyzed by oxygen; in the absence of oxygen, the primary product lives long enough to suffer an irreversible decomposition by violet or ultraviolet light (*cf.* page 465).

Another point in need of elucidation is the possible existence of a reversible *chlorophyll-oxygen complex*. In all the above equations, the effect of oxygen was attributed to encounters between Chl^* , tChl , rChl or rS molecules and free oxygen, and the effectiveness of small oxygen concentrations could therefore be taken as a sign of the existence of a long-lived activated state of chlorophyll. However, this efficiency could also be explained by a reversible association of chlorophyll with oxygen, in a complex which is saturated at very low partial pressures of the latter. We remember (*cf.* page 465) that "allomerization" (which prevents the discoloration of chlorophyll in the phase test) was attributed by Conant and Fischer to the uptake of one molecule of oxygen.

However, several arguments speak against a similar explanation of the effect of oxygen on reversible bleaching. In the first place, reversible bleaching can be observed even with completely allomerized chlorophyll—which, according to the concept of Conant, Stoll, and Fischer, is already "saturated" with oxygen. In the second place, if chlorophyll molecules were associated with oxygen even at $[\text{O}_2] = 10^{-6}$ mole per liter, it would be difficult to explain why oxygen pressures of the order of one atmosphere are required to bring about the quenching of chlorophyll fluorescence.

Nevertheless, the similarity between the reversible bleaching of chlorophyll in oxygen-free methanol, the reversible discoloration of chlorophyll solutions by ferric salts (in the dark and in light), and the first, reversible stage of the phase test, should not be dismissed as accidental. The analogy between the phase test and the thermal reaction with ferric chloride has already been discussed in chapter 16 (page 465); a complete theory should include the photochemical effects as well. It could perhaps be attempted along the following lines:

(a) the primary reaction in all cases (phase test, reaction with Fe^{+++} and reversible bleaching) is *tautomerization* (e. g., enolization, as assumed in the Fischer-Stoll theory);

(b) the "colorless" (yellow or brown) phase is, however, not the enol itself, but either a product of its dismutation (by reaction between the tautomer and ordinary chlorophyll, as assumed by Livingston and Franck) or the product of a reversible reaction of the tautomer with the solvent; the transformation of the enolized phorbin into a chlorin (which occurs under the influence of alcoholic alkali) removes at the same time the decolorized product which is in equilibrium with the enol, and thus causes the termination of the brown phase;

(c) tautomerization (enolization) is possible also in the allomerized state, but its velocity in this case is so small (as compared with the velocity of transformation of the enol into chlorin) that no "brown phase" can be observed; in the reaction with ferric chloride (as well as in the photochemical tautomerization), the decolorized stage is observable, even with allomerized material, because the conversion of the enol into chlorin either does not occur at all, or is much slower than in the alkaline medium of the phase test.

This is merely a suggestion; it may well turn out that the similarity between the phase test and the reversible decolorization of chlorophyll in light is fortuitous; but this question is certainly worth closer study.

It was stated on page 488 that the enhancing effect of *formic acid* on the reversible bleaching of chlorophyll is different from the influence of other acids, and must therefore be attributed to a specific reaction (e. g., a reversible oxidation of chlorophyll by formic acid). However, a much weaker reversible bleaching can be observed with other acids as well. This phenomenon can be attributed to the existence of a reversible and photosensitive first stage in the conversion of chlorophyll into pheophytin.

That "pheophytinization" can be accelerated by light was first noticed by Jørgensen and Kidd (1916) when they observed the fading of chlorophyll solutions in an atmosphere of carbon dioxide. Closer examination (Rabinowitch, unpublished data) showed that the rate of chlorophyll conversion into pheophytin is affected by light only if the concentration of hydrogen ions is low. At $p\text{H}$ 3, the rate of weakening of the red absorption band (which can be used as a measure of this transformation, *cf.* page 467) is markedly accelerated by illumination. At $p\text{H} > 3$, the transformation becomes *partly reversible*, that is, the red band is restored to a certain extent in the dark. This indicates that the reaction occurs in two stages (*cf.* page 467), and that the first, reversible step is accelerated by light.

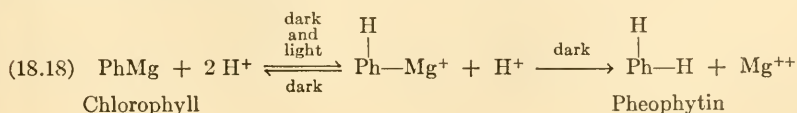

At the high hydrogen-ion concentrations, the photochemical contribution to reaction (18.18) is negligible; but at $pH \approx 3$, this contribution—which is independent of pH —becomes commensurate with that of the thermal reaction (which is proportional to $[H^+]$). At very low hydrogen-ion concentrations, the first step of (18.18) is practically purely photochemical. The velocity with which the intermediate product, $HPhMg^+$, is transformed back into chlorophyll is independent of $[H^+]$, whereas the velocity with which this intermediate is converted (irreversibly) into pheophytin, is proportional to $[H^+]$. Thus, at very low hydrogen-ion concentrations, the two $[H^+]$ -independent reactions—photochemical bleaching and monomolecular restoration of chlorophyll—must predominate over the two $[H^+]$ -proportional, bimolecular thermal reactions, and a reversible photochemical bleaching supplants the irreversible thermal pheophytinization.

Experiments described in this section provide a first glimpse into the mechanism of the primary photochemical process in chlorophyll solutions. They show that “hidden” reversible changes—tautomerizations, oxidation-reductions, perhaps also dismutations—occur in illuminated (even if outwardly photostable) chlorophyll solutions. The last-discussed reaction, the elimination of magnesium by acids, shows how, under appropriate conditions (in the presence of “acceptors” which react with the products of the primary reversible process), the reversible primary reaction is replaced by an irreversible secondary transformation. Many photochemical reactions of chlorophyll (and of other organic dyestuffs as well), whether they affect the dyestuff itself or are merely sensitized by it, are likely to originate in a similar way, that is, through irreversible secondary transformations of the products of reversible primary processes.

B. THE IRREVERSIBLE PHOTOCHEMICAL TRANSFORMATIONS OF CHLOROPHYLL *

1. Bleaching of Chlorophyll

In all probability, the rate of any of the well-known chemical reactions of chlorophyll could be accelerated by light under appropriate conditions (we encountered an example above in the conversion of chlorophyll into pheophytin). However, the only effect of light on chlorophyll which has been repeatedly investigated was *bleaching*, a change which is probably caused by a complex series of transformations (often involving the solvent, or impurities), rather than by a single, well-defined, chemical reaction.

Everyday observation teaches us that chlorophyll in the plants is stable to air and light; but we also learn from experience that, when illumination becomes too strong, or when photosynthesis is inhibited (by drought, poisons, or carbon dioxide starvation), the plants become yellow or colorless, that is, their pigments undergo a photochemical decomposition. A similar effect can be produced much more rapidly

* Bibliography, page 523.

in the presence of excess oxygen (*cf.* Chapter 19, pages 531 *et seq.*); this makes it probable that the bleaching is caused by a *photoxidation* of the pigment.

Dead tissues and colloidal pigment extracts are more sensitive to light than living plants; and solutions of chlorophyll in organic solvents are much less photostable than the aqueous colloids—some of them are completely decolorized in a few hours by direct sunlight or strong artificial light.

It was known to Senebier as early as 1788 that leaf extracts in ether and alcohol are not lightproof. The bleaching was later investigated by Jodin (1864), Sachs (1864), Timiriazev (1869), Gerland (1871), Wiesner (1874), and Reinke (1885), among others; Jørgensen and Kidd (1916), Wurmser (1921), and Gaffron (1933) extended the study to preparations of pure chlorophyll.

Böhi (1929) and Weber (1936) studied the influence of organic "accelerators" and "inhibitors." Reinke (1885), Dangeard (1910), and Wager (1914) found that *solid* chlorophyll (in the form of a thin layer on paper, or imbedded in collodion) bleaches even more rapidly than chlorophyll in solution. Knorr and Albers (1935) and Albers and Knorr (1935) recorded the gradual fading of chlorophyll fluorescence in different solvents, an effect which probably represents another aspect of the photochemical decomposition of the pigment.

Vermeulen, Wassink, and Reman (1937) found that *bacteriochlorophyll* solutions are even more sensitive to light and air than are solutions of ordinary chlorophyll. (This pigment, too, is much more stable in colloidal aqueous extracts, and particularly in living purple bacteria; *cf.* Katz and Wassink 1939.)

The nature of the *products* of the bleaching of chlorophyll is unknown; no competent worker in the field of chlorophyll chemistry has attempted to isolate and analyze them. Scattered hints as to their properties can be found in the papers by Wager (1914) and Ewart (1915), in the book of Willstätter and Stoll (1918), and in Rothemund's remarks to the paper of Albers and Knorr (1935). Some conclusions were disputed, for example, Wager's observation of the intermediate formation of a peroxide able to oxidize hydroiodic acid. The hypothesis of Ewart (1915) that, in the presence of carbon dioxide and air, illuminated chlorophyll is transformed into *xanthophyll* (which Ewart supposed to be formed by the oxidation of phytol), and into a waxy colorless substance also appears improbable.

A much discussed question was that of the occurrence of *formaldehyde* among the products of photodecomposition of chlorophyll. It was often thought that the photochemical formation of formaldehyde from chlorophyll might provide a clue to photosynthesis. Reduction of a carboxyl group in chlorophyll to a carbinol group, splitting off of formaldehyde and recarboxylation presented itself as a possible mechanism of photosynthesis ($\text{RCOOH} = \text{chlorophyll}$):



We described in chapter 4, while dealing with "artificial photosynthesis," the experiments of Usher and Priestley (1911) on the alleged formation of formaldehyde by a photochemical reduction of chlorophyll in the presence of carbon dioxide, and the criticisms

made by Warner (1914), Wager (1914), Ewart (1915), and Willstätter and Stoll (1918). We also mentioned that Warner, Wager, and Ewart suggested that formaldehyde may be formed by the *photooxidation* of chlorophyll. A similar conclusion could be drawn from the experiments of Osterhout (1918), who reported that, when filter paper colored by a chlorophyll extract in carbon tetrachloride was exposed to sunlight in an airtight bell jar until it was bleached, the presence of an aldehyde could be discovered in an open dish of water placed beside the paper.

However, Willstätter and Stoll (1918) denied the formation of formaldehyde by photooxidation of *pure* chlorophyll preparations. Possibly, aldehydes can be formed by a sensitized oxidation of methanol or ethanol by illuminated chlorophyll (*cf.* page 466).

The experiments of Baur and coworkers (*e. g.*, Baur and Fricker 1937, Baur, Gloor, and Künzler 1938, and Baur and Niggli 1943), in which formaldehyde was allegedly produced by reduction of chlorophyll in the presence of certain "accessory" oxidation-reduction systems, also were discussed and criticized in chapter 4 (pages 90 *et seq.*).

Lommel pointed out, in 1871, that the fundamental principle of photochemistry—"light has no chemical effects unless it is absorbed"—requires that chlorophyll should be bleached most rapidly by blue and red light; but other investigators, working with inadequate equipment, arrived at different conclusions. Thus, Sachs asserted, in 1864, that the intensity of bleaching is parallel to the *luminosity* of light, that is, that yellow and green rays (although comparatively weakly absorbed by chlorophyll) have the strongest effect. This hypothesis was supported by Wiesner (1874), but was discredited by the work of Reinke (1885), Dangeard (1910), and Wurmser (1921), who found that the "photochemical sensitivity spectrum" of chlorophyll is (as expected) roughly parallel to its absorption spectrum. However, the quantum efficiency of the bleaching of chlorophyll must not necessarily be the same for all wave lengths, and some observations point to a greater efficiency of blue and violet light, as compared with red light.

Wurmser (1921) found, for the ratio of the initial decolorization velocities of chlorophyll in acetone (for equal absorbed energies), the values 0.41, 0.056, and 1.34 in red, green, and violet light, respectively. The low value for green light—which is only weakly absorbed by chlorophyll—is probably unreliable; but the increased sensitivity in the violet may be significant. In explaining it, two facts may be recalled. In the first place, it was mentioned on page 484 that some excited molecules in the state *B*, reached by absorption of violet light, may undergo a direct photochemical dissociation. In the second place, we noted on page 465 that the "oxychlorophyll" obtained by the reaction of chlorophyll with ferric ions is very sensitive to violet light. Thus, a stronger bleaching effect of blue-violet light may be caused both by a specific effect of this light on chlorophyll itself and by its destructive influence on a yellow product of the reversible primary process.

The quantum yield, γ , of the bleaching of chlorophyll is very small: since the "half-time" of bleaching in intense light (in which a molecule

absorbs about once in a second) is several hours, γ must be less than 10^{-4} . Porret and Rabinowitch (1937) estimated that for ethyl chlorophyllide *a* in methanol, the quantum yield of irreversible bleaching is of the order of 10^{-6} only; while Livingston (1941) found $\gamma \approx 5 \times 10^{-5}$ in methanol, and a three times larger value in acetone. Aronoff and Mackinney (1943) gave quantum yields of about 5×10^{-4} for chlorophyll solutions in acetone and benzene.

All these estimates are based on the assumption that the reaction products do not absorb any red light at all. It is not certain, however, that the color disappears in the very first step of the photochemical transformation; to the contrary, the first reaction products may still be green and the photometric determination of the quantum yield may thus refer to a secondary decomposition step. According to Knorr and Albers (1935) and Albers and Knorr (1935), photochemical transformations often reveal themselves, in chlorophyll solutions, by changes in the fluorescence spectrum, without equally conspicuous changes in color. Obviously, bleaching should be studied by repeated determinations of the whole extinction curve, rather than by colorimetry or photometry in monochromatic light. Figure 54 shows the successive changes in the extinction

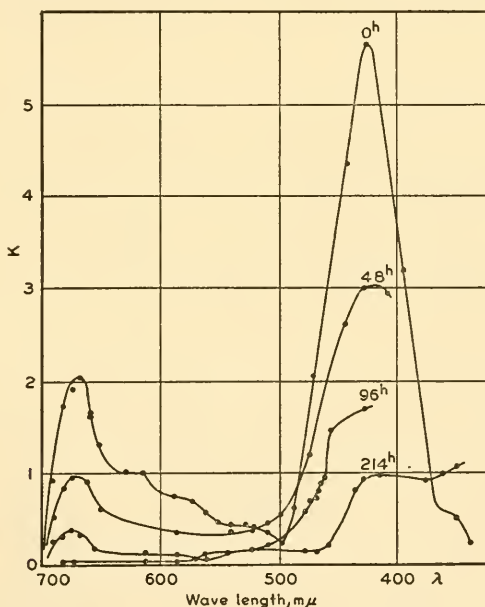

FIG. 54.—Changes in the absorption spectrum of illuminated chlorophyll solution in acetone (after Wurmser, 1921).

curve of an illuminated chlorophyll solution in acetone. The red band disappears completely after several days. The violet band is much more persistent, showing that the porphin structure is maintained in the first stages of the photodecomposition. Aronoff and Mackinney (1943) observed the formation of pink intermediates with

orange fluorescence in the photooxidation of chlorophyll dissolved in benzene or acetone (Fig. 55). Ferguson and Webb (1941) noticed a gradual increase in absorption in the green and infrared in illuminated leaf extracts.

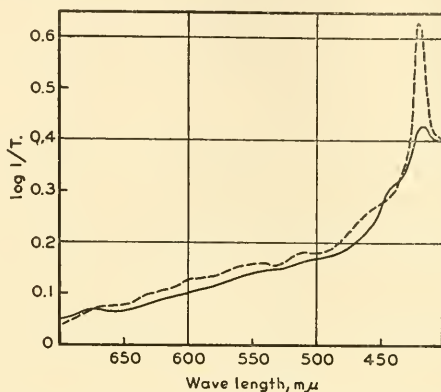

FIG. 55.—Absorption spectrum of the decomposition products of chlorophyll *a* (unbroken curve) and chlorophyll *b* (broken curve) in acetone (after Aronoff and MacKinney 1943).

2. Photoxidation as the Cause of Bleaching

As mentioned above, the chemical nature of the bleaching process is unknown and is probably complex. Most authors assumed that bleaching is caused by *photoxidation*; but the possibility of *photoreduction* shall not be overlooked, particularly in easily oxidizable solvents, or in the presence of oxidizable impurities. *Elimination of magnesium* may be an intermediary step, causing a temporary replacement of the pure green color of chlorophyll by the olive color of pheophytin. According to Jörgensen and Kidd (1916) and Aronoff and Mackinney (1943) bleaching takes this path in all acid solutions; while no intermediate pheophytin formation can be observed in neutral or alkaline media.

Arguments in favor of *autoxidation* as the cause of bleaching of chlorophyll are twofold. In the first place, Jörgensen and Kidd (1916) and Wurmser (1921) found that chlorophyll solutions do not bleach in the absence of oxygen, *e. g.*, in a nitrogen atmosphere, and Warner (1914) and Wager (1914) made the same observation with solid chlorophyll in collodion films. In the second place, an *absorption of oxygen* has been observed to occur during the bleaching.

However, the quantitative results of the latter experiments indicate that most of the absorbed oxygen was utilized for the sensitized autoxidation of the solvent, or impurities, and *not* for the oxidation of chlorophyll itself. Jodin (1864) found, for example, in the first study of this problem, that 0.7 gram of oxygen was taken up in a month by 1 gram

of chlorophyll in ethanol—corresponding to as much as 20 molecules of oxygen per molecule of chlorophyll. Gaffron (1933) found that fresh ethyl chlorophyllide solutions in acetone absorbed oxygen with a quantum yield of the order of 0.1–0.3; the yield decreased with time, but was still as high as 0.006 even after one month of storage. If this were the quantum yield of *bleaching*, all chlorophyll would be bleached, in moderately intense light, in less than a minute. Since no such rapid bleaching has ever been observed, practically all oxygen must have been transferred to the solvent or to oxidizable impurities. Thus, the uptake of oxygen during the bleaching period is not a conclusive proof of the oxidation of chlorophyll. Experiments on allomerization (pp. 460 *et seq.*) showed that chlorophyll can take up one molecule of oxygen without appreciable change in color. (We do not know how this reaction is affected by light.) In allomerization too, the nature of the medium is of paramount importance (oxygen being taken up in methanol or ethanol, but not in ether or pyridine). Thus, one cannot be certain whether chlorophyll is the final oxygen acceptor in this case either. In reaction scheme (16.8–16.10) on page 461, chlorophyll and methanol were assumed to share the absorbed oxygen between them.

Gerland (1871) observed that chlorophyll solutions, which have taken up oxygen in the dark, bleach afterwards in light, even in the absence of oxygen. Whether this observation indicates that oxygen, taken up in the allomerization process, can later be transferred to other parts of the molecule where it causes bleaching, is difficult to say; Gerland's observations were carried out with crude extracts and have not been repeated with pure chlorophyll preparations. They are supported indirectly by observations on other dyestuffs. In contact with air, these dyes first form peroxides or "moxides," which are transformed into stable oxidation products by further exposure to light (see, for example, Gebhard 1909, 1910):

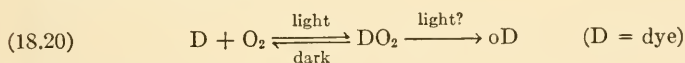

Gaffron (1933) opposed mechanism (18.20) for the photooxidation of chlorophyll, because, according to his observations, chlorophyll does not absorb oxygen and does not form peroxides—neither in light nor in the dark. His experiments were carried out in acetone, and therefore do not conflict with the observations on the oxygen uptake in allomerization, which occurs only in alcohols.

Because of the low partial pressure of oxygen, which suffices to bring about the maximum rate of bleaching of chlorophyll, the possibility that bleaching may be due to a direct reaction between excited fluorescent chlorophyll molecules and molecular oxygen can be discounted. A reaction between long-lived *tautomeric* chlorophyll (tChl) and molecular oxygen, on the other hand, can provide a plausible mechanism of bleaching:

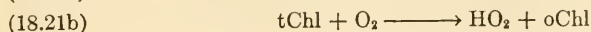
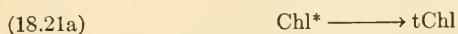

Reaction (18.21), if it occurs with a large quantum yield, must be almost completely reversible (to account for the low yield of bleaching); a small "leak" may be caused by the elimination of a certain proportion of HO₂ radicals (*e. g.*, by their dismutation to water and oxygen). A residue of oxidized chlorophyll molecules will thus be accumulated after prolonged illumination.

However, it seems probable that the photooxidation of chlorophyll in solution occurs not (or not only) in the way suggested by formula (18.21), but is associated with reversible oxidation-reduction reactions with the solvent, or impurities, such as were discussed in the preceding section. Gaffron suggested that the photooxidation of chlorophyll may be an indirect consequence of the sensitized oxidation of autooxidizable impurities ("acceptors") according to the following reaction scheme (A = acceptor; asterisks denote excited states):

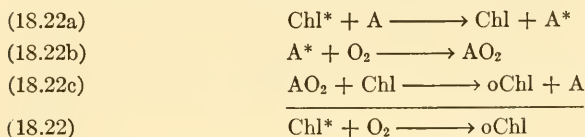

Reaction (18.22c) competes with the stabilization of the oxidized acceptor:

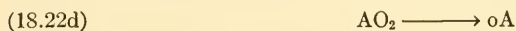

The discussion in section A (pages 484–486) suggests a twofold modification of Gaffron's scheme. In the first place, the part of the "acceptor," A, may be played by the solvent. In the second place, the reaction between chlorophyll and the acceptor (or solvent) is unlikely to be the simple energy transfer represented by (18.22a). The most probable primary process is an oxidation-reduction reaction of chlorophyll with the solvent (or with an impurity, or another chlorophyll molecule). All reaction schemes discussed in section A, *e. g.*, (18.11) or (18.15), which assume the reversible formation of oxidized chlorophyll, oChl, may serve to explain a small "residual" photooxidation, if one assumes that complete reversibility is disturbed by side reactions, which deprive some oxidized chlorophyll molecules of partners for the back reaction. For example, if the primary reaction of excited chlorophyll molecules is their oxidation by the solvent—as assumed in (18.15)—a partial re-oxidation of the reduced solvent by oxygen would leave some chlorophyll in the oxidized state:

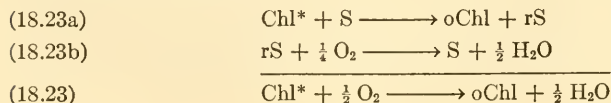

On page 491, we assumed that oxygen acts as a catalyst in the back reaction in (18.23a), *i. e.*, that in (18.23b) oxygen is reduced, not to water, but only to HO₂, and

that the latter radical reduces oChl to Chl; however, if the HO₂ radicals dismute into O₂ and H₂O, instead of reacting with oChl, the catalytic system "springs a leak," and the net result is that represented in (18.23).

Experiments of Knorr and Albers (1935) and Albers and Knorr (1935) on the fading of chlorophyll fluorescence show that photodecomposition may also occur in an atmosphere of pure nitrogen or carbon dioxide, sometimes even more rapidly than in oxygen. As described on page 492, this phenomenon may be attributed to a primary reversible oxidation-reduction reaction of activated chlorophyll with the solvent, which is converted into irreversible decomposition by the absorption of violet or ultraviolet light by oxidized chlorophyll (oChl). Whether this second irreversible step also is an oxidation we do not know. It will be noted that Wurmser (1921), also working with chlorophyll in acetone, found no bleaching in the absence of oxygen. Perhaps this discrepancy may be attributed to the high intensity of short-wave radiations in the experiments of Knorr and Albers (four 150-watt Pyrex mercury lamps in the axis of a cylindrical vessel containing the chlorophyll solution).

3. Effect of Solvents and Protective Substances on Bleaching

According to the preceding two sections, one of the ways in which the solvent can affect the photooxidation of chlorophyll, is by direct participation in the bleaching process, either in the reaction by which the bleaching is produced or in the reaction by which the original color is restored. In the presence of oxygen, this reaction cycle may leave, as a net result, a sensitized oxidation of the solvent. Thus, the solvent may "protect" the pigment from oxidation in light by a diversion of the oxidative action: a sensitized photooxidation of the solvent can be substituted for the direct photooxidation of the pigment. A similar diversion may be caused by dissolved "antioxygens," which are themselves oxidized in light, but prevent the photooxidation of the sensitizer. However, not all "antioxygens" act in this way; others exercise a truly catalytic influence, by accelerating the return of the oxidized pigment into its normal state, as assumed on pages 490 *et seq.* in the interpretation of inhibitory effects of the systems O₂-HO₂ and Fe⁺⁺⁺-Fe⁺⁺ on the reversible bleaching of chlorophyll. It is not always clear whether the protective action of a given "antioxygen" is of a "diversionary" or "catalytic" character, although effects of the second type should be distinguishable by a greater permanency.

Examples of substances which protect chlorophyll from photooxidation by diverting the reaction to themselves are benzidine and the carotenoids (Noack 1925, 1926; Aronoff and Mackinney 1943); also, hydroquinone, *p*-benzohydroquinone, phenol, resorcinol, pyrogallol, diphenylamine, and aniline (Weber 1936). Their action may be based either on a primary interaction of excited chlorophyll with the protecting "acceptor," A:

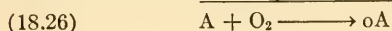
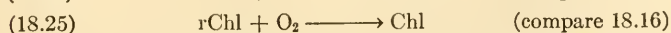
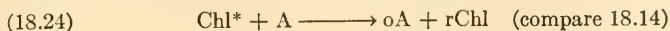

or on a primary interaction of chlorophyll with oxygen:

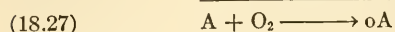
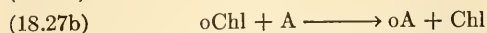

In mechanism (18.24–18.26), the acceptor *prevents* chlorophyll from reacting with oxygen. In mechanism (18.27), the oxidation of chlorophyll actually takes place, but *is reversed* by a reaction with the acceptor.

Whatever mechanism we assume for the inhibition of chlorophyll bleaching by autoxidizable compounds, this inhibition obviously contradicts scheme (18.22), according to which the oxidative bleaching of chlorophyll, instead of being inhibited by autoxidizable substrates, was supposed to occur only in their presence.

Not all known cases in which chlorophyll is stabilized in respect to molecular oxygen can be explained by diversionary or catalytic effects. The same result can apparently be achieved also by association of the pigment with certain substances which make it photostable without themselves suffering a permanent or temporary sensitized oxidation. This truly protective action can be explained, for example, by an accelerated dissipation of the excitation energy in the pigment–protector complex. If this dissipation competes with fluorescence, the “protected” pigment will be nonfluorescent; but since we have assumed that photochemical transformations often are preceded by tautomerization, dissipation may compete only with the latter process and leave fluorescence unaffected.

The action of protective colloids, investigated by Wurmser (1921), probably is of this type. The bleaching velocity could be reduced by 50% by as little as 0.05% of gelatin or casein; 0.86% albumen or 1.45% gum arabic were required to produce the same effect, whereas starch had no appreciable influence even in a concentration of 2%. Wurmser noticed a parallelism between the stabilizing action of a colloid on gold colloids and its efficiency in protecting chlorophyll from oxidation in light.

The protective action of *proteins* may fall into the same category. It was observed by Noack (1927) in artificial protein–chlorophyll complexes, and by Lubimenko (1927) and Smith (1941) in colloidal protein–chlorophyll leaf extracts. Katz and Wassink (1939) noted the considerable stability to light and oxygen of colloidal extracts from purple bacteria, as contrasted with the extreme sensitivity of molecularly dispersed bacteriochlorophyll.

The fact that artificial chlorophyll–protein complexes are nonfluorescent indicates that association of chlorophyll with these compounds further shortens the lifetime of the short-lived fluorescent state; the high partial pressure of oxygen required for photooxidations sensitized by

chlorophyll-protein complexes (*cf.* Fig. 58, page 530) shows that in these complexes no long-lived active states occur at all.

Lipophilic substances also have a protective effect on chlorophyll. Wiesner noted, as early as 1874, that the same degree of bleaching of chlorophyll could be achieved in 3 minutes in 75% alcohol, in 7 minutes in benzene, and in 12 minutes in ether; while a solution in olive oil required 3.5 hours for the same result. Chautard (1874) observed that chlorophyll-colored oils keep their color unchanged for months while exposed to light and air. According to Stern (1920, 1921), lipid-protected aqueous chlorophyll colloids also are photostable. Since lipophilic substances protect rather than quench the fluorescence of chlorophyll (*cf.* Vol. II, Chapter 23), they apparently do not interfere with the short-lived fluorescent state of the pigment. However, they seem to affect the long-lived activated state. If the transition into this state is initiated by tautomerization, lipid solvents may make it less probable (if the tautomer is an enol, as suggested on page 444, it is likely to be less stable in a lipophilic medium than in a polar solvent). If the long-lived state is brought about by a reaction of excited chlorophyll with the solvent, this reaction, too, may be less probable in a nonpolar, lipophilic solvent than in a solvent of the type of alcohol or acetone.

The stability of chlorophyll *in vivo* may be attributed to its association with protein (as suggested by Reinke as early as 1885), or lipides, or both (*cf.* page 393). The high partial pressure of oxygen required to bring about photooxidations in the living cell (*cf.* Fig. 58) proves that in this case, too, no long-lived active products are formed in light. (For a more detailed discussion of the mechanism of sensitization by chlorophyll *in vivo*, see Chapter 19, pages 544 *et seq.*)

Kautsky and Hormuth (1937) described experiments on the oxygen consumption by *grana sediments* (obtained by the centrifugation of leaf press juices). Suspensions, prepared from two grams of leaves, absorbed, in two hours of illumination, up to 0.16 ml. oxygen, without showing signs of saturation (which is not astonishing, since not more than 0.02 mole of oxygen was absorbed up to this point by one mole of chlorophyll). The velocity of autoxidation increased with increasing pH. The oxygen consumption was strongly reduced by *narcotics* (*e. g.*, phenylurethan).

4. Photochemical Oxidation-Reduction Reactions of Chlorophyll *in vitro*

Photochemical reactions of chlorophyll with azo dyes, in which it plays the part of a reductant, were described by Böhi (1929). The azo dyes are reducible (first to hydrazo compounds, then to amines), and in contrast to typical "leuco dyes," the reduction products are not re-oxidizable by oxygen, so that the reaction:



(D = dye) can be observed without excluding air. The result is the

decolorization of both the dye and the chlorophyll. The interpretation of the bleaching as a reduction (rather than oxidation) of the dye seems arbitrary; but Böhi quoted as proof an experiment with Janus green, a blue-green dye whose first reduction product is red, and the second one colorless. In this case, the second reduction stage is reversible, and the red intermediate product (the dye safranine) is re-formed in the presence of air. Upon illumination of a solution of chlorophyll and Janus green (in methanol), the solution first turns red. If oxidized chlorophyll is restored, *e. g.*, by reduction with phenylhydrazine, reduction of the dye can be carried a stage further. Addition of water and ether to methanol allows the separation of the reduced azo dye from chlorophyll and the demonstration that the dye has become entirely colorless. The sequence of color changes:

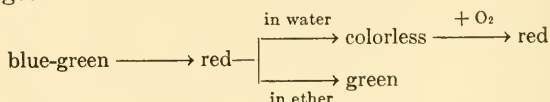

is looked upon by Böhi as a proof that Janus green is bleached by reduction and chlorophyll by oxidation, rather than vice versa.

In the experiments with binary chlorophyll-dyestuff mixtures, Böhi used about ten times more dye than chlorophyll. This indicates that one chlorophyll molecule caused the reduction of several molecules of the dye, *i. e.*, that chlorophyll catalyzed the reduction of the dye by some other reductant. The only available reductant (assuming that the solution was free of impurities), was the solvent (methanol); and so we must think of Böhi's reaction as partly a direct reduction of the dye by chlorophyll, and partly *a sensitized reduction of the dye by methanol* (the latter being probably oxidized to aldehyde). This conclusion reminds one of observations of Rabinowitch and Weiss (1937) on the chlorophyll-ferric iron system. They found that, when the yellow solution, obtained by oxidation of chlorophyll with ferric ions in methanol was allowed to stand until the green color re-appeared, most of the added Fe^{+++} was converted into Fe^{++} . It may be suggested that the yellow "oxychlorophyll," oxidizes methanol; consequently, a part of the "oxychlorophyll" formed by reaction with Fe^{+++} ions reverts to the reduced state by reaction with the solvent, and the net result is a chlorophyll-catalyzed oxidation of methanol by ferric ions.

If this interpretation of the results of Böhi and Rabinowitch and Weiss is correct, chlorophyll can serve as an oxidation-reduction catalyst, even in nonphotochemical reactions. According to Böhi, the chlorophyll-Janus green reaction is accelerated by the provision of a specific reductant for oxidized chlorophyll, *e. g.*, turpentine oil, pinene, piperidine or phenylhydrazine. These substances play the part which was assigned

above to methanol, only more efficiently; they accelerate the bleaching of the azo dye, while preventing that of chlorophyll.

Böhi carried out similar experiments with 25 different dyes, including azofuchsin, ponceau 2R, Congo red, diamine green, etc. The bleaching required from one-half hour to 15 hours (in direct sunlight) in binary chlorophyll-dyestuff systems, but only five to ten minutes in ternary systems containing phenylhydrazine.

Böhi noticed that *yellow* dyestuffs, even the easily reducible ones, *e. g.*, metanil yellow and azoflavin, were not reduced by chlorophyll in light. In an earlier work, Baur and Neuweiler (1927) formulated a rule for sensitization (reminiscent of Stokes' rule), according to which the absorption band of the sensitizer must lie on the violet side of that of the substrate. Böhi used this rule to explain the lack of reaction of chlorophyll with yellow dyes. If we assume that the primary interaction between excited chlorophyll and the dyestuff is an oxidation-reduction, as in (18.28), the importance of the relative position of the absorption bands appears unexplained. The rule of Baur and Neuweiler, if confirmed, could be used as an argument in favor of an alternative mechanism (similar to Gaffron's mechanism 18.22 of chlorophyll bleaching) in which the first step is the *transfer of excitation energy*:

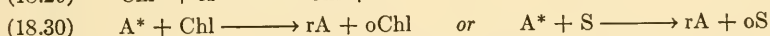
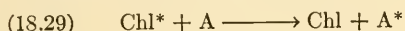

The energy transfer (18.29) is not improbable between two dyestuffs which absorb in the same spectral region, (this case being different from that of energy transfer from a dye to a colorless acceptor, which was considered in 18.22).

In the experiments of Rabinowitch and Weiss, and Böhi, chlorophyll reveals its capacity for *reversible photochemical oxidation* (analogous to its capacity for reversible *thermochemical* oxidation, discussed in chapter 16, page 465). The *irreversible* photooxidation of chlorophyll probably is merely a secondary and rather infrequent consequence of this primary reversible oxidation.

5. Photoreduction of Chlorophyll

It was stated in chapter 16 that efforts to reduce chlorophyll reversibly to a leuco compound, have not been successful. However, the difficulty was not a general reluctance of chlorophyll to be reduced, but the occurrence of irreversible side reactions (*cf.* page 457).

Similarly to all the other simple reactions of chlorophyll, its reduction probably can be accelerated by light. However, chlorophyll has less tendency for photochemical reduction than the typical reversibly reducible dyes—*e. g.*, indigo, thiazines, and oxazines. Thus, Windaus and Borgeaud (1928) were unable to oxidize ergosterol by chlorophyll in light (in the absence of oxygen), a reaction which could easily be accomplished by means of eosine; similarly Meyer (1935) found that diethylamine can be dehydrogenated photochemically by eosine, but not by chlorophyll.

On the other hand, Timiriazev (1869) asserted that chlorophyll solutions in ethanol are bleached by light, even in absence of oxygen, and that they smell of aldehyde after exposure, thus showing that the bleaching must have been caused by a reduction of chlorophyll and oxidation of alcohol to aldehyde. The observations of Osterhout (1918) on the formation of aldehydes in illuminated chlorophyll solutions (*cf.* page 496) also may be explained by a photooxidation of alcohols (present as solvents or impurities), rather than by a photochemical decomposition of chlorophyll itself. The observations of Knorr and Albers (1935) and Albers and Knorr (1935) on the photodecomposition of chlorophyll solutions in acetone in the absence of oxygen, which were attributed on page 501 to a *photoxidation* of the pigment at the cost of the solvent, may equally well be explained by a *photoreduction* of the pigment, and oxidation of acetone.

As mentioned above, reductive bleaching is a characteristic property of many dyestuffs. Some of them are reduced reversibly (*e. g.*, the thiazines, the oxazines, and the triphenylmethane derivatives), others irreversibly (*e. g.*, many azo dyes). The reductive bleaching of "vat dyes" was investigated, for instance, by Kögel and Steigmann (1925), Kögel (1926), Mudrovčič (1929), and Weber (1931), who used diethyl thiourea, piperonal, and other organic compounds as reductants, as well as ferrous salts. Later (1936), Weber reported that the bleaching of chlorophyll exhibits a similarity to that of the reducible dyes in that it, too, is accelerated by the presence of *small quantities* of diethyl thiourea, diallyl thiourea, and other substances which are efficient reductants of vat dyes. However, Weber found that *larger quantities* of the same reductants act as inhibitors, probably by retarding the *oxidative* bleaching of chlorophyll (as discussed on pp. 501-502). We may thus assume that chlorophyll can be bleached either by oxidation or by reduction; small quantities of diethyl thiourea and similar reductants cause an increase in bleaching by accelerating the *reductive* bleaching; while larger quantities of the same reductants have the opposite effect, by preventing the *oxidative* bleaching. This is merely a tentative explanation, and new experiments on the interaction of illuminated, oxygen-free chlorophyll solutions with organic reducing agents are desirable.

It must be mentioned that, according to Weber (1931), certain reducing agents (hydroquinone, pyrogallol, phenol, cyanide, iodide) inhibit the *reductive* bleaching of many dyestuffs as well. The mechanism of this paradoxical effect is as yet not clear.

The photoreduction of many dyestuffs is accelerated by neutral salts (sodium chloride, potassium chloride, etc.; see Weber 1931), whereas the photooxidation often appears retarded by them (*cf.* Noack 1925, 1926). This result can be compared with the observation of Rabinowitch and Weiss (1937) that the reversible reaction of chlorophyll with ferric chloride (both in the dark and in light) is inhibited by neutral salts.

C. CHLOROPHYLL AS A SENSITIZER *in vitro* *

1. Examples of Sensitization by Chlorophyll

In the preceding discussion, we mentioned several mechanisms of chlorophyll bleaching in which this process appeared merely as a side reaction associated with the sensitized oxidation of the solvent, added "acceptors," or impurities. We shall now discuss these sensitized reactions in more detail. The distinction between a "photochemical reaction of a dyestuff" and a "reaction sensitized by a dyestuff" often is merely one of emphasis. Authors who are interested in the transformations of the pigment often do not care much about concomittant changes suffered by other components of the reacting system; while investigators whose interests are centered on the effects of light on the "substrates" of sensitization often ask no questions as to the fate of the sensitizing pigment. It was suggested on page 56 that the term "photocatalysis" be used for reactions in which the sensitizing pigment is known to remain unchanged. We shall have to deal here with some truly photocatalytic reactions, but also with some whose photocatalytic character is by no means certain.

Our knowledge of the sensitizing properties of dyestuffs, including chlorophyll, developed from two sources. In 1874, Vogel discovered the sensitization of the photographic plate, and Becquerel found that chlorophyll can be used for this purpose. A quarter of a century later, Raab discovered that *Paramoecia* are killed by visible light in the presence of certain dyestuffs, and thus initiated the study of the "photodynamic effects" (a term introduced by von Tappeiner and Jodlbauer in 1907). Hausmann (1908) and Hausmann and Kolmer (1908) found that extracts from green plants are "photodynamically active," and Hausmann (1909) made a similar observation with pure chlorophyll solutions. Basically, "photodynamic effect" is the same phenomenon as Vogel's and Becquerel's "sensitization." Von Tappeiner and Jodlbauer called their book *Sensitizing Effects of Fluorescent Dyestuffs*, and suggested the term "photodynamic effect" only as a provisional one, to be used for "biological" sensitizations until their nature was better known. However, this term became widely accepted and is often used by biologists even when dealing with reactions *in vitro*, such as the autoxidation of iodide in the presence of eosine (cf. Spealman and Blum 1937).

Certain authors (cf. Gieklhorn 1914) believed in fundamental differences between photodynamic effect and ordinary sensitization. They quoted, for example, the necessity of molecular oxygen for photodynamic action (a photographic plate can be sensitized in nitrogen), or the fact that only fluorescent dyes are photodynamically active (whereas nonfluorescent dyes can be used in photography). However, the first

* Bibliography, page 524.

distinction merely indicates that the photodynamic actions are autoxidations (while the photographic process is an oxidation-reduction, which does not require oxygen). The connection between fluorescence of dyestuffs and their photodynamic activity, which has assumed in the eyes of some authors an almost mystic character (it has even been suggested that a fluorescent dye can be recognized as such by its photodynamic action, even if no fluorescence is visible!), is a simple consequence of the proportionality between mean life time of the excited molecule and yield of fluorescence (Vol. II, Chapter 23). This often makes sensitization by a fluorescent dye more probable; but under certain circumstances, for example, if the absence of fluorescence is caused by tautomerization, or if a permanent association exists between sensitizer and substrate (a condition realized in the sensitized photographic plate), the life span of the activated nonfluorescent molecule is sufficient to bring about sensitization.

Both autoxidations and oxidation-reductions can be sensitized by chlorophyll. Sensitized autoxidations can be of three kinds: reversible, leading to unstable "moxidides"; "half-reversible," leading to peroxides from which one-half of the absorbed oxygen can be recovered again; or

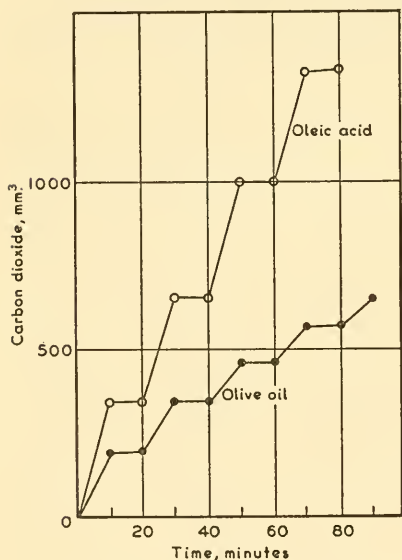

FIG. 56.—Oxygen uptake by oleic acid and olive oil in light with chlorophyll as sensitizer (after Meyer 1935). Horizontal sections correspond to interruptions of illumination.

irreversible, leading to stable oxidation products. It is not always known to which type a given autoxidation belongs, since very often the process was followed only by observing the absorption of oxygen. To determine the amount of peroxide formation, Gaffron (1927, 1933) treated the reaction products with manganese peroxide and often a considerable part of absorbed oxygen was liberated again. Meyer (1935) found that oleic acid, citronellal, pulegone, etc., when subjected to sensitized photoxidation and then tested by means of bromine or permanganate, seemed to have their double bonds intact. In other cases, *e. g.*, that of benzidine (Noack 1925, 1926) or pyruvic acid (Meyer 1935), the photosensitized reaction was a true oxidation. Probably, the primarily formed moloxides or peroxides later are converted into stable oxidation products. This may explain why Windaus and Bruncken (1928) have observed, in studying the sensitized photoxidation of ergosterol, the absorption of one mole of oxygen and the formation of a crystallizable ergosterol peroxide without antirachitic properties, whereas

Meyer (1935) found, with the same substrate, the absorption of only a half mole of oxygen, and obtained products with a definite antirachitic activity.

In table 18.I are collected the main results of sensitization experiments with chlorophyll, ethyl chlorophyllide, and leaf extracts. The table is divided into three parts: (A) *photodynamic effects*, that is, oxidations *in vivo* of unknown cellular constituents, recognizable by their physiological effects; (B) *autoxidations in vitro*, reversible as well as irreversible; and (C) *oxidation-reductions*. Phenomena of the last group are of particular interest to us, since the function of chlorophyll in photosynthesis is to sensitize an oxidation-reduction. Unfortunately, the investigations of Böhi (1929) and Allison (1930) have all the shortcomings of the work emanating from Baur's laboratory: in addition to the "electrochemical language" in which the experiments are described, with "anodic" and "cathodic" "depolarizers" substituted for reductants and oxidants (cf. Chapter 4), we miss an exact photochemical technique. For instance, in experiments with two-dye systems (chlorophyll as sensitizer and another dye as oxidant), no attempt was made to use light absorbed by one component only, although the behavior of methylene blue, which is reduced by phenylhydrazine in light even in the absence of chlorophyll, clearly shows that the direct photochemical reactions of the "acceptor" dyes cannot be neglected.

As a further illustration of a combined photochemical action of both components of a two-dye system, we may mention that Holst (1934, 1936, 1937) found that the oxidation-reduction equilibrium:

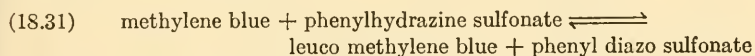

is shifted in one direction by light absorbed by methylene blue, and in the opposite direction by light absorbed by phenyl diazo sulfonate.

The only quantitative investigations among all those listed in table 18.I were those by Gaffron (1927, 1933) and by Ghosh and Sen-Gupta (1934). Gaffron studied the autoxidation of allyl thiourea in acetone, with ethyl chlorophyllide as sensitizer, and found that the quantum yield, γ , reaches unity (in red, yellow, green, and blue light) if the substrate concentration, $[A]$, is at least 0.01 mole per liter. The yield drops at the lower acceptor concentrations and at the higher concentrations of the sensitizer (Table 18.II). The quantum yield can be represented by the following empirical equation:

$$(18.32) \quad \gamma = \frac{0.004 [A]}{0.004 [A] + 0.023 [\text{Chl}] + 1}$$

Its theoretical implications will be discussed later (pages 518 *et seq.*, and 546).

TABLE 18.1

REACTIONS SENSITIZED BY CHLOROPHYLL

Observed by	Sensitizer	Substrate or acceptor	Result
A. BIOLOGICAL SENSITIZATIONS			
Hausmann (1908); Hausmann and Kolmer (1908) Hausmann (1909) Hausmann and von Portheim (1909) Eisler and von Portheim (1922)	Leaf extract in CH_3OH MeChl in CH_3OH Extracts from etiolated leaves (protochlorophyll? carotene?) Artificial chlorophyll-protein complexes	Erythrocytes, Paramoecia Erythrocytes, Paramoecia Erythrocytes Erythrocytes	Hemolysis, death As above, but stronger effects Hemolysis, but weaker than with extracts from green leaves Hemolysis
B. AUTOXIDATIONS			
Noack (1925, 1926)	Chl ($a + b$) in CH_3OH Crude Chl extracts in CH_3OH MeChl ($a + b$) in CH_3OH EtChl ($a + b$) in CH_3OH Chl ($a + b$) in lecithin Cu-pheophytin in CH_3OH ; colloidal Chl in H_2O Chl ($a + b$) in petroleum ether Chl ($a + b$) in ether Chl ($a + b$) in 90% CH_3OH with Fe^{++} and Cu^{++} ions	<div style="display: flex; align-items: center; justify-content: center;"> <div style="border-left: 1px solid black; border-right: 1px solid black; padding: 0 10px;">Benzidine $\text{NH}_2 \cdot \text{C}_6\text{H}_4 \cdot \text{C}_6\text{H}_4 \cdot \text{NH}_2$</div> <div style="font-size: 2em; margin: 0 10px;">}</div> <div style="border-left: 1px solid black; border-right: 1px solid black; padding: 0 10px;">Carotene Xanthophyll Benzidine</div> </div>	Oxidation to benzidine blue, and higher oxidized, brown-violet products; accelerated by MnO_2 ; chlorophyll protected by the acceptor. No oxidation Bleaching of the carotenoids; chlorophyll protected Accelerated oxidation at low Fe^{++} concn. (1.5×10^{-4} mole/l.), then retardation; Cu^{++} even more effective; acceleration destroyed by HCN and Na_2SO_4 Oxygen absorbed; yield increasing with oxygen pressure, even at 1 atm.
Gaffron (1926)	EtChl, 5×10^{-6} mole/l.	Horse serum	O $_2$ absorbed, SO_2 liberated; quantum yield up to 1 (cf. page 509), independent of oxygen pressure
Gaffron (1927, 1933)	EtChl in acetone	Allyl thiourea $\text{NH}_2 \cdot \text{CS} \cdot \text{NH} \cdot \text{CH}_2 \cdot \text{CH} : \text{CH}_2$	

TABLE 18.1—Continued

Observed by	Sensitizer	Substrate or acceptor	Result
B. AUTOXIDATIONS—Continued			
Gaffron (1927 ²)	EtChl in isoamylamine EtChl in dioxane EtChl in isoamylamine + H ₂ O EtChl in diisobutylamine	<p>Isoamylamine (CH₃)₂CH·CH₂·CH₂·NH₂</p> <p>Diisobutylamine [(CH₃)₂·CH·CH₂]₂·NH</p> <p>Ethylamine CH₃·CH₂·NH₂</p>	O ₂ absorbed; amine-peroxide formed (oxidizes I ⁻); all O ₂ again liberated by MnO ₂ ^a 50% of absorbed O ₂ released by MnO ₂ ^b
Meyer (1935) Windaus and Bruncken (1928)	EtChl in dioxane-water (5:1) Chl (a + b) Chl in 95% C ₂ H ₅ OH	Diethylamine CH ₃ ·CH ₂ ·NH ₂ Diethylamine (C ₂ H ₅) ₂ ·NH Ergosterol (C ₂₇ H ₄₄ O)	Oxidation slower than with isoamylamine; 65% of absorbed O ₂ released by MnO ₂ 50% of absorbed O ₂ released by MnO ₂ “ “ “ “ “ “ 1 mole O ₂ absorbed; crystallizable acceptor peroxide (C ₂₇ H ₄₄ O ₄) formed
Meyer (1933 ³ , 1935)	Chl in paraffin oil, buffer in H ₂ O	Ergosterol in cyclohexanal	½ mole O ₂ absorbed; no peroxide formed
Meyer (1933 ¹ , 1935)	“Isochlorophyllin” (alkaline chlorophyll)	Pyruvic acid CH ₃ :CHOH·COOH (enolic form)	2 moles O ₂ absorbed; oxidation to oxalic acid and CO ₂
Meyer (1933 ³ , 1935)	Chl (a + b) in oleic acid, or olive oil, or in cyclohexanol + H ₂ O	Oleic acid (C ₁₇ H ₃₃ COOH), olive oil	½ mole O ₂ absorbed (Fig. 56); double bond intact; probably hydroxy oleic acid formed
	Chl (a + b) in acceptor	Citronellal CH ₂ :C(CH ₃)·(CH ₂) ₃ ·- CH(CH ₃)·CH ₂ ·CHO	Slightly > 1 mole O ₂ absorbed; double bonds and C=O bond (in citronellal) intact
	Chl (a + b) in acceptor	Linalool (CH ₃) ₂ ·C(CH ₂)·CH ₂ ·- C(OH)(CH ₃)·CH:CH ₂	
	Chl (a + b) in acceptor	Terpineol (mixture of 4 isomers) Pulegone CH ₂ :C ₉ H ₁₆ :O·C(CH ₃) ₂ I ⁻ ions	
Franck and Levi (1934) Gaffron (1933)	Leaf extracts in C ₂ H ₅ OH EtChl (a + b)	Rubrene C ₁₂ H ₂₃	Oxidized to I ₂ Rubrene peroxide formed; yield independent of [O ₂]
French (1940)	Bacteriochlorophyll (colloidal extracts)	Ascorbic acid	Oxidation

Continued

TABLE 18.I—Continued

Observed by	Sensitizer	Oxidant	Reductant	Effect
C. OXIDATION-REDUCTIONS				
Böhi (1929)	Chl ($a + b$) in CH_3OH	25 azo dyes (<i>e. g.</i> , azo-fuchsin, ponceau 2R, diamine green, Congo red, Janus green), not forming reversible leuco forms 6 dyes forming reversible leuco forms (<i>e. g.</i> , thioindigo, safranine T, malachite green) Methylene blue	Partly Chl, partly CH_3OH , partly "anodic depolarizers" (<i>e. g.</i> , piperidine or phenylhydrazine) Phenylhydrazine or Chl	Irreversible reduction of the azo dyes; in absence of "depolarizers," oxidative bleaching of Chl Reversible bleaching of the dye
Allison (1930)	Chl ($a + b$) in C_6H_6 or CCl_4 Chl ($a + b$) in CH_3OH	Dyes in H_2O Azo dyes	Phenylhydrazine Phenylhydrazine Oxalic acid	Rapid bleaching (also without Chl!) Bleaching much slower than in homogeneous systems Bleaching of the azo dye (supposedly by reduction, with oxidation of oxalic acid to CO_2) Accelerated reduction of the dye in light Gas consumption (supposedly water synthesis)
Ghosh and Sen-Gupta (1934) Rabinowitch and Weiss (1937)	Chl ($a + b$) in CH_3OH , in alkaline solution [CaO , $\text{Ba}(\text{OH})_2$, or NaOH] Chl in CH_3OH or C_6H_6 MeChl a and ($a + b$) in CH_3OH	5 azodyes (<i>e. g.</i> , azo-fuchsin or Janus green) O_2 Methyl red Fe^{+++}	Palladium-hydrogen H_2 (without catalyst) Phenylhydrazine; phenylhydrazine hydrochloride Methanol (?)	Quantum yields up to 1 in CH_3OH , up to 0.5 in C_6H_6 Fe^{+++} disappears, probably by oxidizing the solvent

* The amine peroxides formed in these experiments apparently decompose *monomolecularly* (cf. Chapter 11, page 291), thus liberating *all* the absorbed oxygen.

^b The peroxide formed in these experiments (H_2O_2 ?) decomposes *bimolecularly* (by dismutation) and thus releases only one-half of the absorbed oxygen.

TABLE 18.II

QUANTUM YIELD OF CHLOROPHYLL-SENSITIZED AUTOXIDATION OF ALLYL THIOUREA

Allyl thiourea, [A] in mole/l. $\times 10^{-3}$	Ethyl chlorophyllide, [Chl] in mole/l. $\times 10^{-3}$	Quantum yield, γ	
		Observed	Calcd. from eq. (18.32)
0.75	1.54	0.105	0.085
7.5	1.54	0.44	0.46
10.0	1.54	0.54	0.53
10.0	0.154	0.94	0.90
75.0	1.54	0.86	0.90

Equation (18.32) does not include the effect of variable oxygen concentration. This effect was comparatively small (in the range investigated by Gaffron). For example, at $[A] = 1 \times 10^{-2}$ mole per liter and $[Chl] = 0.153 \times 10^{-2}$ mole per liter, $\gamma = 0.38$ at $[O_2] = 3 \times 10^{-4}$ mole per liter and 0.48 at $[O_2] = 75 \times 10^{-4}$ mole per liter. Even smaller is the influence of $[O_2]$ on the yield of autoxidation of rubrene sensitized by chlorophyll (Gaffron 1933, 1937), particularly at the higher concentrations of the acceptor.

Ghosh and Sen-Gupta (1934) measured, in methanol and benzene, the rate of the chlorophyll-sensitized reaction between methyl red and phenylhydrazine discovered by Böhi. The quantum yields calculated for the *total* absorption by both pigments were considerably below unity; but when the yields were related to the absorption by chlorophyll alone, γ values were found to approximate unity at the lower concentrations of the sensitizer (*cf.* Table 18.III). The table shows that the yields

TABLE 18.III

QUANTUM YIELD (γ) OF THE CHLOROPHYLL-SENSITIZED OXIDATION-REDUCTION REACTION BETWEEN METHYL RED AND PHENYLHYDRAZINE
(CALCULATED FOR CHLOROPHYLL ABSORPTION ALONE)

Wave length, $m\mu$	Solvent	[Chl], mole/l. $\times 10^6$				
		1.2	1.66	2.5	5	10
546	CH ₃ OH	1.0	—	0.70	0.32	0.13
546	C ₆ H ₆	—	0.45	0.48	0.24	0.10
436	CH ₃ OH	—	1.08	0.8	0.45	0.2

are higher in methanol than in benzene, and decline rapidly with increasing concentration of chlorophyll (in agreement with Gaffron's observations). They are independent of temperature (between 25° and 35° C.), and of the methyl red concentration (between 0.005 and 0.02

mole per liter). The dependence on wave length is not very pronounced in methanol, but in benzene, γ values obtained at 436 $m\mu$ were as low as 0.05. Very low quantum yields were obtained when phenylhydrazine hydrochloride was substituted for the free base.

2. Different Mechanisms of Sensitization

Several mechanisms by which autoxidations and oxidoreductions can be sensitized have been mentioned in this chapter. They involve a triple alternative:

(1) the sensitizer may be either (A) free, or (B) associated with one of the reaction partners;

(2) the interaction of the sensitizer with the substrate may be either (α) an energy transfer, or (β) an oxidation-reduction (that is, electron transfer or hydrogen transfer);

(3) the component with which the light-activated sensitizer reacts may be either (1) the oxidant, or (2) the reductant.

This gives eight combinations—all theoretically possible; most, if not all, have been discussed in the literature.

3. Sensitization by Kinetic Encounters (Type-A Mechanisms)

(a) *Energy Transfer to the Oxidant (Mechanism A α 1)*

Kautsky made the sweeping claim that all dyestuff-sensitized reactions—not only autoxidations, but even oxidation-reductions, including photosynthesis—are initiated by the transfer of excitation energy from the dyestuff to oxygen, bringing the latter into the metastable excited state ${}^1\Delta$ (37.3 kcal above the ground level ${}^3\Pi$).

The origin of this hypothesis will be described in volume II, chapter 23. It will be shown there that the quenching of chlorophyll fluorescence by oxygen indicates that excited fluorescent chlorophyll molecules in fact react with oxygen, perhaps even by the very first encounter, but that this interaction becomes fully effective only when the partial pressure of oxygen reaches the order of one atmosphere, corresponding to more than 0.01 mole per liter. On the other hand, according to Gaffron (1933), the quantum yield of chlorophyll-sensitized photooxidation of allyl thiourea is high, and almost independent of oxygen concentration, between 10^{-4} and 10^{-3} mole per liter; and the same is true of the chlorophyll-sensitized oxidation of rubrene. At these concentrations, the probability of encounters of the short-lived fluorescent chlorophyll molecules with oxygen molecules is too small to account for the high efficiency of sensitized oxidation.

To explain this fact, Kautsky, Hirsch, and Flesch (1935) have postulated the existence of a *long-lived excitation state* of chlorophyll (*cf.* page 486). Kautsky suggested that both the short-lived fluorescent, and the long-lived metastable, chlorophyll molecules can transfer their energy in bulk to oxygen molecules, and that this energy is sufficient—even in the second case—to promote oxygen to the metastable state ${}^1\Delta$. (The excitation energy of this term corresponds to a wave length of 762 $m\mu$.) An objection was raised by Gaffron (1935), who found that autoxidation of allyl thiourea can also be sensitized by *bacteriochlorophyll* in infrared light ($\lambda > 760 m\mu$). Kautsky

and Flesch (1936) attempted to explain this fact by the utilization of a certain amount of thermal energy. Later, Gaffron (1936) found that the efficiency of sensitization remains practically the same even at 818 $m\mu$, and pointed out that, if the sensitization in the infrared were an "anti-Stokes" process, in which thermal energy must help to bring about the excitation of oxygen, the yield in the infrared should be much smaller than in the visible. This objection was answered by Kautsky (1937) with a reference to a second metastable state of the oxygen molecule, $^1\Sigma$, with an excitation energy of only 22.5 kcal, which can be supplied by radiations up to 1261 $m\mu$.

The general arguments against the transfer of electronic excitation energy in bulk from a colored sensitizer to a colorless acceptor, to be discussed in chapter 23 (Vol. II), as well as the lack of positive evidence in favor of the roundabout way of utilization of light energy assumed by Kautsky, are sufficient for the rejection of his hypothesis.

The energy transfer becomes less improbable if the oxidant is itself a dyestuff—particularly one whose absorption bands overlap with those of the sensitizer. On pages 503–505 (*cf.* Eq. 18.29), we have considered the possibility that a mechanism of this type may account for the chlorophyll-sensitized reduction of azo dyes. An interesting demonstration of such a transfer is the carotenoid-sensitized fluorescence of chlorophyll *in vivo* (*cf.* Vol. II, Chapter 24).

(b) *Oxidation-Reduction Reaction with the Oxidant (Mechanism A β 1)*

As stated on page 486, we do not believe that chlorophyll molecules, which fail to emit fluorescence, pass into a *metastable electronic state*; but we considered it possible that these molecules may pass into a chemically changed active state of considerable duration. Similarly, while we do not consider probable a purely physical transfer of excitation energy from metastable chlorophyll molecules to oxygen, we admit the possibility of a chemical reaction (*e. g.*, an electron transfer) between activated chlorophyll and oxygen. In presence of an oxidizable substrate, A, this reaction may become a prelude to sensitized photooxidation, in the following way, for example:

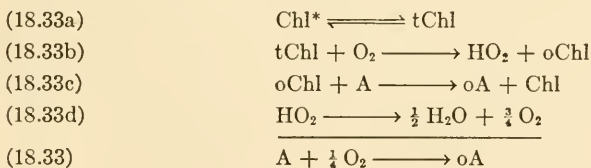

The formation of the radicals, HO_2 , was first suggested by Weiss (1935) as a substitute for that of metastable oxygen molecules, in the explanation of Kautsky's experiments on the transfer of sensitization across air gaps; *cf.* volume II, chapter 23.

Reaction (18.33c) is identical with (18.27b)—the reaction which was assumed on page 502 to explain the protection of chlorophyll from photooxidation by autooxidizable substances.

As mentioned on page 491, a tautomerization of the sensitizer may be replaced by a reversible reaction with the solvent, as, for example:

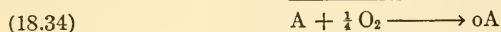
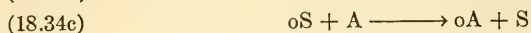
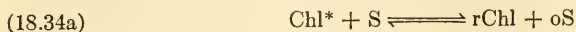

A mechanism similar to (18.33) may account also for the sensitized oxidoreductions listed in the last part of table 18.I:

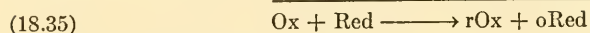
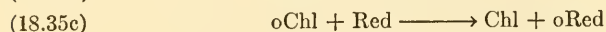
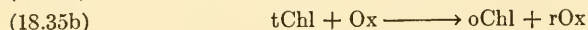

In this case, too, a primary reaction with the solvent can be substituted for tautomerization as the initial step.

(c) *Energy Transfer to the Reductant (Mechanism A α 2)*

It has been mentioned on page 500 that Gaffron (1927, 1933, 1937) postulated a transfer of the excitation energy of chlorophyll to the *oxidation substrate*, A (cf. Eq. 18.22a). To explain the efficiency of sensitized oxidation at low oxygen pressures, Gaffron had to assume that these substrates, *e. g.*, amines or rubrene, are transferred into long-lived activated states. Kautsky objected to Gaffron's mechanism because many sensitization substrates—including allyl thiourea, used by Gaffron—do not quench the fluorescence of chlorophyll. However, this objection loses its strength if one assumes, with Franck and Livingston (1941), that sensitization is brought about by a long-lived active modification of chlorophyll, rather than by the short-lived fluorescent chlorophyll molecules.

If we assume tautomerization (or a reversible reaction with the solvent) as the first step, the next logical step is *oxidation-reduction* (transfer of electrons or hydrogen atoms), rather than a transfer of energy (as assumed by Gaffron), because the active product, being chemically different from normal chlorophyll, cannot return to the normal state without a shift in the position of the atomic nuclei (*e. g.*, an intramolecular or intermolecular transfer of a hydrogen atom). We have then to consider, instead of mechanism A α 2, mechanism A β 2, that is, an oxidation-reduction reaction between sensitizer and reductant.

Franck and Levy (1934) suggested that collisions with excited dyestuff molecules may induce a *dissociation* of the acceptor (which we formulate for this purpose as RH):

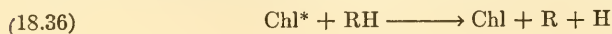

but this mechanism is improbable in consideration of the large amount of energy required for such a dissociation (*cf.* page 484).

(d) *Oxidation-Reduction Reaction with the Reductant (Mechanism Aβ2)*

Weiss (1936) and Weiss and Fischgold (1936) suggested that the primary process of sensitized oxidation is an oxidation-reduction reaction between the dyestuff and the substrate of oxidation. The simplest mechanism of this type is:

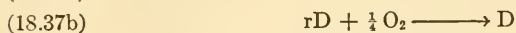

This mechanism is highly probable in the case of dyestuffs forming colorless leuco bases. Their fluorescence is strongly quenched by reductants (I⁻ ions, Fe⁺⁺ ions, and autoxidizable organic compounds). If these dyes are brought together with reductants whose oxidation-reduction potentials are higher than their own, they are reduced (bleached) even in the dark; in light, they can be reduced also by reductants with an oxidation-reduction potential lower than their own. Since this bleaching is reversed in the dark, by the reoxidation of the leuco dye, a stationary state is established during the illumination which differs from the thermodynamic equilibrium. The dyestuff is bleached as long as the system is illuminated. The best example of such reversible bleaching is the reaction of thionine (Lauth's violet) with ferrous ions, described in chapter 4 (page 77) and 7 (page 152). This system can be bleached completely in a few seconds by sufficiently strong light, and recovers its color almost instantaneously in the dark. Other similar systems, *e. g.*, thionine and potassium iodide, or eosine and ferrous ions, are less sensitive, and their reversible bleaching can be discovered only by means of photometric measurements (Rabinowitch and Weiss, unpublished). In the presence of oxygen, some leuco thionine is reoxidized by oxygen, and ferric ions are accumulated, the net result being a *thionine-sensitized autoxidation of ferrous iron*:

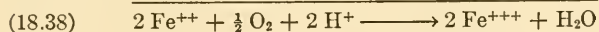
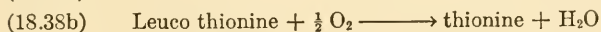
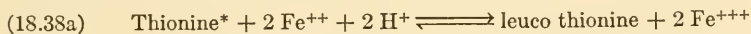

This is a particularly simple case of sensitized autoxidation.

According to equation (18.38), autoxidation by reversibly reducible dyes is due to the disturbance of the photostationary state by molecular oxygen, which removes the leuco dye. A similar disturbance can also be caused by the removal of the oxidized acceptor, *e. g.*, of the Fe⁺⁺⁺ ions. Weiss (1936) found, for instance, that, if reaction (18.38a) is carried out

in the absence of oxygen, in neutral (instead of acid) solution, Fe^{+++} ions form an insoluble hydroxide and the dyestuff is progressively bleached.

Can this mechanism also account for the sensitizing action of chlorophyll? Two observations argue against such an hypothesis: chlorophyll solutions are *not* bleached by reducing ions, *e. g.*, Fe^{++} or I^- , either reversibly or irreversibly (Rabinowitch and Weiss, unpublished); and the fluorescence of chlorophyll is *not* quenched by these ions.

However, the first result could possibly be explained by assuming that, in the case of chlorophyll, the back reaction in (18.39):

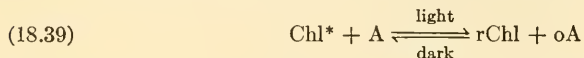

is so rapid that even the strongest illumination cannot appreciably disturb the equilibrium, and the concentration of the reaction products, $[\text{oA}]$, never becomes large enough to allow their removal (as by precipitation of Fe^{+++} , in the case of $\text{A} = \text{Fe}^{++}$).

The second result, the nonquenching of chlorophyll fluorescence by the substrates of photooxidation, also does not entirely preclude a mechanism of the Weiss-Fischgold type, since it can be attributed to a preliminary tautomerization (or a reversible reaction with the solvent), as described on pages 483–484, for example:

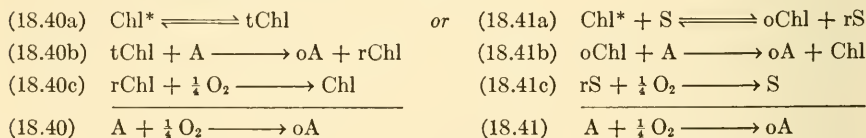

(As mentioned on page 484, contrary to the suggestion of Weiss and Weil-Malherbe, 1944, strong self-quenching cannot explain the absence of quenching by sensitization substrates, when the quantum yield of the sensitized reaction is close to 1.)

(e) Comparison of Mechanisms of Type A

In (18.33), (18.34), (18.40), and (18.41) we have formulated four alternative "type-A" mechanisms of chlorophyll-sensitized autoxidation, each of which could explain why the oxidation substrates do not quench chlorophyll fluorescence and why the photooxidation occurs with a high quantum yield even at low oxygen pressures. The only experimental results which can be used to test these formulas are Gaffron's data on the quantum yield of sensitized oxidation of allyl thiourea (Eq. 18.32). Apart from the $[\text{Chl}]$ term in the denominator, equation (18.32) is of the familiar "Stern-Volmer" type, indicating that activated chlorophyll has the alternative of either being deactivated by a monomolecular process, or reacting with acceptor A by a bimolecular process. Of the four mechanisms mentioned above, mechanism (18.40), in which tau-

toxic chlorophyll either is converted monomolecularly back into ordinary chlorophyll or oxidizes the acceptor by a bimolecular reaction, (18.40b), leads directly to such a dependence of the yield on $[A]$. The other mechanisms give more complicated kinetic equations. However, since the quantum yield must be zero in the absence of A, and cannot exceed unity at high values of A, all mechanisms must give "saturation curves" for the function, $\gamma = f[A]$; and the available experimental data are not exact enough to allow one to assert that the quantum yield curve follows *exactly* the simple Stern-Volmer formula. Thus, new, precise, photochemical experiments appear desirable.

None of our mechanisms explains the occurrence of a term proportional to $[Chl]$ in the denominator of (18.32). Additional hypotheses are required to account for it (as well as for the similar decline of the quantum yield of the chlorophyll-sensitized reaction between methyl red and phenylhydrazine, observed by Ghosh and Sen-Gupta at the higher concentrations of the sensitizer).

This decline could be caused, for example, by a polymerization of chlorophyll and consequent accelerated dissipation of energy. Another possibility is energy dissipation by collisions of excited and normal chlorophyll molecules, $Chl^* + Chl \rightarrow 2 Chl$. The occurrence of one or both of these processes is indicated by the self-quenching of chlorophyll fluorescence (Weiss and Weil-Malherbe 1944). Long-lived active molecules also may be deactivated by such collisions, *e. g.*, by dismutation, which produces the alternative:

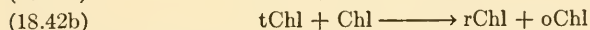
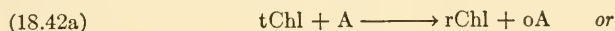

and can thus lead to a decline in the probability of the sensitized oxidation of A with increasing concentration of chlorophyll.

The mechanisms which envisage a *bimolecular* back reaction—*e. g.* (18.34) and (18.41)—can be shown (by the reasoning employed on page 489) to require a proportionality of the absolute yield with the *square root* of light intensity at the low values of $[A]$ (when γ is small and the stationary concentration of oChl is determined almost exclusively by reaction (18.41a); while, at the higher concentrations of the acceptor, when γ approaches unity (*i. e.*, when practically all oChl molecules react according to 18.41b), the absolute yield should become proportional to the first power of light intensity. Thus, the quantum yield should decrease with increasing light intensity at low values of $[A]$, and become independent of this intensity at high values of $[A]$. On the other hand, the mechanisms which imply a monomolecular deactivation, *e. g.*, (18.33) and (18.40), require that the quantum yield should be independent of light intensity at all concentrations of the acceptor. New experimental material would be required to apply these conclusions.

To sum up, we are at present unable to select a single mechanism for all autoxidations and oxidation-reductions sensitized by chlorophyll. One thing is clear: the mechanism of sensitization by chlorophyll is more complicated than that of the sensitization by reversibly reducible "vat dyes," and the assumption of a long-lived activation state cannot be avoided. A scheme of sensitized autoxidation based on long-lived active state, and kinetic equations derived from it, will be found on pages 546-547.

Not unconnected with the problem of long-lived activated states may be the experiments on the "photodynamic activity" of pre-irradiated dyestuff solutions (*e. g.*, fluorescein). Moore (1928), Blum (1930, 1932), Menke (1935), and others found that cytolytic and hemolytic effects can be obtained not only by illuminating the dyed tissue, but also by first illuminating the dyes and then introducing them into the tissues. Blum and Spealman (1934) found that these effects cannot be explained by the presence of hydrogen peroxide in illuminated dyestuff solutions (*cf.* page 78), and attributed them to some unknown decomposition products of the dye.

Quantitative investigations with different solvents and acceptors and with varying light intensities and wave lengths should bring clarity into the problem of the chlorophyll-sensitized reactions *in vitro*; and this may become an important step forward in the understanding of the role of chlorophyll in photosynthesis.

One prerequisite of such studies is that they be carried out with fresh, pure chlorophyll preparations, and not with crude extracts, so-called "pure" commercial products, or preparations which have been kept in storage for a considerable length of time. The oxidation-reduction properties of chlorophyll seem to be among the most sensitive characteristics of this altogether very sensitive compound, and may undergo rapid changes upon storage, not only in solution, but in the dry state as well.

4. Sensitization within a Complex (Type-B Mechanisms)

On pages 492 and 499, the possibility of a reversible association of chlorophyll with *oxygen* was discussed in connection with the mechanism of the bleaching of chlorophyll, and the conclusion reached was that this association is improbable. Obviously, if it would occur, the kinetics of chlorophyll-sensitized autoxidations would be largely changed (mechanisms $B\alpha 1$ or $B\beta 1$ taking the place of the mechanisms discussed before, which were based on the encounters of the molecules tChl, rChl, rS, or rA with free oxygen molecules).

Another possibility is an association of chlorophyll with the *acceptor A* (mechanisms $B\alpha 2$ and $B\beta 2$). Such an association could explain the absence of a concentration-dependent effect of the acceptor on the fluorescence of the sensitizer, in the same way as this fact can be explained by a reaction with the solvent or by tautomerization—namely, by making the sensitization, like fluorescence, formally a monomolecular reaction. The

complex, ChlA, can be expected to have an intrinsic capacity for fluorescence different from that of free chlorophyll; but there is no reason for the intensity of its fluorescence to change with an addition of *excess* A.

The hypothesis of complex formation with the acceptor includes the two possibilities, $B\alpha 2$ and $B\beta 2$, one based on energy transfer within the complex, and one assuming a chemical reaction between the two components of the complex. Franck and Wood (1936) considered the first possibility, with the specific suggestion that the transfer of the excitation energy from Chl to A leads to the dissociation (dehydrogenation) of A. This mechanism is similar to that suggested earlier by Franck and Levi (1934) for kinetic encounters, except that now a residue of the dissociated acceptor remains attached to the sensitizer, and in this way some of the dissociation energy may be compensated for by the affinity between the sensitizer and this residue, for example (instead of 18.36):

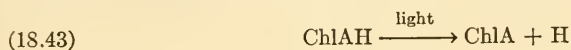

In (18.43), the acceptor is designated by AH and A is a radical whose affinity for chlorophyll is likely to be stronger than that of the saturated molecule, AH. In a complex, energy transfer and chemical reaction are very closely related phenomena. Equation (18.43), for example, envisages a chemical change not only in the "acceptor part," but also in the "sensitizer part" of the complex. One can make one more step and assume a true intermolecular oxidation-reduction reaction within the complex, as:

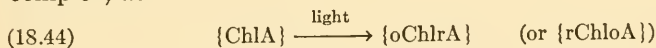

Mechanisms of this type are of particular interest in connection with the problem of photosynthesis, since there, the reaction substrates have often been assumed to be permanently associated with chlorophyll. We shall return to this problem in chapter 19.

D. PHOTOCHEMICAL PROPERTIES OF THE CAROTENOIDS AND PHYCOBILINS *

Not much is known about the photochemical decomposition of the *carotenoids*, although they are described as "light sensitive" (*cf.* Zechmeister 1934). One natural process of great importance is closely related to the photodecomposition of carotenoids: the bleaching of visual purple, which is the basis of vision in the retinal rods. Visual purple is a protein complex containing a derivative of vitamin A as its prosthetic group (*cf.* Wald 1942); the relationship between vitamin A and carotene was mentioned on page 471.

* Bibliography, page 525.

The elementary photochemical act of vision consists in the conversion of visual purple into a mixture of protein and the yellow carotenoid, retinene, and later into the colorless vitamin A. In a dark process, the visual purple is restored from these decomposition products, by direct reversal of the photochemical reaction in the case of retinene, and by a more complicated circular process in the case of vitamin A, according to the scheme:

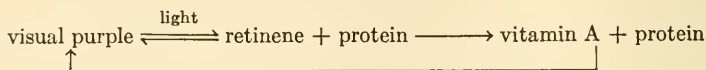

This cycle proves that carotenoids are capable of reversible photochemical reactions—a property which may serve them in good stead in their participation in photosynthesis. This participation, which has long been denied, was recently confirmed by comparative experiments on the yield of photosynthesis in the light absorbed by chlorophyll alone, and in the light absorbed by both chlorophyll and the carotenoids (*cf.* Vol. II, Chapter 30).

However, it is by no means certain that the participation of the carotenoids in the sensitization of photosynthesis is based on a reversible chemical reaction. The carotenoid-sensitized fluorescence of chlorophyll *in vivo* (*cf.* Vol. II, Chapter 24) shows that the electronic excitation energy of the carotenoids can be transferred to chlorophyll. (This phenomenon was quoted on page 515 as proof that the “bulk” transfer of electronic excitation energy is not improbable between two molecules with overlapping absorption bands.) It is feasible—indeed probable—that carotenoid-sensitized photosynthesis also is initiated by such a transfer of electronic excitation energy to chlorophyll.

Almost nothing is known about the sensitizing effect of carotenoids *in vitro*. Perhaps the belief in the rule that nonfluorescent dyes do not sensitize has prevented many investigators from even attempting to use these dyestuffs in sensitization experiments. In the one case, when carotene was tested for its sensitizing action, the result was positive: Karrer and Strauss (1938) found that colloidal carotene solutions sensitize the autoxidation of benzidine. Addition of gelatin or *d,l*-alanine enhanced the effect.

The *phycobilins* are described as “very sensitive to light and oxygen” (see, for instance, Schütt 1888). According to Lemberg (1930), the protein-free pigments are even less stable than the chromoproteids. (Free phycoerythrobilin is quickly oxidized to phycoerythrobilin by oxygen.) Nothing else is known about the photochemistry of these compounds or their sensitizing efficiency. Experiments indicate, however, that they can act as sensitizers in photosynthesis (*cf.* Vol. II, Chapter 30).

Bibliography to Chapter 18

Photochemistry of Pigments *in vitro*

A. The Primary Photochemical Process

- 1916 Jørgensen, I., and Kidd, F., *Proc. Roy. Soc. London B*, **89**, 342.
 1935 Kautsky, H., Hirsch, A., and Flesch, W., *Ber. deut. chem. Ges.*, **68**, 152.
 1936 Franck, J., and Wood, R. W., *J. Chem. Phys.*, **4**, 551.
 Shpolskij, E., and Sheremetev, G., *J. Phys. Chem. USSR*, **8**, 640.
 1937 Kautsky, H., *Biochem. Z.*, **291**, 271.
 Franck, J., and Herzfeld, K. F., *J. Phys. Chem.*, **41**, 97.
 Rabinowitch, E., and Weiss, J., *Proc. Roy. Soc. London A*, **162**, 251.
 Porret, D., and Rabinowitch, E., *Nature*, **140**, 321.
 1938 Weiss, J., *ibid.*, **141**, 248.
 1941 Franck, J., and Livingston, R., *J. Chem. Phys.*, **9**, 184.
 Livingston, R., *J. Phys. Chem.*, **45**, 1312.
 1944 Lewis, G. N., and Kasha, M., *J. Am. Chem. Soc.*, **66**, 2100.
 Weiss, J., and Weil-Malherbe, M., *J. Chem. Soc.*, **1944**, 544.

B. Photochemical Transformations of Chlorophyll

- 1788 Senebier, J., *Expériences sur l'action de la lumière solaire dans la végétation*. Barde, Manget, Genève, 1788.
 1864 Jodin, F. V., *Compt. rend.*, **59**, 857.
 Sachs, J., *Botan. Z.*, **22**, 353.
 1869 Timiriazev, C., *ibid.*, **27**, 885.
 1871 Lommel, E., *Ann. Physik*, **143**, 568.
 Gerland, E., *ibid.*, **143**, 585.
 1874 Chautard, J., *Compt. rend.*, **78**, 414.
 Wiesner, J., *Ann. Physik*, **152**, 496.
 Wiesner, J., *Sitzber. Akad. Wiss. Wien Math.-naturw. Klasse, Abt. I*, **59**, 327.
 1885 Reinke, J., *Botan. Z.*, **43**, 65, 81, 97, 113, 129.
 1909 Gebhard, K., *Z. angew. Chem.*, **22**, 2484.
 1910 Gebhard, K., *ibid.*, **23**, 820.
 Dangeard, P. A., *Compt. rend.*, **151**, 1386.
 1911 Usher, F. L., and Priestley, J. H., *Proc. Roy. Soc. London B*, **84**, 101.
 1914 Warner, C. H., *ibid.*, **87**, 378.
 Wager, H., *ibid.*, **87**, 386.
 1915 Ewart, A. J., *ibid.*, **89**, 1.
 1916 Jørgenson, I., and Kidd, F., *ibid.*, **89**, 342.
 1918 Willstätter, R., and Stoll, A., *Untersuchungen über die Assimilation der Kohlensäure*. Springer, Berlin, 1918.
 Osterhout, W. J. V., *Am. J. Botany*, **5**, 511.
 1920 Stern, K., *Ber. deut. botan. Ges.*, **38**, 28.
 1921 Stern, K., *Z. Botan.*, **13**, 193.
 Wurmser, R., *Arch. phys. biol.*, **1**, 3.
 1925 Kögel, G., and Steigmann, A., *Phot. Ind.*, **1925**, 138, 1141, 1169.
 Noack, K., *Z. Botan.*, **17**, 481.

- 1926 Noack, K., *Naturwissenschaften*, **14**, 385.
Kögel, G., *Phot. Korr.*, **62**, 9, 119.
- 1927 Lubimenko, V. N., *Rev. gén. botan.*, **39**, 619.
Baur, E., and Neuweiler, C., *Helv. Chim. Acta*, **10**, 901.
Noack, K., *Biochem. Z.*, **183**, 135.
- 1928 Mudrovčić, M., *Z. wiss. Phot.*, **26**, 171.
Windaus, A., and Borgeaud, P., *Ann. Chemie (Liebig)*, **460**, 235.
- 1929 Böhi, J., *Helv. Chim. Acta*, **12**, 121.
- 1931 Weber, K., *Z. physik. Chem.*, **B15**, 18.
- 1933 Gaffron, H., *Biochem. Z.*, **264**, 251.
- 1935 Albers, V. M., and Knorr, H. V., *Cold Spring Harbor Symposia Quant. Biol.*, **3**, 87.
Knorr, H. V., and Albers, V. M., *ibid.*, **3**, 98.
Meyer, K., *ibid.*, **3**, 341.
- 1936 Weber, K., *Ber. deut. chem. Ges.*, **69**, 1026.
- 1937 Baur, E., and Fricker, H., *Helv. Chim. Acta*, **20**, 391.
Rabinowitch, E., and Weiss, J., *Proc. Roy. Soc. London A*, **162**, 251.
Porret, D., and Rabinowitch, E., *Nature*, **140**, 321.
Kautsky, H., and Hormuth, R., *Biochem. Z.*, **291**, 285.
Vermeulen, D., Wassink, E. C., and Reman, G. H., *Enzymologia*, **4**, 254.
- 1938 Baur, E., Gloor, K., and Künzler, H., *Helv. Chim. Acta*, **21**, 1938.
- 1939 Katz, E., and Wassink, E. C., *Enzymologia*, **7**, 97.
- 1941 Smith, E. L., *J. Gen. Physiol.*, **24**, 565.
Livingston, R., *J. Phys. Chem.*, **45**, 1312.
Ferguson, F. F., and Webb, Jr., C. W., *Plant Physiol.*, **16**, 210.
- 1943 Aronoff, S., and Mackinney, G., *J. Am. Chem. Soc.*, **65**, 956.
Baur, E., and Niggli, F., *Helv. Chim. Acta*, **26**, 251, 994.

C. Chlorophyll as Sensitizer in Vitro

- 1874 Becquerel, E., *Compt. rend.*, **79**, 185.
- 1907 Tappeiner, H. v., and Jodlbaur, A., *Die sensibilisierende Wirkung fluoreszierender Substanzen*. F. C. W. Vogel, Leipzig, 1907.
- 1908 Hausmann, W., *Biochem. Z.*, **12**, 331.
Hausmann, W., and Kolmer, W., *ibid.*, **15**, 12.
- 1909 Hausmann, W., *ibid.*, **16**, 294.
Hausmann, W., *Jahrb. wiss. Botan.*, **46**, 599.
Hausmann, W., and Portheim, L. v., *Biochem. Z.*, **21**, 51.
- 1914 Gieckhorn, J., *Sitzber. Akad. Wiss. Wien Math.-naturw. Klasse, Abt. I*, **123**, 1221.
- 1922 Eisler, M., and v. Portheim, L., *Biochem. Z.*, **130**, 497.
- 1925 Noack, K., *Z. Botan.*, **17**, 481.
- 1926 Noack, K., *Naturwissenschaften*, **14**, 385.
Gaffron, H., *Biochem. Z.*, **179**, 157.
- 1927 Noack, K., *ibid.*, **183**, 153.
Gaffron, H., *Ber. deut. chem. Ges.*, **60**, 755.
Gaffron, H., *ibid.*, **60**, 2229.

- 1928 Windaus, A., and Bruncken, J., *Ann. Chemie (Liebig)*, **460**, 225.
 Moore, A. R., *Arch. sci. biol.*, **12**, 231.
 Windaus, A., and Borgeaud, P., *Ann. Chemie (Liebig)*, **460**, 235.
- 1929 Böhi, J., *Helv. Chim. Acta*, **12**, 121.
- 1930 Allison, F., *ibid.*, **13**, 788.
 Blum, H. F., *Biol. Bull.*, **58**, 224; **59**, 81.
- 1932 Blum, H. F., *Physiol. Revs.*, **12**, 23.
- 1933 Gaffron, H., *Biochem. Z.*, **264**, 251.
 Meyer, K., *J. Biol. Chem.*, **103**, 39.
 Meyer, K., *ibid.*, **103**, 597.
 Meyer, K., *ibid.*, **103**, 607.
- 1934 Franck, J., and Levi, H., *Z. physik. Chem.*, **B27**, 409.
 Ghosh, J. C., and Sen-Gupta, S. B., *J. Indian Chem. Soc.*, **11**, 65.
 Blum, H. F., and Spealman, C. R., *Proc. Soc. Exptl. Biol. Med.*, **31**, 1007.
 Holst, G., *Z. physik. Chem.*, **A169**, 1.
- 1935 Meyer, K., *Cold Spring Harbor Symposia Quant. Biol.*, **3**, 341.
 Menke, J. F., *Biol. Bull.*, **68**, 360.
 Weiss, J., *Naturwissenschaften*, **23**, 609.
 Kautsky, H., Hirsch, A., and Flesch, W., *Ber. deut. chem. Ges.*, **68**, 152.
 Gaffron, H., *ibid.*, **68**, 1409.
- 1936 Holst, G., *Z. physik. Chem.*, **A175**, 99.
 Franck, J., and Wood, R. W., *J. Chem. Phys.*, **4**, 551.
 Kautsky, H., and Flesch, W., *Biochem. Z.*, **284**, 412.
 Weiss, J., *Trans. Faraday Soc.*, **32**, 1331.
 Weiss, J., *Nature*, **136**, 794.
 Weiss, J., and Fischgold, H., *Z. physik. Chem.*, **B32**, 135.
 Gaffron, H., *Biochem. Z.*, **287**, 130.
- 1937 Holst, G., *Z. physik. Chem.*, **A178**, 282.
 Gaffron, H., *ibid.*, **B37**, 437.
 Spealman, C. R., and Blum, H. F., *Univ. Calif. Pub. Physiol.*, **8**.
 Kautsky, H., *Biochem. Z.*, **291**, 271.
 Rabinowitch, E., and Weiss, J., *Proc. Roy. Soc. London A*, **162**, 251.
- 1940 French, C. S., *J. Gen. Physiol.*, **23**, 469.
- 1941 Franck, J., and Livingston, R., *J. Chem. Phys.*, **9**, 184.
 Livingston, R., *J. Phys. Chem.*, **45**, 1312.
- 1944 Weiss, J., and Weil-Malherbe, H., *J. Chem. Soc.*, **1944**, 544.

D. Photochemistry of Carotenoids and Phycobilins

- 1888 Schütt, F., *Ber. deut. botan. Ges.*, **6**, 36, 305.
- 1930 Lemberg, R., *Ann. Chemie (Liebig)*, **477**, 105.
 Lemberg, R., *Biochem. Z.*, **219**, 255.
- 1934 Zechmeister, L., *Carotinoide*. Springer, Berlin, 1934.
- 1938 Karrer, P., and Strauss, W., *Helv. Chim. Acta*, **21**, 1624.
- 1942 Wald, G., *Biol. Symposia*, **7**, 43.

CHAPTER 19

PHOTOCHEMISTRY OF PIGMENTS *IN VIVO*

A. PHOTAUTOXIDATIONS *in vivo**

1. Photosynthesis, Photoautoxidation, and Photorespiration

In chapter 18, we found that most reactions sensitized by chlorophyll *in vitro* are *autoxidations*, and that only a few chlorophyll-sensitized *oxidation-reductions* have been studied. The most important reaction sensitized by chlorophyll *in vivo*—photosynthesis—is an oxidation-reduction; but chlorophyll in the cell can sensitize *autoxidations* as well. Their substrates are either cellular reserve materials, or externally supplied oxidizable compounds.

The maximum rate of chlorophyll-sensitized photoautoxidation *in vivo* is a whole order of magnitude lower than that of photosynthesis in strong light. It is therefore difficult to say whether a slow photoautoxidation may not sometimes take place simultaneously with photosynthesis even while the latter proceeds at its normal steady rate. Whenever an attempt is made to enhance photooxidation (*e. g.*, by an increase in the partial pressure of oxygen), it soon causes a partial or complete *inhibition* of photosynthesis.

There are thus two methods of studying the photoautoxidation *in vivo*, unhampered by photosynthesis. One is to inhibit photosynthesis beforehand, *e. g.*, by narcotization or by the removal of all carbon dioxide from the medium; the other is to stimulate autoxidation (*e. g.*, by increasing the concentration of oxygen or by stepping up the intensity of illumination), until photosynthesis is inhibited “autocatalytically” (probably by photooxidative deactivation of some of its enzymes). In both cases, oxygen liberation in light yields place to oxygen consumption, whose maximum rate is three or four times higher than the rate of respiration in the dark. This oxygen consumption may proceed at a steady rate for several hours, without causing damage to the plant. After this, photooxidation slows down—obviously in consequence of exhaustion of cellular oxidation substrates—and, at the same time, a bleaching of the pigments becomes apparent. Thus, contrary to the earlier views of Noack (1925, 1926), the pigments are not the first sub-

* Bibliography, page 558.

strates to suffer photoxidation in plants whose photosynthesis has been inhibited; rather, they remain intact as long as other oxidizable materials are available to the cells.

Van der Paauw (1932) had noticed that, subsequent to a period of photoxidation in CO₂-starved cells, oxygen consumption *in the dark* also was stronger than before the exposure. To explain this, he suggested that photoxidation of cellular reserve materials is simply *light-stimulated respiration*, and that stimulation persists for some time after the illumination has ceased.

However, in all probability, photautoxidation and light-stimulated respiration are two independent phenomena. Photautoxidation is a chlorophyll-sensitized photochemical process; it takes place only in the chloroplasts, and its mechanism may bear a close relationship to photosynthesis. "Light-stimulated respiration," on the other hand, often is merely ordinary respiration enhanced by the accumulation of "photosynthates" (*e. g.*, sugars), that is, a nonphotochemical process, which may occur everywhere in the cell. True, some evidence has been found also of a direct stimulation of respiration by light ("photorespiration"); but the active rays seemed in this case to be those absorbed by the *carotenoids* rather than by chlorophyll (*cf.* page 569).

"Photorespiration" phenomena will be discussed later (Chapter 20). That the phenomena which we will describe now are different from photorespiration is shown: *first*, by their occurrence in red light (which indicates sensitization by chlorophyll); *second*, by the much higher partial pressure of oxygen required for their "saturation" (*cf.* Figs. 58 and 59); and *third*, by their occurrence in leaves killed by boiling (which proves their independence from the heat-sensitive enzymatic apparatus of respiration).

One could argue that the last observation indicates that photoxidation *in vivo* bears no relation to photosynthesis either, since the latter process also depends on heat-sensitive enzymes. Gaffron (1939^{1,2}) and Franck and French (1941) suggested, in fact, that chlorophyll-sensitized photoxidations *in vivo* are analogous to similar reactions in chlorophyll *solutions*, rather than to any enzymatic life processes. However, the different influence of oxygen concentration on sensitized photoxidations *in vivo* and *in vitro* (*cf.* page 531) shows that the mechanisms of these processes are different. We suggest, as a working hypothesis, that the *primary photochemical process* of photautoxidation *in vivo* is identical with the primary photochemical process of photosynthesis, but that it is coupled with secondary reactions catalyzed by heat-resistant catalysts (*e. g.*, complex iron compounds, as contemplated by Noack in 1925); while, in photosynthesis, the same primary process is associated with secondary reactions catalyzed by true, heat-sensitive enzymes. This relationship

between chlorophyll-sensitized photautoxidation *in vivo* and photosynthesis will be discussed in more detail on pages 543 *et seq.*

2. Photautoxidation in Narcotized or Starved Plants

Fromageot found, in 1924, that in the presence of 50% or more *glycerol* aquatic plants change from oxygen production to oxygen consumption in light, the rate of which may be three or four times higher than that of respiration in the dark. At approximately the same time, Noack (1925, 1926), while studying the chlorophyll-sensitized benzidine oxidation *in vitro*, found that this reaction also can be sensitized by *living leaves*.

In Noack's experiments, leaves were soaked in aqueous benzidine solution and illuminated for four hours. After this the chloroplasts appeared brown. The brown pigment was extracted and proved to be an oxidation product of benzidine, while the chlorophyll appeared intact and its quantity undiminished. Benzidine oxidation could be observed also in *boiled* green leaves, but *not* in white parts of variegated leaves, or in leaves whose chlorophyll was converted into copper pheophytin by treatment with copper sulfate.

Hardly any experiments on the *photautoxidation of external substrates* by living plants have been carried out since Noack's work on benzidine, although the oxygen consumption of cells undergoing *internal* photoxidation has often been found stimulated by the addition of glucose or other organic nutrients. Whether these compounds served as direct substrates of autoxidation, or were first converted into metabolites, is unknown. Observations on the *photautoxidation of cellular material*, although more numerous, have usually been confined to the measurement of oxygen consumption, thus leaving the nature of the oxidation substrates unknown.

In these experiments, *carbon dioxide starvation* rather than narcotization, has been used as the means to suppress photosynthesis. Noack (1925, 1926) thought that carbon dioxide removal is less efficient than urethan poisoning in promoting photoxidation (because carbon dioxide production by respiration does not allow one to reduce photosynthesis much below the "compensation point," where the net gas exchange is zero.) However, van der Paauw (1932) found that, when *Hormidium* filaments were exposed to light in an atmosphere which was kept free from carbon dioxide by contact with alkali, oxygen evolution yielded place to oxygen consumption, at a rate which was considerably larger than that of ordinary respiration. In similar, but more detailed experiments by Franck and French (1941), leaves of *Hydrangea* were mounted on a wire gauze rotor a few millimeters above a 10% potassium hydroxide solution, which was stirred by threads suspended from the rotor (Fig. 57). The evolution (or absorption) of oxygen was measured manometrically, in darkness and in the concentrated light of a 1000-watt lamp.

As found by Noack, some carbon dioxide liberated by respiration (and photooxidation) was reduced by the leaves before it reached the alkali. Franck and French determined this residual photosynthesis by experiments in nitrogen containing only 1.5% oxygen, which is sufficient to saturate the respiratory apparatus but not enough to cause measurable photooxidation (*cf.* Figs. 58 and 59). The net rate of oxygen consumption, determined under the higher partial pressures of oxygen, was then corrected by adding the rate of residual photosynthesis and subtracting the rate of dark respiration. (This presupposes that photosynthesis was not affected by photooxidation, although the latter may have produced more carbon dioxide than did respiration.)

Photoautoxidation proceeded for a while at a constant rate, until it slowed down for lack of substrates; before stopping altogether it attacked

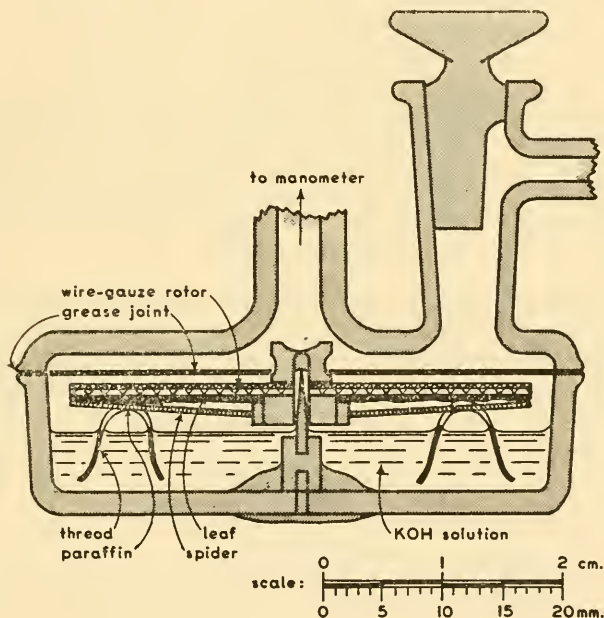

FIG. 57.—Apparatus for the study of photooxidation in carbon dioxide-deprived leaves (after Franck and French 1941). The leaf is mounted on a rotor; its lower surface, which contains the stomata, is just above a potassium hydroxide solution. The vessel is joined to a manometer for the measurement of oxygen consumption.

the pigments and other vital constituents of the cell. This "light injury" can be postponed by providing an external supply of oxidation substrates: in leaves whose stems dipped into a glucose solution, the rate of photoautoxidation was both higher and steadier than without glucose. Similar results were obtained by Mevius (1936), who left CO_2 -starved leaves on the stem and allowed other leaves to photosynthesize in the normal way and supply the photooxidizing leaves with sugars by translocation.

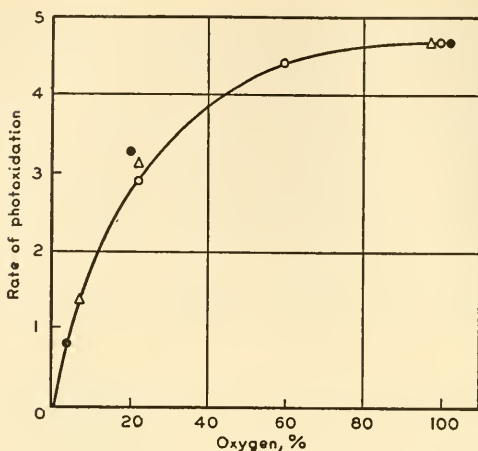

FIG. 58.—Rate of photooxidation as a function of oxygen pressure (after Franck and French 1941). O, oxygen consumption in CO_2 -starved live *Hydrangea* leaves (after Franck and French); Δ , decline of oxygen liberation of live *Chlorella* cells caused by excess oxygen (after Warburg); ●, oxygen consumption by horse serum in light, sensitized by adsorbed porphyrin (after Gaffron). All three processes require a high oxygen pressure to reach a full rate of photooxidation.

Figure 58 shows oxygen consumption in the steady period of photoautoxidation as a function of oxygen pressure, while figure 59 represents a similar plot for respiration. The latter indicates saturation at less than 1% of oxygen in the atmosphere, whereas photooxidation requires over 50%.

(This fact was quoted above as a proof that photooxidation

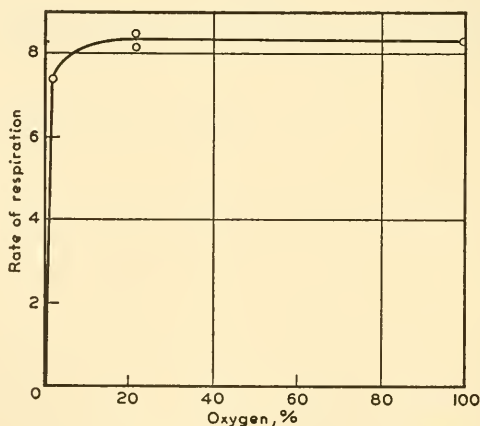

FIG. 59.—Rate of respiration as a function of oxygen pressure (after Franck and French 1941). Saturation is reached at a very low oxygen pressure.

cannot be attributed to a stimulation of the respiratory apparatus.) Figure 58 shows that a high oxygen pressure also is required for photoautoxidation *in vitro*, if it is sensitized by *dyestuff-protein complexes* (but not by free dyestuff molecules, *cf.* page 513), as well as for the oxygen inhibition of photosynthesis, according to Warburg (1919). An interpretation of these relationships will be attempted on pages 544-548.

Some preliminary results were obtained by Franck and French in the study of the dependence of photoautoxidation on *light intensity*. Photoxidation continued to increase in the range $> 30,000$ lux, where the photosynthesis of *Hydrangea* is saturated with light. Franck and French showed (by comparing the rate of oxygen consumption in continuous light with that in periodically interrupted light of the same average intensity) that the oxygen consumption increased more slowly than proportional to light intensity. Red and blue light were found to be equally efficient in photoautoxidation, thus proving that it is brought about by chlorophyll, and not (or not exclusively) by the yellow leaf pigments.

3. Photoautoxidation in the Presence of Excess Oxygen and in Intense Light

It was stated above that photoxidation can suppress photosynthesis "autocatalytically," and thus make carbon dioxide starvation or the use of poisons superfluous. The required stimulation of photoautoxidation can be achieved either by an increase in oxygen pressure or by a step-up in the intensity of illumination.

The inhibition of photosynthesis by excess oxygen was described in chapter 13, which dealt with various chemical inhibitors. It was discovered by Warburg in 1919. As shown by figure 32 (page 328), Warburg found in *Chlorella* a 30% decrease in photosynthesis when the oxygen pressure was increased from 15 to 760 mm. McAlister and Myers (1940) found that, in the presence of 0.03% carbon dioxide and at high light intensities (over 10,000 lux), the photosynthesis of *wheat* was decreased by 20 or 30% when the oxygen content was increased from 0.5 to 20%. Wassink, Vermeulen, Reman, and Katz (1938), on the other hand, found no difference between the rates of oxygen liberation by *Chlorella* at 0% and 20% oxygen (*cf.* Fig. 33), but observed a strong inhibition in pure oxygen, amounting to 20% in comparatively weak light (4000 ergs/cm.²/sec., yellow sodium light), and as much as 50% in strong light (14,500 ergs/cm.²/sec.). *Qualitatively*, the inhibition of photosynthesis by oxygen shows the same dependence on oxygen concentration as does photoautoxidation *in vivo* (*cf.* Fig. 58), but the loss in oxygen production is ten or more times larger than the oxygen consumption by photoautoxidation (as observed by Franck and French at

the same oxygen concentration but in the absence of carbon dioxide). It is thus impossible to account for the decline in photosynthesis by assuming that the observed gas exchange is the balance of unchanged photosynthesis and added photautoxidation. Rather, we have to postulate with Franck and French (1941) that *photoxidation inactivates the catalytic mechanism of photosynthesis*.

An effect similar to that of *excess oxygen* is caused by *excess light*. The dependence of photosynthesis on light intensity will be the subject of chapter 28 in volume II. The rate increases up to a certain light intensity—which for plants adapted to direct sunlight is of the order of 50,000 lux—and then becomes constant, apparently because one of the enzymes taking part in photosynthesis has a limited capacity and can provide (or utilize) only a certain quantity of intermediates, required for (or supplied by) the primary photochemical process. Photautoxidation has no such limitations, and its rate continues to grow long after photosynthesis has become “saturated” with light. This explains the phenomena known as *solarization* (dissolution of starch deposits in leaves in intense light, *cf.* Ursprung 1917), *light inhibition* and *light injury*—which have been known long before their relation to photoxidation became clear.

The ease with which reversible light inhibition and irreversible light injury can be produced in different plants, depends on their (ontogenetic or phylogenetic) light adaptation. This may be one of the reasons for discrepancies between the findings of different observers. When Reinke discovered the light saturation of photosynthesis in 1883, he did not notice any decline in the rate of photosynthesis of aquatic plants until the light intensity was increased to 20 or 50 times that of direct sunlight (that is, to one or two million lux!). Ewart (1896), on the other hand, discovered the inhibition of photosynthesis by excess light by exposing the water plant *Elodea* to direct sunlight. Later, (1897), Ewart observed that the photosynthesis of tropical plants is not inhibited by direct sunlight; still later (1898), he stated that inhibition can be produced in *all* plants by the use of concentrated sunlight. Light inhibition was again observed by Pantanelli in 1903; but the reality of this phenomenon (which had no place in Blackman's theory of “limiting factors”) was doubted by Blackman and Smith (1911), who admitted only the occurrence of light injury in concentrated sunlight, which they ascribed to overheating. Gessner (1938) found no inhibition in prolonged experiments with aquatic plants (*Elodea* and others) in light of 100,000–130,000 lux, even if the near ultraviolet intensity was artificially enhanced by means of a mercury arc in glass. Johansson (1923, 1929) explained the light inhibition by the closure of stomata in strong light (*cf.* the theories of the “midday depression” in volume II, chapter 26), while Emerson (1935) concluded, on the basis of experiments with *Chlorella* in light up to 45,000 lux, that light inhibition occurs only if the supply of carbon dioxide is inadequate (thus creating local starvation, with consequences similar to those described on pages 528–531 of this chapter).

Although incidental factors, such as overheating, closure of stomata, or inadequate supply of carbon dioxide, may play an important role in some cases of light inhibition and light injury, it seems certain that these phenomena can occur also when all such factors are eliminated.

They have been observed for example, in stomata-free ferns (Montfort and Neydel 1928; Föckler 1938), in algae (Montfort 1930, 1933); and in *Chlorella* cells suspended in solutions which provided an ample supply of carbon dioxide (Myers and Burr 1940).

Light inhibition can most easily be obtained in land plants and algae adapted to weak light. Weis (1903), Lubimenko (1905, 1907, 1908^{1,2}, 1928^{1,2}), and Harder (1930, 1933), among others, have found that the "light curves" (rate of photosynthesis plotted *versus* light intensity) of typical "shade plants" reach a maximum in relatively moderate light (*e. g.*, 10,000 lux or less) and then decline again. Montfort (1929, 1933^{1,2}) observed a similar behavior of brown and red algae collected deep under the sea (*cf.* Vol. II, Chapter 28).

The light curves of shade plants and sun plants will be discussed in more detail in volume II, chapter 28. While the ascending parts of these curves are independent of the duration of illumination, the parts corresponding to saturating light intensities, often are time-dependent. In "shade plants," a decline in the rate of photosynthesis at high light intensities cannot be avoided even in rapid experiments; if the illumination is extended, a complete inhibition may ensue and the plants may suffer an irreversible light injury, or even death by "sunstroke." In typical "sun plants," on the other hand, a rapid determination may lead to light curves with a completely flat "saturation plateau," extending far beyond the saturating light intensity; however, a sufficiently prolonged and intense illumination is bound to produce a gradual inhibition in these plants as well.

Föckler (1938) observed that, after one hour of exposure to direct sunlight, the photosynthesis of the fern *Trichomanes radicans* gave place to oxygen uptake. The longer the exposure, the slower and less complete was the recovery in moderate or weak light. Similarly, Stålfelt (1939) found that, in lichens, ten hours of illumination with 16,000 lux caused a 26% decrease in the rate of photosynthesis, and 14 hours in darkness were required for recovery.

The most extensive study of the effect of strong light on photosynthesis was carried out by Myers and Burr (1940) with the unicellular green algae (*Chlorella pyrenoidosa*, *C. vulgaris*, and *Protococcus*). They used collimated light from a tungsten lamp, giving intensities up to 39,000 foot-candles (*i. e.*, about 360,000 lux), and obtained families of curves showing changes in the rate of photosynthesis as a function of both intensity and duration of illumination. The use of thin suspensions (giving a total light absorption of only 10%) ensured a nearly uniform illumination of all cells. (This might explain why the effects observed by Myers and Burr were so much stronger than those described by Emerson.)

Figure 60 shows "time curves" corresponding to different light intensities. At 1000 f.-c., the rate is constant, that is, no inhibition occurs after 30 minutes of illumination. At 4000 f.-c., the initial rate is higher than at 1000 f.-c., but inhibition sets in after about 20 minutes, causing a gradual reduction of photosynthesis to a final rate which is lower than that at 1000 f.-c. At 6100 f.-c., the initial rate is about the

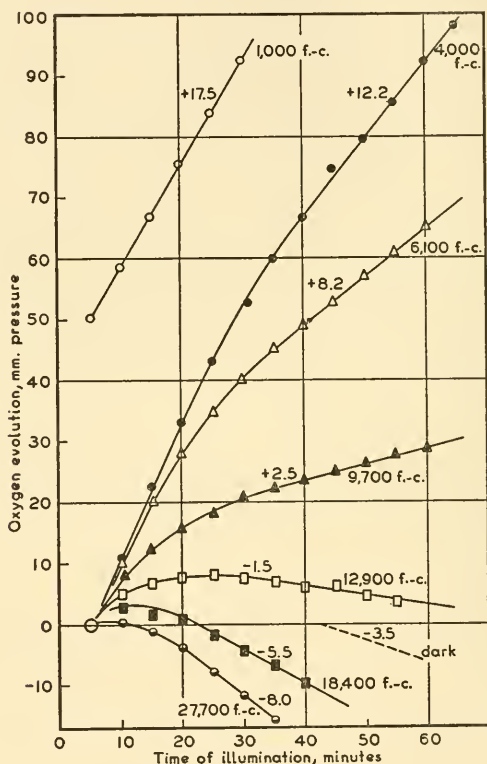

FIG. 60.—Inhibition of oxygen liberation in *Chlorella* by intense light (after Myers and Burr 1940). Light intensities are in foot-candles. Numbers above the curves are rates of pressure change (in mm. per 10 min.).

same as at 4000 f.-c. (showing that light-saturation has been reached) but the inhibition is more rapid and more severe. At 12,900 f.-c., after about 20 minutes, evolution of oxygen is replaced by its consumption; at 18,400 f.-c., the oxygen consumption in light exceeds that in the dark, that is, not only is photosynthesis completely suppressed, but photautoxidation is added to normal respiration. At 27,700 f.-c., the total oxygen absorption is 2.5 times larger than that caused by respiration alone, and the decline in pressure sets in almost immediately upon the start of

illumination. As long as oxygen consumption in light proceeds at a constant rate, the cells suffer no irreversible injury. However, after about two hours (at 38,000 f.-c.), the rate of photooxidation begins to decrease; and the cells show the first signs of bleaching.

Similar observations were made by Föckler (1938) on *Trichomanes radicans*: at the end of the first hour of intense illumination the oxygen consumption was equal to twice the normal respiration; it increased to four times normal respiration after four hours, and declined afterwards.

As in the case of inhibition by excess oxygen, the decline in photosynthesis caused by excessive illumination is many times stronger than could be explained by a mere *superposition* of photautoxidation upon normal photosynthesis. We are again led to the assumption that photautoxidation *inhibits* photosynthesis—a conclusion which was also reached by Föckler (1938) and Myers and Burr (1940). Besides the *magnitude* of the effect, Myers and Burr pointed to its gradual *onset* (contrasted with the immediate beginning of photooxidation in the experiments of Franck and French) as a proof of the inhibition hypothesis. The first 20 to 30 minutes of illumination (*cf.* Fig. 60), during which the slope decreases slowly to a constant final value, can be considered as the period of inactivation of the photosynthetic apparatus.

Similarly to the photautoxidation in CO₂-starved leaves, photautoxidation in strong light is not a steady-state phenomenon, but involves a progressive consumption of cellular reserve materials. Perhaps provision of an organic oxidation substrate (*e. g.*, glucose) could prevent irreversible injury and permit the study of photooxidation in strong light under steady conditions; but no experiments of this kind have yet been made. However, a *temporary* steady state was reached in the central parts of the time curves of Myers and Burr, where photautoxidation proceeded for a while at a constant rate. Their slopes could be used for the analysis of the dependence of photautoxidation on light intensity and other factors.

In figure 61, the rates of oxygen exchange in these periods of steady photooxidation are plotted against light intensity. The shape of the resulting "light curves" depends on the previous history of the cells. Curve *A*, obtained with a suspension grown in strong light and ample supply of carbon dioxide (5%), shows a broad "saturation plateau," while curve *B*, obtained for a suspension grown in the same light but in ordinary air, shows a sharp maximum in the region of 3,000 f.-c. immediately followed by a decline. The difference is similar to that between "sun plants" and "shade plants" according to Weis and Lubimenko (which we have mentioned above). Curves similar to curve *B* were also obtained by Myers and Burr with cells grown in darkness

(with glucose as a source of organic matter). All curves, regardless of the treatment of the algae, approached the same maximum rate of oxygen uptake in very strong light, a rate equivalent to between two and four times the dark respiration. This final rate was not affected by variations in carbon dioxide supply. The addition of cyanide (0.01 mole per liter) which inhibited photosynthesis practically completely and caused the oxygen consumption to begin its increase at light intensities as low as 1,000 f.-c., also left the final rate of autoxidation in strong light (20,000 f.-c.) unaffected.

It was mentioned in chapter 13 (page 329) that Franck and French (1941) attributed the inactivation of photosynthesis by excess oxygen to

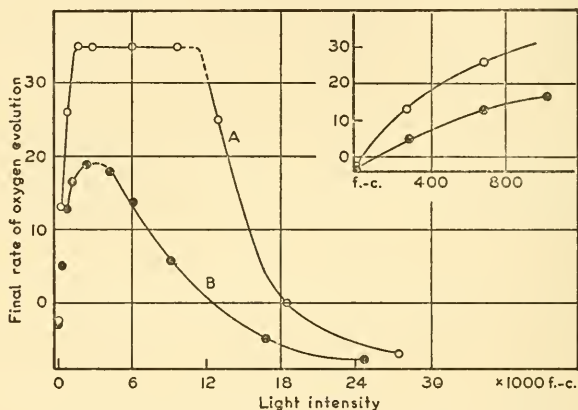

FIG. 61.—Oxygen liberation by *Chlorella* as a function of light intensity in very strong light (after Myers and Burr 1940). A, Cells grown in 5% CO₂ and 450 f.-c.; B, cells grown in air (0.03% CO₂) and 450 f.-c.

a photoxidation of the “carboxylase,” E_A , which supplies the photosynthetic mechanism with the carbon dioxide-acceptor complex, $\{CO_2\}$. The same explanation can be suggested also for the inactivation by intense light. Whenever enzyme E_A is inactivated, the concentration of the normal oxidant in the primary photochemical process becomes depleted, and oxygen is given a chance to act as a “substitute oxidant.”

We have all reason to assume that the inhibition by excess light is essentially the same phenomenon as inhibition by excess oxygen, narcotization, or carbon dioxide starvation. However, it would be important to prove that this type of inhibition, too, is chlorophyll-sensitized and therefore equally strong in red and blue light. Montfort (1941) asserted that the “sunstroke” which marine algae suffer in intense light is caused only by the short-wave part of the spectrum.

4. The Photoxidation of Chlorophyll *in vivo*

It was stated in chapter 18, that chlorophyll is more photostable *in vivo* than *in vitro*. However, chlorophyll in living cells can, too, be bleached by very intense and prolonged illumination, as observed, among others, by Reinke in 1885. This bleaching can be attributed to photoxidation. Pringsheim noticed (1881, 1882) that the leaves do not bleach in the absence of oxygen (*e. g.*, in a carbon dioxide atmosphere). Similarly, Funk (1939, 1940) found that dry leaves do not bleach unless air is present in the intercellular spaces. How the photoxidation of cellular reserve substances goes over, upon the exhaustion of these substrates, into photoxidation of the pigments was described above.

The relative light stability of chlorophyll *in vivo* extends into the *ultraviolet*, as described, for instance, by Gilles (1939). According to Arnold (1933), the inhibition of photosynthesis by ultraviolet light (253.6 m μ) is not accompanied by a destruction of chlorophyll (*cf.* Chapter 13, page 346). Montfort (1941, 1942) found that the bleaching of algae in intense light is caused mainly by violet and ultraviolet radiations.

Richter (1932, 1935) observed the bleaching of chlorophyll *in vivo* by very intense ultraviolet light (< 300 m μ). He found two effects: a *direct* destruction, which requires exposures of several minutes; and an indirect *delayed* decomposition, which can be induced by an exposure of only 10 or 20 seconds. The latter effect, which Richter attributed to the activation of an enzyme, could be observed (in leaves of *Tropaeolum majus*) only when the leaves were illuminated from the underside.

According to page 507 *et seq.*, the stability of chlorophyll to light and air in living cells may have a twofold source: it may be due either to a *static protection*—for instance, to an association with proteins or lipides— or to a *functional inhibition* (chemical protection), which diverts the energy absorbed by chlorophyll to other reactions and prevents it from being used for self-oxidation.

The protective effect of proteins (and lipides) on chlorophyll is well known from experiments with chlorophyll colloids; it accounts for the continued—although reduced—stability of chlorophyll in “chloroplastin” preparations obtained by the grinding of leaves under water. The role of chemical inhibition in the stability of chlorophyll *in vivo* is shown by the fact that bleaching is accelerated by all factors which inhibit photosynthesis, *e. g.*, excess oxygen, carbon dioxide starvation, and poisons, although the association of chlorophyll with proteins and lipides is not likely to be disturbed by these treatments. To the absence of this inhibition we may attribute the fact that “chloroplastin” suspensions or other colloidal complexes *in vitro*, are not quite as photostable as is chlorophyll *in vivo*.

The photooxidation of chlorophyll in plants in which photosynthesis has been inhibited by poisoning or carbon dioxide starvation was first studied by Noack (1925, 1926), who used the water moss, *Fontinalis antipyretica*. After 48 hours of illumination of *Fontinalis* in CO₂-free water, the leaves showed a partial bleaching. More effective was the suppression of photosynthesis by poisoning, *e. g.*, by phenylurethan or sulfur dioxide. The bleaching of poisoned chloroplasts set in, not immediately after the addition of the poison, but several hours later (according to page 526, the explanation of this delay must be sought in the preliminary photooxidation of other cellular materials). Once started, the bleaching persisted even after the removal of the poison, particularly in the case of sulfur dioxide. Noack (1926²) suggested that photooxidation of chlorophyll under the influence of sulfur dioxide explains the destruction of vegetation by industrial smoke gases. Continuing Noack's experiments, Wehner (1928) observed the bleaching of leaves in which the photosynthetic apparatus was poisoned by nitrous gases (fuming nitric acid).

The chemistry and kinetics of chlorophyll bleaching *in vivo* are as yet almost unknown. Noack (1925, 1926) measured the rate of oxygen uptake by killed *Fontinalis* shoots in light, and found a linear increase in the rate with an increase in [O₂], up to 2% oxygen in the air. Preliminary extraction of lipides with petroleum ether did not change the rate of bleaching and of oxygen absorption (Noack considered this as a sign that the stability of chlorophyll in the chloroplasts is not due to an association with lipides). Treatment with copper salts (leading to a substitution of copper for magnesium), slightly increased the rate of oxygen uptake. (This experiment was made because Noack thought that copper-pheophytin, which does not fluoresce and is not efficient as a sensitizer, should also be less subject to photochemical self-oxidation.)

B. SENSITIZED OXIDATION-REDUCTIONS *in vivo* *

The replacement of water by hydrogen sulfide, hydrogen, or organic compounds as hydrogen *donors* in algal and bacterial photosynthesis was discussed in chapters 5 and 6. Sensitized photooxidations, described on pages 526-537 of this chapter, can be attributed to a *substitution of oxygen for carbon dioxide as hydrogen acceptor* in the photochemical reaction (*cf.* page 536). We shall now describe attempts to induce plants to use other (inorganic or organic) substitute acceptors.

1. Chlorophyll-Sensitized Reduction of Nitrate

Green plants are generally capable of assimilating *nitrogen* in the form of nitrates, in the dark, reducing them to derivatives of ammonia,

* Bibliography, page 559.

e. g. amino acids and proteins. The reductants in this reaction are organic cell constituents, *e. g.*, carbohydrates. The process is similar to respiration, with nitrate substituted for oxygen:



Warburg and Negelein (1920) found that, in green algae (*e. g.*, *Chlorella pyrenoidosa*), the reduction of nitrate is accelerated by illumination. These experiments were carried out in a mixture of nitric acid (0.01 mole per liter) and nitrate (0.1 mole per liter) to obtain a considerable concentration of *neutral molecules* HNO_3 , which penetrate through the cell membranes much more easily than do the nitrate *ions*.

Brought into such a solution, *Chlorella* cells produced *in the dark*, 70% more carbon dioxide than they consumed oxygen, thus indicating the superposition of "nitrate respiration" (19.1) on the ordinary, or "oxygen respiration" of carbohydrates. The evolution of ammonia was, at first, less than equivalent to that of carbon dioxide, but approached equivalency after several hours, indicating an initial amination of cellular materials. (Cells starved of nitrogen develop no free ammonia at all in the first few hours of nitrate assimilation.) The nitrate reduction by *Chlorella* in the dark was exceptionally sensitive to cyanide—for example, a 20% reduction in rate was brought about by less than 10^{-6} mole per liter of HCN (as against 10^{-5} for normal photosynthesis and 10^{-2} for respiration of the same algae). On the other hand, nitrate reduction was *less* sensitive than photosynthesis to urethan poisoning—*e. g.*, 0.013% (= 0.8×10^{-3} mole per liter) phenylurethan reduced photosynthesis almost to zero, but decreased nitrate reduction by not more than 30%. The nitrate reduction required the presence of oxygen; under anaerobic conditions, *nitrite* appeared as a reduction product (in addition to ammonia) and acted as a poison, destroying chlorophyll and killing the cells. The nitrite production was *not* inhibited by cyanide.

Light affected the nitrate reduction by *Chlorella* in two ways: in the first place, the *evolution of carbon dioxide was gradually replaced, with increasing light intensity, by an evolution of oxygen*; and in the second place, the *total production of gas was increased* by as much as a factor of five or ten. The production of an *equivalent quantity* of oxygen, instead of carbon dioxide, could be explained by the assumption that reaction (19.1) proceeds in light in the same way as in the dark, but that carbon dioxide, formed in this reaction, is consumed by photosynthesis, and thus converted into oxygen; but this hypothesis could not explain why much *more* oxygen is produced in light than carbon dioxide in the dark. This relationship can be interpreted in two ways.

One way is to assume that reaction (19.1) is accelerated by light, thus producing more carbon dioxide, which is available for conversion into

oxygen by photosynthesis. This explanation was suggested by Warburg and Negelein, who thought that the acceleration of reaction (19.1) may be caused by an increase in the permeability of the cells to HNO_3 molecules in light; one could, however, also think of (19.1) as a genuine photochemical reaction—a chlorophyll-sensitized oxidation-reduction reaction between an organic reductant and nitrate, analogous to the “photoreduction” of carbon dioxide by organic hydrogen donors in adapted algae and purple *Athiorhodaceae*.

Another hypothesis, which leads to particularly interesting speculation, is that the photochemical reaction is the sensitized *reduction of nitrate by water* (and not by organic hydrogen donors), that is, a photosynthesis with nitrate substituted for carbon dioxide as reductant:

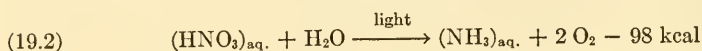

According to this hypothesis, oxygen is produced *directly* by “nitrate photosynthesis,” and not indirectly, by a superposition of ordinary photosynthesis on light-stimulated “nitrate respiration.” Of course, reactions (19.1) and (19.2) may run concurrently, as two competitive processes—similar to the photoreduction of carbon dioxide by hydrogen and glucose (*cf.* Chapter 6, page 141).

In the presence of phenylurethan, the rate of nitrate reduction in light remains undiminished, but pure carbon dioxide is liberated (as in the dark) instead of oxygen. One could suggest that this is an argument in support of the two-step mechanism of nitrate reduction. The first step, the light-stimulated nitrate respiration, may be as insensitive to urethan as the corresponding dark reaction (*cf.* above); while the second step is the urethan-inhibited ordinary photosynthesis. However, the effect of urethan can also be explained on the basis of direct “nitrate photosynthesis” by assuming that urethan inhibits the last, oxygen-liberating stage of reaction (19.2), and thus directs the process into an alternative channel in which the primary photochemical oxidation product (designated by $\{\text{OH}\}$ or Z in chapter 7) is reduced by available organic hydrogen donors, instead of liberating oxygen from water. In other words, urethan could convert “nitrate photosynthesis” into “nitrate photoxidation” in the same manner in which it converts ordinary photosynthesis into ordinary photoxidation (*cf.* Noack’s experiments described on page 528).

More detailed experiments, with specific inhibitors of the type of hydroxylamine, could help to analyze the mechanism of photochemical nitrate reduction and establish its relation to ordinary photosynthesis. Unfortunately, this subject has not received further attention since 1920, although it is certainly worth renewed study. It is not clear whether

observations on the effect of violet and ultraviolet light on the assimilation of nitrate by green plants (*cf.* Tottingham and Lease 1934) bear any relation to the photochemical nitrate reduction.

Lovell (1938) thought that the increase in oxygen evolution by *Elodea*, which he observed upon the addition of potassium nitrate (but not of potassium chloride), was due to nitrate reduction. However, according to Warburg and Negelein, "nitrate photosynthesis" occurs only in strongly acid solutions; comparison of Lovell's results with those of Pirson, described in chapter 13 (page 339), makes it probable that he observed merely a stimulation of normal photosynthesis by a removal of nitrate deficiency.

Developing the hypothesis introduced on page 540, we may suggest that the photochemical reduction of nitrate (or other substitute oxidants) occurs whenever the concentration of the normal oxidants in the primary photochemical process, *i. e.*, of the complex, $\{\text{CO}_2\}$, or of the intermediate hydrogen acceptor, X (*cf.* Eq. 7.10a), becomes depleted (while that of substitute oxidants is high). It may be worth recalling in this connection that some autotrophic bacteria can substitute nitrate for oxygen in chemosynthesis (*cf.* Chapter 5, pages 115 and 116).

2. Reduction of Other Inorganic Oxidants

In chapter 4 (section A), we described the interesting experiments of Hill on the chlorophyll-sensitized oxidation of water by *ferric salts* in aqueous suspensions of chloroplasts. Fan, Stauffer, and Umbreit (1943) were able to obtain some oxygen also from suspensions of live *Chlorella* cells deprived of carbon dioxide but provided with ferric phosphate or other ferric salts as oxidants. However, they were unable to prevent the back reaction (reoxidation of ferrous iron by oxygen) in the way used by Hill (*i. e.*, by reaction with ferricyanide), since the ferricyanide itself was reduced by the cells. This caused the reduction of ferric phosphate to come to an early end.

The so-called "Molisch reaction" (precipitation of silver from *silver nitrate* in the chloroplasts) was described in chapters 10 (page 270) and 14 (page 360). Gauteret (1934) noticed that this reaction is accelerated by light. This, too, may be an example of a chlorophyll-sensitized reduction *in vivo* (although it is doubtful whether water plays the part of reductant in this reaction).

3. Reduction of Organic Oxidants

Noack (1922) interpreted the occasional red coloration of green leaves as a chlorophyll-sensitized photochemical reduction of flavonols to anthocyanins. Similarly to photooxidation, this reaction occurs only when photosynthesis is inhibited (*e. g.*, by an excess of sugars, or by the absence of carbon dioxide).

Fan, Stauffer, and Umbreit (1943) carried out interesting experiments on the production of oxygen by *Chlorella pyrenoidosa* in the absence of carbon dioxide, but in the presence of various organic oxidants. In experiments analogous to those with ferric salts (*cf.* above), they obtained 0.05–0.10 milliliter of oxygen by the addition, to illuminated CO₂-free suspensions of *Chlorella* cells (about 100 mg. dry weight), of acetaldehyde, benzaldehyde, parabanic acid, and nitrourea. It will be noted that all these compounds contain a carbonyl group. Similar experiments gave negative results with formaldehyde, butylaldehyde, dimethylglyoxime, cystine, alizarin, quinalizarin, methylene blue, urea, methylurea, cyanuric acid, allantoin, uracil, xanthine, alloxan, succinate, citrate, fumarate, lactate, acetate, malate, isocitrate, pyruvate, glucose, xylose, arabinose, hexose diphosphate, hexose monophosphate, or phosphogluconic acid.

Quantitative studies of the photoreduction of carbonyl compounds by *Chlorella* cells were carried out with *benzaldehyde* as oxidant. To obtain a maximum amount of oxygen from a given quantity of benzaldehyde, it had to be added immediately after the start of illumination. It was added earlier in the dark, some benzaldehyde was used up by a dark reaction. Since this nonphotochemical decomposition was accompanied by the release of an equivalent quantity of carbon dioxide, *if carbonate was present* (but not if it was absent), the authors interpreted it as a *dismutation* of benzaldehyde (into benzoic acid and benzyl alcohol), with benzoic acid liberating carbon dioxide from the carbonate. If benzaldehyde is added immediately after the beginning of illumination, and the algae are young and in good condition, one molecule of oxygen can be obtained from two molecules of benzaldehyde, in accordance with the equation:

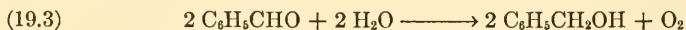

If benzaldehyde is added later, after the illumination in absence of carbon dioxide has lasted for one-half hour or more, the oxygen yield is smaller. This could be caused by a photochemical accumulation of substances capable of reducing benzaldehyde (*i. e.*, a substitution of H₂R for H₂O in reaction 19.3). In older cell suspensions, the quantity of liberated oxygen is further reduced—apparently, by a continuation, in light, of the nonphotochemical dismutation of benzaldehyde into benzyl alcohol and benzoic acid.

As always in “photosynthesis with substitute oxidants,” the question arises whether benzaldehyde is used as such, or is first oxidized to carbon dioxide. The authors considered the latter alternative as improbable, because they were unable to “catch” any carbon dioxide by alkali. The amount of liberated oxygen was unaffected by the presence of potassium hydroxyde. The maximum observed rate of oxygen produc-

tion from benzaldehyde was equal to about one-tenth the maximum rate of normal photosynthesis. The "photosynthesis with substitute oxidants" is thus about as efficient as the "photosynthesis with substitute reductants" as carried out by hydrogen-adapted algae (*cf.* Chapter 6).

C. MECHANISM OF SENSITIZATION *in vivo* *

We have now reviewed all photochemical reactions sensitized by chlorophyll and bacteriochlorophyll *in vivo* (*cf.* Table 19.I). If we

TABLE 19.I
REACTIONS SENSITIZED BY CHLOROPHYLL *in vivo*

Designation	Hydrogen acceptor	Hydrogen donor (R = organic radical)
Photosynthesis	CO ₂	H ₂ O
"Photoreduction"	CO ₂	H ₂ , H ₂ S, H ₂ R, H ₂ S ₂ O ₃ , etc.
"Photautoxidation"	O ₂	H ₂ R
Nitrate reduction	HNO ₃	H ₂ O or H ₂ R
Aldehyde reduction	C ₆ H ₅ CHO etc.	H ₂ O (or H ₂ R?)
Photochemical liberation of hydrogen	(atmosphere)	H ₂ R

consider photosynthesis as the "normal" photochemical reaction in green plants, the other processes in the table can be attributed to the replacement of one (or both) of the normal reaction components (CO₂ and H₂O) by "substitute oxidants" or "substitute reductants."

Table 19.I does not contain the combination "oxygen as oxidant and water as reductant." Of course, the net chemical result of this "autoxidation of water" would be zero; but it could perhaps be detected by isotopic indicators. It would be interesting to find out whether this reaction actually proceeds under certain conditions (*e. g.*, in CO₂-starved leaves). Its yield may perhaps be much larger than that of the photooxidation of organic hydrogen donors, which is responsible for the net chemical change (consumption of oxygen).

1. Hypothesis of a Common Primary Process in All Chlorophyll-Sensitized Reactions *in vivo*

The interpretation of photoreduction, photooxidation and nitrate reduction as "photosynthesis with substitute oxidants or reductants" leads to the working hypothesis that the primary photochemical process is the same in all these reactions, and that their different final results are due to secondary transformations of the same primary products.

* Bibliography, page 560.

As discussed in chapter 7, the primary process in photosynthesis may involve one of the ultimate reaction components, $\{\text{CO}_2\}$ or $\{\text{H}_2\text{O}\}$, or two intermediates, *e. g.*, HZ and X, as in equation (7.10a). If the first assumption is correct, the substitute reductants (or oxidants) may interfere *after* the first photochemical reduction of $\{\text{CO}_2\}$ (or the first photochemical oxidation of $\{\text{H}_2\text{O}\}$), but *before* the conversion of the products of these photochemical reactions into the final products, $\{\text{CH}_2\text{O}\}$ or O_2 (*e. g.*, the first oxidation product, $\{\text{OH}\}$), may react with the substitute reductants— H_2 , H_2S , etc.—before being converted into free oxygen; *cf.* Gaffron 1944). The mechanism of action of substitute reductants and oxidants appears even simpler if the primary process is of the type (7.10a), that is, if it produces an oxidized intermediate catalyst, Z, and a reduced intermediate catalyst, HX. In this case, we have merely to assume that these intermediates can, under suitable conditions, react further with O_2 or HNO_3 instead of CO_2 , and with H_2 , H_2R , or H_2S , instead of H_2O , respectively.

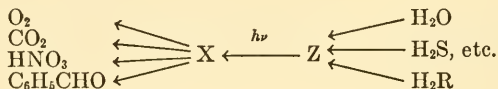

Scheme 19.I.—Chlorophyll-sensitized reactions *in vivo*.

Arrows in scheme 19.I represent hydrogen transfer. This scheme is closely related to schemes 6.III and 9.V.

In the latter, an intermediate, Y, was assumed between Z and X, and X was identified with the hydrogen acceptor in the hydrogenase system, A_{H} ; this led to a closed "hydrogen cycle" and thus permitted an explanation of the photochemical *liberation* of hydrogen in adapted algae, and of the coupling of the oxyhydrogen reaction with the reduction of carbon dioxide.

2. Association of Chlorophyll with the Sensitization Substrates; Fluorescence and Sensitization Yields *in vitro* and *in vivo*

We recall the eight possibilities of sensitization, derived in chapter 18 from the three alternatives: free sensitizer, A, or sensitizer associated with the substrate, B; physical energy transfer, α , or participation of the sensitizer in the chemical reaction, β ; and primary interaction with the oxidant, 1, or with the reductant, 2. We also recall the complications arising from a possible preliminary transformation of the sensitizer into a long-lived active form (by tautomerization, dismutation, or a reversible reaction with the solvent). The same possibilities must also be taken into account in the analysis of the primary process of sensitization by chlorophyll *in vivo*.

In discussing the sensitization phenomena in solution, we paid more attention to mechanisms of type *A*—which can be called “sensitizations by kinetic encounters”—than to mechanisms of type *B*—energy transfers or oxidation-reduction reactions within a complex. We decided that a complex formation of dissolved chlorophyll with oxygen was improbable (page 492); its association with the organic substrates of the sensitized reactions appeared more probable, but in no case was it proved by direct evidence.

The pigments in the living cell certainly are more or less rigidly bound in a structure which includes proteins, lipides, and carotenoids (*cf.* Chapter 14, part C). Franck and Herzfeld (1941) have postulated that the carbon dioxide-acceptor complex, $\{\text{CO}_2\}$, and its intermediate reduction products ($\{\text{HCO}_2\}$, etc.) also are associated with chlorophyll (*cf.* Scheme 7.VA). However, the extraction of the carbon dioxide acceptor from the cells by water and its possible location outside the chloroplasts (*cf.* Chapter 8, page 204), make a stable association between this component and chlorophyll improbable. On the other hand, chlorophyll may well be associated with the intermediary catalysts, X or Y, which first undergo a photochemical hydrogenation in photosynthesis and later bring about the reduction of the complex, $\{\text{CO}_2\}$, by thermal encounters. The “substitute oxidants” (O_2 , HNO_3) also are unlikely to be directly associated with chlorophyll, but may replace carbon dioxide (or the complex $\{\text{CO}_2\}$) in kinetic encounters with the reduced intermediate, HX.

As to the primary reductant HZ, it, too, is likely to be associated with chlorophyll (or may even be identical with it, *cf.* pages 551 *et seq.*).

If we assume that both molecules which take part in the primary photochemical reactions sensitized by chlorophyll (*e. g.*, X and HZ), are permanently associated with the pigment, the question of the “long-lived activated state,” which caused complications in the treatment of chlorophyll sensitization *in vitro*, appears in a new light. No “tautomerization” of chlorophyll seems feasible under these conditions; while “reversible reaction with the solvent” (which was considered on pages 484 and 491 as an alternative mechanism of long-lived activation) is replaced under these conditions by a “reversible reaction with the associated oxidants and reductants.”

The weakness of the fluorescence of chlorophyll *in vivo* can be considered as a sign of the rapidity of the primary reaction, which leaves only a small chance for the re-emission of light. Using a general formulation which does not prejudice a possible identification of chlorophyll with one of the primary reaction components, X or Z, we may write the following two equations for the alternative: fluorescence or primary photochemical reaction in a complex.

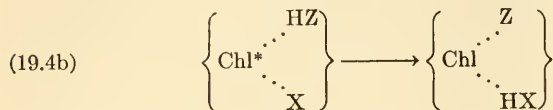
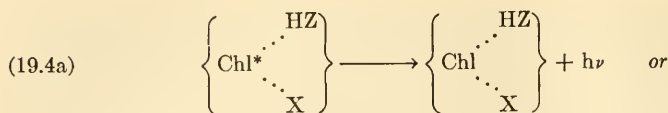

The state on the right side of equation (19.4b) may be the "long-lived activated state" *in vivo*. This state is formed, in the living cell, more rapidly than the corresponding state *in vitro* (as witnessed by the ten times lower yield of fluorescence); but it is also more rapidly destroyed by back reactions (as witnessed by the much higher concentration of oxygen required for efficient photooxidation *in vivo* as compared with solutions; *cf.* page 530). Both these differences can be interpreted as consequences of the association of the pigment *in vivo* with the photosensitive components before the primary process and with the products of their transformation after this process. They can thus be quoted as arguments in favor of the association hypothesis.

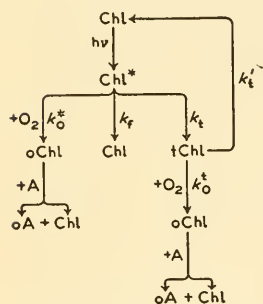

Scheme 19.II.—Fluorescence and sensitized autoxidation in chlorophyll solutions.

We may use schemes 19.II and 19.III to formulate more precisely the influence of oxygen on fluorescence and sensitization by chlorophyll *in vitro* and *in vivo*.

Scheme 19.II represents the probable conditions *in vitro* (k_t in this scheme may refer to tautomerization or to a reversible reaction with the solvent). The quantum yield of fluorescence, according to scheme 19.II, is (*cf.* Rabinowitch 1941):

$$(19.5) \quad \varphi_{\text{sol.}} = \frac{k_f}{k_f + (k_i + k_o[\text{Chl}] + k_t) + k_o^*[\text{O}_2]} = \frac{k_f}{k_f + k + k_o^*[\text{O}_2]}$$

where k_f is the rate of fluorescence and $k_i + k_o[\text{Chl}]$ that of self-quenching (not shown in scheme 19.II). (The two terms correspond to internal energy dissipation in the solvated chlorophyll molecule and to collisions with other chlorophyll molecules; *cf.* Weiss and Weil-Malherbe 1944).

The quantum yield of oxidation of Chl to oChl (which in presence of a "saturating" quantity of acceptor may be considered as the rate-determining step in sensitized autoxidation) is:

$$(19.6) \quad \gamma_{\text{sol.}} = \frac{k_t}{k_f + k + k_o^*[\text{O}_2]} \cdot \frac{k_o^*[\text{O}_2]}{k_o^*[\text{O}_2] + k_t'} + \frac{k_o^*[\text{O}_2]}{k_f + k + k_o^*[\text{O}_2]}$$

If, at $[\text{O}_2] = 10\text{--}1000$ mm., $k_o^*[\text{O}_2]$ is $> k$, the fluorescence yield, φ , must depend on oxygen pressure in this range; and if $k_o^*[\text{O}_2]$ is $\gg k_t'$,

the oxidation yield, γ , will be practically independent of the partial pressure of oxygen:

$$(19.7) \quad \gamma_{\text{sol.}} = \frac{k_t + k_0^*[\text{O}_2]}{k_f + k + k_0^*[\text{O}_2]} \simeq \frac{k_t}{k_f + k}$$

At the low $[\text{Chl}]$ values, $k \simeq k_t$ and since $k_f < k$, γ must approach 1 (still assuming that A is present in excess). These are the conditions encountered in the study of the chlorophyll-sensitized autoxidation of amines *in vitro* (cf. pages 509, 513 and 518–520).

In vivo, on the other hand, we may postulate the sequence of reactions represented in scheme 19.III.

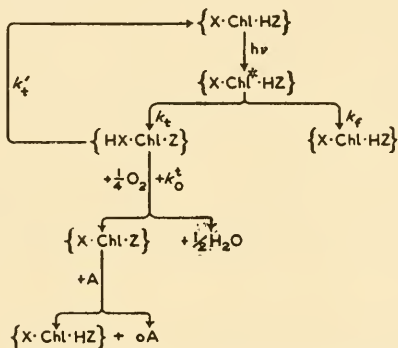

Scheme 19.III.—Fluorescence and sensitized autoxidation by chlorophyll in the living cell.

Scheme 19.III* gives, for the quantum yield of fluorescence:

$$(19.8) \quad \varphi_{\text{cell}} = \frac{k_f}{k_f + k_i + k_t}$$

—independent of $[\text{O}_2]$ —and for the yield of sensitization:

$$(19.9) \quad \gamma_{\text{cell}} = \frac{k_t}{k_f + k_t} \cdot \frac{k_0^*[\text{O}_2]}{k_0^*[\text{O}_2] + k_s}$$

—proportional to $[\text{O}_2]$, if $k_s \gg k_0^*[\text{O}_2]$. Equation (19.8) is based on the assumption that the intermediate forms, $\{\text{HXChlZ}\}$ and $\{\text{XChlZ}\}$, do not accumulate, during the illumination, in quantities commensurate with those of the basic form, $\{\text{XChlHZ}\}$, and thus do not participate in light absorption. If this condition is *not* fulfilled, the contribution of the intermediate forms to fluorescence must be taken into consideration (as will be done in volume II, chapter 24). This contribution can be considerable because the intermediate forms are not subject to “chemical” quenching by reaction (19.4b). This explains, among other things, why oxygen sometimes *enhances* instead of quenching the fluorescence of chlorophyll *in vivo*—it transforms the short-lived intermediate,

* Self-quenching by internal conversion (rate k_i) not shown in scheme 19.III.

{HXChlZ}, which can be converted into {XChlHZ} by a monomolecular back reaction, into the oxidized intermediate, {XChlZ}, which requires, for the regeneration of the normal form, a bimolecular reaction with the reductant A, and therefore has a comparatively long life. Scheme 19.III could be simplified by assuming HZ = Chl (*cf.* pages 551 *et seq.*); but in the present discussion we prefer to keep the question of the chemical participation of chlorophyll in the primary photochemical process open.

3. Problem of the Chemical Participation of Chlorophyll in the Primary Process

In chapter 18, we considered the energy transfer mechanisms (designated on page 514 as mechanisms of type α) as improbable (except for the case of substrates whose absorption bands overlap with those of the sensitizer—as in the case of the chlorophyll-sensitized reduction of azo dyes, or of the carotenoid-sensitized fluorescence of chlorophyll), and have analyzed mainly mechanisms of type β , in which the sensitizer was assumed to enter into reversible oxidation-reduction reactions. All reductants and oxidants in table 19.1 are colorless, and therefore unlikely to take over the excitation energy from chlorophyll in kinetic encounters.

However, the improbability of energy transfer from chlorophyll to a colorless substrate becomes less definite if we consider this substrate is a part of the same complex.

It seems possible that in a complex, $\left\{ \begin{array}{c} \text{X} \\ \text{Chl} \cdots \cdots \text{X} \\ \cdots \cdots \text{HZ} \end{array} \right\}$, the excitation of

chlorophyll could cause a hydrogen (or electron) to be transferred from HZ to X (as represented in scheme 19.III), leaving chlorophyll itself unchanged. This process can be classified as an "energy transfer" as far as the role of chlorophyll is concerned (even though the acceptor uses this energy for a chemical transformation rather than for an electronic excitation).

Although such a "physical" mechanism of sensitization by chlorophyll *in vivo* cannot be entirely excluded, we are inclined to think that, in the living cell, too, mechanisms of type β , which involve a "chemical" participation of chlorophyll in the primary reaction, are more probable. However, we must admit that no *direct* proof of this hypothesis has as yet been secured, even though the alternative, "physical sensitizer" or "chemical photocatalyst," has been argued back and forth in the literature on photosynthesis, for, now, well over fifty years.

The two opposing points of view were first formulated by Timiriazev in 1885 and Reinke in 1886. Timiriazev (1885, 1904) suggested that

chlorophyll has two modifications, "similar to hemoglobin and oxy-hemoglobin," and that, in the course of photosynthesis, the pigment is first bleached (by oxidation or by reduction) and then restored to its colored form. He pointed to the increased transparency of leaves in intense light, "usually attributed to the re-alignment of chloroplasts" (cf. Vol. II, Chapter 22) as an argument in favor of this "reversible bleaching theory." Reinke (1886) took issue with Timiriazev. He saw in the comparative photostability of chlorophyll in the leaves killed by boiling, a proof that light does *not* cause a reversible decolorization of this pigment—since, in his opinion, the capacity for restoration of the color should be lost after boiling. This argument against Timiriazev's theory is not very convincing; but the merit of Reinke's paper lies in a remarkably clear presentation of the alternative "physical" theory, visualizing a transfer of vibrational energy from the light-excited colored sensitizer to the colorless reaction substrate. The triple alternative faced by light-excited chlorophyll molecules—energy transfer to a reactive system, self-destruction of the pigment, or re-emission of absorbed energy as fluorescence—was described by Reinke with a clear understanding of the physical problems, remarkable in a botanical paper in the year 1886.

The controversy between the proponents of "physical" and "chemical" theories has not ceased since the time of Timiriazev and Reinke. Willstätter and Stoll (1918) thought it could be resolved by the determination of the effect of photosynthesis on the concentration of chlorophyll in plants. As shown by table 19.II, they found that even intense photo-

TABLE 19.II
EFFECT OF PHOTOSYNTHESIS ON CHLOROPHYLL CONCENTRATION
(AFTER WILLSTÄTTER AND STOLL)

Plant	Duration of illumination, hrs.	Temp., °C.	Chl, per cent of fresh weight	
			Before	After
<i>Prunus laurocerasus</i>	22	30	0.094	0.095
<i>Hydrangea opulodes</i>	6	30	0.092	0.091
<i>Pelargonium zonale</i>	6	40	0.125	0.128

synthesis at elevated temperatures, does not change this concentration. Their results prove that chlorophyll is not *permanently* affected by photosynthesis. But, contrary to the original intention of Willstätter and Stoll, they do not solve the problem of a *reversible* chemical transformation of the pigment. In this case, the concentration of chlorophyll could be reduced to a certain extent *during* photosynthesis (as envisaged

by Timiriazev), but should be restored to its original value immediately after the cessation of illumination. In other words, chlorophyll in plants should behave in the same way as dissolved chlorophyll did in the experiments of Porret and Rabinowitch and of Livingston, described in chapter 18 (pages 486 *et seq.*).

As stated previously, the extent of such reversible changes in illuminated systems depends on the relative rates of two reactions—the one causing the change, and the other restoring the original state.

If chlorophyll is changed reversibly during photosynthesis, the quantum yield of its change must be at least equal to that of photosynthesis, that is, it must approach unity at low light intensities, and decline to about 0.1 in strong light. In direct sunlight, each chlorophyll molecule may absorb light ten times each second, and thus must be changed at least once in a second. Assuming that it stays in the changed state for τ seconds before being restored by a back reaction, the proportion of changed molecules present in the stationary state will be τ (as long as $\tau \ll 1$ second). If the back reaction is *nonphotochemical*, τ can have almost any value imaginable, depending on the concentration of the molecules participating in the back reaction and on its energy of activation. If τ is very small, (*e. g.*, ≤ 0.001 second), it is quite possible for chlorophyll molecules to be chemically changed every time they initiate photosynthesis, and to be restored to the original state with such promptness that only one chlorophyll molecule in a thousand or more will be present in the changed (and probably discolored) state at any time, even in the most intense light.

We have deduced, on page 546, from the concentration dependence of the rate of photooxidation, that the lifetime of the "long-lived" activation state of chlorophyll *in vivo* is much shorter than in organic solutions. Thus, the reversible bleaching of chlorophyll *in vivo* is likely to be much weaker than the effects observed by Porret and Rabinowitch and by Livingston in chlorophyll solutions in methanol.

The situation changes if we assume that the back reaction too is *photochemical*, *i. e.*, that chlorophyll uses photons, first for a (direct or indirect) reduction of $\{\text{CO}_2\}$ (oxidizing itself in this process), and then in the oxidized state, for a (direct or indirect) oxidation of water and its own reduction (as was assumed in the theory of Franck and Herzfeld 1941). Under these conditions, a stationary state of photosynthesis can be maintained only if the two photochemical reactions proceed with equal velocity. If we assume that the two modifications of chlorophyll are (about) equally intensely colored, and react with (approximately) the same quantum yield, an equality of the two reaction rates is only possible if the two forms are present, in the stationary state, in approximately equal quantities.

Two alternative pictures of the chemical participation of chlorophyll in photosynthesis emerge from this discussion. In the *first picture*, chlorophyll is bleached—or strongly changed in color—in the photochemical forward reaction, and is restored by a *thermal back reaction* so rapidly that no visible decolorization takes place in the stationary state of photosynthesis. In the *second picture*, the color of chlorophyll is not strongly changed by its photochemical transformation; the product of this transformation may therefore accumulate, during photosynthesis, until its concentration is about equal to that of the original form, without changing the coloration of the cells; and the restoration of chlorophyll may be achieved by a *photochemical back reaction*.

A choice between these two possibilities could be facilitated by a closer investigation of the pigment spectrum during photosynthesis. Visual observation is insufficient, because the eye is a poor instrument for the estimation of extinction curves; it would hardly notice the disappearance of even 20% of the pigment, not to speak of a mere shift in the position of the absorption bands. The parallel alignment of chloroplasts in strong light was found by Schanderl and Kaempfert to increase considerably the transmissivity of leaves (Chapter 22, Vol. II); and the same authors have reported that leaves often grow more opaque during prolonged illumination because of the deposition of assimilates. These changes would hardly ever be noticed by a mere visual observation of the leaves.

In the first of the two pictures mentioned above, the photochemical forward reaction may be either an *oxidation* or a *reduction* of chlorophyll; thus, we can classify the theories of the chemical function of chlorophyll in photosynthesis in the following three groups (the first two of which correspond to the mechanisms designated as $\beta 1$ and $\beta 2$ in chapter 18, page 514):

(a) *Photochemical oxidation* of chlorophyll to a decolorized form; nonphotochemical reduction; in this case, chlorophyll can be identified with the primary reductant, HZ, in scheme 7.I.

(b) *Photochemical reduction* of chlorophyll to a decolorized form; nonphotochemical reoxidation; in this case, chlorophyll can be identified with the primary oxidant, X, in scheme 7.I (“decolorized” may mean merely a form whose color is irrelevant for its transformation back into chlorophyll).

(c) *Photochemical oxidation and photochemical reduction* (in this case, both the oxidized and the reduced form must be green). Chlorophyll can be identified with the intermediary oxidation-reduction system, Y, in scheme 7.I. In case (c), the extracted chlorophyll may represent either the oxidized or the reduced form.

Theories belonging to all these groups have been suggested by different authors.

(a) *Photochemical Oxidation, Nonphotochemical Reduction of Chlorophyll*

Weigert (1923) postulated that the primary photochemical process in photosynthesis is an electron transfer from chlorophyll to water, followed by the oxidation of water by oxidized chlorophyll and reduction of carbon dioxide by reduced water:

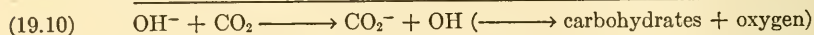
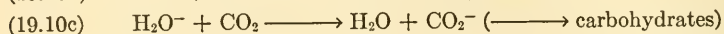
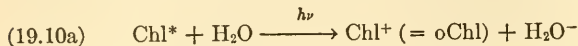

Our four quanta schemes (7.7) and (7.10), and the eight quanta schemes (7.14) and (9.10), can be classified as "primary chlorophyll oxidation schemes" if one identifies the reductant, HZ (or HX), with chlorophyll, and thus writes, for example, instead of (7.10a):



where oChl may stand for a "monodehydrochlorophyll."

One is free to speculate about the possible role in this one-step oxidation of the "lone" hydrogen atom in position 10 (*cf.* Stoll 1932, 1936), or of the "extra" hydrogen atoms in positions 7 and 8.

We can use the elementary photochemical process (19.11) to rewrite the various mechanisms of photosynthesis and photooxidation suggested in chapters 7, 9, and 18 with chlorophyll as the primary photoreductant. For example, the steps *a*, *b*, *d* and *g* in equation system (9.10), which represented photosynthesis according to the theory of "energy dissipation," become:

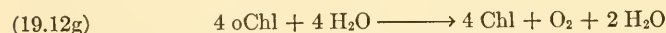
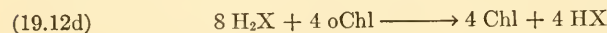
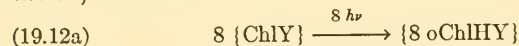

The mechanism of photooxidation *in vivo*, represented by scheme 9.III, becomes, with HZ = Chl:

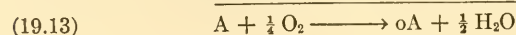
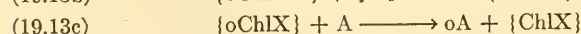
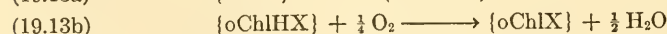
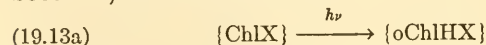

One objection can be raised to mechanism (19.13). Reaction (19.13c) appears to be the same by which "substitute reductants" replace water in the photosynthesis of bacteria and anaerobically adapted algae. If this reaction can occur in *all* green plants (that is, if it does not need the intermediary of an hydrogenase), why should all of them not be able to reduce carbon dioxide at the cost of cellular or added organic hydrogen donors, that is, to carry out "*photoreduction*" with organic reductants instead of photosynthesis? (This question was asked once before in chapter 6, page 145.) The answer may be that photoreduction is possible, but that in photosynthetically active plants, the probability that oChl will react with *water* is so much higher than that it will react with another hydrogen donor (A in 19.13c, H₂R in Scheme 6.III) that the last-named reaction remains unnoticed. In *photoxidation*, on the other hand, only the small fraction of oChl molecules which react with A produce a net chemical change, since (as mentioned on page 543) the reaction of oChl with H₂O:

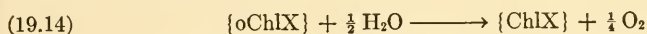

merely compensates for an equal amount of oxygen which is consumed by the reoxidation of the intermediate HX by oxygen according to (19.13b).

Thus, *photoxidation in vivo* may represent a small irreversible residue of a reversible photochemical process, which may be described as "*photosynthesis running in a circle*" (because of the substitution of oxygen for carbon dioxide as the final oxidant). The residual effect is caused by the substitution of a small proportion of oxidizable cellular substrates for water as final reductants (compare Scheme 19.I).

Since photoxidation occurs also in boiled leaves, reactions (19.13b) and (19.13c) must be catalyzed by heat-resistant catalysts of low molecular weight, rather than by true enzymes (*cf.* Noack 1925, 1926).

(b) Photochemical Reduction, Nonphotochemical Reoxidation of Chlorophyll

This alternative was suggested by Conant (*cf.* Conant, Dietz, and Kamerling 1931), who thought that extracted chlorophyll is the *reduced* form of the catalyst. It oxidizes itself in air by forming *allomerized* chlorophyll. Conant suggested that, *in vivo*, it could be oxidized by a thermal reaction with carbon dioxide and reduced by a photochemical reaction with water. (Thus, the photochemically active form was supposed to be identical with *allomerized* chlorophyll.)

Willstätter (1933) suggested that chlorophyll (H₂R) is first oxidized by oxygen to a radical, "monodehydrochlorophyll" (HR), thus accounting for the alleged necessity of oxygen for photosynthesis (*cf.* Chapter 13, page 326); it then reduces carbon dioxide by a thermal reaction, being itself converted into a "didehydrochlorophyll," R. (This mechanism bears a certain similarity to the "energy dismutation" defined on page 165.) Finally, R oxidizes water by a photochemical reaction and is itself reduced, first to HR, and then to H₂R.

(c) Photochemical Oxidation and Photochemical Reduction of Chlorophyll

The earliest variations of this theory assumed an interconversion of chlorophylls *a* and *b*. When Willstätter and Stoll (1913) found that chlorophyll *b* contains one oxygen atom more (and two hydrogen atoms less) than chlorophyll *a*, they conceived the idea that, in the course of photosynthesis, chlorophyll *a* may be oxidized to *b* (by reducing carbon dioxide) and then reduced again (by oxidizing water). This prompted them to search for changes in the ratio $[a]:[b]$ during intense photosynthesis. No such changes were found; and Willstätter and Stoll considered this as a decisive argument against the theory of an $a \rightleftharpoons b$ transformation in photosynthesis. This is not necessarily so, since the equilibrium may be rapidly re-established in the dark (*cf.* page 550). However, no simple way has been found to oxidize chlorophyll *a* to chlorophyll *b* *in vitro* (*cf.* Stoll and Wiedemann, page 466). Furthermore, as discussed on pages 405 *et seq.*, colored algae (*Phaeophyceae*, *Rhodophyceae*, *Diatomeae* and *Cyanophyceae*)—*i. e.*, the vast majority of photosynthesizing organisms—contain no chlorophyll *b*; this certainly speaks against a chemical equilibrium involving the two forms.

Although abandoned by Willstätter and Stoll (1918), the hypothesis of a reversible $a \rightleftharpoons b$ transformation has been revived by Dixon and Ball (1922), who postulated that chlorophyll *a*, by photochemically reducing carbon dioxide, is converted into chlorophyll *b*.

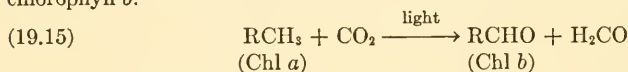

Chlorophyll *b* oxidizes water, also photochemically, and is thus restored to chlorophyll *a*:

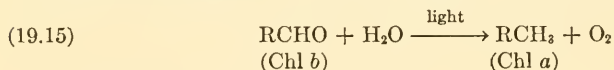

In a different (and highly implausible) form, the $a \rightleftharpoons b$ conversion hypothesis was again presented by Baly and Morgan (1934) and Baly (1935, 1941). They assumed the following two reactions (RH₂ = Chl *a*; RO = Chl *b*):

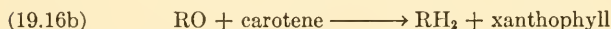
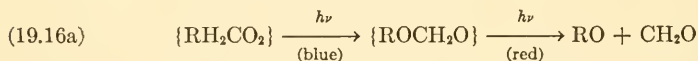

Reaction (19.16a) was assumed to proceed in two photochemical steps—the first leading to a complex (Chl*b*CH₂O) and the second liberating free CH₂O. The first step was assumed to require a quantum of blue light, the second a quantum of red light. Reaction (19.16b) was considered to be a dark reaction (Blackman reaction).

Baly's scheme ignores the fact that photosynthesis involves not only a reduction of carbon dioxide, but also a liberation of oxygen from water. (Neglect of this point is conspicuous also in Baly's experiments on artificial photosynthesis, pages 85 *et seq.*), and stops at the formation of formaldehyde and xanthophyll from carbon dioxide and carotene. Furthermore, Baly ignores the elementary fact that photosynthesis can proceed in pure blue light as well as in pure red light.

Ruben, Frenkel, and Kamen (1942) intended to check the $a \rightleftharpoons b$ transformation theory by means of radioactive magnesium, basing their method on the more rapid "pheophytization" of chlorophyll *a*, found in experiments *in vitro* (cf. page 467). They hoped to be able to introduce Mg^* selectively into chlorophyll *a in vivo* and then to investigate the conversion of this "tagged" chlorophyll *a* into chlorophyll *b* during photosynthesis. However, no measurable exchange of magnesium in chlorophyll *in vivo* with Mg^*NO_3 could be obtained in the short time available, so that the purpose of the investigation has remained unfulfilled.

Most recent theories of photosynthesis, which assumed a photochemical oxidation and photochemical reduction of chlorophyll, have renounced any distinction between the functions of the chlorophylls *a* and *b*.

Stoll (1932) suggested that chlorophyll can lose reversibly two hydrogen atoms, by a process analogous to allomerization (which Stoll and Wiedemann thought they had succeeded in reversing, at least in the case of chlorophyll *b*, cf. page 462). Since allomerized chlorophyll has the same color as the nonallomerized product, a half-and-half distribution of chlorophyll between the ordinary and allomerized form could take place *in vivo* without becoming apparent to the eye. The oxidized (allomerized) form was thought by Stoll to be able to oxidize water photochemically, while the reduced (nonallomerized) form was assumed to be able to reduce carbon dioxide, also by a photochemical reaction.

Using suggestions made by Franck in 1935, Stoll (1936) later substituted for his first concept the theory of an *hydrogen-hydroxyl exchange* in chlorophyll; in this theory, too, both the oxidation of chlorophyll to an hydroxychlorophyll (perhaps by an exchange of the hydrogen atom in position 10 for an hydroxyl radical, leading to the 10-hydroxychlorophyll mentioned on page 461), and the reduction of the latter back to ordinary chlorophyll were supposed to be photochemical processes.

The most recent (third) theory of Franck and Herzfeld (1941), described by equations (7.12) and scheme 7.VA (with X now standing for oxidized chlorophyll, and HX for reduced chlorophyll) represented a return to Stoll's earlier picture. In this theory, chlorophyll was supposed to oscillate during photosynthesis between the two green forms designated by Franck as Chl and HChl, respectively, one of them being active in the photochemical oxidation of water and the other, in the photochemical reduction of carbon dioxide.

The eight quanta mechanism (7.11), too, can be formulated with chlorophyll as photocatalyst—by identifying Y with Chl and HY with HChl.

It is scarcely necessary to rewrite here equation systems (7.11) and (7.12) or schemes (7.V) and (7.VA) in order to illustrate these concepts.

Of the three types of theories we have reviewed, those of type (b) are least plausible—since we have no experimental evidence indicating

the capacity of chlorophyll for reversible reduction. Thus we must make our choice between schemes of the type (a) or (c)—*e. g.*, between the energy dismutation theory (9.10) (in the form 19.12, in which HZ is identified with chlorophyll), and the Franck-Herzfeld mechanism 7.VA (or its less specific prototype, 7.V).

Reversible oxidation of chlorophyll to a decolorized form (which tends to support theories of type a), as well as the *occurrence of chlorophyll in two interconvertible green forms* belonging to two different levels of oxidation (which, if definitely established, would provide strong support for theories of type c), were both discussed in chapter 16 (pp. 456 *et seq.*). We recall that the experiments of Rabinowitch and Weiss (1937) have indicated that chlorophyll is reversibly oxidizable to a decolorized compound ("oxychlorophyll"), and that its oxidation can be brought about by a photochemical reaction (page 488). However, several objections stand in the way of an identification of the yellow "oxychlorophyll" of Rabinowitch and Weiss with oChl in equation (19.11): for instance, the instability of "oxychlorophyll" (which is irreversibly changed by illumination with blue-violet light, by contact with water, and even by standing for more than a few minutes). However, conditions in the living cell may be such as to stabilize the oxidized form, or to make its instability less dangerous, by providing for a rapid return into the reduced colored state of all oChl molecules not used for the evolution of oxygen. (It was suggested on page 546 that the reversal of the primary photochemical process, *e. g.*, by reaction $\{\text{oChlHX}\} \longrightarrow \{\text{ChlX}\}$, is very rapid in the living cell, because the two products remain linked in a complex.)

As to the existence of two interconvertible green forms of chlorophyll, our discussion in chapter 16 indicated several possible systems of this type, *e. g.*, chlorophyll and protochlorophyll (7,8-didehydrochlorophyll), chlorophyll and dihydrochlorophyll (2-vinyl-bacteriochlorophyll), chlorophyll and 10-monodehydrochlorophyll (or 10-hydroxychlorophyll), and chlorophyll *a* and chlorophyll *b*. However, a reversible photochemical interconversion has yet to be demonstrated for any of these pairs.

It may be useful to reflect on the thermodynamic properties which the chlorophyll system should possess in order to fulfill the functions assigned to it in theories of types *a* and *c*. In the first case, its oxidized form is called upon to oxidize water by a thermal reaction (directly or indirectly); thus, its normal potential must be exceptionally *negative* (≤ -0.8 volt), which is not impossible for a free radical (*cf.* page 232). In the second case, the reduced form of chlorophyll is required to reduce carbon dioxide (directly or indirectly) in the dark, which calls for an exceptionally *positive* potential ($\geq +0.4$ volt). In case *c*, the oxidation-reduction potential of chlorophyll could lie in the middle between these two extremes.

The reduction of "oxychlorophyll" by ferrous ions (*cf.* page 464) points to a rather low potential of the chlorophyll-oxychlorophyll system (≤ -0.7 volt) and thus tends to support theory *a*.

Some evidence pertinent to the chemical function of chlorophyll in photosynthesis was obtained by Norris, Ruben, and Allen (1942) in the study of photosynthesis of *Chlorella* in water containing tritium, the radioactive hydrogen isotope, H³. They found no penetration of tritium into chlorophyll after a period of photosynthesis. This result can be interpreted in several ways:

(1) it may indicate that chlorophyll does not serve as a reversible hydrogen donor and acceptor at all, and may thus be quoted in support of the "physical" sensitization theory; or

(2) it may mean that chlorophyll donates hydrogen to carbon dioxide by a photochemical reaction, but recovers it from water by a thermal reaction, and that the rate of the latter is much slower for the heavy tritium than for ordinary hydrogen. This interpretation would support scheme *a* (as against the schemes *b* and *c*) because, in the latter theories, hydrogen is acquired by chlorophyll by a photochemical reaction, and no difference between the rates of *photochemical* transfer of the two isotopes could be expected.

(3) However, the same result can be reconciled with schemes *b* and *c* as well, if one assumes *either* that an intermediate oxidation-reduction system (*e. g.*, RO-ROH in Franck's scheme 7.VA) serves as a "filter" which "traps" tritium between water and chlorophyll, *or* that extracted chlorophyll is identical with the *oxidized*, rather than with the reduced, form of the photocatalyst. Thus, the experiments with tritium, although interesting, do not yet allow of a definitive interpretation.

Ruben, Hassid, and Kamen (1939) found that, if *radioactive carbon* is used in photosynthesis, some radioactivity is found afterwards in chlorophyll. The absolute quantity of C* absorbed by chlorophyll is small (*e. g.*, 0.04% C* in chlorophyll as against 24% in carbohydrates after one hour of illumination) but, because of the small concentration of chlorophyll, the probability that a radioactive C* atom will be found in a given chlorophyll molecule is as high as one-fourth of the probability of finding it in a given molecule of carbohydrate. This entrance of radioactive carbon into chlorophyll probably is indicative of a rapid decomposition and resynthesis of the pigment *in vivo*, and bears no direct relation to the chemical mechanism of photosynthesis.

4. Role of Accessory Pigments in Photosynthesis

The function of the carotenoids and phycobilins in photosynthesis is even less well known than that of chlorophyll. Two specific sensitization effects have been ascribed to the carotenoids: *phototaxis* (*cf.*, for example, the experiments of Voerkel 1934 and Blum 1935, in Vol. II, Chapter 22) and a stimulation of *respiration* (*cf.* Föckler 1938 and Emerson and Lewis 1943; these experiments will be discussed in Chapter 20). In

addition, however, both the carotenoids and the phycobilins appear to contribute to the sensitization of photosynthesis. Proofs of this assertion are based on the analysis of the relation between wave length, light absorption, and yield of photosynthesis, which will be discussed in volume II, chapters 22 and 30.

The fact that in no case have carotenoids or phycobilins been found able to produce photosynthesis *without* chlorophyll supports the view—first expressed by Engelmann as long as 60 years ago (1884, 1887)—that accessory pigments do not participate directly in the oxidation-reduction process, but transfer their excitation energy to chlorophyll. As stated on page 515, this “physical” mechanism appears much more plausible in the case of energy transfer between two dyes with overlapping absorption bands than in the case of a transfer from a pigment to a colorless substrate. The *carotenoid-sensitized fluorescence of chlorophyll* in green algae and diatoms (*cf.* Vol. II, Chapter 24) provides a direct demonstration of the occurrence of the process:

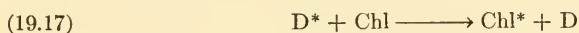

(D = carotenoid dye). As suggested previously, the extension of these experiments to phycobilin-carrying red and blue algae would be of considerable interest because, in these organisms, the red or blue pigments must provide the largest part of the energy used for photosynthesis. Furthermore, the structural similarity between phycobilins and chlorophylls makes a *chemical* substitution of the former for the latter as the photocatalysts in photosynthesis more plausible than a similar replacement of chlorophyll by the carotenoids.

Bibliography to Chapter 19

Photochemistry of Pigments *in vivo*

A. *Photautoxidations in vivo*

- 1881 Pringsheim, N., *Untersuchungen über die Lichtwirkung und Chlorophyllfunktion in der Pflanze*. Engelmann, Leipzig, 1881.
- 1882 Pringsheim, N., *Jahrb. wiss. Botan.*, **13**, 377.
- 1883 Reinke, J., *Botan. Z.*, **41**, 697, 713, 732.
- 1885 Reinke, J., *ibid.*, **43**, 65, 81, 27, 113, 129.
- 1896 Ewart, A. J., *J. Linnean Soc.*, **31**, 217.
- 1897 Ewart, A. J., *Ann. Botany*, **11**, 439.
- 1898 Ewart, A. J., *ibid.*, **12**, 363.
- 1903 Pantanelli, E., *Jahrb. wiss. Botan.*, **39**, 167.
Weis, F., *Compt. rend.*, **137**, 801.
- 1905 Lubimenko, V. N., *Rev. gén. botan.*, **17**, 381.
- 1907 Lubimenko, V. N., *Compt. rend.*, **145**, 1347.
- 1908 Lubimenko, V. N., *Ann. sci. nat. Genève*, **IX**, 7, 321.
Lubimenko, V. N., *Rev. gén. botan.*, **20**, 162, 253, 285.
- 1911 Blackman, F. F., and Smith, A. M., *Proc. Roy. Soc. London B*, **83**, 389.

- 1917 Ursprung, A., *Ber. deut. botan. Ges.*, **35**, 57.
- 1919 Warburg, O., *Biochem. Z.*, **103**, 341.
- 1923 Johansson, N., *Svensk Botan. Tid.*, **17**, 215.
- 1924 Fromageot, C., *Bull. soc. chim. biol.*, **6**, 169.
- 1925 Noack, K., *Z. Botan.*, **17**, 481.
- 1926 Noack, K., *Naturwissenschaften*, **14**, 383.
Noack, K., *Z. angew. Chem.*, **39**, 302.
- 1928 Lubimenko, V. N., *Rev. gén. botan.*, **40**, 415, 486.
Lubimenko, V. N., *Arch. biol. Sta. Sevastopol*, **1**.
Montfort, C., and Neydel, K., *Jahrb. wiss. Botan.*, **68**, 801.
Wehner, O., *Planta*, **6**, 543.
Johansson, N., *Jahrb. wiss. Botan.*, **71**, 154.
- 1930 Montfort, C., *ibid.*, **72**, 776.
Harder, R., *Planta*, **11**, 263.
- 1932 van der Paauw, F., *Rec. trav. botan. néerland.*, **29**, 497.
Richter, O., *Denkschr. Akad. Wiss. Wien, Math.-naturw. Klasse*, **103**,
165, 172.
- 1933 Arnold, W., *J. Gen. Physiol.*, **17**, 135, 145.
Harder, R., *Planta*, **20**, 699.
Montfort, C., *Protoplasma*, **19**, 385.
Montfort, C., *Biochem. Z.*, **261**, 179.
- 1935 Emerson, R., *Cold Spring Harbor Symposia Quant. Biol.*, **3**, 128.
Richter, O., *Sitzber. Akad. Wiss. Wien Math.-naturw. Klasse, Abt. I*,
144, 157.
- 1936 Mevius, W., *Jahrb. wiss. Botan.*, **81**, 327.
- 1938 Wassink, E. C., Vermeulen, D., Reman, G. H., and Katz, E., *Enzymo-
logia*, **5**, 100.
Föckler, H., *Jahrb. wiss. Botan.*, **87**, 45.
Gessner, F., *ibid.*, **86**, 441.
- 1939 Stälfelt, M. G., *Planta*, **30**, 384.
Gaffron, H., *Biol. Zentr.*, **59**, 288.
Gaffron, H., *Cold Spring Harbor Symposia Quant. Biol.*, **7**, 377.
Gilles, E., *Bull. soc. botan. France*, **86**, 140.
Funk, G., *Ber. deut. botan. Ges.*, **57**, 404.
- 1940 Funk, G., *ibid.*, **58**, 506.
McAlister, E. D., and Myers, J., *Smithsonian Inst. Pub. Misc.
Collections Repts.*, **99**, No. 6.
Myers, J., and Burr, G. O., *J. Gen. Physiol.*, **24**, 45.
- 1941 Franck, J., and French, C. S., *ibid.*, **25**, 309.
- Montfort, C., *Naturwissenschaften*, **29**, 238.
- 1942 Montfort, C., and Zöllner, G., *Botan. Arch.*, **43**, 393.

B. Sensitized Oxidation-Reductions in vivo

- 1920 Warburg, O., and Negelein, E., *Biochem. Z.*, **110**, 66.
- 1922 Noack, K., *Z. Botan.*, **14**, 1.
- 1934 Tottingham, W. E., and Lease, E. J., *Science*, **80**, 615.
Gauteret, R., *Compt. rend.*, **198**, 1252.

- 1938 Lovell, J., *Proc. Leeds Phil. Lit. Soc. Sci. Sect.*, **3**, 488.
1943 Fan, C. S., Stauffer, J. F., and Umbreit, W. W., *J. Gen. Physiol.*, **27**,
15.

C. Mechanism of Sensitization in vivo

- 1884 Engelmann, Th. W., *Botan. Z.*, **42**, 81, 97.
1885 Timiriazev, C., *Bull. Congr. Intern. Botan. St. Pétersbourg 1884*.
1886 Reinke, J., *Botan. Z.*, **44**, 161, 177, 193, 209, 225, 241.
1887 Engelmann, Th. W., *ibid.*, **45**, 393, 409, 425, 441, 457.
1904 Timiriazev, C., *Proc. Roy. Soc. London*, **72**, 424.
1913 Willstätter, R., and Stoll, A., *Untersuchungen über das Chlorophyll*.
Springer, Berlin, 1913.
1918 Willstätter, R., and Stoll, A., *Untersuchungen über die Assimilation
der Kohlensäure*. Springer, Berlin, 1918.
1922 Dixon, H. H., and Ball, N. G., *Sci. Proc. Roy. Dublin Soc.*, **16**, 435.
1923 Weigert, F., *Z. physik Chem.*, **106**, 313.
1925 Noack, K., *Z. Botan.*, **17**, 481.
1926 Noack, K., *Naturwissenschaften*, **14**, 383.
1931 Conant, J. B., Dietz, E. M., and Kamerling, S. E., *Science*, **73**, 268.
1932 Stoll, A., *Naturwissenschaften*, **20**, 955.
1933 Willstätter, R., *ibid.*, **21**, 252.
1934 Baby, E. C. C., and Morgan, L. B., *Nature*, **133**, 414.
Voerke, S. H., *Planta*, **21**, 251.
1935 Baly, E. C. C., *Proc. Roy. Soc. London B*, **117**, 218.
Blum, H. L., *Cold Spring Harbor Symposia Quant. Biol.*, **3**, 210.
Franck, J., *Chem. Revs.*, **17**, 433.
1936 Stoll, A., *Naturwissenschaften*, **24**, 53.
1937 Rabinowitch, E., and Weiss, J., *Proc. Roy. Soc. London A*, **162**, 251.
1938 Föckler, H., *Jahrb. wiss. Botan.*, **87**, 45.
1939 Ruben, S., Hassid, W. Z., and Kamen, M. D., *J. Am. Chem. Soc.*,
61, 661.
1941 Franck, J., and Herzfeld, K. F., *J. Phys. Chem.*, **45**, 978.
Baly, E. C. C., *Photosynthesis*. Longmans, Green, London, 1941.
Rabinowitch, E., *Ann. N. Y. Acad. Sci.*, **41**, 224.
1942 Ruben, S., Frenkel, A. W., and Kamen, M. D., *J. Phys. Chem.*, **46**,
710.
Norris, T. H., Ruben, S., and Allen, M. B., *J. Am. Chem. Soc.*, **64**,
3037.
1943 Emerson, R., and Lewis, Ch. M., *Am. J. Botany*, **30**, 165.
1944 Gaffron, H., *Biol. Rev. Cambridge Phil. Soc.*, **19**, 7.
Weiss, J., and Weil-Malherbe, H., *J. Chem. Soc.*, **1944**, 544.

CHAPTER 20

PHOTOSYNTHESIS AND RESPIRATION *

We have discussed, in the preceding chapters, the chemical mechanisms of photosynthesis and other photochemical processes sensitized by chlorophyll in the living cell, in the assumption that these processes occur in a separate catalytic apparatus and are essentially independent of the other metabolic activities of the organism. This assumption forms the basis of the quantitative study of photosynthesis, and it will be the subject of a critical discussion in volume II, chapter 26, which will form an introduction to the treatment of the kinetics of photosynthesis.

However, the same cells which engage in photosynthesis, also participate in many other metabolic activities, *e. g.*, fat synthesis and protein synthesis, as well as various degradation processes; and all these processes interfere, directly or indirectly, with the working of the photosynthetic mechanism. Even inside the chloroplasts, photosynthesis is only one of several simultaneous reactions which include, for instance, the polymerization and depolymerization of sugars, as well as the ubiquitous respiration, which takes place, with varying intensity, in all cells, tissues, and organs of a living organism.

Usually, respiration is mentioned in the investigations of photosynthesis only as a bothersome source of uncertainty. Since the net result of respiration is the reversal of photosynthesis, all measurements of the later process must be corrected for respiration. The difficulty of determining this correction was first mentioned in chapter 3 (page 32), and found particularly irksome in chapter 10 (pages 264 *et seq.*) when we tried to clarify the function of hydroxy acids in the photosynthesis of succulents, and in chapter 19 (Section A) when the interplay of photosynthesis and respiration was discovered to be further complicated by the superposition of a third process—photoautoxidation.

Despite the difficulty of a simultaneous determination of respiration and photosynthesis, the relationship between these two processes could be considered as merely incidental if it were not for some observations which appear to indicate the existence of a more intimate connection between the two catalytic mechanisms: we refer to the cyanide-resistant residual photosynthesis, described in chapter 12 (page 302) and the carotenoid-stimulated respiration, which will be discussed further below.

* Bibliography, page 570.

Although the nature of the links between the photosynthetic and the respiratory apparatus is as yet quite uncertain, they will undoubtedly be subject to closer study in the future. We have therefore assembled, in the present chapter, some experimental material pertaining to the relation between respiration and photosynthesis, even though a large part of this material may later prove to be irrelevant. For a more complete, but rather indiscriminate, collection of results pertaining to the relation between light and respiration in plants, we refer to the review by Weintraub (1944).

1. Effect of Respiration on Photosynthesis

Does *enhanced* respiration bring about enhanced photosynthesis? Does *inhibited* respiration cause an inhibition of photosynthesis? The answer to both questions seems to be in the negative, although the conclusion is by no means final.

Respiration can be enhanced, for example, by an external supply of appropriate substrates; van der Paauw (1932) found that the photosynthesis of *Hormidium* also is increased markedly in a 1% glucose solution. Gaffron (1939) stated, to the contrary, that "innumerable experiments" have provided no convincing evidence of a stimulating effect of this kind. It may be worth mentioning, in this connection, that, according to Emerson (1927), the additional respiration of *Chlorella*, caused by glucose feeding, is much more sensitive to cyanide than ordinary respiration. This is perhaps an indication that the mechanism of glucose-supported respiration in *Chlorella* is different from that of the normal respiration—either in its location (in the outermost layers of the cytoplasm) or in its catalytic mechanism. In either case, the relation of the "extra" respiration to photosynthesis may be different from that of normal respiration.

The respiration of certain algae (*e. g.*, *Scenedesmus* D3) can be *reduced* by 85% by cyanide without measurably affecting the rate of photosynthesis (*cf.* page 305). Gaffron (1937) pointed to this result as an argument in favor of essential independence of respiration and photosynthesis.

Spoehr and McGee (1923), who observed that leaves kept for a long period in the dark lost their capacity for both photosynthesis and respiration, saw in this fact a proof that the two processes are interrelated. However, a direct influence of respiration on photosynthesis can hardly be deduced from the mere fact of their simultaneous disappearance in starved tissues.

In chapter 13, we described the inhibition of photosynthesis after a period of "anaerobic incubation." This could be quoted as a proof that inhibition of respiration brings about, sooner or later, also an inhibition

of photosynthesis. However, according to Gaffron (*cf.* Chapter 6) the connection is only an indirect one. The primary effect of suppressed respiration is *fermentation* (reversed Pasteur effect!); the latter brings about the reduction of one or several components of the enzymatic mechanism of photosynthesis, so that, upon illumination, no oxygen can be released until these components have been regenerated.

The photooxidative reactions which inhibit photosynthesis under high oxygen pressures (Chapters 13, page 328, and 19, page 531) are distinct from normal respiration, since their rate is affected by changes in oxygen concentration between 10 and 100% (*cf.* Figs. 58 and 59). As described in chapter 19, this type of sensitized autoxidation must be localized in the chloroplasts, and can be attributed to reactions catalyzed by heat-resistant catalysts of low molecular weight, rather than by true respiratory enzymes.

While the above experiments provide no evidence of a chemical interaction between the catalysts or intermediates of respiration and the photosynthetic apparatus, an indication that respiration may contribute more than its end product—carbon dioxide—to photosynthesis can be found in the observation of Warburg (1919) and van der Paauw (1932) on cyanide inhibition of photosynthesis. According to these observers, cyanide reduces photosynthesis to the level of compensation, but does not lead to a net consumption of oxygen and evolution of carbon dioxide. The relevant experimental results and their interpretation were discussed in chapter 12 (pp. 302 *et seq.*). It was stated there that the phenomenon requires renewed study, but that if its reality would be confirmed it could be taken as an indication that carboxylic acids, formed as intermediate products of respiration, can be utilized as oxidants in photosynthesis, instead of the complexes $\{CO_2\}$, thus avoiding the cyanide-sensitive reaction by which $\{CO_2\}$ is formed from an acceptor and free carbon dioxide. This is at present merely a conjecture, but it is worth closer investigation; its plausibility is enhanced by the observation of Fan, Stauffer, and Umbreit (*cf.* Chapter 19, page 542) that other organic carbonyl compounds also can be used as "substitute oxidants" in photosynthesis.

2. Effect of Photosynthesis (and Photoxidation) on Respiration

Gaffron (1939) pointed out that photosynthesis can be completely inhibited by hydroxylamine without an apparent change in respiration, and concluded that respiration in green cells is not directly dependent on the immediate products or intermediates of photosynthesis. This is natural, since respiration occurs also in the nonphotosynthesizing cells of multicellular plants. However, it does not prove that intermediates

of photosynthesis are incapable of serving as substrates of respiration, particularly when the supply of the normal substrates is insufficient.

An interesting example of a partial identity of the enzymatic apparatus of respiration and photosynthesis is provided by certain bacteria. As suggested on page 111, these bacteria use the same enzymatic channels to convey hydrogen from organic donors to oxygen in the dark (respiration) and to carbon dioxide in light (photosynthesis). However, this duplication of enzymatic functions takes place in a part of the photosynthetic apparatus which is not usually active in green plants (the "hydrogenase system," *cf.* Chapter 6).

While a direct chemical link between the *intermediates* of photosynthesis and the substrates of respiration is possible, but not yet proved, a stimulation of respiration by the *end products* of photosynthesis—carbohydrates—has been established beyond doubt, and appears natural, in consideration of the fact that respiration can also be stimulated by externally supplied sugars.

The acceleration of respiration after a period of illumination was first observed by Borodin (1881) and Palladin (1893), and again by Warburg and Negelein (1922). The extent of this effect must depend on the capacity of the cells for disposing of the synthesized carbohydrates by translocation or by formation of insoluble polymers. This explains widely varying figures given by different authors for the respiration increases which followed a period of photosynthesis (*cf.* Table 20.I).

The experiments of Spoehr and McGee (1923) showed that respiration increases particularly strongly in leaves which have been previously kept in darkness for several days and have thus been depleted of carbohydrates; the effect on the respiration of nonstarved leaves is much weaker.

Gessner (1939) too, found that a "dark adaptation period" of several days is necessary to produce a stimulation of respiration by an illumination of 40,000 lux. He noticed, however, that a similar effect can be produced also by *ultraviolet light*, and concluded that it is not caused by photosynthesis, but represents a direct stimulation of the respiratory system. Ranjan (1940) found that ultraviolet light *inhibits* the respiration of *Eugenia jambolana*.

It seems probable that the same was true also of other results in Table 20.I, particularly those of Föckler (1938). Probably, a *direct* stimulation of respiration by short-wave light (ultraviolet, violet, and blue), which will be discussed on pages 567–569, is superimposed on the effect of accumulated photosynthates in all experiments except those performed in yellow or red light.

Although it seems plausible that respiration should be stimulated by the accumulated products of photosynthesis, it is by no means certain that all of the increased oxygen consumption, observed after a period of

TABLE 20.I
AFTEREFFECTS OF PHOTOSYNTHESIS ON RESPIRATION

Species	Conditions of illumination	Respiration increased by, %	Authority	
<i>Hormidium</i>	150-w. lamp 13-cm. distant	100	van der Paauw (1932)	
Beans	16 hrs., 7140 lux, after 64 hrs. starvation	196	Spoehr and McGee (1923)	
<i>Helianthus</i>	5 hrs., 7140 lux, without starvation	3		
Wheat	30 min., up to 1000 f.-c.	0	McAlister (1937)	
<i>Fontinalis antipyretica</i>	2 hrs. 10,000 lux, blue Same, red light	70 45	Bode (1940)	
<i>Ulva lactuca</i>	1 hr. sun	48 ^a	21 ^b	Föckler (1938)
<i>Cladophora rupestris</i>	2 hrs. gray sky	92	88	
<i>Fucus serratus</i>	2 hrs. sun	104	74	
<i>Laminaria digitata</i>	2 hrs. 1000-w. lamp	86		
<i>Ceramium rubrum</i>	1 hr. gray sky	111	68	
<i>Fontinalis</i>	2 hrs. 1000-w. lamp	126	127	
<i>Potomageton lucens</i>	2 hrs. 1000-w. lamp	229	122	
<i>Elodea crispera</i>	2 hrs. 1000-w. lamp	81	26	
<i>Trichomanes radicans</i>	3 hrs. daylight	41	27	
Aquatic plants (<i>Potomageton</i> , <i>Elodea</i> , etc.)	4 hrs., 40,000 lux after more than 16 hrs. of dark adaptation	Up to 50%	Gessner (1937, 1939)	

^a First hour after the illumination period.

^b Second hour after the illumination period.

illumination, can be attributed to stimulated respiration. Part of this absorption may be caused by oxidations in the photosynthetic mechanism, analogous to those which were assumed (in Chapter 19) to be responsible for the photoautoxidation in intense light and under high oxygen pressure. The components and intermediates of the photosynthetic apparatus may well be capable not only of a photochemical, but also of a slow non-photochemical autoxidation.

The existence of autoxidizable intermediate products formed by photochemical processes in the chlorophyll apparatus is demonstrated by the *aftereffects* of *photoautoxidation* (which obviously cannot produce carbohydrates). Whether the photoxidation had been brought about by

starvation (as in the experiments of van der Paauw 1932, and Franck and French 1941), or by excess oxygen (as in the work of McAlister and Myers 1940), or by excessive illumination (Myers and Burr 1940), the

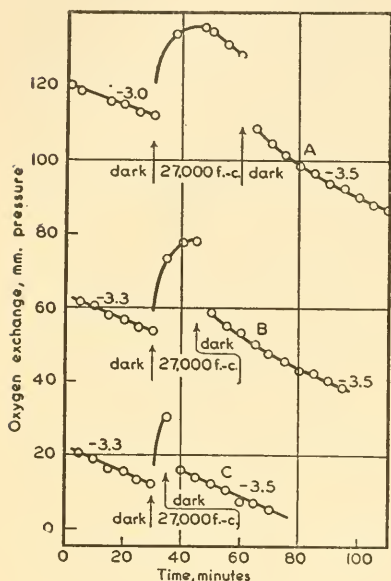

FIG. 62.—Increased oxygen consumption in the dark after a period of photautoxidation (after Myers and Burr 1940). The effect is shown by the curvature in A and B.

return to darkness always finds the oxygen consumption enhanced (*cf.* Fig. 62). It is improbable that this increased absorption of oxygen is due to an increase in normal respiration; probably, photooxidation in the chloroplasts leaves a residue of “semioxidized” intermediate products whose oxidation can be achieved in the dark without the participation of the respiratory enzymes. According to Franck and French (1941) the “aftereffect” of photooxidation of CO_2 -starved leaves is small, unless the leaves have been supplied with glucose during the exposure (*cf.* Table 20.II).

3. Effect of Light on Respiration

In chapter 19, we suggested that the phenomena of photautoxidation in starved or narcotized leaves in the presence of excess oxygen or in very intense light are brought about by a cooperation of the primary

photochemical apparatus of photosynthesis with the action of heat-resistant catalysts (*cf.* Gaffron 1939, 1940, and Franck and French 1941) and has nothing in common with the enzymatic mechanism of ordinary

TABLE 20.II
AFTERAFFECTS OF PHOTOXIDATION (AFTER FRANCK AND FRENCH)

Substrate	Oxygen consumption (in relative units)		
	Before exposure	During exposure (photoxidation)	After 30 min. exposure
Without sugar	8	16.3	8.5
With sugar	12.1	20.5	14.5 ^a 22.5 ^b 24.0 ^c

^a After a first exposure for 25 minutes.

^b After two exposures of 25 minutes, each with 2 hours of darkness between them; final high rate maintained for 90 minutes.

^c After the third exposure; rate maintained for 30 minutes.

respiration (as this was suggested by van der Paauw in 1932). If this view is adopted, we may still ask whether illumination has any influence on normal respiration as well (other than stimulation by accumulated photosynthates). The effect for which we are looking may consist either in direct "photorespiration," *i. e.*, a photochemical activation of the respiratory system which sets in immediately upon illumination and disappears abruptly upon return to darkness; or in an indirect stimulation which sets in slowly in light and persists for some time in the dark. The first effect is difficult to distinguish from decreased photosynthesis; the second can easily be confused with accelerated respiration caused by the accumulated products of photosynthesis. However, it was mentioned on page 564, that Gessner (1939) concluded, from the effect caused by ultraviolet light, that the "persistent" light stimulation of respiration, is not—or not entirely—attributable to an accumulation of sugars. The same conclusion was reached by Föckler, and Emerson and Lewis, who also found that the dependence of light-stimulated respiration on wave length is different from that of photosynthesis.

Montfort and Föckler (1938) and Föckler (1938) noticed that the respiration of *nonchlorophyllous* plant tissues, *e. g.*, roots of *Vicia faba*, shoots of asparagus, fruit skins, etc., is increased from 20 to 100% during the first hour of illumination. On return to darkness, oxygen consumption returned to its original level, sometimes quite rapidly. The responsibility for this stimulation was found to lie with the radiations below 500 m μ , a relation which indicates the participation of a yellow pigment. No effects were observed in infrared light, whereas a vigorous effect occurred in the ultraviolet. Föckler found a parallel between the "action spectrum" of "photorespiration" and the absorption spectrum of etiolated leaves as measured by Seybold (reproduced in Chapter 22, Vol. II).

Föckler thought that a similar direct effect of light on respiration could be detected also in chlorophyllous tissues—where stimulated respiration often is difficult to distinguish from inhibited photosynthesis—by its dependence on wave length. However, in fully active green tissues, photosynthesis is much too intense, compared with respiration, to make such measurements possible. Föckler therefore inhibited the photosynthesis (of *Potamogeton lucens*) by narcotics in concentrations which did not affect respiration (0.06% phenylurethan), and measured the gas exchange in light of different colors. He found the strongest oxygen uptake in blue light, and almost no uptake in green and red light. One possible, but improbable explanation of these results is that photosynthesis is completely inhibited by 0.06% urethan, while respiration is inhibited by red, and stimulated by blue light. A more probable explanation is that the inhibition of photosynthesis by 0.06% phenyl-

urethan is incomplete and only reduces it roughly to the compensation point; red (and green) light do not affect respiration, and therefore leave the gas exchange close to balance, whereas blue light stimulates respiration and thus causes a net consumption of oxygen.

These results have been confirmed by the more precise observations of Emerson and Lewis (1943). They found that, in *Chlorella*, the oxygen consumption in the dark is enhanced considerably after a short illumination with light belonging to the narrow band of 440–530 $m\mu$, with a maximum effect at 470 $m\mu$. The increase in the net oxygen consumption in light with time, illustrated by figure 63 (and occurring,

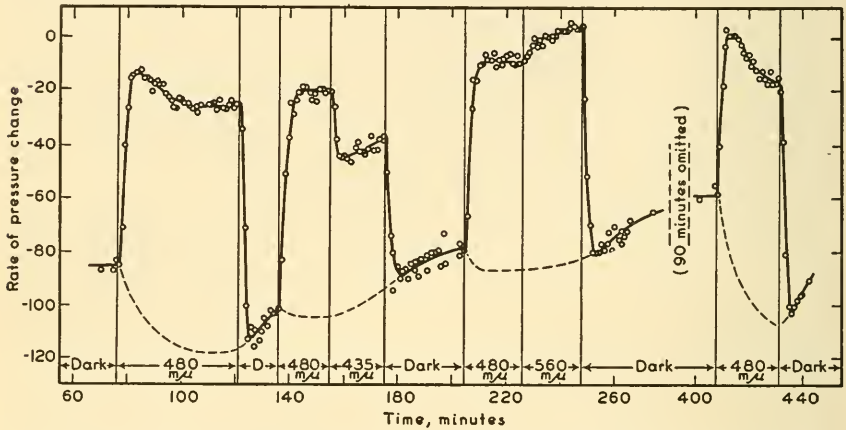

FIG. 63.—Effect of light on oxygen consumption (after Emerson and Lewis 1943). The rate of oxygen exchange is based on readings at one-minute intervals. Light periods are indicated at the bottom by the wave length of the light used. Intensities: 8.0×10^{-8} einsteins per $cm.^2$ per minute at 480 $m\mu$; 4.1×10^{-8} at 435 $m\mu$; and 7.3×10^{-8} at 560 $m\mu$. Broken line indicates the probable development of respiration during the illumination periods. The cells (260 $mm.^3$ *Chlorella* cells in 25 ml. carbonate buffer) were in the dark for about 75 minutes preceding the observations.

according to this figure, only at 480 $m\mu$ and not at 435 $m\mu$ or 560 $m\mu$), indicates that the rate of respiration increases gradually during the illumination, the maximum observed increase (shown on the extreme right) being of the order of 70%. (It must be noted that the light intensity used in these experiments was very weak. The net gas exchange in figure 63 never exceeded the compensation point, so stronger effects may perhaps occur in more intense light.)

According to Emerson and Lewis, the light-stimulated oxygen consumption is particularly strong in *Chlorella* cells grown in neon light. These cells are yellowish green in color (indicating a low concentration of chlorophyll). Some cultures showed almost no effect; the same was true of the blue-green cells of *Chroococcus*.

It thus seems probable that light absorbed by the *carotenoids* has a specific stimulating influence on oxygen consumption, which is, however, not a *direct* sensitization, since it sets slowly in light and persists for several minutes in the dark.

Whether the effect of *ultraviolet* light on the respiration of green cells, observed by Gessner, can be attributed to the same cause is an open question; the stimulation of respiration in *colorless* tissues, observed by Montfort and Föckler, seems to point to a different mechanism, since these tissues contain no carotenoids (but may contain water-soluble pigments of the flavonol type).

We now come to the problem of "photorespiration" proper, that is, a direct photochemical acceleration of normal respiration which disappears in the dark as instantaneously as does photosynthesis. The possibility of such an effect is a nightmare oppressing all who are concerned with the exact measurement of photosynthesis, and various attempts have been made to bring it to light. The problem is: how to determine the true rate of respiration in green plant cells *during the illumination*. Noddack and Kopp (1940) measured the light curves of photosynthesis of *Chlorella* at different temperatures and inquired whether the subtraction of "dark respiration" (R_d) from the apparent photosynthesis at low light intensities (P_a) leaves a residue, $P = P_a - R_d$, which is *independent of temperature*, as this could be expected for true photosynthesis at low light intensities (*cf.* Vol. II, Chapter 31). They found slight deviations from constancy, but in the direction which indicated a somewhat *decreased*, rather than stimulated, respiration in light. In similar experiments of Emerson and Lewis (1940), temperature was found to have no effect at all on the calculated quantum yield.

According to Gaffron (1939), the respiration of cells poisoned with *hydroxylamine* (which inhibits photosynthesis and does not affect respiration) continues in light at the same rate as in the dark. The results obtained with *cyanide* are more complex because this poison acts on both photosynthesis and respiration (*cf.* Chapter 12). In most plants—both higher plants and algae, including *Chlorella*—photosynthesis is more sensitive to cyanide than respiration; in certain species, however, as in some strains of *Scenedesmus*, the relation is reversed. Thus, hydrocyanic acid should afford an opportunity to study both respiration in light with poisoned photosynthesis, and photosynthesis with poisoned respiration. However, experiments of the first kind do not give the same simple results as those with hydroxylamine. In intense light, photosynthesis is so much stronger than respiration that a small residual capacity for photosynthesis which remains in the cyanide-poisoned cells is sufficient to prevent an exact measurement of respiration. Warburg (1919) observed that photosynthesis cannot be reduced by cyanide

poisoning below the compensation point; and even though this result is controversial (*cf.* page 309), it certainly is true that it has been impossible to stifle photosynthesis completely by cyanide without using such concentrations of the poison which would affect respiration as well.

Gaffron (1937, 1939) had more success with the reverse procedure—quenching the respiration of *Scenedesmus*, without damaging photosynthesis. Typical results are shown in Table 20.III. The fact that “true

TABLE 20.III

EFFECT OF CYANIDE ON RESPIRATION AND PHOTOSYNTHESIS IN SCENEDESMUS
(0.09 ml. cells in phosphate buffer, pH 5.9, 21° C.; air with 5% CO₂)

Conditions of experiment	[HCN], mole/l. × 10 ⁵			
	0	2	10	50
Dark respiration (in mm. ³ O ₂ in 20 min.), R_d	-54	-27	-13	- 2
Net gas exchange at 400 lux (15 min. illumination + 5 min. dark), $P + R_1$	-23	+11	+18	+29
$P + R_1 - R_d$	31	38	31	31

photosynthesis,” calculated in the last line of table 20.III by the subtraction of dark respiration from the net gas exchange in light, remains practically constant, while respiration itself drops to 4% of its original value, can be considered as an indication that respiration in light is the same as in the dark. (Strictly speaking, the constancy of the figures in the last row proves only that the difference $R_1 - R_d$ is independent of cyanide concentration; it is feasible, but improbable that this difference is constant, but not zero.)

Although none of the experiments described above provides a final proof of the nonexistence of true “photorespiration,” the least that can be stated is that no evidence of such a phenomenon has as yet been found (except perhaps in ultraviolet light), and that all definitely established cases of light-stimulated respiration were of the “persistent” type, and could be attributed either to an accumulation of sugars or to an indirect photochemical effect of blue-violet light absorbed by the carotenoids.

Bibliography to Chapter 20

Photosynthesis and Respiration

- 1881 Borodin, I., *Mém. acad. sci. St. Pétersbourg*, VIII, 28, No. 4.
 1893 Palladin, W., *Commun. Univ. Kharkov*, 1893. *Cf. Botan. Zentr.*, 58, 375, 1894.
 1919 Warburg, O., *Biochem. Z.*, 100, 230.
 1922 Warburg, O., and Negelein, E., *Z. physik. Chem.*, 102, 235.

- 1923 Spoehr, H. A., and McGee, J. M., *Carnegie Inst. Wash. Pub.*, No. 325.
- 1927 Emerson, R., *J. Gen. Physiol.*, **10**, 469.
- 1932 van der Paauw, F., *Rec. trav. botan. néerland.*, **29**, 497.
- 1937 McAlister, E. D., *Smithsonian Inst. Pub. Misc. Collection*, **95**, No. 24.
Gaffron, H., *Biochem. Z.*, **292**, 241.
Gessner, F., *Jahrb. wiss. Botan.*, **85**, 267.
- 1938 Montfort, C., and Föckler, H., *Planta*, **28**, 515.
Föckler, H., *Jahrb. wiss. Botan.*, **87**, 45.
- 1939 Gessner, F., *Planta*, **29**, 165.
Gaffron, H., *Biol. Zentr.*, **59**, 302.
Gaffron, H., *Cold Spring Symposia Quant. Biol.*, **7**, 377.
- 1940 Gaffron, H., *Am. J. Botany*, **27**, 204.
Emerson, R., and Lewis, Ch. M., *Carnegie Inst. Yearbook*, **39**, 154.
Bode, O., *Jahrb. wiss. Botan.*, **89**, 208.
Noddack, W., and Kopp, Ch., *Z. physik. Chem. A*, **187**, 79.
Myers, J., and Burr, G. O., *J. Gen. Physiol.*, **24**, 45.
McAlister, E. D., and Myers, J., *Smithsonian Inst. Pub. Misc. Collections*, **99**, No. 6.
Ranjan, S., *J. Indian Botan. Soc.*, **19**, 19, 105.
- 1941 Franck, J., and French, C. S., *ibid.*, **25**, 309.
- 1943 Emerson, R., and Lewis, Ch. M., *Am. J. Botany*, **30**, 165.
- 1944 Weintraub, R. L., *Botan. Rev.*, **10**, 383.

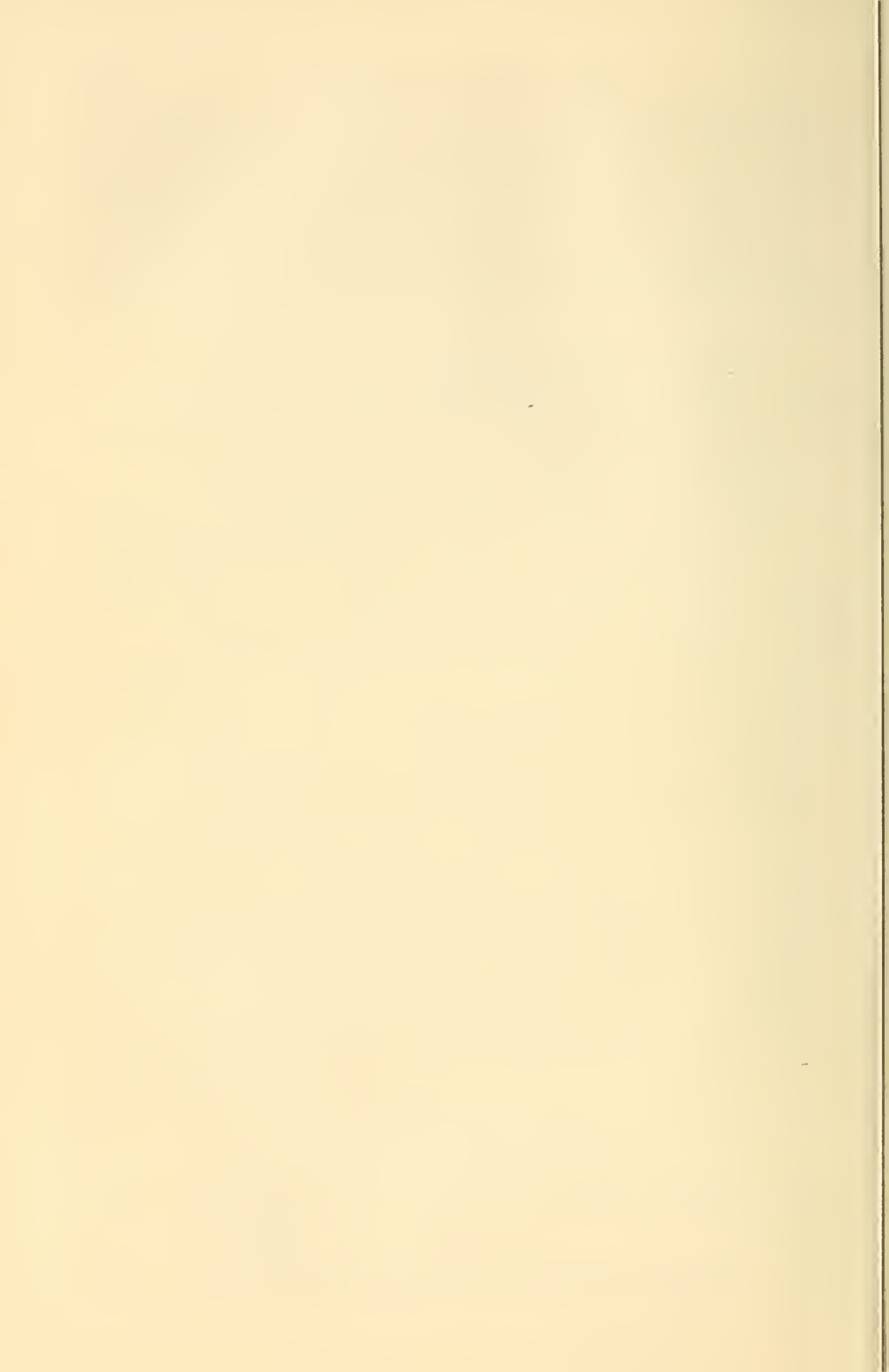

AUTHOR INDEX OF THE MAIN INVESTIGATIONS DESCRIBED IN VOLUME I *

A

- Albers, V. M. *See* Knorr, H. V.
Allen, M. B. *See* Norris, T. H.
Allison, F.: Chlorophyll-sensitized oxidation-reductions *in vitro*, 509, 512.
Arens, K.: Directed transfer of ions through leaves, 197, 200.
Arnold, W.: Effect of ultraviolet light on photosynthesis, 345-346. *See also* Emerson, R.
Aufdemgarten, H.: Pickup of carbon dioxide after a period of photosynthesis, 206, 207.

B

- Baeyer, A. v.: Formaldehyde as intermediate in photosynthesis, 48, 51.
Baly, E. C. C.: Experiments on photosynthesis *in vitro*, 85-88.
Barker, H. A.: Photosynthetic quotient of oil-producing diatoms, 33-34. *See also* Carson, S. F.
—, Ruben, S., and Kamen, M. D.: Metabolism of methane bacteria, 121-123; reversibility of biological decarboxylations, 185, 209.
Baur, E., and coworkers: Dismutation as mechanism of photosynthesis, 248; experiments on photosynthesis and other sensitized oxidation-reductions *in vitro*, 68, 69, 82, 85, 89-94, 496; sensitization rule, 505; sensitized photodecomposition of water, 72-74, 78.
Beijerinck, M. W.: Oils as products of photosynthesis in diatoms, 43.
Bennet-Clark, T. A.: Acid metabolism of plants, 264-266.
Bergman, B. *See* Euler, H. v.
Bernard, C.: Narcotization of photosynthesis, 320.
Berthelot, D., and coworkers: Decomposition of water and carbon dioxide in ultraviolet light, 71, 81, 83.
Blackman, F. F.: Saturation of photosynthesis with light and carbon dioxide attributed to a nonphotochemical enzymatic reaction, 172.
Bodnár, J., and coworkers: Plant feeding with formaldehyde, 259.
Böhi, J.: Photochemical reactions with chlorophyll, and chlorophyll-sensitized reactions of azo dyes, 503-508, 509-512.
Bokorny, Th.: Feeding of algae with low molecular weight compounds, 257, 260.
Boresch, K.: Pigments and chromatic adaptation of algae, 415, 417, 421, 425, 429.
Bot, G. M.: Separation and analysis of chloroplastic matter, 369-375, 390, 391, 412.
Boussaingault, T. B.: Photosynthetic quotient, 24, 31, 33.
Burr, G. O.: Carbonic anhydrase in plants, 199, 380. *See also* Myers, J.

C

- Carson, S. F., Foster, J. W., Ruben, S., and Barker, H. A.: Biological decarboxylation studied by means of radioactive indicators, 185-186.
Chibnall, A. C.: Leaf proteins and lipoids, 369, 372-375.

* Complete author index will be found at the end of Volume II.

- Conant, J. B., and co-workers: Allomerization of chlorophyll an oxidation, 460; is allomerization a step in photosynthesis?, 553; dehydrogenation of chlorophyll, 463; oxygen uptake by chlorophyll, 460-461; structure of chlorophyll, 438.
- Curtius, Th., Franzen, H., and coworkers: Investigation of volatile leaf components, 252-254.

D

- Dhar, N. R., and coworkers: Experiments on photosynthesis *in vitro*, 88-89.
- Dörrestein, R. *See* Wassink, E. C.
- Doutreligne, Soeur: Grana photographs, 358-359, 362.
- Duggar, B. M. *See* Dutton, H. J.
- Dutton, H. J., Manning, W. M., and Duggar, B. M.: Carotenoid-sensitized fluorescence of chlorophyll, 476, 515, 522, 558.

E

- Egle, K. *See* Seybold, A.
- Eisenbeck, Nees v.: Discovery of phycocyanin, 417, 476.
- Emerson, R.: Can light inhibition of photosynthesis be attributed to carbon dioxide deficiency?, 532; inhibition of photosynthesis by cyanide, 304-305; photosynthesis in chlorotic plants, 338-339.
- Emerson, R., and Arnold, W.: Culture of chlorophyll-deficient algae, 428, 430; photosynthesis in flashing light, 307.
- and Green, L.: Effect of pH changes on photosynthesis, 339-340; photosynthesis and catalase activity of algae, 284-285.
- and Lewis, C. M.: Carbon dioxide "gush" in *Chlorella*, 167, 207; effect of blue-violet light on respiration, 557, 567-569.
- Emerson, R. L., Stauffer, J. F. and Umbreit, W. W.: Is light energy first converted in photosynthesis into phosphate bond energy?, 227-229.
- Engelmann, Th. W.: Discovery of bacterial photosynthesis, 99; depth distribution of colored algae—a consequence of chromatic adaptation, 420; no photosynthesis without chlorophyll, 558; no photosynthesis without life, 61.
- and Gaidukov, N. I.: Chromatic adaptation of algae in colored light, 424-427.
- Ericsson-Quensel, I. B. *See* Svedberg, Th.
- Euler, H. v.: Chlorophyll and heredity, 431.
- Euler, H. v., Bergman B., and Hellström, H.: Chlorophyll content of single chloroplasts, 411.
- Ewart, A. J.: Inhibition of photosynthesis by excess light, 532.
- Eymers, J. G., and Wassink, E. C.: Metabolism of purple bacteria, 99, 101, 104, 105.

F

- Fan, C. S., Stauffer, J. F., and Umbreit, W. W.: Photosynthetic production of oxygen by algae with ferric salts or organic compounds as substitutes for carbon dioxide, 541-543.
- Faurholt, C.: Carbon dioxide hydration, amination, and alcoholation equilibria, 175, 176, 177, 180, 181.
- Fischer, F. G., and Löwenberg, K.: Structure of phytol, 439-440.
- Fischer, H., and coworkers: Dehydrogenation of chlorophyll 463; enolization of chlorophyll and phase test, 459; mechanism of allomerization, 461; porphyrin synthesis, 445; structure of bacteriochlorophyll, 444-445; structure of chlorophyll, 438, 442; structure of protochlorophyll, 404, 445.
- Fischgold, H. *See* Weiss, J.
- Fishman, M. M. *See* Moyer, L. S.

- Fleischer, W. E.: Photosynthesis in chlorotic plants, 337-339, 428.
- Föckler, H.: Effect of violet and ultraviolet light on photosynthesis and respiration, 564-565; photooxidation in shade plants exposed to strong light, 533, 535. *See also* Montfort, C.
- Foster, J. W.: Oxidation of isopropanol to acetone by purple bacteria in light, 107. *See also* Carson, S. F.
- Franck, J.: Interpretation of cyanide inhibition of photosynthesis, 307; interpretation of photochemical carbon dioxide gush, 167; multiplicity of nonphotochemical reactions in photosynthesis, 172-173, 285. *See also* Livingston, R.; Weller, S.
- and French, C. S.: Aftereffects of photooxidation, 566; photooxidation in carbon dioxide starved plants, 527-531, 536; photooxidation poisons the photosynthetic apparatus, 329, 532, 536.
- , French, C. S., and Puck, T. T.: Fluorescence and photosynthesis, nonlimiting catalytic reactions in photosynthesis, 167, 307, 310.
- and Herzfeld, K. F.: Delayed photochemical dissociation of large molecules, 484; first (four quanta) theory of photosynthesis, 287-290; second (eight quanta) theory of photosynthesis, 154, 155, 162-164, 545, 550, 555.
- and Livingston, R.: Tautomerization of chlorophyll in solution, 490-491, 493.
- and Pringsheim, P.: Oxygen production by first light flash after anaerobiosis, demonstrated by phosphorescence quenching method, 327.
- and Wood, R. W.: Dissociation within the sensitizer-substrate complex as mechanism of sensitization by chlorophyll 521; fluorescence and primary dissociation of chlorophyll in solution, 484.
- Franzen, H. *See* Curtius, Th.
- French, C. S.: Pigments and photochemical metabolism of bacteria, 101, 110, 388. *See also* Franck, J.
- Frenkel, A. W.: Location of carbon dioxide acceptor in the cell, 204. *See also* Ruben, S.

G

- Gaffron, H.: Bacteriochlorophyll as sensitizer *in vitro*, 514-515; effect of hydroxylamine and other inhibitors on adaptation, de-adaptation, and photoreduction in algae, 313, 315, 318-319; inhibition of photosynthesis and photoreduction by cyanide, 305-311; inhibition of photosynthesis by oxygen deficiency, 327-329; long-lived active states of autoxidation substrates, 516; metabolism of anaerobically incubated algae (adaptation, de-adaptation, photoreduction, oxyhydrogen reaction), 128-148; metabolism of purple bacteria, 101, 104, 106, 108-110; nonoccurrence of hydrogen peroxide as intermediate in photosynthesis and chemosynthesis, 286; peroxide formation and inhibition of photosynthesis by photooxidation, 293, 508, 511; photosynthesis of algae in which respiration is completely inhibited, 285-286, 305-306, 570; primary photochemical process in purple bacteria, 168-170; quantum yield of chlorophyll-sensitized autoxidations *in vitro*, 509, 513, 518; relation of photosynthesis and respiration, 562, 563, 569, 570; specific poisoning of different partial reactions in photosynthesis, 300. *See also* Rieke, F. F.
- Gaidukov, N. I. *See* Engelmann, Th. W.
- Gessner, F.: Effect of ultraviolet light on respiration, 564, 569.
- Ghosh, J. C., and Sen-Gupta, S. B.: Quantum yield of chlorophyll-sensitized reaction of methyl red with phenylhydrazine, 513-514.
- Godnev, T. N., and Kalishevich, S. V.: Chlorophyll content of single chloroplasts, 411.
- Granick, S.: Separation and analysis of chloroplastic matter, 369-375.
- Green, L. *See* Emerson, R.
- Greenfield, S. S.: Inhibition of photosynthesis by various cations and anions, 340-342.
- Griessmeyer, H. *See* Noack, K.

H

- Haberlandt, G.: Number of chloroplasts in a cell, 357.
 Hales, S.: Aerial nutrition of plants, 12.
 Hanson, E. A.: Chlorophyll monolayers, 449, 451; x-ray analysis of chlorophyll, structure 448.
 Harder, R.: Combined chromatic and intensity adaptation of algae, 421; combined effects of light intensity and color on pigment system, 425.
 Hassid, W. Z. *See* Ruben, S.
 Heilbron, I. M., and coworkers: Algal carotenoids, 415-416, 472.
 Heitz, E.: Grana in chloroplasts 358-362.
 Hellström, H. *See* Euler, H. v.
 Herzfeld, K. F. *See* Franck, J.
 Hill, R., and Scarisbrick, R.: Isolated chloroplasts as sensitizers for photochemical oxidation of water by ferric salts, 63-67, 541.
 Hille, J. van: Decline of photosynthesis in aged cultures of algae, 285, 332, 339.
 Honert, T. van: Inhibition of photosynthesis by alkaline buffers, 198.
 Hoppe-Seyler, F.: Relation of chlorophyll to hemin, 438.
 Hubert, B.: Chloroplast model, 368, 391-394.

I

- Ingen-Housz, J.: Discovery of role of light and green color in liberation of oxygen by plants, 17-19; discovery of carbon assimilation from air by plants, 22-23.
 Inman, O. L.: Oxygen liberation by isolated chloroplasts, 62-63.

J

- Joslyn, M. A., and Mackinney, G.: Kinetics of chlorophyll conversion to pheophytin, 467.

K

- Kalishevich, S. V. *See* Godnev, T. N.
 Kamen, M. D. *See* Ruben, S.; Barker, H. A.
 Karrer, P., and coworkers: Bacterial carotenoids, 416, 472, 473, 475, 480.
 Katz, E., and Wassink, E. C.: Colloidal bacteriochlorophyll extracts, 386, 495, 502.
See also Wassink, E. C.
 Kausche, G. A., and Ruska, H.: Electron microscope study of chloroplasts, 363-365.
 Kautsky, H.: Metastable oxygen as energy carrier in sensitized reactions, 514-515.
 Kennedy, S.: Chlorophyll and photosynthesis in magnesium-deficient plants, 338, 428.
 Kiessling, W. *See* Noack, K.
 Klein, G., and Werner, O.: Formaldehyde assay in plants, 256.
 Knorr, H. V., and Albers, V. M.: Fading of chlorophyll fluorescence with time in different media, 495, 497, 501, 506.
 Kohn, H. I.: Iodoacetyl as inhibitor of photosynthesis, 284, 318-319.
 Krebs, H. A., Martius, C., and coworkers: Citric acid metabolism, 268.
 Krossing, G.: Enzymes in chloroplasts, 379-381.
 Küster, E.: Birefringence of chloroplasts 365, 366.
 Küster, W.: Chlorophyll structure, 440-441.
 Kützing, F. T.: Discovery of phycoerythrin, 417, 476.
 Kuhn, R., and Winterstein, A.: Reduction of chlorophyll, 457, 458.
 Kylin, H.: Algal pigments, 415, 417, 418, 476, 477.

L

- Lavoisier, P. A.: Composition of air and theory of oxidation, 12; "fixed air" a compound of carbon and oxygen, 13.
- Lemberg, R.: Investigation of algal chromoproteids, 417, 418, 476-479.
- Lewis, Ch. M. *See* Emerson, R.
- Liebich, H. *See* Noack, K.
- Liebig, J. v.: Plant acids as intermediates in photosynthesis, 35, 51; total yield of photosynthesis on earth, 5.
- Livingston, R.: Reversible bleaching of chlorophyll, 486-493. *See also* Franck, J.
- and Franck, J.: Photosynthesis under high carbon dioxide pressures, 331.
- Löwenberg, K. *See* Fischer, F. G.
- Lubimenko, V. N.: Mechanism of chlorophyll formation in plants, 404-411, 431; ombrophilic and heliophilic plants, 533, 534; preparation of colloidal chlorophyll extracts from plants, 384-388.
- and Shcheglova, O. A.: Effect of wounding on photosynthesis, 343.
- Lwoff, A.: Organic nutrition of green flagellates, 261-262.

M

- McAlister, E. D.: Pickup of carbon dioxide in dark after a period of photosynthesis, 206-208; aftereffects of photosynthesis on respiration, 565, 566.
- and Myers, J. Inhibition of photosynthesis by excess oxygen, 328, 531.
- MacKinney, G.: Carotene assay in leaves, 415, 471. *See also* Joslyn, M. A.
- Manning, W. M., and Strain, H. H.: Chlorophyll *d* in red algae, 407. *See also* Dutton, H. J.; Strain, H. H.
- Maquenne, L., and coworkers: Photosynthetic quotient, 32-33.
- Martius, C. *See* Krebs, H. A.
- Mayer, Robert: Conversion of light into chemical energy by plants, 24-26.
- Mazé, P.: Volatile components of leaves, 251, 254.
- Menke, W.: Analysis of chloroplast ash, 376-377; association of carotenoids with proteins in the cell, 393, 476; chlorophyll content of chloroplastic matter, 390, 411-412; chloroplasts as thixotropic bodies, 358; laminary structure and birefringence of chloroplasts, 362-363, 365-367; separation and analysis of chloroplastic matter, 368-376, 451.
- Meyer, A.: Acidification cycle of succulents, 264-265; assimilatory secretion, 43, 254; size of chloroplasts, 357; total volume of chloroplasts in a leaf, 371.
- Meyer, K.: Chlorophyll-sensitized photooxidations *in vitro*, 508, 509, 511.
- Meyerhof, O.: Metabolism of nitrifying bacteria, 119, 225.
- Möbius, M.: Size of chloroplasts, 357.
- Möhl, H. v.: Starch grains in chloroplasts, 42.
- Molisch, H.: Metabolism of purple bacteria, 100-102; oxygen liberation by dried leaf powders, 62-63; phase test of chlorophyll, 459; reduction of silver nitrate in chloroplasts, 254, 270-271; phycobilins as chromoproteids, 417, 476.
- Mommaerts, W. E. H. M.: Separation and analysis of chloroplastic matter, 361, 369, 370, 380, 390-391.
- Montfort, C.: Light curves and light injury of deep water algae, 533, 536, 537.
- and Föckler, H.: Light-stimulated respiration, 567.
- Moore, B.: Iron in chloroplasts, 376.
- Mothes, K., and Sagromsky, H.: Chromatic adaptation of diatoms, 425.
- Moyer, L. S., and Fishman, M. M.: Electrophoresis of chloroplast proteins, 374, 386, 387.
- Myers, J., and Burr, G. O.: Aftereffects of photooxidation in algae, 566; photosynthesis and photooxidation in very intense light, 533-536. *See also* McAlister, E.

N

- Nakamura, H., and coworkers: Adaptation of algae to hydrogen sulfide, 128; hydrogenase in bacteria, 131; metabolism of purple bacteria, 100, 101, 110; poisoning of photosynthesis and of catalase by cyanide, hydroxylamine, and hydrogen sulfide, 284, 285, 305, 306, 311, 316, 319.
- Nash, A. C.: Analysis of chloroplastic matter, 358, 361, 369-372, 386, 390-391, 394; analysis of leaf ash, 376-378; ascorbic acid in chloroplasts, 269-270; chloroplast enzymes, 199, 379-381.
- Negelein, E.: Inhibition of photosynthesis by hydrogen sulfide, 315-316. *See also* Warburg, O.
- Niel, J. C. van. *See* Van Niel.
- Noack, K.: Chlorophyll adsorbates on proteins, 388; chlorophyll bleaching and photoxidation in poisoned and starved plants, 528-529, 538; chlorophyll-sensitized oxidation of benzidine *in vitro* and *in vivo*, 528; photoreduction of flavonols *in vivo*, 541; simple iron compounds as catalysts in photosynthesis, 317-318, 375.
- , Griessmeyer, H., and Liebich, H.: Iron in chloroplasts, 377-378.
- and Kiessling, W.: Protochlorophyll conversion to chlorophyll, 405.
- Norris, T. H., Ruben S., and Allen, M. B.: Photosynthesis with tritium, 557.

O

- Oltmanns, F., Vertical distribution of algae as consequence of adaptation to light intensity, 421, 425, 426.

P

- Paauw, F. van der: Cyanide inhibition and cyanide-resistant photosynthesis, 302-309, 563; photoxidation in starved plants, 527-528.
- Paechnatz, G.: Plant cannot be fed on formaldehyde, 260.
- Pirson, A.: Ionic deficiency effects on photosynthesis and chlorophyll, 336-340, 428-429, 541.
- Porret, D., and Rabinowitch, E.: Reversible bleaching of chlorophyll, 486-493, 497. *See also* Weiss, J.
- Pratt, R. *See* Trelease, S. F.
- Priestley, Joseph: Discovery of air purification by plants, 13-17.
- Pringsheim, P. *See* Franck, J.
- Pucher, G. W. *See* Vickery, H. B.
- Puck, T. T. *See* Franck, J.

R

- Rabinowitch, E.: Effect of light on equilibrium of chlorophyll and ferric chloride, 488-489; energy dismutation as possible mechanism of photosynthesis and chemosynthesis, 161, 164-166, 233-239, 552; mechanism of reversible bleaching and brown phase of chlorophyll, 460; primary process in ionic solutions, 72-77; relation between sensitization and fluorescence *in vitro* and *in vivo*, 545-548; reversible reaction of chlorophyll with solvents as possible primary step in sensitization, 491-493; uptake of carbon dioxide and other gases by chlorophyll, 450-455. *See also* Porret, D.
- and Weiss, J.: Chlorophyll as catalyst in the dark, 69, 504; reaction of chlorophyll with ferric and ceric salts, 464-467, 490, 506, 556, reversible bleaching of dyes by iodide ions and ferrous ions, 517.
- Reinke, J.: Association of chlorophyll with proteins *in vivo*, 384, 503; chlorophyll as sensitizer of photosynthesis, 548-549; light saturation of photosynthesis, 532.

- Reman, G. H. *See* Wassink, E. C.
- Rieke, F. F., and Gaffron, H.: Photoreduction and photosynthesis in flashing light, 133, 169, 310.
- Riley, G. A.: Photosynthetic production of the plankton, 6-7.
- Rothemund, P.: Chlorophyll reduction irreversible, 457; synthesis of porphin, 445-446.
- Ruben, S.: All oxygen liberated in photosynthesis originates in water 54-55, 106; phosphorylation as possible correlate to carboxylation and carboxyl reduction in photosynthesis, 150, 201, 226-227, 229; reduction intermediates in photosynthesis studied by means of radioactive carbon, 241-244. *See also* Barker, H. A.; Carson, S. F.; Norris, T. H.
- , Hassid, W. Z., and Kamen, M. D.: Exchange of carbon in chlorophyll during photosynthesis, 557.
- , Frenkel, A. W., and Kamen, M. D.: Exchange of magnesium in chlorophyll *in vivo*, 467, 555.
- and Kamen, M. D.: Radioactive carbon as indicator in photosynthesis, 37; radioactive carbon as indicator of carbon dioxide uptake in dark by plants, 202-203, 308, 346; nature of the carbon dioxide-acceptor complex, 204-205.
- Rudolph, H.: Chlorophyll formation in light of different color, 423, 430, 431.
- Ruhland, W.: Metabolism of hydrogen bacteria, 116-120.
- , Wetzell, K., and coworkers: Acid metabolism of plants, 263, 264, 267-268.
- Ruska, H. *See* Kausche, G. A.

S

- Sabalitschka, Th.: Plant feeding with formaldehyde, 258-261.
- Sachs, J.: Discovery of starch formation in illuminated chloroplasts, 33, 42.
- Sagromsky, H. *See* Mothes, K.
- Sargent, M. C.: Intensity adaptation and color changes of blue-green algae, 412, 421, 425-426.
- Saussure, N. Th. de: Discovery of water participation in photosynthesis, 23-24; ratio $H_2O:CO_2$ in photosynthesis, 36.
- Scarbrick, R. *See* Hill, R.
- Scarth, G. W.: Birefringence of chloroplasts, 365.
- Schmucker, Th.: Inhibition of photosynthesis by narcotics, 321.
- Schroeder, H.: Total yield of photosynthesis on earth, 5-7, 9.
- Senebier, J.: Discovery of role of carbon dioxide in photosynthesis, 19-22.
- Sen-Gupta, S. B. *See* Ghosh, J. C.
- Seybold, A.: Chlorophyll *b* as specific sensitizer for starch synthesis, 403, 405-406, 423.
- , Egle, K., and coworkers: Chlorophyll and carotenoid assay in plants, 405, 407-410, 412-416; light field and a:b ratio in plants, 403, 422; protochlorophyll fractions, 404; two-phase distribution of chlorophyll in chloroplasts, 362, 392-393.
- Sheheglava, O. A. *See* Lubimenko, V. N.
- Shibata, K., and Yakushiji, E.: Inhibition of photosynthesis by hydroxylamine, 284, 311.
- Smith, E. L.: Colloidal leaf extracts and effect of detergents, 386-388.
- Smith, J. H. C., and coworkers: Carbohydrates as only direct products of photosynthesis, 36-37, 44, 242; carbon dioxide uptake by chlorophyll preparations, 452-453; carbon dioxide uptake by leaves in dark, 188-195, 205.
- Söhngen, N. L.: Metabolism of methane-liberating and methane-consuming bacteria, 118, 119, 121.
- Spoehr, H. A., and coworkers: Relation of photosynthesis to respiration, 331-332, 562-564; transformations of carbohydrates in plants, 38, 43-47; uptake of carbon dioxide by leaves in dark, 191-192.

- Stauffer, J. F. *See* Emerson, R. L.; Fan, L. S.
- Stokes, G. G.: Discovery of multiplicity of leaf pigments, 399, 402, 412; existence of a third chlorophyll, 406.
- Stoll, A.: Chlorophyll as intermediate photoreductant and photoxidant in photosynthesis, 555; hydrogen-hydroxyl exchange as primary photoprocess in photosynthesis, 151, 555. *See also* Willstätter, R.
- and Wiedemann, E.: Allomerization of chlorophyll, 458, 461–462; preparation and properties of “chloroplastin,” 385–387.
- Strain, H. H.: Leaf carotenols, 412–416, 470, 472. *See also* Manning, W. M.
- and Manning, W. M.: Chlorophyll *c* (chlorofucin) in algae, 406; chlorophyll isomers *a'* and *b'*, 403, 444.
- Svedberg, Th., Katsurai, T., and Eriksson-Quensel, I. B.: Molecular weight of phycobilins, 478–479.

T

- Timiriazev, C.: Chlorophyll as chemical catalyst in photosynthesis, 548–550; chlorophyll spectrum and Darwinian theory, 427; reduction of chlorophyll, 457–458.
- Treboux, O.: Feeding of algae with organic compounds, 257, 261, 266; inhibition of photosynthesis by high osmotic pressure, 334.
- Trelease, S. F., Pratt, R., and coworkers: Photosynthesis in heavy water, 295–298.
- Tswett, M.: Chromatographic separation of chlorophylls *a* and *b*, 402.

U

- Umbreit, W. W. *See* Emerson, R. L.; Fan, C. S.; Vogler, K. G.

V

- Van der Honert. *See* Honert, T. van.
- Van der Paauw. *See* Paauw, P. van.
- Van Hille. *See* Hille, J. van.
- Van Niel, C. B., and coworkers: Generalized equations of photosynthesis, 105; metabolism of purple and green bacteria, 100–111; oxidation of water as primary photochemical process in photosynthesis, 73, 155–157; photosynthesis as oxidation-reduction, 53; primary photochemical process in bacteria, 168–170.
- Vermeulen, D. *See* Wassink, E. C.
- Vickery, H. B., Pucher, G. W., and coworkers: Acid metabolism of plants, 251, 263, 264, 267–269.
- Vinogradsky, S.: Discovery of chemosynthesis, and metabolism of colorless sulfur bacteria, 100–103, 111, 113, 119.
- Vogler, K. G., and Umbreit, W. W.: Metabolism of *Thiobacillus thiooxidans*, 113–115, 201–202.

W

- Warburg, O.: Carbonate-bicarbonate buffers as media for the study of photosynthesis, 177–179; cyanide-resistant residual photosynthesis, 302–303, 308–309, 563, 569–570; inhibition of photosynthesis by cyanide, 283, 301–303, 305, 531; inhibition of photosynthesis by excess oxygen, 328, 531; inhibition of photosynthesis by urethans, 284, 321–324.
- and Negelein, E.: Photochemical nitrate reduction in plants, 538–541.
- Wassink, E. C., Katz, E., and Dörrestein, R.: Bacteriochlorophyll extracts 170, 389. *See also* Katz, E.
- , Vermeulen, D., Reman, G. H., and Katz, E.: Inhibition of photosynthesis by cyanide, 302, 310; inhibition of photosynthesis by excess oxygen, 328–329, 531; inhibition by urethan, 322–323.

- Weber, F.: Birefringence of chloroplasts, 365; myelin tubes in chloroplasts, 375-376; silver nitrate reduction in chloroplasts, 270, 271, 360.
- Weber, K.: Protection of chlorophyll from bleaching, 495, 501; reductive bleaching of dyes, 506.
- Weier, E.: Grana in chloroplasts, 359-361.
- Weil-Malherbe, H. *See* Weiss, J.
- Weis, F.: Light curves of photosynthesis in shade plants, 533-534.
- Weiss, J., and Fishgold, H.: Reversible reduction of sensitizer as mechanism of sensitization, 517-518. *See also* Rabinowitch, E.
- and Porret, D.: Photooxidation of water by ceric ions, 74.
- and Weil-Malherbe, H.: Self-quenching of chlorophyll fluorescence, 484, 489, 518, 519.
- Weller, S., and Franck, J.: Effect of cyanide, hydrogen peroxide, and hydroxylamine on photosynthesis in steady and flashing light, 307-308, 312-313.
- Werner, O. *See* Klein, G.
- Wetzel, K. *See* Ruhland, W.
- Wiedemann, E. *See* Stoll, A.
- Wieler, A.: Grana, 254, 270, 358-360; iron in chloroplasts, 376-378.
- Willstätter, R., and Stoll, A.: Carbon dioxide uptake by chlorophyll preparations, 452-453; carbon dioxide uptake by leaves in the dark, 190-192; chlorophyll and carotenoid assay in plants, 407-411, 412-416; chlorophyll *a* and *b* not interconvertible, 474, 554; chlorophyll *c* a secondary product, 406; chlorophyll concentration unaffected by intense photosynthesis, 419, 423, 549; chlorophyllase, 380-381, 467; identity of chlorophylls from different species, 402-403; photosynthesis as decomposition of carbonic acid, with performic acid, formic acid and performaldehyde as intermediates, 52, 287-288; photosynthesis and age of leaves, 333; photosynthetic quotient, 31-35; structure of chlorophyll, 438-440.
- Winterstein, A. *See* Kuhn, R.
- Wood, R. W. *See* Franck, J.
- Wurmser, R.: Bleaching of chlorophyll, 495-498, 501; protection of chlorophyll by colloids, 502.

Y

- Yakushiji, E. *See* Shibata, K.
- Yamafuji, K., and coworkers: Sensitized photochemical formation of hydrogen peroxide, 63, 74, 78.

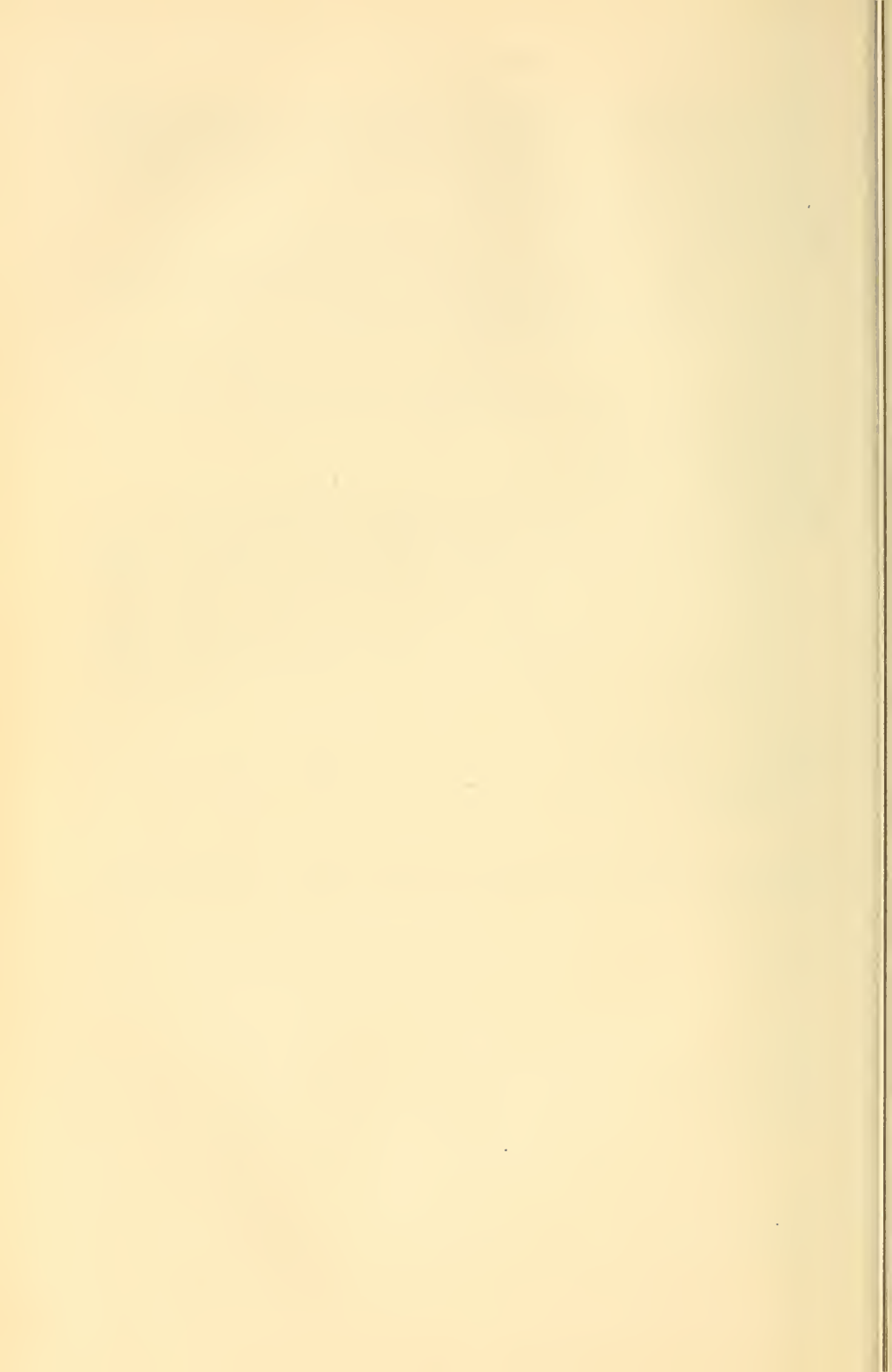

SUBJECT INDEX *

The following abbreviations are used: Chl, *chlorophyll*; CS, *chemosynthesis*; PO, *photoxidation*; PR, *photoreduction*; PS, *photosynthesis*; and R, *respiration*.

A

- Accessory pigments*, 401, 470-480
Acetaldehyde, conversion to starch, 261
function in PS, 342
in R, 224, 251, 261, 342
occurrence in plants, 243, 251, 253, 254
Acetic acid, as bacterial product, 123
energy, 184, 218
as food, 261
as intermediate in R, 224
occurrence in plants, 249, 251, 253
oxidation by bacteria, 110
Acetoin, occurrence in plants, 254
Acetone, as bacterial product, 107
Acidification of succulents, 264-267
Acids, conversion to carbohydrates by succulents, 265
occurrence and role in plants, 34, 207-269
in PS and R, 35, 51, 247, 265, 343
as substrates of bacterial PR, 102
Adaptation of algae, to H₂, 128-136
to light intensity and color, 421-427, 532
poisoning of H₂ adaptation, 310, 313
Adapted algae, metabolism, 120, 128-149, 168-170
scheme, 239
Aging, effect on PS, 285, 333-334, 339
Alcohols, in bacterial PR, 107
CO₂ uptake, 179-180, 186
in plants, 253-256
Aldehydes, in plants, 253
Algae, adaptation to H₂, 128-169
chromoplasts, 359
feeding with low molecular weight compounds, 257-262
formation of Chl in dark, 430
pigments, 405-407, 408-411, 415-416, 472

- Alkali ions*, in chloroplasts and cytoplasm 376-377
effect on PS, 340
Alkaloids, effect on PS, 321
Allomerization of Chl. See *Chlorophyll reactions, allomerization*
Allylthiourea (= thiosinamine), effect on Chl bleaching and fluorescence, 487, 516
Chl-sensitized oxidation, 510, 513
Amines, Chl-sensitized autoxidation, 511
CO₂ uptake, 181-183
Amino acids, CO₂ uptake, 182
in leaves, 373-374
source of oxalic and malic acid in plants, 264
Ammonium ions, effect on PS, 340
Anaerobic incubation, 128-136, 326-328
Anions, inhibition of PS, 341-342
Anthocyanins, 401, 479-480, 541
Ascorbic acid, 93, 259, 269-273, 343
Assimilatory secretion, 43, 254
Aurea leaves, 401, 403, 408-409
Autotrophic bacteria, 99-111
role in nature, 123-124
Autoxidation, 70, 474, 508-511, 517
Azide, effect on CS, 113
on PS, 318
Azo dyes, reaction with Chl, 503-505, 511

B

- Bacteria*, 99, 101, 102, 112-125
CS, 111-127
hydrogenase, 131
PR, 99-111
primary photoprocess, 168-170
Bacteriochlorophyll, 99, 101, 170, 384-389, 402, 407, 447, 495
as sensitizer, 514

* A subject index for both volumes will be found in Volume II.

- Bacterioviridin*, 101, 402, 445
Benzaldehyde, as substitute oxidant in PS, 542-543
Benzene, energy, 218, 219, 221
 as substrate of CS, 118
Benzidine, as Chl protector, 501
 PO, 508, 510, 528
Bicarbonate, in plants, 188, 189-195
 redox potential, 221
 reserve in plants, 196-200
 solutions, pH and CO₂ content, 178
Bicarbonate ions, absorption spectrum, 81
 concentration in CO₂ solution, 173-179
 energy, 218
 role in PS, 195-200
Bilan, 477, 478
Birefringence, of Chl coacervates, 392
 of chloroplasts, 362-368
Bleaching of chlorophyll. See *Chlorophyll bleaching*
Blue-green algae, absence of chromoplasts, 355
 adaptation to H₂S, 148
 chromatic adaptation, 419, 424-427
 pigments, 402, 405, 415-419, 424-427, 429
Blue-violet light, specific effects, 430, 431, 465, 485, 496, 536, 540, 541, 564-565, 567-568
Bond energies. See *Standard bond energies*
Brown algae, habitat, 420
 pigments, 402, 405, 410, 413, 414, 416, 420, 472
Brown phase, 459, 460, 462-463, 493
Butanol, in bacterial metabolism, 121-122
Butyrate, as plant food, 261
- C
- Calcium carbonate*, in aquatics, 197
 in leaves, 194, 377
Carbamates, formation from amines and CO₂, 181-183
Carbamination, 123, 182, 188, 191, 194, 289
 of Chl, 454
Carbohydrates, effect on greening, 429
 on PS, 331-333
 on R, 333
 energy, 49
 occurrence in leaves, 44-45
 as products of CS and PS, 33, 36-38, 118, 140, 241-242
 role in succulents, 265
- Carbon*, cycle on earth, 19
 isotope C¹⁴, 244
 as reductant in CS, 112, 118
 sublimation energy, 213
Carbonate-bicarbonate equilibrium, in plants, 190-195
Carbonate buffers, 178, 196, 198, 340
Carbonate ions, concentration in solution, 173-179
 energy, 218
 inhibition of PS, 197-198
 in plants, 189-195, 199-200
 spectrum, 81
Carbon dioxide, deficiency, stimulation of
 PO, 526-531
 effect on amylolysis, 331
 on Chl bleaching, 488
 on Chl fluorescence, 167
 on H₂ absorption by algae, 142
 on stomata, 331
 energy, 215-218
 "free" and "bound," 189-190
 "gush," 207
 hydration, 74, 175, 198-199
 inhibition of PS by its excess, 330-331
 ionic dissociation, 173-176
 penetration into cells, 197
 "pickup," 206-208
 reaction with Chl, 451-456
 role in PS, 19-22
 salting-out, 179
 solubility, 173-179, 189
Carbon dioxide absorption, by alcohols, 179-180
 by alkaline earth carbonates, 179
 by amines, 181-183
 by bacteria, 110, 114, 209
 by blood, 182
 by Chl, 455-456
 by dry leaves, 191-195
 by *Escherichia*, 209
 irreversible and reversible, 192-193
 by living plants, 188-209
 by phosphate buffers, 190-195
 by plants in dark, 190-195, 200-208
 in PR, 108, 109
 in PS, 173
in vitro, 173-188
 by water, 180, 181, 209
Carbon dioxide-acceptor complex, {CO₂}, 173, 188, 198, 200-208

- as ultraviolet-sensitive component in PS, 346
- Carbon dioxide addition to bonds*, H—OH, 176
- C—H, 183
- C—metal, 186
- N—H, 181
- N—metal, 454
- R—OH, 180
- Carbon dioxide concentration*, effect on
- HCN poisoning, 302, 303
- on deacidification of succulents, 265
- on urethan poisoning, 322
- in air, 174
- Carbon dioxide decomposition*, as primary process in PS, 157
- in ultraviolet light, 81
- Carbon dioxide liberation*, in deacidification of succulents, 265-266
- in light, 167
- by methane bacteria, 121-122
- by nitrate-reducing plants, 539
- Carbon dioxide reduction*, by bacteria, 113, 123, 167
- by CS in adapted algae, 123, 138
- coupled with phosphorylation, 226-227
- by electric discharges, 83
- by H₂, 73, 79, 83-89, 121, 146-148
- by H₂O₂, 157
- intermediates, 246-280
- by Mg, 79
- nonphotochemical step in PS, 124, 173, 213-244
- primary photoprocess in PS, 157-159, 161
- sensitized, 84-94
- thermodynamics, 213-222
- true, 123, 187-188
- in vitro*, 78-94
- Carbonic anhydrase*, 176, 182, 186-187, 199, 380
- Carbon monoxide*, 81-82, 112, 113, 118, 260, 316-317
- Carbonyl group*, energy, 215, 218
- as oxidant in PS, 542-543
- phosphate ester, 224
- Carboxylase*, role in PS. See *Catalyst E_A*
- Carboxylation*, of Chl, 454
- coupled with phosphorylation, 201
- in CS and PS, 80, 114, 183, 205
- energy, 217
- equilibrium, *in vitro* and *in vivo*, 183-186, 200-208
- in heterotrophants, 128, 208-209
- of H₂, 208
- in plants, 188, 200-208
- relation to true reduction of CO₂, 123, 187-188
- Carboxyl group*, energy, 215-218
- formation in R, 226
- as oxidant in PS, 80, 90-93
- phosphate ester, 224-227
- potential, 221
- Carboxylic acids*, as intermediates of R and substrates of PS, 563
- reduction, 80
- Carotenes*, 412-416, 470-476, 521-522
- Chl-sensitized oxidation, 510
- conversion to xanthophyll, 554
- in plants, 401, 412-416
- in seeds, 430-431
- Carotenoids*, 470-476
- in algae, 401, 412-416, 472
- autumnal transformations, 415
- in bacteria, 99, 101, 416-417, 473
- Chl protectors, 501
- effect of external factors on formation, 423, 430-431
- energy transfer to Chl, 515, 522, 558
- existence *in vivo*, 388
- fluorescence, 402
- formation *in vivo*, 427-431
- inheritance, 431
- in leaves, 401, 412-416
- in lipid fraction of leaves, 375
- participation in PS and R, 474-475, 522, 527, 557-558, 561, 569
- peroxides, 292-293, 474
- photochemistry, 521-522
- in plant extracts, 388
- position in chloroplasts, 367
- relation to vitamin A, isoprene, and phytol, 439-440, 471-472
- role in phototaxis, 557
- as sensitizers, 476, 515, 522, 561, 569
- Carotenols*, 412-416, 470-476, 521-522
- ratio to carotenes, 412-414, 423, 424
- in seeds, 430-431
- Catalase*, 122, 284, 286, 379-380, 431
- Catalyst E_A* (carboxylase), 173, 179, 203
- sensitivity to PO and poisons, 286, 308, 329-330, 536

- Catalyst E_B* (stabilizing catalyst, a mutase?), 163, 173, 379
- Catalyst E_C* (deoxidase), 173, 281, 312, 379
absence in bacteria, 168
inhibition by H₂S and NH₂OH, 312, 316
- Catalyst E_O* (deoxidase), 134-136, 281
- Catalytic reactions* in PS. See *Nonphotochemical processes*
- Cations*, as photoxidants for water, 74-76
transfer through leaves, 197
- Cell membranes*, permeability to neutral molecules, 197, 301, 319, 539-540
- Cellulose*, 42, 49
- Ceric ions*, reaction with Chl, 464-465
PO of H₂O, 74, 75
- Chemautotrophic bacteria*, 4, 99, 101, 112-125
efficiency, 118-122
- Chemosynthesis*, 99, 111-124
in algae, 141-142
energy dismutation theory, 166, 235-239
phosphorylation theory, 229
schemes, 142, 144, 235, 238
- Chlorides*, effect on PS, 341-342
in leaves, 376-377
- Chlorins*, 447, 457, 467
- Chloroform*, effect on PS, 320-321
- Chlorofucin*. See *Chlorophyll c*
- Chloroglobin*, 389
- Chlorophyll*, 382-394, 402-412, 438-470, 483-521, 526-557
as acceptor, for H in PS, 154-161
for H₂O and CO₂ in PS, 287, 450, 545
association, with CO₂, 287, 451-456, 545
with lipoids, 382-384, 391-394
with O₂, 455, 492, 520-521
with oxidants and reductants in PS, 545
with proteins, 382-384, 393
with sensitization substrates, 520-521, 544-547
bleaching, reversible, 486-494, 517, 550
in vitro, 383, 486-506
in vivo, 537-538, 550
catalyst in dark, 466, 504
colloids, 68, 452-453, 502-503
extracts, 382-383, 384-387, 394. See also *Chloroplastin* and *Chloroglobin*
films, 68, 394, 449-450
fluorescence. See *Fluorescence*
function in PS, 69, 154-161, 166-167, 287, 294-295, 384, 427-428, 450, 505-506, 545, 548-558
inheritance, 431
photocatalyst, 56, 69, 384
photoreductant and photoxidant in PS, 155, 294-295, 304, 505-506, 550, 551, 554-557
sensitizer, for autoxidations, 289
for H₂O₂ formation, 78
for Molisch reaction, 271
for nitrate reduction, 538-541
for PR of dyes, 504
for PS *in vitro*, 67-69, 89, 90-94
in vitro, 507-522
in vivo, 526-558
spectrum, 362, 383, 403, 427, 443-444
state *in vivo*, 367, 382-394
tautomeric, role in bleaching, sensitization, and fluorescence, 484-485, 489-491, 493, 499-500, 515, 545
- Chlorophyll a-chlorophyll b ratio*, 389, 402-404, 408-409, 419, 422, 423, 424, 554
- Chlorophyll a'*, 403
- Chlorophyll b*, conversion to *a*, 466-534
occurrence, 405-406
specific function in nature, 150, 403, 406, 422
specific properties, 423, 451, 462
- Chlorophyll b'*, 403
- Chlorophyll c* (chlorofucin), 402, 406-407, 439
- Chlorophyll-carotenoid ratio*, 413, 414, 422, 423, 427
- Chlorophyll concentration*, diurnal variations, 419, 420
effect of external factors, 419-432
effect on PS and catalase activity, 285
on HCN poisoning, 304
on quantum yield of sensitization, 509, 512, 519
in grana, chloroplasts, and cells, 204, 391, 411-412
in leaves and algae, 407-409
in lipid leaf fraction, 375
unchanged by PS, 549-550
- Chlorophyll d and d'*, 407, 439
- Chlorophyll formation in plants*, 404-405, 431
in dark, 404, 430, 431
effect of external factors, 345-346, 427-431

- Chlorophyll molecule*, 438-469
dipole, 444
enol, 444, 459, 493
isomers, 403, 444
long-lived states, 484-486
mesomers, 442-444
shape and size, 448-449
two green forms, 166-167, 556
water content, 450
- Chlorophyll oxidation*, 455-466
in PS, 551-557
- Chlorophyll peroxide*, 293, 461
- Chlorophyll photochemistry, in vitro*, 383, 483-521
in vivo, 526-560
- Chlorophyll-protein complexes*, artificial, 388
natural, 68, 383-389, 502-503
- Chlorophyll-protein ratio*, in chloroplasts, 387, 389-391
- Chlorophyll reactions*, 450-467
alcoholysis, 381, 459
allomerization, 293, 400, 459-462, 492-493
with ascorbic acid, 273
with associated oxidants and reductants, 545
carbamination, 183, 454
with CO, 316
with CO₂, 451-456
dismutation, 460, 489, 519
enolization, 444, 493
exchange with C*, 557
with H*, 557
with Mg*, 467
with FeCl₃, 295, 464-466
hydrogenation, 441, 457, 458
phase test, 457, 459, 465-466
polymerization, 519
uptake of CO₂, 451-456
of H₂O, 454-455
of O₂, 293, 499
with water, 450-451
- Chlorophyll reduction*, 90, 456-466, 491
in PS, 551, 553, 554-557
- Chlorophyllase*, 380-381, 447, 467
- Chlorophyllides*, 440, 447, 448-449, 462
- Chlorophyllin*, 439, 447; shape, 448
- Chlorophyllogen*, 404, 405, 431, 457
- Chloroplastic matter*, separation and composition, 204, 269, 368-371, 376-379, 381, 411-412
- Chloroplastin*, 385-386, 389, 537
- Chloroplasts*, 354-397
alignment in light, 549, 551
birefringence, 364-367
Chl content, 389-391, 411-412
content of ascorbic acid, 269-271
dichroism, 361
grana and lamina, 357-361, 361-367
iron and copper assay, 376-379
membrane, 357
number, size, shape, and volume, 354-357, 371
pH, 451
PS *in vitro*, 61-67
proteins and lipoids, 371-376
sensitizers in Hill's reaction, 63-67
state of pigments, 382-394
structure, 354-367
water content, 382
- Chlorosis*, 337-339, 372-373, 414, 428, 429
- Chromatic adaptation*, of algae, 421-427
of land plants, 422-424
- Chromatoplasm*, 355
- Chromoplasts*, 354-367
- Chromoproteids*, 382, 417-419
- Citrate*, in nonsucculent plants, 250, 267-269
as plant food, 261, 262, 266
as R intermediate, 268-269
in succulents, 264
- Cleavage test*, 460
- Coacervates of Chl*, 392
- Combustion energy*, 214-216
- Compensation point* of PS, 302
- Complementary chromatic adaptation*, 421-427
- Conifers*, Chl formation in dark, 430
- Conjugation*, influence on bond energy, 183-184, 214, 218-219
- Copper*, assay in chloroplasts, 379
role in PS, PO, and R, 320, 538
- Coupled reactions*, in CS, 141, 142, 235
in PS, 234
- Crotonic acid*, preparation from purple bacteria, 110
- Cupric ions*, effect on PS, 336, 340, 341
- Cyanide effect*, on carbonic anhydrase, 182
on catalase, 284-286
on Chl fluorescence, 310-311
on C*O₂ uptake, 203, 242
on CO₂ pickup, 207-308

- on CS, 113, 310
 on de-adaptation, 310
 on formic acid synthesis, 208
 on glucose-stimulated R, 562
 on Hill's reaction, 66
 on H₂-adapted algae, 310-311
 on hydrogenase, 131
 on hydrogen bacteria, 117
 on induction in PS, 310
 on iron in chloroplasts, 318, 378
 on nitrate reduction, 539
 on O₂ liberation in PS, 309
 on oxyhydrogen reaction, 310
 on PO, 311, 536
 on PR, 310-311
 on PS, 300-310, 342, 569-570
 on R, 301-306, 308, 569-570
Cyanide-resistant photosynthesis, 306-309, 561, 569-570
Cyanophyceae. See *Blue-green algae*
Cycloses. See *Inositols*
Cytoplasm, role in PS, 355
 separation from chloroplasts and composition, 369-376, 379-380
- D
- Dark reactions*. See *Nonphotochemical processes*
Deacidification of succulents, 265-266
De-adaptation of algae, 131-136, 169
 effect of poisons, 310, 313-316
Decarboxylation, 121, 183, 208, 454. See also *Carboxylation*
Dehydration, effect on Chl, 400
 on photolysis of CO₂, 82
 on PS, 333-335
Deoxidase, in PS, 134-136, 173, 281, 282, 291, 293-295, 312, 379
 NH₂OH and H₂S sensitivity, 286, 312, 316
Detergents, effect on Chl extracts, 387
Diatoms, adaptation to H₂S, 128
 oil storage, 34
 pigments, 402, 405, 425
Dichroism of chloroplasts, 366-367
Dihydroporphins, 445
Dinitrophenol, inhibition effects, 113, 143, 319
Dipole moment of Chl, 444
Dismutation, 48, 217
 of acetate by bacteria, 121
 of benzaldehyde by leaves, 542-543
 of Chl, 460, 489, 519
 of energy, in CS and PS, 161, 164-166, 233-239, 552
 of free radicals, 230
 of hydrogenase, 130
 of peroxides, 80, 282, 287, 291
 of semiquinones, 159
 step in deacidification, 266-267
 in PS, 80, 156, 158, 172-173, 240, 248
Distilled water, effect on PS and R, 336
Diurnal variations, of acidity, 246
 of Chl content, 419-420
Double bonds, energy, 214
 peroxides, 292, 474
Drying. See *Dehydration*
Dyestuffs, bleaching, 77, 293, 499
 as sensitizers, 76, 503-505, 512, 522
- E
- Efficiency*, of CS, 118-120, 140-141
 of PS, 50
Eight quanta theories of PS, 154, 160-168, 233-235, 552, 555
Electric fields and currents, effect on PS, 346
Electron transfer, as mechanism of oxidation, 151, 219-220, 319
Energy (total and free), of carboxylation, 183-184, 217
 of CO₂, 174-175, 215
 of combustion, 43, 213-216
 of CS, 112-120
 of dismutation, 217, 230-231, 282
 of fermentation, 121, 217
 of free radicals, 219-233
 of Hill's reaction, 67
 of hydration, 174-175, 217
 of isomerization, 217
 of methane production, 121-123
 of oxidation-reduction, 217-222, 230-231
 of peroxides, 282-284, 288, 291-292
 of phosphate bonds, 201, 224
 of polymerization, 217
 of PR, 102-105, 108
 of PS, 3, 8-10, 47-51, 69, 160-161, 291
 of R, 225
 of stabilization of intermediates in PS, 161
 of standard bonds, 213-215, 283
 of water, 72, 74, 213-215, 283

- Energy dismutation.* See *Dismutation, of energy*
- Energy transfer*, 514-517, 522, 548, 558
- Enolization of chlorophyll.* See *Chlorophyll reactions*
- Enzymes*, in chloroplasts, 379-381
in leaves, 41-42
as limiting factor in PS, 172
- Ethanol*, absorption of CO₂, 180
in bacterial metabolism, 121
effect on PS, 321
occurrence in plants, 249, 251, 254
- Ether*, effect on PS, 320-321, 342
on Chl in leaves, 383
- Etiolated plants*, 429-431
protochlorophyll content, 404
- F
- Fats*, occurrence in chloroplasts, 375
- Fatty acids*, in PR of bacteria, 102, 106, 108, 110-111
- Feeding*, of albino plants, 47
of algae with formaldehyde, 257-260
with other low-molecular compounds, 260-262
of flagellates, 261-262
- Fermentation*, 53, 110, 121-122, 129, 130, 136-138, 217, 265, 327, 563
- Ferric chloride*, reaction with Chl, 295, 464-466, 490-491, 504, 512
- Ferric oxalate as photoxidant*, for H₂O₂, 64
for H₂O. See *Hill's reaction*
- Ferric salts*, as oxidants in PS, 541
- Ferri-ferro systems*, 70, 221, 222, 294
- Ferrous ions*, occurrence in chloroplasts, 378
reaction with oxy-Chl, 488, 490
as reductants in CS, 116
- Flagellates*, organic nutrition, 261-262
pigments, 405-407
- Flashing light experiments*, 133, 169, 296-297, 307-308, 310, 311, 313, 338, 346
- Flavones*, 401, 402, 479-480, 541
reduction in light, 547
- Fluorescence*, of pigments, shift *in vivo*, 383
relation to primary photoprocess, 483-484
spectrum, of brown algae, 405-407
- Fluorescence of chlorophyll in vitro*, in coacervates, 392
in colloids, 385-388, 392, 393
effect of reduction, 457
fading, 492, 495, 497, 501
interpretation, 484, 489, 519, 546-547
in multilayers, 394
quenching and sensitization, 483, 485-486, 518, 546-548
yield, 485
- Fluorescence of chlorophyll in vivo*, 167, 392
carotenoid-sensitized, 476, 515, 522, 558
effect of anaerobiosis, 328
of boiling, 393
of cyanide, 310-311
of urethan, 322-323
in grana and stroma, 361-362
interpretation, 392-394
relation to sensitization, 545-548
yield, 546-547
- Fluorescence of phycobilins*, 402, 417
- Formaldehyde*, Chl-sensitized formation, 89, 90-94
decomposition by plants, 257, 260
energy, 48-49, 218
feeding to plants, 257-260
formation by silent discharges, 83
from CO₂ *in vitro*, 79, 82, 83
from Chl, 91
from percarbonate, 289
from phosgene and bicarbonate by H₂O₂, 79
hydrate, 53
intermediate in PS, 48, 51, 247-248
occurrence in plants, 249, 253, 255-257
poison, 257-259
polymerization, 247, 259, 273
product of PO, 68, 267, 495-496
in rain water, 82
reaction with nitrate and nitrite in light, 87
stimulant, 343
- Formic acid*, biosynthesis, 218
effect on Chl bleaching, 488
energy, 184, 218
feeding to plants, 261
intermediate in PS, 51
occurrence in plants, 249-251, 253
production by bacteria, 110
reversible decarboxylation, 185
- Four quanta theories of photosynthesis*, 154, 288
- Free energy.* See *Energy*
- Free radicals*, energy, 81, 217, 229-234
as intermediates in CS, PO, and PS, 80, 233-239, 287, 293, 494-501, 515

Fructose, 40, 43, 44, 46, 49
Fucozanthol, 401, 413, 415-416, 423, 472
Fumaric acid, biosynthesis, 209
 energy, 184, 218
 H acceptor, 131
 intermediate in R, 224
 in plants, 250-251

G

Galactose, 39, 49
Glucose, 39-42, 46
 effects on plant metabolism, 133, 137,
 140, 141, 143, 147, 308, 331-333, 562
 energy, 49
 product of PS, 44-46
 substrate of PO, 528, 529, 535
Glucuronic acid, in plants, 250, 252
 in respiration, 269
Glyceraldehyde, energy, 49
 occurrence in PS, 46
 in R, 223
Glycerol, in bacterial metabolism, 209
 conversion to sugar, 260, 261
 effect on PS and PO, 528
Glycogen, in algae, 43
Glycol, conversion to starch by plants, 261
Glycolaldehyde, *glycolic and glyoxalic acids*,
 in plants, 249, 251, 254
Grana, 44, 254, 357-361, 362
 Chl-protein ratio, 390-391
 fluorescence, 361
 O₂ uptake, 503
 in silver precipitates, 359
 volume, 390-391
Green algae, pigments, 403, 405, 410, 413
Greening, 427, 429
Green sulfur bacteria, 99, 101, 102, 103
 pigments, 402
Guard cells, 334
 "Gush" of carbon dioxide in light, 203, 207

H

Heavy metals, effect on PS, 340-342
Heavy water, effect on PS, 157, 295-298,
 335
Heliophilic and heliophobic (ombrophilic)
plants, 422, 533, 535
Hemoglobin, 63, 134, 384
Heredity, effect on pigments, 424, 431
Heterotrophic organisms, 2, 208-209
Hexenaldehyde, in plants, 43, 250, 252-255
Hexoses, as products of PS, 39, 45

Hill's reaction, 65, 66, 75, 239, 240
Hydration, of Chl, 449, 450
 of CO₂, 173-179, 198-199
 energy, 217
Hydrogen, in bacterial metabolism, 102,
 104, 116-118, 121, 123
 as reductant for CO₂ *in vitro*, 79, 83
Hydrogenase, in algae, 130, 134
 in bacteria, 131
 inhibition by CO, 316-317
Hydrogenation, of carotenoids, 474
 of CO₂ as primary photoprocess, 154,
 157-159
 energy, 217-222
 of free radicals, 230
Hydrogen atoms, in Chl, 441, 463, 555
 reactions with CO₂, 77
Hydrogen bacteria, 73, 112, 116-118, 119,
 236-239
Hydrogen donors, 106, 141, 145
Hydrogen fermentation, 128, 129, 136-139,
 142-146
 effect of poisons, 319
Hydrogen ions, effect on PS, 339-340
Hydrogen-oxygen ratio, in CS, 117, 139-
 141, 236-238
Hydrogen peroxide, dismutation, 80
 energy, 215, 283
 inhibitor of PS, 286, 318
 intermediate in PS and R, 79, 281-286
 monomolecular decomposition, 291
 photochemical formation, 70-73, 78, 283
 reductant for CO₂, 79-80
Hydrogen sulfide, effect on plants, 284, 316
 inhibitor, 315-316
 reductant in PS, 101, 102, 113, 128
 stimulant, 342
Hydrogen transfer, inhibition by dinitro-
 phenol, 319
 as mechanism of oxidation, 52, 151, 219
 as primary photoprocess, 150
Hydrogen uptake, by algae, 117, 129, 136-
 137, 139, 142-146
 by Chl, 455
Hydroxyl, ions, 339-340
 radicals, 72, 220
Hydroxylamine effect, on adaptation and
 de-adaptation, 133-135, 313-314
 on Hill's reaction, 66
 on PR, 311
 on PS, 284, 285, 311-315, 320, 569
 on R, 311-315, 320, 569

I

- Indoleacetic acid*, effect on PS, 343
Induction period in PR, 146
 in PS, 35, 207, 313, 326-328
Infrared light, photochemical effects, 99-100, 514-515
Inhibition. See under *Photoreduction*, *Photosynthesis*, *Photoxidation*, *Respiration*
Inositols, 39-40, 46, 244
Intensity adaptation, of algae, 421-422, 425 of leaves, 423-427
Intermediates, of CO₂ reduction, 239-280
 of O₂ liberation, 281-299
 of PS, 130, 133, 134, 244, 246, 564
 of R, 563
Inulin, 43, 49
Iodide ions, effect on PS, 341
 on PO, 511
Iodoacetyl radical, effect on catalase, 284-285
 on CO₂ uptake by bacteria, 114
 on CS, PS, and R, 113, 318-319, 342
Ions, deficiency and excess effects on PS, 335-342
Iron, bacteria, 112, 116
 in chloroplasts, 376-379, 429
 complexes in PS, 239-240
 effect on Chl, 425, 428-429
 on PS, 239-240, 317, 338
Isoamylamine, Chl-sensitized oxidation, 511
 effect on Chl bleaching, 487
Isoelectric point of pigment-protein complexes, 374, 380, 386, 478
Isomerization, of Chl, 403, 458
 energy, 217
Isotopes. See also *Radio-* categories
 of oxygen, participation in PS, 10, 55

K

Knallgas bacteria. See *Hydrogen bacteria*

L

- Lactaldehyde and lactic acid*, in bacterial PR, 108
 as plant food, 261
 in plants, 249, 250, 251, 254
Laminae, 361-367
Leaves, ash, 194, 372, 376-379
 carotenoids, 413

- Chl, 407-409
 CO₂ absorption, 205
 cross section, 357
 dry and frozen, CO₂ absorption, 191-195
 dry, O₂ liberation, 61-62
 extracts and mash as catalysts, 62, 63, 67, 259
 fractionation, 252-255
 yellow and white, CO₂ absorption, 193
Lecithin in leaves, 375
Leucophyll, 233, 404, 405, 457
Light color effect, on Chl bleaching, 496
 on pigment formation, 430-431
 on PO, 531
 on water deficiency phenomena in PS, 335
Light field, effect on pigments, 403, 423
Light injury, 529, 532
Light intensity effect, on Chl bleaching, 487, 489
 on Chl-sensitized reactions, 519
 on Hill's reaction, 65
 on H₂ metabolism of algae, 142-143, 147
 on induction in algae, 146
 on inhibition of PS by poisons and deficiencies, 302, 303, 306, 309, 312, 319, 333, 337-339, 341
 on PO, 531, 532
 on PS, 296-298, 526, 531-537
Light saturation, of Hill's reaction, 65
 of PR, 145
 of PS, 532, 535
Light stimulation, of respiration, 527
Lipides, association with pigments, 382, 475-476, 537-538
 effect on Chl fluorescence, 392
 occurrence in chloroplasts, 365-367, 391-394
Lipochromes, 382
Lipoids, assay in leaves, 375
 association with pigments, 382
 in chloroplasts and cytoplasm, 371-376
 in grana and stroma, 361
 protection of Chl, 503
Long-lived active products, in Chl *in vitro*, 483-486
in vivo, 544-547
 in O₂, 514
Luminous bacteria, as reagents for O₂, 62, 100, 327
Luteol, 415, 416, 470-472, 474

M

- Magnesium*, effect on Chl and PS, 337-338, 383, 428, 440, 443, 448, 451, 461, 462, 467
 loss by Chl, 467, 493-494, 498
 as reductant for CO₂, 79
- Malic acid*, biosynthesis, 209
 conversion to carbohydrates, 265
 to citric acid, 269
 as intermediate in PS and R, 51, 224
 occurrence in plants, 250, 251, 262-269
 as plant food, 261
 PO, 267
 as reductant for bacteria, 108
- Mallose*, 41
- Manganese*, effect on PS and Chl, 338-339, 429
 in leaves, 195
- Mannose*, 39, 46
- Mechanical injury*, effect on PS, 343-344
- Mercuric ions*, inhibition of PS, 336
- Mesomerism* of chlorophyll, 442-443
- Methane bacteria*, 118-119, 120-122
- Methanol*, Chl-catalyzed oxidation, 466, 504, 512
 conversion to starch, 261
 occurrence in plants, 249, 251
- Midday depression* of PS, 331, 334
- Molisch reaction* (AgNO₃ reduction by chloroplasts), 254, 270-271, 360, 541
- Moloxides*, as intermediates in PS and PO, 156, 292, 499, 508, 511
- Monocotyledons*, absence of starch, 47
 pigments, 424
- Monolayers and multilayers* of Chl, 394, 449
- Morphine*, effect on PS, 321
- Motile bacteria*, 100
- Myelin tubes* in chloroplasts, 375-376

N

- Narcotics*, effect on formic acid synthesis, 208
 on PS and R, 300, 320-324
 stimulation of PO, 526, 528-531
- Neutrons*, effect on PS, 347
- Nitrate*, deficiency effect, 337, 339, 425, 428
 as oxidant in CS, PR, and PS, 115, 116, 131, 539, 540, 541
 reduction by plants in dark, 538-539
 sensitized reduction, 87, 538-541
- Nitrifying bacteria*, 112-113, 119

- Nitrite*, formation from nitrate in plants, 539
 oxidation by bacteria, 112
- Nitrous gases*, effect on plants, 317, 538
- Nonphotochemical processes in photosynthesis*, 150-158
 CO₂ fixation, 172-212
 reduction, 213-244
 O₂ liberation, 281-299
- Nonsulfur purple bacteria*, 110, 131
- Nucleic acid* in chloroplasts, 374

O

- Oceans*, yield of PS, 5-8
- Oil* as product of PS, 34, 43, 254, 357
- Oleic acid*, effect on Chl fluorescence, 392
 PO, 508, 511
- Ombrophilic and ombrophobic plants*, 403, 409, 421, 422, 533, 535
- Ontogenetic adaptation*, 419, 422, 424-427
- Optical activity*, of Chl, 441
- Organic hydroperoxides and peroxides*, energy, 291
 role in PS, 163, 286-293
- Organic matter*, origin, 82, 83
 rate of production on earth, 36-37
- Osmotic pressure*, effect on PS, 334-335
- Over-all reaction*, of CS, 112-120
 of PR, 102-106
 of PS, 31, 34, 53, 156, 158-159
- Oxalacetic acid*, biosynthesis, 209
 decarboxylation, 185
 energy, 218
 role in R, 268
- Oxalic acid*, Chl-sensitized oxidation, 512
 energy, 184
 formation in plants, 269
 as intermediate in PS, 51
 occurrence in plants, 249, 262-263
 as plant food, 201
 PO *in vitro*, 267
- Oxidase*, activation in algae, 135, 286
- Oxidation*, of carotenoids, 473-475
 of Chl, 456-466, 491, 503-505
 of Chl as primary process in PS, 552-553, 554-557
- Oxidation-reduction*, as cause of Chl bleaching, 489-493
 Chl-sensitized, 509, 512
 of Chl and solvents, 485-486, 500-501

- of Chl with oxidants or reductants, 503-505, 515-516, 517-518
 internal in Chl, 450-459
- Oxidation-reduction potential*, 53, 217-222
- of ascorbic acid, 272
 of carbonic acid, 75
 of ceric ions, 74
 of Chl, 295, 556-557
 of dyes, 76
 of excited molecules, 152
 of formic acid, 79
 of free radicals, 230-233
 of H_2O_2 , 79, 283
 of intermediates in PS, 234
 of iron complexes, 240
 in leaves, 431
 of O_2 , 79, 283
 of phosphate esters, 225
 of thionine, 152
 of water, 79
- "*Oxychlorophyll*," 295, 464-467, 556
- Oxygen*, acceptor complex, 325
 conversion of PS to PO, 531-532
 cycle on earth, 10
 deficiency, influence on PS, 326-328
 effect on CS, 139
 on Chl bleaching, 486-491, 498, 501
 on Chl fluorescence, 492, 547
 on greening, 429
 on nitrate reduction, 539
 inhibition of PS by excess, 329, 530
 isotopic composition and PS, 10, 54-56
 metastable, 150, 514-515
 origin in PS, 54
 origin in sulfate produced by bacteria, 113
 as oxidant in PS, 536, 538
 -oxygen bond weakness, 49, 214-215
 photochemical production by algae with substitute oxidants, 541-543
 potential, 283
- Oxygen-liberating enzymes in photosynthesis*. See *Deoxidase*, *Catalyst Ec*, *Catalyst Eo*
- Oxygen liberation*, absence in bacteria, 100
 in artificial PS, 92, 93
 in deacidification of succulents, 265
 of distilled water, 200
 by first light flash, 133, 327
 by leaf powders and single chloroplasts, 62-67
 by nitrate reducing plants, 539
 as nonlimiting reaction in PS, 285-286
 in PS, 173, 281-299
 role of carotenoids, 474-475
- Oxygen pressure effect*, on Chl bleaching, 499
 on Chl-sensitized oxidation, 513
 on PO, 502-503, 523, 526-527, 530-536
 on PS, 328-330, 530-531
 on R, 527, 530-531
- Oxygen uptake*, by adapted algae, 139
 by bacteria, 110, 114
 by Chl, 293, 455, 460-461, 492, 498-499, 520
 by Chl-sensitized PO, 508-511
 by grana, 503
- Oxyhydrogen reaction*, in algae, 129, 132, 134, 138-142
 in bacteria, 116, 118
 Chl-sensitized, 512
 effect of HCN, 310
 H_2O_2 as intermediate, 286

P

- Palisade tissue*, 357
- Pentose and pentosans*, 38, 43, 49
- Peracids*, energy, 291
- Percarbonic acid*, 79
 in PS, 288-289
- Performaldehyde and performic acid* in PS, 287-288
- Peroxidase*, 281, 380, 431
- Peroxides*. See also *Amine peroxides*, *Catalyst peroxides*, *Hydrogen peroxide*, *Organic peroxides*, *Percarbonic acid*, *Performaldehyde*
 decomposition as nonphotochemical reaction in PS, 172
 formation in Chl bleaching, 495
 in dead tissues, 63
 as intermediates in oxyhydrogen reaction, 140
 in PO, 293, 499, 508, 511
 in PS, 48, 156
 monomolecular and mono-acid bimolecular decomposition, 80
 reversible formation, 291-293
- pH effect*, on anaerobic inhibition, 327
 on Chl monolayers, 449, 450
 on CO_2 solubility, 173-179
 on fermentation, 137

- on HCN solutions, 301
- on PS, 198, 339-340
- on redox potentials, 220
- Phase test*, 457, 459, 465, 492-493
- Phenantroline*, effect on adapted algae, 135, 314, 319-320
- Phenols*, as Chl protectors, 501
 - conversion to starch, 261
 - energy, 185
- Phenylhydrazine*, photochemical reactions, 504-505, 509, 512
- Pheophosphide*, 447, 458, 462
- Pheophyceae*. See *Brown algae*
- Phaeophytin*, 447, 452, 453, 454, 456, 467, 493-494, 498
- Phorbins*, 447
- Phosphate bond*, energy, 115
 - role in CS, PS, and R, 225, 227-229
- Phosphates* as CO₂ absorbers in leaves, 190-195
- Phosphatidic acid* in leaves, 374-375
- Phospholipides* in leaves, 374-376, 393
- Phosphorescence*, 485
 - use for O₂ detection, 327
- Phosphorus*, deficiency effect on PS, 339
 - in plants, 228, 374, 376-377
- Phosphorylation*, coupled with carboxylation, 115, 201
 - with CS, 114, 229
 - with PS, 150, 226-229
 - with R, 222-226
- Phototrophic bacteria*, 99, 101
- Photautoxidation*, 70, 72
 - in vivo*, 526-538
- Photocatalysis*, 56, 161-162, 507
- Photochemical reactions*, of adapted algae, 142-148
 - of carotenoids and phycobilins, 521-522
 - of Chl, 483-524
 - of pigments, *in vivo*, 526-560
- Photodismutation*, 485-486
- Photodynamic reactions*, 56, 76, 317, 507-510, 520
- Photogalvanic and photovoltaic effect*, 76
- Photoheterotrophic bacteria*, 101, 106-111
- Photoreduction*, 101
 - by adapted algae and bacteria, 111, 129, 136, 146-148, 169-170
 - of Chl, 458, 505, 551, 553
 - effect on poisons, 310, 314, 316-317, 319-320
 - primary process in PS, 161, 551, 553
 - in succulents, 34
- Photorespiration*, 527, 567, 569-570
- Photostationary state*, 10, 71, 72, 82, 486-493
- Photosynthesis*, analogy to CS, 234-235
 - artificial (achievement?), 86-87, 93
 - (definition), 84
 - bacterial (= photoreduction), 148
 - complete and partial, 61
 - effect of chemical inhibitors and stimulants, 300-344
 - of poisons and narcotics, 300-325
 - of various physical agents, 344-347
 - from acids in succulents, 265-266
 - from CO₂ and H₂ in algae, 129
 - interaction with R, 562-566
 - by leaf powders and single chloroplasts, 61-67
 - of N compounds, 87, 88
 - net, 31
 - normal, 32
 - relation to R, 309, 561-570
 - residual, in presence of HCN, 302-304, 308-309
 - schemes, 136, 144, 153, 157, 159, 160, 162, 165, 235, 239, 552
 - true, 32
 - with substitute oxidants, 541-543
 - substitute reductants, 99-148
- Photosynthesis, inhibition*, 300-325
 - by alkali, 340
 - by alkaloids, 321
 - by anions, 341-342
 - by azide, 318
 - by chloride, 341-342
 - by chloroform, 320-321
 - by CO, 316-317
 - by Co⁺⁺ and Cu⁺⁺, 336, 340
 - by cyanide, 301-311, 340-341
 - by dinitrophenol, 319
 - by ethanol and ether, 320-321
 - by excess carbohydrates, 331-333
 - by excess CO₂, 330-331
 - by excess light, 532-536
 - by excess osmotic pressure, 341
 - by excess O₂, 328-330, 531
 - by heavy metals, 340-342
 - by Hg⁺⁺, 336, 341
 - by H₂O₂, 286, 318
 - by H₂S, 315-316

- by injury, 343-344
- by iodide, 341-342
- by iodoacetyl, 318-319
- by ions, 335-342
- by K deficiency, 336-337
- by Mg deficiency, 337-338
- by Mn deficiency, 338-339
- by Na^+ , 340
- by narcotics, 320-324
- by NH_4^+ , 340
- by NH_2OH , 311-315
- by Ni^{++} , 340-341
- by nitrate deficiency, 339
- by photooxidation, 526
- by physical agents, 344-347
- by SO_2 , 317-318
- by thiourea, 320
- by thymol, 320-321
- by urethans, 321-324
- by Zn^{++} , 341
- Photosynthesis, interpretation*, by v. Baeyer, 48, 51
 - by Baly, 87, 554
 - by Conant, 553
 - as decomposition of CO_2 , H_2O or H_2CO_3 , 51-53
 - by Dixon and Ball, 554
 - energy dismutation hypothesis, 233-235
 - by Franck and Herzfeld, 162-164, 287-290, 545, 550, 555
 - as intermolecular H transfer, 53
 - by Liebig, 35, 51
 - as oxidation-reduction, 51-56
 - by Rabinowitch, 164-166, 233-235
 - by Ruben, 150, 201, 226-227
 - by Stoll, 555
 - by Thunberg and Weigert, 79, 552
 - as topochemical reaction, 152
 - as two-stage process, 123-124
 - by Van Niel, 53, 73, 105, 155-157
 - by Weiss, 240
 - by Willstätter, 553
 - by Willstätter and Stoll, 52, 287-288
- Photosynthesis, stimulation*, by acids, 340
 - by ascorbic acid, 273
 - by carbohydrates, 332-333
 - by chemicals, 342-344
 - by cyanide, 303, 304
 - by injury, 343-344
 - by ions, 335-342
 - by narcotics, 321
 - by physical agent, 344-347
 - by SO_2 and nitrous gases, 317
- Photosynthetic quotient*, 21, 31, 34, 35
 - of adapted algae, 140
 - of bacteria, 103, 107, 108, 109
- Phototaxis*, 557
- Phototropism* of bacteria, 99
- Photoxidation*, of Chl, 495, 498-501, 537-538, 551-553, 554-557
 - inhibiting effect on PS, 526, 532
 - of plant acids, 267
 - in poisoned plants, 317
 - primary photoprocess, 527-528, 543-544
 - as primary process in PS, 161
 - relation to R, 527, 530-531, 563-566
 - stimulation by excess O_2 and light, 531, 563
 - in succulents, 34, 265-266
- Phthiocol*, effect on algae, 314, 319-320
- Phycobilins* (phycocyanin and phycocerythrin), 417-419, 476-479
 - role in PS, 426, 479, 522, 557-558
- Phycocyanobilin and phycoerythrobilin*, 477
 - isoelectric points, 478
- Phyllins*, 447
- Phylogenetic adaptation* of pigments, 419-424, 532
- Phytin*, 40
- Phytins*, 447
- Phytol*, 439, 448, 449, 471-472
 - uptake of CO_2 , 180
- Pickup* of CO_2 , 203, 206-208
- Pigments*, 399-437
 - accessory, 470-489
 - association with proteins and lipoids, 382-384
 - content in algae, 418
 - in chloroplasts, 369, 382-394
 - in grana, 361-362
 - extraction, 383
 - influence of external factors, 419-432
 - polarity gradation, 382
- Plankton*, photosynthesis, 6
- Plasmolysis*, effect on PS, 334-335
- Polymerization of carbohydrates*, catalyzed
 - by ascorbic acid, 273
 - energy, 217
 - sensitized by Chl b?, 150
- Porphin*, 445-446
 - protein complexes, 384

- Porphyryns*, 446, 457, 478
monolayers, 394
- Potassium*, deficiency effects, 336-337, 339, 428
in chloroplasts, 376-377
- Primary photochemical process*, in carbonate solutions, 81
in Chl solutions, 483-484
common to all Chl-sensitized reactions *in vivo*, 543-544
in dyestuff solutions, 77
in ionic solutions, 75
in Hg-H₂O mixture, 72
in PO, 527-528, 543-544
in PR, 168-170
in water, 71
in ZnO-H₂O mixture, 73
- Primary photochemical process in photosynthesis*, 136, 142, 150-171, 451
decomposition of H₂O, 155
dehydrogenation of an organic hydroxy compound, 290
electron transfer from Chl to H₂O, 552
H exchange between intermediates, 159-160
H-OH exchange, 151
most likely, 166-168
oxidation of Chl, 552-553, 554-557
of water, 155-157
of H₂O and reduction of CO₂, 161-163
phosphorylation, 150
reduction of CO₂, 157-159
two such processes, 160-164
- Products of photosynthesis*, 38-46
- Propionate*, as plant food, 261
- Propionic acid bacteria*, fixation of CO₂, 209
- Protective colloids*, effect on Chl, 502
- Protein-chlorophyll*, suspensions, solutions, and precipitates, 384-387, 388, 394, 502.
See also *Chloroplastin*, *Chloroglobin*
- Proteins*, association with pigments, 382-384, 388, 417, 475, 479, 502
in chloroplasts and cytoplasm, 371-376
in grana and stroma, 361
protection by Chl, 383
protection of Chl, 502-503
sensitivity to dinitrophenol, 319
- Protochlorophyll*, 404-405, 431, 445, 457, 463
- Protoplasma*, role in PS, 333, 342, 344, 355
- Purple sulfur bacteria*, 4, 99, 101-103, 124
analysis, 109, 110
dark metabolism, 110-111
pigments, 402, 416-417, 473
PR, 102-112
R, 100, 110, 564
- Purpurea* leaves, 401, 480
- Pyrenoids*, 43, 356, 359
- Pyrrole*, 440
effect on Chl synthesis, 428-429
- Pyruvic acid*, as plant food, 266
decarboxylation, 185
energy, 184, 218
role in R, 223, 224
sensitized PO, 508-511

Q

- Quantum yield*, of Chl bleaching, 485-488, 496-497
of Chl-sensitized reactions, 509, 512-514, 518-520, 546-547
of PR in algae, 169, 314-315
of PS, 154, 160, 228-229
of water oxidation by ceric ions, 74
- Quenching* of Chl fluorescence, 167, 483, 490
- Quercetin*, 185, 480
- Quinine*, effect on PS, 321
as sensitizer, 78
- Quinones*, 221-222
peroxides, 292-293
reaction with Chl, 461

R

- Radicals*. See *Free radicals*
- Radioactive rays*, effect on PS, 337, 346-347
- Radiocarbon*, exchange with Chl, 557
as indicator, in bacterial metabolism, 122, 207
in decarboxylation, 185-186, 201
in PS, 37, 202-203, 241-244
- Radiohydrogen*. See *Tritium*
- Radiomagnesium*, exchange with Chl, 555
- Radiooxygen*, as indicator in PS, 54-55
- Red algae*, absence of Chl *b*, 405
habitat, 420
pigments, 402, 410, 413, 417-419
- Respiration*, correction 32, 561
cycles, 222-224, 268
effect of light, 527, 566-570
function of O₂ pressure, 530

- as H transfer, 52
inhibition, 301-306, 308, 311, 315, 316,
318-319, 320-324, 569-570
interaction with PS and PO, 332, 527,
530-531, 562-566
in purple bacteria, 100, 110-111
role of acids, 267-269
of carotenoids, 475, 557
of phosphorylation, 222-226
stimulation, 301, 304, 316
Respiratory quotient, 32, 34, 109, 266
Reversible bleaching. See *Chlorophyll
bleaching, reversible*
Reversible oxidation of chlorophyll. See
Chlorophyll oxidation, reversible
Reversible oxidation reduction systems, 221,
231-232
Reversible peroxide formation. See *Per-
oxide, reversible*
Reversible reduction of chlorophyll. See
Chlorophyll reduction, reversible
Rhodamine, as sensitizer, 78, 92
as stain, 361, 367
Rhodins, 447
Rhodocae. See *Red algae*
Rhodopin, *rhodopurpurin*, *rhodovibrin*,
rhodoviolascin, 416, 473
Rubidium, as K substitute, 337, 428
Rubrene, peroxide, 292
PO, 511
- S
- Salt effects*, 179, 336, 465, 506
Salting-out, of chloroplastic matter, 369-
371
of Chl, coacervates, 392
of CO₂, 179
Salt-water algae, dependency of PS on
salinity, 336
Saturation of photosynthesis, with CO₂, 196
with light, 532, 535
Selenium, in bacterial metabolism, 101
Self-quenching, of Chl fluorescence, 484,
489, 518, 519
Semiquinones, 231-233
Sensitization, by carotenoids, 522
by Chl, 507-522, 543, 557
of Chl fluorescence, 515
in a complex, 520-521
direct and indirect, 483
by kinetic encounters, 514-520
relation to fluorescence, 483-484, 546-
548
Separations methods, of chloroplastic mat-
ter and cytoplasm, 368-371
of pigments, 399-400
Shade plants. See *Ombrophilic plants*
Silent discharges, effect on CO₂, 83
Silver nitrate reduction, by ascorbic acid,
272
by chloroplasts. See *Molisch reaction*
Smoke gases, effect on vegetation, 538
Sodium, effect on PS, 340
in leaves, 377
Solarization, in PS, 532
Solvents, function in Chl allomerization,
461-462
in Chl bleaching, 491-492, 500
protective effect on Chl, 501
reaction with Chl as step in sensitiza-
tion, 516
with Chl* as cause of weak fluores-
cence, 405-486
Sorption, isothermals of Chl for CO₂, 452
Spongy parenchyma, 357
Stabilization of intermediates, role in PS,
161, 172
Standard bond energies, 213-215, 217, 283,
484
Starch, dissolution in intense light, 532
energy, 49
equilibrium with sugars in guard cells, 334
food for flagellates, 261
formation in ultraviolet light, 344
formation sensitized by Chl b, 406,
423-424
grains in chloroplasts, 33
maximum accumulation, 46
occurrence in plants, 43, 47
as product of PS, 37, 42, 86, 87
production in plants from organic foods,
257-263
structure, 42
Sterols, in leaves, 375
Stimulation. See *Photooxidation*, *Photo-
synthesis*, *Respiration*
Stomata, closure mechanism and role in
PS, 331, 334, 532
Stroma, of chloroplasts, 358, 361, 362,
369-370
*Substitute reductants and oxidants in photo-
synthesis*, 67, 124, 538, 541-543

- Succinate*, biosynthesis, 209
 content in plants, 250, 251, 263
 energy, 218
 as food, 261, 263
 intermediate in PS, 51
 in R, 224, 268
 oxidation coupled with phosphorylation,
 226
 PO, 267
- Succulents*, acid metabolism, 264-267
 PS quotient, 34
- Sucrose*, 41-42
 energy, 49
 first product of PS, 37, 44-46
 influence on PS, 334-335, 341
 uptake of CO₂, 180
- Sulfate*, assay in leaves, 377
 production by bacteria, 102, 113, 115
- Sulfite*, effect on PS, 317
 in PR, 103
- Sulfur*, in CS, 113-115
 in chloroplast proteins, 374
 in PR, 102
- Sulfur bacteria*, colorless, 100, 101, 112,
 113-116
 green and purple, 99, 101, 102-106
- Sulfur dioxide*, effect on plants, 317, 318,
 378
 on PS, 318, 342
- Sunlight*, intensity distribution, 427
- Sun plants*. See *Heliophilic plants*
- Sunstroke* of shade plants, 533, 536
- T**
- Tartrates*, 250, 251
 as food, 261, 266
 as intermediates, 51
- Temperature effect*, in CO₂ inhibition of PS,
 331
 in CS, 117
 in H adaptation, 130
 in Hill's reaction, 66
 in PS, 172, 296
- Tetrahydroporphins*, 445
- Tetrathionate*, as product of PR and CS,
 104, 115
- Thiocyanide*, effect on plants, 318
 as reductant in CS, 116
- Thionine*, potential, 77
 reaction with ascorbic acid, 272
 reduction by Fe⁺⁺ in light, 77, 151, 159,
 486, 517
 as sensitizer, 517
- Thiorhodaceae*. See *Purple sulfur bacteria*
- Thiosinamine*. See *Allylthiourea*
- Thiosulfate*, in CS, 115, 116
 as reductant in PR, 103, 104
- Thunderstorm*, effect on PS, 321
- Toluene* as reductant in CS, 118
- Topochemical mechanism* of PS, 152
- Transpiration energy*, 9
- Trioses* as intermediates in PS, 240
- Tritium*, PS with T₂O, 298, 557
- U**
- Ultraviolet light*, specific photochemical
 effects, 71, 81, 272, 344-346, 430, 501,
 532, 537, 564
- Uranium compounds*, effect on greening,
 429
 as sensitizers, 78, 84, 85
- Urethan inhibition*, of catalase, 284
 of C*O₂ uptake in light, 242
 of CS, 113
 of Hill's reaction, 66
 of hydrogen bacteria, 117
 of nitrate reduction, 539-540
 of O₂ uptake by grana, 503
 of PS and R, 284, 300, 321-324
- Urethan stimulation*, of PO, 528, 538
 of PS, 342
- V**
- Valerate* as food, 261
- Violaxanthol* in plants, 415, 416
- Viologens*, 233, 457
- Visual purple*, photochemistry, 521-522
- Vitamins*, A, 471
 C. See *Ascorbic acid*
 K, 314
- Volatile components* of leaves, 252-255
- W**
- Water*, deficiency. See *Dehydration*
 effect on greening, 429
 energy, 283
 interaction with Chl, 450-451
 participation, in photosynthesis, 23, 57,
 153, 289
 in photovoltaic and photogalvanic
 effect, 76
 spectrum and primary photoprocess, 71

- Water decomposition*, as primary photo-
process in PS and PR, 155-157,
168-169, 451
sensitized, 71-74, 76, 78
in ultraviolet light, 71
- Water oxidation*, as dark reaction in PS,
158, 163
photochemical, 69-78, 543
as primary photoprocess in PS and PR,
155-157, 161, 168
- Water reduction*, photochemical, 81, 272
- Waxes* in leaves, 375
- Wound hormones*, effect on PS, 343
- X
- X-rays*, effect on Chl, 403
on CO₂, 83
- Y
- Yellow dyes*, reaction with Chl, 505
- Yellow leaves*, pigments, 401
- Z
- Zeaxanthol*, 414, 415, 472
- Zinc compounds*, effect on PS, 341
sensitization of H₂O decomposition, 72,
78

1021-14

