

UC Irvine

UC Irvine Previously Published Works

Title

Postnatal enlargement of human tracheobronchial airways and implications for particle deposition.

Permalink

<https://escholarship.org/uc/item/1rx8502g>

Journal

The Anatomical record, 212(4)

ISSN

0003-276X

Authors

Phalen, RF
Oldham, MJ
Beaucage, CB
[et al.](#)

Publication Date

1985-08-01

DOI

10.1002/ar.1092120408

Copyright Information

This work is made available under the terms of a Creative Commons Attribution License, available at <https://creativecommons.org/licenses/by/4.0/>

Peer reviewed

Postnatal Enlargement of Human Tracheobronchial Airways and Implications for Particle Deposition

ROBERT F. PHALEN, MICHAEL J. OLDHAM, CHRISTINE B. BEAUCAGE,
T. TIMOTHY CROCKER, AND JD MORTENSEN

Air Pollution Health Effects Laboratory, Department of Community and Environmental Medicine, University of California, Irvine, CA 92717 (R.F.P., M.J.O., C.B.B.) and UBTL Division, University of Utah Research Institute, Salt Lake City, Utah (JDM.)

ABSTRACT In support of predictions for inhaled particle deposition, morphometric measurements were taken on 20 replica airway casts of people aged 11 days to 21 years. Measurements of right upper lobe airway lengths, diameters, and branching angles were made such that a growth model suitable as input to predictive equations for particle deposition efficiency was obtained. The tracheobronchial airways growth was describable by linear regressions on body length. The length-to-diameter ratio of growing airways did not change in any simple way as a function of airway generation. Airflow rates for a given state of physical activity for various ages were found from previously published data to be describable by linear regressions on body mass. Three states of physical exertion—low activity, light exertion, and heavy exertion—were used for modeling purposes. The computed particle deposition efficiencies indicate that under most circumstances smaller (younger) people will have greater tracheobronchial deposition efficiencies than larger (older) people. For example, tracheobronchial dose on a per kilogram body mass basis for 5- μ m-diameter particles may be more than 6 times higher in the resting newborn than in the resting adult assuming equivalent deposition efficiencies above the larynx.

Because little is known regarding age-related differences in inhaled particle deposition, we have been interested in developing mathematical predictions for particle deposition in the tracheobronchial airways corresponding to a range of ages. Such predictions are strongly dependent on airway anatomy, so measurements of the growing airways were taken to develop a model upon which to base the mathematical predictions for deposition.

Although several investigators have provided quantitative descriptions of the dimensions of adult human airways, few have described the manner in which these structures grow. Among the earliest morphometric models for the complete adult tracheobronchial airways were those published by Weibel (1963). To generate these models, measurements from the trachea downward for about 10 generations were made on a plastic replica cast prepared by Liebow from the excised lungs of an adult male. Formalin-fixed slices from a lung fixed in the inflated state were measured to obtain values for smaller airways, and intermediate sizes were estimated by interpolation. Subsequent descriptions of the adult airways were published by Horsfield and Cumming (1967) and Horsfield et al. (1971), who used a resin cast made from the excised lung of a "young man," and by Yeh and Schum (1980), who used silicone rubber casts prepared in situ in a 50- and a 60-year-old man.

Limited information on bronchial dimensions in children has been published, but it is neither adequately documented nor complete enough to establish growth patterns for the complete tracheobronchial tree. Engel

(1913) published values for lengths and diameters (sagittal and frontal) of the trachea and right and left main bronchi for 12 children aged 1 month to 13 years, and a 40-year-old adult. Engel's data show relatively rapid but decelerating growth of the measured structures up to about age 7 years, but with only one child over age 10 years little can be said about growth after age 7. Also, only two generations of airways were well described.

Although there is agreement on the sequence of events during postnatal lung growth, many fundamental questions remain. There is general agreement (although perhaps a lack of direct proof) that the full number of bronchial airways are present at birth and that alveolarization of bronchioles continues postnatally in a proximal direction. Bronchial airway growth generally parallels changes in stature, but there is confusion regarding details. This state of understanding is described in a review by Thurlbeck (1977), who summarizes in the following manner.

"*Airways.* Because airways do not increase in number, they must increase in dimension. The increase in dimension parallels the increase in stature, as shown by the measurement of anatomical dead space in children (Wood et al., 1971). Tracheal diameter increases directly with the increase in chest circumference (Hieronymi, 1961). However, there are discrepant views about the relative rate of growth of central and peripheral airways. This is of more than trivial interest—it has been shown that the

Received October 18, 1984; accepted March 14, 1985.

conductance of peripheral airways in children up to the age of 4 is considerably lower than in older children and in adults (Hogg et al., 1970). It has been suggested that this is why bronchiolitis is a life-threatening disease in small children; inflammation and narrowing of airways with low conductance would produce marked air flow obstruction. Hislop et al. (1972) considered that all airways grew proportionately and in parallel with lung volume changes. Cudmore et al. (1962) thought that the proximal airways grew faster than the distal airways. On the contrary, Hogg et al. (1970) found that there was a disproportionate increase in the diameter of distal airways compared to central airways up to the age of 5 years. It has also been suggested that the rate of growth depends on age and that length and diameter may differ. The most complete study, by Hieronymi (1961), indicated that proximal and distal airways enlarged equally but that their diameters increased slightly more than their lengths up to the age of 5 months. After 1 year, distal airways increased 12–30% more than the proximal airways, and the increase in diameter was consistently less than the increase in length" (p. 15).

The reasons for this lack of agreement on airway growth patterns are many and they apparently include a) differences in techniques used by various investigators, b) significant variability between individuals, c) sampling problems associated with the large numbers and variations in structure of lung airways, and d) relative dearth of normal anatomical tissue.

Despite the lack of quantitative information, recent pressure to estimate environmental risks faced by children has led to the use of a theoretically based tracheobronchial growth curve by Hofmann et al. (1979). For the purpose of establishing a formalized anatomy in support of inhaled particle deposition efficiency calculations, Hofmann et al. assumed a) that "the airways in the lung of a child are a miniature version of those of the adult and this relationship persists during postnatal growth," and b) that "the regional number of airways remains constant for the upper airways but changes with age for the lower airways." Hofmann's scaled tracheobronchial and parenchymal anatomy, based on an adult model of Landahl (1950), was constrained to give appropriate age-related total lung volumes. Recently Hofmann (1982a) published a more sophisticated model of children's airway growth. This second model was based on scaling the adult tracheobronchial model of Weibel (1963) to younger ages. Assumptions for this scaled model included, a) "the newborn lung is not the adult in miniature," b) "the (number of) nonrespiratory air passages down to the level of terminal bronchioles are complete at birth"; and c) "with progressing age each individual branch grows in a symmetrical way both in length and diameter and in constant relationship to the whole organ." This second-generation model was constrained to be consistent with age-related functional residual capacity and total lung volume. It is emphasized that neither of these growth models was based on actual measurements. Hofmann's models do not present data relating to branch angles or inclinations to gravity of airways. Also because Hofmann's dose calculations for particles inhaled by children did vary significantly as a function of age, the importance of accurately defining tracheobronchial growth is underscored.

Because inhaled particle deposition calculations are

among the important applications for morphometric data, the data requirements for computing deposition in the tracheobronchial tree will be examined. Yeh et al. (1976), in a review of the factors influencing inhaled particle deposition, addressed the anatomical input needed for modeling. The phenomena of diffusion, inertial impaction, and gravitational sedimentation were assumed to be adequate for describing the relevant particle behavior. Equations for deposition probabilities due to these phenomena, as used by Yeh and Schum (1980), are:

$$\text{Diffusion: } P_D = 4.07a^{2/3} - 2.4a - 0.446a^{4/3} + \dots$$

where $a = 1D/2r^2\bar{V}$, and l = tube length, D = particle diffusion coefficient, r = tube radius, \bar{V} = mean air velocity.

$$\text{Sedimentation: } P_S = 1 - \exp\left(\frac{-gC\rho D_p^2 l \cos b}{9\pi\mu r \bar{V}}\right)$$

where g = gravitational acceleration, C = Cunningham slip factor for particle, ρ = particle density, D_p = particle diameter, b = inclination of tube, μ = viscosity of air.

$$\text{Impaction: } P_I = 1 - \frac{2}{\pi} \cos^{-1}(\Theta S) + \frac{1}{\pi} \sin[2 \cos^{-1}(\Theta S)]$$

where Θ = branching angle, S = Stokes number = $C\rho D^2\bar{V}/36\mu r$.

Clearly, the anatomical information needed for such calculations consists of airway tube lengths, diameters, branching angles, and inclinations to gravity. The morphometric techniques for obtaining this information from replica casts of airways have been published (Phalen et al., 1978). These techniques involve establishing an idealized model of an airway branch (Fig. 1), defining the appropriate dimensions on this branch, and performing corresponding measurements on the tubular structures of replica airway casts.

METHODS

Casts

Because replica casts of the airways have been successfully used and validated for morphometric measurements in the past they were utilized for this study. When morphometric data are to be taken, cast artifacts should be minimized to the extent that is practical. The technical factors that relate to quality of the cast include a) the condition of the lung at death and alterations that occur during preparation and casting, b) use of a casting compound that has good characteristics with respect to filling the organ, replication of detail, and shrinkage, and c) location of the lung during casting, e.g., excised vs in situ. The saline-replacement in situ method using silicone rubber has been shown to produce sufficiently accurate casts (Yeh et al., 1975). This differs from the method of saline replacement by silicone rubber of Kilpper and Stidd (1973) only in that the lung is injected and the rubber is cured in situ at the time of autopsy.

The 20 casts used in this study were selected from a set of 28 made in situ by JD Mortensen using a varia-

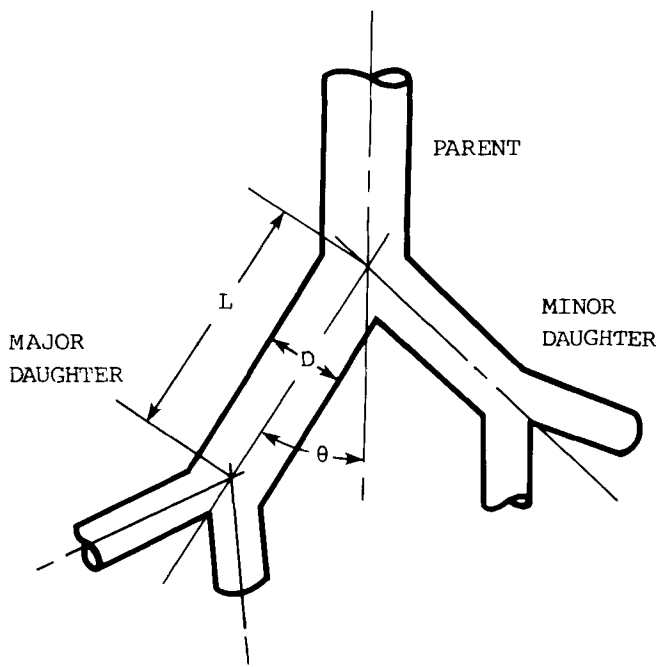

Fig. 1. Idealized airway branch showing parameters measured morphometrically on airway casts.

tion of a published technique (Phalen et al., 1973). The subjects (Table 1), aged 11 days to 21 years, had no recognizable chronic lung disease, and had died of causes not believed to alter the tracheobronchial structure greatly. Data taken at the time of casting included body mass and length, and chest circumference. Eight other casts were excluded owing to incomplete casting, gross abnormalities, or loss of portions of the casts. The relationship between age and body height is shown in Figure 2. Prior to silicone rubber injection the lung was de-aerated by ventilation with CO_2 , lavaged with saline to remove mucus, and filled with physiological saline. Dow Corning RTV 310 medical grade Silastic was mixed with catalyst and placed into an injector that displaced saline as it slowly filled the lung until the material would not flow (about 1 h of filling). All procedures were performed using a tracheal cannula. The silicone rubber was cured in situ for 24 h. After this period, the lungs were removed and the tissue was digested in sodium hydroxide. The casts were rinsed, dried, and subjected to measurement. A cast ready for measurements is shown in Figure 3.

Morphometric Measurements on Casts

Each airway measured was identified by a unique binary number (Phalen et al., 1973), and each measurement used for the model presented here was taken by morphometrists who were trained in lung cast measurements and had discussed and resolved any gross differences in technique. Further, over 90% of the measurements on the children's casts were independently measured by two morphometrists, a parity test was performed, and any tubes for which there were major disagreements were measured again by both. A linear

regression on the two morphometrists data yielded a correlation coefficient of 0.98, indicating excellent comparability on a tube-by-tube basis.

For each of the 20 lung casts used in this study, every airway down to the third division was measured. In addition, a terminal bronchiole in the upper lobe of each cast was marked with a thread tie and the entire pathway to the bronchiole was measured tube by tube. This pathway was typically 11 divisions. For each measured airway, length, diameter, and its branching angle were recorded. Additional measurements were made on several terminal bronchioles and the two divisions just proximal to them. In these measurements a single morphometrist measured lengths and diameters of the three divisions in a randomly selected area of the right upper lobe of each cast. In total, parameters were measured on about 500 individual airways.

Data Handling

Because of the great individual variability in tracheobronchial dimensions, and because we wished to derive models for all ages between birth and 18 years, it was decided to perform regressions of dimensions for each generation on some age-related body parameter such as body weight, chest circumference, or body length. It was hoped that one or more of these body parameters would have a linear relationship to airway dimensions. Airway lengths and diameters were found to be linearly correlated with body length and with chest circumference. Because it is easier to measure, body length was chosen. Thus, for each generation of airway, linear regressions on body length were performed. Although heel-to-crown measurements of length at autopsy are not actual height measurements, the two are nearly identical and are considered interchangeable for our purposes.

Two choices were available for defining the average adult's lung airway dimensions: grouping data from the

TABLE 1. Characteristics of the population from which cast measurements were made

Age (years)	Sex	Body length (cm)	Body mass (kg)
1.92	M	94	9.1
2.33	F	94.5	12.3
20.75	M	190	72.6
0.32	M	64.8	8.1
0.27	M	48	6.4
0.37	F	48	5.0
0.27	F	66	5.9
0.03	M	48	3.2
0.27	F	58.4	5.0
0.10	M	50.8	5.0
0.50	M	60.9	7.0
0.43	F	67.3	6.8
19.5	M	190.5	69.1
8.67	M	118	26
0.5	M	72.3	8.8
13.5	F	145	54.9
21	M	177.8	67
14	F	175.2	51
3	F	109	13.6
9.4	M	143.5	40.9

All casts were made in situ by Dr. Mortensen.

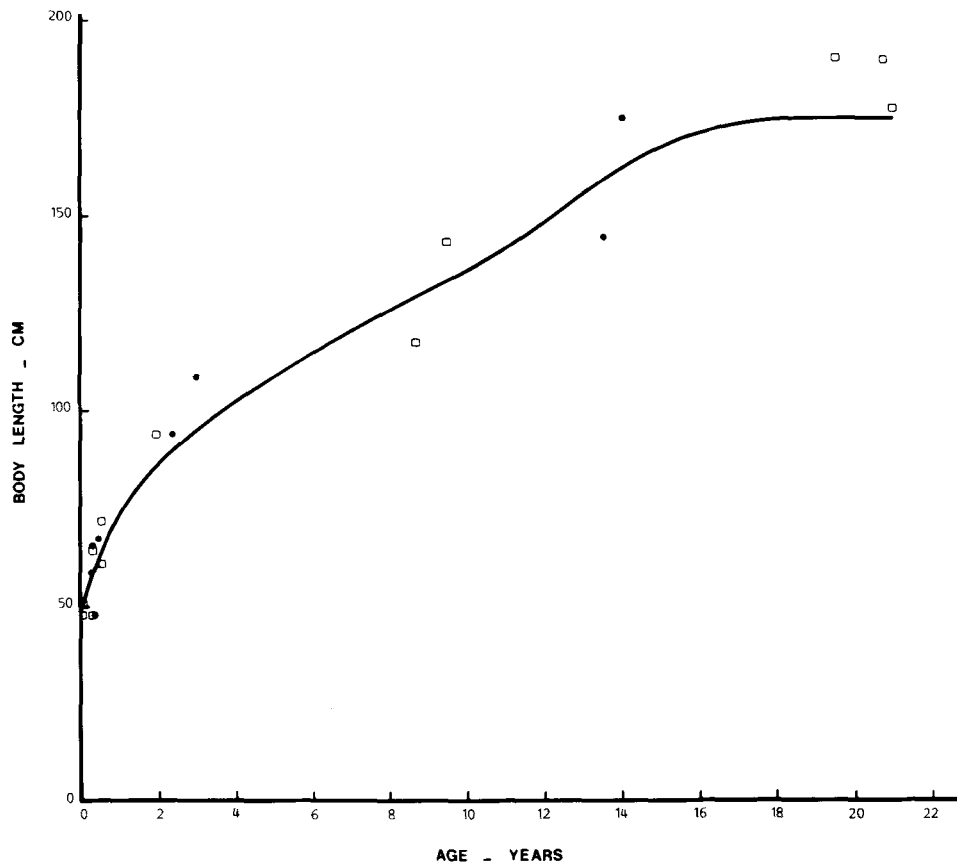

Fig. 2. Growth data for the 20 human subjects used for making airway measurements. Circles represent females and squares represent males. The curve is for U.S. males circa 1947-1966 (Altman and Dittmer, 1972).

oldest subjects, or using all of the casts and picking adult values from the linear regression equations. The linear regression equations were used to establish adult tracheobronchial dimensions by selecting airway dimension values at a body length of 175 cm. This number was arrived at by graphically fitting the length vs age data for our 6 oldest subjects (male and female) and reading the length at age 18 years (Fig. 2). This value is consistent with that for U.S. males between the years 1947 and 1966, but greater than that cited for females (Altman and Dittmer, 1972); this discrepancy may be due to a larger stature of children in more recent times.

Branch angles were not found to be correlated with age or body parameters strongly enough to indicate they changed during body growth. Accordingly, all data on branch angles were pooled at each generation regardless of age.

Particle Deposition Calculations

In order to examine the influence of tracheobronchial airway growth on the deposition of inhaled particles, our morphometric data were used as input into the particle deposition equations of Yeh and Schum (1980), which were previously shown. These equations had been verified for adults by comparison with actual particle deposition data in human subjects (Yeh and Schum, 1980), but their extension to children had not been tried.

Particle deposition calculations also require knowledge of air flows within the airways. Values for total airflow rates for humans of various ages, both at rest and during maximal exercise, were taken from a summary compilation of published values (Altman and Dittmer, 1971). Such ventilation data are well documented and of sufficient quality for use in modeling. The particle deposition calculations were performed using three ventilation states corresponding to low activity (10 liters/min for the adult), light exertion (20 liters/min for the adult), and heavy exertion (60 liters/min for the adult). Values for newborns, infants, children, and adolescents were scaled downward as linear functions of body mass. The air flow rates for selected ages, along with body height and mass are given in Table 2.

One notes that in the deposition equations, average inspiratory air flow through the trachea is twice the minute ventilation because inspiration occurs only over approximately 1/2 of the breathing cycle.

The particle diameters used for deposition calculations ranged from 0.05 μm to 10.0 μm micrometers; unit density and spherical shape were assumed.

Nomenclature for Tracheobronchial Generations

Because the human lung exhibits relatively symmetric dichotomous branching, the concept of "generations" or "divisions down" is useful for grouping airways

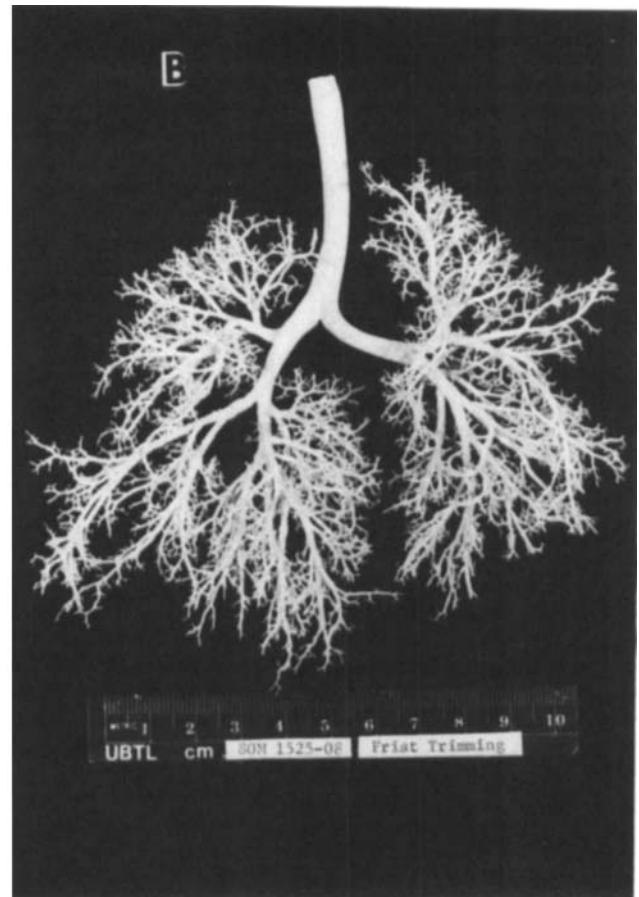
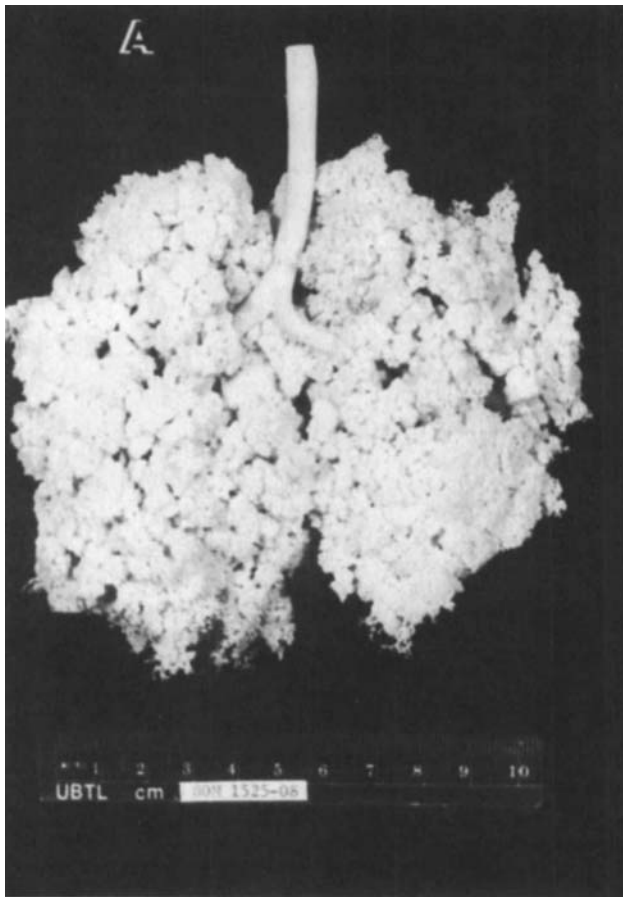

Fig. 3. Untrimmed (A) and trimmed (B) airway cast made in situ in a 4-month-old male. The trimmed version consists of the trachea and tracheobronchial tree including terminal bronchioles.

TABLE 2. Body mass, height, and minute ventilation at three levels of activity for selected ages

Age (years)	Mass (kg)	Height (cm)	Minute ventilation (l/m) ¹		
			Low activity	Light exertion	Heavy exertion
0	3.3	50	1.52	3.00	8.92
2	13.0	88	2.75	5.48	16.4
4	16.4	104	3.18	6.34	19.0
6	22.0	115	3.89	7.77	23.2
8	27.0	127	4.53	9.05	27.1
10	34.0	138	5.42	10.8	32.4
12	43.0	150	6.56	13.1	39.3
14	54.0	162	7.96	15.9	47.8
16	63.0	170	9.10	18.2	54.6
18	70.0	175	10.0	20.0	60.0

Values represent averages for males and females as determined from graphical fits of published tabulated data (Altman and Dittmer, 1971, 1972).

¹Terminology used for describing ventilation is arbitrary as no standard accepted definitions exist.

of similar size. This type of ordering is less useful for strongly monopodial branching systems, in which a given generation will contain airways with a large range in sizes and even different functions. For example the 10th generation in the dog contains bronchi, bronchioles, respiratory bronchioles, alveolar ducts, and al-

veolar sacs. Using the terminology of Weibel (1963) we named the trachea generation 0, that is, the 0th division down the tracheobronchial tree. Weibel used Z as the symbol for generation. The right and left main bronchi are Z = 1, their 4 daughters are Z = 2, and so forth down the tree.

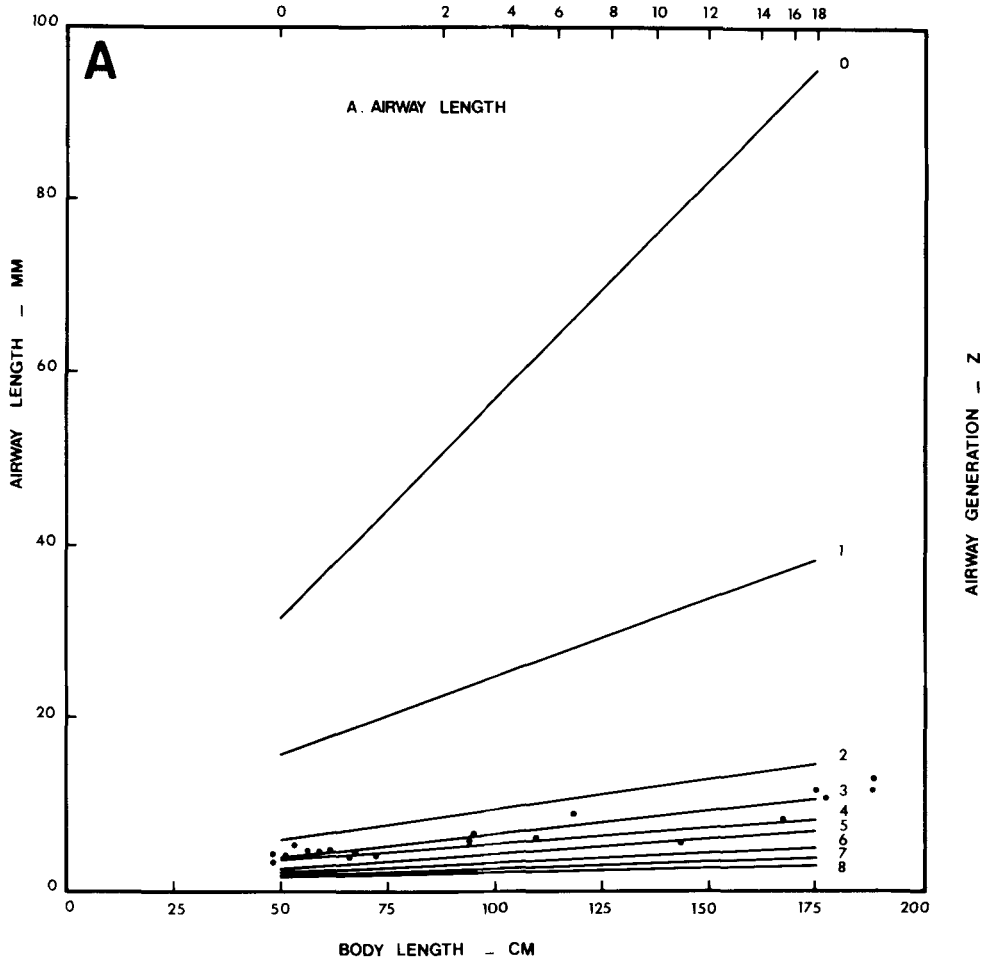

Fig. 4. Airway length (A) and diameter (B) as a function of body height as determined from morphometric measurements on airway casts. Actual morphometric data are shown for generation 3.

RESULTS

Tracheobronchial Morphometry

Trachea

Because the cannula used in the preparation of casts extended down into the trachea, direct measurements of tracheal length could not be made. Diameters were measured on 19 casts and the lengths calculated on the basis of a ratio of tracheal length to diameter of 5.0, as published for an in situ human cast (Yeh and Schum, 1980). Tracheal dimensions vs. body height were fitted by linear regression (corr = 0.97). The resulting regression equations can be used to compute tracheal length L_0 , or diameter D_0 , for any body height H . Adult values are computed with 175 cm used for H .

$$L_0 \text{ (mm)} = 0.50 H \text{ (cm)} + 1.5$$

$$D_0 \text{ (mm)} = 0.10 H \text{ (cm)} + 0.69$$

Bronchi, $Z = 1$ to $Z = 8$

Bronchi were distinguished by the presence of cartilage in their walls. Because the replica casts did not have any tissue remaining on them, a working definition for bronchi, $Z = 1$ through $Z = 8$, was used. For adults the luminal diameter of the average $Z = 8$ airway was about 1.8 mm. When bronchial dimensions for each generation were plotted vs. body height they demonstrated linear relationships with that parameter. Least-squares fits yielded the following growth equations, where L and D are in millimeters and H is in centimeters.

	SE; r (mm)		SE; r (mm)
$L_1 = 0.18 H + 6.79$	3.0; 0.95	$D_1 = 0.069 H + 0.886$	0.84; 0.97
$L_2 = 0.070 H + 2.46$	1.7; 0.88	$D_2 = 0.046 H + 0.982$	0.92; 0.92
$L_3 = 0.053 H + 1.24$	1.0; 0.93	$D_3 = 0.033 H + 0.937$	0.37; 0.98
$L_4 = 0.035 H + 1.96$	1.6; 0.75	$D_4 = 0.017 H + 0.999$	0.57; 0.83
$L_5 = 0.033 H + 1.13$	0.91; 0.88	$D_5 = 0.014 H + 0.711$	0.43; 0.85
$L_6 = 0.022 H + 1.12$	1.1; 0.71	$D_6 = 0.012 H + 0.541$	0.51; 0.78

AIRWAY DIAMETER vs. BODY LENGTH

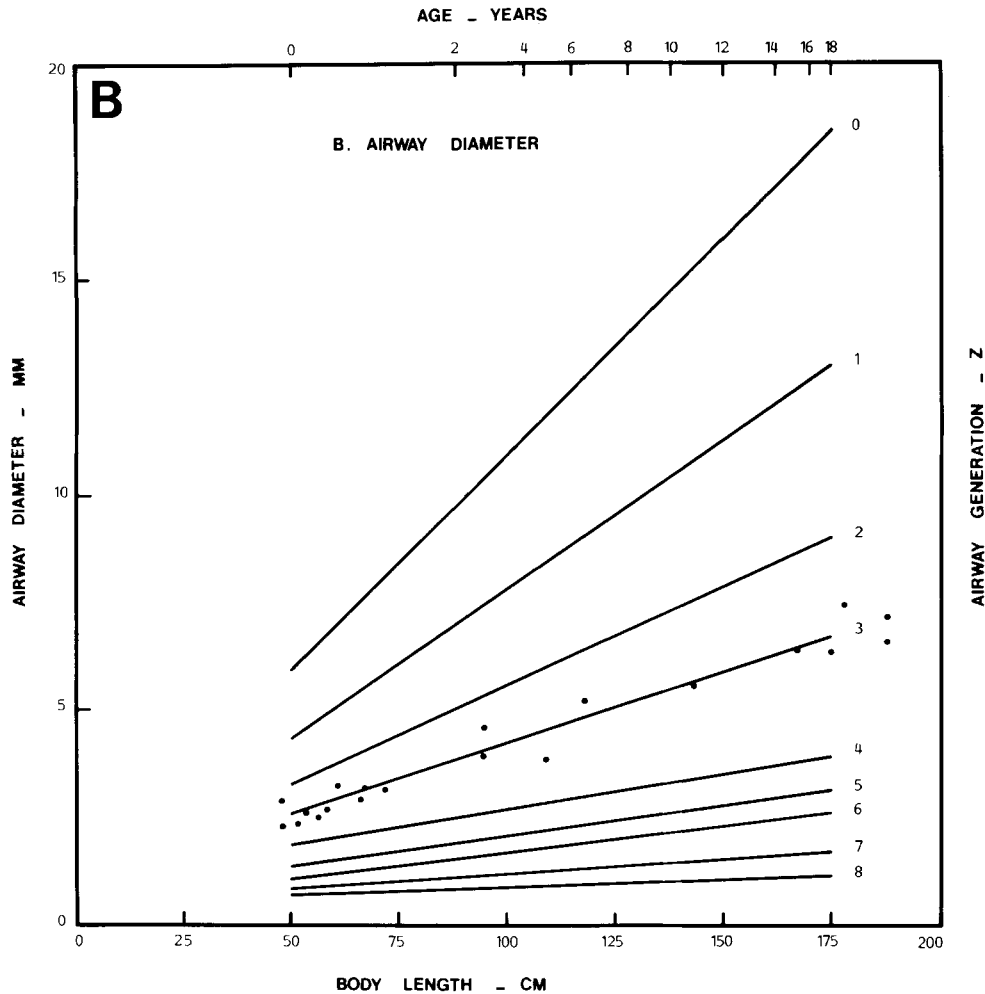

Figure 4. Continued.

$L_7 = 0.013 H + 1.33$	0.74; 0.66	$D_7 = 0.007 H + 0.496$	0.30; 0.78
$L_8 = 0.008 H + 1.52$	0.86; 0.42	$D_8 = 0.004 H + 0.499$	0.17; 0.78

These equations are based on actual morphometric data taken on all airways down to generation Z = 3, and airways in the right upper lobe only for Z = 4 through Z = 8. Although the data of Yeh and Schum (1980) indicate some differences in dimensions between whole-lung and upper lobe airways from Z = 4 through Z = 8, these differences are not systematic and therefore are not taken into account. The standard error (SE) is the mean standard error around the best-fit line; r is the correlation coefficient.

Bronchioles, Z = 9 to Z = 15

Morphometric measurements were made on several Z = 9 and Z = 10 airways as well as airways identified on casts as terminal bronchioles (having no alveoli but immediately preceding an alveolarized airway); all such measurements were from an upper lobe. In order to present a complete tracheobronchial model that is representative of the whole lung, two types of interpolation were necessary. First, the cast morphometric data of Yeh and Schum (1980) were used to correct upper lobe terminal bronchiole data to whole lung. Yeh and Schum reported data on the dimensions of human terminal bronchioles in each lobe in the entire lung. Their data indicate that the average terminal bronchiole is 17%

longer and 3% wider than the average right apical lobe terminal bronchiole. Thus, our values for length and diameter were multiplied by 1.17 and 1.03 respectively in order to apply our right apical lobe data to a whole-lung model. Also, growth equation constants for airways Z = 9 through Z = 15 were interpolated using a straight line (on a semilog plot) connecting the measured generations. The uncorrected equations for L and D (mm) vs H (cm) are shown below. In the equations for length and diameter one notes that the constants tend to decrease with increasing Z. This implies that not only do successive generations of airways decrease in size but also that the effect of body size (or growth) is smaller for deeper-lying airways.

$L_9 = 0.009 H + 1.30,$	$D_9 = 0.003 H + 0.488$
$L_{10} = 0.007 H + 1.29,$	$D_{10} = 0.002 H + 0.479$
$L_{11} = 0.006 H + 1.27,$	$D_{11} = 0.001 H + 0.461$
$L_{12} = 0.005 H + 1.25,$	$D_{12} = 0.0009 H + 0.452$
$L_{13} = 0.004 H + 1.23,$	$D_{13} = 0.0006 H + 0.440$
$L_{14} = 0.003 H + 1.21,$	$D_{14} = 0.0004 H + 0.429$
$L_{15} = 0.002 H + 1.20,$	$D_{15} = 0.0002 H + 0.419$

Figure 4 illustrates growth curves for airway lengths and diameters for the human tracheobronchial tree; ac-

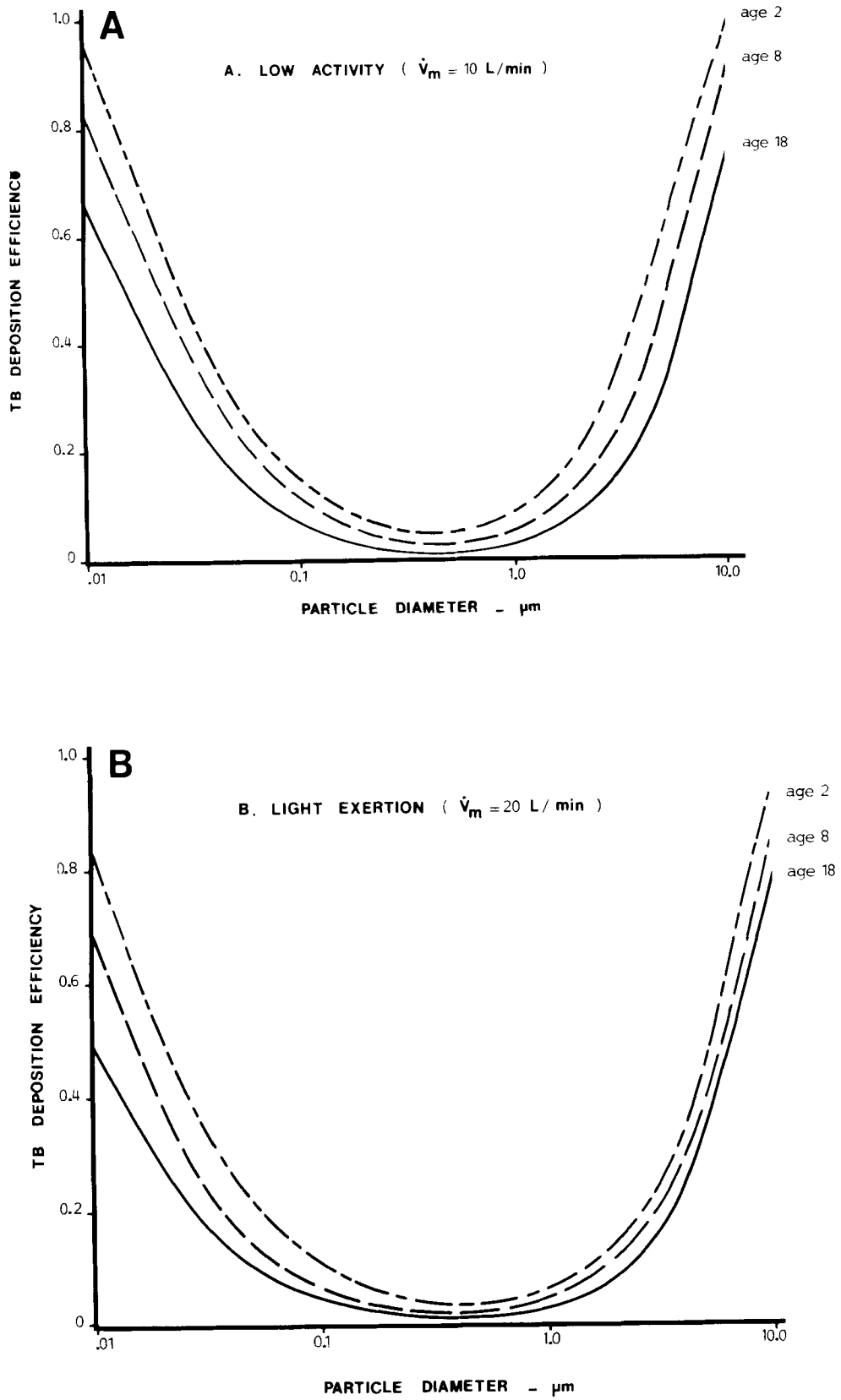

Fig. 5. Computed particle deposition efficiencies vs. particle size for ages 2, 8, and 18 years at three ventilatory states: A) low activity, B) light exertion, and C) heavy exertion.

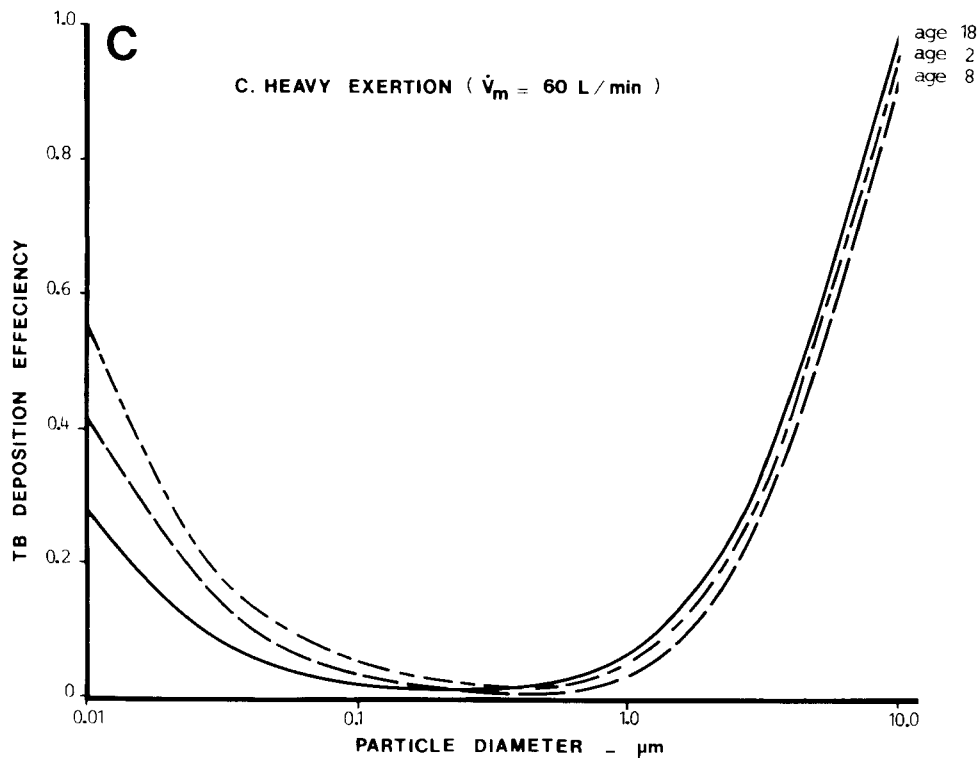

Figure 5. Continued.

tual measured values for $Z = 3$ are also shown. Table 3 shows the adult tracheobronchial model that was developed in this study. Although Yeh and Schum (1980) have used 60° for gravity angles of distal airways, the actual measured data appear to approach 45° . Thus 45° was assumed as the gravity angle of airways beyond generation 13.

Computed Particle Deposition

Particle deposition efficiencies, expressed as a fraction of those entering the trachea, were calculated as functions of age, particle diameter, and ventilatory state. Figure 5 shows the computed particle deposition efficiencies for particle diameters from $0.05 \mu\text{m}$ to $10.0 \mu\text{m}$ for three representative ages and three states of venti-

TABLE 3. Adult tracheobronchial airways model

Structure	UCI/UBTL adult lung model—version A					
	Gen. (Z)	L (mm)	D (mm)	θ ($^\circ$) ¹	ϕ ($^\circ$) ²	ΣV (ml) ³
Trachea	0	89.0	17.7	0	0	22
Bronchi	1	38.3	13.0	36	20	32
	2	14.7	9.1	35	31	36
	3	10.5	6.7	28	43	39
	4	8.0	4.0	35	39	40
	5	7.0	3.1	39	39	42
	6	4.9	2.7	34	40	44
	7	3.6	2.2	48	36	46
Bronchioles	8	3.3	1.8	53	39	48
	9	3.0	1.5	54	45	51
	10	2.7	1.2	51	43	54
	11	2.5	1.0	46	45	58
	12	2.2	0.82	47	45	62
	13	2.0	0.68	48	45	68
	14	1.8	0.55	52	45	75
	15	1.7	0.46	45	45	85
Term. bronchiole						

Model applies to a person 18 years of age, 175 cm tall, and of 70 kg body mass.

¹Branch angles are assumed to be independent of age.

²For gravity angle, the value of Yeh and Schum (1980) is used to generation 13 and 45° is assumed thereafter.

³Cumulative volume assuming each airway gives rise to two daughters.

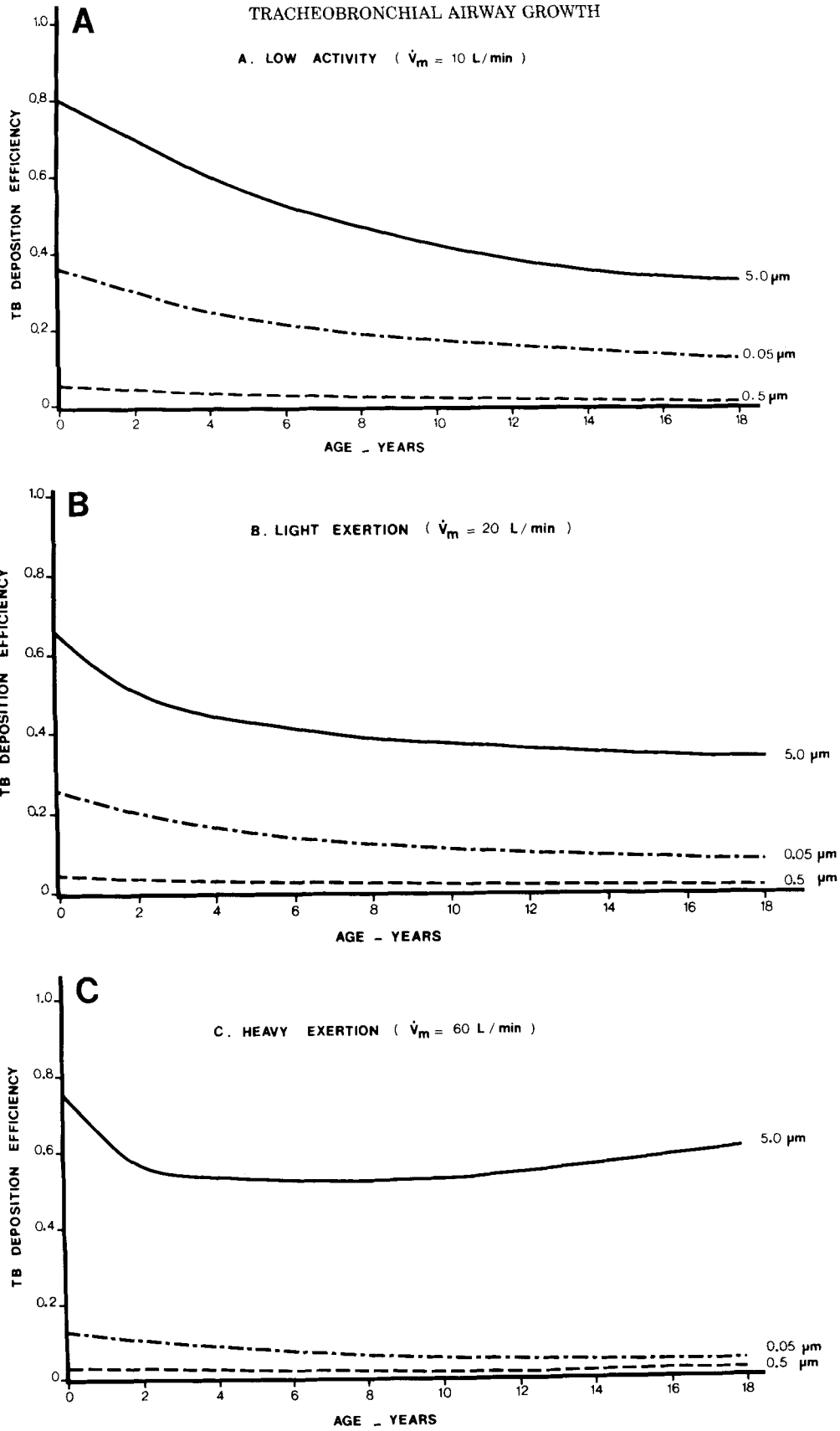

Fig. 6. Computed particle deposition efficiencies vs. age for three aerosol particle diameters and three ventilatory states: A) low activity, B) light exertion, and C) heavy exertion. Efficiencies are fractions of number of particles entering the trachea.

lation. Each curve has a minimum at about $0.5 \mu\text{m}$ particle diameter. This minimum is due to the fact that for such size particles, sedimentation, impaction, and diffusion are all inefficient deposition mechanisms. At higher flow rates, diffusional deposition is less efficient and the deposition efficiencies for small particles are seen to decrease as flow rate increases. As flow rate increases, the effects of impaction are increased and the effects of sedimentation decreased. These phenomena are seen on the curves for particles larger than about $0.5 \mu\text{m}$. In general, increasing age is associated with decreasing particle deposition efficiency. This is not necessarily the case at high flow rates and large particle diameters, as seen in Figure 5C.

Figure 6 shows deposition data for three particle sizes and three ventilatory states vs. age. The particle sizes are selected to demonstrate that particles near $0.5 \mu\text{m}$ diameter have low deposition efficiencies, relative to those smaller or larger. These curves clearly show the effects of age on predicted particle deposition.

DISCUSSION

Comparison With Previous Morphometric Data

The developed adult tracheobronchial model compares favorably with those of Weibel (1963), Horsfield and Cumming (1967) and Horsfield et al. (1971), and Yeh and Schum (1980). What differences do exist may be due either to natural variability in anatomy or due to the fact that our model represents the 18-year-old and the former models were presumably developed using older adults.

Our growth models can be compared with the measurements on large airways of Engel (1913) and of Scammon (1923), and with the largely theoretical second model of Hofmann (1982a). Such comparisons are somewhat difficult because the former authors relied upon age rather than height. In general, at a given age our model airways are usually larger than those formerly reported. It is noted that our subjects tended to be larger in stature at a given age than children were in the past (Altman and Dittmer, 1972). Thus, age is not as useful as height (or sitting height) for growth curves. The model presented here is not irreconcilable with the earlier work and is based on a larger number of measurements and a larger number of subjects than any of the previous models.

Computed Particle Deposition

For adults, the computed particle deposition efficiencies are comparable to laboratory measurements of tracheobronchial deposition in human subjects (Lippmann et al., 1971). Our computations are also in basic agreement with other model calculations (Task Group on Lung Dynamics, 1966; Chan and Lippmann, 1980). Figure 7 illustrates these comparisons.

Comparable predictions for children for a wide range of particle sizes have not been published previously. Hofmann (1982b) published computed deposition probabilities (deposition per 1 cm^2 of surface area) for submicrometer particles ($0.08 \mu\text{m}$) for airway generation 6 as a function of age. His computation predicted that deposition was highest in the newborn, decreased with increasing age to 21 years, and remained constant for greater ages. Our calculations are in agreement with this prediction.

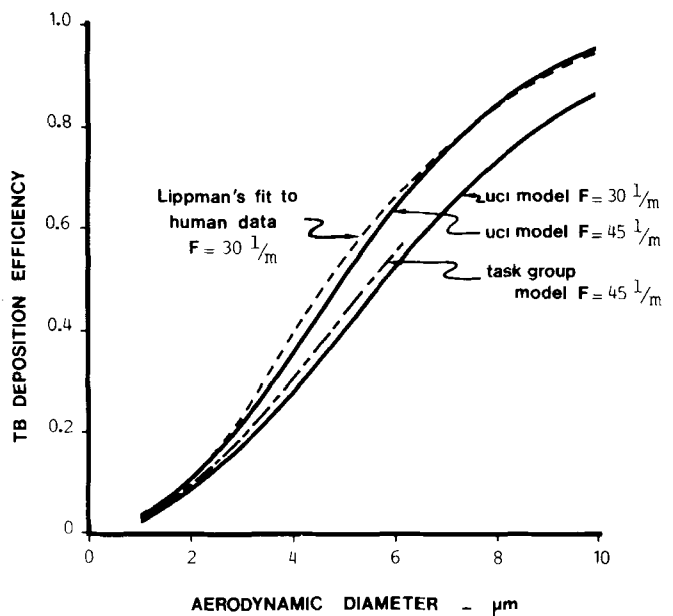

Fig. 7. Comparison of model predictions for tracheobronchial deposition efficiencies (as fraction of number entering trachea) for particles. Lippmann's curve is an empirical fit to data acquired from nonsmoking adults (Lippmann et al., 1971; Chan and Lippmann, 1980). The Task Group curve is theoretical (Task Group on Lung Dynamics, 1966). Two of our (UCI) computed curves are shown. The flows given are twice the minute ventilation. Values reported by Stahlhofen et al. (1981) are not included because of uncertainties in mouth deposition, but these values tend to fall below those shown.

Implications as to Comparative Risks From Inhaled Particles

The model predictions indicate that smaller individuals will generally receive greater initial particle deposition within the tracheobronchial tree (as a fraction of particles entering the trachea) than larger individuals at a given ventilatory state. (The predictions apply most directly to mouth breathing or tracheotomized individuals.) Also, because minute ventilation at a given state of activity is approximately linearly related to body mass plus an additional constant, under similar circumstances of activity the smaller person inhales more air per unit body mass. Therefore higher initial tracheobronchial doses on a per unit body mass basis are predicted for younger (smaller) people. Figure 8 shows an example of this age-related dose effect for several particle sizes at resting ventilation. If all other factors were identical between a young person and an adult, the young person might be at greater risk from many types of airborne particles. These other factors include deposition efficiency in the nasal, oral, and pharyngeal airways and at the larynx; speed and efficiency of clearance of deposited material; efficiency of defenses such as acid neutralization by airway ammonia; and tissue sensitivity.

Model Dead Space

The tracheobronchial morphometric data can be used to calculate an anatomical tracheobronchial tree dead space for any age. Further, this cast dead space can be compared to functional, physiological, and anatomical dead space measurements in living subjects. Several

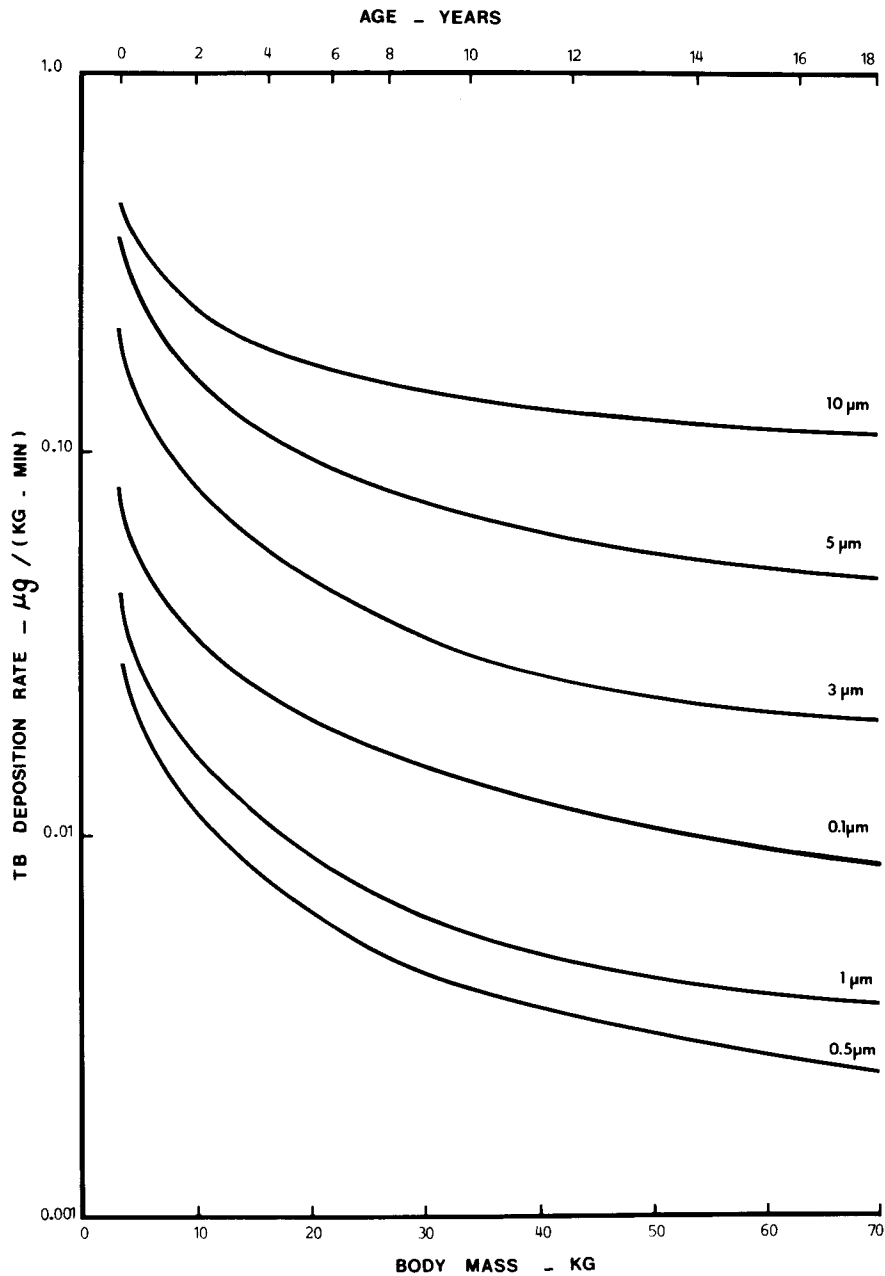

Fig. 8. Predicted initial dose to the tracheobronchial region as a function of body mass. Assumptions include equivalent upper airway deposition for all ages, inhalation of particles at 1 mg/m^3 concentration in air, and resting minute ventilation V_m . The equation used to generate the curves was: $D_{TB} = V_m (\text{m}^3/\text{min}) P_{TB} 1 (\text{mg}/\text{m}^3)/\text{body mass (kg)}$, where P_{TB} is the appropriate tracheobronchial deposition efficiency.

major problems arise in such a comparison. First, the morphometric measurements do not include respiratory bronchioles, which contribute a quantitatively unknown portion of the dead space. Also, in computing dead space from morphometric measurements the number of airways at a given generation Z is usually assumed to be equal to 2^Z . This assumption does not take into account the natural heterogeneity in the numbers of branches leading to alveoli. Moreover, functionally assessed dead

space can vary by a multiple of 2 or more, depending upon such factors as body position, point in the breathing cycle, age, presence of disease, and measurement technique (Altman and Dittmer, 1971). Our dead space calculations from casts tend to give values for most ages that are lower than mean values obtained by functional measurements (Hart et al., 1963). The cast values are within the span of functional measurements (Wood et al., 1971).

Patterns of Airway Growth

Although the possibility exists that undiscovered artifacts are associated with the in situ lung casting technique, our quantitative data can be used to shed new light on the ways in which human airways grow. All generations of airways appear to grow in length and in diameter in proportion to body height, but the proportionality constant is larger for larger airways (those with smaller Z numbers). Larger airways grow proportionately more rapidly than smaller ones. Thus our data are consistent with the prior observations of Cudmore et al. (1962) that proximal airways grow faster than distal ones.

For all airway generations during body growth the absolute increase in length is larger than the absolute increase in diameter. However, because airway diameters are smaller than their lengths, the length-to-diameter ratio does not always increase during growth. This ratio does not follow any simple pattern during growth. Length-to-diameter ratios decrease slightly with increasing age for Z equals 0-2 and 6-8: For all other Z the ratio increases slightly.

ACKNOWLEDGMENTS

The authors thank Kathleen Stout of UBTL for assistance in facilitating morphometric measurements. Pamela Swick and Sonia Usdansky for aid in preparation of the manuscript, Tuan Nguyen for preparation of the illustrations, and Dr. Dane Westerdahl, Dr. James Whittenberger, and Dr. Michael Kleinman for technical suggestions for the manuscript. The research was supported by the California Air Resources Board (contract No. AO-128-32). The lung casts were made at UBTL under contract (No. 68-01-4980) with the Office of Radiation Programs, U.S. Environmental Protection Agency (Neal Nelson, Ph.D., project officer).

LITERATURE CITED

- Altman, P.L., and D.S. Dittmer eds. (1971) *Respiration and Circulation*. Federation of American Societies for Experimental Biology, Bethesda, MD, pp. 40-41, 78-84.
- Altman, P.L., and D.S. Dittmer, eds. (1972) *Biology Data Book*, 2nd Ed. Federation of American Societies for Experimental Biology, Bethesda, MD, Vol. 1, pp. 195-201.
- Chan, T.L., and M. Lippmann (1980) Experimental measurements and empirical modelling of the regional deposition of inhaled particles in humans. *Am. Ind. Hyg. Assoc. J.*, *41*:399-409.
- Cudmore, R.E., J.L. Emery, and A. Mithal (1962) Postnatal growth of bronchi and bronchioles. *Arch. Dis. Child*, *37*:481-484.
- Engel, S. (1913) Form, Lage und Lageveränderungen des Bronchialbaumes im Kindesalter. *Arch. Kinderheilk.*, *60*:267-288.
- Hart, M.D., M.M. Orzalesi, and C.D. Cook (1963) Relation between anatomic respiratory dead space and body size and lung volume. *J. Appl. Physiol.*, *18*:519-522.
- Hieronymi, G. (1961) Über den Durch das Alter bedingten formwandel menschlicher Lungen. *Ergeb. Allerg. Pathol. Anat.*, *41*:1-62.
- Hislop, A., D.C.F. Muir, M. Jacobsen, G. Simon, and L. Reid (1972) Postnatal growth and function of the pre-acinar pathways. *Thorax*, *27*:265-274.
- Hofmann, W. (1982a) Mathematical model for the postnatal growth of the human lung. *Respir. Physiol.*, *49*:115-129.
- Hofmann, W. (1982b) Dose calculations for the respiratory tract from inhaled natural radioactive nuclides as a function of age. II. *Health Phys.*, *43*:31-44.
- Hofmann, W., F. Steinhäusler, and E. Pohl (1979) Dose calculations for the respiratory tract from inhaled natural radioactive nuclides as a function of age. I. Compartmental deposition, retention and resulting dose. *Health Phys.*, *37*:517-532.
- Hogg, J.C., J. Williams, J.B. Richardson, P. Macklem, and W.M. Thurlbeck (1970) Age as a factor in the distribution of lower airway conductance and in the pathologic anatomy of obstructive lung disease. *N. Engl. J. Med.*, *282*:1283-1287.
- Horsfield, K., and G. Cumming (1967) Angles of branching and diameters of branches in the human bronchial tree. *Bull. Math. Biophys.*, *29*:245-259.
- Horsfield, K., G. Dart, D.E. Olson, G.F. Filley, and G. Cumming (1971) Models of the human bronchial tree. *J. Appl. Physiol.*, *31*:207-217.
- Kilpper, R.W., and P.J. Stidd (1973) A wet-lung technique for obtaining Silastic rubber casts of the respiratory airways. *Anat. Rec.*, *176*:279-288.
- Landahl, H.D. (1950) On the removal of air-borne droplets by the human respiratory tract. I. The lung. *Bull. Math. Biophys.*, *12*:43-56.
- Lippmann, M., R.E. Albert, and H.T. Peterson, Jr. (1971) The regional deposition of inhaled aerosols in man. In: *Inhaled Particles III*. W.H. Walton, ed. Unwin Brothers Limited, Old Working, Surrey, England, pp. 105-122.
- Phalen, R.F., H.C. Yeh, O.G. Raabe, and D.J. Velasquez (1973) Casting the lungs in situ. *Anat. Rec.*, *177*:255-263.
- Phalen, R.F., H.C. Yeh, G.M. Schum, and O.G. Raabe (1978) Applications of an idealized model to morphometry of the mammalian tracheobronchial tree. *Anat. Rec.*, *190*:167-176.
- Scammon, R.E. (1923) The trachea. In: *Pediatrics*. I.A. Abt, ed. W.B. Saunders, Philadelphia, pp. 344-348.
- Stahlhofen, W., J. Gebhart, and J. Heyder (1981) Biological variability of regional deposition of aerosol particles in the human respiratory tract. *Am. Ind. Hyg. Assoc. J.*, *42*:348-352.
- Task Group on Lung Dynamics. (1966) Deposition and retention models for internal dosimetry of the human respiratory tract. *Health Phys.*, *12*:173-207.
- Thurlbeck, W.M. (1977) Structure of the lungs. In: *Respiratory Physiology II*. J.G. Widdicombe, ed. University Park Press, Baltimore, MD, Vol. 74, Chapt. 1, pp. 1-34.
- Weibel, E.R. (1963) *Morphometry of the Human Lung*. Springer-Verlag, Berlin.
- Wood, L.D.H., S. Prichard, T.R. Weng, K. Kruger, A.C. Bryan, and H. Levison (1971) Relationship between anatomic dead space and body size in health, asthma and cystic fibrosis. *Am. Rev. Respir. Dis.*, *104*:215-222.
- Yeh, H.C., and G.M. Schum (1980) Models of human lung airways and their application to inhaled particle deposition. *Bull. Math. Biol.*, *42*:461-480.
- Yeh, H.C., A.J. Hulbert, R.F. Phalen, D.J. Velasquez, and T.D. Harris (1975) A stereoradiographic technique and its application to the evaluation of lung casts. *Invest. Radiol.*, *10*:351-357.
- Yeh, H.C., R.F. Phalen, and O.G. Raabe (1976) Factors in influencing the deposition of inhaled particles. *Environ. Health Perspect.*, *15*:147-156.