

© 2012 IEEE. Personal use of this material is permitted. Permission from IEEE must be obtained for all other uses, in any current or future media, including reprinting/republishing this material for advertising or promotional purposes, creating new collective works, for resale or redistribution to servers or lists, or reuse of any copyrighted component of this work in other works.

Digital Object Identifier (DOI): [10.1109/TIA.2011.2181290](https://doi.org/10.1109/TIA.2011.2181290)

IEEE Transactions on Industry Applications. 48, 2, pp. 708-719 11

Power Electronics Converters for Wind Turbine Systems

Frede Blaabjerg
Marco Liserre
Ke Ma

Suggested Citation

Blaabjerg, F., Liserre, M. & Ma K., "Power Electronics Converters for Wind Turbine Systems," 19 mar 2012 | IEEE Transactions on Industry Applications. 48, 2, pp. 708-719 11

Power Electronics Converters for Wind Turbine Systems

F. Blaabjerg¹, M. Liserre², K. Ma¹

¹Department of Energy Technology, Aalborg University
Pontoppidanstraede 101, DK-9220 Aalborg East, Denmark
fbl@et.aau.dk, kema@et.aau.dk

²Dept. of Electrotechnical and Electronic Engineering
Polytechnic of Bari
Via E.Orabona 4, 70125 - Bari, Italy
liserre@poliba.it

Abstract – The steady growth of installed wind power together with the up-scaling of the single wind turbine power capability has pushed the research and development of power converters towards full scale power conversion, lowered cost pr kW, increased power density and also the need for higher reliability. In this paper, power converter technologies are reviewed with focus on existing ones and on those that have potential for higher power but which have not been yet adopted due to the important risk associated with the high power industry. The power converters are classified into single- and multi-cell topologies, in the latter case with attention to series connection and parallel connection either electrical or magnetic ones (multi-phase/windings machines/transformers). It is concluded that as the power level increases in wind turbines, medium voltage power converters will be a dominant power converter configuration but continuously cost and reliability are important issues to be addressed.

I. INTRODUCTION

Wind turbine system (WTS) technology is still the most promising renewable energy technology. It started in the 1980's with a few tens of kW production power per unit. Today multi-MW size wind turbines are being installed [1]-[4] and they are very advanced power generators. There is a wide-spread use of wind turbine systems in the distribution networks as well as there are more and more wind power stations which are connected to the transmission networks. Denmark for example has a high power capacity penetration (> 30 %) of wind energy in major areas of the country and today 25 % of all the electrical energy consumption is covered by wind energy. The aim is to achieve a 100 % non-fossil based power generation system in 2050 [5]. Initially, wind power did not have any serious impact on the power system control, but now due to its size, wind power has to play a much more active part in grid operation and control. The technology used in wind turbines was originally based on a squirrel-cage induction generator connected directly to the grid. Power pulsations in the wind were almost directly transferred to the electrical grid by using this technology as the speed is fixed (limited slip range). Furthermore, no dynamic control of the active and reactive power exists except for a few capacitor banks which ensured unity power factor at the Point of Common Coupling (PCC). As the power capacity of the wind turbines increases regulating the

frequency and the voltage in the grid become even more important and in the last decade it has become necessary to introduce power electronics [6] as an intelligent interface between the wind turbine and the grid. Power electronics is changing the basic characteristic of the wind turbine from being an energy source to being an active power source for the grid. The electrical technology used in the wind turbine is not new. It has been discussed for several decades but now the cost per kW of new wind power plant is comparable and even lower than coal power plant's one, hence solutions with power electronics are very attractive [7].

This paper provides an overview of existing power electronics technologies in wind turbines and on those that have the potential for higher power wind turbine systems. In fact the most recent finding of the Upwind European project are that 20 MW wind turbine is feasible provided some key innovations are developed and integrated [8]. Given the limited technical literature details about power converter configuration in industrial products, the paper aims on classifying the solutions proposed in scientific literature but which have not been presented in a comprehensive way. First, the basic market developments are discussed with a focus on cost, size and power density, also in respect to the adopted generator technology, to the filter and transformer and to the switching devices used. Next, wind conversion is discussed with attention on two competing philosophies – one with reduced power converter which has been popular up to now – a second with a full scale power converter which is becoming more and more the preferred choice. The most promising power converter topologies for wind turbines are further presented and compared by classifying them into single-cell and multi-cell structure. Reliability issues are also discussed in this context as it becomes more and more important.

II. WIND TURBINE SYSTEMS

Wind power has until now grown to a cumulative worldwide installation level of 200 GW with close to 40 GW installed alone in 2010, according to BTM Consult, indicating that wind power is really an important player in some areas of the world [9]. The worldwide penetration of wind power electricity was 1.8% and the prediction for 2019 is more than 8% or 1 TW cumulative installations. China was the largest

market in 2010 and in general the EU, the USA and China are sharing around one third of the total market. The global accumulated installed power capacity is shown in Fig. 1.

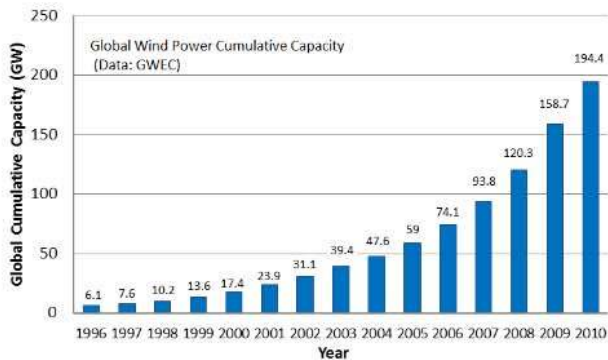

Fig. 1. Annual global cumulative installed wind power capacity from 1996 to 2010 (Source: GWEC).

In 2010, the Danish company Vestas Wind Systems A/S was still in the top position among the largest manufacturers of wind turbines in the world, closely followed by the Chinese company Sinovel as the second largest in the world. This company was third in 2009 and this data gives some idea of the impressive interest in Asia for wind energy. Fig. 2 shows the wind turbine top suppliers in 2010, also published by BTM Consult.

A. Generators in wind turbine systems

Synchronous generators, either externally excited or with permanent magnets, are becoming the preferred technology in the best seller power range [1]-[4]. Multi-pole PMSG with a full power back-to-back converter looks to become the most adopted generator in the near future due to the reduced losses and lower weight if compared to the externally excited SG that is manufactured successfully by, e.g., the German company Enercon. In the last case the generator is an annular generator and rotor current is used to regulate the dc-link voltage. The transition seems mainly to be valid for larger wind turbines (3-6 MW). However, the increased prices of rare-earth magnets might change the philosophy of wind turbine drive trains to avoid to high risk in expenses.

B. Power electronics converters in wind turbine systems

The penetration of power electronics in wind turbine systems has been continuously growing since the 1980's, when it consisted of a thyristor-based soft-starter just for initially interconnecting the wind turbine and after that being by-passed and the generator was operating directly to the grid. In the 1990's, it was mainly the use of rotor resistance control with a diode bridge and a power electronic switch; finally the back-to-back power converter emerged, first in reduced power for DFIG, then in full power [2], [3], [6]. Fig. 3 shows the evolution of WTS size and the use of power electronics capacity highlighted with an inner circle in blue. The most adopted solution in power converters for wind turbine systems in the best seller range 1.5-3 MW is the use of two two-level voltage source converters in a back-to-back configuration [1]. At lower and higher powers it is possible to

find other solutions such as a diode-bridge for the generator in the case of a synchronous generator and also the use of multilevel converters to enter medium voltage for high power applications.

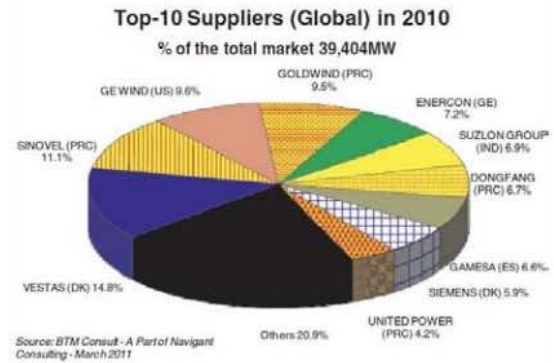

Fig. 2. Wind turbine market share distributed by manufacturers in 2010. (Source: BTM Consult).

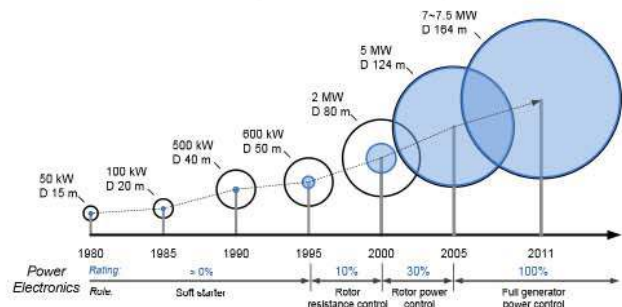

Fig. 3. Wind turbine evolution and the main trend of power electronic conversion (blue indicates power level of converters) in the last 30 years.

The demands posed on power electronic converters for wind turbine systems are depicted in Fig. 4.

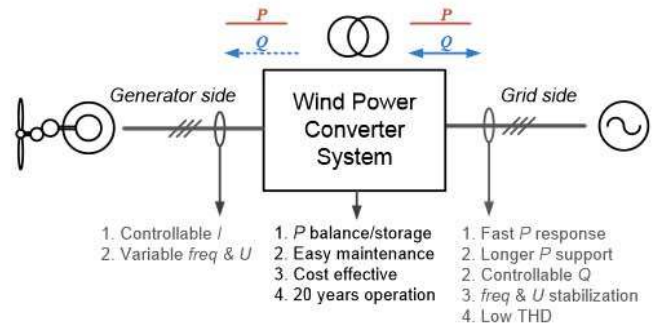

Fig. 4. Wind power conversion and demands to power electronics.

As the interface between the wind turbine generator and power grid, the wind power converter has to satisfy the requirements to both sides. For the generator side: the current flowing in the generator stator should be controlled to adjust torque and as a consequence the rotating speed. This will contribute to the active power balance in normal operation when extracting the maximum power from the wind turbine but also in the case grid faults appears [4]. Moreover, the converter should have the ability to handle variable

Table I. Main switching devices for wind power converters.

	IGBT module	IGBT Press-pack	IGCT Press-pack
Power Density	Moderate	High	High
Reliability	Moderate	High	High
Cost	Moderate	High	High
Failure mode	Open circuit	Short circuit	Short circuit
Easy maintenance	+	-	-
Insulation of heat sink	+	-	-
Snubber requirement	-	-	+
Thermal resistance	Moderate	Small	Small
Switching loss	Low	Low	High
Conduction loss	High	High	Low
Gate driver	Small	Small	Large
Major manufacturers	Infincon, Mitsubishi ABB, Semikron, Fuji	Westcode, ABB	ABB
Medium voltage ratings	3.3 kV / 4.5 kV / 6.5kV	2.5 kV / 4.5 kV	4.5 kV / 6.5 kV
Max. current ratings	1.5 kV / 1.2 kA / 750 A	2.2 kA / 2.4 kA	2.1 kA / 1.3 kA

fundamental frequency and voltage amplitude of the generator output to control the speed.

For the grid side: the converter must comply with the grid codes regardless of the wind speed. This means it should have the ability to control the inductive/capacitive reactive power Q, and perform a fast active power P response. The fundamental frequency as well as voltage amplitude on the grid side should be almost fixed under normal operation, and the Total Harmonic Distortion (THD) of the current must be maintained at a low level [6], [10], [11].

Inherently, the converter needs to satisfy both the generator side and grid side requirements with a cost effective and easy maintenance solution. This requires a high power density, reliability and modularity of the entire converter system. Moreover, the wind power converter may need the ability to store the active power, and boost up the voltage from the generator side to the grid side [1].

C. Transformers and filters in wind turbine systems

Transformers and filters have a pivotal role for volume and losses. All wind turbine manufacturers are using a step-up transformer for connecting the generator to the grid. Research is on-going in order to replace it with a transformer with a unity transformer ratio or even maybe to avoid it - leading to high-power and high-voltage transformerless solutions [12] which is a technological challenge. Regarding filters, typically an LCL-filter is the adopted solution to attenuate PWM harmonics [13] but in the case a diode-bridge is adopted on the generator side and in the case of higher power WTS have also strict demands to grid voltage harmonics. Trap filters might also be adopted in the final solution. Damping of resonances, associated to the LCL-filter, is important also and the use of passive damping can create high losses (and thereby lower energy production) and compromise the attenuation of PWM harmonics provided by

the filter. This may lead to the use of active damping, acting on the controller structure or to use more complex passive damping solutions [14].

D. Switching devices

The latest development in switching devices is playing an important role in the development of higher power converters for wind turbines with increased reliability and efficiency. The main choices are IGBT modules, IGBT press-pack and IGCT press-pack as shown in Table I.

The press-pack technology leads to an increase in reliability, yet to be scientifically proven but known from industrial experience, higher power density (easier stacking for series connection) and better cooling capability at the price of an higher cost compared to power modules. Press-pack IGCT supports the development of MV converters and are already state of the art in high power electric drives (e.g. for oil and gas application) but not yet widely adopted in the wind turbine industry also because of cost issues [15]-[17].

However the module technology has longer record of applications and less mounting problems. Moreover the most critical point for reliability, the lift-off - due to thermal cycling - of the bond-wires used to connect the dies in the module [15], is an area of ongoing improvements both in materials [18] and solution (use of flexible foils instead of bond-wires leading to 35% reduction in volume [19]).

III. WIND TURBINE CONCEPTS

As shown in Fig. 3 more and more power electronics have been incorporated into wind turbine systems to improve wind turbine control and to improve the interconnection to the grid system. In this paper, focus is primarily on the systems where complete control of active and reactive power can be obtained

in all operating points by using partial-scale power converter or full scale power converter.

A. Variable Speed WT with Partial-scale Power Converter

The most adopted partial scale frequency converter is adopted in conjunction with the Doubly-Fed Induction Generator (DFIG) concept, which gives a variable speed controlled wind turbine with a Wound Rotor Induction Generator (WRIG) and partial scale power converter (rated to approx. 30% of nominal generator power) on the rotor circuit. The topology is shown in Fig. 5.

The stator is directly connected to the grid, while a partial-scale power converter controls the rotor frequency and thus the rotor speed. The power rating of this partial-scale frequency converter defines the speed range (typically $\pm 30\%$ around synchronous speed). Moreover, this converter performs reactive power compensation and a smooth grid interconnection. The smaller frequency converter makes this concept attractive from an economical point of view. In this case the power electronics is enabling the wind turbine to act as a dynamic power source to the grid. However, its main drawbacks are the use of slip-rings and the protection schemes/controllability in the case of grid faults [20], [21].

The use of a reduced size converter is also feasible with PMSG as e.g. proposed in [22] where a 20% power converter is placed in series with the stator winding to actively damp the generator.

B. Variable Speed Wind Turbine with Full-scale Power Converter

A variable speed wind turbine configuration with full-scale power conversion corresponds to the full variable speed controlled wind turbine, with the generator connected to the grid through a power converter as shown in Fig. 6.

The frequency converter performs the reactive power compensation and a smooth grid connection for the entire speed range. The generator can be asynchronous generator, electrically excited synchronous generator (WRSG) or permanent magnet excited type (PMSG). The stator windings are connected to the grid through a full-scale power converter.

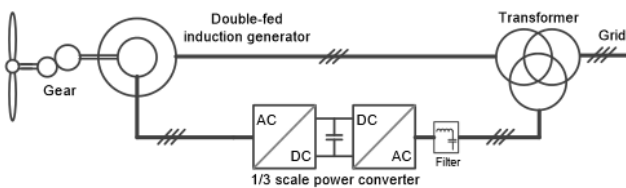

Fig. 5. Variable speed wind turbine with partial-scale power converter.

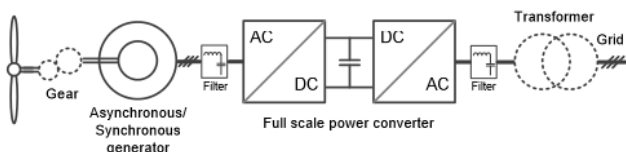

Fig. 6 Variable speed wind turbine with full-scale power converter.

Some variable speed wind turbine systems are gearless – see dotted gearbox in Fig. 6. In these cases, a heavier direct driven multi-pole generator is used. The wind turbine companies Enercon and Siemens Wind Power are examples of manufacturers who are using more direct drive type systems. The voltage level of the full-scale power conversion can be from low-voltage (below 1 kV) to medium voltage level and, in the future the voltage level might be appropriate to connect more directly to the grid system and to avoid the transformer [12].

IV. SINGLE CELL POWER CONVERTERS FOR WIND TURBINES

A. Unidirectional power converter solutions

Today it is a trend to use a permanent magnet synchronous generator (PMSG) in the full-rated power converter wind turbine. As there is no reactive power needed in such a generator and active power flows uni-directionally from the PMSG to the grid through a power converter, only a simple diode rectifier can be applied to the generator side converter in order to obtain a cost-efficient solution. However diode rectifier even if multiphase or 12-pulse introduces low frequency pulsations that can trigger shaft resonance [24]. Semi-controlled rectifier solutions are also possible [25].

In order to get variable speed operation and stable DC bus voltage, a boost DC-DC converter could be inserted in the DC-link or dc-voltage can be controlled using rotor excitation, as shown in Fig. 7. It should be mentioned that for power levels in the range of MW's the dc/dc converter needs to be made by several interleaved units or by a 3-level solution [23].

Fig. 8 shows the use of two current source converters in a back-to-back connection [26]. The advantage of the proposed solution can be to exploit the inductance of the long cables used in wind parks if a dc-distribution is adopted or used in the case of the generator converter is placed in the nacelle while the grid converter is placed at the bottom of the WTS [27]. The use of a Voltage Source Inverter (VSI) on the grid side is mandatory in case of Fig. 7 topology since capacitive dc storage is used. In a similar way the use of Current Source Inverter (CSI) on the grid side is mandatory in the case of Fig. 8 topology is used since the dc storage is inductive.

B. Two-level power converter (2L-BTB)

Pulse Width Modulation-Voltage Source Converter with two-level output voltage (2L-PWM-VSC) is the most frequently used three-phase power converter topology so far in wind turbines systems. The knowledge available in this field is extensive and it is a well established technology. As the interface between the generator and grid in the wind turbine system, two 2L-PWM-VSCs are usually configured as a back-to-back structure (2L-BTB) with a transformer on the grid side, as shown in Fig. 9. A technical advantage of the 2L-BTB solution is the relatively simple structure and few components, which contributes to a well-proven robust and reliable performance.

However, as the power and voltage range of the wind turbine are increasing, the 2L-BTB converter may suffer from larger switching losses and lower efficiency at Mega-Watts

(MW) and Medium-Voltage (MV) power levels. The available switching devices also need to be paralleled or connected in series in order to obtain the required power and voltage of wind turbines, which may lead to reduced simplicity and reliability of the power converter [28].

Another problem in the 2L-BTB solution is the two-level output voltage. The only two voltage stages introduce relatively higher dv/dt stresses to the generator and transformer. Bulky output filters may be needed to limit the voltage gradient and reduce the THD [29].

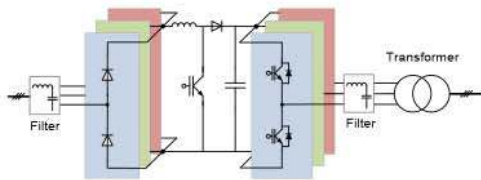

Fig. 7. Full-rated power converter wind turbine with permanent magnet generator.

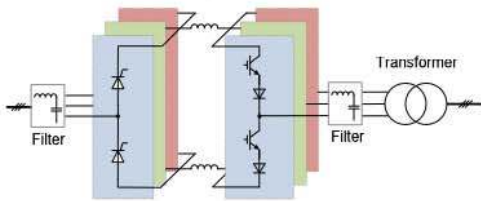

Fig. 8. Full-rated power converter wind turbine with permanent magnet generator (Current source version).

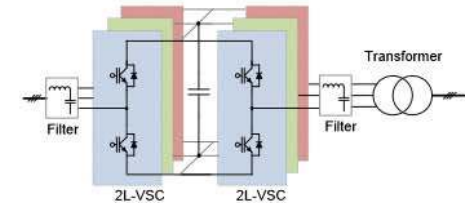

Fig. 9. Two-level back-to-back voltage source converter for wind turbines (2L-BTB)

The 2L-BTB topology is state of the art in DFIG based wind turbines e.g. [2], [3], [30]. Several manufacturers are also using this topology for full-rated power converter wind turbines with a squirrel-cage induction generator.

C. Multilevel power converter

As mentioned above, power capacity of wind turbines keeps climbing up (even to 10 MW), and it becomes more and more difficult for a traditional 2L-BTB solution to achieve acceptable performance with the available switching devices. With the abilities of more output voltage levels, higher voltage amplitude and larger output power, multi-level converter topologies are becoming interesting and popular candidates in the wind turbines application [31]-[33].

Generally, multilevel converters can be classified into three categories [33-36]: neutral-point diode clamped structure, flying capacitor clamped structure, and cascaded converter cells structure. In order to get a cost-effective design, multilevel converters are mainly used in the 3 MW to 7 MW variable-speed full-scale power converter wind

turbines. Several possible multilevel solutions are presented in the following.

1) Three-level Neutral Point diode Clamped Back-To-Back topology (3L-NPC BTB)

Three-level Neutral Point diode Clamped topology is one of the most commercialized multi-level converters on the market. Similar to the 2L-BTB, it is usually configured as a back-to-back structure in wind turbines, as shown in Fig. 10, which is called 3L-NPC BTB for convenience.

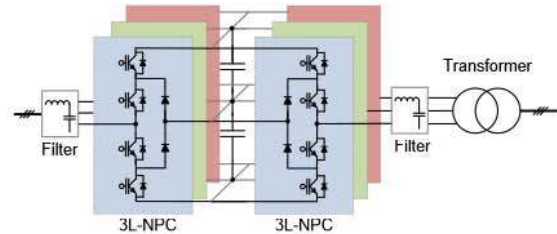

Fig. 10. Three-level Neutral Point Clamped back-to-back converter for wind turbines. (3L-NPC BTB)

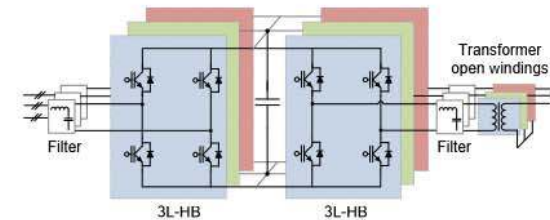

Fig. 11. Three-level H-bridge back-to-back converter for wind turbines. (3L-HB BTB)

It achieves one more output voltage level and less dv/dt stress compared to the 2L-BTB, thus the filter size is smaller. The 3L-NPC BTB is also able to output the double voltage amplitude compared to the two-level topology by the switching devices of the same voltage rating. The mid-point voltage fluctuation of DC-bus used to be a drawback of the 3L-NPC BTB. However, this problem has been extensively researched and is considered improved by the controlling of redundant switching status [36]. However, it is found that the loss distribution is unequal between the outer and inner switching devices in a switching arm, and this problem might lead to de-rated converter power capacity when it is practically designed [32], [36], [37].

2) Three-level H-bridge back-to-back topology (3L-HB BTB)

The 3L-HB BTB solution is composed of two H-bridge converters which are configured in a back-to-back structure, as shown in Fig. 11. It can achieve output performance similar to the 3L-NPC BTB solution, but the unequal loss distribution and clamped diodes are eliminated. More efficient and equal usage of switching devices as well as higher designed power capacity might be obtained [31], [32], [38].

Moreover, as only half of the DC bus voltage is needed in 3L-HB BTB compared to the 3L-NPC BTB, there are less

series connection of capacitors and no mid-point in DC bus, thus the size of DC-link capacitors can be further reduced.

However, a 3L-HB BTB solution needs an open winding structure in the generator and transformer in order to achieve isolation between each phase. This feature has both advantages and disadvantages: on one hand, an open winding structure enables relatively isolated operation of each phase, and a potential fault tolerant ability is thereby obtained if one or even two phases of the generator or the generator side converter are out of operation. On the other hand, an open winding structure requires double cable length and weight in order to connect with the generator and the transformer. Extra cost, loss and inductance in the cables can also be major drawbacks. The open-winding impacts on the loss/weight of the generator and the transformer still need to be further investigated.

3) Five-level H-bridge back-to-back topology (5L-HB BTB)

The 5L-HB BTB converter is composed of two back-to-back H-bridge converters making use of 3L-NPC switching arms, as shown in Fig. 12. It is an extension of 3L-HB BTB, and shares the same special requirements for the open-winding generator and transformer.

With the same voltage rating of the switching devices, 5L-HB BTB can achieve five level output voltage, and double voltage amplitude compared to the 3L-HB BTB solution. These features enable smaller output filter and less current rating in the switching devices as well as in the cables [29], [39].

However, compared to 3L-HB BTB, the 5L-HB BTB converter introduces more switching devices, which could reduce the reliability of the total system. The problems of unequal loss distribution as well as larger DC link capacitors will unfortunately also return.

4) Three-level Neutral Point diode Clamped topology for generator side and Five-level H-bridge topology for grid side (3L-NPC + 5L-HB)

Generally, the output quality requirements of the grid side are much stricter than those of the generator side [40]. To adapt this unsymmetrical requirement for wind power converters, a “compound” configuration employing 3L-NPC topology on the generator side, and 5L-HB topology on the grid side can be adopted, as shown in Fig. 13.

On the generator side, this configuration has a performance similar to the 3L-NPC BTB solution. While on the grid side, it has the same performance to 5L-HB BTB. The voltage levels and amplitude of the grid side are higher than those on the generator side. It is noted that an open winding structure in the generator is avoided; the cable length on the generator side is therefore reduced to half, but the potential fault tolerant ability is also eliminated. It has less switching devices compared to 5L-HB BTB, but still unequal loss distribution in the switching devices exists.

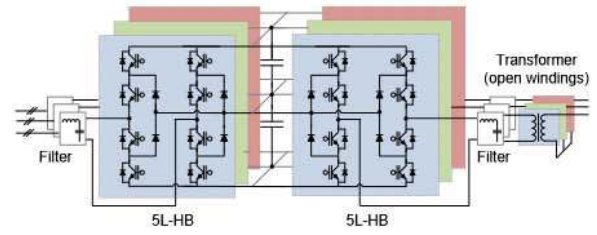

Fig. 12. Five-level H-bridge back-to-back converter for wind turbines. (5L-HB BTB)

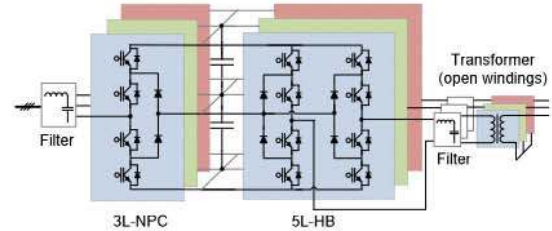

Fig. 13. Three-level Neutral Point Clamped and five-level H-bridge converter for wind turbines. (3L-NPC + 5L-HB)

In all the previously proposed solutions, the large amount of power semiconductor as well as auxiliary components could reduce this converter reliability and increase the cost. The total system weight and volume reduction in the wind turbine application still needs to be further investigated.

The comparisons between the five solutions for single-cell full-scale power converter wind turbines are shown in Table II, regarding power semiconductor numbers, the output voltage ability, fault tolerant ability, as well as major advantages and disadvantages.

V. MULTIPLE CELLS POWER CONVERTERS FOR WIND TURBINES

Up till now, one of the most commercialized cascaded converter cells multilevel topologies is the Cascaded H-Bridge (CHB) converter as shown in Fig. 14. Unfortunately, the CHB needs an isolated DC-link for each converter cell. This characteristic may involve a complex multi-pulse transformer on the generator side, resulting in larger weight and volume [29], [41].

A configuration which shares a similar idea with some of the next generation traction converters [42], [43], as well as the European UNIFLEX-PM Project [44] is proposed in Fig. 14. It is based on a back-to-back Cascaded H-bridge converter structure, with galvanic insulated DC/DC converters as interface. The DC/DC converters with medium frequency transformer (MFT) operate at several kHz to dozens of kHz, the transformer size is thereby reduced. Because of the cascaded structure, this configuration can be directly connected to the transmission power grid (10 kV-20 kV) with high output voltage quality, filterless design, and redundancy ability [42]-[44].

Table II. Comparison of the one-cell power converter solutions for wind turbines.

	3L-NPC	3L-HB	5L-HB	3L + 5L
IGBT numbers	24	24	48	36
Diode numbers ¹	36	24	72	54
Switch current	I_{ph}	I_{ph}	I_{ph}	I_{ph}
Switch voltage	$0.5V_{dc}$	V_{dc}	$0.5V_{dc}$	$0.5V_{dc}$
Max. output voltage ²	$0.5V_{dc}$	V_{dc}	V_{dc}	$0.5V_{dc} + V_{dc}$
Output-Switch voltage ratio	1	1	2	1 + 2
Voltage WTHD ³	0.84 %	1.15 %	0.73 %	0.73%
Output connection	Standard	Open winding	Open winding	Open winding
Fault tolerant ability ⁴	No	Yes	Yes	No
Advantages	Matured technology	Less DC link capacitors, Equal loss distribution	More output voltage levels, Higher voltage utilization of device ⁵	Higher performances on grid side than generator side
Disadvantages	Unequal loss distribution, DC bus midpoint	Zero-sequence current path, More cables	Zero-sequence current path, More cables and devices	Unequal loss distribution, DC bus midpoint

Notes:

1. Include both freewheeling diodes and clamping diodes.
2. Theoretical maximum amplitude of output phase voltage.
3. Simulation results of grid inverter, $f_s/f_o=21$, $M=1$, 80th harmonics, modulation methods in [56], voltage of V_a-V_b .
4. If one or two phase of generator side converter fails, still keep working.
5. Larger output-switch voltage ratio (higher output voltage using the same voltage rating devices).

Fig. 15 shows a different approach, proposed by Semikron, to increase the power by using a multi-cell structure, i.e. the connection of them in series on a MVDC bus, while the grid converters are connected in parallel [45]. The main advantage is that standard low voltage modules may be used for a MVDC application.

Fig. 16 shows the solution adopted by Gamesa in the 4.5 MW wind turbine [46] with parallel connection of cells both on the generator side and on the grid side. Siemens also introduce this kind of solution in some of their multi-MW wind turbines [47].

Fig. 17 shows a solution for a high power high voltage transformerless WTS where the coils of the generator are connected to the ac/ac converter that are connected in series on the grid side. The coil windings need to be isolated [12].

Fig. 18 shows a power converter obtained with series connection of matrix converters in which the output feed several windings of a transformer leading to a magnetic parallel configuration [48].

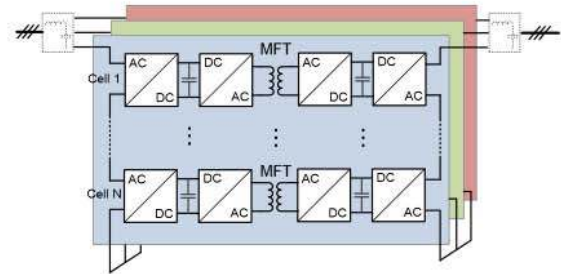

Fig. 14. Cascaded H-bridge back-to-back converter for wind turbines with Medium Frequency Transformer (S-S).

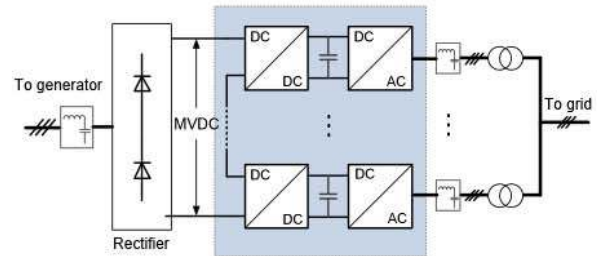

Fig. 15. Series connection of power converter cells using a common grid converter diode-bridge, an MVDC link and boost converters with 2-level inverters parallel connected to the grid (S-P).

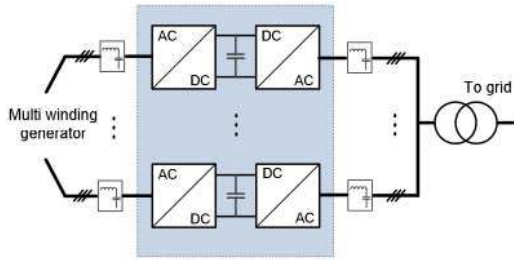

Fig. 16. Parallel connection of power converters in which PWM signals are interleaved to achieve harmonic cancellation (*P-P*).

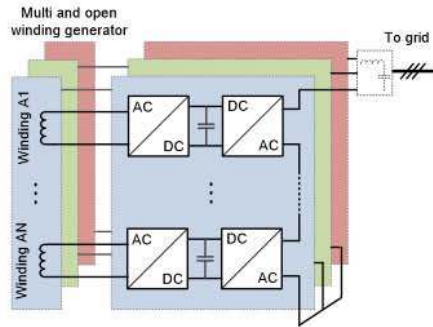

Fig. 17. Magnetic parallel connection of power converters on the generator side and series connection on the grid side (*MP-S*).

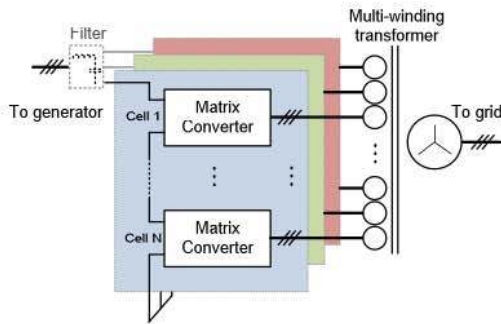

Fig. 18. Series connection of matrix converters with magnetic paralleling on the grid side (*S-MP*).

Table III. Comparisons of the multi-cell solutions for wind turbines.

Configurations	S-S	S-P	P-P	S-MP	MP-S
Generator	Standard	Standard	Open winding	Standard	Open winding
Transformer	0	--	-	---	0

Note: The more -, the more large and heavy.

All the reviewed topologies have fault tolerant capabilities and all of them are also using a higher number of components. The main differences are in the requirement they have in respect to the generator and in respect to the transformer as outlined in Table III.

VI. RELIABILITY ISSUES

The penetration of wind power into the power grid is fast growing even expected to be 20% of the total electricity

production at 2020 in Europe [49]. Meanwhile, the power capacity of a single wind turbine is increasing continuously in order to reduce the price pr. produced kWh, and the location of wind farms is moving from onshore to offshore because of land limits and more wind energy production in the offshore. Consequently, due to much more significant impacts to the power grid, as well as higher cost to maintain and repair after failures than ever before, the wind power generation system is required to be more reliable and able to withstand some extreme grid or environment disturbances. Reliability is one of the key issues that concerns WTS manufacturers and investors in order to ensure high power security (availability). Market feedback has shown that the control and power converters seem to be more prone to failure even though the generator and gearbox have the largest downtime, as illustrated in Fig. 19 [50]. The need for higher power density in power converters, as already outlined, leads to more compact design, reduced material use and equipment cost [51]. All may invoke new failure mechanisms in the power and control electronics. Exposure to moisture, vibration, dust, chemicals, high voltage and temperature is predominant in wind turbine systems failure drivers.

The study of reliability in power electronics is moving from a statistically based approach that has been proven to be unsatisfactory in achieving higher safety levels in the automotive industry, where the standards are very high, to a physics-of-failure approach which involves the study of each of the phenomena that lead to failures of power electronics [52], [53] and also the entire wind turbine.

The main driver of the semiconductor failures has been found to be the thermal cycling of the different materials, with different expansion coefficients, which stress the power switches. The thermal cycling appears when power semiconductors in the converter commute unevenly and periodically. The thermal chain as shown in Fig. 20 determines a periodical thermal excursion of the different materials, which expand and compress until different failure mechanism are triggered. Different power switches are based on different technologies, e.g. module-integrated or press-pack, and on different characteristics leading to a number of possible combinations of failure mechanisms.

Hence it is important that a clear mission profile exist, including the definition of all the stresses to which the semiconductors are subjected, before the power converter reliability is evaluated as illustrated in Fig. 21.

Through analysis, understanding and modeling of failure mechanisms and field load, the goal of seeking correlations between electrical measurements on failed components and the observed failure, need to be pursued. This will lead to the development of real time monitoring and prediction that consists of identifying methods for the real time (on-line) detection of the lifetime (wear-out) state of the power transistor (or power diode) by monitoring various relevant (thermal, electrical, optical etc.) sensor signals [54]. For example, the Collector-Emitter voltage V_{CE} of an IGBT, which is subject to an accelerated test, experiences a sudden increase just before the IGBT failure [55] and can be used for predictive maintenance in the wind turbine system.

Moreover a new interesting area of research is the use of modulation and control optimized to reduce the maximum junction temperature (Fig. 22) or the maximum junction temperature fluctuation (Fig. 23) under particularly stressing conditions such as low voltage ride through [56] or wind gusts [57].

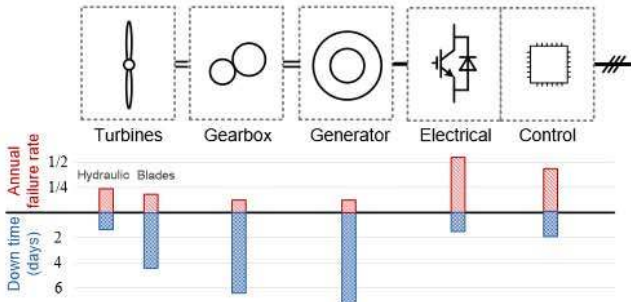

Fig. 19. Wind turbine overview in respect to reliability where registered annual failure rate and down time are illustrated. Data from [46].

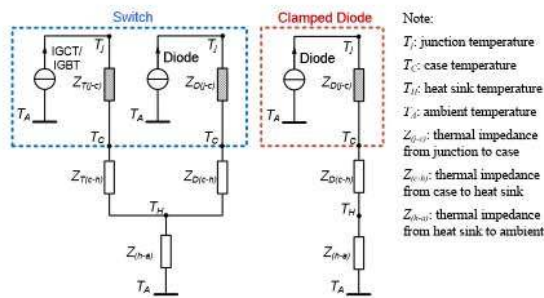

Fig. 20. Example of thermal models of the power devices in a power converter.

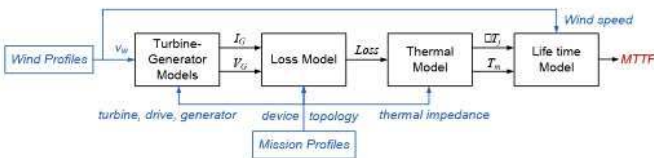

Fig. 21. From the definition of a mission profile to a reliability model of a power converter in a wind turbine.

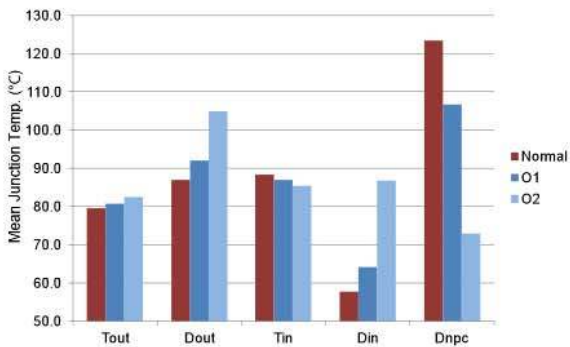

Fig. 22. Mean junction temperature considering normal and optimized modulation sequences for the 3L-NPC wind power inverter under LVRT. $V_g=0.05$ p.u. 100% reactive current.

The zero voltage level output of 3L-NPC inverter introduces losses to the clamping diode D_{npc} , which will be

more stressed during the Low voltage ride through operation of power grid. The basic idea of the thermal optimized modulation O1 and O2 is trying to reduce the duration time of zero voltage level by utilizing the switching state redundancy in the inner hexagonal of space vector diagram of three-level NPC inverter. By the same time the control ability of DC bus midpoint potential is still maintained.

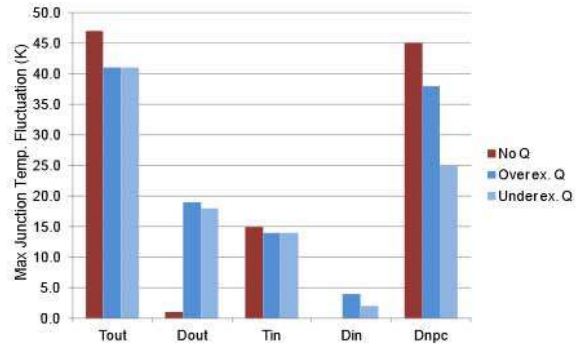

Fig. 23. Maximum thermal fluctuation of 3L-NPC inverter with different reactive powers (Considering parallel converters).

During wind gust the junction temperature fluctuation in the power devices of wind power converter may be serious. The basic idea of this method is to circulate the reactive power among paralleled converters in a wind farm to somehow stabilize the temperature fluctuation, by the same time the reactive power regulations by the power grid standards are still satisfied.

VII. CONCLUSION

The paper has given an overview of different power electronic converters in wind turbine systems with special attention paid to the many possible topologies at low voltage and medium voltage. An important trend is that the technology is moving towards a higher power level and it is inevitable that it goes for higher voltage and as a consequence into multilevel single-cell structures or to multi-cell modular structures that can even use standard low voltage power converter modules. One current concern beyond being able to upscale the power is being better able to predict reliability of power electronic converters and control, as it has been a major failure cause in WTS, and better lifetime prediction and condition monitoring methods in the future will be important to improving the technology. The use of a multi-cell approach in the power converter design can also lead to transformerless high power converters which are directly connected to a medium voltage grid with reduction of power losses, weight and volume. Research is on-going in this direction. Further, as the wind turbines are aggregated into wind power stations – configurations most useful for single-turbine operation are perhaps not the most feasible solution for a large scale off-shore wind farm needing a large power transmission system.

REFERENCES

- [1] M. Liserre, R. Cardenas, M. Molinas, J. Rodriguez, "Overview of Multi-MW wind turbines and wind parks", *IEEE Transactions on Industrial Electronics*, Vol. 58, No. 4, April 2011, pp. 1081-1095.
- [2] Z. Chen, J.M. Guerrero, F. Blaabjerg, "A Review of the State of the Art of Power Electronics for Wind Turbines," *IEEE Transactions on Power Electronics*, vol.24, No.8, pp.1859-1875, Aug. 2009.
- [3] F. Blaabjerg, Z. Chen, S.B. Kjaer, "Power Electronics as Efficient Interface in Dispersed Power Generation Systems", *IEEE Trans. on Power Electronics*, 2004, Vol. 19, no. 4, pp. 1184-1194.
- [4] A.D. Hansen, F. Iov, F. Blaabjerg, L.H. Hansen, "Review of contemporary wind turbine concepts and their market penetration," *Journal of Wind Engineering*, Vol. 28, No. 3, 2004, pp. 247-263.
- [5] Report of Danish Commission on Climate Change Policy, "Green Energy - the road to a Danish energy system without fossil fuels," September 2010. (Available: <http://www.klimakommissionen.dk/en-US/>)
- [6] M.P. Kazmierkowski, R. Krishnan, F. Blaabjerg, "Control in Power Electronics-Selected problems", Academic Press, 2002. ISBN 0-12-402772-5.
- [7] M. Milligan, K. Porter, E. DeMeo, P. Denholm, H. Holttinen, B. Kirby, N. Miller, A. Mills, M. O'Malley, M. Schuerger, L. Soder, "Wind power myths debunked," *Power and Energy Magazine*, IEEE , vol.7, no.6, pp.89-99, November-December 2009.
- [8] UpWind project, "Design limits and solutions for very large wind turbines," March 2011, (Available: http://www.ewea.org/fileadmin/ewea_documents/documents/upwind/2_1895_UpWind_Report_low_web.pdf)
- [9] Website of BTM Consult, Denmark. (Available: <http://www.btm.dk/>).
- [10] F. Blaabjerg, R. Teodorescu, M. Liserre, A.V. Timbus, "Overview of Control and Grid Synchronization for Distributed Power Generation Systems," *IEEE Transactions on Industrial Electronics*, vol.53, no.5, pp.1398-1409, Oct. 2006.
- [11] R. Teodorescu, M. Liserre and P. Rodriguez, *Grid Converters for Photovoltaic and Wind Power Systems*. IEEE/Wiley, 2011.
- [12] C.H. Ng, M. A. Parker, Li Ran, P.J.Tavner, J. R. Bumby, E. Spooner, "A Multilevel Modular Converter for a Large, Light Weight Wind Turbine Generator," *IEEE Transactions on Power Electronics*, vol.23, no.3, pp.1062-1074, May 2008.
- [13] M. Liserre, F. Blaabjerg, S. Hansen, "Design and control of an LCL-filter-based three-phase active rectifier," *IEEE Transactions on Industry Applications*, vol.41, no.5, pp. 1281-1291, Sept.-Oct. 2005.
- [14] A. Rockhill, M. Liserre, R. Teodorescu, P. Rodriguez, "Grid Filter Design for a Multi-Megawatt Medium-Voltage Voltage Source Inverter," *IEEE Transactions on Industrial Electronics*, Vol. 58, No. 4, April 2011, pp. 1205-1217.
- [15] C. Busca, R. Teodorescu, F. Blaabjerg, S. Munk-Nielsen, L. Helle, T. Abeyasekera, P. Rodriguez, "An overview of the reliability prediction related aspects of high power IGBTs in wind power applications," *Microelectronics Reliability*, Vol. 51, no. 9-11, September-November 2011, pp. 1903-1907.
- [16] R. Jakob, C. Keller, B. Gollentz, "3-Level high power converter with press pack IGBT," in *Proc. EPE 2007*, 2-5 Sept. 2007.
- [17] Rodrigo Alvarez, Felipe Filsecker, Steffen Bernet, "Comparison of press-pack IGBT at hard switching and clamp operation for medium voltage converters," in *Proc. EPE 2011*, 2011.
- [18] Website of heraeus, (Available: <http://www.heraeus.com/>)
- [19] Website of Semikron, (Available: <http://www.semikron.com/>).
- [20] S. Muller, M. Deicke, R.W. De Doncker, "Doubly fed induction generator systems for wind turbines," *Industry Applications Magazine*, IEEE , vol.8, no.3, pp.26-33, May/June 2002.
- [21] D. Xiang, Li Ran, P.J. Tavner, S. Yang, "Control of a doubly fed induction generator in a wind turbine during grid fault ride-through," *IEEE Transactions on Energy Conversion*, Vol.21, no.3, pp. 652-662, Sept. 2006.
- [22] S. Grabic, N. Celanovic, V.A. Katic, "Permanent Magnet Synchronous Generator Cascade for Wind Turbine Application," *IEEE Transactions on Power Electronics*, vol.23, no.3, pp.1136-1142, May 2008.
- [23] Bin Wu, Yongqiang Lang, Navid Zargari, Samir Kouro "Power Conversion and Control of Wind Energy Systems" Wiley 2011.
- [24] A. Faulstich, J.K. Stinke, F. Wittwer, "Medium voltage converter for permanent magnet wind power generators up to 5 MW," in *Proc. EPE 2005*, pp.1-9, 2005.
- [25] D.S. Oliveira, M.M. Reis, C. Silva, L. B. Colado, F. Antunes, B.L. Soares, "A Three-Phase High-Frequency Semicontrolled Rectifier for PM WECS," *IEEE Transactions on Power Electronics*, vol.25, no.3, pp.677-685, March 2010.
- [26] J. Dai, D.D. Xu, B. Wu, "A Novel Control Scheme for Current-Source-Converter-Based PMSG Wind Energy Conversion Systems," *IEEE Transactions on Power Electronics*, vol.24, no.4, pp.963-972, April 2009.
- [27] P. Tenca, A.A. Rockhill, T.A. Lipo, P. Tricoli, "Current Source Topology for Wind Turbines With Decreased Mains Current Harmonics, Further Reducible via Functional Minimization," *IEEE Transactions on Power Electronics*, Vol.23, no.3, pp.1143-1155, May 2008.
- [28] J. Rodriguez, S. Bernet, Wu Bin, J. O. Pontt, S. Kouro, "Multilevel Voltage-Source-Converter Topologies for Industrial Medium-Voltage Drives," *IEEE Transactions on Industrial Electronics*, vol. 54, no. 6, pp. 2930-2945, 2007.
- [29] S. Kouro, M. Malinowski, K. Gopakumar, J. Pou, L. G. Franquelo, B. Wu, J. Rodriguez, M. A. Perez, J. I. Leon, "Recent Advances and Industrial Applications of Multilevel Converters," *IEEE Transactions on Power Electronics*, vol. 57, no. 8, pp. 2553 - 2580, 2010.
- [30] R. Pena, J.C. Clare, G.M. Asher, "Doubly fed induction generator using back-to-back PWM converters and its application to variable speed wind-energy generation", *Electric Power Application*, Vol. 143, No. 3, 1996, pp. 231-241.
- [31] K. Ma, F. Blaabjerg, D. Xu, "Power Devices Loading in Multilevel Converters for 10 MW Wind Turbines," in *Proc. of ISIE 2011*, pp. 340-346, June 2011.
- [32] K. Ma, F. Blaabjerg, "Multilevel Converters for 10 MW Wind Turbines," in *Proc. of EPE, 2011 - Birmingham*.
- [33] J. M. Carrasco, L. G. Franquelo, J. T. Bialasiewicz, E. Galvan, R. Portillo, M. M. Prats, J. I. Leon, N. Moreno-Alfonso, "Power-electronic systems for the grid integration of renewable energy sources: A survey," *IEEE Transactions on Industrial Electronics*, vol. 53, pp. 1002-1016, Jun. 2006.
- [34] D. Krug, S. Bernet, S. S. Fazel, K. Jalili, M. Malinowski, "Comparison of 2.3-kV Medium-Voltage Multilevel Converters for Industrial Medium-Voltage Drives," *IEEE Transactions on Industrial Electronics*, vol. 54, no. 6, pp. 2979-2992, 2007.
- [35] J. Rodriguez, S. Bernet, P. K. Steimer, I. E. Lizama, "A Survey on Neutral-Point-Clamped Inverters," *IEEE Transactions on Industrial Electronics*, vol. 57, no. 7, pp. 2219-2230, 2010.
- [36] R. Teichmann, S. Bernet, "A comparison of three-level converters versus two-level converters for low-voltage drives, traction, and utility applications," *IEEE Transactions on Industry Applications*, vol. 41, no.3, pp. 855-865, 2005.
- [37] T. Bruckner, S. Bernet, H. Guldner, "The active NPC converter and its loss-balancing control," *IEEE Transactions on Industrial Electronics*, vol. 52, no. 3, pp.855-868, 2005.
- [38] O. S. Senturk, L. Helle, S. Munk-Nielsen, P. Rodriguez, R. Teodorescu, "Medium voltage three-level converters for the grid connection of a multi-MW wind turbine," in *Proc. EPE 2009*, pp.1-8, 2009.
- [39] H. Hosoda, S. Peak, "Multi-level converters for large capacity motor drive," in *Proc. IPEC'10*, pp. 516-522, 2010.
- [40] M. Altin, O. Goksu, R. Teodorescu, P. Rodriguez, B. Bak-Jensen, L. Helle, "Overview of recent grid codes for wind power integration," *Proc. of OPTIM'2010*, pp. 1152-1160, 2010.
- [41] M. Malinowski, K. Gopakumar, J. Rodriguez, M. A. Pérez, "A Survey on Cascaded Multilevel Inverters," *IEEE Transactions on Industrial Electronics*, vol. 57, no. 7, pp. 2197-2206, 2010.
- [42] B. Engel, M. Victor, G. Bachmann, and A. Falk, "15 kV/16.7 Hz energy supply system with medium frequency transformer and 6.5 kV IGBTs in resonant operation," in *Proc. of EPE 2003*, Toulouse, France, Sep. 2-4, 2003.
- [43] S. Inoue, H. Akagi, "A Bidirectional Isolated DC-DC Converter as a Core Circuit of the Next-Generation Medium-Voltage Power Conversion System," *IEEE Transactions on Power Electronics*, vol.22, no. 2, pp. 535-542, 2007.

- [44] F. Iov, F. Blaabjerg, J. Clare, O. Wheeler, A. Rufer, A. Hyde, "UNIFLEX-PM-A Key-Enabling Technology for Future European Electricity Networks," *EPE Journal*, vol. 19, no. 4, pp.6-16, 2009.
- [45] D. Schreiber, "Power converter circuit arrangement for generators with dynamically variable power output", US Patent App. 10/104,474, 2002.
- [46] B. Andresen, J. Birk, "A high power density converter system for the Gamesa G10x 4.5 MW Wind turbine", *Proc. of EPE'2007-Aalborg*, 2007, pp. 1-7.
- [47] R. Jones, P. Waite, "Optimised power converter for multi-MW direct drive permanent magnet wind turbines," in *Proc. EPE 2011*, pp.1- 10, 2011.
- [48] J. Kang, N. Takada, E. Yamamoto, and E. Watanabe, "High Power Matrix Converter for Wind Power Generation Applications," *Proc. ICPE 2011 (ECCE-Asia)*, pp. 1331-1336, 2011.
- [49] European Commission Climate Action, "The EU climate and energy package", March 2007.
- [50] B. Hahn, M. Durstewitz, K. Rohrig "Reliability of wind turbines – Experience of 15 years with 1500 WTs", Institut für Solare Energieversorgungstechnik (ISET), Kassel, Germany.
- [51] J. Lutz, H. Schlangenotto, U. Scheuermann and R. W. De Doncker, "Semiconductor Power Devices Physics, Characteristics, Reliability," Springer Verlag, 2011.
- [52] E. Wolfgang, L. Amigues, N. Seliger and G. Lugert, "Building-in Reliability into Power Electronics Systems". *The World of Electronic Packaging and System Integration*, 2005, pp. 246-252.
- [53] D. Hirschmann, D. Tissen, S. Schroder, R.W. De Doncker, "Inverter design for hybrid electrical vehicles considering mission profiles," *IEEE Conference on Vehicle Power and Propulsion*, 7-9 Sept. 2005, pp. 1-6.
- [54] S. Yang, D. Xiang, A. Bryant, P. Mawby, L. Ran, P. Tavner, "Condition Monitoring for Device Reliability in Power Electronic Converters: A Review," *IEEE Transactions on Power Electronics*, vol.25, no.11, pp.2734-2752, Nov. 2010.
- [55] J. Due, S. Munk-Nielsen, Rasmus Nielsen, "Lifetime investigation of high power IGBT modules", In *Proc. of EPE 2011 - Birmingham*.
- [56] K. Ma, F. Blaabjerg, M. Liserre, "Thermal Analysis of Multilevel Grid Side Converters for 10 MW Wind Turbines under Low Voltage Ride Through", in *Proc. of ECCE 2011*, pp. 2117 – 2124, 2011.
- [57] K. Ma, M. Liserre, F. Blaabjerg, "Reactive Power Influence on the Thermal Cycling of Multi-MW Wind Power Inverter", in *Proc. of APEC 2012*.