

Power Line Carrier Communication Using Automated Meter Reading

R. Gunasekaran¹, C. Karthikeyan², J. Pavalam¹, P. Mohanapriya¹, A. Preethi³, V. Indhumathi²

¹Excel College of Engineering and Technology, Namakkal (Dist.), Tamil Nadu, India

²K. S. Rangasamy College of Engineering, KSR Kalvi Nagar, Namakka (Dist.), Tamil Nadu, India

³Vivekanandha College of Engineering for Women-Autonomous, Namakkal (Dist.), Tamil Nadu, India

Email address:

gunaphd2015@gmail.com (R. Gunasekaran), ckarthykeya@gmail.com (C. Karthikeyan), pavalam.eee@gmail.com (J. Pavalam), mohanapriya129@gmail.com (P. Mohanapriya), agpspreethi@gmail.com (A. Preethi), indhueee@gmail.com (V. Indhumathi)

To cite this article:

R. Gunasekaran, C. Karthikeyan, J. Pavalam, P. Mohanapriya, A. Preethi, V. Indhumathi. Power Line Carrier Communication Using Automated Meter Reading. *Bioprocess Engineering*. Vol. 1, No. 4, 2017, pp. 104-109. doi: 10.11648/j.be.20170104.12

Received: April 5, 2017; **Accepted:** May 10, 2017; **Published:** August 18, 2017

Abstract: A new concept of Power line Communication. Now human operators do the Meter reading for the consumption of Electricity from house to house and building to building. It requires huge number of labor and takes more time to complete the process. Reading error is a common cause of human operator. Automatic Meter Reading (AMR) becomes an executable option to overcome the problems of huge time taking to get the meter readings, the measured values are in kilo watt-hours (kWh) by energy meter. The supply status of the consumer reading unit we identified the disk rotation of the energy meter. The main advantage of this system is a low cost system that produces very encouraging results and it can be implemented upon existing electro-mechanical meters so there is no need to purchasing new meters AMR is the remote collection of consumption data from customer's utility meters over power line. Power-Line Communication (PLC) carries data on a conductor that is also used simultaneously for AC electric power distribution to consumers. PLC transmitter is responsible for transmission of data from the provider end. At the provider end, there will be the PLC receiver, which is responsible for data receiving, and this module makes an interface with computer, which is responsible for data processing.

Keywords: AMR, Carrier Communication, PLC, Power Line

1. Introduction

The communication medium for the transmission of meter reading falls into two categories: wired and wireless. Wired services embrace customary phone lines, power lines, dedicated and switched information lines, and broadband services, like co-axial and fiber-optic cables. Wireless services vary from unofficial drive-by systems that use low power transmitters to send information over unauthorized radio frequencies to mounted two-way networks victimization advanced communication technologies like cellular and satellite. of all on the market media, entirely cable is fascinating to the energy supplier, as a result of the remainder will incur additional worth to them. The technology involved in automating meter reading through power lines area unit the sanctioning technology to various extra services, like web services, that associate degree energy supplier can supply. Thus, automatic meter reading becomes

the "window" to any or all prospects. Before applying any technology, the best priority area unit the understanding of the flexibility lines.

Visual scrutiny of meters is long and labor intensive. A study, conducted by lake, had shown that somebody's meter reader would possibly only accomplish a similar average information rate of regarding 1bit/s, that's implausibly slow. Moreover, some meters are set in places of poor accessibility that greatly increase the problem of reading such meters. The electricity value can be analyzed and measured through the energy meter by manually from first end to another end, to avoid time consumption. It needs Brobdignagian range of labor operators and long-standing operating hour to attain complete information reading of a specific space. Reading error may be a common reason behind human operator charge. There are several such issues within the charge

system that causes inconvenience to the ability supplier likewise because the customers and this drawback is increasing with the event of residential housing and business building within the developing countries. This has, in turn, resulted in increase of power supplier charge value and helps to cut back charge value and overcome the on top of mentioned issues, AMR system is introduced. The aim of the project is completely machine-controlled and therefore the communication is created potential entirely through the facility line itself. This communication is one-directional at a quicker rate through long distances. By digitizing, the presently used analogue energy meter has been fully remodeled to a digital one. therefore it's useful to the purchasers because the system is created terribly user friendly. this technique permits the user to induce updated details of the facility employed in his house.

2. Description

2.1. Power Supply

The power supply section is the important one. A power supply is a device that supplies electric power to an electrical load. It should deliver constant output regulated power supply to PLC modem and microcontroller for successful working of the project. The block diagram of power supply is given below.

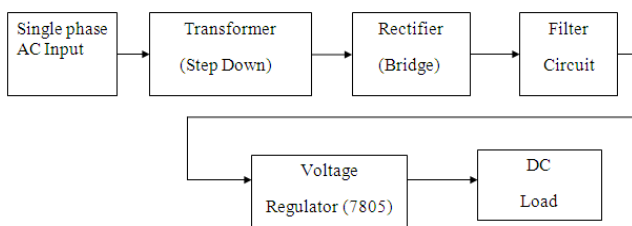

Block diagram of power supply unit

Figure 1. Block Diagram for Power Supply Unit.

Power Supply Components

- a. Full wave rectifier
- b. Voltage regulator
- c. Filter circuit

2.2. Transformer

A transformer is a device that transfers electrical energy from one circuit to another through inductively coupled conductors, i.e the transformer's coils or windings. Transformer is used here to step down the supply voltage to a level suitable for the low voltage components. The transformer used here is a 230/ (12V-0-12V) step down transformer. The transformer consists of primary and secondary coils. To reduce or step down the voltage, the transformer is designed to contain less number of turns in its secondary core.

2.3. Rectifiers

The full wave bridge rectifier circuit configuration was

widely used. It offers a lot of economical use of the electrical device and in addition the Centre Broached electrical devices are not required. The extra retail prices may charge due to adding up of diodes. Typically four diode bridges may be bought as single things, creating construction of the general circuit a lot of less complicated.

In view of their benefits, full wave rectifier circuit's square measure nearly forever employed in preference to wave circuits. The exaggerated potency in addition to the higher smoothing ability arising from the shorter time between peaks implies that their benefits outweigh the disadvantages by a protracted manner. Solely sometimes, usually for low demand provides would wave rectifier be employed in preference to the total wave rectifier circuit.

2.4. Filter

Capacitors area unit used as filters. The ripples from the dc voltages area unit removed and pure dc voltage is obtained. the first action performed by electrical condenser is charging and discharging.

It charges in positive cycle of the ac voltage and it'll discharge in negative cycle, hence it permits solely dc voltage and doesn't permit the ac voltage. This filter is fastened before the regulator. Capacitors used here for a unit of the worth about 1000uF. This filter is fastened when the Regulator circuit to filter any of the probably found ripples within the output received finally. Capacitors used here area unit useful 10F.

2.5. Voltage Regulator

The voltage regulators will provide a continued DC voltage to the transmitter and receiver device. Power provides whereas not regulators have associate inherent downside of adjusting DC voltage values because of variations at intervals the load or because of fluctuations at intervals the AC liner voltage. With a regulator connected to the DC output, the voltage is maintained within an in depth tolerant region of the specified output LM7805 is used throughout this project for providing +12V and -12V DC provide. Regulators comprise a class of wide used ICs.

Regulator IC units contain the electronic equipment for reference supply, comparator electronic equipment, management device and overload protection beat one IC. though the inner construction of the IC is somewhat totally different from that delineated for delineated for separate transformer circuits, the external operation is way identical.

An influence offer are often engineered employing a electrical device connected to the AC itinerary to step the AC voltage to desired electronic equipment, then rectifying that AC voltage, filtering with a capacitance and LC filter, if desired and eventually control the DC voltage victimization associate degree IC regulator. The regulators are often designated for operation with load currents from many mille amperes to tens of amperes, resembling power rating from mill watts to tens of watts the fundamental affiliation of a three-terminal transformer IC to a load. The fastened

transformer has associate degree unregulated DC input voltage V_i applied to 1 input terminal, a regulated output DC voltage V_o from a second terminal, with the third terminal connected to ground.



Figure 2. Voltage regulator (7805).

This ensuing DC voltage typically has some ripple or AC voltage variation. A regulator circuit removes the ripples and conjointly remains an equivalent DC price notwithstanding the input DC voltage varies or the load connected to the output DC voltage changes. This voltage regulation is typically obtained victimization one in every of the popular transformer IC units.

4. Circuit Diagram of Power Supply Unit

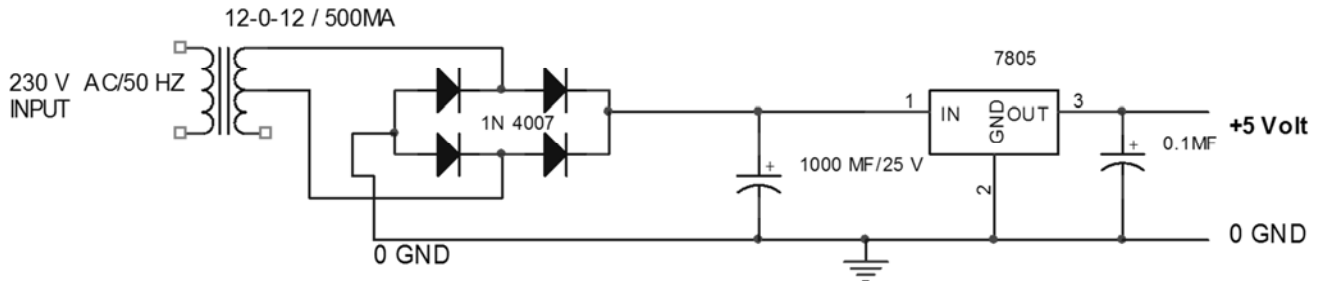

Figure 3. Circuit Diagram of Power Supply Unit.

5. Operation

Available power supply is associate Ac voltage arrives at 230V. Since our electronic circuits need solely terribly marginal voltage and current we have a tendency to use step down power electrical device. Step down electrical device is meant in such how that the input is 230V and output of 12V. Another factor is that electronic circuits operate in DC wherever as accessible output of electrical device is AC of 12V. So the rectifier circuit is employed to convert AC to DC. The Rectifier circuit consists of 4 diodes which is fashioned in bridges therefore on convert incoming AC to DC.

3. Features

- a. Output current in way over 1A
- b. Internal thermal overload protection
- c. No external elements needed
- d. Output junction transistor safe space protection

For most no vital applications are easier and more effective alternative for a transformer is that the simple terminal kind. It solely 3 connections (input, output, and ground) and is factory-trimmed to supply a hard and fast output. Typical of this kind is that the 78x. The voltage is specific by the last 2 digits of the half variety and might be any of the following: 05, 08, 10, 12, 15, 18, or 24. It's to create a +5 V regulator, for example, with one in every of these regulator. An Electrical device across the output improves transient response and keeps the electrical resistance low at high frequencies (an input electrical device of a minimum of 0.33µF ought to be utilized in addition if the regulator is found a substantial distance from the filter capacitors).

- Voltage Range
- (1) LM7805C 5V
 - (2) LM7812C 12V
 - (3) LM7815C 15V
 - (4) LM7912C -12V

6. Block Diagram

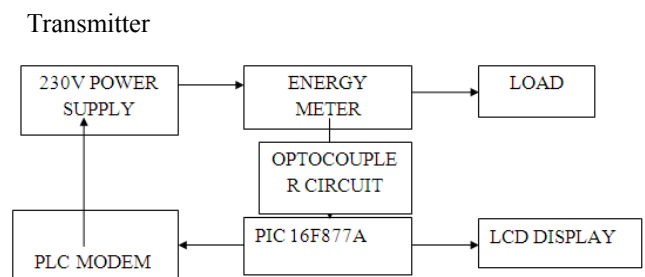

Transmitter block diagram

Figure 4. Transmitter.

Receiver

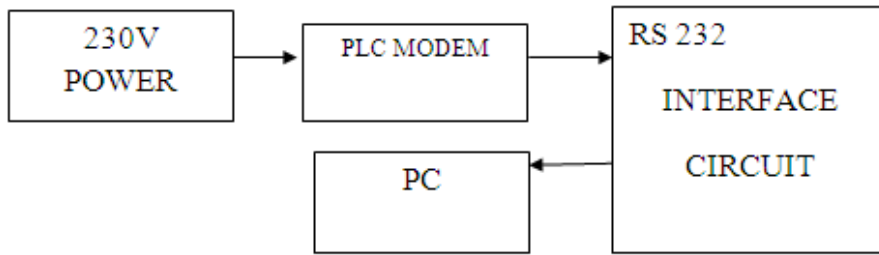

Receiver block diagram

Figure 5. Receiver.

7. Circuit Diagram

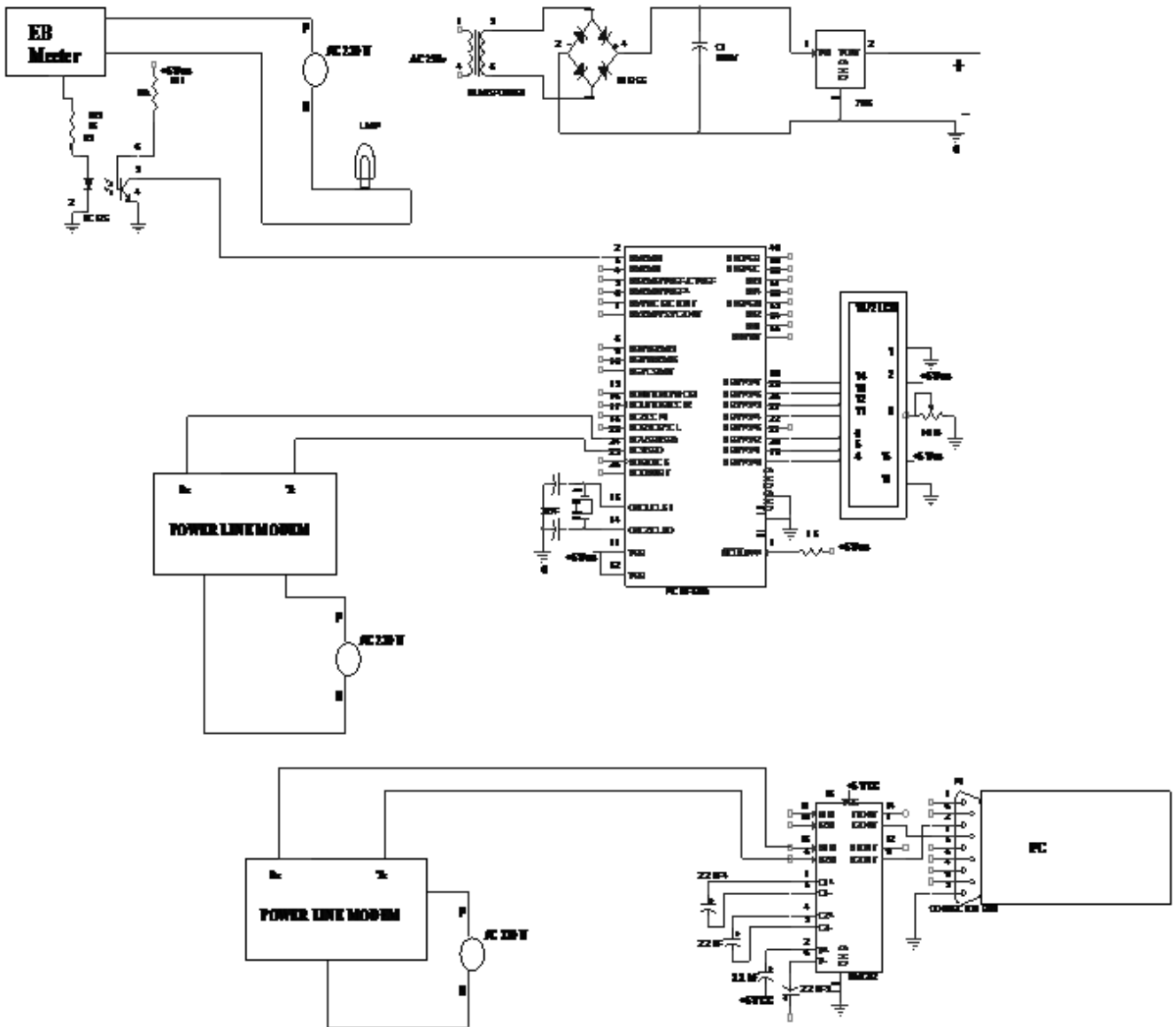

Figure 6. Circuit Diagram.

8. Working Principle

The working of the project can be classified into two major parts. They are listed in below:

- a. Transmitting section
- b. Receiver section

8.1. Transmitter Section

The 230V, 50Hz cycles per second AC offer is offer to the energy meter. The energy meter is connected with the ac load. Whenever the load is ON condition the energy disc starts to rotate and turn out analog signal. This analog signal is regenerate into digital signal. With the assistance of PIC microcontroller the liquid crystal display can show the unit of power consumed & and therefore the quantity for the consumed power. So the digital signal sends to the transmitter through the Opto coupler to safeguard the plc transmitter from high voltage. The plc transmitter wont to send the information of unit consumed & quantity to the receiver through the AC line plc transmitter & PIC microcontroller with 5V DC offer to control. They tend to use step down electrical device to convert 230V AC into 12V AC then its regenerate into dc by mistreatment diode rectifier. at the moment we tend to an employing a regulator to induce constant 5V DC offer and noises eliminated by the filter circuit.

8.2. Receiver Section

The receiver section of the electronic equipment is connected with the finish of the ability line. It receives the signal that is given by the transmitter section. Hence the receiver is additionally connected with the RS232 serial communication interface to attach the non-public laptop. By victimization the small code receiver package the ability consumption and quantity of it are often displayed in computer.

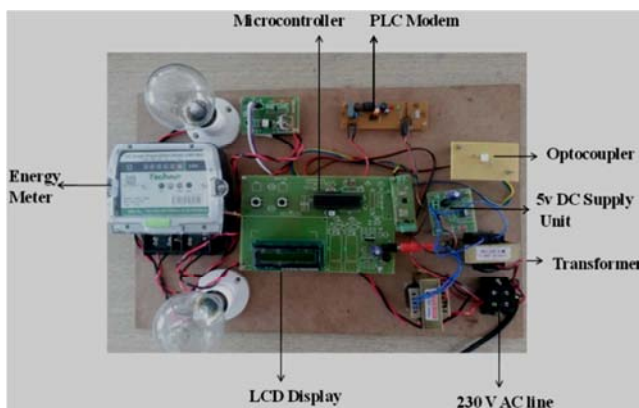

Figure 7. Transmitter section.

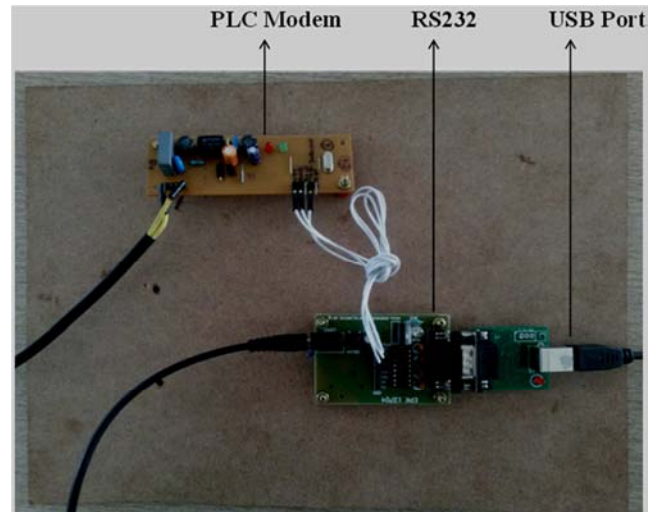

Figure 8. Receiver Section.

9. Conclusion

In this project the Automated Meter Reading through Power Line Carrier Communication is done successfully. The Power Line as a carrier communication and illustrate the working ability of electromechanical energy meter.

The electromechanical energy meter is made to an Automatic reading, in which the existing scenario of the project has been developed. There is no need of change to any special meter.

10. Future Scope

Automatic Prepaid Billing with the intimation of the following factors

- a. High load
- b. Low voltage
- c. Power factor variation

References

- [1] Amit Jain "A Prepaid Meter Using Mobile Communication" vol3, 2011.
- [2] Ashna. K, "GSM Based Automatic Energy Meter Reading system with Instant Billing", 2013.
- [3] Arun, S "Design And Implementation Of Automatic Meter Reading System Using GSM, ZIGBEE through GPRS", Vol. no. 2, May2012.
- [4] Bharat Kulkarni, "GSM based automatic meter reading system using ARM controller", Volume2, Issue5, Feb 2005.
- [5] Chunjuanwei, "Implementation Of Automatic Meter Reading System Using PLC and GPRS", 2011.
- [6] Elena M, "Power line Communication In Home-Building Automation System", 2004.
- [7] Harish P., "GSM Based Automatic Wireless Energy Meter Reading System", Vol. 1, Issue 9, November – 2012.

- [8] Moghavvemi. M, "A Reliable and Economically Feasible Automatic Meter Reading System Using Power Line Distribution Network", Jun 2013.
- [9] Mejbaul Haque, "Microcontroller Based Single Phase Digital Prepaid Energy Meter for Improved Metering and Billing System", 2011.
- [10] Sravanthi. T. "Prepaid Electricity Billing System Using GSM Mobile", vol. 2, issue 2, Feb 2013.
- [11] Vivekhashkar, "A Reliable Automatic Meter Reading System Using Power Line Distribution Network", issue 3, Vol. No. 1, 2012.

Biography



R. GUNASEKARAN was born in Erode in the year of 1981. He had completed his under graduation (B. E. – EEE) in the year of 2003 from Kongu Engineering College, Perundurai and post graduated M. E (Power Electronics & Drives) at KSR College of technology in the year of 2010. He is doing Ph.D., (Part-Time) in Anna university, Chennai at 2015 Onwards.

He is currently working as Assistant professor in the Department of EEE at Excel College of Engineering and Technology, Komarapalayam from June 2015. His research interest involves in power electronics, Renewable energy. He is a life member of Indian society for Technical Education.