

(NASA-CR-171987) PRE- AND POSTTREATMENT
TECHNIQUES FOR SPACECRAFT WATER RECOVERY
Final Report (Umpqua Research Co.) 103 p
Avail: NTIS HC A06/MF A01 CSCL 06A

N87-25766

Unclas
0083881

63/54

UMPQUA RESEARCH
COMPANY

**PRE- AND POSTTREATMENT TECHNIQUES
FOR SPACECRAFT WATER RECOVERY**

March 1987

UMPQUA
RESEARCH

PRE- AND POSTTREATMENT TECHNIQUES FOR
SPACECRAFT WATER RECOVERY
FINAL REPORT

March 1987

URC 70320

BY

David F. Putnam
Gerald V. Colombo
William F. Michalek

Prepared for National Aeronautics and Space Administration,
Lyndon B. Johnson Space Center, Houston, Texas
Contract No. NAS9-17073

Distribution of this report is provided in the interest of
information exchange. Responsibility for the contents resides
in the authors or organization that prepared it.

UMPQUA RESEARCH COMPANY

P.O. BOX 791 626 DIVISION

MYRTLE CREEK, OREGON 97457

Tel: (503) 863-5201

PREFACE

This final report has been prepared for Lyndon B. Johnson Space Center, National Aeronautics and Space Administration, under Contract NAS9-17073.

Requests for further information or assistance will be welcomed by the following Umpqua Research Company (UMPQUA) representatives:

David F. Putnam

Telephone: (503) 863-5201

Gerald V. Colombo

Telephone: (503) 863-5201

TABLE OF CONTENTS

1.0	INTRODUCTION	1
2.0	BACKGROUND	2
3.0	SUMMARY OF RESULTS	4
3.1	<u>Literature Search</u>	5
3.2	<u>Treatment Philosophy</u>	5
3.3	<u>New Pretreatment Agents</u>	6
3.4	<u>Post-treatment</u>	8
3.4.1	<u>Sorption Beds</u>	8
3.4.2	<u>Reverse Osmosis</u>	8
3.4.3	<u>Ultraviolet Light Assisted Oxone Oxidation</u> <u>(UV/O₃)</u>	8
4.0	CONCEPT DEVELOPMENT	8
4.1	<u>Chemical Pretreatments</u>	11
4.1.1	<u>Urine Distillation Tests</u>	12
4.1.2	<u>Wash Water Distillation Tests</u>	19
4.1.3	<u>Ersatz Humidity Condensate Distillation</u> <u>Tests</u>	22
4.1.4	<u>Microbial Testing</u>	26
4.1.4.1	<u>Urine Stability Testing</u>	26
4.1.4.2	<u>Urine Bacteria Challenge Testing</u>	27

4.1.4.3	<u>Urine Fungal Challenge Testing</u>	28
4.1.5	<u>Conclusion</u>	32
4.1.6	<u>Recommendations</u>	33
4.2	<u>Flocculation/Coagulation/pH Adjustment</u>	34
4.2.1	<u>Exploratory Tests</u>	35
4.2.2	<u>Optimization Studies</u>	36
4.2.3	<u>Distillation Test</u>	41
4.3	<u>Electrolytic Pretreatment</u>	42
4.4	<u>Post Treatment by Sorption Beds</u>	42
4.4.1	<u>Activated Carbon</u>	43
4.4.2	<u>Ion Exchange Resins</u>	43
4.4.3	<u>Polymeric Adsorbent</u>	43
4.4.4	<u>Multifiltration</u>	44
4.5	<u>Post Treatment by Reverse Osmosis</u>	66
4.6	<u>Post Treatment by Oxidation</u>	67
4.6.1	<u>Vapor Phase Ozonation Tests.</u>	68
4.7	<u>Post Treatment by Air Stripping</u>	72
4.8	<u>Post Treatment by Liquid/Liquid Extraction.</u>	74
4.9	<u>Post Treatment Microbial Control</u>	76
4.10	<u>Conceptual Designs and Trade-Offs</u>	79
5.0	CONCEPT RECOMMENDATIONS	90

LIST OF FIGURES

4.1-1	Laboratory Vacuum Still	18
4.4-1	Post Filtration Bed	45
4.4-2	Multifiltration Unit Schematic	46
4.4-3A	Organic Removal from Urine Distillate by Multi-media Sorbtion Bed (First Pass)	51
4.4-3B	Unibed Performance, TOC VS Length (Single Pass) .	52
4.4-4A	pH Changes of Urine Distillate Flowing Through a Multi-media Sorbtion Bed.	54
4.4-4B	Unibed Performance, pH VS Length	55
4.4-5A	Conductivity Removal From Urine Distillate by Multi-media Sorbtion Bed (Single Pass)	57
4.4-5B	Unibed Performance, Conductivity VS Length (Single Pass)	58
4.4-6A	Organic Removal From Urine Distillate by Multi-media Sorption Bed-Pass through Second Bed	64
4.4-6B	Unibed Performance TOC VS Length (Second Pass)	65
4.6-1	Vapor Phase Ozonation Distillation Apparatus . .	69
4.6-2	Vapor Phase Ozonation Distillation Apparatus with Addition of Vacuum Flash	71
4.9-1	Sorption Bed Test Set-Up	78

4.10-1A	Multifiltration Unit, Umpqua Research Company	
	Concept	82
4.10-1B	Multi-media Bed Design, Umpqua Research Company	
	Concept	83
4.10-2	Reverse Osmosis Unit, Bend Research Concept . . .	85
4.10-3	UV/O ₃ Post Treatment Unit, Westgate Research	
	Concept	87
4.10-4	Weight Comparison for the Three Candidate Post Filtration Methods (Total Equivalent Weight VS Mission Length	88

LIST OF TABLES

3.0-1	Comparison of Urine Pretreatments Containing Oxidizing Biocides to Those With Non-oxidizing Biocides	6
4.1-1	Ersatz Humidity Condensate Used in Distillation Tests	23
4.1-2	Distillation of Ersatz Humidity Condensate . . .	24
4.2-1	Exploration Flocculation/Coagulation Tests . . .	35
4.4-1	Composition and Performance of the First Experimental Unibeds	48
4.4-2	TOC Levels in Post-Filtration Test Beds (Single Pass)	50
4.4-3	pH Values-Sorption Bed Tests (Single Pass) . . .	53
4.4-4	Conductivity Levels in Post-Filtration Test Beds (Single Pass)	56
4.4-5	Summary of Approximate Amounts of TOC Removed By Sorption Beds in One Pass at 2 cm/min Feed . .	62
4.4-6	Summary of Bed Loadings after Processing 17 1/2 liters of Urine Distillate	63
4.5-1	Post Treatment Results for Reverse Osmosis of Urine Distillate	67
4.6-1	Results of Introducing Ozonated Air to the Vapor Phase During Distillation of HDAB Treated Urine .	68
4.6-2	Results of Vapor Phase Ozonization Tests	72

4.7-1	Organic Contaminants Removed to a Significant Degree by Air Stripping at Water Factory 21 . . .	73
4.7-2	Removal of Organics from Urine Distillate by Air Stripping	74
4.8-1	Removal of Organics from Urine Distillate By Liquid/Liquid Extraction Followed by Air Stripping	75
4.9-1	Aerobic Plate Counts from Sorption Beds for Various MCV Locations	79
4.10-1	Multifiltration Using Multimedia Beds	81
4.10-2	Reverse Osmosis Using Bend Research Modules . . .	84
4.10-3	UV/D ₃ Using Westgate Research Concept	86
4.10-4	Weight Summaries for the Three Candidate Post Filtration Methods	89
5.0-1	Summary of Recommendations	90

1.0 INTRODUCTION

The objective of this program was to develop techniques for satisfactory pretreatment of waste water (urine and wash water) prior to recovery by distillation and satisfactory post-treatment of the recovered water and Humidity Condensate for purification to the high quality necessary for reuse. The effort included literature and laboratory investigations, feasibility evaluation of candidate approaches, and development of conceptual designs for a waste water pretreatment system and a recovered water post treatment system.

In the experimental portions of the effort a laboratory glass still was used to process urine, wash water and humidity condensate. Various pretreatment techniques were evaluated. A new non-oxidizing chemical pretreatment was developed that decreases the organic content of urine distillate by a factor of three. In addition, the expendable weight of this pretreatment is less than one half that of previous pretreatment formulas and it can be formulated into an easily dispensable liquid.

Three promising post-treatment methods were identified as follows: (1) a train of various sorption beds; (2) reverse osmosis; and (3) ultraviolet light assisted ozone oxidation (UV-O₃).

2.0 BACKGROUND

Future manned spacecraft developed for large crews and long-term space operations, such as earth-orbiting Space Station, will require water reclamation to avoid prohibitive launch weight penalties and frequent resupply. Waste water, including urine and wash water can be recovered by distillation methods such as vapor compression distillation (VCD) (1,2) or vapor diffusion distillation such as that used by the Thermoelectric Integrated Membrane Evaporation System (TIMES) (3,4).

Prior to distillation, urine has to be treated to stabilize the volatile contaminant constituents to prevent carryover in the distillation process. In addition, the pretreatment should provide disinfection of the urine to maintain bio-static conditions. Several chemical pretreatment formulas have been utilized to accomplish this stabilization. A solution of sulfuric acid and chromium trioxide has been used in an Air Evaporation Water Recovery Process (5) as well as in the TIMES process. A solution of sulfuric acid, an anti-foaming agent, and an iodofor compound has been employed in the VCD subsystem. Recently, a formula that uses sulfuric acid and monopersulfate oxidizing agent has been developed (6). In addition, an electrolytic pretreatment process has been investigated to stabilize the urine without the need for addition of

expendable chemical agents (7). The use of a dual catalyst system has also been investigated to decompose the volatile constituents in the distillation vapor phase as an alternative to urine pretreatment (8)(9).

Wash water from personal hygiene and laundry facilities also needs to be treated prior to distillation. Like urine, wash water needs to be stabilized to prevent microbial growth and minimize volatile contaminant carryover. In addition, wash water must be treated to prevent carryover due to foaming during processing in the VCD subsystem. A process has been developed that utilizes the addition of ferric chloride to coagulate the soap constituents, allowing separation by filtration. During VCD wash water recovery tests at the Johnson Space Center, the wash water was pretreated with an anti-foaming agent, sulfuric acid and an iodoform compound.

Following distillation, the product water must be treated to remove low concentrations of contaminants that present toxic hazards and contribute to foul tastes and odors. The contaminants that carry over, in the distillation process, into the product water are mainly ammonia and volatile organics. There is concern that, with many recycles, organic contaminants could accumulate in the water processing system or in the human body and build up to toxic levels. It is therefore desirable to remove all measurable levels of organics in the post-treatment process.

To date, post-treatment has consisted of ion-exchange and activated carbon adsorption beds (11)(12). This scheme has produced clear, high quality water without objectionable odors or tastes. The ion-exchange resin and activated carbon, however, have failed to remove all measurable levels of organic contaminants.

In addition to the removal of organics, the recovered water has to be treated with a residual biocide such as iodine to maintain safe storage until the water is used. Iodine-impregnated resin beds have been used quite successfully to provide residual disinfection (9)(10).

In order to develop effective pretreatment and post-treatment techniques, all steps of the water recovery process have to be considered. The completeness or effectiveness of the pretreatment technique will necessarily affect the quality of the product water and therefore impact the required post-treatment. Similarly, the characteristics of the distillation process itself will impact the requirements of both waste water pretreatment and product water post-treatment.

3.0 SUMMARY OF RESULTS

Significant progress was made under this contract to define viable techniques for waste water pretreatment and recovered water post-treatment. The accomplishments are summarized in the following paragraphs.

3.1 Literature Search

A comprehensive literature search was conducted on spacecraft water recovery pretreatment and post-treatment techniques. The candidate methods selected for investigation were the following.

Chemical additives

Ion exchange

Granular activated carbon

Ultraviolet light assisted ozone oxidation (UV/O₃)

Vapor phase ozonation

Reverse osmosis

Air stripping

Liquid/liquid extraction

Flocculation/coagulation

pH adjustments

3.2 Treatment Philosophy

A treatment philosophy was developed on the argument that a given organic removal method should not have to be used at more than one point in a water recovery system. It was felt that one point of use should be sufficient and would avoid unnecessary duplication. It was further argued that the best place to apply an organic removal step is on distillate, not waste water, because distillate contains fewer organics, is a much cleaner liquid and is less corrosive than waste water. It follows then, that the ideal pretreatment should be designed to minimize organic

evolution from waste water. The foregoing arguments are summarized in the following two guidelines:

- (1) minimize organic evolution from wastewater
- (2) remove organics after the evaporation step, that is, from the vapor phase or from the distillate.

3.3 New Pretreatment Agents.

Two new pretreatment formulas, which contain no oxidizers, were developed under this contract. These new pretreatments reduce the organic level in urine distillate by a factor of 3 compared to pretreatment formulas that contained oxidizing chemicals. The data are summarized below in Table 3.0.-1.

TABLE 3.0-1. COMPARISON OF URINE PRETREATMENTS CONTAINING OXIDIZING BIOCIDES TO THOSE WITH NON-OXIDIZING BIOCIDES.

<u>PRETREATMENTS</u>	<u>TOTAL ORGANIC CARBON (TOC) LEVEL IN DISTILLATE MG/L</u>
Oxidizing Biocides: iodine, hexavalent chromium, oxone	24 to 30
New Non-oxidizing Biocides: metals (Cu ⁺⁺ +Cr ⁺⁺⁺) and hecadedecyl-trimethyl ammonium bromide (HDAB)	8 to 10

In addition to lowering the organic level in the distillate the use rate of the new non-oxidizing pretreatments is lower by a factor of 2 or 3 than the

oxidizing pretreatment formulas. In addition, each of the new pretreatments can be formulated into a single liquid solution amenable to pumping, whereas the oxidizing pretreatments were either a heavy viscous liquid or consisted of more than one phase, e.g., liquid and solid. Another disadvantage of the oxidizing pretreatments is their tendency to oxidize higher molecular weight organics to those of lower molecular weight, which are generally more difficult to remove by post-treatment.

To summarize, the new, non-oxidizing pretreatments developed under this contract have the following advantages over the oxidizing pretreatments:

- * The new pretreatments result in only 1/3 as many volatile organics that later must be removed in a post-treatment step.
- * The volatile organics that do appear in the distillate should be more easily removed by post-treatment methods.
- * The new pretreatments have use rates that are only about 1/3 to 1/2 the usage rates of previous pretreatments.
- * The new pretreatment formulations consist of a single phase, easily pumped liquid as opposed to previous pretreatment formulations that were either viscous and difficult to meter or consisted of a liquid and a solid phase that required two

separate dispensing techniques.

3.4 Post-treatment.

Three promising post-treatment methods were identified as follows:

3.4.1 Sorption Beds. Work was conducted on a train of sorption beds, including iodinated resin, strong acid cation resin, strong base anion resin, strong acid/base mixed resin, polymeric adsorbent and activated carbon. This train removed organics down to the 200 ppb range with only very small quantities of material needed. Less than 1.7 grams of material are now projected for 1000 grams of distillate. It is anticipated that this quantity can be significantly reduced by further experimental investigations.

3.4.2 Reverse Osmosis. Urine odor was removed, specific conductance was lowered by a factor of 6 and TOC was reduced by a factor of 8. Based on these good performance results more experimental investigative work should be pursued.

3.4.3 Ultraviolet Light Assisted Oxone Oxidation (UV/O₃) - TOC was reduced to the 200 ppb level without using expendables. UV-O₃ oxidation has an additional advantage in that it potentially can destroy all bacteria, viruses, and toxins, thus providing excellent separation between the waste water and recovered water. Additional work in this area is desirable.

4.0 CONCEPT DEVELOPMENT

The objective of this task was to identify promising

approaches for the pretreatment of urine and wash water prior to distillation and for the post-treatment of recovered water for application on long duration space missions. The candidate approaches were compiled as a result of a literature investigation, a technical survey of conventional pre- and post-treatment techniques, and cursory laboratory investigations of promising approaches. Several promising pretreatments and post-treatments were recommended for feasibility evaluations. The various approaches that were considered, the pre- and post-treatment philosophy that was developed, and the candidate concepts that were selected for feasibility evaluations are discussed.

The results of the literature search were compiled and presented to NASA in the following documents:

A. Water Treatment-Organics Removal.

Date: Jan. 9, 1984

Data Base: Water Resources Abstracts, 1979-83.

Scope: Water Treatment, Water Purification, Drinking Water, Potable Water, Domestic Water, Organic Compounds, Organic Matter.

Number of Citations: 147

Source: Oregon State University

B. Spacecraft Water Recovery.

Date: Jan. 27, 1984

Data Base: NASA Search Number SPECIAL, 1968-84.

Scope: Spacecraft Water Recovery, Pre-treatment and
Post-treatment Techniques.

Number of Citations: 224

Source: NASA Scientific and Technical Information
Facility

C. Spacecraft Water Recovery Techniques Bibliography.

Date: Dec. 9, 1983

Data Base: Umpqua Research Company

Scope: Spacecraft Water Recovery, Pre-treatment and
Post-treatment Techniques.

Number of Citations: 80

Source: Umpqua Research Company

D. Urine Preservation.

Date: Feb. 9, 1984

Data Base: Index Medicus 1973-84

Chemical Abstracts 1977-79

Scope: Urine, Stability, Storage, Preservation

Number of Citations: 29 and 32

Source: Oregon State University

E. Literature Search Summary

Date: Feb. 16, 1984

Data Base: This report summarizes the results of the
literature search. The most pertinent literature
and technical information is presented and
discussed.

The promising concepts identified in the literature

were analyzed for applicability to the desired space applications.

The pre and post-treatment methods that were considered are discussed in the following paragraphs. The cursory testing that was conducted to screen some of the methods is presented here. Several of the methods were rejected at this point. The remaining were recommended for subsequent feasibility evaluations.

4.1 Chemical Pretreatments.

Chemical pretreatments for urine distillation have been developed by NASA sponsored work over the last 20 years. The chemicals that are currently used are H_2SO_4 , to fix free ammonia; a biocide to prevent microbial decomposition of urea and other urine organics to ammonia and volatile organic compounds; an oxidizer to improve the odor of the distillate produced from pretreated urine; and sometimes an anti-foaming agent to prevent foaming during boiling and subsequent carryover of liquid urine by physical entrainment. The biocides previously used for urine and wash water pretreatment in aerospace applications are: $CuSO_4$, CrO_3 , Biopal and Oxone. The last three are oxidants. Recent off-gassing work done at NASA/JSC has shown that the oxidants may increase the number and amount of off-gassing organic products. In addition, oxidation of urine produces volatile organics of lower molecular weight, which tend to be more difficult to remove from the distillate.

Antifoaming agents that have been used include: SWS 211 and Dow H-10.

Distillation tests were performed on urine, wash water, and ersatz humidity condensate solutions to obtain comparative data on the ability of various chemical pretreatments to minimize volatile organic carryover. In addition, both static and challenge type microbial studies were performed to determine the effectiveness of various biocides for urine and wash water preservation.

Test Procedures and Summarized Results are presented in the following paragraphs.

4.1.1 Urine Distillation Tests. Various urine pretreatments were evaluated to determine their effectiveness in providing a relatively high-quality distillate. Four distillate quality criteria were used:

- a. Acceptable pH
- b. Low conductivity (K)
- c. Low ammonia (NH_3)
- d. Low total organic carbon (TOC)

PROCEDURE: Urine from the acidified urine pool (30 liter pool acidified to pH = 3 with H_2SO_4) was pretreated using the following methods:

- a. No treatment
- b. 5.0 g/l Oxone added as an oxidizing agent
- c. 0.44 g./l CrO_3 added as an oxidizing agent

- d. 1.76 g/l $\text{Cr}(\text{NO}_3)_3 \cdot 9\text{H}_2\text{O}$ + 0.18 g/l CuSO_4 added as biocides.
- e. 4.98 g/l $\text{FeSO}_4 \cdot 7\text{H}_2\text{O}$ added as a reducing agent
- f. Sufficient NaOH added to bring the pH to 11.5

150 ml of the sample was placed in the flask (See Figure 4.1-1) and distilled at 60 degrees C. Five 25 ml distillate fractions were removed and analyzed for pH, K, NH_3 , and TC (the total carbon test proved to be an accurate indicator of TOC, since inorganic carbon was found not to exceed 1 mg/l). In addition, brine total solid percentage was determined using a refractometer at the time of removal of each distillate fraction.

RESULTS:

<u>TREATMENT</u>	<u>FRACTION</u>	<u>TS%</u> <u>(Initial)</u>	<u>TS%</u> <u>(Final)</u>	<u>pH</u>	<u>Sp.</u> <u>Cond</u>	<u>NH_3</u>	<u>TC</u>
CONTROL	0 - 25 ml	3.0	3.9	5.5	11	1.7	31
	25 - 50	3.9	4.7	5.0	10	0.7	8
	50 - 75	4.7	6.7	4.8	10	0.9	8
	75 - 100	6.7	9.8	4.4	21	1.2	8
	100 - 125	9.8	21	4.5	23	1.3	10
OXONE	0 - 25 ml	4.4	4.1	4.6	17	3.4	38
	25 - 50	4.1	5.3	4.2	25	2.5	23
	50 - 75	5.3	7.5	4.1	36	2.2	19
	75 - 100	7.5	13.4	3.9	49	2.5	27
	100 - 125	13.4	48	3.7	76	2.3	38
CrO_3	0 - 25 ml	3.1	3.6	4.6	12	*	37
	25 - 50	3.6	4.6	4.7	10	*	28
	50 - 75	4.6	6.6	4.4	21	*	17
	75 - 100	6.6	11.0	4.2	29	*	17
	100 - 125	11.0	34	3.9	51	*	20
$\text{Cr}(\text{NO}_3)_3$ + CuSO_4	0 - 25 ml	3.2	3.7	5.4	4	1.7	10
	25 - 50	3.7	4.7	4.5	17	1.3	7
	50 - 75	4.7	6.3	4.3	24	1.1	6
	75 - 100	6.3	9.7	4.1	30	0.9	8
	100 - 125	9.7	21	4.1	40	1.1	9

FeSO ₄	0 - 25 ml	3.4	4.1	4.7	12	1.6	20
	25 - 50	4.1	5.0	4.2	25	1.0	9
	50 - 75	5.0	6.8	4.2	26	1.4	9
	75 - 100	6.8	10.2	4.2	31	1.2	9
	100 - 125	10.2	21	4.2	42	1.6	11
NaOH	0 - 25 ml	3.4	3.9	11.1	310	1500	45
	25 - 50	3.9	4.9	10.5	79	89	12
	50 - 75	4.9	6.6	10.1	31	10	9
	75 - 100	6.6	10.0	10.0	27	9.3	9
	100 - 125	10.0	16	10.0	28	11	11

* Interference noted.

SUMMARY AND CONCLUSIONS:

The effects on distillate quality of the six pretreatments investigated are summarized below by means of averaging the pH, Specific Conductance, NH₃, and TC from the fractions collected for each pretreatment.

PRETREATMENT	MEAN OF DISTILLATE FRACTIONS			
	pH	Sp. Cond.	NH ₃	TC
a. Control	4.8	15	1.2	13
b. Oxone	4.1	41	2.6	29
c. CrO ₃	4.4	25	*	24
d. CrNO ₃ + CuSO ₄	4.5	23	1.2	8
e. FeSO ₄	4.3	27	1.4	12
f. NaOH	10.3	95	320	17

* Interference noted

Some common patterns were discovered by comparing successive fractions from each pretreatment; these patterns are not reflected in the means presented above:

- a. pH: In general, distillate pH became more acidic with each fraction.

- b. Specific Conductance: Specific Conductance increased with each successive fraction (except with the last pretreatment, where Specific Conductance was more a function of NH_3 present).
- c. NH_3 : Again except for the NaOH pretreatment, where NH_3 was initially liberated in great quantities and then steadily diminished, the NH_3 results followed a fairly consistent pattern, in that NH_3 started relatively high and then dropped, later rising again.
- d. TOC: TOC, as a function of TC, patterned NH_3 by dropping from an initial high, then picking up again with later fractions. There may have been a common factor underlying both results, although TC and NH_3 are not overlapping analyses.

In conclusion, the effects of the six pretreatments investigated are given below:

- a. CONTROL: The untreated urine gave a distillate with an acceptable pH, Specific Conductance, NH_3 , and TC; in fact, compared with the other pretreatments, its average Specific Conductance and NH_3 were the lowest, and average TC second lowest. Seen in this perspective, any form of pretreatment in addition to acidification should be examined critically.
- b. OXONE: The use of Oxone, previously considered to be a useful pretreatment chemical due to its strong oxidative properties, should be strongly reexamined in

light of the results, which show it to have produced the lowest average pH and highest conductivity, NH_3 , and TC (except for NaOH, which was never seriously considered for pretreatment applications). Thus, using our criteria, Oxone produced the most unacceptable distillate of the first five pretreatments.

- c. CrO_3 : Although the CrO_3 results were acceptable in terms of pH, conductivity, and TC (the NH_3 reading was interfered, possibly with Cr^{+6} compounds), there was nothing discovered which would cause us to recommend the use of this oxidizing agent, since better results were obtained without adding CrO_3 .
- d. $\text{Cr}(\text{NO}_3)_3 + \text{CuSO}_4$: These heavy metal compounds were considered primarily as biocidal pretreatment. The results indicate that the addition of these biocides produced a distillate comparable to that of the control sample, with the lowest TC of the group tested. Thus, in terms of added pretreatments tested, this ranked as the best overall.
- e. FeSO_4 : According to the results, the use of FeSO_4 as a reducing agent produced an acceptable distillate, although there was nothing to indicate that it is an improvement over the control sample.
- f. NaOH: The addition of NaOH, forming an alkaline brine, caused the release of NH_3 (as was expected) which influenced the conductivity; both NH_3 and conductivity

were much higher in this distillate than any other. The clearly unacceptable results demonstrate the importance of acidification as an element of pretreatment.

As a final point, it should be noted, at least from this initial investigation, that the use of oxidizing agents (e.g. Oxone or CrO_3) as chemical pretreatments for urine produced a more unacceptable distillate (lower pH, higher conductivity, NH_3 , and TC) than the use of pretreatments without oxidizing agents, such as the control sample or the sample treated with heavy biocides. This finding calls into question most of the research on chemical pretreatment for urine distillation from the last twenty years, which supported the use of oxidizing agents. Additional research required for confirmation of this point includes at least the following:

- a. Distillation of pretreated urine at higher total solids concentrations, i.e. those more in the probable working range of an actual distillation unit (20-40%), to establish that the patterns discovered from our distillation runs are applicable to those conditions.
- b. Identification of major organics found in the distillate from each pretreatment. A possibility here is that the organics in one distillate may be easier to remove than those from another distillate, even though they are in greater abundance, causing a higher TOC.

FIGURE 4.1-1

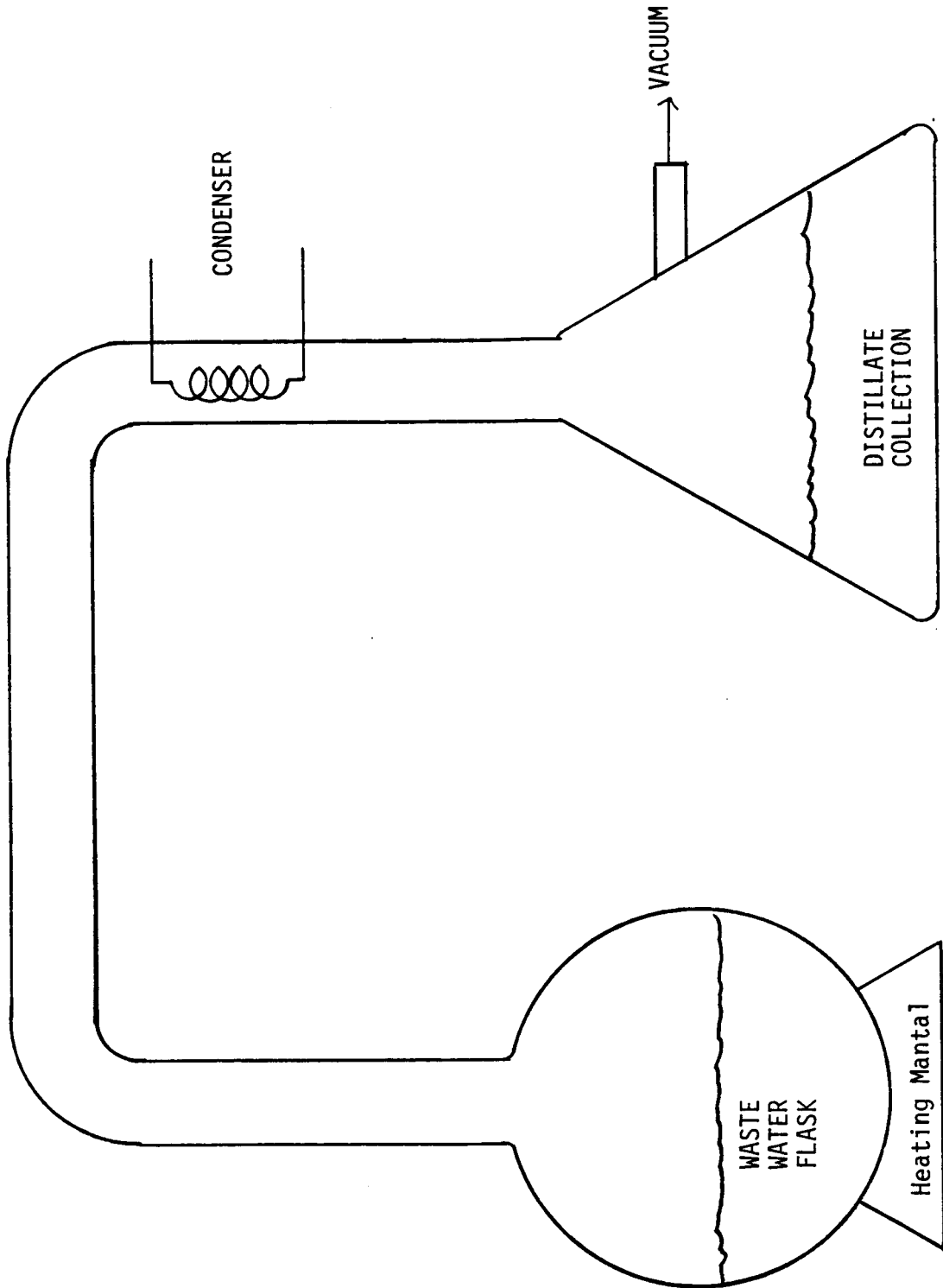

LABORATORY VACUUM STILL

4.1.2 Wash Water Distillation Tests. Distillation tests were performed on shower water using the following pretreatments:

(1) acid plus filtration: acid added as in (2) below plus filtration.

(2) <u>acid:</u>	-- Dosage --	
<u>item</u>	<u>grams/l</u>	<u>ml/l</u>
H ₂ SO ₄	2.31	1.25

(3) acid plus metals:

	Batch of pretreatment - solution -		-- Dosage --	
<u>item</u>	<u>ml</u>	<u>grams</u>	<u>grams/l</u>	<u>ml/l</u>
Cr (NO ₃).9H ₂ O	-	80	2.00	
CuSO ₄ .5H ₂ O	-	50	1.25	
H ₂ SO ₄	50	92.1	2.31	
H ₂ O	50	<u>50</u>	<u>1.25</u>	
TOTAL:		272.1	6.81	

(4) acid plus HDAB*:

	Batch of pretreatment - solution -		-- Dosage --	
<u>item</u>	<u>ml</u>	<u>grams</u>	<u>grams/l</u>	<u>ml/l</u>
HDAB*	-	1.6	0.04	
H ₂ SO ₄	50	92.1	2.31	
H ₂ O	50	<u>50.0</u>	<u>1.25</u>	
TOTAL:		143.7	3.60	2.50

*Hexadecyltrimethyl ammonium bromide

The shower water was generated by laboratory personnel. Individuals used a whole-body shower, consumed 3.8 liters of distilled water and used Shuttle non-foaming soap.

It was found that the acid plus metals pretreatment (3) caused flocculation and precipitation overnight. Adding only acid (2) caused precipitation after several days. Adding acid plus HDAB (4) caused less precipitation than acid alone.

The shower water had a Total Organic Carbon (TOC) content of 304 mg/l. A 150 ml quantity was distilled with pretreatments (1), (2) and (3). Distillation produced 125 ml of distillate and 25 ml of wash water concentrates. The distillates had the following TOC values:

	<u>Treatment (1)</u> <u>acid + filtration</u>	<u>Treatment (2)</u> <u>acid only</u>	<u>Treatment (3)</u> <u>acid + metals</u>
TOC, mg/l	2.6	2.6	17.7 6.7 (repeat)

Addition of an anti-foaming agent was not necessary. The elevated TOC values for Treatment (3) can not be explained but may be due to entrainment. More testing is indicated.

Mixture of Shower Water and Urine.

A mixture of shower water and urine (2:1 by volume) was distilled for two pretreatments, acid plus metals (3) and acid plus HDAB (4). 150 ml of mixture was distilled to

produce 125 ml of distillate. The results are presented below.

	Treatment (3) <u>acid + metals</u>	Treatment (4) <u>acid + HDAB</u>
pH, pH units	4.6	4.8
Sp.Cond., umho/cm	9.4	6.8
NH ₃ , mg/l	0.88	0.47
TOC, mg/l	10.7	7.1

Both of these distillations produced a water similar in TOC levels to the water produced from 100% urine (TOC = 8 to 10 mg/l). Specific conductance and ammonia levels were lower than in distillates from 100% urine. Antifoam had to be used with both pretreatments. In previous tests antifoam had not been necessary with urine until concentrations of 30 per cent solids and also had not been necessary with wash water containing the non-foaming soap.

It is interesting that the acid + HDAB pretreatment produced better results than the acid + metals pretreatment. It is felt that more testing should be done before drawing any conclusions. Especially since there is no apparent explanation for the better performance of HDAB.

CONCLUSIONS:

Based on these test results, it appears that acid plus HDAB (4) is the best pretreatment for wash water and mixtures of wash water and urine. This pretreatment produces the best distillate with the lowest dosage of pretreatment solution. Should it prove necessary for

microbiological control, the amount of HDAB could be significantly increased from its present dosage level of 0.04 g/l with minimum weight penalty.

Further investigations are planned in the Phase II effort. Greater dosages of HDAB will be explored and new biocides will be investigated and compared to acid plus metals (3) and acid plus HDAB (4). Thus there will be new data, which are expected to validate these results and confirm the recommendation of acid plus HDAB.

4.1.3 Ersatz Humidity Condensate Distillation Tests. A batch of ersatz humidity condensate was prepared and distilled with and without pretreatment. The ersatz mixture is shown in Table 4.1-1 below. This formulation is derived from the European Space Lab Data and NASA-JSC BENDS Chamber Data. The Octanoic acid represents all of the fatty acids.

TABLE 4.1-1 ERSATZ HUMIDITY CONDENSATE
USED IN DISTILLATION TESTS

<u>Molecular weight</u>	<u>Carbon weight</u>	<u>Constituent</u>	<u>Amount ml/l</u>	<u>Sp gr</u>	<u>Concentration mg/l</u>	<u>Carbon mg/l</u>
144.2	96	Octanoic Acid $\text{CH}_3(\text{CH}_2)_6\text{CO}_2\text{H}$	20	0.862	17.24	11.5
58.1	48	Acetone $\text{CH}_3\text{CO CH}_3$	3	0.799	2.40	2.0
60.1	36	Isopropyl Alcohol $\text{CH}_3\text{CHOH CH}_3$	1	0.788	.79	.5
35.05	-	$\text{NH}_4 \text{ OH}$ (58%)	30	0.900	7.6 as NH_3	0
Calculated Carbon =						14.0

The measured values of the above solution were:

pH = 10

Specific Conductance = 15 $\mu\text{mho-cm}^{-1}$

TOC = 14.3 mg/l

This measured TOC value of 14.3 mg/l checks very closely with the calculated value of 14.0 mg/l.

The results of the distillation tests are presented in Table 4.1-2.

TABLE 4.1-2 DISTILLATION OF ERSATZ
HUMIDITY CONDENSATE

<u>Pretreatment</u>	<u>Parameter</u>	<u>- Values -</u>	
		<u>Raw</u>	<u>Distilled</u>
without pretreatment:	amount of liquid, ml	1,000	460
	pH	10.0	9.0
	Sp. Cond, umho-cm ⁻¹	15	25
	TOC, mg/l	14.3	8.0
	NH ₃ , mg/l	7.6	4.4
with Cr ^{III} + Cu ^{II} + H ₂ SO ₄ :	amount of liquid, ml	1,000	460
	pH	1.9	4.5
	Sp. Cond, umho-cm ⁻¹	9,950	18
	TOC, mg/l	15.7	20.0
	NH ₃ , mg/l	7.6	ND
with HDAB + H ₂ SO ₄ :	amount of liquid, ml	1,000	690
	pH	2.7	4.4
	Sp. Cond, umho-cm ⁻¹	6,800	23
	TOC, mg/l	31.4	20.0
	NH ₃ , mg/l	7.6	ND

In distilling the ersatz humidity condensate with no pretreatment, the first 460 ml of distillate from the 1000 ml charge had a little over one-half the TOC and NH₃ concentration of the raw charge. Continued distillation would probably have produced proportionately higher concentrations of TOC and NH₃ in the distillate due to the higher concentrations building up in the charge.

Pretreatment with Cr^{III} + Cu^{II} + H₂SO₄ increased the specific conductance of the raw charge from 15 to 9,950

umho-cm⁻¹ and lowered the pH from 10.0 to 1.9. The TOC and NH₃ concentrations were not changed. The first 640 ml of distillate from the 1,000 ml charge contained no measurable NH₃. However, the TOC was 20 mg/l. This is higher than the initial measured TOC concentration in the charge (15.7 mg/l). Obviously, the acidification process increased the volatility of the dissolved organics.

Pretreatment with HDAB + H₂SO₄ increased the specific conductance of the raw charge from 15 to 6,800 umho-cm⁻¹ and lowered the pH from 10.0 to 2.7. It also increased the measured TOC from 14.3 to 31.4 due to the addition of HDAB. The first 690 ml of distillate from the 1,000 ml charge contained no measurable NH₃. The TOC was 20.0 mg/l, just as it was with the Cr^{III} + Cu^{II} + H₂SO₄ pretreatment. This would indicate that the HDAB is probably not volatilizing or otherwise affecting the distillation process. This test appears to confirm, that the acidification process increases the volatility of the dissolved organics.

CONCLUSION:

Based on these tests it is concluded that the acidification pretreatments that have been developed for urine and wash water are not appropriate for humidity condensate, as far as organics are concerned. They do, however, tie up the ammonia in humidity condensate. Before it would make sense to mix humidity condensate with either wash water or urine for distillation, from the point of view

of removing organics, some kind of new pretreatment would have to be devised to tie up the organics without detrimental effects on the wash water or urine when mixed with them. At this time no appropriate approaches are evident.

Considering the current state-of-the-art, it appears that the lowest penalty approach to purification of humidity condensate would be to forego a distillation step and go directly to post-filtration. Such post-filtration could in some manner be combined or integrated with the post-filtration of urine and/or wash water distillate.

4.1.4 Microbial Testing. Tests were performed to assess the effectiveness of selected chemical pretreatments in preventing microbiological growth in acidified urine (urine acidified to a pH of approximately 3 by addition of 1.25 ml/l of H_2SO_4) and shower wash water.

4.1.4.1 Urine Stability Testing. 20 ml samples of acidified urine (1.25 ml/l of H_2SO_4) were checked for stability after thirty days under the following conditions:

- a) Acidified urine at 2° C
- b) Acidified urine at 25° C
- c) Acidified urine + 1.76 g/l $Cr(NO_3)_3 \cdot 9H_2O$ and 0.18 g/l $CuSO_4 \cdot 5H_2O$ stored at 25° C (room temperature).

The chromiums and copper compounds were added as biocides with the following results:

<u>SAMPLE</u>	<u>TIME</u>	<u>pH</u>	<u>MICRO COUNT</u>	<u>VISUAL OBSERVATIONS</u>		
				<u>SOLIDS</u>	<u>COLOR</u>	<u>CLEARNESS</u>
URINE (2 c)	Initial	2.8	<100/ml	none	yellow	clear
	Final	2.8	<100/ml	none	yellow	clear
URINE (25 C)	Initial	2.8	<100/ml	none	yellow	clear
	Final	2.9	3700/ml	yeast only	yellow	clear
URINE + BIOC.	Initial	2.8	<100/ml	none	yellow	clear
	Final	2.5	<100/ml	none	yellow	clear

SUMMARY AND CONCLUSIONS:

From the preceding observations, the main factor which could potentially affect the stability of acidified urine would be microbial growth. An organism identified as a yeast began growing in the acidified urine pool (25 degrees C) sample about halfway through the testing period. The two methods of preservation investigated, refrigeration and addition of biocides, both proved capable of controlling microbial growth.

4.1.4.2 Urine Bacteria Challenge Testing. Testing was performed to determine if bacteria could survive in the acidified urine pool without the addition of a biocide. 25 ml samples of the acidified urine pool were seeded to produce a 10^4 bacterial density with a) DI water, b) Pseudomonas aeruginosa, and c) Streptococcus faecalis. Plate counts were performed at 0 hours and 24 hours on the samples with the following results:

<u>SEED</u>	<u>TIME</u>	<u>COUNT/ML</u>
DI WATER	0 hr	<100
	24 hr	<100
PSEUDO.	0 hr	<100
	24 hr	<100
STREP.	0 hr	$8.1 * 10^4$
	24 hr	<100

SUMMARY AND CONCLUSIONS:

It is obvious that the challenge organisms selected did not survive in pH3 urine; only Streptococcus faecalis survived the few minutes between seeding and sampling, but it too was gone by 24 hours.

These results were discussed with a microbiologist at Oregon State University, who concurred with our suspicion that no bacteria common to human flora would survive in such acidic conditions. He recommended we investigate the survival rates of fungi, many of which would thrive under the same conditions.

Therefore, in terms of biocidal treatment of an acidified urine pool, bacterial challenge organisms pose no threat; biocidal dosages should be investigated instead on fungal challenge organisms.

4.1.4.3 Urine Fungal Challenge Testing. Fungi generally thrive in acidic conditions and are therefore more relevant challenge organisms than bacteria. Tests were conducted on acidified urine pretreated with 1) Oxone, 2) Cr⁺⁺⁺ and Cu⁺⁺, and 3) HDAB, with the following results.

Oxone.

25 ml sample of acidified (1.25 g/l H₂SO₄) urine plus 5 g/l Oxone were seeded to produce a 10³/ml density of the following organisms:

- a) Pseudomonas aeruginosa
- b) Streptococcus faecalis
- c) Aspergillus niger (A fungal organism)

Plate counts were performed on Pseudomonas and Streptococcus samples after 48 hours in plate count agar at 35° C and on the Aspergillus sample after 5 days in Saboraud's agar at 20° C with the following results:

<u>SAMPLE</u>	<u>PSEUDO. SEED</u>	<u>STREP. SEED</u>	<u>ASPER. SEED</u>	<u>NO SEED</u>
CONTROL	<1.0 x 10 ²	<1.0 x 10 ²	7.0 x 10 ²	<1.0 x 10 ²
URINE+OXONE	<1.0 x 10 ²	<1.0 x 10 ²	<1.0 x 10 ²	<1.0 x 10 ²

SUMMARY AND CONCLUSIONS:

The control sample indicates that the challenge bacteria used do not thrive in pH 3 urine, but the fungus does. A 5.0 g/l dosage of Oxone was sufficient to kill this fungus in the urine.

Cr⁺⁺⁺ and Cu⁺⁺. The pretreatment formula of Cr(NO₃).9H₂O (mol wt = 400) plus CuSO₄.5H₂O (mol wt = 250) was added to acidified urine to produce 0.001, 0.005, 0.01 and 0.02 molar concentrations. These concentrations were then seeded with enough Aspergillus niger, a fungal organism, to produce

approximately 10^3 organisms per ml. Growth occurred in the acidified control and caused it to develop a disagreeable odor. Growth occurred much more slowly or not at all in the Cr^{+++} + Cu^{++} treated samples and eventually the mold population died out in three of the four samples. No detectable urine deterioration was observed in any of the samples. The data are summarized below.

MOLD PLATE COUNTS FOR ACIDIFIED URINE TREATED WITH

Cr^{+++} + Cu^{++}

Time	Control	0.001M//1 (.65g/1)	0.005M/1 (3.25g/1)	0.01M/1 (6.25g/1)	0.02M/1 (13.5g/1)
0 hr	4×10^3 per ml	4×10^3	4×10^3	4×10^3	4×10^3
24 hr	8×10^4	6×10^4	5×10^3	3×10^3	2×10^3
1 wk	2×10^6	5×10^4	2×10^4	2×10^3	5×10^2
2 wk	4×10^5	3×10^5	5×10^3	8×10^2	1×10^2
4 wk	3×10^6	3×10^3	<10	<10	0
8 wk	TNTC	31	100		

These data indicate that the metals tend to prevent mold growth and gradually kill off spores.

Hexadecyltrimethyl Ammonium Bromide (HDAB)

Acidified urine was treated with 1 ml/1 of a 4% solution of HDAB and spiked with the JSC mold culture*, as was a metals treated sample and a control. The results are summarized below.

*Trichoderma

**Bacteria and Mold Plate Counts for Spiked Acidified Urine
Treated with Cr⁺⁺⁺ + Cu⁺⁺ and Hexadecyltrimethyl
Ammonium Bromide (HDAB).**

<u>Time</u>	acidified only <u>control</u> Bacteria/Mold	Cr ⁺⁺⁺ +Cu ⁺⁺ 0.005 m/l <u>3.25 g/l</u> Bacteria/Mold	HDAB 1 ml/l of 4% <u>Bacteria/Mold</u>
24 hr	TNTC/TNTC	TNTC/<100	25/<100
18 day	TNTC/TNTC	TNTC/1	1/0

The HDAB treatment appears to be a better microbiocide than the metals treatment for urine. Shower water was evaluated with natural flora with the following results.

**Bacteria and Mold Plate Counts for Acidified Shower Water
(1.25 ml/l H₂SO₄) treated with Cr⁺⁺⁺ + Cu⁺⁺ and
Hexadecyltrimethyl Ammonium Bromide (HDAB).**

<u>Time</u>	acidified only <u>control</u> Bacteria/Mold	Cr ⁺⁺⁺ +Cu ⁺⁺ 0.005 m/l <u>3.25 g/l</u> Bacteria/Mold	HDAB 1 ml/l of 4% <u>Bacteria/Mold</u>
24 hr	TNTC/50	0 / 6	0 / 11
18 day	TNTC/TNTC	0 / 0	0 / 19

These results indicate that in shower water, HDAB is not as good a moldicide as the metals. This is probably because soap tends to inactivate HDAB. However, it appears to inhibit microbial growth sufficiently to be an effective

pretreatment agent. It can always be used at a higher concentration, which may be necessary with other cleansing agents or higher concentrations of the shuttle nonfoaming soap.

4.1.5 Conclusion. Based on the foregoing distillation tests and microbial testing the following conclusions are drawn.

- 1) H_2SO_4 effectively binds free ammonia present in solution which minimizes carryover in the distillate phase.
- 2) H_2SO_4 addition to lower solution pH to approximately 3 in wash water and urine effectively eliminates bacterial growth but does not eliminate fungal growth.
- 3) The addition of Hexadecyltrimethyl Ammonium Bromide (HDAB) to acidified urine and wash water solutions effectively limit bacterial and fungal growth.
- 4) The addition of $Cr^{III} + Cu^{II}$ ($Cr(NO_3)_3 \cdot 9H_2O + CuSO_4 \cdot 5H_2O$) to acidified urine and wash water effectively limits bacterial and fungal growth.
- 5) Wash water and mixture of wash water and urine treated with HDAB appear to produce better distillate than when treated with Cr^{III} and Cu^{II} .
- 6) The oxidizing pretreatment chemicals, although effective in bacteriological control, produce

poorer quality distillate than either HDAB or $\text{Cr}^{+1} + \text{Cu}^{+1}$ chemical pretreatments.

- 7) The acidification of ersatz humidity condensate increased the volatility of dissolved organics.

4.1.6 Recommendations: The wash water and urine, pretreatment with H_2SO_4 and Hexadecyltrimethyl Ammonium Bromide (HDAB) gives optimum results in terms of microbial control and distillate quality. More testing should be completed with high dose rates of HDAB to ensure satisfactory performance should high doses be required for microbial control in extreme cases.

Additional research should be performed to confirm the results of this investigation that concluded that non-oxidizing agents outperformed oxidizing agents for urine pretreatment. This is contradictory to most research in this area that has been performed over the last 20 years.

The pretreatments investigated in this study are not suitable for humidity condensate. Some new form of pretreatment needs to be developed before humidity condensate could be mixed with urine or wash water prior to distillation. A better approach at this time would be to forego the distillation step with humidity condensate and go directly to the post-filtration step in the purification process.

4.2 Flocculation/Coagulation/pH Adjustment.

Some sources conclude that flocculation/coagulation with inorganic multivalent ions removes suspended organics (turbidity and colloidal matter) from water but very few dissolved organics. However, one source concludes that FeCl_3 can be nearly as effective as activated carbon in organic removal in some cases. Another source concludes that cationic surfactants are effective bactericides, are coagulants of clay and color, and remove some soluble organic molecules, e.g., humic acid and lignin. Based on these findings it was felt that flocculation/coagulation might be effective in urine pretreatment and possibly in post treatment. Therefore cursory investigations were conducted in which it was first found that both alum and FeCl_3 , when used individually, remove urine organics. Next it was found that using alum and FeCl_3 together had a synergistic effect and removed as much as 38% of the organics in urine. An optimum dosage, pH and mixing method was established. Then distillation tests were run using the optimum pretreatment. Unfortunately there was only a small reduction (approximately 15%) in the organic level of the distillate, forcing the conclusion that this pretreatment does not effectively remove the volatile organics of interest, although it does remove a significant portion of the non-volatile organics from urine.

A description of the test procedures and results are presented in the following paragraphs.

4.2.1 Exploratory Tests. The purpose of these exploratory tests was to assess the impact of various chemical coagulants upon the solids, odor and appearance of urine, as a method of screening these coagulants as possible elements in chemical pretreatment of urine prior to distillation. Since reduction of volatile organics is a primary goal of chemical pretreatment, an effective chemical coagulant would presumably reduce urine total solids and odor if it were removing organics.

The procedure consisted of adding FeCl_3 , alum and lime individually to the acidified urine pool samples at a concentration of 2 g/l of urine and mixed thoroughly. The acidified urine pool consisted of 52 liters of urine acidified with 2.3 g of H_2SO_4 per liter of urine and stored at 2 degrees C. The total solids percentage (measured with a refractometer), odor, and appearance of the three mixtures, as well as a control sample from the urine pool, were recorded after five minutes. The results are summarized in Table 4.2-1.

TABLE 4.2-1. EXPLORATORY FLOCCULATION/COAGULATION TESTS

<u>TREATMENT</u>	<u>TOTAL SOLIDS%</u>	<u>ODOR</u>	<u>APPEARANCE</u>
Control	3.1	Normal	Clear
FeCl_3	3.1	Slightly Less	Precipitate at bottom
Alum	3.1	Slightly Less	Clear
Lime	3.3	No change	Precipitate at bottom

The total dissolution of each coagulant at 2 g/l concentration would theoretically increase the total solids by 0.2%. Of the 3.1% total solids in the original urine pool sample, only 0.8% represent the dissolved organics potentially removable by chemical coagulation; the remaining 2.3% consist of NaCl and urea. Seen in this perspective, it could be concluded that both FeCl_3 and alum removed as much as 25% (0.2% out of 0.8%) of the target group. The addition of the coagulant masks this point in the total solids analysis (i.e., 3.1% total solids + 0.2% coagulant - 0.2% organics = 3.1%). Using the same reasoning, it can be concluded that the addition of lime failed to remove organics as indicated by the increase in total solids from 3.1% to 3.3%.

The odor decreased slightly for FeCl_3 and alum treatment but not for lime. This tends to support the above interpretation that FeCl_3 and alum removed organics but lime did not.

Based on this exploratory work it was recommended that FeCl_3 and alum be further examined in terms of their ability to remove volatile organics from urine. But first, optimization studies were conducted to establish the best dosages, pH and mixing methods.

4.2.2 Optimization Studies. The purpose of these studies was to optimize the process of chemical

flocculation/coagulation for removal of volatile organics from urine. The criterion used was the ability to remove total organic carbon from urine. The coagulants used were: FeCl_3 , alum and a mixture of FeCl_3 and alum. The actual chemical formulas were: $\text{FeCl}_3 \cdot 6\text{H}_2\text{O}$ and $\text{Al}_2(\text{SO}_4)_3 \cdot 14\text{H}_2\text{O}$. The parameters that were varied were: dosage, pH, stir rate and mixing time.

As a general procedure for all these tests, a 50 ml acidified urine pool sample was dosed with coagulant and the pH adjusted. Then the sample was mixed for a certain period of time, after which 10 ml were transferred to a centrifuge tube and centrifuged for 5 minutes; precipitate volume was recorded. Total organic carbon analysis was performed on a 10^{-2} dilution of supernatant. Percentage reduction in TOC from the acidified urine control (unadjusted for pH) was calculated. The specific procedure and results for the four tests are given below:

- a. Type of Coagulant: 0.01 m/l FeCl_3 , 0.1 m/l alum, and 0.01 m/l FeCl_3 plus 0.01 m/l alum were used as the coagulant dose. pH was both unadjusted (about 2.5) and adjusted to 5. The samples were mixed for 20 minutes.

RESULTS: pH 2.5

<u>SAMPLE</u>	<u>TOC(mg/l)</u>	<u>%TOC Reduction from Control</u>	<u>Precipitate</u>
Control	4600	-	None
Alum	4500	Not Significant	None
FeCl ₃	4400	4	0.3 ml
Alum + FeCl ₃	4100	11	0.3 ml

RESULTS: pH 5

<u>SAMPLE</u>	<u>TOC(mg/l)</u>	<u>%TOC Reduction from Control</u>	<u>Precipitate</u>
Alum	4600	Not Significant	0.4 ml
FeCl ₃	4400	4	0.4 ml
Alum + FeCl ₃	3800	16	1.5 ml

b. Mixing Method: The samples were dosed with 0.05 m/l FeCl₃ and 0.05 m/l alum; pH was adjusted to 6. The samples were mixed as follows on a standard magnetic stir plate:

1. 30 RPM for 5 minutes
2. 600 RPM for 5 minutes
3. 30 RPM for 60 minutes
4. 600 RPM for 60 minutes

RESULTS:

<u>SAMPLE</u>	<u>TOC(mg/l)</u>	<u>%TOC Reduction from Control</u>	<u>Precipitate</u>
Control	4100	-	None
30 RPM 5 min	3400	17	3.5 ml
600 RPM 5 min	3400	17	3.5 ml
30 RPM 60 min	3400	17	3.5 ml
600 RPM 60 min	2900	29	4.5 ml

CONCLUSIONS: It appears the faster the rate and longer the contact time, the better the removal; in this test mixing at 600 RPM for 60 minutes gave the best results.

c. pH: The samples were dosed with a 0.01 m/l $FeCl_3$ and 0.01 m/l alum concentration from a 0.5 m solution of the two coagulants. pH was adjusted to 3,4,5,6 and 7 with NaOH. The samples were stirred for 20 minutes and allowed to settle for 1 hour, then stirred again prior to centrifugation.

RESULTS:

<u>SAMPLE</u>	<u>TOC(mg/l)</u>	<u>%TOC Reduction from Control</u>	<u>Precipitate</u>
Control	4400	-	None
pH 3	4100	7	0.4 ml
pH 4	3300	25	0.8 ml
pH 5	4000	9	1.5 ml
pH 6	4400	0	1.5 ml
pH 7	4400	0	1.5 ml

CONCLUSION: Removal efficiencies differ at different pH values; however, the two tests concerning pH gave conflicting results. In test "c" above, the liquid coagulant solution used may have affected the TOC removal around pH 6 resulting in a very low percentage reduction. In two other tests at pH 6 (tests "b" ("Mixing Method") and part of "d" ("pH and dose adjustment")) TOC removal was noted; the liquid coagulant solution was not used for these tests. In any case, optimum pH for TOC removal from urine is probably in the 4 - 6 range.

d. pH and Dosage Adjustment: Sample dosage with FeCl₃/alum was 0.001 m/l and 0.05 m/l; pH was adjusted to 4, 5 and 6. The samples were stirred 10 minutes and settled 50 minutes, then further agitated prior to centrifugation.

RESULTS:

<u>SAMPLE</u>	<u>TOC(mg/l)</u>	<u>%TOC Reduction from Control</u>	<u>Precipitate</u>
Control	4800	-	None
RESULTS: pH 4			
.001 m	4400	8	<0.1 ml
.05 m	3100	35	1.5 ml
RESULTS: pH 5			
.001 m	4200	13	<0.1 ml
.05 m	3800*	21*	3.0 ml
RESULTS: pH 6			
.001 m	3700	23	<0.1 ml
.05 m	3000	38	3.5 ml

* Lab accident possibly increased TOC for this sample.

CONCLUSION: The results indicate that the more coagulant used, the better the TOC removal. No upper limit was investigated, however; from these tests a 0.05 m concentration gave best results.

Based on these optimization studies it was recommended that the best coagulant be evaluated in a distillation test.

4.2.3 Distillation Test. The purpose of this test was to evaluate the potential of flocculation/coagulation of urine as a removal mechanism for volatile organics, which are generally carried over during urine distillation.

The procedure involved distilling 150 ml samples from the acidified urine pool treated as follows:

- a) 0.05 m/l $\text{FeCl}_3 \cdot 6\text{H}_2\text{O}$ and 0.05 m/l $\text{Al}_2(\text{SO}_4)_3 \cdot 14\text{H}_2\text{O}$ were added and the pH adjusted to 4.0 with NaOH, then rapidly mixed for 1 hour.
- b) the same as (a) but centrifuged after mixing and the precipitate discarded.

Samples (a) and (b) were distilled in an all-glass apparatus; Distillation temperature was 60 C. A Total Organic Carbon (TOC) analysis was performed on the first 125 ml of distillate collected from each 150 ml sample.

RESULTS:

<u>SAMPLE</u>	<u>DISTILLATE TOC</u>
Control	7 mg/l
Coagulant added	6 mg/l
Coag. + centrifuged	6 mg/l

CONCLUSIONS: The organic removal ascribed to coagulants in previous tests does not seem to apply to volatile organics; i.e. those that carry over during distillation at 60 C. Therefore, coagulation of urine does not prove to be an acceptable method of reducing the organic level in urine distillate.

4.3 Electrolytic Pretreatment.

Electrolytic Pretreatment is pertinent to urine which contains sodium chloride, but not to distillate, which lacks an electrolyte. Experience with distilling electrolytically pretreated urine at McDonnell Douglas (14) showed that a substantial amount of pretreatment is required to produce an acceptable distillate. The electrolytic process uses considerable electrical power and produces large amounts of gaseous by-products that require further processing. For these reasons and because there are more promising alternatives, it was felt that electrolytic pretreatment should not be selected for further study in this program.

4.4 Post Treatment by Sorption Beds.

The literature search produced numerous citations in respect to the ability of activated carbon and ion exchange resins to remove trace organic compounds from drinking water. These sorption media have been routinely used to polish urine distillate and humidity condensate in space-type water recovery systems. However, very little work has been done to experimentally evaluate the performance of

various media or to optimize the amount of media and the sequence in which it should be used. A major reason for this is that until recently, there was very little information concerning the identity of organic compounds in question. There is some GC/MS data available, but a good carbon balance has yet to be obtained.

4.4.1 Activated Carbon. Granular activated carbon (GAC) has better organic removal efficiency than powdered activated carbon (PAC). Also, GAC is easier to use in zero g than PAC because it is used in flow-through beds whereas PAC is added to the water and then must be removed by filtration. Much longer beds (15 to 30 ft) are needed than have been used to date in aerospace systems. Activated carbon can be optimized for specific organic compounds; thus an optimum post filtration bed might contain several different carbons.

4.4.2 Ion Exchange Resins: Ion exchange resins remove mainly inorganic ions but are also effective for removal of some organics. In post treatment they may be able to remove organics that cannot be removed by any other method. There are many different kinds of resins and probably several would be required in an optimized post treatment bed.

4.4.3 Polymeric Adsorbent. This is a macroreticular polystyrene divinylbenzene copolymer produced by Rohm & Haas. It is known to adsorb surfactants, fatty acids, steroids, enzymes, amino acids, polypeptides and proteins.

It is recommended for use in canneries and laundries among other applications.

4.4.4 Multifiltration. This method consists of a train of sorption beds that contain various sorption media. In conventional use, flow is usually passed completely through one bed material before being passed through second or third material. Replenishment and/or regeneration occurs as beds or portions of beds are expended. In the present instance the use of at least five different media are contemplated. If beds were set up in the conventional manner, then an inventory of at least five different bed types would be required for changeout when beds become saturated. Instead of this approach, a single canister was designed that contains the various media in appropriate proportions and sequence (See Figure 4.4-1). As many as six canisters are installed in series (See Figure 4.4-2). When the influent canister breaks through, it is removed and the remaining beds moved up in position. A new bed is installed at the effluent end of the chain. The actual repositioning of the canisters is accomplished with valving. This approach is termed the "unibed" concept and achieves the Space Station goal of commonality by using a single bed that contains all of the necessary sorbent media in optimum proportions.

The type, amount and sequence of sorption media used in the first experimental unibed canisters are summarized in

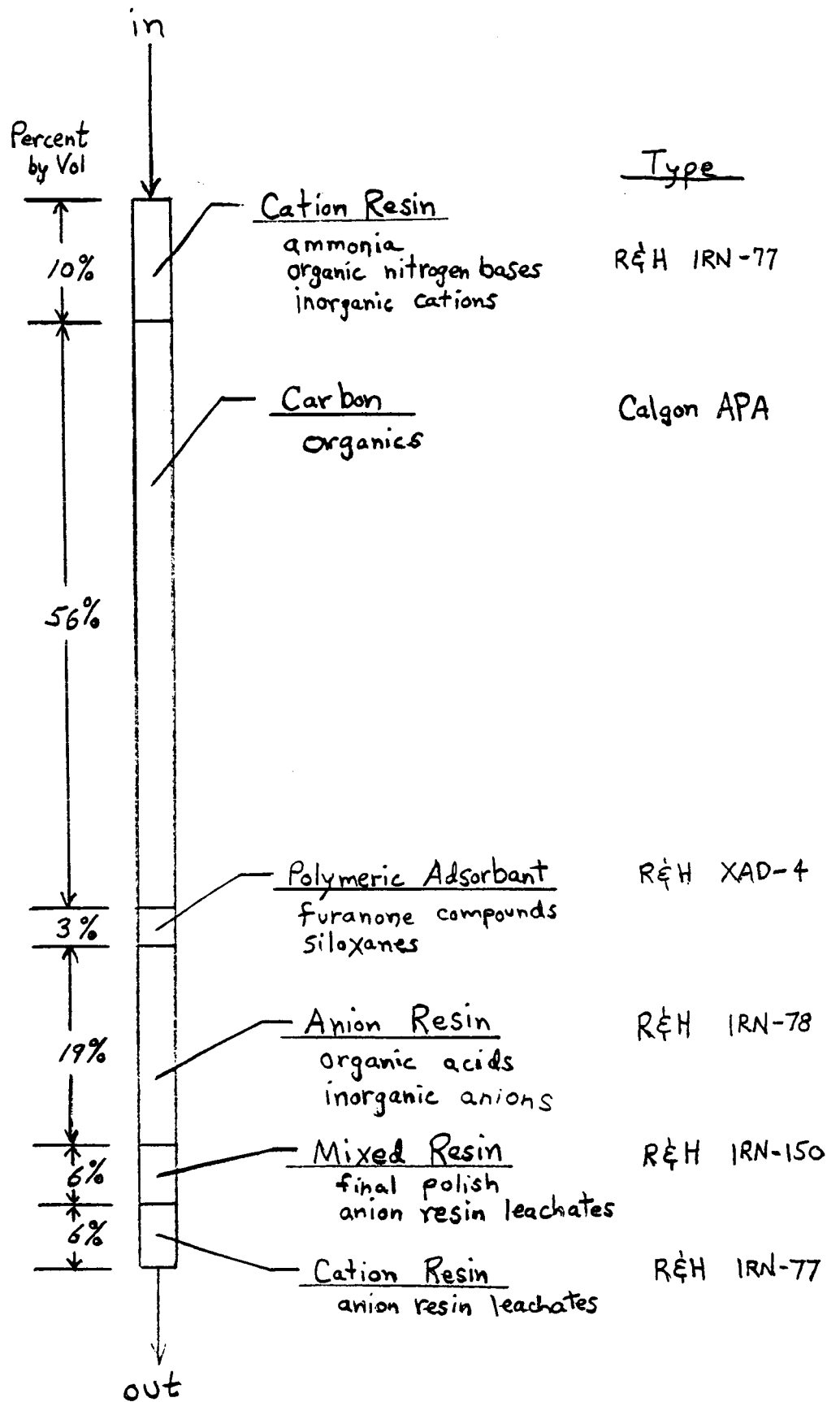
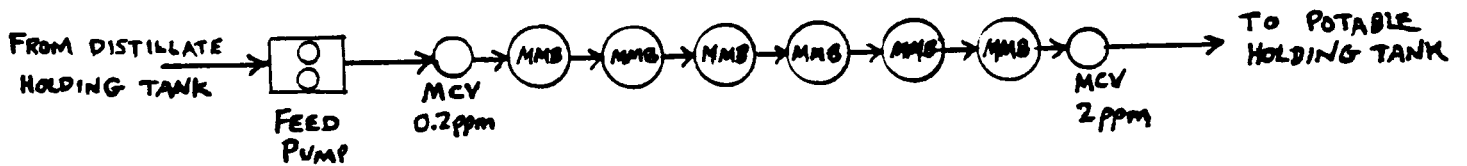

Figure 4.4-1 POST-FILTRATION BED

FIGURE 4.4-2

MULTIFILTRATION UNIT SCHEMATIC



NOTE:

MCV = MICROBIAL CHECK VALVE

MMB = MULTI-MEDIA BED

Table 4.4-1 together with performance data. The unibed canisters were constructed with glass tubing. Individual beds were held in place by glass wool. Sample ports were provided between individual beds. Selection of the types of media and the sequence of beds was based on the following rationale. It was felt that ammonia should be removed first as it tends to raise pH and removing it lowers the pH. Ionic organic compounds are more strongly adsorbed by carbon at lower values of pH. Also, the presence of ammonia in solution dramatically increases the solubility of many organic compounds. Thus cation resin is placed first to remove primarily ammonia, but also organic nitrogen bases and inorganic cations. A carbon bed was placed next in line to remove organics. This was followed by polymeric adsorbent to remove furanone compounds, siloxanes and perhaps some as yet unknown organics. An anion resin bed was placed next to remove organic acids and inorganic anions. This was followed by a mixed cation and anion resin bed for final polishing and to remove anion resin leachates. The final bed is cation resin to remove anion resin leachates. The beds were sized from published loading data. They were sized for distillate from HDAB treated urine, which contains very little methanol, ethanol and acetonitrile. These compounds have all been found in distillate from Oxone treated urine and are not readily removed by the beds in this design.

TABLE 4.4-1

COMPOSITION AND PERFORMANCE OF THE FIRST EXPERIMENTAL UNIBEDS.

Second Unibed in Series
Throughput = 8.4 liters
= 154 bed volumes

First Unibed in Series
Throughput = 18.5 liters
= 322 bed volumes

Flow Sequence ↓ Bed	Number	Media	Supplier Type	Bed Diameter cm	Bed Length cm	Bed Volume ml	Bed Met Wt g	Face Velocity cm/min	Flow @ 1 ml/min	Approximate Concentration of TOC Removed at Feed TOC = 7.5 mg/l mg/l	Bed Loading mg TOC/g	Bed Loading mg NH ₃ /g	Approximate Concentration of TOC Removed at Feed TOC = 1.25 mg/l mg/l
1		Strong Acid Cation Resin	Rohm & Haas IRN-77	0.5	29	5.8	5.1	5	5	2.0	4.7	5.1	—
2		Activated Carbon	Calgon APA	0.8	59.5	29.8	11.9	2	2	2.0	2.9	0	—
3		Polymeric Adsorbent	Rohm & Haas XAD-4	0.5	11	2.2	1.9	5	5	0.25	2.6	0	—
4		Strong Base Anion Resin	Rohm & Haas IRN-78	0.8	20	10.0	5.1	2	2	0.75	3.6	0	—
5		Strong Acid Strong Base Mixed Resin	Rohm & Haas IRN-150	0.5	17	3.4	3.5	5	5	0.75	2.5	0	—
6		Strong Acid Cation Resin	Rohm & Haas IRN-77	0.5	32	3.2	2.8	5	5	0.25	1.4	0	—
TOTAL:					168.5	54.4	30.3			6.25	1.05		1.05
							Remaining TOC:			1.25			.20

Two identical unibeds were challenged in series. Total throughput of the first unibed was 17.5 liters or 322 bed volumes. After passing through the first unibed, 8.4 liters or 154 bed volumes were then passed through the second unibed. The remaining water ($17.5 \text{ l} - 8.4 \text{ l} = 9.1 \text{ l}$) was used for analysis. Neither unibed experienced breakthrough as a whole, so ultimate life has yet to be determined. However, based on individual bed performance, it was decided that the first cation bed, the polymeric bed and the anion bed should all be doubled in size.

The basic performance data, including bed loadings, are presented in Table 4.4-1. The change in TOC as distillate proceeds through a unibed as shown in Figure 4.4-3. The change in pH is shown in Figure 4.4-4 and the change in conductivity is shown in Figure 4.4-5. All detectable ammonia was removed in the first cation bed.

The tests have demonstrated that the unibed concept is promising and that reasonably low expendable rates are probably attainable, at least down to an organic carbon level of 0.2 ppm. Ultimate life has not yet been established. Also, performance below 0.2 ppm has not yet been investigated. These questions, together with the evaluation of other sorption media and the consideration of humidity condensate, wash water distillate and raw wash water are being investigated in current programs.

The data for the first bed pass through is summarized below in Tables 4.4-1 through 4.4-4 and Figures 4.4-3 through 4.4-5, for the second bed pass through in Table 4.4-1 and Figure 4.4-6.

TABLE 4.4-2. TOC LEVELS IN POST-FILTRATION TEST BEDS (SINGLE PASS)

(milligrams per liter)

ITEM	AMT g	BED* EXIT STA#	- THRUPUT, ML -																	
			350	2500	3600	5800	7000	8000	8700	8900	9400	9900	11,900	12,200	13,700	14,200	15,600	16,000	17,500	
RAW DIST	-	0	7.6	7.6	7.6	7.6	7.6	7.6	7.6	7.6	7.6	4.7	3.7	6.0	8.0	8.0	4.8	4.8	4.8	6.2
CATION	5.1	1	3.4	5.8	5.3	5.5							3.6	6.3	5.3					4.2
CARBON	11.9	2	1.6	2.4	4.3	3.4							2.0	4.0	2.8					3.0
POLYMERIC	1.9	3	2.5	2.9	4.6	2.6							2.7	3.4	2.5					2.5
ANION	5.1	4	2.5	0.9	2.4	2.6							1.4	2.9	3.2					2.7
MIXED	3.5	5	6.9	1.6	1.0	1.9							1.4	2.0	2.0					1.5
CATION	2.8	6	1.5	1.4	0.8	1.6	1.7	1.4	1.4	1.4	0.8			1.2	1.1	2.0	1.5	2.0	2.0	1.2

TOTAL: 30.3

COMPOSITE SAMPLE #6: 1.9 1.8 1.8 1.8 2.0 1.4 1.5 0.5 0.5 1.2 2.0 1.5 1.2 2.2 1.2

*See Figure 4.9-1 for Location of Sample Stations

Figure 4.4-3A

ORGANIC REMOVAL FROM URINE DISTILLATE
BY MULTI-MEDIA ADSORPTION BED. (Single Pass)

CATION	5.8	5.1
CARBON	29.8	11.9
POLYMERIC	2.2	1.9
ANION	3.8	3.1
MIXED	3.4	3.5
CATION	3.2	2.8
TOTAL	50.2	30.3

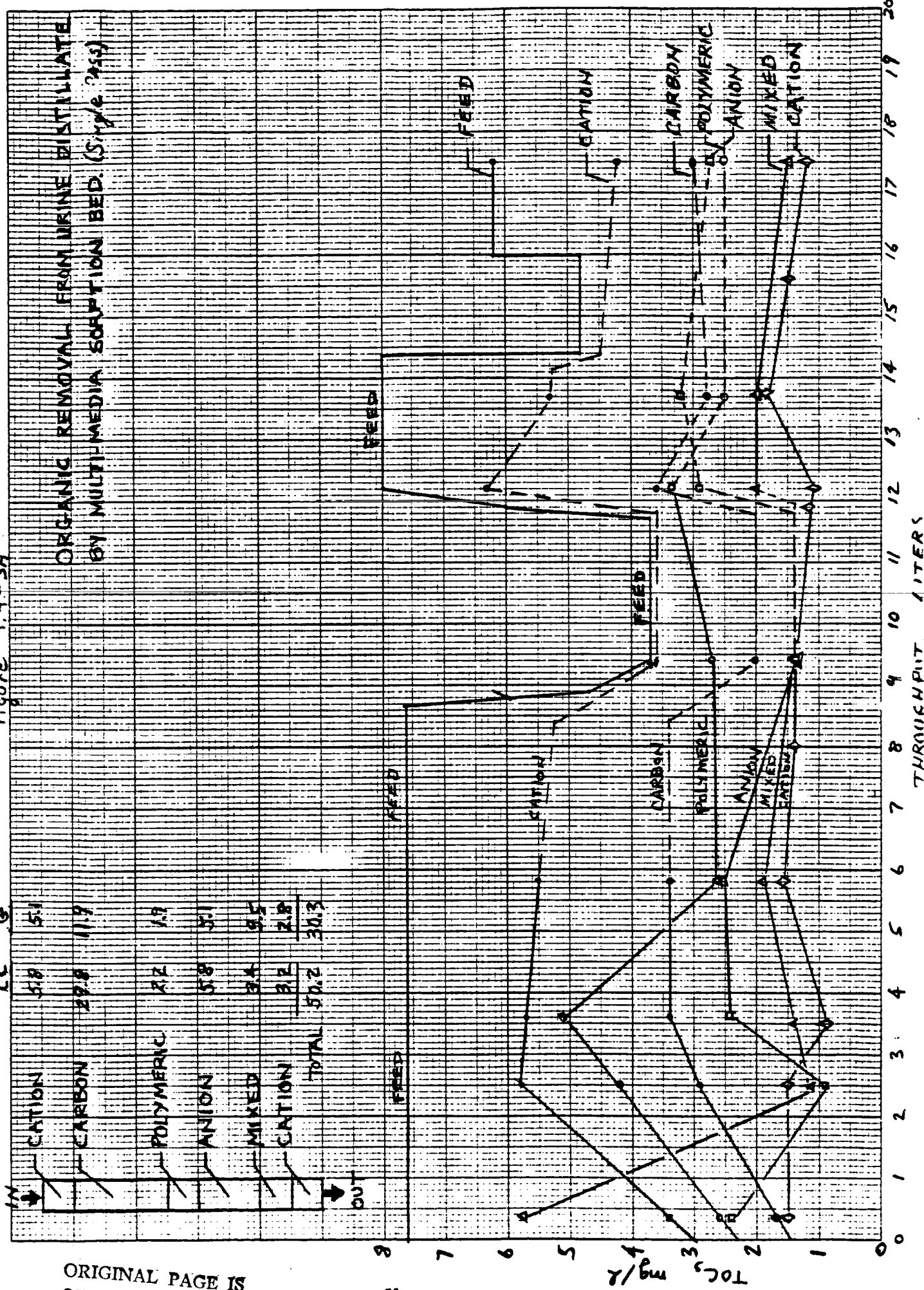

ORIGINAL PAGE IS
OF POOR QUALITY

FIGURE 4.4-3A

FIGURE 4.4-3B

ORIGINAL PAGE IS
OF POOR QUALITY

UNIBED PERFORMANCE

TOC VERSUS LENGTH (SINGLE PASS)

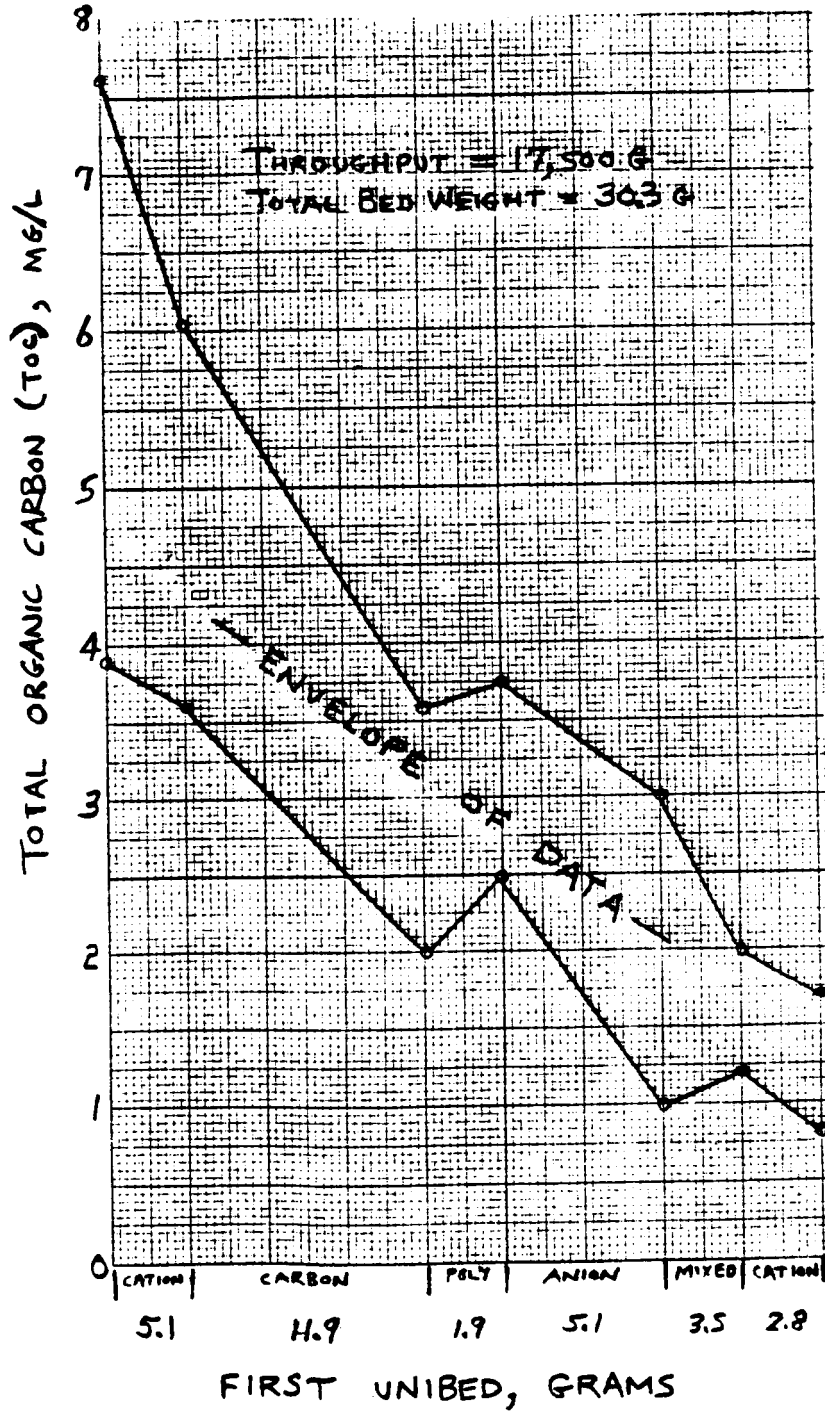
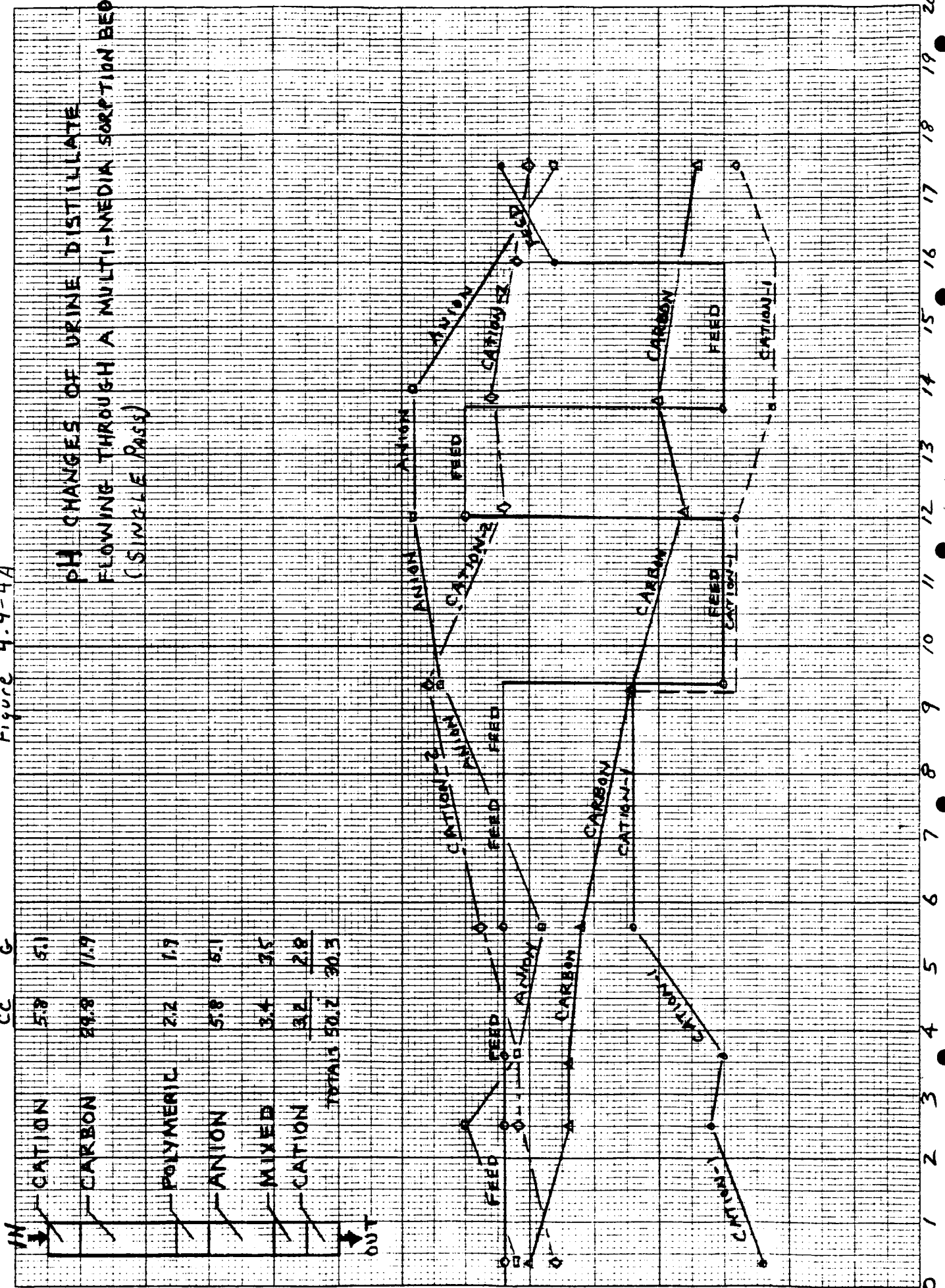

TABLE 4.4-3. pH VALUES - SORPTION BED TESTS (SINGLE PASS)

	Sta* #	350	2500	3600	5800	9400	10,400	12,000	13,700	16,000	17,500
Raw Dist.	0	6.2	6.2	6.2	6.2	4.5	4.5	6.5	4.0	5.8	6.2
Cation	1	4.2	4.6	4.5	5.2	5.2	5.2	4.4	4.1		4.4
Carbon	2	6.0	5.7	5.7	5.6	5.2	5.2	4.8	5.0		4.7
Polymeric	3	6.0	6.0	6.1	5.6	5.1	5.1	4.9	4.9		4.9
Anion	4	6.1	6.5	6.2	5.9	6.7	6.7	6.9	6.9		5.8
Mixed	5	6.1	6.2	6.2	5.9	6.5	6.5	6.4	6.5		6.2
Cation	6	5.8	6.2	6.2	6.4	6.8	6.8	6.2	6.3	6.1	6.0
Composite		5.9	6.1	6.4	5.8	6.7	6.4	6.0	6.6	6.3	5.5

*See Figure 4.9-1 for Location of Sample Stations.

Figure 4.4-4A



ORIGINAL PAGE IS
OF POOR QUALITY.

FIGURE 4.4-4B

UNIBED PERFORMANCE
pH VERSUS LENGTH

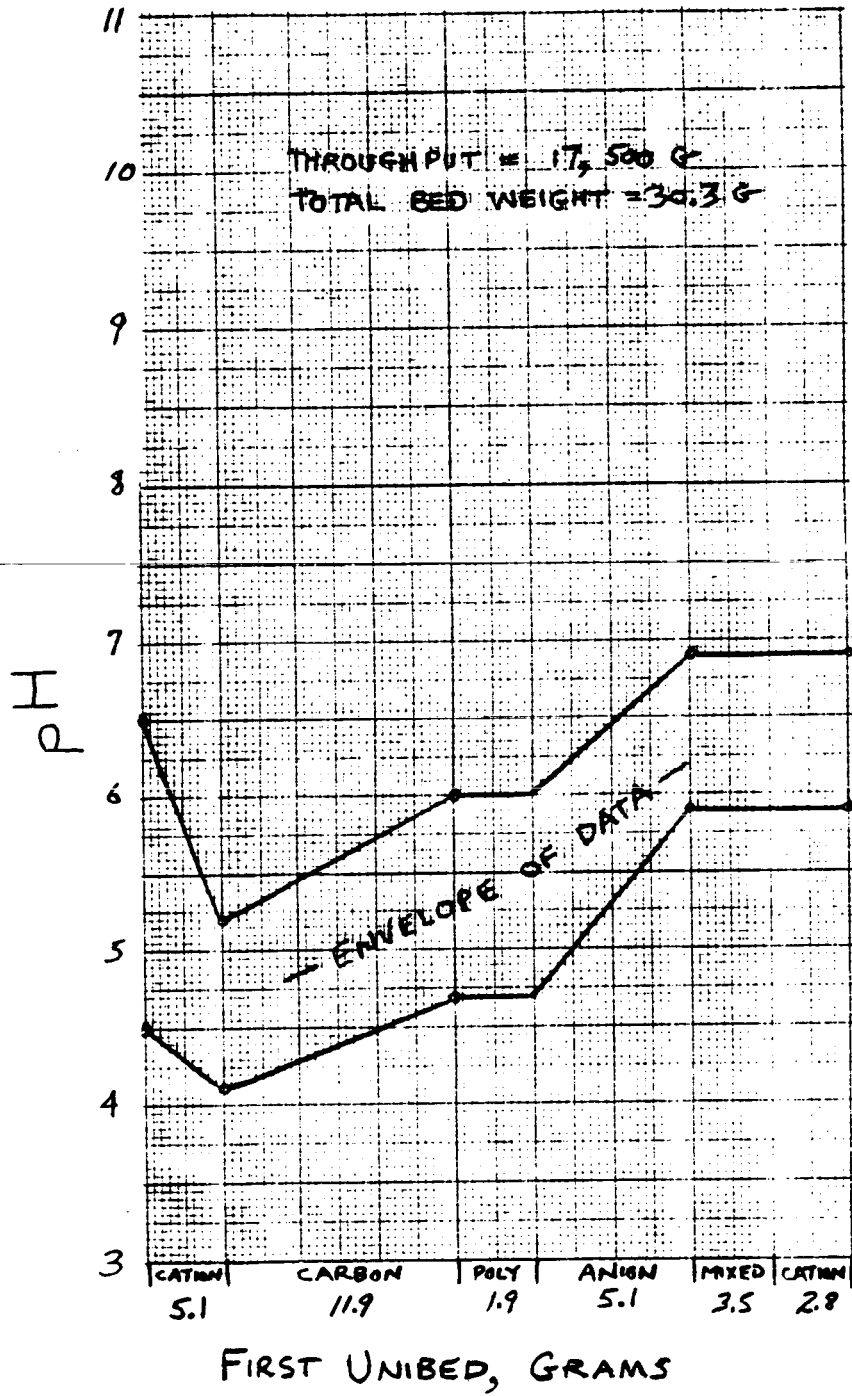

ORIGINAL PAGE IS
OF POOR QUALITY

TABLE 4.4-4. CONDUCTIVITY LEVELS IN POST-FILTRATION TEST BEDS
(SINGLE PASS) (micromho-cm⁻¹)

BED* EXIT STA#	- THRU PUT, ML -													
	<u>350</u>	<u>2500</u>	<u>3600</u>	<u>5800</u>	<u>7000</u>	<u>8000</u>	<u>8700</u>	<u>8900</u>	<u>9400</u>	<u>10,400</u>	<u>12,000</u>	<u>13,700</u>	<u>16,000</u>	<u>17,500</u>
0	18								15	10	66	66	17	17
1	-	24	27	24		20		5.8			15.7	36		36
2	1.9	2.2	3.3	3.6				5.9			12.2	7.5		12.2
3	2.2	3.4	1.9	2.6				4.6			13.0	9.9		11.5
4	2.3	0.8	1.9	3.1				0.9			1.4	1.7		1.4
5	1.1	0.7	0.6	0.9				0.9			0.8	0.7		0.8
6	0.4	0.8	0.7	0.5	1.3	1.5	1.0	0.9	0.9	0.6	0.6	0.6	0.8	0.9

*See Figure 4.9-1 for Location of Sample Stations

ORIGINAL PAGE IS
OF POOR QUALITY

Figure 4.4-5A

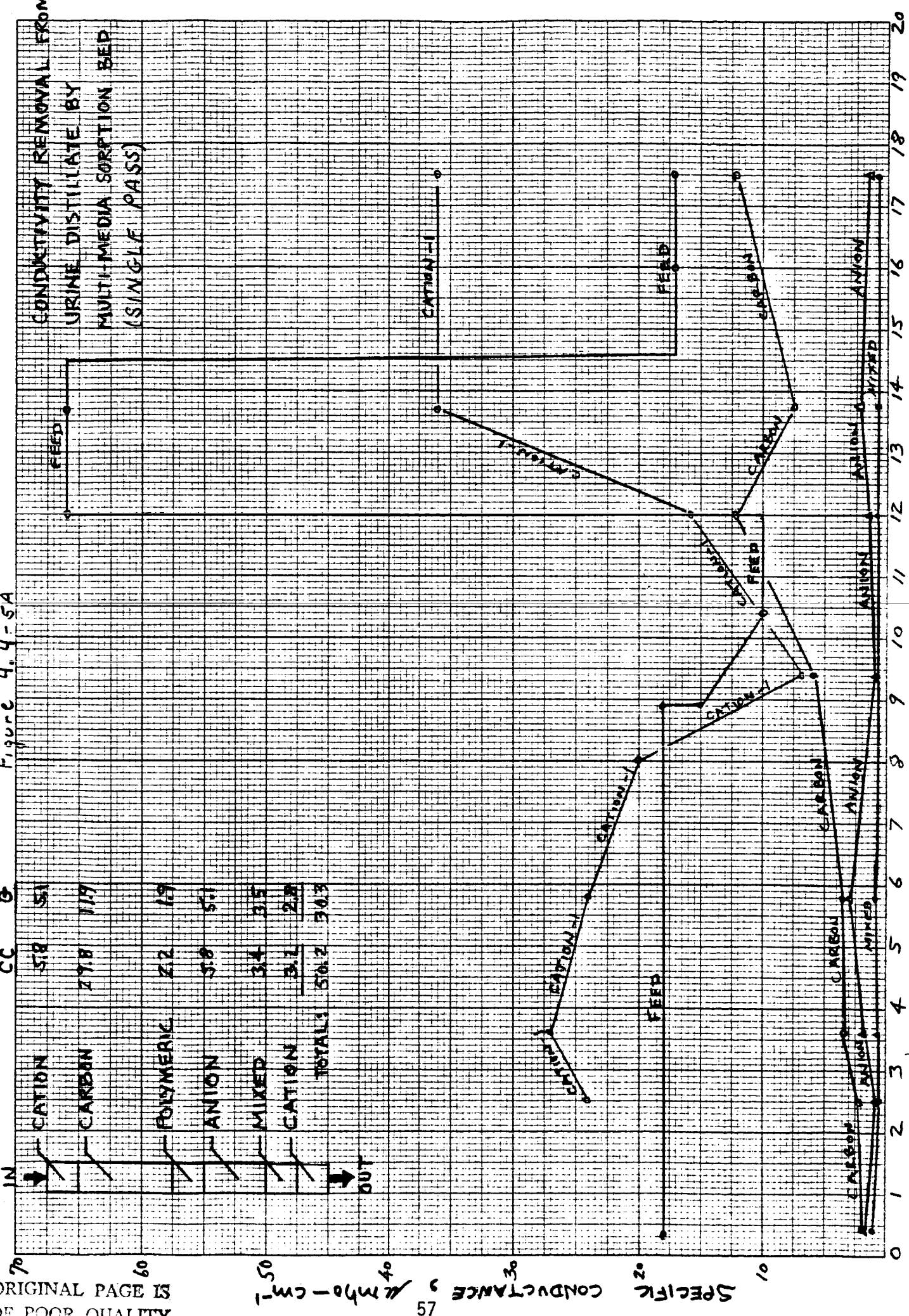

CONDUCTIVITY REMOVAL FROM
URINE DISTILLATE BY
MULTI-MEDIA SORPTION BED
(SINGLE PASS)

THRU PUT LITERS

SPECIFIC CONDUCTANCE, cmho-cm

FIGURE 4.4-5B

UNIBED PERFORMANCE,
CONDUCTIVITY VERSUS LENGTH
(SINGLE PASS)

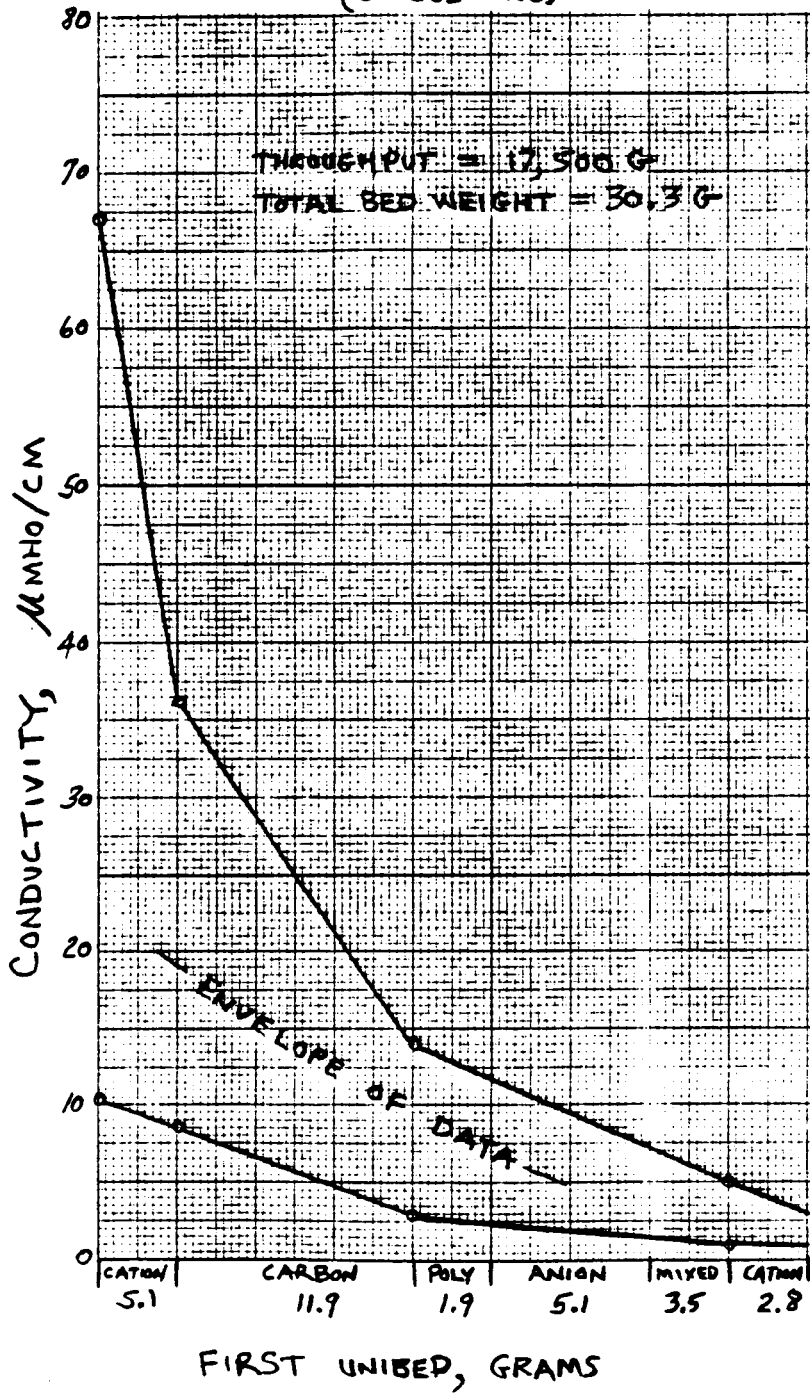

ORIGINAL PAGE IS
OF POOR QUALITY

First Cation Bed.

This bed (See Figure 4.4-3A) removed about 1 mg/l of TOC from the feed stream that contained 6 to 8 mg/l of TOC. The bed removed essentially no TOC from the feed stream that contained 3 to 4 mg/l. Apparently, whatever organics the cation bed removes were absent in this particular feed, which consisted of the first cuts of distillate from the HDAB treatment. The feed from 12 to 14 liters was derived from HDAB treated urine from later cuts, at higher feed concentrations, and the organics in question are back. The feed after 14 1/2 liters was switched back to the metals treated urine. (As an aside note, the TOC of the metals treated urine decreased with time even though the pooled sample was kept refrigerated.) The amount of organics removed in the 14 to 16 liter range is only an approximation. The last point at 17 1/2 liters shows 2 mg/l removal, about the same as in the beginning (2 to 9 liter range). It is interesting to note that in the case of the metals treated urine the specific conductance increases as TOC is removed by the first cation bed.

Because the final cation bed removes some organics throughout the test, it is felt that some organics that could be taken out by the first bed may be getting through

and that the size of the first cation bed should be increased. Note that the first cation bed removed all NH_3 satisfactorily throughout the test.

Carbon Bed.

The carbon bed (See Figure 4.4-3A) removed between 1 and 3 mg/l of TOC throughout the test. It seemed to remove more at the beginning than at the end. The gradual increase in specific conductance leaving the carbon bed appears to indicate that the bed gradually becomes loaded with organic acids, removing fewer and fewer of them. This behavior, called "instantaneous breakthrough", is normal for organic acids being adsorbed on carbon. The unremoved organic acids appear to be removed by the anion resins downstream. The final TOC output from the full series of beds remained essentially in the range 1 to 1 1/2 mg/l throughout the test. These data indicate that an increase in the amount of carbon does not appear to be necessary.

Polymeric Bed.

The polymeric bed (See Figure 4.4-3A) was apparently not sufficiently washed out prior to the start of the test. Up until 5 liters of throughput, it added TOC which was, however, taken out by the downstream beds. The polymeric bed appears to have sorbed about 1 mg/l of TOC between 6 and 9 liters and about 1/2 mg/l of TIC between 12 and 17 1/2 liters. It appears that the polymeric adsorbent is doing

something and should be increased in amount.

Anion Bed.

The anion bed (See Figure 4.4-3A) removed 2 to 3 mg/l of TOC for essentially the first 12 liters of throughput. After the 12 liter mark the mixed bed removed more organic material than previously, indicating that the anion resin in the mixed bed was picking up what the anion bed could no longer sorb. It appears that the size of the anion bed should be doubled.

Mixed Bed.

The mixed bed (See Figure 4.4-3A) apparently was not sufficiently washed down at the start of the test. It removed from about 1/2 to 1 mg/l of TOC between 3 and 9 liters, none from 9 to 12 liters (during low TOC feed), and from 1 to 1 1/2 mg/l from 12 to 17 1/2 liters. It appears that the size of the mixed bed is all right. Theoretically, a mixed bed should not be needed if the preceding cation and anion beds are sized right, do not leach or do not have certain organics kicked off due to a change in feed composition. The mixed bed is there for backup.

Final Cation Bed.

The main purpose of the final cation bed (See Figure 4.4-3A) is to pick up possible leachate from the anion resin in the mixed bed. It is also there for final polishing. The bed appeared to remove about 1/4 to 1/2 mg/l of TOC

throughout most of the test. It appears to be sufficiently large.

A summary of the TOC removal data is presented in Table 4.4-5. The beds consistently removed TOC down to the 1 to 2 ppm range, and each bed made some contribution.

TABLE 4.4-5. SUMMARY OF APPROXIMATE AMOUNTS OF TOC REMOVED BY SORPTION BEDS IN ONE PASS AT 2 CM/MIN FEED.

<u>BED DESCRIPTION</u>	<u>Approximate Amount of TOC Removed mg/l</u>
#1 Cation	2
Carbon	2
Polymeric	1/2
Anion	3/4
Mixed	3/4
#2 Cation	<u>1/4</u>
TOTAL REMOVED	6 1/4
Unremoved TOC	<u>1 1/4</u>
FEED	7 1/2

A summary of the actual bed loadings compared to the estimated loadings is presented in Table 4.4-6.

Breakthrough appears to have occurred in the first cation bed, the polymeric bed and the anion bed. Breakthrough may be occurring in other beds as well, but not at a detectable level.

The effluent from this test, which was not used for sampling (about 8 1/4 liters), was pooled and saved in a refrigerated container. A fresh set of beds were prepared,

rinsed with deionated water, and challenged with this composite. These results are presented in Figure 4.4-6. The TOC was further reduced to well under 1 ppm.

**TABLE 4.4-6. SUMMARY OF BED LOADINGS AFTER PROCESSING
17 1/2 LITERS OF URINE DISTILLATE**

<u>Bed Description</u>	<u>Estimated Loadings mg TOC/g material</u>	<u>Actual Accum. Loadings mg TOC/g material</u>	<u>Breakthrough</u>
#1 Cation	25 (NH ₃)	5.1 (NH ₃)	No
	0	4.7	Probably
Carbon			
10 to 1 ppm	150	2.9	No
1000 to 50 ppb	50		?
50 to 10 ppb	10		?
10 to 1 ppb	1		?
Polymeric	50	2.6	Possibly
Anion	52	3.6	Yes
Mixed	50	2.5	No
#2 Cation	50	1.4	No

Testing at this level is very difficult, not just because the TOC analyzer is operating at its lower detection limit, but also because of inadvertent contamination of samples during collection both from solvent vapors present in the lab atmosphere and insufficiently clean sample containers. Sample cuts taken directly from the test rig and analyzed immediately generally have lower TOC's than samples taken from the collection jugs, as can be seen in Figure 4.4-6A.

Figure 4.4-6A

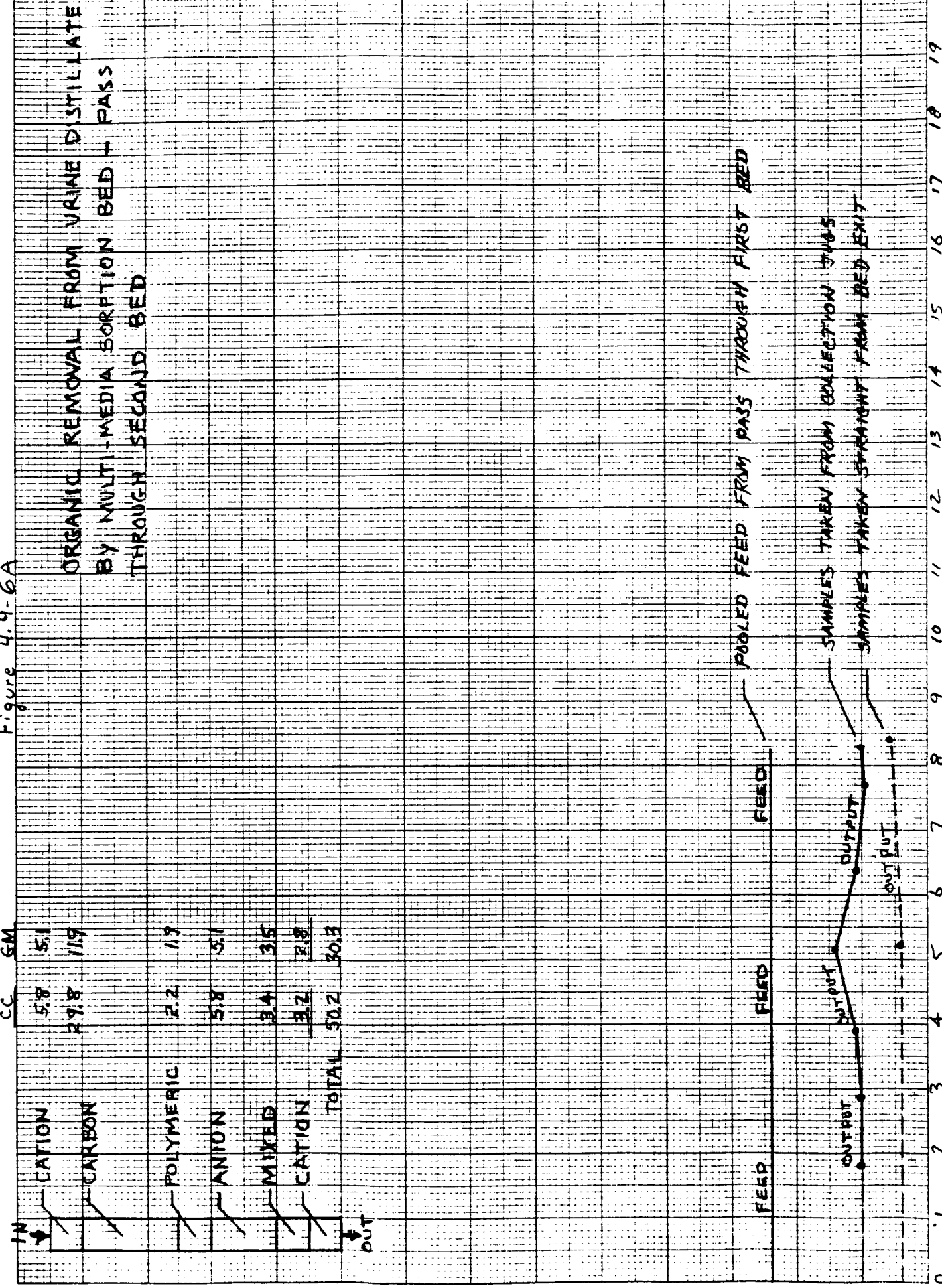

ORIGINAL PAGE IS
OF POOR QUALITY

FIGURE 4.4-6B

ORIGINAL PAGE IS
OF POOR QUALITY

UNIBED PERFORMANCE TOC VERSUS LENGTH (SECOND PASS)

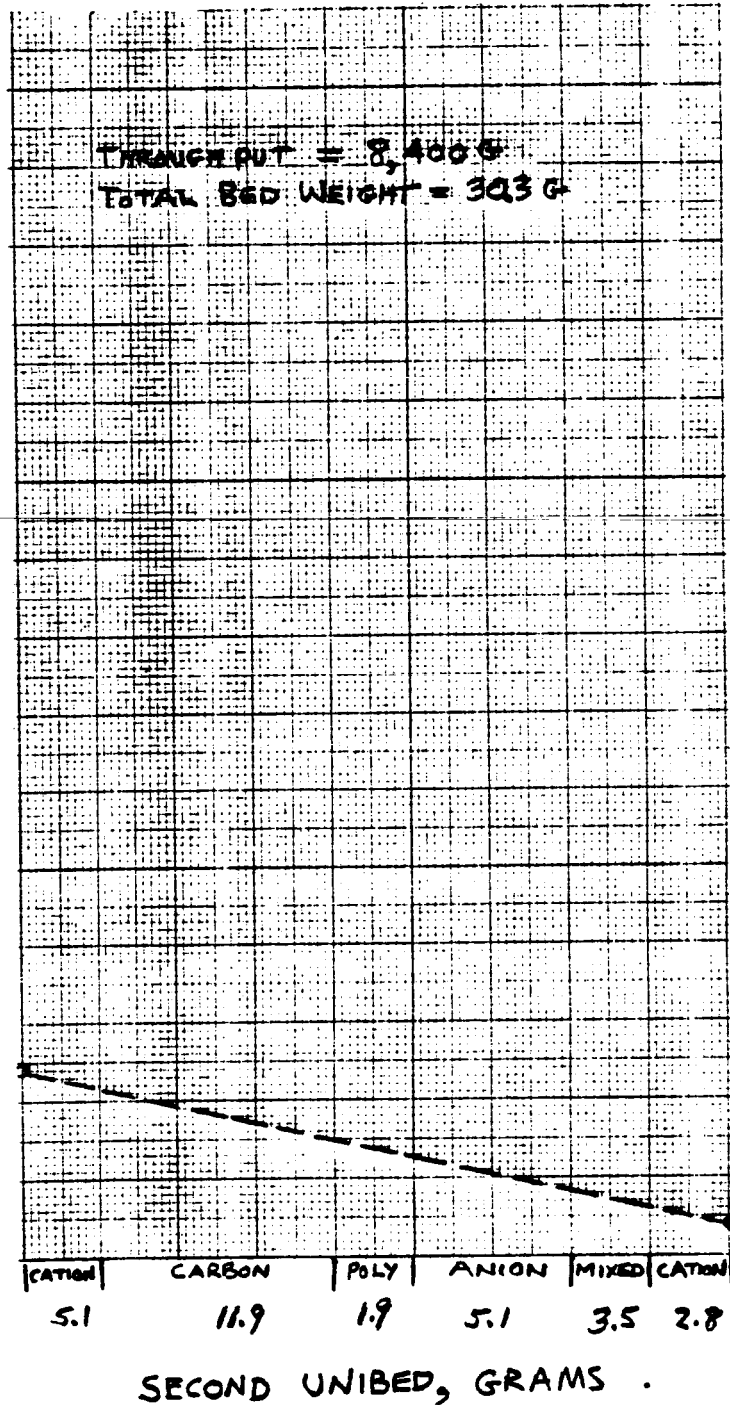

4.5 Post Treatment by Reverse Osmosis.

Certain reverse osmosis membranes can reject organic as well as inorganic molecules, although in general, organic molecules are often not rejected at as high a rejection rate as are inorganic molecules. Bend Research, Inc. has unique expertise with such membranes, and in addition has developed a hollow-fiber membrane in which the flow is radially outward rather than inward as is the case with other hollow-fiber membranes. This unique feature enables a controlled velocity inside the tubes, which produces higher fluxes and less fouling, thus leading to more compact designs and longer useful lifetimes for the reverse osmosis modules that incorporate these hollow fibers.

Samples of urine distillate were sent to Bend Research for membrane challenge tests to ascertain if there are promising membranes that can reject the organics contained in urine distillate.

The results are presented in Table 4.5-1 below. Column 1 shows the urine distillate as provided by URC. Column 2 shows the urine distillate after being loaded into the Bend Research test loop. Note the increase in TOC, Na, Ca and K, indicating a less than 100% pure loop, even after vigorous cleaning. This is not untypical. Note also that the NH_3 level decreased slightly, perhaps being sorbed by materials in the loop.

The FT-30 membranes, A, B and C were evaluated and all

performed similarly and did a good job of rejecting organics as well as the inorganics that were present. Membrane NS-100 did not do so well and will be dropped for further consideration in this application.

TABLE 4.5-1. POST TREATMENT RESULTS FOR REVERSE OSMOSIS OF URINE DISTILLATE.

Parameter	Urine Distillate from URC	Urine Distillate from RO loop at start of Test	Membrane	Membrane	Membrane	Membrane
			FT-30	FT-30	FT-30	NS-100
			A	B	C	
pH, pH units	6.7	6.9	6.4	6.3	6.4	6.9
Sp Cond $\mu\text{mho-cm}^{-1}$	57	54	2.3	2.8	2.8	11.5
NH ₃ -N, mg/l	7.9	6.2	0.23	0.25	0.30	1.7
TOC, mg/l	9.3	14.2	1.0	1.1	0.8	3.7
Na, mg/l	0.65	3.05	0.48	0.46	0.42	0.30
Ca, mg/l	0.14	0.37	0.13	0.31	0.17	0.22
K, mg/l	0.35	0.51	0.04	0.06	0.05	0.06
Cl ⁻ , mg/l	ND@1	ND@1	ND@1	ND@1	ND@1	ND@1

4.6 Post Treatment by Oxidation.

Various chemical oxidants were mentioned in the literature as being effective in removing some organics from drinking water. This same mechanism, however, is utilized during ozonation, a relatively more efficient process than chemical oxidation. Therefore, the only likely application of chemical oxidation is for waste water pretreatment as discussed in paragraph 4.1.

Ozone, especially in combination with UV light, has been shown to be a powerful oxidizing agent for treatment of organics, metals, etc. Its potential contribution to waste

water post treatment was felt to be significant.

It was recommended that some tests be run at Umpqua Research to ascertain the effectiveness of vapor phase ozonation, as this approach could theoretically be more easily incorporated into an existing distillation system than could a liquid phase ozonator.

4.6.1 Vapor Phase Ozonation Tests. A test was run in which ozonated air was introduced to the vapor phase during distillation. The ozonator used is claimed not to produce oxides of nitrogen in the air stream as most other ozonators do. The ozonated distillate did not contain nitrates, which would tend to support this claim. The results are presented in Table 4.6-1. TOC was lowered by about 28%. The pH dropped and the specific conductivity increased, indicating an increase in organic acids along with the drop in TOC.

TABLE 4.6-1. RESULTS OF INTRODUCING OZONATED AIR TO THE VAPOR PHASE DURING DISTILLATION OF HDAB TREATED URINE.

	<u>TOC</u> <u>mg/l</u>	<u>pH</u>	<u>Sp. Conductance</u> <u>$\mu\text{mho-cm}^{-1}$</u>
Without Vapor-Phase Ozonation	11.8	3.9	19
With Vapor-Phase Ozonation	8.5	3.5	52

A second test was prepared in which all of the water vapor was passed over the ozonator tube as shown in Figure 4.6-1. A heating mantle is used to heat a boiling flask

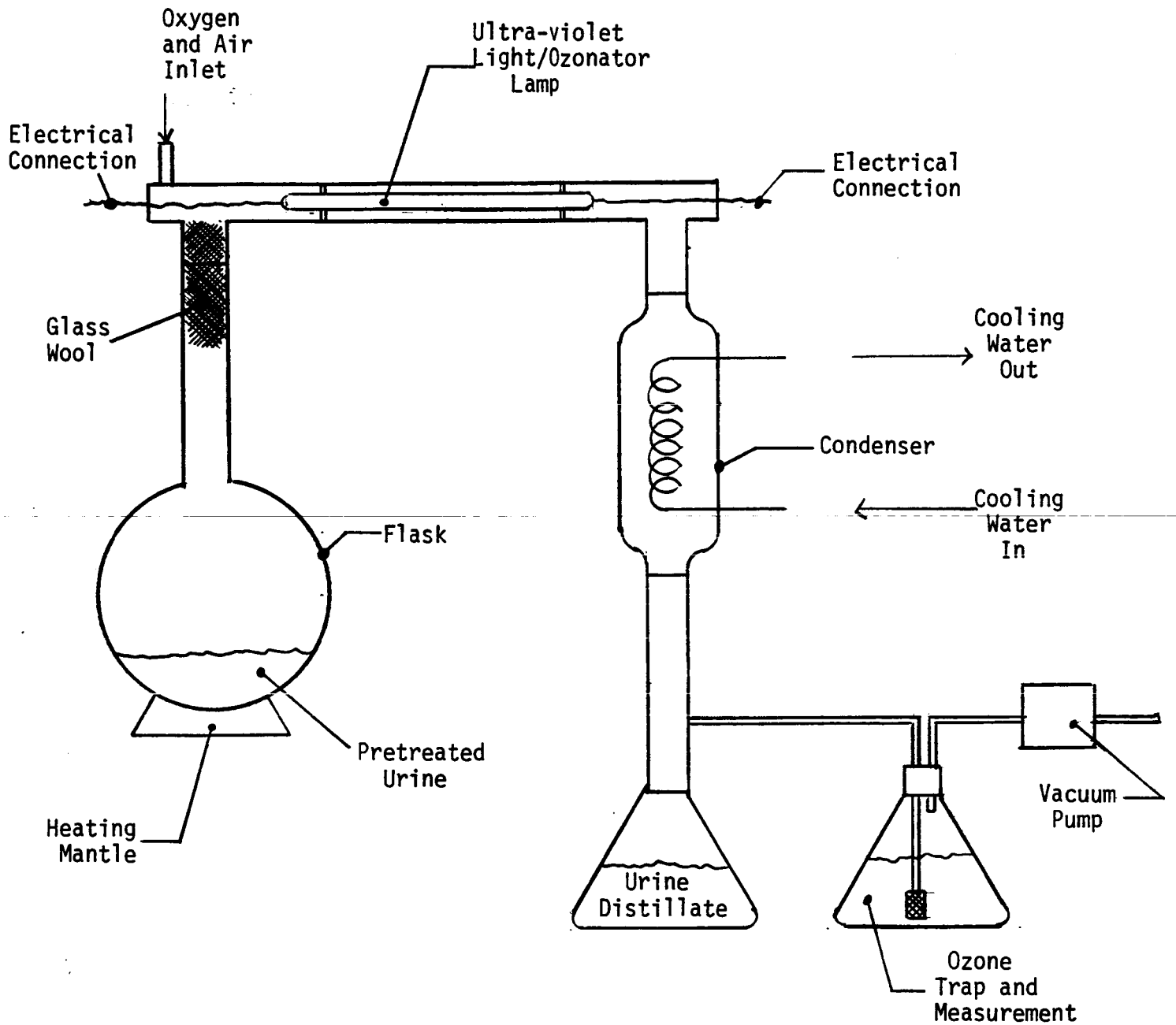
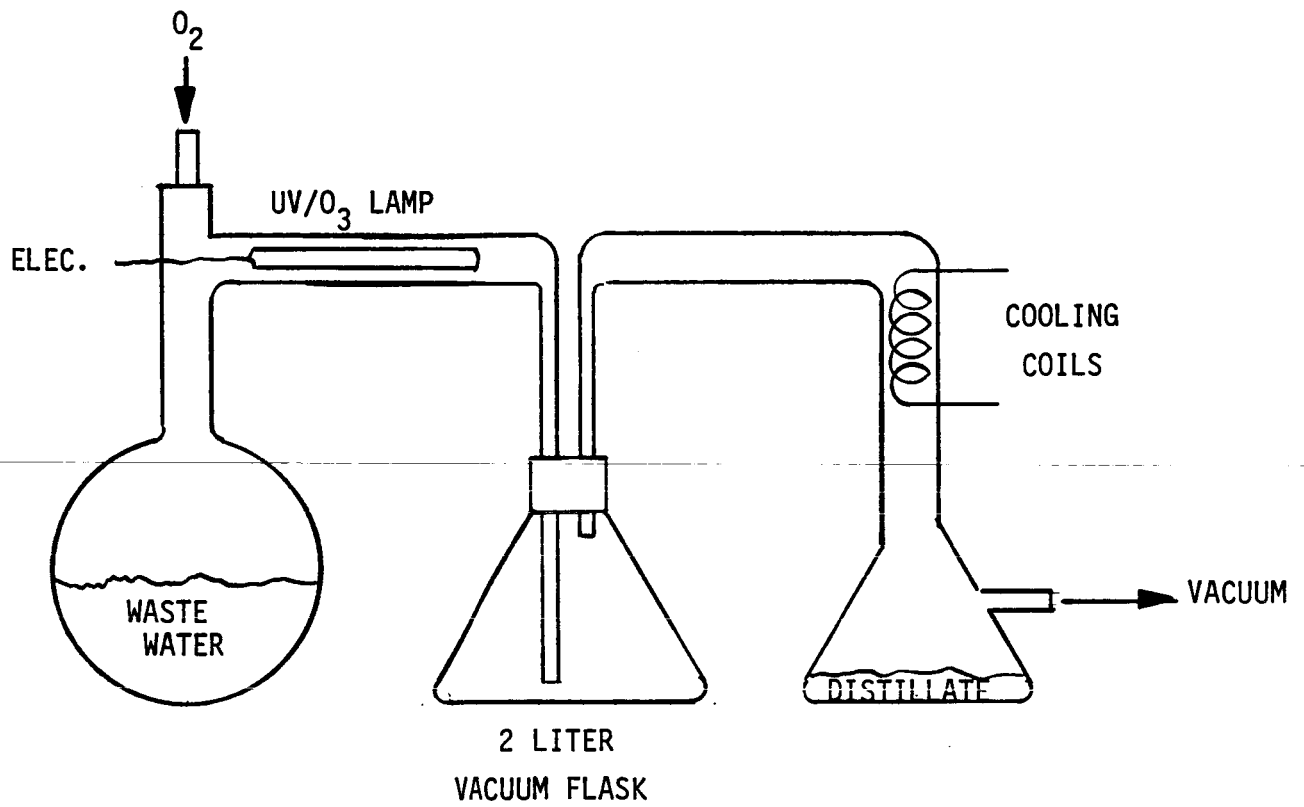

FIGURE 4.6-1
 APPARATUS FOR THE ULTRA-VIOLET
 LIGHT/OZONATION (UV/O₃)
 TREATMENT IN THE VAPOR PHASE
 OF THE DISTILLATION PROCESS

containing pretreated urine, the vapor then passes over an ultra-violet/ozonation lamp to be re-condensed and collected for analysis in a receiving flask. The complete system is under vacuum. The boiling rates of the urine are controlled by the amount of vacuum used on the system and mantle temperature. Excess ozone, if any, is collected in a trap to determine its level.

DESCRIPTION OF PROCEDURE: Numerous operating conditions were evaluated to determine the maximum production and contact time of ozone with the distillation vapor. Figure 4.6-2 depicts the final configuration used in the analysis. This configuration was derived after numerous tests varying the air flow, lamp location, vessel volumes, vacuum changes and heat variations. To provide longer contact time a two liter vacuum flask was added on the down stream side of the boiling flask with the VU/O₃ lamp positioned to flow into the boiling flask, through the vacuum flask into the condensing coils. This configuration proved to provide ample ozone and contact time with the distillation vapor when tested on oxygen and distilled water samples. Bottled oxygen was metered into the system ahead of the VU/O₃ lamp at a rate of 25 ml/min which was found earlier to produce the highest level of ozone concentration. Fresh urine was collected, pooled and pre-treated with a solution of H₂SO₄ and HDAB. The final tests were conducted in the apparatus

FIGURE 4.6-2
VAPOR PHASE OXIDATION
FINAL APPARATUS CONFIGURATION



as described (Figure 4.6-2) with a vacuum of 610 mm Hg and an oxygen flow rate of 25 ml/min, 2 ml of Dow Anti Foam was added to retard foaming. In each case the test was started with a 1 liter urine sample. The distillate was sampled at 150 ml intervals with pH, specific conductance and TOC being analyzed immediately. The finished distilled pools were also tested for their phenol content. The results of the final tests are described below and tabulated in Table 4.6-2.

TABLE 4.6-2. RESULTS OF VAPOR PHASE OZONIZATION TESTS.

#1 Sample distilled without the use of ozonizer.
 #2 and #3 samples distilled with the use of ozonizer.

<u>Sample No.</u>	<u>pH</u>	<u>Sp. Conductance 600 pool average</u>	<u>TOC</u>	<u>Phenol</u>
1	4.5 - 5.0	59.7	43 mg/l	.15 mg/l
2	4.5 - 5.0	48.5	35 mg/l	.11 mg/l
3	4.5 - 5.0	48.0	34 mg/l	.11 mg/l

CONCLUSION: The use of ozone in the vapor phase of urine distribution compared to samples run under the same conditions without ozone yield distillates having 20% less TOC and specific conductance levels, phenols were in the 25% lower levels, and pH's varied little. An appreciable decrease in odor was noted on samples tested with the ozonization process.

4.7 Post Treatment by Air Stripping.

Air stripping has proved to be very effective in

removing trace organics from ground water supplies and as a tertiary treatment in waste water purification systems. Reference (13) lists the organics which were significantly removed by air stripping at Water Factory 21, a waste water treatment plant. These organics, together with their approximate average concentrations and removal percentages are presented in Table 4.7-1.

TABLE 4.7-1. ORGANIC CONTAMINANTS REMOVED TO A SIGNIFICANT DEGREE BY AIR STRIPPING AT WATER FACTORY 21 (See Reference 13)

<u>Contaminant</u>	<u>Concentration ug/l</u>	<u>Percentage Removal</u>
Trihalomethanes	10.4	79
Chlorobenzenes	3.0	96
Tetrachloroethylene	2.5	95
1,1,1-trichloroethane	4.7	91

Reference (13) found that in general, organic compounds that were significantly removed by air stripping had Henry's law constants above approximately 10^{-3} atm m^3/mol .

Cursory tests were conducted to investigate the effectiveness of air stripping for the removal of organic contaminants from urine distillate. TIMES distillate was used in the first test. The next three tests involved successive distillate fractions from a one liter batch of urine treated with sulfuric acid and HDAB then vacuum distilled. Air Stripping was simulated by bubbling nitrogen

at 200 ml/min through 100 ml of distillate for five minutes. The results are presented in Table 4.7-2.

TABLE 4.7-2. REMOVAL OF ORGANICS FROM URINE DISTILLATE BY AIR STRIPPING.

<u>Urine Distillate</u>	<u>Initial TOC mg/l</u>	<u>Final TOC mg/l</u>	<u>% Change in TOC mg/l</u>
TIMES	90	83	-7.8
DISTILLATE PORTIONS FROM 1 LITER URINE BATCH			
0 - 250 ml portion	10	10	0
250 - 500 ml portion	7	6	-14.
500 - 750 ml portion	16	14	-13.
Average for 750 ml	11	10	-9.1

In another test, urine distillate was acidified with HCl to pH = 2, then subjected to the same stripping procedure. Results were not as good as for no pH adjustment.

It was concluded that, due to the low organic removal (less than 10 per cent), air stripping is not a viable post treatment technique for urine distillate.

4.8 Post Treatment by Liquid/Liquid Extraction.

Liquid/Liquid extraction is used in some gas chromatography methods to extract trace organics from water samples. It is also commonly used for industrial waste water treatment.

Cursory tests were conducted using pentane, hexane and iso-octane to extract organics from the same urine distillates that were used in the air stripping tests (See para. 4.7). Twenty milliliters of solvent were used to extract 100 ml of distillate. It was found that the total organic carbon level of the extracted samples increased, presumably due to the incomplete separation of the solvent. Therefore the solvent was purged by bubbling 200 ml/min of nitrogen through the sample for five minutes. The results are presented in Table 4.8-1.

TABLE 4.8-1. REMOVAL OF ORGANICS FROM URINE DISTILLATE BY LIQUID/LIQUID EXTRACTION FOLLOWED BY AIR STRIPPING.

<u>Urine Distillate</u>	<u>Initial TOC mg/l</u>	<u>After Extraction TOC mg/l</u>	<u>After Air Stripping TOC mg/l</u>	<u>Change in TOC %</u>
TIMES(hexane)	90	133	100	+11
PORTIONS FROM 1 LITER BATCH OF URINE				
0 - 250 ml (pentane)	10	29	9	-10.
250 - 500 ml (hexane)	7	16	6	-14.
500 - 750 ml (iso-octane)	16	24	12	-25.
Average for 750 ml	11	23	9	-18.

In another test, urine distillate was acidified with

HCl to pH = 2, then subjected to the same liquid/liquid extraction procedure followed by air stripping. Results were not as good as for no pH adjustment.

It was concluded that, due to the incomplete separation of solvent from the distillate, which would require subsequent air stripping, and the low organic removal (less than 20 per cent), solvent extraction is not a viable post treatment technique for urine distillate.

4.9 Post Treatment Microbial Control.

In the Space Shuttle, fuel cell product water is used for drinking water. The fuel cell water is treated by passing it through the Microbial Check Valve (MCV) (See Reference 9). The MCV contains an iodinated resin bed. This bed imparts approximately 2 ppm of iodine to the water. The 2 ppm iodine residual maintains microbial control. The MCV has also been investigated (See Reference 10) for application to waste waters including: (1) humidity condensate; (2) urine distillate; (3) urine distillate with carryover and (4) wash water processed by reverse osmosis and by flocculation/coagulation. It was concluded that the MCV can process reclaimed waste water streams without significant degradation of the resin as long as the streams do not contain abnormal amounts of contaminants. In the case of malfunctioning systems, excessive stripping of iodine from the bed would be the most damaging effect. This could require premature replacement of the MCV.

NASA has previously tried both chlorine (in the Apollo program) and the silver ions (see Reference 11 and 12) and found them to be deficient for space applications.

Iodinated resin beds were recommended for inclusion in post-treatment subsystems for the purpose of maintaining microbial control. Tests were performed to ascertain the effectiveness of placing iodinated resin in the unibed column to control microbial growth within the column.

A schematic of the sorption-bed test setup is shown in Figure 4.9-1. Plate counts were taken at sample stations 0 through 6. They were taken first with no iodinated resin bed in the system, then with a bed installed at location 0, then at location 2, and finally at location 3. The results are presented in Table 4.9-1. The 2.0 ppm MCV kept the first cation bed free from growth, but failed to prevent growth in the other beds even when placed at locations 2 and 3. The carbon, polymeric resin and anion resin all remove iodine at the design flow velocity (2 cm/min). It is concluded that placing MCV resin between the beds will not maintain microbial control. If it is desired that microbial control be maintained throughout the beds, it can probably be done by including both an MCV and a membrane to stop spores ahead of the beds and pre-sterilizing this assembly at autoclave temperature.

FIGURE 4.9.1

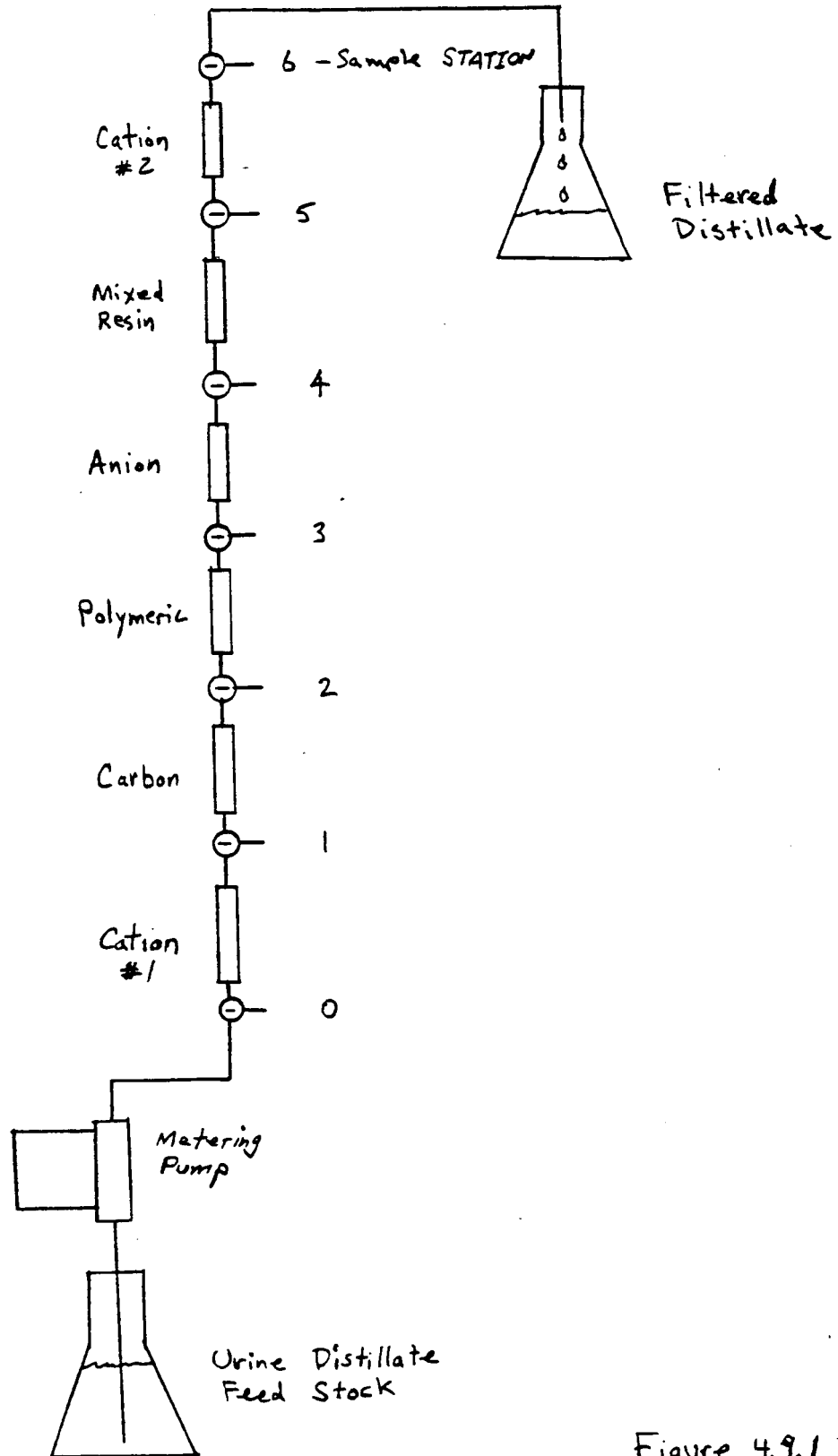

TABLE 4.9-1. AEROBIC PLATE COUNTS FROM SORPTION BEDS
FOR VARIOUS MCV LOCATIONS

<u>Location</u>	<u>No MCV</u>	<u>2.0 ppm MCV at 0</u>	<u>2.0 ppm MCV at 2</u>	<u>2.0 ppm MCV at 3</u>
0	7.7x10 ⁵	0	7.7x10 ⁵	7.7x10 ⁵
1	TNTC	<100	-	-
2	TNTC	7.5x10 ⁴	0	-
3	TNTC	10x10 ⁴	5.5x10 ³	0
4	TNTC	6.5x10 ⁴	2.0x10 ⁴	4.3x10 ⁴
5	TNTC	6.8x10 ⁴	1.0x10 ⁴	2.2x10 ⁴
6	TNTC	7.0x10 ⁴	1.6x10 ⁴	1.0x10 ⁵

4.10 Conceptual Designs and Trade-Offs.

Conceptual designs and estimated weight and power figures are presented for three potential post filtration methods: (1) Multifiltration using multi-media beds, (2) Reverse Osmosis using hollow-fiber membrane modules with tube-side flow (Bend Research), and (3) Ultraviolet catalyzed ozonation (Westgate Research). Schematics of these methods are presented in Figures 4.10-1, 4.10-2, and 4.10-3 respectively. Weight and power estimates are presented in Tables 4.10-1, 4.10-2, and 4.10-3. The design parameters are listed below:

Design Parameters.

Crew Size: 6

<u>Waste Input Model:</u>	<u>Urine</u> <u>lb/day</u>	<u>Flush</u> <u>lb/day</u>	<u>Total</u> <u>lb/day</u>
Water	26.5	16.5	43.0
Solids	<u>1.3</u>	<u>0</u>	<u>1.3</u>
TOTAL	27.8	16.5	44.3

Duty Cycle: 16 hr/day

Processing Rate: 2.69 lb H₂O/hr

<u>Power Penalties.</u>	<u>Sunlit side</u> <u>kg/watt</u>	<u>Darkside</u> <u>kg/watt</u>	<u>Average</u> <u>kg/watt</u>
regulated 115 VAC, 60 HZ	0.159	0.329	0.244

Thermal Rejection Penalty.

thermal rejection to air 0.113

Total Power & Thermal Rejection Penalty.

total (assumes all input energy for
these systems is rejected to air as heat) 0.357

The weights and powers presented in Tables 4.10-1, 4.10-2 and 4.10-3 are best estimates at this time. It should be realized that none of the components except for the MCV, have been developed to flight hardware and are, in fact, in the very early development stages. The three post-treatment methods are summarized in Table 4.10-4.

TABLE 4.10-1 MULTIFILTRATION USING MULTIMEDIA BEDS
(See Figure 4.10-1)

Launched Weight with Scheduled Replacement Items (*) in Place.

<u>Qty</u>	<u>Spares</u>	<u>Component</u>	<u>Unit Wt Kg</u>	<u>Total Wt Kg</u>	<u>Average Power Watts</u>
1		plumbing & fittings	6	6	
1	1	metering pump	1.5	3	10
1		controls	2.5	2.5	10
6		canisters (*)	2	12	
2		MCV (*)	0.5	<u>1</u>	<u> </u>
		TOTALS:		24.5	20

Scheduled Replacement Items:

1 canister per 90 days	=	2 Kg/90 days
2 MCV per 90 days	=	1 Kg/90 days

Summary:

Launch weight	=	<u>24.5</u>
Power & thermal rejection penalty (20 x 0.357)	=	<u>7.1</u>
Total Equivalent Launch Weight	=	31.6
90-day resupply weight	=	3.0

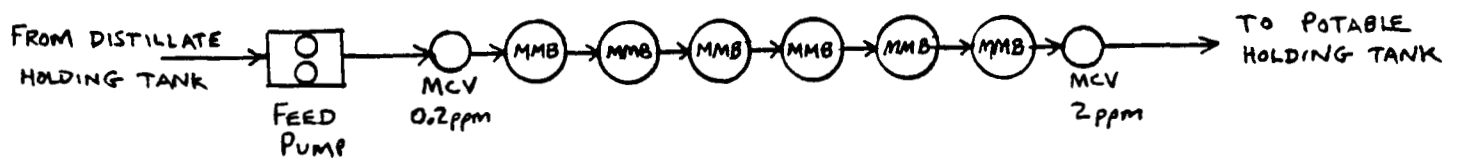

NOTES:

MCV = MICROBIAL CHECK VALVE
 MMB = MULTI-MEDIA BED

FIGURE 4.10-1A

MULTIFILTRATION UNIT

UMPQUA RESEARCH COMPANY CONCEPT

FIGURE 4.10-1B

MULTI-MEDIA BED DESIGN

UMPQUA RESEARCH COMPANY CONCEPT

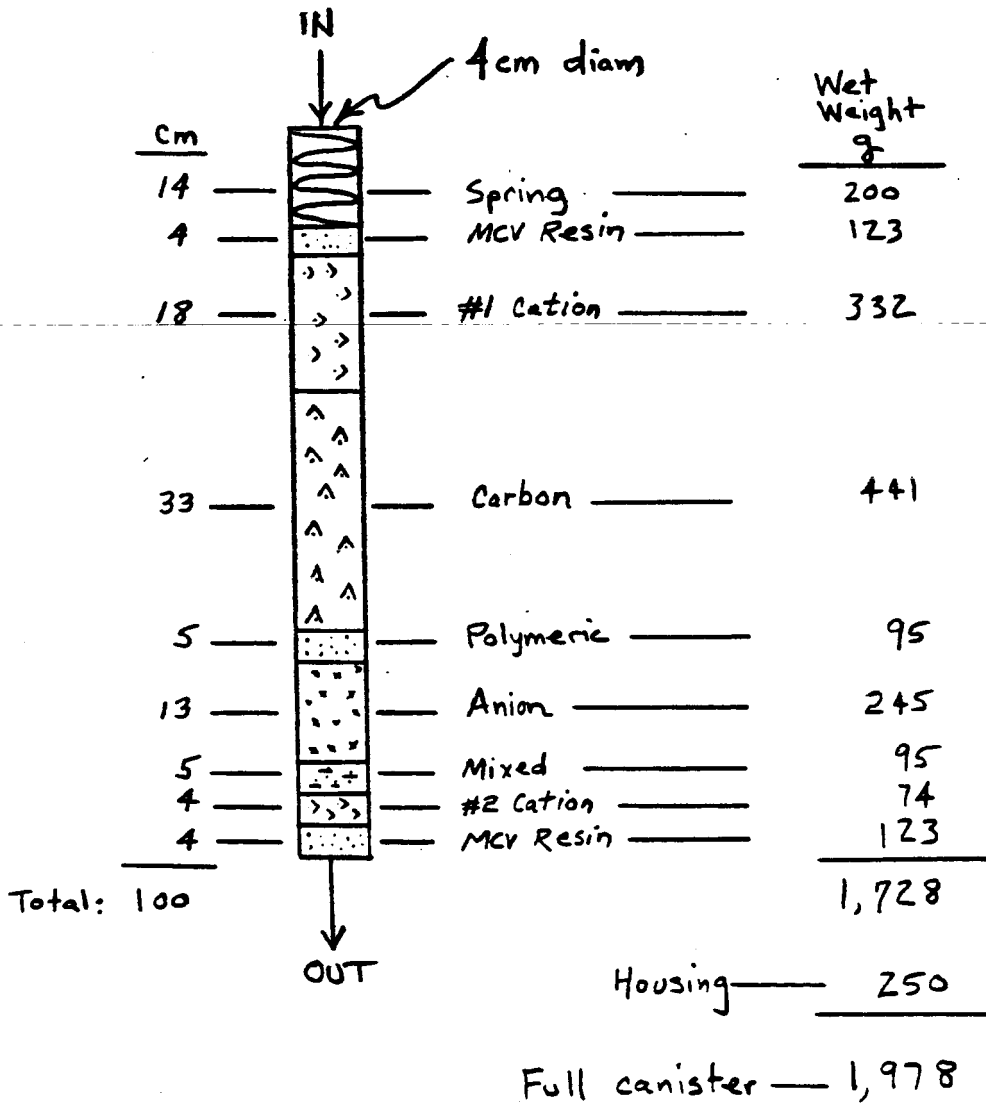

TABLE 4.10-2. REVERSE OSMOSIS USING BEND RESEARCH MODULES

(See Figure 4.10-2)

Launched Weight with Scheduled Replacement Items (*) in Place.

<u>Qty</u>	<u>Spares</u>	<u>Component</u>	<u>Unit Wt Kg</u>	<u>Total Wt Kg</u>	<u>Average Power Watts</u>
1		plumbing & fittings	10	10	
1	1	feed pump	10	20	10
1	1	circ pump	6	12	40
1		Accumulator	4	4	
1		RO Module housing	6	6	
1		controls	5	5	20
1		RO Module (*)	1	1	
2		MCV (*)	0.5	<u>1</u>	<u> </u>
		TOTALS:		49.0	70

Scheduled Replacement Items:

1 RO Module per 360 days = 0.25 Kg/90 days
 2 MCV per 90 days = 1 Kg/90 days

Summary:

	<u>Kg</u>
Launch weight	= 49.0
Power & thermal rejection penalty (70 x 0.357)	= <u>25.0</u>
Total Equivalent Launch Weight	= 74.0
90-day resupply weight	= 1.25

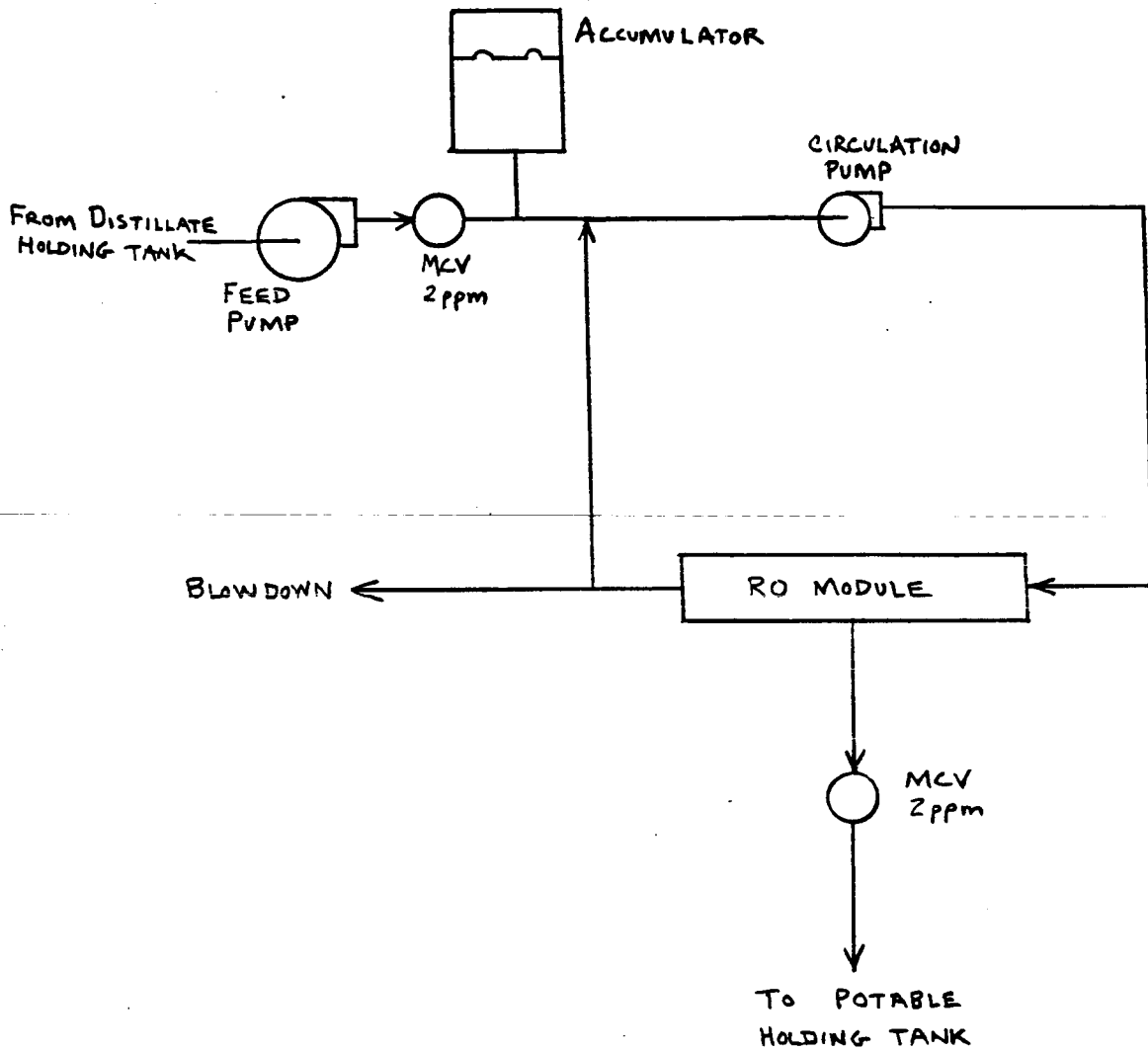

NOTE:

MCV = MICROBIAL CHECK VALVE

FIGURE 4.10-2
 REVERSE OSMOSIS UNIT
 BEND RESEARCH CONCEPT

TABLE 4.10-3. UV/O₃ USING WESTGATE RESEARCH CONCEPT

(See Figure 4.10-3)

Launched Weight with Scheduled Replacement Items (*) in Place.

<u>Qty</u>	<u>Spares</u>	<u>Component</u>	<u>Unit</u> <u>Wt</u> <u>Kg</u>	<u>Total</u> <u>Wt</u>	<u>Average</u> <u>Power</u>
<u>Kg</u>	<u>Watts</u>				
1		plumbing & fittings	4	4	
1	1	ozone generator	4	8	75
1	1	reactor	10	20	40
1	1	feed pump	1.5	3	10
1	1	discharge pump	1.5	3	10
1		controls	5	5	20
1		U-V lamp (*)	0.5	0.5	75
1		MCV (*)	0.5	<u>0.5</u>	<u> </u>
TOTALS:				44.0	230

Scheduled Replacement Items:

1 UV lamp per 360 days	=	0.25 Kg/90 days
1 MCV per 90 days	=	0.5 Kg/90 days

Summary:

	=	<u>Kg</u>
Launch weight	=	44.0
Power & thermal rejection penalty (70 x 0.357)	=	<u>82.1</u>
Total Equivalent Launch Weight	=	126.1
90-day resupply weight	=	0.75

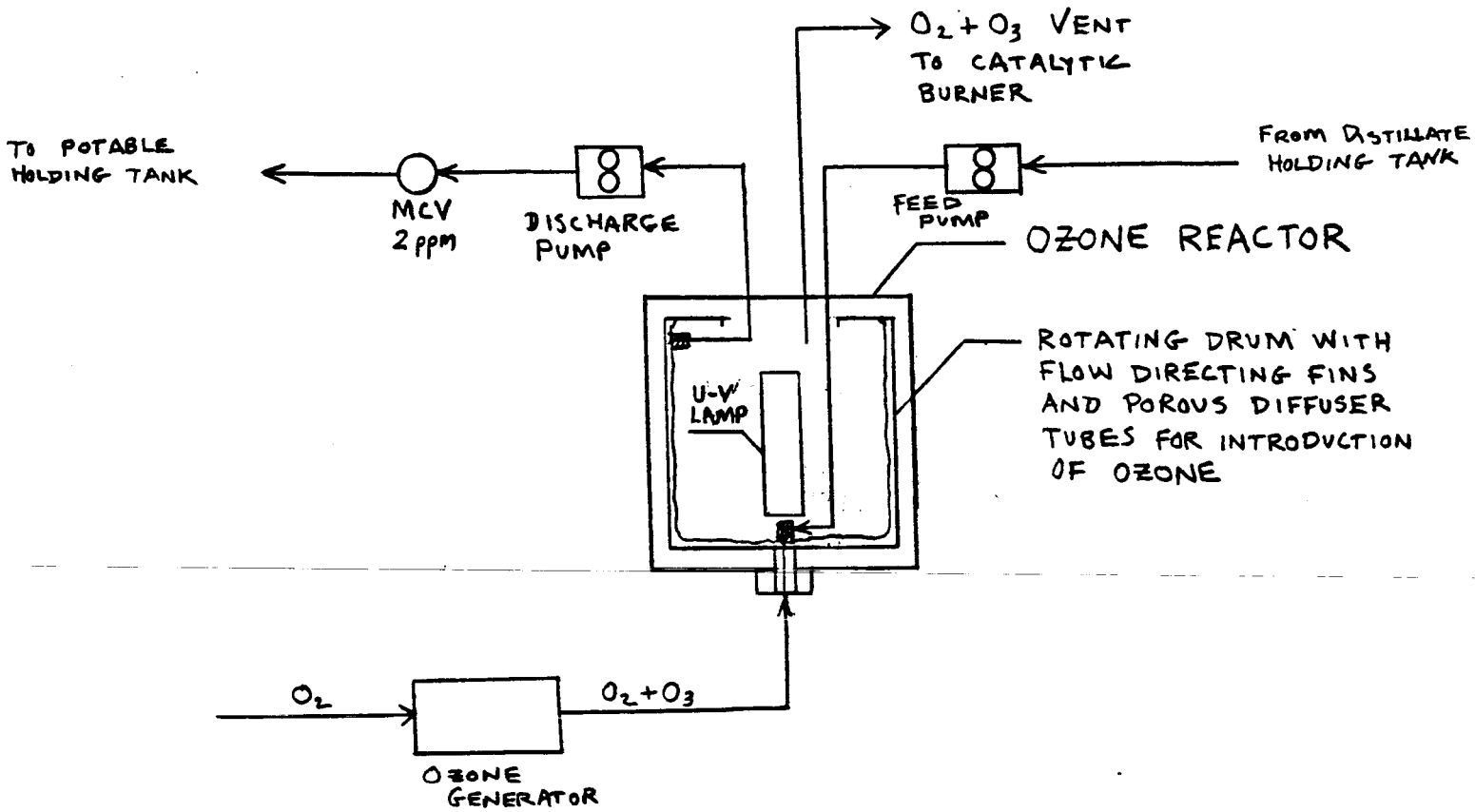

NOTE:

MCV = MICROBIAL CHECK VALVE

FIGURE 4.10-3

U-V/O₃ POSTTREATMENT UNIT
WESTGATE RESEARCH CONCEPT

Figure 4.10-4 Weight Comparison
For the Three
Candidate Post-
Filtration Methods

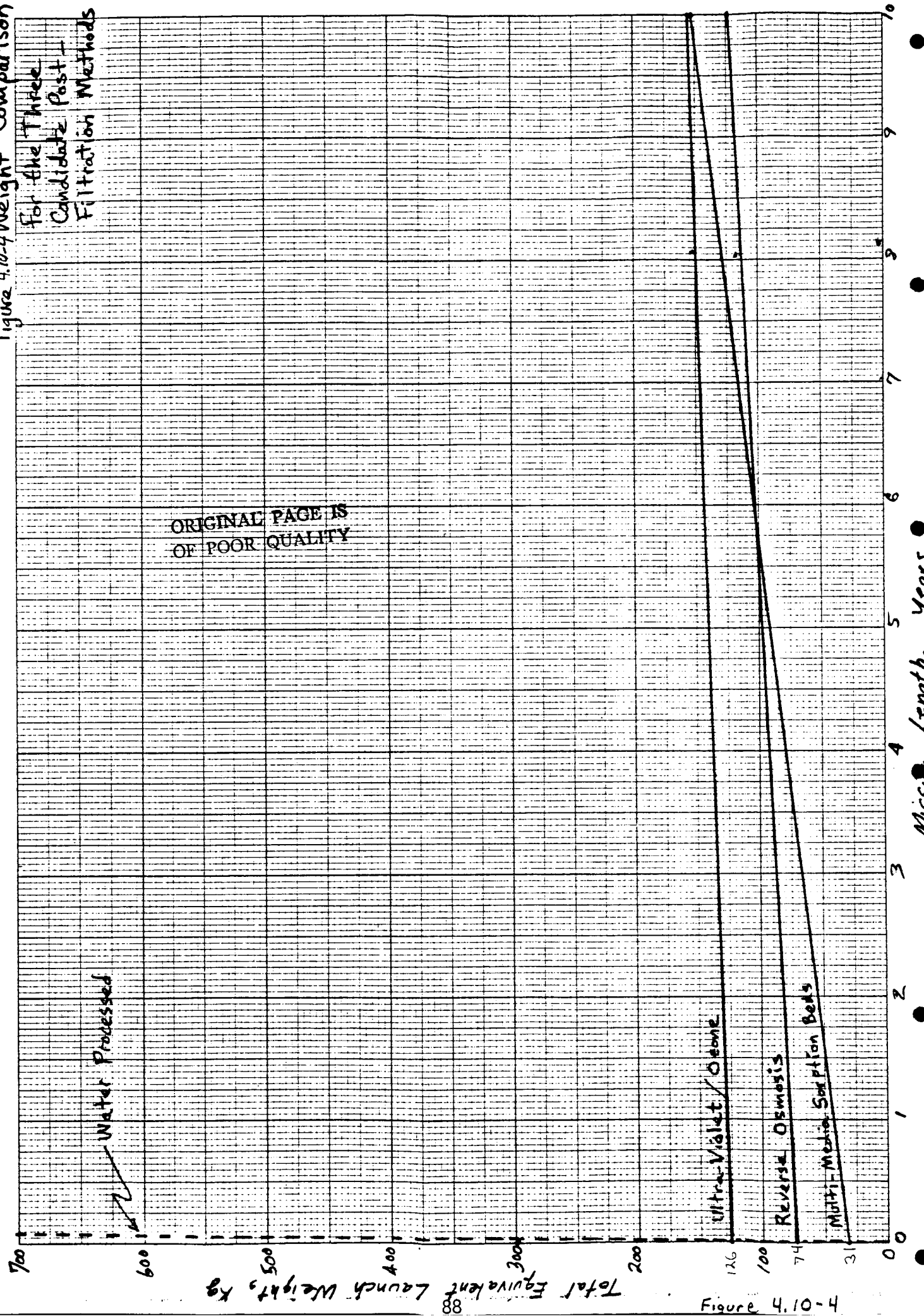

Total Equivalent Launch Weight, kg

Figure 4.01-4

TABLE 4.10-4. WEIGHT SUMMARIES FOR THE THREE CANDIDATE
POST FILTRATION METHODS

	Weight/Kg		
	<u>Multi-media Sorpton beds</u>	<u>Reverse Osmosis</u>	<u>UV/O₃</u>
Launch weight	24.5	49.0	44.0
Power & Thermal penalty	<u>7.1</u>	<u>25.0</u>	<u>82.1</u>
Total Equivalent launch weight	31.6	74.0	126.1
90-day resupply weight	3.0	1.25	0.75

Note: These tabulations are compared graphically in

Figure 4.10-4.

Since the processing rate is 19.5 Kg/day, even the heaviest of these methods will process an amount of water equivalent to its launch weight in less than seven days. This would appear to be a good bargain.

The data generated to date indicate that one of these alone may not be sufficient to remove all of the organic and inorganic contaminants that may be present in reclaimed water. For instance, UV/O₃ appears very good at removing organics but has little effect on inorganics, while reverse osmosis is better at removing inorganics than organics. So far the multi-media sorption beds have an edge when both inorganics and organics are considered, but more long-term testing is necessary to determine whether UV/O₃ may be

needed to remove a class of organics that may not be removed by either reverse osmosis or multi-media sorption. Further testing is needed on all three methods to more completely define their virtues and limitations.

5.0 CONCEPT RECOMMENDATIONS.

Several concepts are recommended for further evaluation while several others were dropped from further consideration. A summary of the recommendations is presented in Table 5.0-1.

TABLE 5.0-1. SUMMARY OF RECOMMENDATIONS.

<u>Recommended for Further Evaluation</u>	<u>Recommended to be Dropped</u>
Chemical Pretreatments	Flocculation/Coagulation
Post Treatment Sorption Beds	Electrolytic Pretreatment
Post Treatment by Reverse Osmosis	Post Treatment by Air Stripping
Post Treatment by Ozonation	Post Treatment by Liquid/ Liquid Extraction
Post Treatment Iodination	

REFERENCES

PHASE I PRE & POST FINAL REPORT

1. "Development of a Preprototype Vapor Compression Distillation Water Recovery Subsystem," Final Report, Contract NAS9-15136, Lockheed Missiles and Space Company, November 1978.
2. "Preprototype Vapor Compression Distillation Subsystem," Final Report, Contract NAS9-15267, Life Systems, Inc., August 1979.
3. Trusch, R.B. and Roebelen, G.J., Jr., "A Thermoelectric Integrated Membrane Evaporation System," ASME Paper No. 78-ENAS-19, presented at the Intersociety Conference on Environmental Systems, San Diego, CA, July 1978.
4. Roebelen, G.J. Jr., Dehner, G.F., and Winkler, H.E., "Thermoelectric Integrated Membrane Evaporation Water Recovery Technology," SAE Paper No. 82049, presented at the Intersociety Conference on Environmental Systems, San Diego, CA, July 1982.
5. Putnam, D.F., "Chemical Aspects of Urine Distillation," Paper No. 65-AV-24, presented at the ASME Aviation and Space Conference, Los Angeles, CA, March 1965.
6. Winkler, H.E., Verostko, C.E., and Dehner, G.F., "Urine Pretreatment for Waste Water Processing System." SAE Paper No. 831113, presented at the Intersociety Conference on Environmental Systems San Francisco, CA, July 1983.

7. Putnam, D.F. and Vaughan, R.L., "Design and Fabrication of a Flight Concept Prototype Electrochemical Water Recovery Subsystem," Final Report Contract NAS1-8954, McDonnell Douglas Astronautics Company, September 1971.
8. Elden, N.C., Winkler, H.E., Price, D.F., and Reysa, R.P., "Integrated Water Management System Description and Test Results," SAE Paper No. 831111, presented at the Intersociety Conference on Environmental Systems, San Francisco, CA, July 1983.
9. Colombo, G.V., Greenley, D.R., and Putnam, D.F., "Water System Microbial Check Valve Development," Final Report, Contract NAS9-15079, Umpqua Research Company, July 1978.
10. Colombo, G.V., and Greenley, D.R., "Advanced Check Valve Development," Final Report, Contract NAS9-15854, Umpqua Research Company, June 1980.
11. "60-Day Manned Test of a Regenerative Life Support System with Oxygen and Water Recovery", McDonnell Douglas Astronautics Company, NASA CR-98500, December 1968.
12. "Operational Ninety-Day Manned Test of a Regenerative Life Support System", NASA CR-111881, Douglas Astronautics Company, May 1971.
13. McCarty, Perry L., "Organics in Water - An Engineering Challenge," Journal of the Environmental Engineering Division, proceedings of the American Society of Civil Engineers, February 1980.

14. Putnam, D.F. and Vaughan, R. L., "Design and Fabrication of a Flight Concept Prototype Electrochemical Water Recovery Subsystem," Final Report Contract NAS1-8954, McDonnell Douglas Astronautics Company, September 1971.