

Precision Differential Sampling Measurements of Low-Frequency Synthesized Sine Waves With an AC Programmable Josephson Voltage Standard

Alain Rüfenacht, Charles J. Burroughs, Jr., Samuel P. Benz, *Senior Member, IEEE*,
Paul D. Dresselhaus, Bryan C. Waltrip, and Tom L. Nelson

Abstract—We have developed a precision technique to measure sine-wave sources with the use of a quantum-accurate ac programmable Josephson voltage standard. This paper describes a differential method that uses an integrating sampling voltmeter to precisely determine the amplitude and phase of high-purity and low-frequency (a few hundred hertz or less) sine-wave voltages. We have performed a variety of measurements to evaluate this differential technique. After averaging, the uncertainty obtained in the determination of the amplitude of a 1.2 V sine wave at 50 Hz is $0.3 \mu\text{V}/\text{V}$ (type A). Finally, we propose a dual-waveform approach for measuring two precision sine waves with the use of a single Josephson system. Currently, the National Institute of Standards and Technology (NIST) is developing a new calibration system for electrical power measurements based on this technique.

Index Terms—Digital-analog conversion, Josephson arrays, power measurement, quantization, signal synthesis, standards, superconductor-normal-superconductor devices, voltage measurement.

I. INTRODUCTION

THE HIGHEST accuracy in the calibration of ac signals to date has been obtained by the use of thermal converters, which require multiple ac–dc comparison steps [1]. A disadvantage of this technique is that it is relatively slow and only limited to the determination of the signal root mean square (rms) amplitude. Other methods have been developed to measure with high accuracy both the amplitude and the phase of ac signals. Among them, sampling techniques are widely used for the calibrations of power and energy meters [2]–[4]. However, the appearance of hysteretic effects limits the absolute accuracy of the sampling methods [5], [6]. One way to reduce undesirable gain and nonlinearity effects of the sampling voltmeters is to measure lower voltage amplitudes. For this purpose, we have developed a differential sampling method that compares the voltage of an ac source with that of an ac programmable Josephson voltage standard (ACPJVS).

Derived from dc programmable Josephson voltage standards [7]–[11], the ACPJVS systems produce stepwise-approximated waveforms such that the voltage on each step has the quantum

Manuscript received June 6, 2008; revised September 25, 2008. First published December 9, 2008; current version published March 10, 2009. This paper was presented in part at the Conference on Precision Electromagnetic Measurements, Broomfield, CO, June 8–13, 2008. The Associate Editor coordinating the review process for this paper was Dr. Y.-H. Tang.

The authors are with the National Institute of Standards and Technology, Gaithersburg, MD 20899-1070 USA.

Digital Object Identifier 10.1109/TIM.2008.2008087

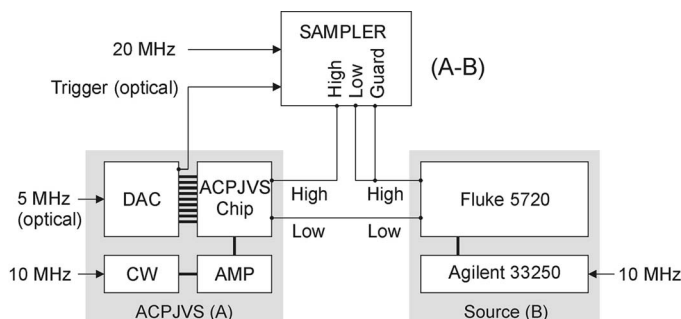

Fig. 1. Diagram showing the differential (A–B) measurement setup. The reference signal (a square wave at the same frequency of the ACPJVS waveform) for the phase and frequency locking of the Fluke 5720A is provided by an Agilent 33250 arbitrary waveform generator. All clock signals are locked to the same reference. The guard of the sampling voltmeter is driven by the same signal (B) as the low input of the sampler. Glossary for the ACPJVS system: DAC = Current bias electronics, AMP = microwave amplifier, and CW = 18.3 GHz microwave generator.

accuracy of the Josephson effect [12]–[15]. Unfortunately, for this technique, the nonzero rise time of the bias electronics and other timing effects influence the step transitions [16], [17] so that the ACPJVS-synthesized waveforms do not yield quantum-accurate rms voltages. Nevertheless, the quantum accuracy of the ACPJVS waveforms can be exploited by using differential sampling techniques, because the samples that contain transients can easily be discarded. For the reconstruction of the source waveform, we only use the samples in which the ACPJVS voltages are fully settled on their quantum-accurate dc values (Josephson steps) [6].

We present in this paper a differential sampling method that is used to determine the amplitude of a sinusoidal waveform (B) using an ACPJVS reference (A). The block diagram of the differential sampling configuration is shown in Fig. 1. Previous investigations of the differential sampling method using two ACPJVS systems provided important information regarding the capabilities, advantages, and limitations of the technique [6], [18]. This method can be used to determine the amplitude, phase (relative to the sampling window), and harmonic content of any ac voltage waveform. The reconstruction technique based on the Josephson reference voltages and the differential sampling measurements is explained in detail in the next section. This method produces better results than those of conventional sampling techniques, but to take full advantage of the differential configuration, ac sources with high amplitude and phase stability, as well as excellent spectral purity, are

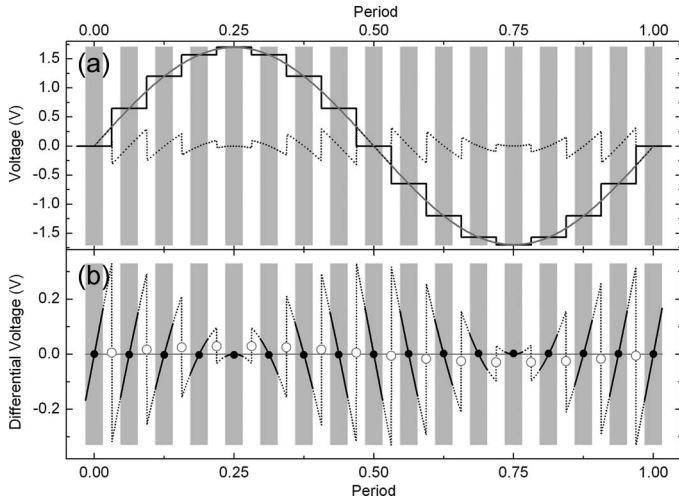

Fig. 2. (a) Ideal simulated ACPJVS staircase-approximated sine wave with 16 samples and ac source sine wave (both with 1.2 V rms amplitude and zero relative phase). The resulting differential waveform is represented by the dotted line. The gray and white stripes correspond to the different integration windows of the sampling voltmeter. (b) Zoom of the differential waveform. The circles show the magnitude of the integrated voltage for each sampling window. Free of transients, the solid circle samples are used for waveform amplitude reconstruction. The open circle samples that contain the transients are discarded.

required. For the measurements presented in this paper, a Fluke 5720A calibrator was used as the ac source.¹ We performed a variety of tests to ensure that the differential sampling technique remains valid over the range of experimental parameters, such as the relative phase alignment and the number of Josephson voltage samples per waveform.

This differential sampling method, which was adapted to low-frequency waveforms, is particularly interesting for electrical power applications: the National Institute of Standards and Technology (NIST) is developing a “Quantum-Watt” system [19], [20] based on this technique. The electrical power calibration standards are based on the precise knowledge of the rms amplitudes and the relative phases of two ac waveforms. In Section VI, we describe a practical method for determining the amplitudes of two ac waveforms by the use of a “dual” reference waveform provided by a single ACPJVS system.

II. DIFFERENTIAL SAMPLING TECHNIQUE

As an introduction to the differential technique, Fig. 2(a) presents a simulation of the ACPJVS staircase-approximated waveform, the ac source sine wave, and the resulting differential voltage. For simplicity, we have chosen in this example an ACPJVS waveform with 16 samples. Both waveforms have 1.2 V rms amplitude. Because the ACPJVS waveform is only accurate on each constant-voltage step, the contributions from the transients must be removed. This is done by sampling the differential waveform twice for each step of the ACPJVS waveform [6] and then discarding half of the measurements that contain the transients (open circles) [see Fig. 2(b)]. The remain-

ing measurements (solid circles) contain the integrated values of the voltage difference between the constant-voltage reference steps and the sinusoidal waveform. By analyzing these data, we reconstruct the original sine wave and extract its amplitude and phase relative to the sampling window (described below). In this idealized example, the position of the sampling window is centered on constant-voltage steps of the ACPJVS waveform. The ACPJVS reference and ac source waveforms are frequency locked and phase synchronized (zero relative phases).

In the actual measurements, the number of ACPJVS steps per period is much larger than 16 (generally from 40 to 100) so that the differential amplitude is smaller than the smallest amplitude range (100 mV) of the sampling voltmeter, which optimizes the benefit of the differential sampling method. The amplitude of a staircase-approximated Josephson sine wave is chosen to closely match the amplitude of the sinusoidal source. Before each measurement, the ac source amplitude is set to zero, and the sampling window is aligned so that half of the integration bins are centered in the middle of the corresponding constant-voltage steps. Alignment is optimized by adjusting the delay between the bias electronics trigger output and the start of the sampling sequence. Once the sampling window is aligned with respect to the ACPJVS waveform, the ac source amplitude is turned on. The phase of the ac source is then aligned with the ACPJVS waveform to reach the relative phase desired (around zero degrees to minimize the differential voltage). The phase-alignment algorithm consists of sampling the differential voltage, reconstructing the relative phase (see below), and applying a phase-shift correction to the ac source. No further realignment during the measurement sequence is needed as long as all the frequency references remain locked to the same clock reference. Once these alignment steps are completed, the system is ready for voltage measurements.

The first step toward determining the amplitude and phase of the ac source is to reconstruct an “integrated-quantity” waveform by summing the differential sampling measurements with the corresponding known Josephson voltages from each sample. By fitting the fundamental and the first ten harmonics of this reconstructed waveform, the amplitudes and phases of these signals may be derived. The fitting procedure also provides the magnitude of the dc offset and the residual amplitude at the power-line frequency (60 Hz). To obtain the rms value of the harmonics, the fitted amplitudes are corrected for the sampler transfer function $\sin(\pi \cdot f \cdot \tau) / (\pi \cdot f \cdot \tau)$, where $\tau = (2Nf) - \delta t$ is the integration (aperture) time of the sampling voltmeter, f is the frequency of the waveform, N is the number of ACPJVS waveform steps, and δt is the setup time of the sampling voltmeter. The factor of two in the expression of the integration time arises because the number of measurement samples is twice the number of steps in the ACPJVS waveform. We fix the value of δt to 30 μs so that the sampler has enough time to complete its required setup time and provide its highest accuracy.

In contrast with the dc comparison measurements, we measure the differential voltage between the high sides of the two sources (Fig. 1). This configuration has the advantage of simplifying the measurement setup for the electrical power applications, where two different voltage sources must be

¹Commercial instruments are identified in this paper only to adequately specify the experimental procedure. Such identification does not imply recommendation or endorsement by the NIST, nor does it imply that the equipment identified are necessarily the best available for the purpose.

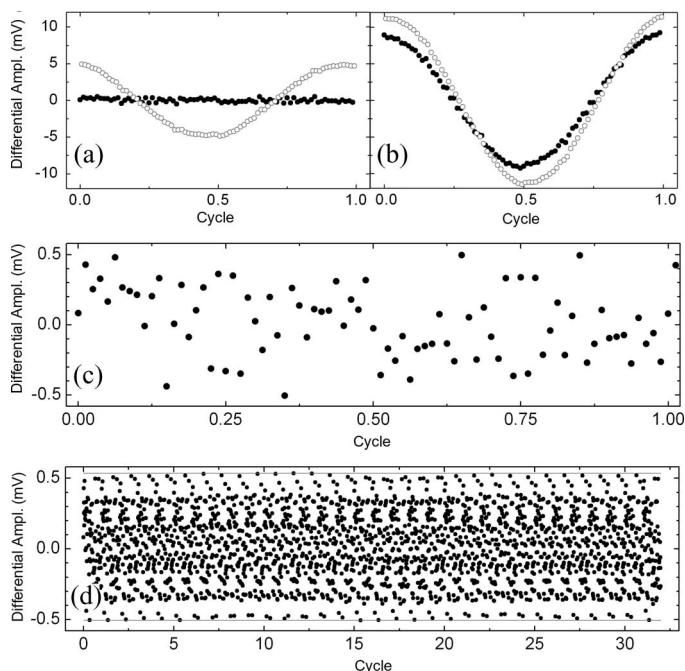

Fig. 3. Differential amplitudes measured by the sampling voltmeter using an ACPJVS stepwise-approximated 50 Hz 1.2 V rms sine wave with 80 steps per period, (a) with zero relative phase and (b) with 0.3° relative phase for “on-step” (solid circles) and transient (open circles) samples. The measured amplitudes of only the “on-step” samples for (c) the first cycle and (d) all 32 cycles of the zero relative phase trace. The two horizontal lines in (d) indicate the maximum amplitudes measured and emphasize a small amplitude modulation.

compared with the Josephson voltage reference. With the use of a coaxial cable between the various instruments, this configuration also provides better shielding. Therefore, we rely on the common-mode rejection performance of the sampling voltmeter by driving the voltmeter guard with the same signal as the one connected to the low input (the waveform with the least harmonic content). At 50 Hz, the common-mode error of the sampling voltmeter has been determined to be less than $0.1 \mu\text{V/V}$ [19].

III. DIFFERENTIAL SAMPLING MEASUREMENTS

Precision comparisons were performed between the ACPJVS and the Fluke 5720A sine wave with various numbers of samples and relative phase configurations. Both of the 50 Hz waveforms had rms amplitudes of 1.2 V. Fig. 3 shows typical measurements with the sampling voltmeter of the resulting differential (A–B) waveform. The measured differential amplitude and pattern depend on the relative phase alignment, for instance, 0° in Fig. 3(a) and 0.3° in Fig. 3(b). The sinusoidal shape of the transient samples (open circles) is a direct consequence of the differential method with sinusoidal waveforms, as already demonstrated in the ideal case shown in Fig. 2(b).

The signals of interest for the reconstruction technique are the “on-step” samples (solid circles). We present the zero relative phase measurements for the first cycle in Fig. 3(c) and all the 32 cycles used for the reconstruction in Fig. 3(d). In Fig. 3(c), the nonzero symmetrical pattern is a consequence of the finite quantization of the Josephson voltage levels. In

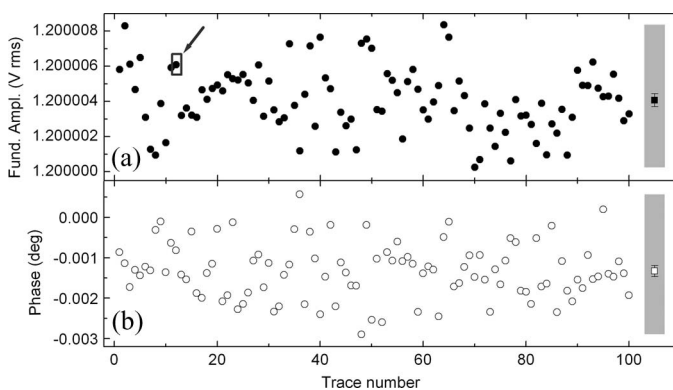

Fig. 4. Calculated values of the Fluke 5720A rms amplitude and phase (nominally 1.2 V and 0°) at 50 Hz inferred from the measured differential signal by use of an 80-step ACPJVS reference waveform. (a) Mean amplitude of the fundamental for each of the 100 traces. (b) Mean phase relative to the sampling window for the same sampled data. In each gray rectangle, we graphically report the resulting average value calculated over the 100 traces. The error bar represents the standard deviation of the mean ($k = 2$). The arrow indicates the mean value of trace #12, whose detailed measurements are shown in Fig. 3.

TABLE I
AMPLITUDE AND PHASE

	rms amplitude (μV)	phase (deg)
1f	$1,200,004.07 \pm 0.37$	$-0.001\ 327 \pm 0.000\ 138$
2f	17.31 ± 0.03 (-96.8 dBc)	-128.35 ± 0.10
3f	6.57 ± 0.02 (-105.2 dBc)	-51.49 ± 0.22
4f	0.99 ± 0.02 (-121.6 dBc)	91.01 ± 1.50
5f	7.31 ± 0.02 (-104.3 dBc)	-144.71 ± 0.16
60 Hz	2.74 ± 0.14	
DC off.	-17.15 ± 0.77	

Various averaged amplitudes and phases derived from the fitting procedure over the 100 traces (rms amplitude of nominally 1.2 V, 50 Hz frequency and 80 steps per waveform). The uncertainties reported correspond to the standard deviation of the mean ($k=2$).

Fig. 3(d), one can see that the differential waveform is slightly modulated over the 32 cycles. Ideally, the waveform pattern should be identical for each cycle, which is clearly not the case here. This “jitter effect” is caused most likely by the instability in the phase-locking mechanism of the calibrator, as discussed hereinafter.

The sampler acquired 100 individual traces, each consisting of 32 cycles. For each of these traces, we fit the amplitude and phase of the sine wave and the first few harmonics. In Fig. 4, the amplitude and phase of the fundamental are shown, and it can be seen that they both have good short-term stability. Averaged over all the 100 traces, the rms amplitude of the fundamental is 1.200 004 07 V with a corresponding standard deviation of the mean ($k = 2$) of $0.37 \mu\text{V}$, which corresponds to a measurement uncertainty of $0.3 \mu\text{V/V}$ (type A). The harmonic contributions (reported in Table I) are particularly small, and their contribution to the total rms value is well below one part in 10^8 . We draw the same conclusion for the 60 Hz voltage contribution.

In general, this analysis shows that the amplitude of the Fluke 5720A source is stable and that the contributions from higher harmonics are negligible for rms voltage measurements. Nevertheless, as shown in Fig. 3(d), we observe a time-dependent amplitude modulation. With the differential

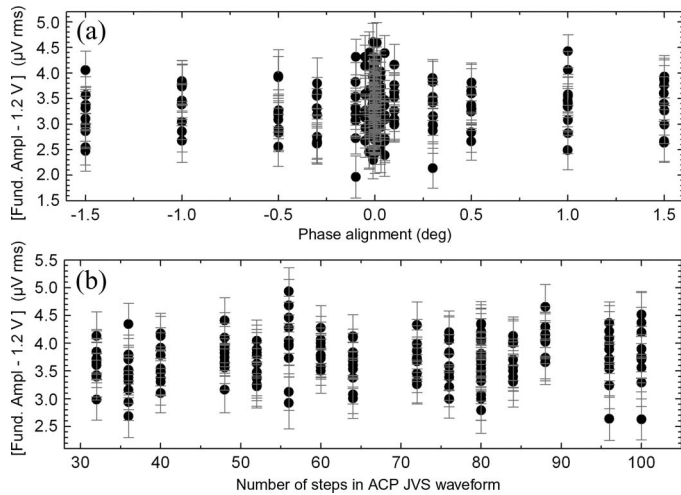

Fig. 5. Demonstration that the differential sampling method produces consistent results with regard to (a) phase misalignment and (b) number of steps in the ACPJVS waveform.

approach, there are two obvious contributors to this effect, i.e., the phase noise [see Fig. 4(b)] produced by the phase and frequency locking function of this particular calibrator and the low-frequency modulation of the actual amplitude of the calibrator source. Fortunately, averaging over many traces considerably reduces this effect.

IV. EVALUATION OF THE SAMPLING METHOD

Fig. 5 presents the results of two important tests that are essential for determining the potential sources of error in the differential sampling method (type B uncertainties). The measured values must be independent of both (a) the phase alignment and (b) the number of voltage steps used in the ACPJVS waveform. This requirement can be satisfied as long as the resulting differential voltage is on the lowest (100 mV) range of the sampling voltmeter. To obtain consistent results, the output voltage of the Fluke 5720A must be constant over the duration of the test. To check the overall stability, we repeated the previous measurement ten times, varying the phase offset and number of samples. In Fig. 5(a), the relative phase was adjusted over $\pm 1.5^\circ$ while keeping the other parameters of the ACPJVS waveform fixed (80 waveform steps, 50 Hz, 1.2 V). In Fig. 5(b), the number of steps in the 50 Hz sine wave was varied from 32 to 100. Except for the expected variations due to the measurement noise, the inferred amplitude was independent of both the phase alignment and the number of ACPJVS waveform steps. It is important to note that the sampling voltmeter's aperture time decreases with the increasing number of samples and that this significant change did not affect the measured amplitude. Therefore, over the tested range, the results show that the aperture time (τ) used to rescale the data is well controlled. Note that the choice of the number of steps per ACPJVS waveform is a compromise between the small differential voltages (requiring a high number of steps per ACPJVS waveform) and the large aperture time (requiring a small number of steps per ACPJVS waveform to reduce the noise contribution of the sampler [6]).

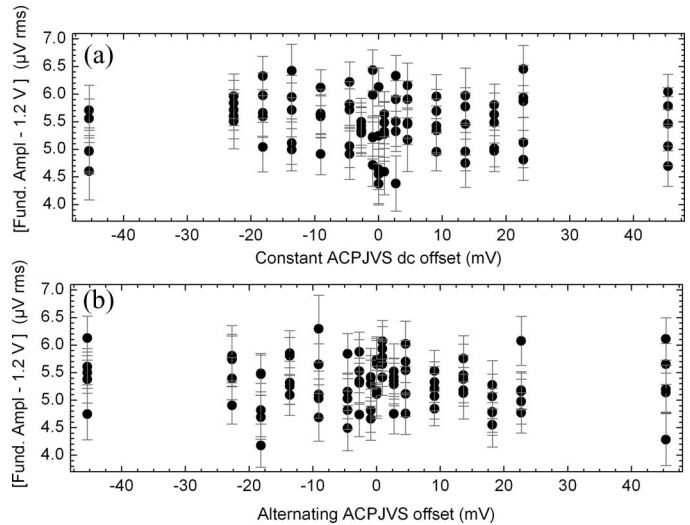

Fig. 6. Demonstration that the differential sampling method produces consistent results with regard to (a) ACPJVS dc offsets and (b) ACPJVS interleaved offsets.

Since the amplitude resolution of an ACPJVS waveform is determined by the voltage produced by its smallest segment or least significant bit (LSB), we can attribute only quantized voltage values to the staircase-approximated sine wave. By using an ACPJVS chip with 3.9 V maximum voltage (three Josephson junctions per stack) [10], the smallest segment contains 24 junctions, which produces an LSB voltage of 0.908 mV at 18.3 GHz. Due to the quantization of the ACPJVS waveform, the sampled differential voltages are not rigorously zero, even if the phase and amplitude of the two waveforms are well matched. This effect can be seen in the data shown in Fig. 3(c), where the differential voltages vary between -0.5 mV and $+0.5$ mV. To check if the ACPJVS voltage quantization induced variations in the reconstructed amplitude, we performed measurements with intentionally distorted ACPJVS waveforms. In the first distortion test, the ACPJVS voltages were shifted with a constant dc offset [see Fig. 6(a)], which varied from -50 to $+50$ LSBs for each measurement. The corresponding sampled differential amplitude is shifted by the same offset amount. For this test, we used the standard 80-step ACPJVS waveform, 50 Hz, and 1.2 V rms amplitude waveforms. No systematic trend over the full dc offset range of ± 50 mV was observed in the computed fundamental amplitude. Even the largest applied offsets that gave a differential amplitude close to the full range of the voltmeter (100 mV) showed no noticeable gain effect on the reconstructed amplitude.

For the second distortion test, we intentionally applied alternate positive and negative offsets to the consecutive steps of the ACPJVS reference waveform. This interleaving of the offsets has the advantage of having zero net dc component over the full cycle and keeps the total rms voltage of the ACPJVS waveform almost unchanged. The reconstructed amplitude of the measurement for the alternating dc over the same ± 50 mV range is presented in Fig. 6(b) and shows the same lack of systematic trend as for the constant offset test.

To discard the transient contributions and obtain reasonably small differential amplitudes, we have chosen to sample

the differential waveform with twice the sample number of the ACPJVS waveform. To further verify the amplitude reconstruction technique, we doubled the number of sampling measurements; therefore, we measured four samples for each Josephson voltage step. In this measurement, only one quarter of the measured data contained transients that were discarded. The three remaining differential voltage measurements for each Josephson step are suitable for amplitude reconstruction (#1, #2, and #3). Two of them (#1 and #3) produce larger integrated voltage data than the one located in the middle (#2). For each differential measurement trace of 32 cycles, we reconstructed the amplitude of the sine-wave source with separate contributions of #1, #2, #3 and #1 + #3. All of the reconstructed amplitudes agree with each other within an uncertainty smaller than the noise floor of the measurement. Once again, the gain and linearity of the sampling voltmeter do not appear to affect the reconstructed amplitude. Therefore, at 50 Hz, we expect a type B uncertainty due to the common mode and the linearity effects to be less than the type A uncertainty inferred from Section III.

V. DUAL ACPJVS REFERENCE WAVEFORM

Calibrations of the watt and watt-hour meters require two ac signal sources (one for voltage and one for current) with known amplitudes and phase shifts between them. For the quantum-based ac power standard, we chose to perform rms voltage comparisons at $V_V = 1.2$ V and rms current comparison using a reference voltage $V_I = 0.5$ V [19]. This suggests the use of two sampling voltmeters and two ACPJVS systems. However, to minimize the complexity of the calibration system and reduce the cost, we have implemented a single ACPJVS system and will use it to generate both reference waveforms. The first idea was to generate a dual interleaved ACPJVS waveform with the V_V and V_I voltages in alternating steps of the ACPJVS waveform. This approach had the advantage of simultaneously measuring both ac sources but had the disadvantage of overloading the voltmeter at every other sample. Unfortunately, the sampling voltmeter was unable to recover from this overloaded state prior to the next sampling measurement, which prevented the practical use of this rather elegant approach. Fortunately, the large circular memory of the ACPJVS bias source allows the storage of a dual ACPJVS waveform based on multiple cycles of each voltage reference signal. As represented in Fig. 7, such a dual ACPJVS waveform consists of juxtaposing n cycles of the V_V reference waveform with m cycles of the V_I reference waveform.

Even with the juxtaposed dual waveform, each sampling voltmeter is overloaded when the voltage reference provided by the dual waveform corresponds to the other reference signal. However, the advantage of the method is that the sampler has the opportunity to recover from its overload state for a fixed number of cycles while measuring the desired reference ACPJVS waveform. To determine this recovery time, we performed a direct measurement of a dual juxtaposed ACPJVS waveform with the sampling voltmeter (no differential technique, no sine-wave source used). The ACPJVS test waveform comprised four cycles with a 1.2 V rms that overloaded the

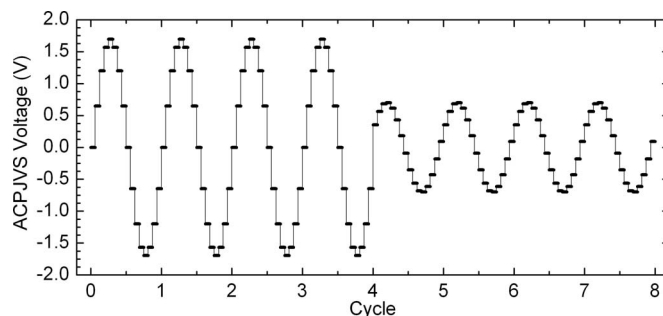

Fig. 7. Example of a dual juxtaposed ACPJVS waveform with $n = 4$ cycles of a 1.2 V rms and $m = 4$ cycles of 0.5-V rms sine waves, with a relative phase of 30° . For clarity, we show a waveform with only 16 samples per cycle.

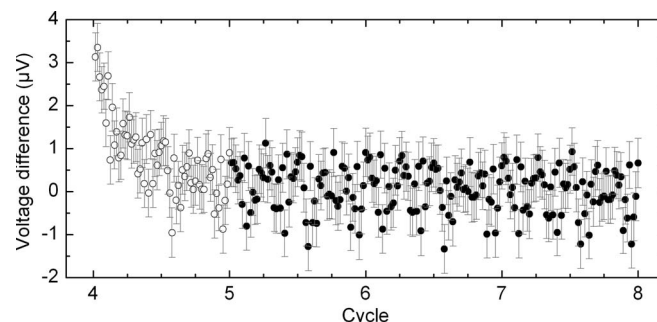

Fig. 8. Difference between the expected Josephson rms voltage (10 mV) and the amplitude measured with the sampling voltmeter as a function of time (50 Hz cycle). During cycles 1 through 4, the 100 mV range of the sampling voltmeter is overloaded with the 1.2 V juxtaposed waveform. After a complete cycle (open circles), the sampler fully recovers from the overloaded state (solid circles).

sampler followed by four cycles with a 10 mV rms amplitude staircase-approximated sine wave with 64 samples per cycle and 50 Hz frequency. Fig. 8 demonstrates that, after a full cycle, the voltmeter recovers from its initially overloaded state to within the measurement noise. All of the various tests performed with the juxtaposed ACPJVS waveforms of different numbers of cycles and various amplitudes for the overloaded cycles produced the same results. The dual juxtaposed approach appears valid as long as the first cycle (20 ms) of the corresponding reference is discarded for the amplitude reconstruction of the sine-wave source. For example, the cycle number for each ACPJVS voltage reference can be extended to 33, which provides 32 valid cycles to determine the ac source amplitude. The other advantage of this method is that the dual waveform has a precisely fixed relative phase for power calibrations.

VI. CONCLUSION

A differential sampling technique has successfully been demonstrated, in which the ACPJVS provides a precision quantum-accurate voltage (and phase) reference to accurately measure the amplitude and relative phase of a high-purity 50 Hz sine wave produced by a Fluke 5720A calibrator. The results demonstrate significant parameter ranges over which the method is independent of the phase alignment, the number of samples, and the quantization effect inherent to the ACPJVS waveform. Furthermore, for this particular frequency (50 Hz),

the influence of the linearity effects and common-mode rejection is much smaller than $1 \mu\text{V}/\text{V}$, which meets the precision requirement for a Josephson-based wattmeter system. Nevertheless, we observe limitations due to the phase and amplitude jitter from Fluke 5720A, which introduced noise in the reconstructed amplitude. Although this jitter does not significantly affect the ac–dc transfer standard rms measurements with the Fluke calibrator, which is its intended application, it compromises its use in our Quantum–Watt system. NIST is constructing a custom source for the Quantum–Watt system, which will have the desired phase stability for these sampling measurements. The dual ACPJVS waveform provides a useful Josephson reference for the differential method involving the two sources of the Quantum–Watt system without affecting the precision of the measurement. The results obtained with the differential sampling technique emphasize the importance of ACPJVS methods, excluding the contribution of the transients [20], [21]. In addition to the described power application, these transient-free techniques may enable new applications in the field of low-frequency ac voltage metrology, such as thermal voltage converter calibrations, impedance measurements, etc.

ACKNOWLEDGMENT

The authors would like to thank Y. Chong, N. Hadacek, and B. Baek for helping develop the stacked junction fabrication process used for our PJVS chips, D. R. White for the helpful approaches for the data analysis of differential measurements, and B. Djokic of NRC-Canada for helpful conversations concerning the differential sampling method.

REFERENCES

- [1] B. D. Inglis, "Standards for ac–dc transfer," *Metrologia*, vol. 29, no. 2, pp. 191–199, May 1992.
- [2] R. S. Turgel, "Digital wattmeter using a sampling method," *IEEE Trans. Instrum. Meas.*, vol. IM-23, no. 4, pp. 337–341, Dec. 1974.
- [3] G. N. Stenbakken, "Digital wattmeter using a sampling method," *IEEE Trans. Power App. Syst.*, vol. PAS-103, no. 10, pp. 2919–2926, Oct. 1984.
- [4] R. Arseneau, M. Sutherland, and J. Zelle, "A new transfer device for the NRC travelling standard program," *IEEE Trans. Instrum. Meas.*, vol. 52, no. 2, pp. 411–414, Dec. 2003.
- [5] W. G. Kürten Ihlenfeld, E. Mohns, R. Behr, J. M. Williams, G. Ramm, and H. Bachmair, "Characterization of a high-resolution analog-to-digital converter with a Josephson AC voltage source," *IEEE Trans. Instrum. Meas.*, vol. 54, no. 2, pp. 649–652, Apr. 2005.
- [6] A. Rüfenacht, C. J. Burroughs, and S. P. Benz, "Precision sampling measurements using ac programmable Josephson voltage standards," *Rev. Sci. Instrum.*, vol. 79, no. 4, pp. 044 704-1–044 704-9, Apr. 2008.
- [7] S. P. Benz, C. A. Hamilton, C. J. Burroughs, T. E. Harvey, and L. A. Christian, "Stable 1 volt programmable voltage standard," *Appl. Phys. Lett.*, vol. 71, no. 13, pp. 1866–1868, Sep. 1997.
- [8] H. Schulze, R. Behr, F. Müller, and J. Niemeyer, "Nb/Al/AIO_x/AIO_x/Al/Nb Josephson junctions for programmable voltage standards," *Appl. Phys. Lett.*, vol. 73, no. 7, pp. 996–998, Aug. 1998.
- [9] C. J. Burroughs, S. P. Benz, T. E. Harvey, and C. A. Hamilton, "1 volt dc programmable Josephson voltage standard," *IEEE Trans. Appl. Supercond.*, vol. 9, no. 2, pp. 4145–4149, Jun. 1999.
- [10] Y. Chong, C. J. Burroughs, P. D. Dresselhaus, N. Hadacek, H. Yamamori, and S. P. Benz, "Practical high resolution programmable Josephson voltage standards using double- and triple-stacked MoSi₂ barrier junctions," *IEEE Trans. Appl. Supercond.*, vol. 15, no. 2, pp. 461–464, Jun. 2005.
- [11] C. J. Burroughs, P. D. Dresselhaus, Y. Chong, and H. Yamamori, "Flexible cryo-packages for Josephson devices," *IEEE Trans. Appl. Supercond.*, vol. 15, no. 2, pp. 465–468, Jun. 2005.
- [12] C. A. Hamilton, C. J. Burroughs, and R. L. Kautz, "Josephson D/A converter with fundamental accuracy," *IEEE Trans. Instrum. Meas.*, vol. 44, no. 2, pp. 223–225, Apr. 1995.
- [13] P. Kleinschmidt, P. D. Patel, J. M. Williams, and T. J. B. M. Janssen, "Investigation of binary Josephson arrays for arbitrary waveform synthesis," *Proc. Inst. Elect. Eng.—Sci. Meas. Technol.*, vol. 149, no. 6, pp. 313–316, Nov. 2002.
- [14] R. Behr, J. M. Williams, P. Patel, T. J. B. M. Janssen, T. Funck, and M. Klönz, "Synthesis of precision waveforms using a SINIS Josephson junction array," *IEEE Trans. Instrum. Meas.*, vol. 54, no. 2, pp. 612–615, Apr. 2005.
- [15] C. J. Burroughs, S. P. Benz, P. D. Dresselhaus, B. C. Waltrip, T. L. Nelson, Y. Chong, J. M. Williams, D. Henderson, P. Patel, L. Palafox, and R. Behr, "Development of a 60 Hz power standard using SNS programmable Josephson voltage standards," *IEEE Trans. Instrum. Meas.*, vol. 56, no. 2, pp. 289–294, Apr. 2007.
- [16] C. J. Burroughs, A. Rüfenacht, S. P. Benz, P. D. Dresselhaus, B. C. Waltrip, and T. L. Nelson, "Error and transient analysis of stepwise-approximated sine waves generated by programmable Josephson voltage standards," *IEEE Trans. Instrum. Meas.*, vol. 57, no. 7, pp. 1322–1329, Jul. 2008.
- [17] C. J. Burroughs, Jr., A. Rüfenacht, S. P. Benz, and P. D. Dresselhaus, "Systematic error analysis of stepwise-approximated AC waveforms generated by programmable Josephson voltage standards," *IEEE Trans. Instrum. Meas.*, vol. 58, no. 4, pp. 761–767, Apr. 2009.
- [18] R. Behr, L. Palafox, G. Ramm, H. Moser, and J. Melcher, "Direct comparison of Josephson waveforms using an ac quantum voltmeter," *IEEE Trans. Instrum. Meas.*, vol. 56, no. 2, pp. 235–238, Apr. 2007.
- [19] B. C. Waltrip, B. Gong, T. L. Nelson, Y. Wang, C. J. Burroughs, Jr., A. Rüfenacht, S. P. Benz, and P. D. Dresselhaus, "AC power standard using a programmable Josephson voltage standard," *IEEE Trans. Instrum. Meas.*, vol. 58, no. 4, pp. 1041–1048, Apr. 2009.
- [20] L. Palafox, G. Ramm, R. Behr, W. G. K. Ihlenfeld, and H. Moser, "Primary ac power standard based upon programmable Josephson junction arrays," *IEEE Trans. Instrum. Meas.*, vol. 56, no. 2, pp. 534–537, Apr. 2007.
- [21] B. Jeanneret, F. Overney, L. Callegaro, A. Mortara, and A. Rüfenacht, "Josephson-voltage-standard-locked sine wave synthesizer: Margin evaluation and stability," *IEEE Trans. Instrum. Meas.*, vol. 58, no. 4, pp. 791–796, Apr. 2009.
- [22] A. Rüfenacht, C. J. Burroughs, S. P. Benz, P. D. Dresselhaus, B. Waltrip, and T. Nelson, "Precision differential sampling measurements of low-frequency voltages synthesized with an ac programmable Josephson voltage standard," in *Proc. Conf. Precis. Electromagn. Meas. Dig.*, Broomfield, CO, Jun. 10, 2008, TuB1-1.



Alain Rüfenacht was born in La Chaux-de-Fonds, Switzerland, on August 20, 1975. He received the physics degree and the Ph.D. degree in high-temperature superconducting ultrathin films from the Université de Neuchâtel, Neuchâtel, Switzerland, in 1998 and 2005, respectively.

In 1999, he was a Scientific Collaborator with the Electrical Quantum Standards Laboratory, Swiss Federal Office of Metrology (METAS). Since 2007, he has been a Guest Researcher with the Quantum Voltage Project, National Institute of Standards and Technology (NIST), Gaithersburg, MD, where he mainly focuses on the integration of Josephson junction arrays into voltage standards.



Charles J. Burroughs, Jr. was born on June 18, 1966. He received the B.S. degree in electrical engineering from the University of Colorado, Boulder, in 1988.

He is currently with the National Institute of Standards and Technology (NIST), Boulder, where he was a student and has been a permanent staff member since 1988. At NIST, he has worked in the area of superconductive electronics, including the design, fabrication, and testing of Josephson voltage standards and digital-to-analog and analog-to-digital converters. He is the author of 45 publications and the holder of three patents in the field of superconducting electronics.



Samuel P. Benz (M'00–SM'00) was born in Dubuque, IA, on December 4, 1962. He received the B.A. degree (*summa cum laude*) in physics and math from Luther College, Decorah, IA, in 1985 and the M.A. and Ph.D. degrees in physics from Harvard University, Cambridge, MA, in 1987 and 1990, respectively.

Since 1990, he has been with the National Institute of Standards and Technology (NIST), Boulder, CO, where he was a NIST/NRC Postdoctoral Fellow and has been a permanent staff member since January 1992. He has been the Project Leader of the Quantum Voltage Project at NIST since October 1999. He has 150 publications and is the holder of three patents in the field of superconducting electronics. He has worked on a broad range of topics within the field of superconducting electronics, including Josephson junction array oscillators, single flux quantum logic, ac and dc Josephson voltage standards, and Josephson waveform synthesis.

Dr. Benz is a member of Phi Beta Kappa and Sigma Pi Sigma. He was the recipient of two U.S. Department of Commerce Gold Medals for Distinguished Achievement. He received an R. J. McElroy Fellowship (1985–1988) to work toward the Ph.D. degree.



Paul D. Dresselhaus was born in Arlington, MA, on January 5, 1963. He received the B.S. degree in physics and electrical engineering from the Massachusetts Institute of Technology, Cambridge, in 1985 and the Ph.D. degree in applied physics from Yale University, New Haven, CT, in 1991.

He was with Northrop Grumman for three years, where he designed and tested numerous gigahertz-speed superconductive circuits, including code generators and analog-to-digital converters. He also upgraded the simulation and layout capabilities at

Northrop Grumman to be among the world's best. He has also been a Postdoctoral Assistant with the State University of New York, Stony Brook, where he worked on the nanolithographic fabrication and study of Nb–AlOx–Nb junctions for single-electron and SFQ applications, single-electron transistors and arrays in Al–AlOx tunnel junctions, and the properties of ultrasmall Josephson junctions. Since 1999, he has been with the Quantum Voltage Project, National Institute of Standards and Technology, Boulder, CO, where he has developed novel superconducting circuits and broadband bias electronics for precision voltage waveform synthesis and programmable voltage standard systems.

Bryan C. Waltrip received the B.S. degree in electrical engineering and computer science from the University of Colorado, Boulder, in 1987 and the M.S. degree in electrical engineering from The Johns Hopkins University, Baltimore, MD, in 1998.

Since 1984, he has been an Electronics Engineer with the Electricity Division, National Institute of Standards and Technology, Gaithersburg, MD, where he is currently working on precision measurement systems in the areas of ac voltage, power, and impedance.

Tom L. Nelson, photograph and biography not available at the time of publication.