

PRELIMINARY DESIGN FEATURES OF THE RASCAL—A NASA/ARMY
ROTORCRAFT IN-FLIGHT SIMULATOR

Edwin W. Aiken* and Robert A. Jacobsen**
NASA Ames Research Center
Moffett Field, California

Michelle M. Eshow†
U.S. Army Aeroflightdynamics Directorate
Moffett Field, California

William S. Hindson‡ and Douglas H. Doane§
NASA Ames Research Center
Moffett Field, California

Abstract

Salient design features of a new NASA/Army research rotorcraft—the Rotorcraft-Aircrew Systems Concepts Airborne Laboratory (RASCAL)—are described. Using a UH-60A Black Hawk helicopter as a baseline vehicle, the RASCAL will be a flying laboratory capable of supporting the research requirements of major NASA and Army guidance, control, and display research programs. The paper describes the research facility requirements of these programs together with other critical constraints on the design of the research system, including safety-of-flight. Research program schedules demand a phased development approach, wherein specific research capability milestones are met and flight research projects are flown throughout the complete development cycle of the RASCAL. This development approach is summarized, and selected features of the research system are described. The research system includes a full-authority, programmable, fault-tolerant/fail-safe, fly-by-wire flight control system and a real-time obstacle detection and avoidance system which will generate low-altitude guidance commands to the pilot on a wide field-of-view, color helmet-mounted display.

*Chief, Flight Dynamics and Controls Branch. Member AIAA.

**RASCAL Project Manager, Aircraft Systems Branch. Member AIAA.

†Aerospace Engineer, Flight Control Branch. Member AIAA.

‡Research Pilot, Aircraft Operations Branch.

§Aerospace Engineer, Guidance and Navigation Branch.

This paper was originally presented at the AIAA/AHS Flight Simulation Technologies Conference, Aug 24-26, 1992, Hilton Head Island, SC.

Introduction

The preface to the proceedings from an International Symposium on "In-Flight Simulation for the 90's" held in Braunschweig, Germany, in July 1991 contains the following assessment of flight simulation:

Within the aerospace community, flight simulation has become virtually synonymous with the reproduction of the cockpit flight environment in a ground-based simulation facility. As this discipline has matured and assimilated the advances in digital processor and electronic imaging technologies, ground-based flight simulation has found its legitimate role in pilot-in-the-loop applications, both as a research and development tool and as a training aid. Nevertheless, ground-based flight simulation does have limitations related to the incomplete – and sometimes conflicting – nature of visual and motion cues which are presented to the pilot. As a result, in-flight simulation has played a unique role in aerospace research, development, and test pilot training by providing the proper environment and immersing the pilot in a real flight situation.

For rotorcraft, in-flight simulation is becoming increasingly important as fly-by-wire flight control technology is exploited and as autonomous systems are developed to relieve pilot workload, particularly during nap-of-the-Earth flight. In addition, the fidelity of aerodynamic modeling for rotorcraft is far from maturity, with the result that important handling and performance phenomena such as rotor wake interactions cannot be adequately simulated on the ground. This paper describes

the planned development and preliminary design features of a modern rotorcraft in-flight simulation facility—the Rotorcraft-Aircrew Systems Concepts Airborne Laboratory (RASCAL)—heavily influenced by the requirements of major NASA and Army rotorcraft guidance, control, and display research and development (R&D) programs at the Ames Research Center, Moffett Field, California.

As described in Ref. 1, the Army/Sikorsky UH-60A Black Hawk helicopter (Fig. 1) was determined to be the most appropriate available baseline vehicle for RASCAL development. In October of 1989, a UH-60A, originally used as the Army's Advanced Digital-Optical control System (ADOCS) demonstrator aircraft, was loaned to NASA-Ames Research Center by the U.S. Army, and the development of the RASCAL research facility was initiated.

The paper begins with a statement of the objective of the RASCAL development, including an overview of the research programs which will utilize its capabilities. These research requirements and other critical design constraints, including flight safety, are then summarized. The approach to be taken in the development of the RASCAL, which is also driven by the requirements of the flight research elements of the programs it will support, is then described. Finally, selected design features of the RASCAL Research Flight Control System are presented.

Project Objective and Research Requirements

The objective of the RASCAL facility development project is the design, development, integration, and testing of an airborne laboratory capable of supporting the flight research requirements of several major NASA and Army guidance, control, and display R&D programs. These programs are described in Ref. 1 and include the following:

1. Superaugmented Concepts for Agile Maneuvering Performance (SCAMP): Analysis, ground simulation, and flight research to investigate methods for the enhancement of rotorcraft maneuverability and agility through the application of advanced flight-control concepts
2. Automated Nap-of-the-Earth Flight (ANOE): Analysis, ground simulation, and flight research to develop low-altitude guidance algorithms and pilot's display laws for rotorcraft terrain-following/terrain-avoidance and obstacle avoidance
3. Rotorcraft Agility and Pilotage Improvement Demonstration (RAPID): In-flight validation and demonstration of ground simulation-derived solutions to selected Army-identified "technology barriers" to the development of next generation/future systems.



Fig. 1 Rotorcraft-Aircrew Systems Concepts Airborne Laboratory (RASCAL).

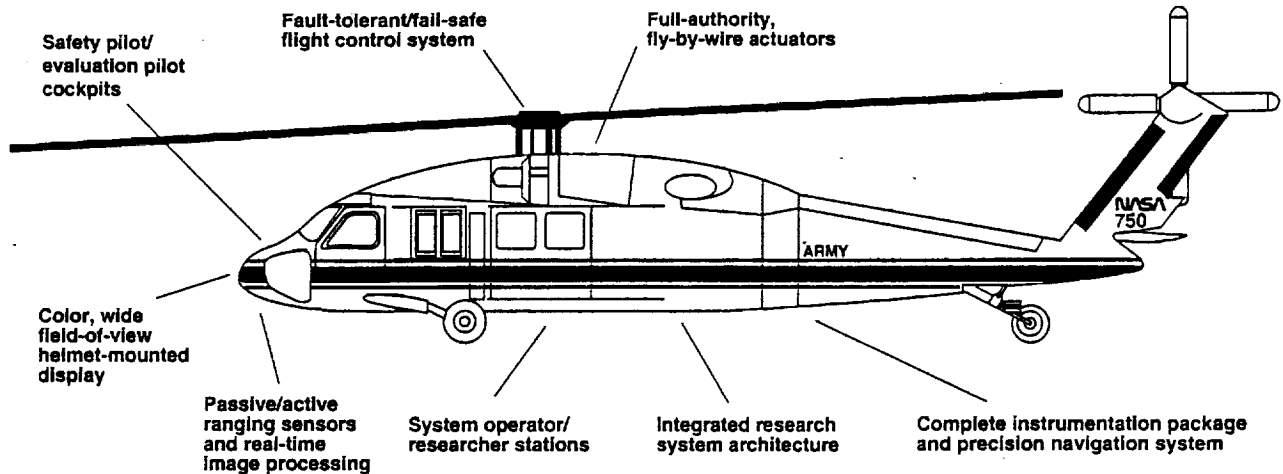

Fig. 2 RASCAL research system components.

To support the requirements of these R&D programs, the RASCAL research system will include the following (Fig. 2):

1. A high quality instrumentation, signal conditioning, and data acquisition system including rigid body, rotor state, and propulsion system sensors, suitable for both experimental data and flight control applications
2. A programmable, fly-by-wire research flight control system including high-performance actuators; a flight control computer, programmable in a higher-order language, with a hardware/software architecture necessary for the throughput and speed requirements of the various SCAMP control concepts; and a high-speed data bus with sufficient capacity for the anticipated bus traffic
3. The capability to evaluate both conventional controllers, using an artificial force-feel system, and integrated, multi-axis side-stick controllers
4. An in-flight researcher interface with the system for monitoring the experiments and for effecting configuration changes to allow productive use of the available flight time
5. An on-board precision navigation system suitable for low-altitude flight
6. Appropriate passive (e.g., TV or FLIR) and active (e.g., radar or laser) sensors for image-based guidance and navigation including obstacle detection/avoidance
7. On-board computational capability for real-time image processing, vehicle motion estimation, guidance algorithm generation, and pilot's display generation
8. Terrain data base storage for low-altitude navigation with no image sensor-aiding
9. A flexible, programmable pilot's display system including a panel-mounted display suitable for a digital map and a color, wide field-of-view, helmet-mounted presentation of flight status and command information and sensor-based imagery
10. A capability for the integration of autonomous guidance commands with the research flight control system

RASCAL Research System Design Requirements

An in-house preliminary design of the RASCAL research system was conducted during the summer and fall of 1991. The efforts of the preliminary design team included the establishment of prioritized design requirements for the research system. The top six of these requirements, in priority order, are:

1. **Flight Safety:** The RASCAL research system shall not degrade the flight safety reliability of the baseline Black Hawk helicopter.
2. **Performance:** The RASCAL research system shall have the capability to implement SCAMP high-bandwidth flight control laws, which include the use of rotor state feedback, and a real-time image processing,

guidance, and display system suitable for the ANOE program. The capability of the research flight control system shall be limited only by the performance of the basic UH-60A flight control system.

3. **Research Flight Envelope:** The RASCAL allowable research flight envelope shall be the Black Hawk flight envelope. No expansion of that flight envelope is required. Aggressive maneuvering while using the research system shall be conducted at altitude, clear of terrain and obstacles. Aggressiveness may be limited near the terrain and obstacles.

4. **Cost Constraints:** The RASCAL research system design must be compatible with the available funding from NASA, Army, and Federal Aviation Administration (FAA) sources.

5. **Research Productivity:** The RASCAL research system shall be designed with a high mission reliability and with the capability of obtaining a maximum number of research data points per flight hour.

6. **Schedule Constraints:** The RASCAL research system shall be developed in a manner that allows specific SCAMP, ANOE, and RAPID flight research experiments to be flown at intervals throughout the overall facility development period.

The milestones for RASCAL facility capability dictated by the requirements of the SCAMP, ANOE, and RAPID flight research experiments schedule are indicated in Fig. 3. These experiments are summarized as follows:

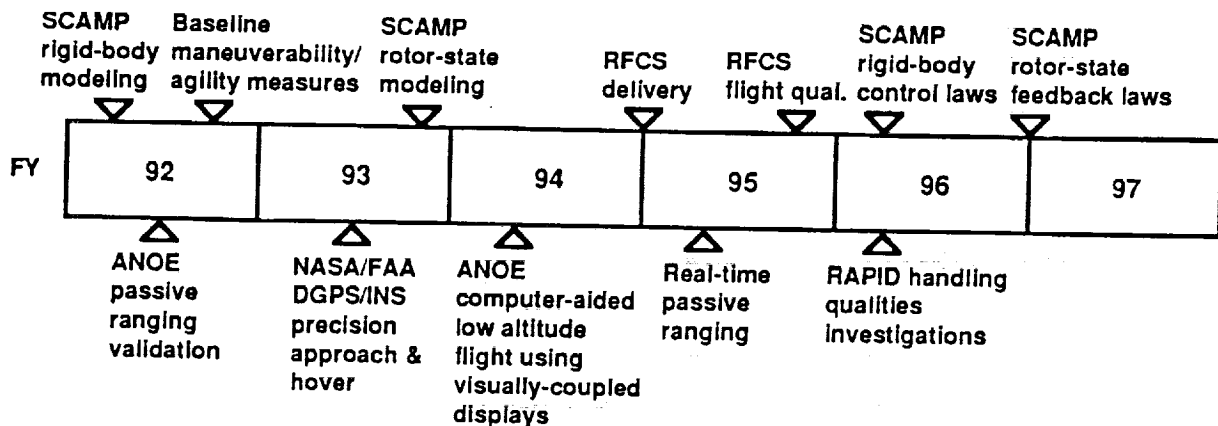

Fig. 3 RASCAL research facility capability milestones.

SCAMP and RAPID

Rigid-Body Modeling. Data acquisition to support the development and validation of rigid-body models suitable for use in SCAMP control law development

Baseline Maneuverability/Agility Measures. Development of relevant measures of rotorcraft maneuverability and agility and measurement of the maneuverability and agility characteristics of the basic Black Hawk

Rotor-state Modeling. Rotor state data acquisition to support the extension of the SCAMP rotorcraft models to include rotor system dynamics

Rigid-Body Flight Control Systems (FCS). Flight implementation and evaluation of SCAMP control laws involving the feedback and control of rigid-body states

Rotor-State Feedback FCS. Flight implementation and evaluation of SCAMP control laws which include the feedback and control of rotor states

ANOE

Passive Ranging Validation. Acquisition of airborne video imagery data from stereo TV cameras for off-line validation of range estimation algorithms

Differential Global Positioning System (DGPS)/ Inertial Navigation System (INS) Precision Approach and Hover. In-flight evaluations of the suitability of a DGPS/INS for helicopter terminal area operations under Instrument Meteorological Conditions

Computer-Aided Low-Altitude Flight Using Visually Coupled Displays. Flight evaluations of low-altitude guidance algorithms and the presentation of fused guidance symbology and sensor imagery on a color, wide field-of-view helmet-mounted display

Real-Time Passive Ranging. Flight evaluations and demonstrations of pilot aids for low-altitude flight including real-time obstacle detection and avoidance systems employing TV and FLIR sensors

The facility capability milestones established by the requirements of these experiments demand a phased approach to the development of the overall research capability of the RASCAL.

RASCAL Research System Development Program

Research program requirements dictate that RASCAL flight test programs be conducted at several stages throughout the development of the RASCAL as a research facility. The research system that is to be installed on the RASCAL must meet the research objectives of these programs in a timely manner. A phased development program has been defined to provide a system that can support research activities at several stages as the system is developed. The functional capability that is imple-

mented at any phase of the development program to meet the immediate research goals is maintained and adds to the overall facility capability. This additive approach results in a system that, upon completion, will have more integrated capability than any of the individual research programs presently require. Future research programs will have the full integrated capability available for the conduct of flight test programs.

A critical element of this approach to the development of the RASCAL is that the system development risks must be minimized. This constraint requires that the facility be developed using state-of-the-art, but proven, technology. Care will be taken to severely limit technology development requirements in specifying the RASCAL Research System.

The research programmatic milestones identified for the RASCAL and presented in Fig. 3 have been grouped into four development phases as indicated in Fig. 4. Each of these four phases results in the accomplishment of specific, reportable research goals. The system requirements for each of the phases is presented below.

Phase 1. Measurement and documentation of the basic UH-60A dynamics and controls characteristics are to be accomplished, thereby providing a baseline against which future improvements in maneuverability and agility can be judged. Acquisition of stereo video data for post-flight processing will be accomplished, allowing the validation of passive ranging algorithms.

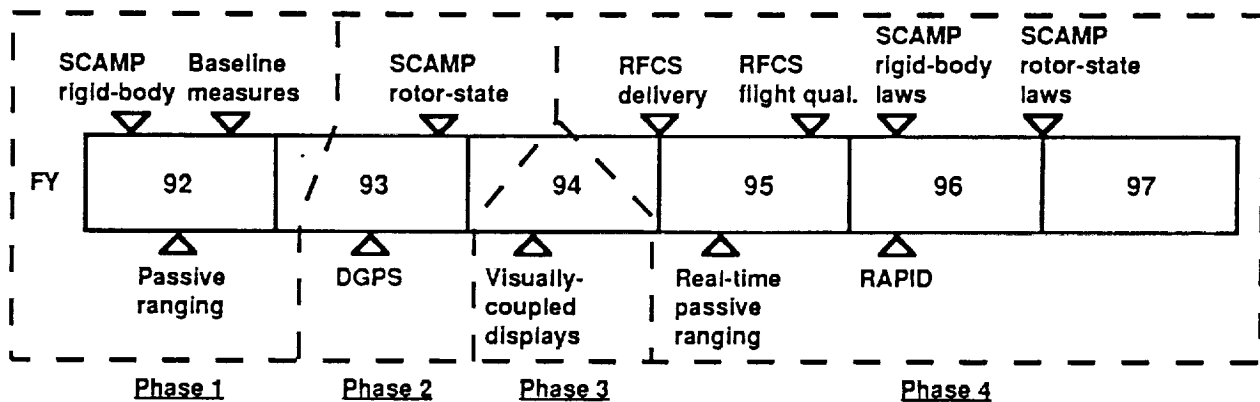

Fig. 4 RASCAL facility development phases.

Phase 2. The additional capability of acquiring and documenting rotor state measurements will complete the UH-60A baseline identification. Differential Global Positioning System (DGPS) position measurement capability will allow the development of guidance/display laws for precision approach and hover.

Phase 3. A wide-field-of-view, color, helmet-mounted display will add the capability to provide enhanced guidance information to the pilot, allowing the development of display laws to assist in the ability to conduct missions in an NOE environment.

Phase 4. A full-authority, fly-by-wire research flight control system will allow development and demonstration of control laws that more fully utilize the maneuverability and agility capabilities of the UH-60A. Real-time processing of the stereo video data on board the RASCAL will allow the presentation of obstacle ranging information and sensor/computer-aided guidance commands to the pilot.

System architectures have been established for each of the phases of the RASCAL development program that allow the additional capabilities to add to the overall system capability. The specific research requirements of each phase are met by this approach while the facility capability is always increased. This approach will be beneficial as new research programs are defined and the full capability of the RASCAL can be utilized.

Phase 1

The architecture for the RASCAL Phase 1 Research System is shown in Fig. 5. The central element of the research system for Phase 1 is the data acquisition computer, which uses an Intel 80486 processor. Analog sensors provide control position and a limited set of body state measurements. A Litton LN-93 Inertial Navigation Unit (INU) is installed to measure body attitudes and angular rates, and linear velocities and accelerations. Communication between the INU and the data acquisition computer is provided by a Mil-Std-1553B bus. A GEC Marconi HADS Air Data Computer that had been installed on the aircraft previously has been incorporated to provide low airspeed and local flow angle information.

A pair of high resolution video cameras is mounted on the nose of the RASCAL to provide data for the post-flight validation of passive ranging algorithms. The video data are time-correlated with the aircraft state data and processed post-flight. Provisions are incorporated to replace the video cameras with a FLIR installation. An

experimenter's station is installed in the cabin allowing convenient control of the video and data systems.

Phase 2

Additional components added to the Phase 1 RASCAL system architecture will allow the research goals of Phase 2 to be accomplished. The resulting architecture is shown in Fig. 6. The basic data acquisition capability installed for Phase 1 will remain, with additional sensors installed to provide rotor state information. A guidance/navigation computer will be added to perform the guidance and navigation law computations. To provide guidance information to the pilot, a panel-mounted display will be installed and driven by the guidance/navigation computer. A DGPS that communicates directly with the guidance/navigation computer through a digital bus will be included. An uplink data stream from a ground-based GPS is required to provide the differential corrections to the airborne unit.

A research system operator's station will be implemented in the forward area of the RASCAL cabin for control of the research system. An experiment support/observer's station will be installed in the aft cabin to accommodate a second researcher or to provide for an observer during flight test operations.

Phase 3

The most significant addition to the RASCAL research system architecture to accommodate the low-altitude guidance research goals for Phase 3 will be the addition of a wide-field-of-view, multi-color helmet-mounted display system as shown in Fig. 7. Included will be the helmet, incorporating the display capability, a programmable display generator and a head tracker system. A second Mil-Std-1553B bus is anticipated to provide the data communications required to process guidance and navigation laws and to pass that information to the helmet. Additionally, that information must be recorded by the data acquisition system for post-flight processing.

Provisions for the acquisition of additional data regarding propulsion system performance will be added during this phase. Truth data for evaluation of the guidance system performance will be provided by uplinking data from the laser tracking system that Ames operates at its Crows Landing flight test facility.

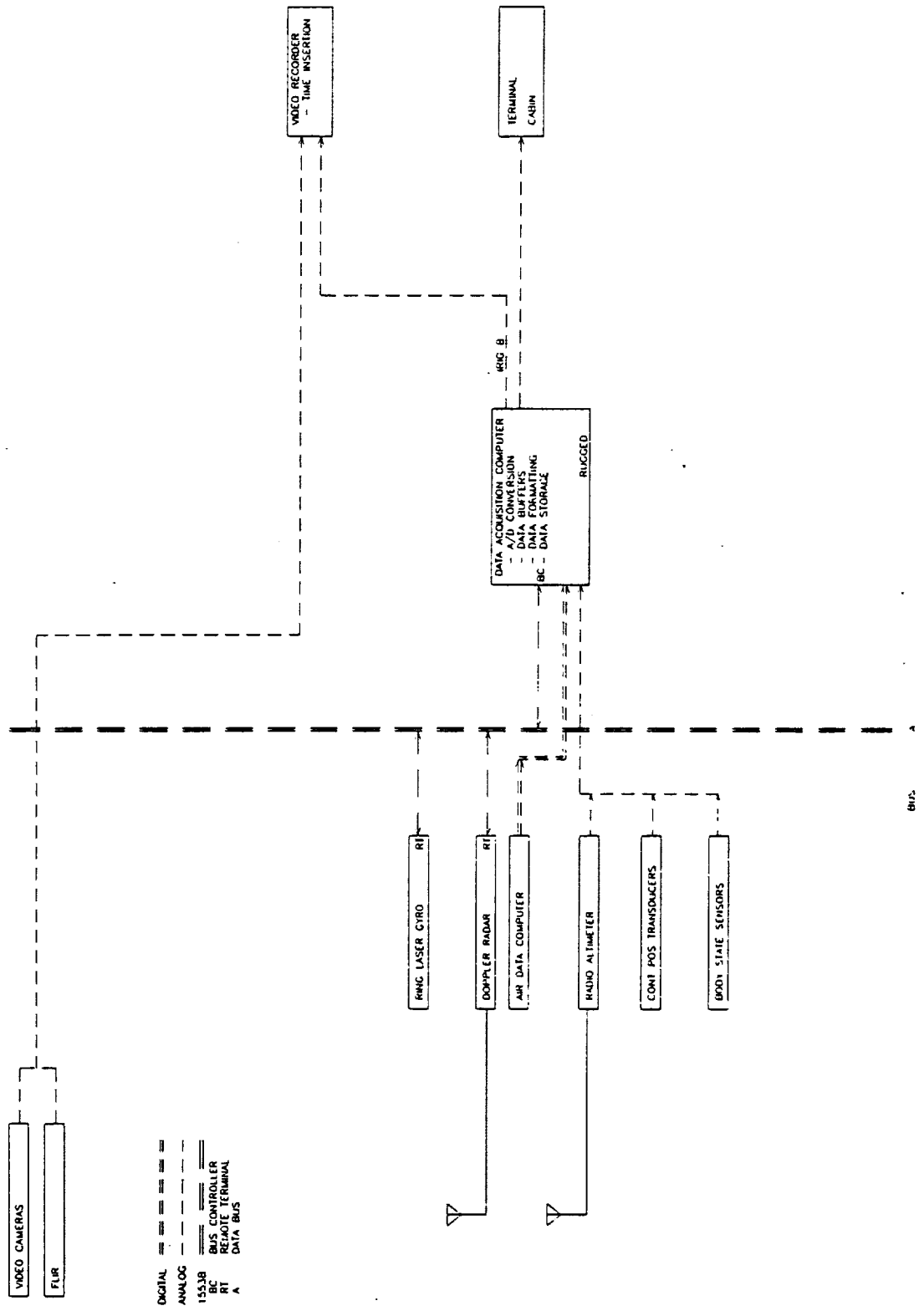

Fig 5 RASCAL Phase I architecture.

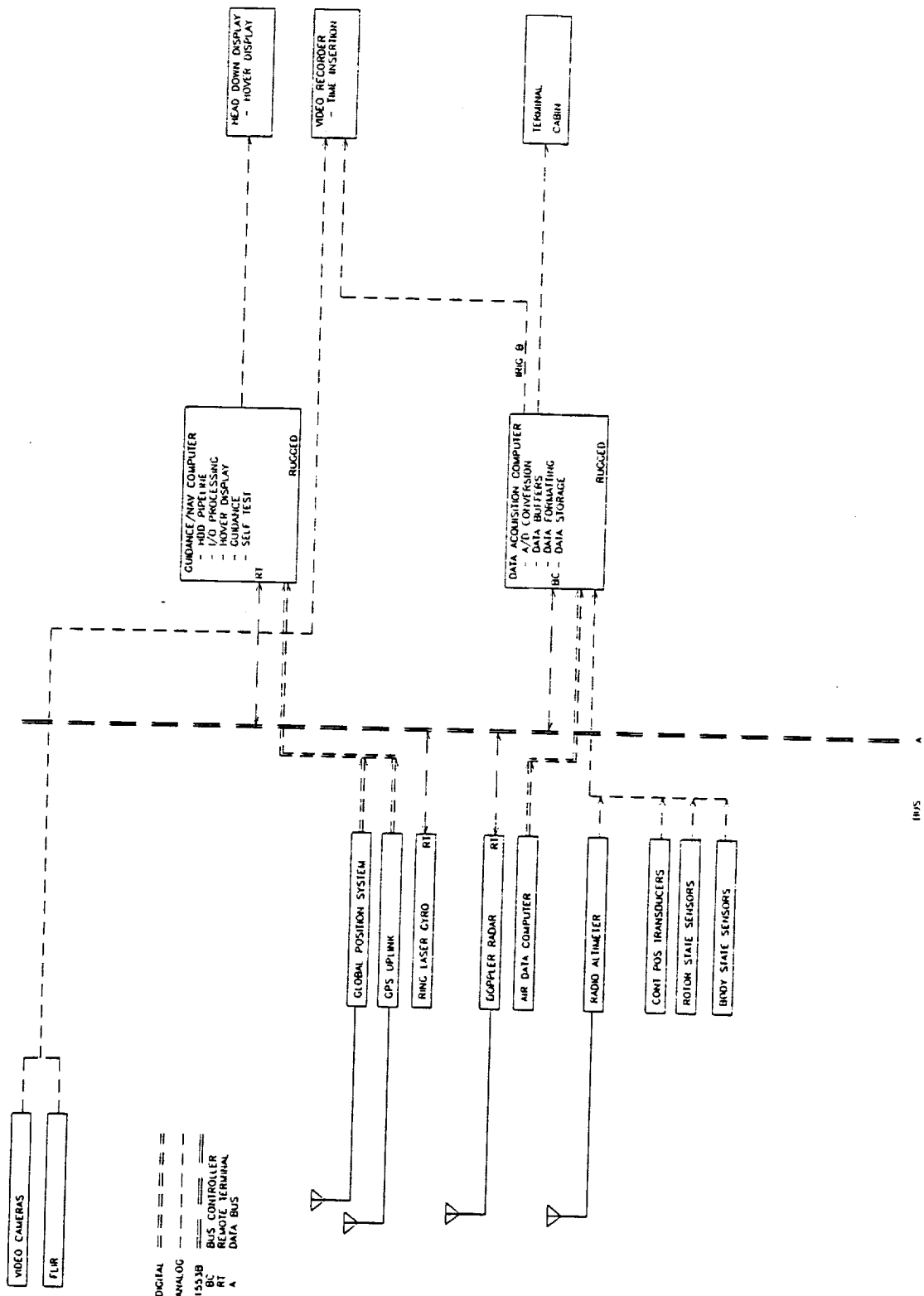

Fig. 6 RASCAL Phase 2 architecture.

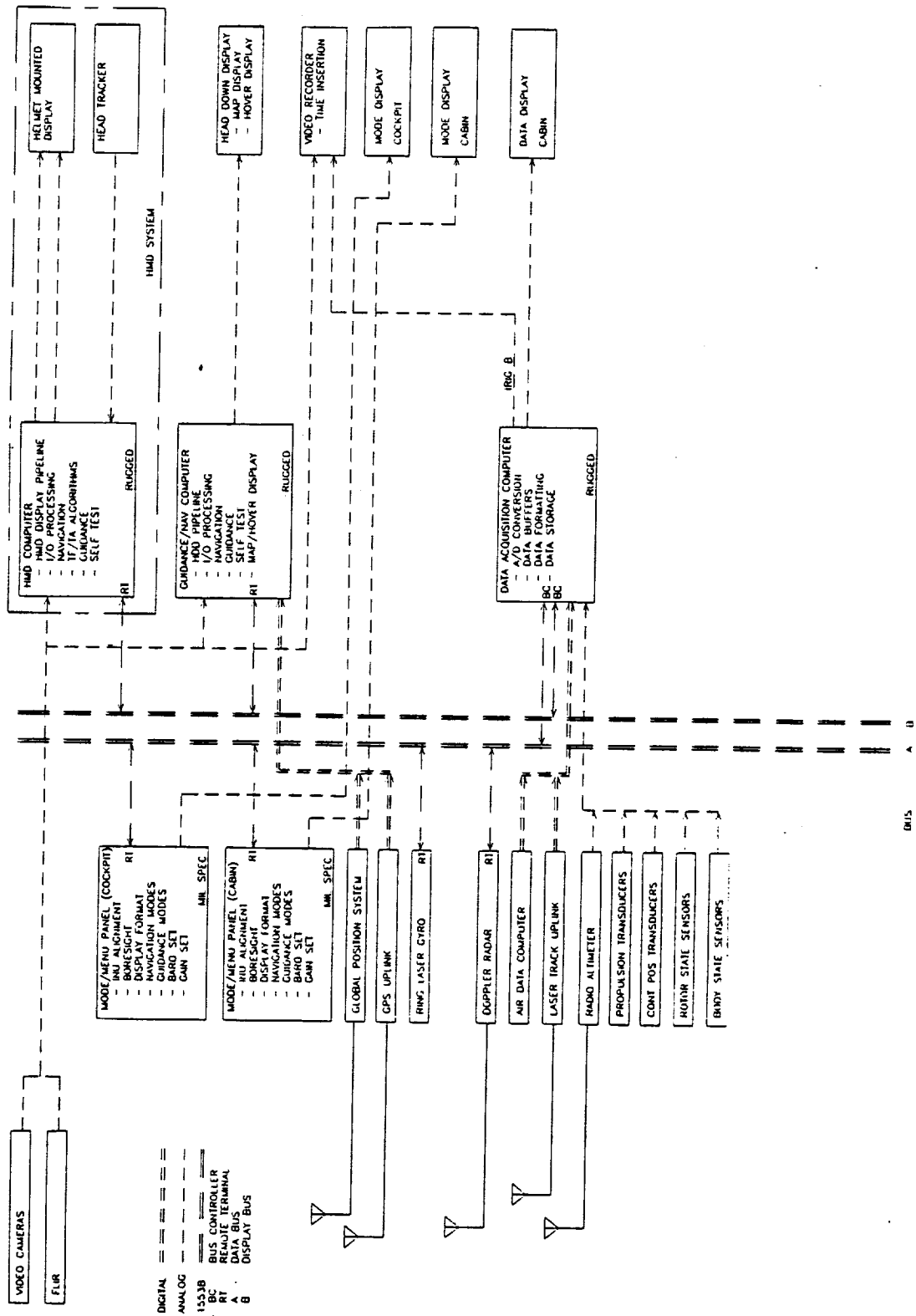

Fig. 7 RASCAL Phase 3 architecture.

The research system will be, by this phase of development, sufficiently complex to require the incorporation of mode control capability. The mode-menu panels will be used by the evaluation pilot to select guidance and display modes and by the researcher/system operator to centrally control and monitor the research system components and to vary experiment parameters during the flight test. Control/display units will be installed in the cockpit and at the research operator's station to provide this interaction with the research system, which will be accomplished using the Mil-Std-1553B bus.

Phase 4

Two major system installations will be added to the research system to accomplish the research goals for Phase 4. The completion of this phase defines the final system architecture as shown in Fig. 8.

The first of these major installations is a real-time image processor for the passive video ranging system. This unit will process the video signals to extract ranging information and provide it to the guidance/navigation computer. Obstacle avoidance information generated by the guidance/navigation computer will be displayed to the pilot. A high-speed digital bus will be used to communicate the information among the image processor, the guidance/navigation computer, and the helmet-mounted display system.

The second major addition to the RASCAL research system in Phase 4 is the fly-by-wire research flight control system (RFCS). This installation provides the RASCAL with its full in-flight simulator capability. An "evaluation pilot's" station will be implemented by mechanically disconnecting the controls at the right crew station and installing new controls that electrically signal the RFCS. The RFCS will be a full-authority flight control system incorporating the functional components shown in the lower right section of Fig. 8; it is described in the next section.

On-board data analysis capability will be provided by the data analysis computer, which will be capable of real-time data display and post-run data analysis for use by the on-board researcher. A rearrangement of the Mil-Std-1553B buses may be required to accommodate the increased data flow requirements. Telemetry capability will be provided to allow the acquired data to be displayed and recorded on the ground at Ames' flight test facilities.

During Phases 3 and 4, a ground development facility will be built up to support the on-board systems development. A combination of actual and emulated flight hardware will be employed to support hardware flight qualification and subsystems integration and software validation and verification. Inclusion of a simplified fixed-base simulation capability will allow pilot-in-the-loop testing and will support experiment development and pre-flight training activities.

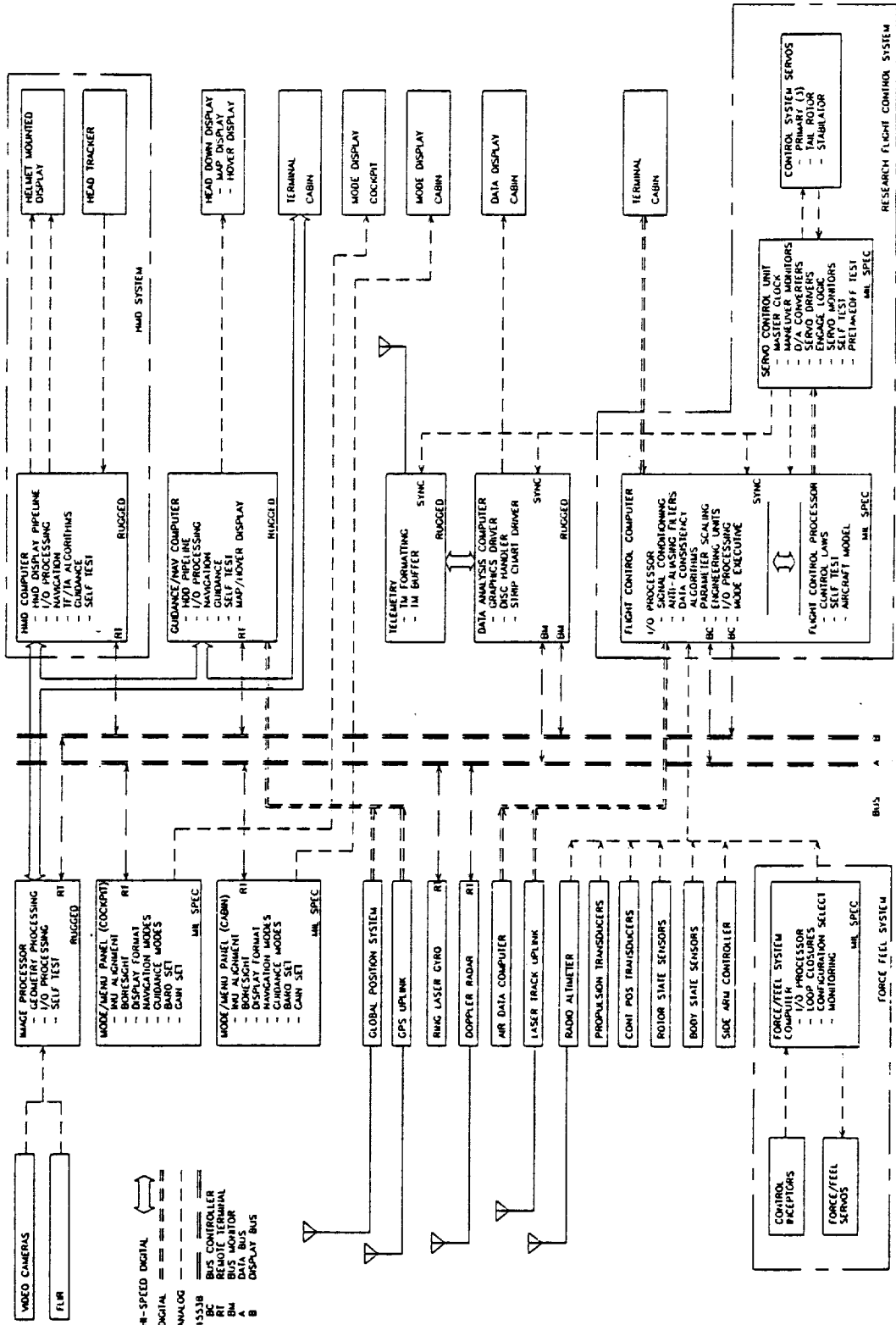

Fig. 8 RASCAL Phase 4 architecture.

Research Flight Control System Requirements and Design Features

The RASCAL RFCS comprises those elements of the research system necessary to achieve full-authority, fly-by-wire flight control by the evaluation pilot. The elements include control inceptors, sensors, a flight control computer, a servo control unit, and research servo-actuators, as illustrated in Fig. 9. Because it is the largest single RASCAL subsystem and because of its flight critical nature, special attention is given in this section to describing the RFCS flight safety issues, performance requirements, and component functional requirements.

Safety and Reliability Requirements

The basic design philosophy of the RFCS is fail-safe. On detection of a system fault, the RFCS reverts to a disengaged condition allowing the safety pilot to resume control of the aircraft using the existing mechanical flight control system of the UH-60A. Preferably, the fault is recognized and the RFCS disengaged without any significant control transient, characteristics that are often described as fail-soft or fail-passive. The research flight envelope, especially the allowable aggressiveness near the ground or obstacles, is directly impacted by the expected magnitude of these fault recognition and system disengagement transients.

Most system faults that do not pose an immediate or severe threat to the aircraft can be recognized and acted

upon by the safety pilot who is directly and continuously monitoring the action of the basic UH-60A pilot controls. However, the faults that would result in a hardover control transient must be detected very quickly by automatic monitors. Furthermore, control transients associated with detection and isolation of these faults must be small enough to permit the safety pilot to safely regain control even when operating near the ground or among obstacles. Consequently, the most stringent requirement for RFCS system flight-safety reliability is focused on two essential functions:

1. The ability to disengage when required, whether initiated by the automatic safety monitoring system, the safety pilot, or the evaluation pilot
2. The immediate detection, typically within 100 msec, of component failures or software errors that would otherwise lead to unacceptably large and rapid control transients

The performance and response time requirements for these automatic monitors have been established in piloted simulations. The reliability of these safety-critical functions must be such that the probability that they will fail to operate as designed is extremely remote, less than one in 10^7 flight hours. The quantitative basis of this requirement lies in an assumed 1000 flight-hour operating life of RASCAL, to which standard protection from potentially catastrophic failures has been applied.

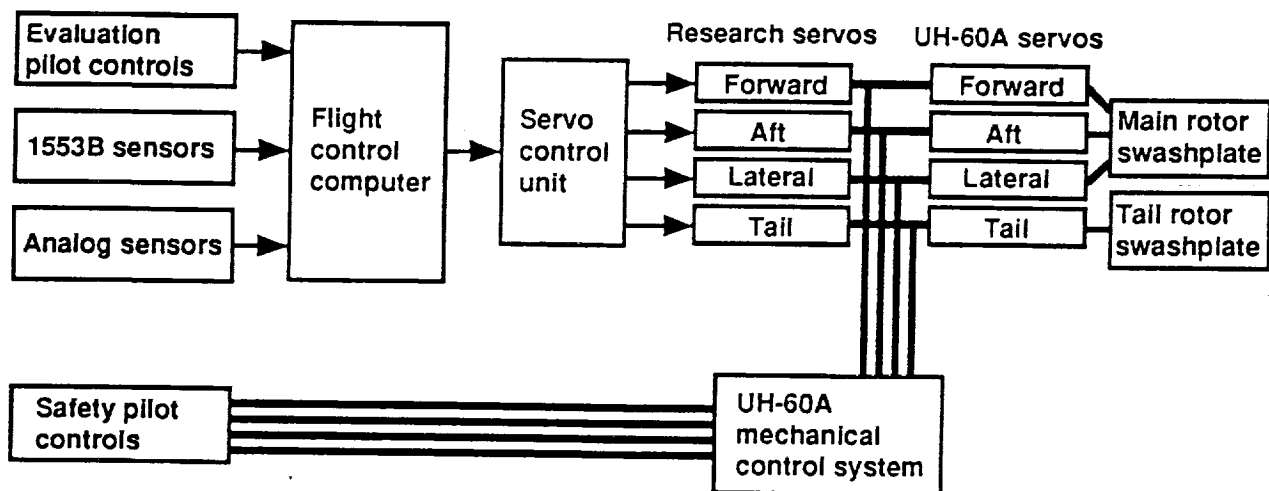

Fig. 9 RFCS components and aircraft interface.

For system disengagement, this level of reliability can be achieved with state-of-the-art components and techniques that will assure that the RFCS servos can be hydraulically bypassed. Force-override features such as shear pins may also be included for added safety. Detection of component failures associated with the actuation loop itself is similarly straightforward, with good assurance that detection and isolation will be fast enough to result in insignificant control transients. Nevertheless, achieving these functions to the level of reliability that is required will undoubtedly entail some level of redundancy of hydraulic system components and servo control hardware.

Achieving high reliability in the passive detection and isolation of hardover commands that may be generated within the RFCS is a more difficult problem, particularly as it is intended that the aircraft be flown aggressively through the fly-by-wire system so that large command signals may be the norm. Component redundancy with cross-channel comparison could be used to quickly detect system hardware faults. However, this method of fault detection increases system complexity and is subject to nuisance trips, especially if only two channels are employed. It is essential that an appropriate balance be struck between system complexity in the form of dual or triplex systems and the impact of nuisance trips and system maintainability on research productivity.

To provide protection from software errors using a redundant design approach, independent software specifications and implementations would be required. Although software is the most frequent source of control system transients in a research facility of this type, the prospect of generating wholly dissimilar software or implementing cumbersome validation and verification procedures is distinctly unattractive.

A preferred approach to fault detection is to monitor the character of the command signals to the RFCS servos, with the objective of identifying commands of unacceptable magnitude, regardless of their source. This has been the general technique employed for this type of research facility in the past, for example, in the CH-47B variable stability helicopter.² In practice, it may be more effective to detect these large commands by examining the character of the error signal within the actuator loop itself. This approach has the advantage of diminishing the requirement for component and software redundancy, but it has less potential to provide as effective transient suppression. This relatively simple approach permits location of these monitors in a dedicated, protected, and hence more reliable area of the RFCS, removed from ever-changing research software. However, without additional intelli-

gence, this monitor concept is unable to differentiate between large commands generated intentionally by the evaluation pilot and actual system faults. Hence it is susceptible to nuisance trips that would result from aggressive maneuvering. In addition, whatever the design details of the fault detection monitors, redundant implementations may be required to achieve the necessary functional reliability.

In light of these considerations, a question remains whether the maneuvering flight envelope achievable with the fail/safe RFCS/aircraft system is consistent with the research program requirements. The SCAMP objective of developing and evaluating control laws designed using advanced methodologies can be met with aggressive maneuvering away from obstacles or the ground and with reduced aggressiveness near obstacles. The RAPID program embodies a more traditional in-flight simulation role and in addition is intimately tied to the ADS-33C handling qualities specification.³ Section 4 of ADS-33C requires very aggressive maneuvering at low altitudes to demonstrate specification compliance, for example, an acceleration/deceleration with pitch attitudes in excess of 30 degrees performed at altitudes of 50 ft above ground level or lower. It is desired to achieve these maneuver objectives with the RASCAL RFCS. However, it is not yet clear whether the fail/safe architecture, which is highly desirable from a cost, complexity, and research productivity standpoint, will permit very aggressive maneuvering near terrain and obstacles.

System Performance Requirements

To meet the high-bandwidth flight control performance goals of the SCAMP and RAPID programs, it is well understood that the RFCS design must minimize the delay contributed by each component versus a total time delay budget and the nonlinearities introduced into the control path by rate limits and hysteresis.

The time delay budget was arrived at using, as a baseline, the ADOCS case study performed by Tischler⁴ and the RASCAL preliminary design study described in Ref. 5. The Ref. 4 study found that the ADOCS forward loop equivalent delays from pilot input to aircraft response was over 240 msec. This delay was thought to be the source of the handling qualities shortcomings that became apparent in the vehicle during high-precision, high-gain pilot tasks.⁴ The goal for the RASCAL budget was to reduce the total delay by 50% to roughly 120 msec, which is below the critical point of handling qualities degradation according to fixed-wing experiments.⁶ Further reduction is not feasible because a significant

portion of the delay arises from the UH-60A main rotor and primary servo-actuators, which will not be modified.

Table 1 shows the component breakdown of forward loop equivalent delays for the pitch axis for ADOCS (from Ref. 4) and the goal for RASCAL for centerstick and sidestick configurations. The major areas of improvement for RASCAL are a reduction in the computation frame to 10 msec and improved research servo performance leading to an approximation of 10 msec of delay. This equates to a second-order servo response natural frequency of 22 Hz.

Table 1 Comparison of ADOCS and RASCAL component equivalent delays, pitch axis

Element	ADOCS delay, ms	RASCAL goal, ms
Main rotor	66	66
UH-60A primary servos	24	24
Research servos	26	10
Zero-order hold	17	5
Computations	22	5
Stick sampling skew	<u>17</u>	<u>5</u>
Total delay, centerstick	n/a	115
Sidestick notch filter	40	30
Sidestick biodynamic filter	<u>32</u>	<u>10</u>
Total delay, sidestick	244	155

Regarding nonlinearities, SCAMP control laws will require the maximum amount of precision attainable with the UH-60A. Concern about the impact of hysteresis in the UH-60A control linkages led to requiring that the research servos be mounted at the input to the UH-60A primary servos, rather than near the safety pilot. This is especially crucial for the tail rotor servo, which will be mounted in the vertical tail at the UH-60A tail servo input linkage to avoid the compliance of the tail rotor cable and lost motion in the mechanical linkages. It is recognized that these locations cause the hysteresis to be present in the safety pilot's backdriven controls; however, piloted simulation studies have indicated that this loss of precision is not a critical factor.

The major source of nonlinearity remaining is the rate limit of the servos. The UH-60A primary servos have a rate limit of 100%/sec which, due to the linkage gains and mechanical mixing box, lead to higher and nonuniform rate limits of the cockpit controls. There is no advantage

to driving the servos beyond their rate limit, so the research servos will have the same rate capability. The maximum sine wave input amplitude that a servo will respond to linearly is equal to the servo maximum rate divided by the input frequency. For example, at the 1/rev frequency of 27 rad/sec, the servos can respond linearly to inputs of up to $\pm 3.7\%$. At the pilot controls, this corresponds to between ± 0.3 and ± 1.3 inches depending on the control axis. The SCAMP control designs have considered this limitation. To date the rate limit does not appear to be a major impediment during aggressive maneuvering even with rotor state feedback.

Component Functional and Performance Requirements

This section describes the requirements of the components of the RFCS (Fig. 9) that derive from the safety and performance considerations just described. Depending on the design selected to meet the fail/safe requirements and associated reliability goals, the system architecture may incorporate redundancy of some or all components. However, because the redundancy and redundancy management features are not yet well defined for the RFCS, they are not addressed in this paper.

Sensors. The primary sensors for the RFCS are indicated in Fig. 8. Of particular interest is that, as part of the SCAMP program, a major effort will be undertaken to measure rotor states. Current plans call for use of rotary variable differential transformers (RVDTs) at the blade roots to sense blade flap, lag, and pitch. Optical methods of sensing these angles are also being investigated. In addition, it is planned to mount pairs of linear accelerometers on each blade to obtain duplicate measures of flap, lag, and pitch and possibly their rates using the state estimation methods described in Ref. 7. These signals will be transmitted or routed through slip rings for processing in the on-board computers.

Controls. The first set of pilot controllers will likely consist of a multi-axis sidestick controller on the evaluation pilot's right with a collective lever on the left. Optional spring-loaded pedals will likely be included. Ultimately, it is planned to have in addition a conventional centerstick, pedals, and collective driven by a fully programmable force-feel system.

Flight Control Computer. The flight control computer (FCC) will contain signal conditioning, bus control, signal processing, and control laws. The internal architecture of the FCC has not yet been determined, especially with regard to the number of processors

required. However, it is a requirement that the FCC as a whole be able to perform extensive analog and digital signal processing as described below. Apart from input/output processing, it is estimated that the processor(s) used for the control law computations will need to have 32-bit, floating point architecture and be capable of 16 million instructions per second (MIPS) or 6 million floating point operations per second (MFLOPS). The FCC will have a large memory requirement, on the order of 4 Mbytes, to accommodate future growth and to permit loading several sets of control law applications code from different experiments to allow maximum flight test flexibility.

The FCC will communicate with the other sub-systems via Mil-Std-1553B data buses (Fig. 8). Those systems include the 1553B-based sensors, the cockpit and cabin mode-menu computers, the guidance and navigation system, and the data acquisition and analysis system. The number and arrangement of buses required for these interactions are being determined based on estimates of projected loading, traded off against hardware and software requirements and compatibility with the phased research system development.

There is a requirement for extensive analog input into the FCC to accommodate the analog sensors. Many of the signals will be used for flight control, while others will be converted to 1553B format and sent on to the data analysis computer or telemetry system for recording. All the analog signals will be anti-alias filtered at a single frequency. A digital processor will then be used as required for lower-frequency filtering of both the analog and 1553B-based sensor signals using low-pass or notch filters. The advantage of this approach is to permit flexibility in changing filter complexity and characteristics while retaining a single hardware configuration. It is expected that for control applications the highest frequency of interest is at 2/rev, or 8.6 Hz, while for parameter identification activities higher frequencies will be desired.

A real-time operating system or real-time executive will be employed for program execution. A high-order language will be used for control law and signal processing applications. Depending on software tools that are available, the language will be either C or Ada. A commercial, workstation-based, software development environment will likely be employed, with appropriate cross-compilers and a complete window-oriented symbolic debugging capability. The real-time shell, including software to drive all of the input/output devices, will be developed such that new signal processing and control law modules can be easily integrated. The project

teams will develop the signal processing and control law applications software using a structured design approach similar to that used for the Ames V/STOL Systems Research Aircraft (VSRA) program.⁸

Servo Control Unit. The servo control unit (SCU) will receive, process, and monitor control commands from the FCC. It will contain servo loop closure electronics, control engagement and disengagement of the RFCS, and provide fault detection and isolation logic. These SCU functions are considered flight-safety critical and must meet the 10^{-7} failures/flight hour reliability requirement discussed above.

The SCU will receive servo position commands from the FCC that will be appropriately processed and will become the commands to the RFCS servos' electro-hydraulic valves. The servo loops will be analog, and linear variable differential transformers (LVDTs) will be used for the servo ram position feedback. Each element of the servo loop will be monitored; for example, by using the actual ram position versus one predicted by a low-order model. In addition, the servo motions will be monitored for "reasonableness" to assure that the SCU has not received a hardover or slowover command from an upstream component such as the FCC. The requirements for these command monitors have been established in piloted simulations that defined the maximum servo motion that can be tolerated before the monitor disengages the RFCS. The monitor thresholds will have some selectability to account for different flight environments and task aggressiveness levels.

When any of these monitors detects a failure, the RFCS will be disengaged by bypassing and depressurizing the RFCS servos. The bypass functions may be redundant if necessary to assure proper disengagement. Disengagement will also be effected via failure discretes to the SCU from all upstream monitors, for example the FCC watchdog timer. Finally, both the safety and evaluation pilots will be able to command disengagement via switches mounted on their controls. Unique aural tones will accompany RFCS engagement and disengagement.

Research Servos. As discussed previously, the research servos will be mounted at the inputs to each of the UH-60A primary swashplate and tail rotor servos and will provide full-authority control of those servos. Their performance will be consistent with the 10 msec time delay and 100%/sec rate limit discussed above. The servos will be electrically signaled hydraulic actuators mounted in parallel with the UH-60A mechanical flight control system so that their motions are reflected, via movement of the mechanical linkages, back to the safety

pilot's cockpit controls. The detail designs of the research servos' hydraulic and mechanical interfaces to the UH-60A will be modeled on those used successfully for ADOCS.⁹ At the same time, lessons learned in the ADOCS program will be used to improve the design for RASCAL. For example, the RASCAL servo rams will be balanced or semi-balanced to provide the same response in both directions.

Concluding Remarks

Since the first in-flight simulator was developed in 1947 at what was to become NASA Ames Research Center, these devices have been successfully applied to all aspects of the aircraft development process. The RASCAL represents the latest in a series of helicopter in-flight simulators that began in the late 1950s with the Princeton University variable stability HUP-1, used as a research tool to generate roll and yaw handling qualities requirements. The RASCAL is being developed as much more than a handling qualities research tool and will be capable of supporting major NASA, Army, and FAA research programs in integrated guidance, control, and display systems for rotorcraft. A fundamental requirement for these programs is that both ground- and in-flight simulation be applied in a complementary fashion to ensure the completeness and accuracy of the results.

References

¹Aiken, E. W., Hindson, W. S., Lebacqz, J. V., Denery, D. G., and Eshow, M. M., "Rotorcraft In-Flight Simulation at NASA Ames Research Center: A Review of the 80's and Plans for the 90's," International Symposium on In-Flight Simulation for the 90's, Braunschweig, Germany, July 1-3, 1991 (NASA TM-103873, Aug. 1991).

²Kelly, J. R. et al., "Description of the VTOL Approach and Landing Technology (VALT) CH-47 Research System," NASA TP-1436, Aug. 1979.

³*Handling Qualities Requirements for Military Rotorcraft*, U.S. Army AVSCOM Aeronautical Design Standard ADS-33C, St. Louis, MO, Aug. 1989.

⁴Tischler, M. B., "Assessment of Digital Flight Control Technology for Advanced Combat Rotorcraft," *Journal of the American Helicopter Society*, Vol. 34, No. 4, 1989.

⁵Deazley, W. R., "UH-60 RASCAL Variable Stability System Configuration Study," Calspan Final Report No. 7738-3, Feb. 1991.

⁶Smith, R. E. and Sarrafan, S. K., "Effect of Time Delay on Flying Qualities: An Update," *Journal of Guidance, Control, and Dynamics*, Vol. 9, No. 5, 1986.

⁷McKillip, R. A., Jr., "Kinematic Observers for Active Control of Helicopter Rotor Vibration," Paper No. 65, Twelfth European Rotorcraft Forum, Gramisch-Partenkirchen, Germany, Sept. 1986.

⁸Foster, J. D., Moralez III, E., Franklin, J. A., and Schroeder, J. A., "Integrated Control and Display Research for Transition and Vertical Flight on the NASA V/STOL Research Aircraft (VSRA)," NASA TM-100029, Oct. 1987.

⁹Dones, F. D., and Glusman, S. I. et al., "Advanced Digital/Optical Control System Final Technical Report, Volume 2 - Systems Engineering," AATD Report No. D358-10055-2, Applied Aviation Technology Directorate/Boeing Helicopters, Dec. 1989.

List of Attendees

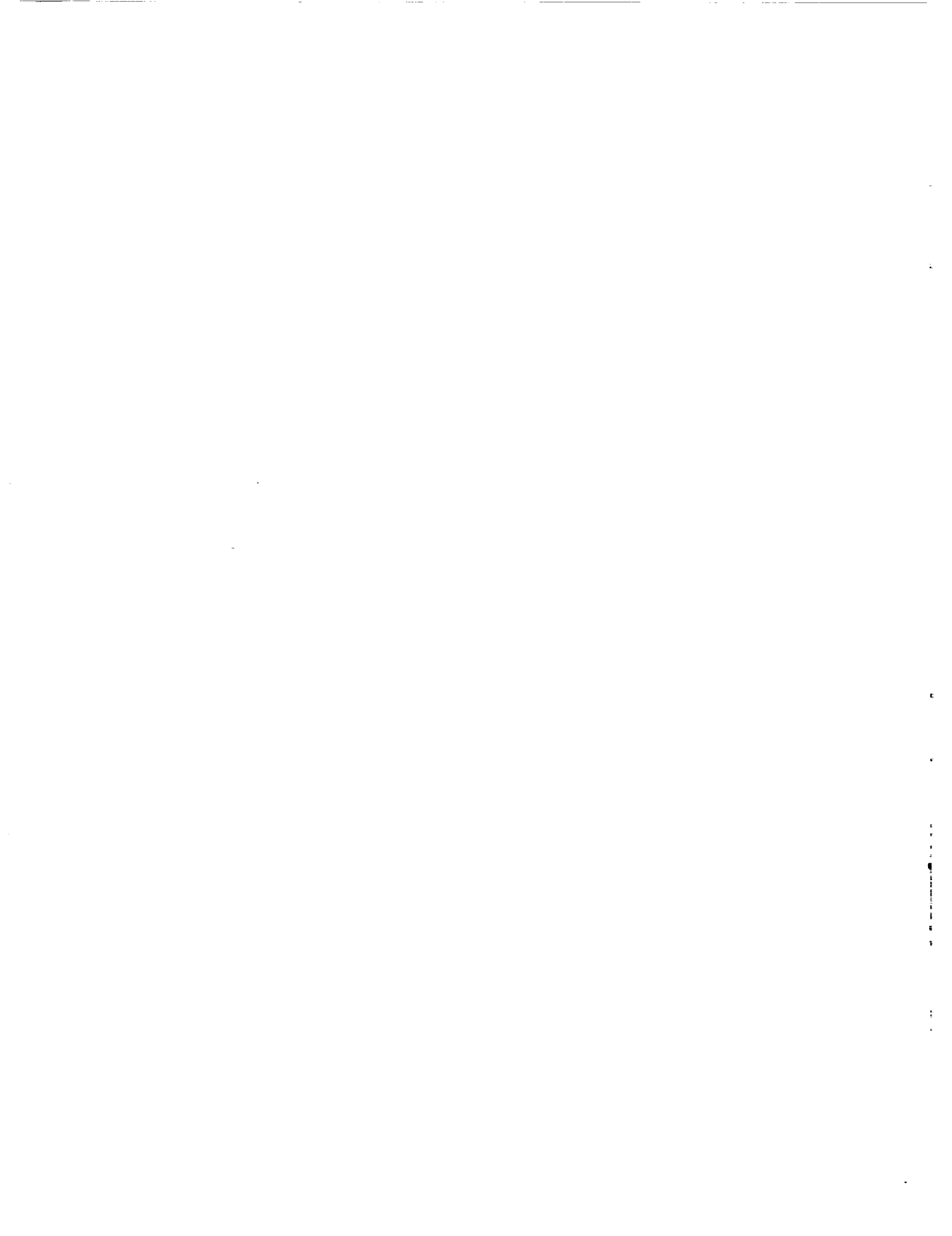

LIST OF ATTENDEES

Theodore B. Aldrith

Sikorsky Aircraft

Sikorsky Aircraft
6900 Main St.
Stratford, CT
06601-1381
(203) 386-5834

Anthony D. Andre

West. Aero. Lab

MS 262-3
NASA Ames Research Center
Moffett Field, CA
94035-1000
(415) 604-3665

Harold Andrews

Starmark Corp.

3800 No. Fairfax Dr. #102
Arlington, VA
22203-1703
(703) 528-1552

Adolph Atencio

U.S. Army AFDD

U.S. Army Aeroflightdynamics Directorate
MS 210-7
NASA-Ames Research Center
Moffett Field, CA
94035-1000
(415) 604-6863

Stuart Atkins

Piasecki Aircraft Corp.

Piasecki Aircraft Corp.
West End of Second Street
Essington, PA
19029
(215) 521-5700

Stewart W. Baillie

NRC Flight Res. Lab.

National Research Council Flight Research Laboratory
Uplands Bldg. U-61
Ottawa, Ontario
KEY-0R6
Canada
(613) 998-3790

Dwight L. Balough

Flight Experiments Branch

MS 237-5
NASA Ames Research Center
Moffett Field, CA
94035-1000
(415) 604-3152

Lourdes G. Birckelbaw

STOVL/Powered-Lift Tech. Br.

MS 237-3
NASA Ames Research Center
Moffett Field, CA
94035-1000
(415) 604-5592

Bob Blake

Sikorsky Aircraft Div., UTC

Sikorsky Aircraft
120 Winter Club Court
P.B.G, FL
33410
(407) 775-5298

Chris Blanken

U.S. Army AFDD

U.S. Army Aeroflightdynamics Directorate
MS 210-7
NASA-Ames Research Center
Moffett Field, CA
94035-1000
(415) 604-5836

Joseph J. Bonin

AFOTEC/TFM

AFOTEC/TFM
8500 Gibson Blvd. SE
Kirtland AFB, NM
87112
(505) 846-5344

Paul F. Borchers

Flight Dynamics and Controls Br.

MS 211-2
NASA Ames Research Center
Moffett Field, CA
94035-1000
(415) 604-6115

Prof. Roy Bradley
Univ. of Glasgow
University of Glasgow
The University
Glasgow, G128QQ
U.K.
041 339 8855 (x8070)

R. James Breiding
Naval Training Systems Center
Naval Training Systems Center
12350 Research Parkway
Orlando, FL
32826-3224
(407) 380-4723

LCDR Christopher D. Brown
USNTPS
USNTPS
522 Lake Drive
Lexington Park, MD
20653-000
(301) 863-4411

Robert Buckanin
U.S. Army AATD
Flight Controls Team Center
U.S. Army ATCOM - AATD
Bldg 401
Ft. Eustis, VA
23604
(804) 878-4101

A. N. Cappetta
Naval Air Dev. Cent.
Air Vehicle and Crew Systems Technology Department
Naval Air Development Center
Warminster, PA
18974-5000
(215) 441-7047

Dean Carico
NAWC
Naval Air Warfare Center
Patuxent River, MD
20670
(301) 826-1382

Roberto Celi
Univ. of Maryland
Dept. of Aerospace Eng.
University of Maryland
College Park, MD
20742
celi@eng.umd.edu
(301) 405-1132

Charles A. Chalk
Calspan Corp.
Calspan Corp.
PO Box 400
Buffalo, NY
14225
(716) 631-6708

Dr. Robert T. N. Chen
Flight Dynamics and Controls Br.
MS 211-2
NASA Ames Research Center
Moffett Field, CA
94035-1000
(415) 604-5008

Monique Chetelat
SYRE Inc.
SYRE Inc.
P.O. Box 81
Moffett Field, CA
94035
(415) 604-3245

Benny K. Cheung
Flight Experiments Branch
MS 237-5
NASA Ames Research Center
Moffett Field, CA
94035-1000
(415) 604-5432

Bill W. Chung
Flight Dynamics and Controls Br.
MS 211-2
NASA Ames Research Center
Moffett Field, CA
94035-1000
(415) 604-6002

John W. Clark
NAWC
Naval Air Warfare Center
PO Box 5152
Warminster, PA
18974
(215) 441-2165

Clayton R. Coler
Rotorcraft Human Factors Research Branch
MS 262-3
NASA Ames Research Center
Moffett Field, CA
94035-1000
(415) 604-5716

Richard A. Coppenbarger
Guid and Nav. Br.
MS 210-9
NASA Ames Research Center
Moffett Field, CA
94035-1000
(415) 604-5433

Lloyd D. Corliss
Military Technology Office
NASA Ames Research Center
Moffett Field, CA
95035-1000
(415) 604-6269

H. C. Curtiss, Jr.
Princeton Univ.
Engineering Quad, Room D-224
Princeton University
Princeton, NJ
"08544"
(609) 258-5149

Dr. Joseph De Maio
U.S. Army AFDD
Crew Station Research and Development Branch
MS 243-4
NASA Ames Research Center
Moffett Field, CA
94035-1000
(415) 604-6974

William A. Decker
Flight Dyn. and Cont. Br.
Flight Dynamics and Controls Branch
MS 211-2
NASA Ames Research Center
Moffett Field, CA
94035-1000
(415) 604-5362

James Dryfoos
Boeing Helicopters
Boeing Helicopters
PO Box 16858, MS P32-31
Philadelphia, PA
19142-0858
(215) 591-7305

Maj. Mike Duva
NAVAIRSYSCOM, U.S.M.C.
NAVAIRSYSCOM
PMA205-2I
Washington, D.C.
20361
(703) 692-2641 x3015

Ronald DuVal
Advanced Rotorcraft Technology
Advanced Rotorcraft Technology
1685 Plymouth Street
Mountain View, CA
94022
(415) 968-1464

Shawn Engelland
Flight Dynamics and Controls Br.
MS 211-2
NASA Ames Research Center
Moffett Field, CA
94035-1000
(415) 604-5271

Dorothy L. Englehardt
NAVAIR
NAVAIR
Washington, DC
20361-1205
(703) 692-2641

Michelle Eshow
U.S. Army AFDD
U.S. Army Aeroflightdynamics Directorate
MS 211-2
NASA Ames Research Center
Moffett Field, CA
94035-1000
(415) 604-5272

Donald L. Folger
Sikorsky, UTC
S336A1
United Technologies, Sikorsky Aircraft
6900 Main Street
Stratford, CT
06601-1381
(203) 386-7449

Dr. James A. Franklin
Flight Dyn. and Cont. Br.
Flight Dynamics and Controls Branch
MS 211-2
NASA Ames Research Center
Moffett Field, CA
94035-1000
(415) 604-6004

Ron Friedman
Boeing Helicopters
Boeing Helicopters
PO Box 16858
Philadelphia, PA
19142-0858
(215) 591-6167

John D. Funk
Naval Air Warfare Cent.
Aircraft Division
Naval Air Warfare Center
Warminster, PA
18974-5000
(215) 441-3463

R. Thomas Galloway
Naval Training Systems Center
Naval Training Systems Center
12350 Research Parkway
Orlando, FL
32826-3224
(407) 380-4648

Charles K. Gardner
U.S. Army
U.S. Army
STEAT-AQ-TC
Edwards AFB, CA
93525
(805) 277-4023

Philip J. Gold
Sikorsky Aircraft Div., UTC
MS 336A
Sikorsky Aircraft Div., UTC
6900 Main St.
Stratford, CT
06601-1381
(203) 386-3208

David L. Green
Starmark Corp.
Starmark Corp.
1745 Jefferson Davis Highway, Suite 507
Arlington, VA
22202
(703) 413-0250

Dr. Arthur J. Grunwald
West. Aero. Labs
MS 262-2
NASA Ames Research Center
Moffett Field, CA
94035-1000
(415) 604-0104

Thomas F. Gruzleski
CAE-Link
CAE-Link
PO Box 1237
Binghamton, NY
13902-1237
(607) 721-4251

J. Hagen
NTPS
National Test Pilot School
Box 658
Mojave, CA
93501
(805) 824-2977

Maj. Johnnie Ham
U.S. Army AQTD
Airworthiness Qualification Test Directorate
Bldg. 1820
Edwards AFB, CA
93523-5000
(805) 940-8940

Daniel C. Hart
U.S. Army AFDD
U.S. Army Aeroflightdynamics Directorate
MS 210-7
NASA-Ames Research Center
Moffett Field, CA
94035-1000
(415) 604-3485

Sandra G. Hart
Rotorcraft Hum. Fac. Res. Br.
MS 262-3
NASA Ames Research Center
Moffett Field, CA
94035-1000
(415) 604-6072

Loran A. Haworth
U.S. Army AFDD
MS 243-3
NASA Ames Research Center
Moffett Field, CA
94035-1000
(415) 604-6944

Robert K. Heffley
Robert Heffley Engineering
Robert Heffley Engineering
349 First Street
Los Altos, CA
94022
(415) 949-1747

William S. Hindson
Flight Operations Br.
Flight Operations Branch
MS 211-3
NASA Ames Research Center
Moffett Field, CA
94035-1000
(415) 604-1106

Roger H. Hoh
Hoh Aeronautics, Inc.
Hoh Aeronautics, Inc.
2075 Palos Verdes Drive North #217
Lomita, CA
90717
(310) 325-7255

Patrick J. Hollifield
Bell Helicopter Textron Inc.
Bell Helicopter Textron Inc.
PO Box 482
Fort Worth, TX
76101
(817) 280-2288

Steven W. Hong
United Tech. Res. Cent.
MS 85
United Technologies Research Center
East Hartford, CT
"06108"
(203) 727-7068

Thomas L. House
U.S. Army ATCOM
U.S. Army Aviation and Troop Command
4300 Goodfellow Blvd.
St. Louis, MO
63132
(314) 263-1012

J. Howitt
U.K. Defence Res. Agcy.
31 Whitley Rd.
Shortstown, Bedford
MK42 OXA
U.K.
023-422-5368

James J. Howlett
Sikorsky Aircraft Div., UTC
MS 336A
Sikorsky Aircraft Div., UTC
Main Street
Stratford, CT
06601-1381
(203) 386-6010

Carla D. Ingram
SYRE Inc.
SYRE Inc.
P.O. Box 81
Moffett Field, CA
94035
(415) 604-5381

Laura Iseler
Flight Dynamics and Controls Br.
MS 211-2
NASA Ames Research Center
Moffett Field, CA
94035-1000
(415) 604-6196

Kenneth G. Jay
British Embassy
British Embassy
3100 Massachusetts Ave.
Washington, DC
20008
(202) 898-4640

John B. Johns
U.S. Army AFDD
MS 215-1
NASA Ames Research Center
Moffett Field, CA
94035-1000
(415) 604-6214

Walter W. Johnson
Rotorcraft Human Factors Br.
Rotorcraft Human Factors Branch
MS 262-3
NASA Ames Research Center
Moffett Field, CA
94035-1000
(415) 604-3667

Mary K. Kaiser
Rotorcraft Human Factors Br.
Rotorcraft Human Factors Branch
MS 262-3
NASA Ames Research Center
Moffett Field, CA
94035-1000
(415) 604-4448

Andrew W. Kerr
U.S. Army AFDD
U.S. Army AFDD
MS 215-1
NASA Ames Research Center
Moffett Field, CA
94035-1000
(415) 604-5837

David L. Key
U.S. Army AFDD
U.S. Army Aeroflightdynamics Directorate
MS 210-7
NASA Ames Research Center
Moffett Field, CA
94035-1000
(415) 604-5839

Lee Khinoo
Veda Inc.
Veda Inc.
300 Exploration
Lexington Park, MD
20653
(301) 826-4411

Dr. Fredrick D. Kim
Flight Dynamics and Controls Br.
MS 211-2
NASA Ames Research Center
Moffett Field, CA
94035-1000
(415) 604-5272

Dwayne F. Kimball
Ishida Aerospace Res., Inc.
Ishida Aerospace Research, Inc.
Alliance Airport
2301 Horizon Drive
Fort Worth, TX
76177
(817) 837-8000 x229

David W. King
Boeing Helicopters
Boeing Defense and Space Group: Helicopter Div.
PO Box 16858
Philadelphia, PA
19142-0858
(215) 591-2257

Rene Knorr
Eurocopter Deutschland GmbH
Eurocopter Deutschland GmbH
Postfach 80 11 40 D-8000
Munchen, 80
Germany
089-6000-6575

Masaki Komoda
Tokyo Met. Inst. of Tech.
Tokyo Metropolitan Institute of Technology
6-6 Asahigaoka, Hino
Tokyo, Japan 191

William E. Larsen
FAA
MS 210-2
NASA Ames Research Center
Moffett Field, CA
94035-1000
(415) 604-6380

Dr. Victor J. Lebacqz
Flight Human Factors Br.
Flight Human Factors Branch
MS 262-4
NASA Ames Research Center
Moffett Field, CA
94035-1000
(415) 604-5792

Sikorsky Library
United Technologies Res Ctr
Attn: Library Acquisitions
411 Silver Lane
East Hartford, CT
6108

Tom MacDonald
Boeing Helicopters
Boeing Helicopters
MS P20-38
PO Box 16858
Philadelphia, PA
19142-0858
(215) 591-5204

John A. Macrino
U.S. Army AATD
U.S. Army AATD
Ft. Eustis, VA
23604
(804) 878-2122

M. Hossein Mansur
U.S. Army AFDD
MS 211-2
NASA Ames Research Center
Moffett Field, CA
94035-1000
(415) 604-6037

Bob Marshall
no address information

Walter E. McNeill
Flight Dyn and Contr. Br.
MS 211-2
NASA Ames Research Center
Moffett Field, CA
94035-1000
(415) 604-5362

Robert V. Miller
USNTPS
U.S. Naval Test Pilot School
NAS
Patuxent River, MD
20653
(301)826-4411

David G. Mitchell
System Technologies Inc.
Systems Technology Inc.
13766 S. Hawthorne Blvd.
Hawthorne, CA
90250-7083
(310) 679-2281

Manoj Mittal
Georgia Tech.
Georgia Tech Research Facility, Cobb County
7220 Richardson Rd, Bldg. 2 Trailer
Smyrna, GA
30080
(404) 528-7110

Maj. V. D. Mize
Naval Training Systems Center
Naval Training Systems Center
12350 Research Parkway
Orlando, FL
32826-3224
(407) 380-4219

J. Murray Morgan
NRC Flight Res. Lab.
National Research Council Flight Research Laboratory
Uplands Bldg. U-61
Ottawa, Ontario
KEY-0R6
Canada
(613) 998-3180

Michael W. Mosher
USNTPS
U.S. Naval Test Pilot School
4350 Jimmy Carter Blvd.
Norcross, GA
30093-0000
(301) 863-4411

CW4 Craig R. Nixon
U.S. Army AQTD
U.S. Army AQTD
75 North Flightline Rd.
Edwards AFB, CA
93524-6100
(805) 277-4992

Randall L. Oser
Naval Training Systems Center
Naval Training Systems Center
12350 Research Parkway
Orlando, FL
32826-3224
(407) 380-4818

Dean Owen
Univ. of Canterbury
Department of Psychology
University of Canterbury
Christchurch
New Zealand
(03) 667-001, FAX (03) 642-181

Gareth D. Padfield
Defence Res. Agency
Defence Research Agency
Flight Systems Dept.
Bedford
MK41 6AE
U.K.
0234-225-370

Heinz-Jurgen Pausder
DLR Inst. Fuer Flugmechanik
DLR Inst. Fuer Flugmechanik
Buchhorstblick 13
3302 Cremlingen
Germany
email: FK17%DLRBMBS.BITNET@VM.GO.DLR.DE
(531) 395-2694

Frederick O. Porter
NAWCAD
NAWCAD
Patuxent River, MD
20650
(301) 826-1335

Ian Postlethwaite
Leicester Univ.
Control Systems Research, Dept. of Engineering
Leicester University
Leicester, LE1 7RH
U.K.
(301) 826-1335

Raymond W. Prouty
Consultant
4334 Deerpark Court
Westlake Village, CA
91361
(818) 889-8955

Leighton Kf. Quon
SYRE Inc.
SYRE Inc.
P.O. Box 81
Moffett Field, CA
94035
(415) 604-3891

J. J. Rabeni
Reflectone Inc.
Reflectone
4908 Tampa West Blvd.
P.O. Box 15000
Tampa, FL
33684-5000
(813) 885-7481

Thomas L. Reynolds
U.S. Army AFDD
MS 211-3
NASA Ames Research Center
Moffett Field, CA
94035-1000
(415) 604-5101

David (Tom) Rutledge
McDonnell Douglas Hel. Co.
McDonnell Douglas Helicopter Co.
MS 530/B346
5000 E. McDowell Rd.
Mesa, AZ
85205
(602) 891-2272

Richard A. Schott
USMC
USMC
HMT-204
MCAS New River
Jacksonville, NC
28460
(919) 451-6422

Jeffery A. Schroeder
Flight Dyn. and Contr. Br.
Flight Dynamics and Controls Branch
MS 211-2
NASA Ames Research Center
Moffett Field, CA
94035-1000
(415) 604-4037

LCDR Timothy Sestak
Naval Air Warfare Center
Naval Air Warfare Center
Aircraft Division
PO Box 51 52
Warminster, PA
18974-0591
(215) 441-1047

Rickey C. Simmons
Flight Operations Branch
MS 211-3
NASA Ames Research Center
Moffett Field, CA
94035-1000
(415) 604-3130

Donovan Spurgeon
NAVAIR
NAVAIR PMA-205M
COMNAVAIRSYSCOM
Washington, DC
20361
(703) 692-2641 x 3002

Dr. Wendell B. Stephens
U.S. Army Aeroflightdynamics Dir.
MS 243-3
NASA Ames Research Center
Moffett Field, CA
94035-1000
(415) 604-5794

Michael W. Stortz
Flight Operations Branch
MS 211-3
NASA Ames Research Center
Moffett Field, CA
94035-1000
(415) 604-3131

Karen Studebaker
Rotorcraft Technology Br.
MS 237-5
NASA Ames Research Center
Moffett Field, CA
94035-1000
(415) 604-5469

Selwyn Sturisky
Georgia Tech
School of Aerospace Engineering
Georgia Tech.
Atlanta, GA
30332-0150
(404) 894-2995

Shoichi Sugiyama
Ishida Aerospace Res., Inc.
Ishida Aerospace Research, Inc.
Alliance Airport
2301 Horizon Drive
Fort Worth, TX
76177
(817) 837-8000

Armin Taghizad
ONERA-DED
ONERA
21 Avenue de la Division Leclerc
B.P. 72 92322 Chatillon Cedex
France
32.16.4-46.73.40.40

Dr. Marc D. Takahashi
U.S. Army AFDD
MS 211-2
NASA Ames Research Center
Moffett Field, CA
94035-1000
(415) 604-5271

Nigel Talbot
CAA
CAA
Aviation House, South Area
Gatwick Airport
Gatwick, Surrey
RH6 OYR
UK
44293 573107

Peter D. Talbot
Rotorcraft Technology Branch
MS 237-5
NASA Ames Research Center
Moffett Field, CA
94035-1000
(415) 604-5108

Robert Tam
SYRE Inc.
SYRE Inc.
P.O. Box 81
Moffett Field, CA
94035
(415) 604-5000 (22433)

Dr. Douglas G. Thomson
Univ. of Glasgow
University of Glasgow
The University
Glasgow, G128QQ
U.K.
041 339 8855 (x4334)

Dr. Mark B. Tischler
U.S. Army AFDD
MS 211-2
NASA Ames Research Center
Moffett Field, CA
94035-1000
(415) 604-5563

Joseph J. Totah
Rotorcraft Technology Branch
MS 237-5
NASA Ames Research Center
Moffett Field, CA
94035-1000
(415) 604-4126

D. J. Walker
Leicester Univ.
Control Systems Research, Dept. of Engineering
Leicester University
Leicester, LE1 7RH
U.K.
0533-522529

Don Welch
Bell Helicopter Textron
MS 1302
Bell Helicopter Textron
PO Box 482
Fort Worth, TX
76101
(817) 280-3608

Matthew S. Whalley
U.S. Army AFDD
U.S. Army Aeroflightdynamics Directorate
MS 210-7
NASA-Ames Research Center
Moffett Field, CA
94035-1000
(415) 604-3505

Gregory P. Wright
Sikorsky Aircraft Div., UTC
MS 336A
Sikorsky Aircraft Div., UTC
Main Street
Stratford, CT
06601-6010
(203) 386-6010

Richard E. Zelenka
Aircraft Guidance and Navigation Branch
MS 210-9
NASA Ames Research Center
Moffett Field, CA
94035
(415) 604-5433

