

Title	Pressure Welding of Aluminum to Titanium
Author(s)	Iwamoto, Nobuya; Tabata, Sanetoshi; Takeuchi, Toshiaki
Citation	Transactions of JWRI. 5(1) P.63-P.66
Issue Date	1976-03
Text Version	publisher
URL	http://hdl.handle.net/11094/8330
DOI	
rights	本文データはCiNiiから複製したものである
Note	

Osaka University Knowledge Archive : OUKA

<https://ir.library.osaka-u.ac.jp/>

Osaka University

Pressure Welding of Aluminum to Titanium †

Nobuya IWAMOTO*, Sanetoshi TABATA** and Toshiaki TAKEUCHI**

Abstract

To reduce the degree of deformation, pressure welding of aluminum to titanium, in this case especially using the titanium pre-coated with aluminum, was carried out. This means made possible to weld in the air at the elevated temperature and to lessen the deformation being required. The diffusion layer and the intermetallic compound in weld were studied with X-ray diffraction analysis and the latter was identified to Al_3Ti .

1. Introduction

While titanium has good corrosion resistance, aluminum has the superior thermal and electric properties. Therefore, the composite material of these two metals has been thought to be suitable for heat exchangers or electric conductors used in corrosive atmosphere. It says that it needs to deform the body amounts to 80 % to obtain sufficient strength in the cold pressure welding of titanium¹⁾. When titanium is welded at the elevated temperature in order to reduce the deformation,^{2),3)} it is necessary to prevent the oxidation of the faying surfaces besides to minimize the absorption of oxygen and nitrogen which embrittle the metal surfaces.

Pressure welding of dissimilar metals have been studied by several workers^{4),5)}. McEwan and Milner classified the metal pairs into four groups such as immiscible, partly miscible, miscible and intermetallic forming and compared their weldability and the effect of heat treatment. Furthermore, they mentioned that c.p.h. metals such as zinc and magnesium have considerably inferior weldability, i.e. higher threshold deformation and lower strength when compared with cubic metals such as aluminum, copper, iron and lead. They suggested that this reason would be due to the difference in the behavior of breakdown of oxide film.

The metal pair of aluminum-titanium whose mechanical properties are very different, may require

large deformation to weld each other in cold pressure welding because it is difficult to deform titanium faying surface. When hot pressure welding technique is applied, the problems associated with heating of titanium must be solved.

In this study, it was aimed to reduce the deformation in pressure welding process of aluminum to titanium from the industrial viewpoint. The weldability when aluminum pre-coating on titanium surface was used and weld zone were examined.

2. Experimental Procedures

2.1 Materials

The materials used in this work were commercial purity aluminum plate (1100), titanium sheet (KS50, corresponds to ASTM B265-58 T-Gr2) and high purity aluminum. Their chemical compositions are given in Table 1. The dimensions of the specimens for lap

Table 1 Chemical composition

Specimen	Cu	Fe	Si	Mn	Mg	Zn	Cr	Ti	Al
1100	0.02	0.33	0.21	0.04	-	0.01	-	0.01	Bal.
1099	0.001	0.0004	0.001	-	-	-	-	-	Bal.
Ti	Ti > 99.5%								

welding were 100 mm length, 20 mm width and 5 mm thickness for aluminum and 1 mm thickness for titanium.

† Received on Jan.8, 1976 (Presented at The Meeting of Japan Welding Society, October, 1975)

* Professor

** Teikoku Piston Ring Inc.

2.2 Surface preparation

The following treatments of specimens were performed: 1. degreasing, 2. rinsing, 3. pickling, 4. re-rinsing, 5. drying, 6. wire brushing. Most of the titanium specimens were coated with aluminum by hot-dipping technique before wire brushing. To get one side coating, the suspended graphite powder in alcohol was painted to the other surface. After drying, the titanium specimens were dipped into aluminum bath at fixed temperature for a constant period.

2.3 Pressure welding

The apparatus used in this work is shown schematically in Fig. 1. A pair of the specimens overlapped in

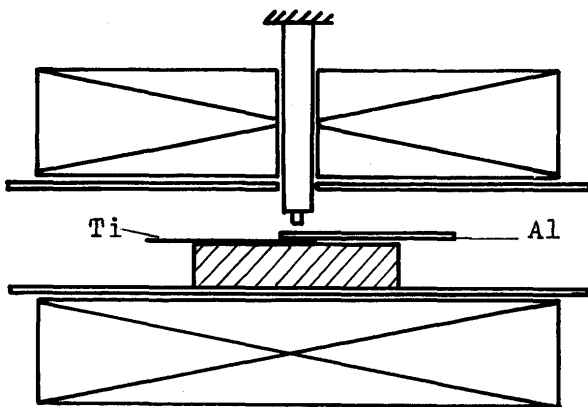

Fig. 1 Apparatus for pressure welding

the area of 20 mm x 20 mm was set between the dies as shown in Fig. 1. Then, the specimens were pressed with the dies of 6 mm ϕ from aluminum side at the welding temperature.

2.4 Examination

X-ray diffraction analysis was made to know the intermetallic compound formed at the interface. The strength of the joint was measured with tensile testing machine (Shimadzu, IS-5000).

3. Experimental results

3.1 Analysis of weld zone

Generally, hot-dipped coating is composed of two layers: (a) an alloy layer which is formed by diffusion at temperature well below the melting point and (b) a

coating metal layer which has solidified from the molten state. The thickness of these layers depend on the temperature, dipping time and rising velocity from bath. As an example, the microstructure of the titanium specimen hot-dipped at 750 °C for 15 sec is shown in

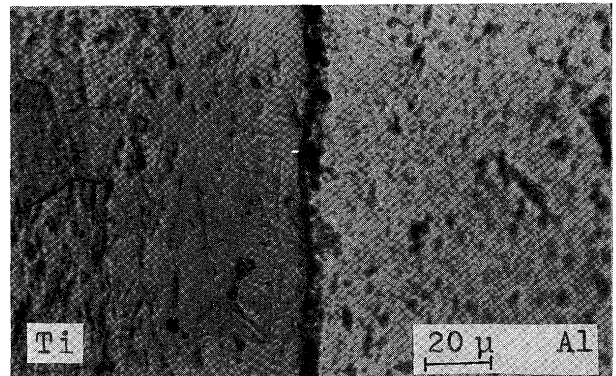

Photo. 1 Microstructure of hot-dipped titanium

Photo. 1. The coated aluminum layer is about 30 μ m thickness but it remained unclear whether the intermetallic compound formed or not.

Figure 2 shows the result of E.P.M.A. of the same sample in Photo. 1. The intermetallic compound layer could not be recognized from this result.

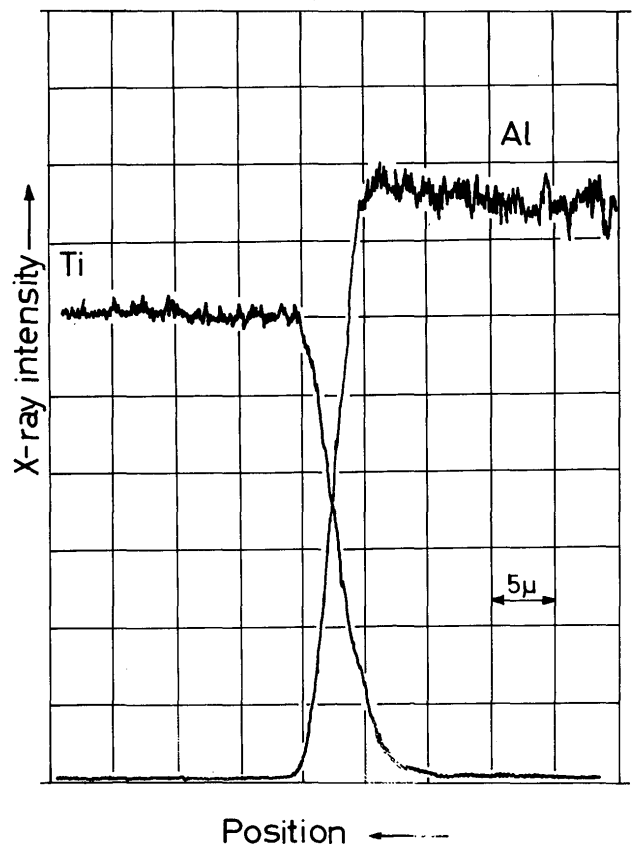

Fig. 2 X-ray micro-analysis of weld between aluminum and titanium

The experimental conditions of electrolytic extraction⁶⁾ of hot-dipped titanium specimens are given in Table 2. X-ray diffraction patterns of the residues

Table 2 Conditions of electrolytic extraction

0.2 N-HCl	
EDTA 2Na	5g/l
0.2 N-C ₆ H ₄ (COOH) (COOK)	250ml/l
pH 3~4, D _k = 5 mA/cm ²	

extracted from titanium, hot-dipped at 750 °C for 15 sec and at 750 °C for 8 min, are shown in Photo. 2-(a) and 2-(b). The diffraction patterns of Al₃Ti are observed in Photo. 2-(b), but the formation of Al₃Ti is not

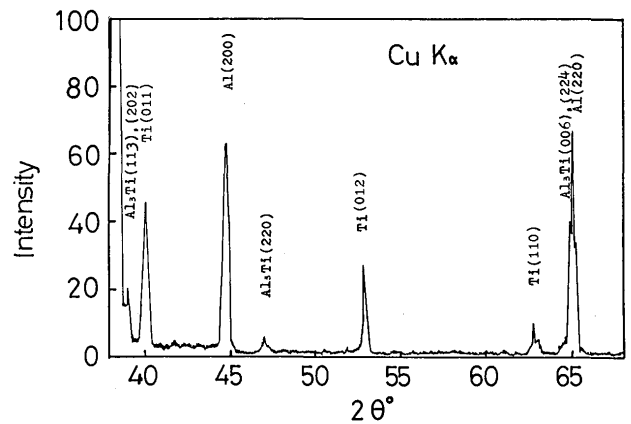

Fig. 3 X-ray diffraction patterns of specimen roll-bonded and heat-treated

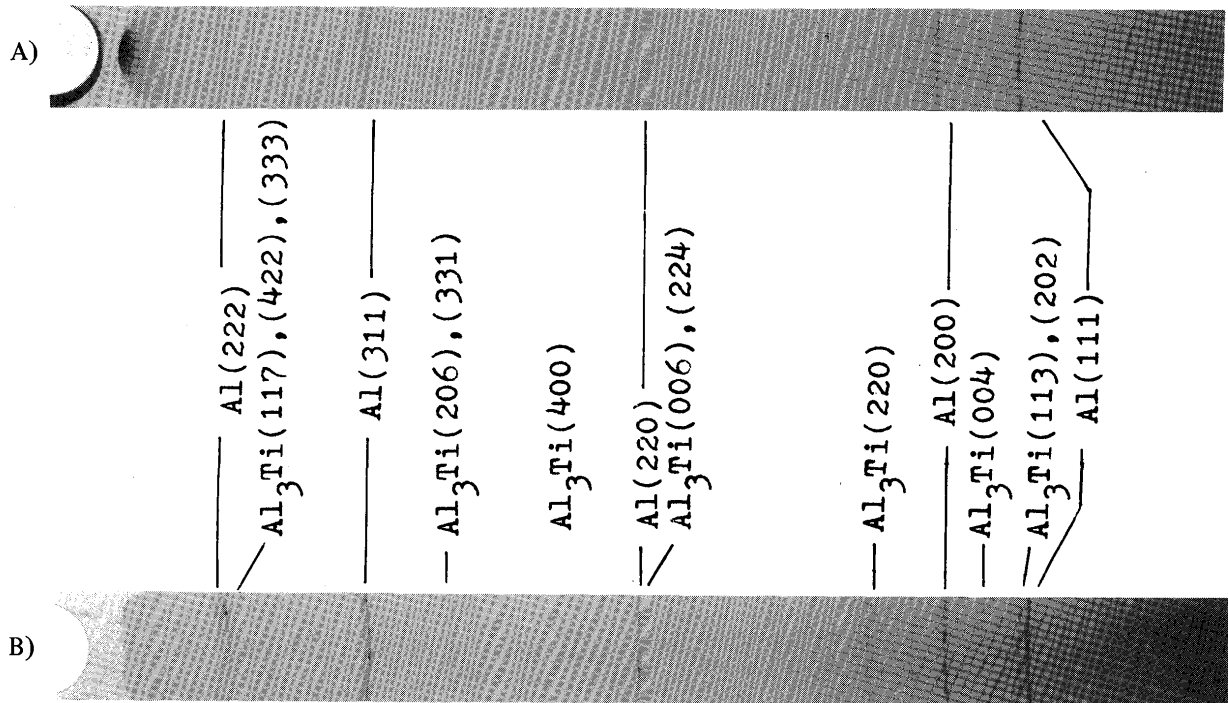

Photo. 2 - (a), (b) X-ray diffraction patterns of residues extracted from hot dipped titanium
(a) 750°C, 15 sec (b) 750°C, 8 min

observed in Photo. 2-(a).

To solve whether same intermetallic compound is formed, the direct cold pressure welding followed by diffusion heat-treatment was studied. The sample was made as follows:

- (1) cold rolling of titanium and aluminum foil by one pass reduction of 40 %
- (2) heat-treatment at 600 °C for 10 hours

The result by X-ray is shown in Fig. 3. Al₃Ti was confirmed in this specimen.

These results show that the intermetallic compound formed in weld is Al₃Ti only though there are another intermetallics such as Al₂Ti, AlTi, AlTi₃ or Al₁₁Ti in

this binary system, and the growth of this layer seemed to be very slow compared to that of other intermetallic compounds layer in the system of aluminum-copper, aluminum-iron or aluminum-nickel.

The parameters of hot-dipping in the following experiment were fixed at 750 °C for 15 sec because hot dipping time is the longer, the rougher the surface becomes.

3.2 Examination of Weldability

The relationships between failure strength of the lap joint in tensile-shear test and deformation under the

constant welding temperature are shown in Fig. 4. For convenience, deformation was changed to the value of reduction of aluminum thickness in Fig. 4. The lap joint

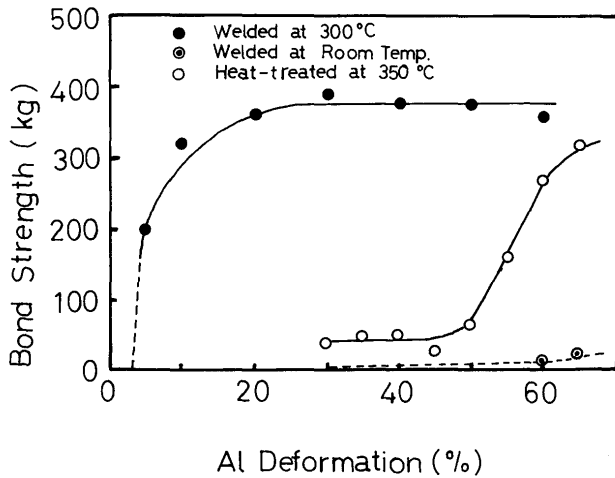

Fig. 4 Effect of deformation on bond strength

welded at 300 °C begins to weld at about 5 % deformation, steeply increases the strength with deformation proceeds and then shows sufficient strength at 20 % deformation. The lap joint welded at room temperature begins to weld at 30 % deformation but its strength is very low. As for direct cold pressure welding, however, the threshold deformation value is more than 70 %, so it seems that the aluminum coating is effective in reducing the deformation being required. The strength was increased as shown in Fig. 4 when the lap joints were heat-treated at 350 °C for 30 min. But the strength was considerably lower than that of the joint welded at 300 °C, because failure had been occurred at the periphery of weld by heat-treatment.

The effect of welding temperature on strength is shown in Fig. 5 when deformation was fixed to 20 %. Specimens could not be welded together up to 150 °C, i.e. the threshold deformation value was larger than 20 %. The joint showed the maximum strength when it was welded at the range from 200 °C to 350 °C. The joint, however, had a tendency to decrease its strength when welding temperature becomes higher than 350 °C. The reason would be attributed to the oxidation or the softening of aluminum.

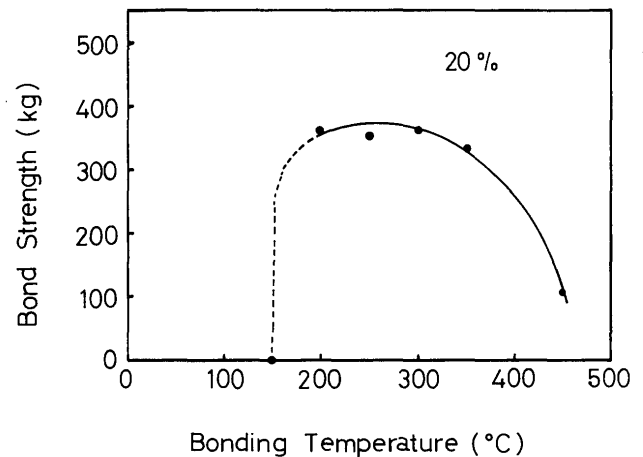

Fig. 5 Effect of welding temperature on bond strength

4. Summary

The conclusions obtained in this work are as follows:

- (1) Aluminum is readily pressure welded to titanium when aluminum layer was coated on titanium before welding.
- (2) This layer enables to weld in the air at the elevated temperature and to reduce the deformation being required.
- (3) The experimental conditions to obtain good joints are as follows:
 - (a) 750 °C, 15 sec for hot-dipping
 - (b) 300 °C, 20 % for welding
- (4) The intermetallic compound formed in weld is Al_3Ti .

References

- 1) J. E. Hughes: Sheet Met. Ind., 31 (1954) p. 52
- 2) C. B. Voldrich: Welding Journal, 32 (1953) p. 497
- 3) C. F. Wilford and R. F. Tylecote: Brit. W. J., 7 (1960) p. 708
- 4) R. F. Tylecote: Brit. W. J., 1 (1954) p. 117
- 5) K. J. B. McEwan and D. R. Milner: Brit. W. J., 9 (1962) p. 406
- 6) S. Masuyama, K. Arai and A. Kawabe: Light Metals, 23 (1973) p. 487 (in Japanese)