



Process Design and Economics for Conversion of Lignocellulosic Biomass to Ethanol

Thermochemical Pathway by Indirect Gasification and Mixed Alcohol Synthesis

A. Dutta, M. Talmadge, and J. Hensley
*National Renewable Energy Laboratory
Golden, Colorado*

M. Worley and D. Dudgeon
*Harris Group Inc.
Atlanta, Georgia and Seattle, Washington*

D. Barton, P. Groenendijk, D. Ferrari, and
B. Stears
*The Dow Chemical Company
Midland, Michigan*

E.M. Searcy, C.T. Wright, and J.R. Hess
*Idaho National Laboratory
Idaho Falls, Idaho*

NREL is a national laboratory of the U.S. Department of Energy, Office of Energy Efficiency & Renewable Energy, operated by the Alliance for Sustainable Energy, LLC.

Technical Report
NREL/TP-5100-51400
May 2011

Contract No. DE-AC36-08GO28308

Process Design and Economics for Conversion of Lignocellulosic Biomass to Ethanol

Thermochemical Pathway by Indirect Gasification and Mixed Alcohol Synthesis

A. Dutta, M. Talmadge, and J. Hensley
*National Renewable Energy Laboratory
Golden, Colorado*

M. Worley and D. Dudgeon
*Harris Group Inc.
Atlanta, Georgia and Seattle, Washington*

D. Barton, P. Groenendijk, D. Ferrari, and
B. Stears
*The Dow Chemical Company
Midland, Michigan*

E.M. Searcy, C.T. Wright, and J.R. Hess
*Idaho National Laboratory
Idaho Falls, Idaho*

Prepared under Task No. BB07.3710

NREL is a national laboratory of the U.S. Department of Energy, Office of Energy
Efficiency & Renewable Energy, operated by the Alliance for Sustainable Energy, LLC.

NOTICE

This report was prepared as an account of work sponsored by an agency of the United States government. Neither the United States government nor any agency thereof, nor any of their employees, makes any warranty, express or implied, or assumes any legal liability or responsibility for the accuracy, completeness, or usefulness of any information, apparatus, product, or process disclosed, or represents that its use would not infringe privately owned rights. Reference herein to any specific commercial product, process, or service by trade name, trademark, manufacturer, or otherwise does not necessarily constitute or imply its endorsement, recommendation, or favoring by the United States government or any agency thereof. The views and opinions of authors expressed herein do not necessarily state or reflect those of the United States government or any agency thereof.

Available electronically at <http://www.osti.gov/bridge>

Available for a processing fee to U.S. Department of Energy and its contractors, in paper, from:

U.S. Department of Energy
Office of Scientific and Technical Information

P.O. Box 62
Oak Ridge, TN 37831-0062
phone: 865.576.8401
fax: 865.576.5728
email: <mailto:reports@adonis.osti.gov>

Available for sale to the public, in paper, from:

U.S. Department of Commerce
National Technical Information Service
5285 Port Royal Road
Springfield, VA 22161
phone: 800.553.6847
fax: 703.605.6900
email: orders@ntis.fedworld.gov
online ordering: <http://www.ntis.gov/help/ordermethods.aspx>

Cover Photos: (left to right) PIX 16416, PIX 17423, PIX 16560, PIX 17613, PIX 17436, PIX 17721



Printed on paper containing at least 50% wastepaper, including 10% post consumer waste.

Executive Summary

The Energy Independence and Security Act (EISA) of 2007 established a mandate for 36 billion gallons of U.S. biofuel production per year by 2022. To meet this goal, the U.S. Department of Energy (DOE) promotes the development of ethanol and other liquid fuels from lignocellulosic feedstocks and funds fundamental and applied research to advance the state of biomass conversion technology. As a participant in the program, the National Renewable Energy Laboratory (NREL) investigates process improvements for cellulosic ethanol production and develops information that can be used to assess cellulosic ethanol's cost-competitiveness and market penetration potential.

This design report describes an up-to-date benchmark thermochemical conversion process that incorporates the latest research from NREL and other sources. It also includes improvements that are deemed experimentally achievable by 2012. This benchmark helps to quantify the impacts of core research at NREL and elsewhere and evaluates progress toward achieving technical and cost targets. The report will assist DOE in understanding the research areas that hold the greatest potential to positively impact the cost of ethanol production via gasification.

Building on a design report published in 2007, NREL and its subcontractor Harris Group Inc. performed a complete review of the process design and economic model for a biomass-to-ethanol process via indirect gasification. Specifically, the process design involves conversion of woody biomass to ethanol, where biomass is converted to syngas via indirect steam gasification, and the syngas is cleaned, conditioned, and converted to mixed alcohols over a solid catalyst. Ancillary areas such as feed handling and drying, alcohol separation, steam and power generation, cooling water, and other utilities are also included in the design.

The following major updates are included in the report:

- Improved feedstock cost estimates derived from Idaho National Laboratory's uniform-format feedstock handling system.
- Current understanding of the conversion of tars and other hydrocarbons to carbon monoxide (CO) and hydrogen (H₂) using biomass-derived syngas and steam reforming.
- Inclusion of The Dow Chemical Company's fundamental kinetic model for alcohol synthesis, which predicts the behavior of their proprietary alcohol synthesis catalyst.
- Inclusion of a physical solvent for the removal of CO₂ at high pressures.

The conceptual design presented herein considers the economics of ethanol production, assuming the achievement of internal research targets for 2012 and nth-plant costs and financing. The design features a processing capacity of 2,205 U.S. tons (2,000 metric tonnes) of dry biomass per day and an ethanol yield of 83.8 gallons per dry U.S. ton of feedstock. The ethanol selling price corresponding to this design is \$2.05 per gallon in 2007 dollars, assuming a 30-year plant life and 40% equity financing with a 10% internal rate of return and the remaining 60% debt financed at 8% interest. This ethanol selling price corresponds to a gasoline equivalent price of \$3.11 per gallon based on the relative volumetric energy contents of ethanol and gasoline. A summary of the analysis is presented in the following table.

Process Engineering Analysis for Ethanol from Mixed Alcohol Synthesis

2012 Case Using Technical Targets for Tar Reforming & Mixed Alcohol Synthesis

2,000 Dry Metric Tonnes Biomass per Day

Indirect Gasifier, Tar Reformer, Sulfur Removal, MoS₂ Catalyst, Fuel Purification, Steam-Power Cycle

All Values in 2007\$

Minimum Ethanol Selling Price (MESP) \$2.05 per Gallon

Contributions: Feedstock Costs	\$0.735	per Gallon
Operating Costs & Credits	\$0.244	per Gallon
Capital Charges & Taxes	\$1.069	per Gallon

Gasoline-Equivalent Price \$3.11 per Gallon

EtOH Production at Operating Capacity	64.7	MM Gallons per Year
EtOH Product Yield	83.8	Gallons per Dry US Ton Feedstock
Mixed Alcohols Production at Operating Capacity	72.5	MM Gallons per Year
Mixed Alcohols Product Yield	93.9	Gallons per Dry US Ton Feedstock
Delivered Feedstock Cost	\$61.57	per Dry US Ton (Includes Capital Up to Throat of Gasifier)
Internal Rate of Return (After-Tax)	10.0%	
Equity Percent of Total Investment	40.0%	

Capital Costs		Operating Costs (¢ / Gallon Product)	
Gasification	\$43,250,000	Feedstock	73.5
Tar Reforming & Quench	\$26,940,000	Natural Gas	0.0
Acid Gas & Sulfur Removal	\$28,490,000	Catalysts	9.9
Syngas Compression & Expansion	\$80,630,000	Olivine & Magnesium Oxide	0.7
Alcohol Synthesis Reaction	\$41,420,000	Other Raw Materials	0.9
Alcohol Separation	\$20,310,000	Waste Disposal	0.8
Steam System & Power Generation	\$45,840,000	Electricity	0.0
Cooling Water & Other Utilities	\$9,560,000	Fixed Costs	35.9
Total Installed Equipment Cost (TIC)	\$296,450,000	Co-Product Credits	-23.8
Land (115 acres at \$14000 per acre)	1,600,000	Capital Depreciation	37.8
Site Development	9,640,000	Average Income Tax	11.5
(% of ISBL)	4.0%	Average Return on Investment	57.5
Indirect Costs & Project Contingency	183,650,000		
(% of TIC)	62.0%	Operating Costs (\$ / Year)	
Fixed Capital Investment (FCI)	491,350,000	Feedstock	\$47,560,000
Working Capital	24,490,000	Natural Gas	\$0
Total Capital Investment (TCI)	\$515,840,000	Catalysts	\$6,380,000
Total Installed Equipment Cost per Annual Gallon		Olivine & Magnesium Oxide	\$0
of Ethanol Product	4.58	Other Raw Materials	\$380,000
of Mixed Alcohol Product	4.09	Waste Disposal	\$520,000
Fixed Capital Investment per Annual Gallon		Electricity	\$0
of Ethanol Product	7.59	Fixed Costs	\$23,240,000
of Mixed Alcohol Product	6.78	Co-Product Credits at \$1.88 per Gallon	-\$15,380,000
Loan Interest Rate	8.0%	Capital Depreciation	\$24,490,000
Loan Term (Years)	10	Average Income Tax	\$7,450,000
Maximum Yields Based on Feedstock Carbon Content		Average Return on Investment	\$37,210,000
Theoretical Ethanol Production (MM Gal / Year)	159.0	Total Plant Electricity Usage (KW)	64,356
Theoretical Ethanol Yield (Gal / Dry Ton)	205.9	Electricity Produced Onsite (KW)	64,411
Current Ethanol Yield (Actual / Theoretical)	40.7%	Electricity Purchased from Grid (KW)	0
Gasifier Efficiency - HHV %	74.3	Electricity Sold to Grid (KW)	55
Gasifier Efficiency - LHV %	73.9	Steam Plant + Turboexpander Power Generated (hp)	86,377
Overall Plant Efficiency - HHV %	46.5	Used for Main Compressors (hp)	63,374
Overall Plant Efficiency - LHV %	44.9	Other Electrical Consumption (hp)	23,003
Plant Operating Hours per Year	8410	Plant Electricity Use (KWh / Gal EtOH)	8.36
On-Stream Percentage	96.0%	Gasification & Reforming Steam Use (lb / Gal EtOH)	8.68
Excel File: R236H-V29.xls		Specific Operating Conditions	
		Feed Rate	Dry Tonnes / Day 2,000
			Dry Tons / Day 2,205
		Feedstock Cost	\$ / Dry Ton \$61.57
			\$ / Moisture & Ash Free Ton \$62.14

Acknowledgements

We thank the reviewers and other contributors to this report. Reviewers and other contributors are listed below by company/organization name. Reviewer comments on the draft version of the report are presented in Appendix O along with NREL authors' responses.

List of reviewers

Black & Veatch	Jon Erickson
British Petroleum	Nicholas Petrellis (retiree with 30 years experience)
Colorado School of Mines	Rob Braun
ConocoPhillips	Alex Platon
Coskata, Inc.	Richard Tobey
Goldman Sachs	Brian Bolster
National Renewable Energy Laboratory	Andy Aden Richard Bain Mary Bidy Ryan Davis Kristiina Iisa Kim Magrini-Bair Steven Phillips Joan Tarud
Pacific Northwest National Laboratory	Susanne Jones Iva Jovanovic Yunhua Zhu
Rentech, Inc.	George Apanel
URS Corporation	John Jechura
Weyerhaeuser	John Tao

Editor

National Renewable Energy Laboratory	Sara Havig
--------------------------------------	------------

Process flow diagram development

Harris Group Inc.	Diane Hartley Susanne Korinek Ray Lanier Hung Tran Joan Walker
-------------------	--

We thank the U.S. Department of Energy for funding and supporting this work.

Table of Contents

1	Introduction	1
1.1	Motivation and Background	1
1.2	Technoeconomic Analysis Approach	3
1.3	Definition of n th -Plant Economics	4
1.4	Estimation of Capital Costs	6
2	Plant Design Basis	9
2.1	Feedstock and Plant Size	9
2.2	Process Overview.....	11
2.3	Aspen Plus Model.....	14
3	Process Design and Cost Estimation	15
3.1	Area 100: Feed Handling and Drying.....	15
3.1.1	Area 100 Overview	15
3.1.2	Area 100 Design Basis.....	17
3.1.3	Area 100 Equipment Cost Estimations	17
3.2	Area 200: Gasification	18
3.2.1	Area 200 Overview	19
3.2.2	Area 200 Design Basis.....	21
3.2.3	Area 200 Equipment Cost Estimations	21
3.3	Area 300: Gas Cleanup.....	23
3.3.1	Area 300 Overview	23
3.3.2	Area 300 Design Basis.....	25
3.3.3	Area 300 Equipment Cost Estimations	26
3.4	Area 400: Alcohol Synthesis, Syngas Compression and Acid Gas Processing.....	26
3.4.1	Area 400 Overview	26
3.4.2	Area 400 Design Basis.....	33
3.4.3	Area 400 Equipment Cost Estimations	37
3.5	Area 500: Alcohol Separation.....	37
3.5.1	Area 500 Overview	38
3.5.2	Area 500 Design Basis.....	40
3.5.3	Area 500 Equipment Cost Estimations	41
3.6	Area 600: Steam System and Power Generation	41
3.6.1	Area 600 Overview	41
3.6.2	Area 600 Design Basis.....	42
3.6.3	Area 600 Equipment Cost Estimations	43
3.7	Area 700: Cooling Water and Other Utilities	43
3.7.1	Area 700 Overview	43
3.7.2	Area 700 Design Basis.....	44
3.7.3	Area 700 Cost Estimation	44
3.8	Additional Process Design Information.....	45
3.9	Pinch Analysis	45
3.10	Energy Balance	46
3.11	Sustainability Metrics	48
4	Process Economics	51
4.1	Total Capital Investment (TCI).....	51
4.2	Variable Operating Costs.....	53

4.3 Fixed Operating Costs.....	54
4.4 Value of Higher Alcohol Co-Products.....	55
4.5 Minimum Ethanol Selling Price.....	55
5 Process Economics and Sensitivity Analyses	56
5.1 Financial Scenarios	58
5.2 Feedstock	58
5.3 Gasification and Gas Cleanup.....	58
5.4 Alcohol Synthesis	58
5.5 Co-Product Value.....	59
6 Conclusions	59
7 Future Work.....	59
8 References	60
Appendix A. Equipment Description and Design Basis Summary	64
Appendix B. Individual Equipment Cost Summary	74
Appendix C. Discounted Cash Flow Rate of Return (DCFROR) and Operating Cost Summary	83
Appendix D. Process Parameters and Operation Summary	90
Appendix E. Process Flow Diagrams (PFDs) and Material and Energy Balances	93
Appendix F. Feedstock Supply Overview from Idaho National Laboratory (INL)	121
Appendix G. Synthesis Gas and Char Correlations for Indirect Gasifier.....	128
Appendix H. Equipment Lists and Cost Data for Package Systems	132
Appendix I. Technology and Cost Targets for Gasification, Tar Reforming, and Alcohol Synthesis.....	137
Appendix J. Fuel-Grade Ethanol Specifications	141
Appendix K. Direct Costs Included in Equipment Installation Factors from Harris Group Inc.	143
Appendix L. Plant Footprint and Land Cost Calculation from Harris Group Inc.....	149
Appendix M. Pinch Analysis and Heat Integration System Design	151
Appendix N. Summary of Design Report Assumptions.....	154
Appendix O. Reviewer Comments on Draft Design Report and Responses	157

List of Figures

Figure 1. Approach to thermochemical ethanol process design and analysis.....	3
Figure 2. <i>Chemical Engineering's</i> Plant Cost Index data.....	7
Figure 3. Current and predicted availability of biomass.....	9
Figure 4. Simplified flow diagram for the thermochemical process	11
Figure 5. Woody biomass feedstock supply system.....	16
Figure 6. Simplified process flow diagram of gasification area.....	19
Figure 7. Simplified process flow diagram of gas cleanup area.....	23
Figure 8. Simplified process flow diagram of alcohol synthesis area	27
Figure 9. The Dow Chemical Company model predictions compared to experimental data	29
Figure 10. Simplified flow diagram of the H ₂ S/CO ₂ removal and sulfur recovery	31
Figure 11. Maximum operating pressure for syngas turbo-expander.....	32
Figure 12. Simplified process flow diagram of alcohol separation area.....	38
Figure 13. Pinch analysis composite curve.....	46
Figure 14. Overall energy analysis (dry wood LHV basis).....	47
Figure 15. Cost contribution details from each process area.....	56
Figure 16. Results of sensitivity analyses.....	57

List of Tables

Table 1. Summary of n th -Plant Assumptions for Technoeconomic Analysis.....	5
Table 2. Comparison of Market Studies and TE Analyses for Existing Biofuels	5
Table 3. Direct Cost Factors for Estimating Installed Equipment Costs [16]	8
Table 4. Ultimate Analysis of Woody Biomass Feedstock	10
Table 5. Design Basis for Feed Handling and Drying Area	17
Table 6. Unit Cost Breakdown for Woody Biomass Feedstock (Southern Pine).....	18
Table 7. Design Basis for Gasification Area	21
Table 8. Estimates for Gasification and Tar Reforming Facilities	22
Table 9. Cost Estimate for Gasification Area	22
Table 10. Target Performance of Reforming Catalyst.....	25
Table 11. Reformer Conditions, Gas Compositions, and Reactor Basis for the Base Case	25
Table 12. Cost Estimate for Gas Cleanup Area	26
Table 13. Target and Design Basis Parameters for Alcohol Synthesis Reactor	34
Table 14. Design Parameters for Compression, Power Recovery, and H ₂ S/CO ₂ Systems	35
Table 15. Sources of Equipment Costs for Alcohol Synthesis Area	37
Table 16. Cost Estimate for Alcohol Synthesis Area	37
Table 17. Design Basis Parameters for Alcohol Separation Area	40
Table 18. Cost Estimate for Alcohol Separation Area.....	41
Table 19. Plant Power Requirements.....	42
Table 20. Cost Estimate for Steam System and Power Generation Area	43
Table 21. Design Basis for Cooling Water System	44
Table 22. Cost Estimate for Cooling Water and Other Utilities Area	44
Table 23. Utility and Miscellaneous Design Information.....	45
Table 25. Comparison of Water Usage for Transportation Fuel Processes.....	50
Table 26. General Cost Factors in Determining Total Installed Equipment Costs.....	51

Table 27. Cost Factors for Indirect Costs	52
Table 28. Project Cost Worksheet	52
Table 29. Summary of Variable Operating Costs	53
Table 30. Salary Costs for Plant Employees.....	54
Table 31. Other Fixed Operating Costs	54
Table 32. Higher Alcohols Co-Product Pricing.....	55

List of Acronyms

ASME	American Society of Mechanical Engineers	ISBL	inside battery limits
ASTM	American Society of Testing and Materials	kWh	kilowatt-hour
bbbl	barrel = 42 gallons	LHV	lower heating value
BCL	Battelle Columbus Laboratory	MAF	moisture and ash free
BFW	boiler feed water	MA	mixed alcohols
BPD	barrels per day	MAS	mixed alcohol synthesis
Btu	British thermal unit	MASP	minimum alcohols selling price
CFM	cubic feet per minute	MeOH	methanol
CH ₄	methane	MESP	minimum ethanol selling price
CO	carbon monoxide	MoS ₂	molybdenum disulfide
Co	cobalt	MgO	magnesium oxide
CO ₂	carbon dioxide	MTBE	methyl-tertiary-butyl ether
DCFRROR	discounted cash flow rate of return	MTPD	metric tonnes per day
DEPG	dimethyl ether of polyethylene glycol	MW	megawatts
DOE	U.S. Department of Energy	NREL	National Renewable Energy Laboratory
EDI	electrodeionization	NRTL	non-random two liquid activity coefficient method
EIA	Energy Information Administration	OBP	DOE's Office of Biomass Program
EISA	Energy Independence and Security Act	PFD	process flow diagram
EtOH	ethanol	PNNL	Pacific Northwest National Laboratory
FCC	fluid catalytic cracking	PPMV	parts per million by volume
FCI	fixed capital investment	PPMW	parts per million by weight
FT	Fischer-Tropsch	POX	partial oxidation
FY	fiscal year	psia	pounds per square inch (absolute)
GHSV	gas hourly space velocity	psig	pounds per square inch (gauge)
GJ	gigajoule	RKS-BM	Redlich-Kwong-Soave equation of state with Boston-Mathias modifications
gpm	gallons per minute	SMR	steam methane reformer
H ₂	hydrogen	SOT	State of Technology
H ₂ S	hydrogen sulfide	TIC	total installed cost
HAS	higher alcohol synthesis	TDC	total direct cost
HHV	higher heating value	TPD	short (U.S.) tons per day
hp	horsepower	TPEC	total purchased equipment cost
IRR	internal rate of return	WGS	water gas shift
INL	Idaho National Laboratory	WWT	wastewater treatment
IPE	Icarus Process Evaluator (software from Aspen)		

1 Introduction

1.1 Motivation and Background

The Energy Independence and Security Act of 2007 (EISA) [1] established a mandate for the annual U.S. production of 36 billion gallons of renewable fuel by 2022, of which 15 billion gallons may come from traditional or corn-based technologies and at least 16 billion gallons must be derived from lignocellulosic biomass sources. In order to achieve this goal the U.S. Department of Energy (DOE) has promoted the development of ethanol and other liquid fuels from lignocellulosic feedstocks by sponsoring programs in fundamental and applied research that aim to advance biomass conversion technologies.

One of DOE's research platforms is thermochemical conversion of lignocellulosic biomass to ethanol via gasification. DOE has set a target for making available technologies that, when integrated, will enable the production of ethanol that is cost-competitive with gasoline on an energy equivalent basis, without subsidies or policy initiatives, by the year 2012. To achieve this goal, DOE is sponsoring research in areas where commercial technology is not currently available, such as cleanup of biomass-derived syngas and synthesis of ethanol from syngas. This research is conducted at national laboratories, universities, and private companies in conjunction with engineering companies.

In order to assess the economic viability and potential of the conversion process, the National Renewable Energy Laboratory (NREL) and its partners have developed a complete process model with economic projections to estimate an absolute plant-gate price for ethanol. This plant-gate price is referred to as the minimum ethanol selling price (MESP). The MESP can be used by policymakers and DOE to assess the cost-competitiveness and market penetration potential of cellulosic ethanol in comparison with petroleum-derived fuels and corn-based ethanol.

The process design and economic analysis also directs biomass conversion research by examining the sensitivity of the MESP to process alternatives and research advances. Proposed research and anticipated results can be translated into a new MESP value that can be compared to the benchmark value documented in this report. This process helps to quantify the impact of core research at NREL and elsewhere and to track progress toward meeting competitive cost targets. It also allows DOE to make decisions about which research proposals have the greatest potential to reduce MESP.

This report builds upon a previous design report released in 2007 [2], written by engineers from NREL and Neoterics International, Inc. For the present report, NREL contracted Harris Group Inc. to provide engineering support through estimates and reviews of the equipment and raw material cost assumptions used in the process design and economic analysis. This report reflects NREL's latest envisioned thermochemical ethanol process design and includes the latest research and development progress in three key conversion areas (gasification, gas cleanup, and alcohol synthesis) and improvements in other areas such as heat integration and utilities.

Gasification involves the devolatilization and chemical conversion of biomass to a medium-calorific-value gas in an atmosphere of steam and/or oxygen. There are two primary classes of gasifiers – partial oxidation or direct gasifiers, and indirect steam blown gasifiers. Partial oxidation (POX) gasifiers, also called directly-heated gasifiers, use heat from the reaction

between oxygen and organic compounds to provide the necessary energy to devolatilize biomass and to react with carbon-rich chars to break their complex molecules into gases. POX gasifiers require high-purity oxygen provided by air separation units, which require significant capital investment. The capital intensity of these systems makes direct gasification processes more cost-prohibitive for smaller scale biomass conversion plants [3].

Indirect steam gasifiers are heated via heat transfer from a hot solid or through a heat transfer surface. By-product char and portions of the product gas can be combusted with air (external to the gasifier itself) to provide the energy for gasification. Although steam gasifiers do not require an air separation unit, gas compression is typically required for downstream unit operations because most indirect gasifiers operate at low pressure.

Indirect steam gasification was chosen as the basis for the gasifier design because techno-economic studies have shown that it has an economic advantage over oxygen-blown high-temperature slagging [4] or lower temperature dry-ash direct gasification [5] processes. Similar conclusions were drawn for the production of methanol and hydrogen from biomass [6].

A constraint was incorporated into this design requiring the process to remain “electrical energy neutral.” That is, the process was designed without allowing for purchase of coal, natural gas, or electricity for plant operations. Because the heat and power requirements of the process cannot be met through char combustion alone, the following options were considered:

- Additional biomass could be used to heat and power the process. This option increases the biomass processing rate beyond 2,000 tonnes per day and potentially voids some of the feedstock cost assumptions.
- Fossil fuels (coal or natural gas) could be added directly to provide additional fuel.
- Some syngas could be diverted from liquid fuel production for heat and power production. This option makes the design energy self-sufficient but lowers the overall product yield.

It was decided that the first and second options would not be considered and that the third option would be used to satisfy balance-of-plant heat and power requirements. In designs that result in excess heat or power production, energy in the form of electricity will be exported to the grid for a co-product credit.

NREL worked with Harris Group Inc. to identify realistic process configurations and equipment costs for critical, high-priced equipment in each process area. Aspen Icarus Process Evaluator (IPE) 2006.5 was utilized for cost estimations for generic, lower-cost equipment like knock-out drums and standard heat exchangers.

The biomass conversion parameters used in this design are based on a slate of research targets that NREL and DOE have specified for the period spanning 2006 to 2012. These targets are discussed in this report and summarized in Appendix I. The economics of the process design use the best available equipment and raw material cost estimates with an “nth-plant” project cost structure and financing. The 2012 nth-plant MESP computed in this report is \$2.05 per gallon in

2007 dollars. This MESP value corresponds to a gasoline equivalent price of \$3.11 per gallon. The gasoline equivalent price is determined by multiplying the MESP by the ratio of volumetric energy contents of gasoline and ethanol ($\$2.05 \text{ MESP} * 115,500 \text{ Btu per gallon of gasoline} / 76,000 \text{ Btu per gallon of ethanol}$).

Future modifications to the process design presented here will be reflected annually through NREL's State of Technology (SOT) reports. These reports ensure that the process design and its associated costs incorporate the most current data from NREL, other DOE-funded research programs, and external sources, including up-to-date equipment and installation costs.

1.2 Technoeconomic Analysis Approach

The general approach used in the process design, process model, and economic analysis is depicted in Figure 1. This design report includes information from completed and ongoing research at NREL and other national laboratories, detailed reviews of commercially available technologies, process modeling using Aspen Plus software, equipment cost estimation through vendor quotes and Aspen Icarus software, and discounted cash flow analysis. The technoeconomic analysis ultimately provides a minimum ethanol selling price (MESP) based on the financial assumptions in Table 1.

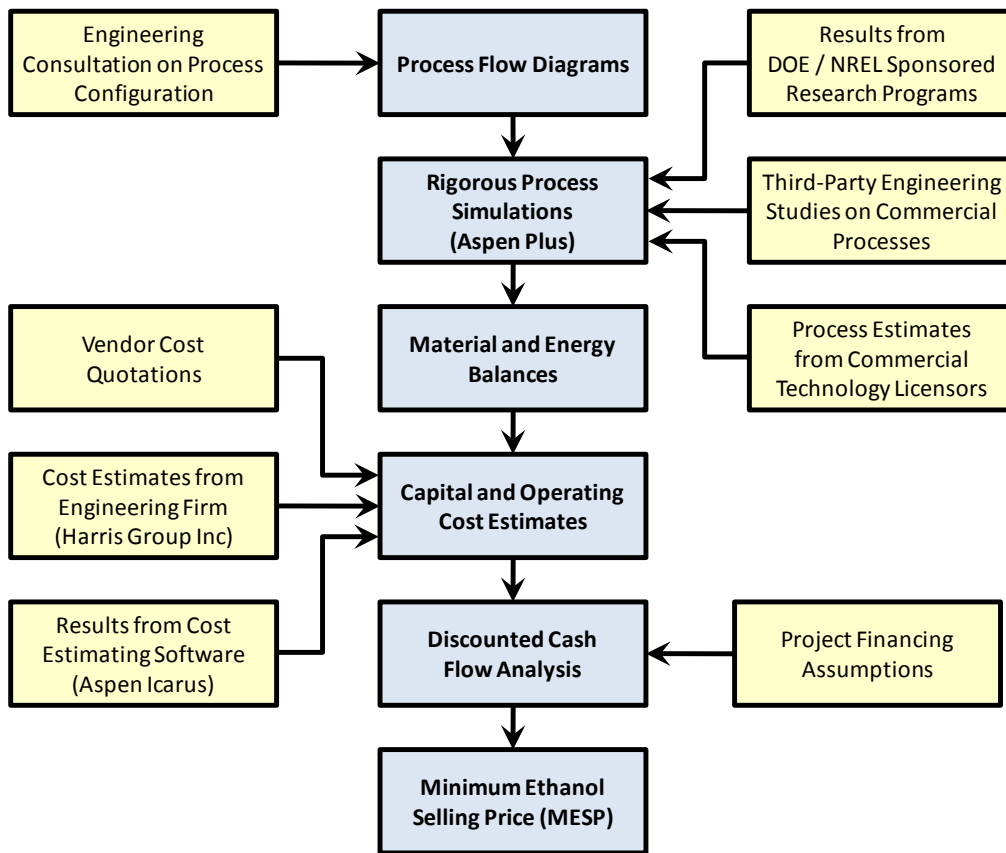

Figure 1. Approach to thermochemical ethanol process design and analysis

Aspen Plus Version 2004.1 was used to develop mass and energy balances for the process. The plant operations are separated into seven major process areas:

- Area 100: Feed handling and drying
- Area 200: Gasification
- Area 300: Synthesis gas cleanup
- Area 400: Alcohol synthesis, syngas compression, and acid gas removal
- Area 500: Alcohol separation
- Area 600: Steam system and power generation
- Area 700: Cooling water and other utilities

1.3 Definition of n^{th} -Plant Economics

The technoeconomic analysis reported here uses n^{th} -plant economics. The key theoretical assumption associated with n^{th} -plant economics is that several plants using the same technology have already been built and are operating. In other words, the assumption reflects a future in which a successful industry has been established with many operating plants. Because the technoeconomic model is a tool used primarily for (1) studying new process technologies or (2) comparing integrated schemes in order to comment on their relative economic impact, it is prudent to ignore artificial inflation of project costs associated with risk financing, longer start-ups, equipment overdesign, and other costs associated with pioneer plants, as these overshadow the real economic impact of advances in conversion science or process engineering research. At the very least, n^{th} -plant economics should help to provide justification and support for early technology adopters and pioneer plants.

Because equipment costs in this design report have been estimated explicitly, the n^{th} -plant assumptions apply primarily to the factored cost model used to determine the total capital investment from the purchased equipment cost and to the assumptions applied for plant financing. The n^{th} -plant assumption also applies to operating parameters, such as process uptime and start-up time. A summary of the n^{th} -plant assumptions applied in this report are listed in Table 1. These financial assumptions are consistent with assumptions used for other economic analyses done for DOE's Office of Biomass Program (OBP), with some deviations to reflect the uniqueness of this process.

Table 1. Summary of nth-Plant Assumptions for Technoeconomic Analysis

Description of Assumption	Assumed Value
Internal rate of return (IRR)	10%
Plant financing by equity / debt	40% / 60% of total capital investment
Plant life	30 years
Income tax rate	35%
Interest rate for debt financing	8.0% annually
Term for debt financing	10 years
Working capital cost	5.0% of fixed capital investment (excluding land purchase cost)
Depreciation schedule	7-Year MACRS schedule [7]
Construction period (spending schedule)	3 years (8% Y1, 60% Y2, 32% Y3)
Plant salvage value	No value
Start-up time	3 months
Revenue and costs during start-up	Revenue = 50% of normal Variable costs = 75% of normal Fixed costs = 100% of normal
On-stream percentage after start-up	96% (8,410 operating hours per year)

Examples have shown that technoeconomic models can reasonably predict the production costs of biofuels. Tao and Aden [8] performed a survey of technoeconomic models of existing biofuels production (corn ethanol, sugarcane ethanol, and conventional soy biodiesel) from published literature. These studies were normalized to a consistent year-dollar value and feedstock cost (where applicable) and compared to published market studies of the same biofuels. This comparison, shown in Table 2, indicates that technoeconomic (TE) models were able to predict the actual cost of production of these biofuels within an accuracy of $\pm 20\%$. The variability in accuracy is largely a result of the variability in factored capital cost estimates used in these models.

Table 2. Comparison of Market Studies and TE Analyses for Existing Biofuels

Fuel	Market Study	TE Model	Error in TE Prediction
Corn ethanol	\$1.53/gal [9]	\$1.54/gal [10]	0.7 %
Sugarcane ethanol	\$1.14/gal [9]	\$1.29/gal [11, 12]	13.2%
Soy biodiesel	\$2.15/gal [13]	\$2.55/gal [14]	18.6%

The consistency of TE predictions compared to market study values is not surprising because the TE model developers were able to compare their results to real economics and make adjustments

as necessary. Also, the feedstock costs for the fuels presented in Table 2 make up a high percentage of the total production cost, making errors in the remaining production cost estimates less impactful on the fuel selling price. Developing a technoeconomic model for a pre-commercial technology, such as the woody biomass-to-ethanol process described in this report, is based on less specific information and has to be rooted in current understanding of the state of the technology, feasible improvements at the time of the analysis, and good engineering practice. There will be more uncertainties in the cost predictions from such studies. Using the nth-plant philosophy, it is assumed that the pre-commercial technoeconomic model reflects the production economics for the technology's mature future.

1.4 Estimation of Capital Costs

Capital costs were estimated using a variety of resources. For sub-processes that utilize well-developed technologies and can be purchased as modular packages (e.g., sulfur recovery unit and refrigeration), an overall package cost was used instead of the sum of costs for individual pieces of equipment. Costs for common process equipment (e.g., tanks, drums, pumps, and simple heat exchangers) were estimated using Aspen IPE 2006.5 costing software, which uses the Q1 2007 cost basis. Unit operations that are specific to thermochemical ethanol production (e.g., gasifier, tar reformer, and alcohol synthesis reactor) were priced through vendor quotations. It is important to note that capital cost estimates for pre-commercial technologies like the gasifier and tar reformer were derived from current vendor quotes for first-of-its-kind fabrications, which should be higher than costs for mature nth-plant technologies. The cost assumptions for the gasifier and tar reformer are discussed in detail in Section 3.2.3.

The original (base) purchased equipment costs reflect the base case for equipment size and cost year. Equipment sizes required for the process may vary from the original base case, requiring adjustment of the equipment costs. Instead of re-pricing equipment after minor changes in size, exponential scaling is applied to adjust the purchased equipment costs using Equation 1:

$$\text{Scale-Up Equipment Cost} = \text{Base Equipment Cost} \left(\frac{\text{Scale-Up Capacity}}{\text{Base Capacity}} \right)^n \quad (\text{Eq. 1})$$

The characteristic scaling exponent, n , is typically in the range of 0.6 to 0.7 for process equipment. The sizing parameters are based on a characteristic of the equipment related to production capacity, such as inlet flow for a process vessel or heat transfer duty for a heat exchanger. Equation 1 assumes that all other process parameters (pressure, temperature, etc.) remain constant relative to the base case. Scaling exponents were determined from the following sources:

- Vendors' estimates of scaling exponent or inference from vendor quotes when multiple quotes were available for equipment of various processing capacities.
- Development of correlations by multiple estimates from Aspen IPE software.
- Standard reference from published sources such as Garrett [15], Peters, Timmerhaus and West [16], and Perry et al. [17].

When cost data were not available in 2007 dollars, costs were adjusted with *Chemical Engineering's* (CE) Plant Cost Index [18] using Equation 2:

$$\text{Corrected Equipment Cost} = \text{Base Equipment Cost} \left(\frac{\text{2007 Cost Index Value}}{\text{Base Year Cost Index Value}} \right) \quad (\text{Eq. 2})$$

The CE indices used in this study are listed and plotted in Figure 2. The index data show a sharp increase after 2003 due to increases in global steel demand and a dip in 2009 due to the global recession. The August 2010 index was used for 2010 since that was roughly the time when most of the recent cost quotes were obtained.

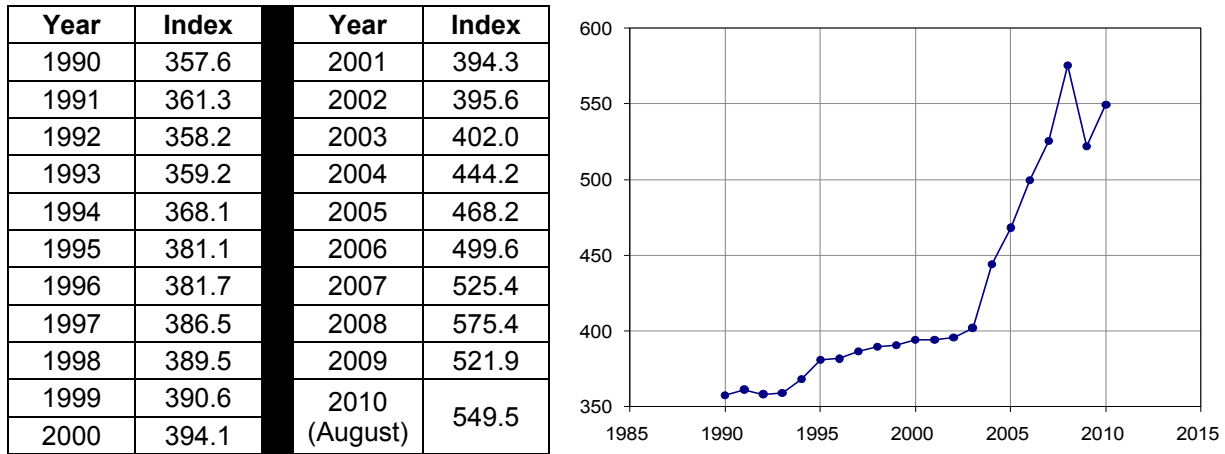

Figure 2. Chemical Engineering's Plant Cost Index data

Once the total purchased equipment costs (TPEC) were determined, scaled, and time-corrected, an equipment installation factor was applied to estimate the total installed cost (TIC) for the equipment or process unit including associated piping, instrumentation and controls, electrical systems, buildings, yard improvements, and direct labor per Equation 3, where $f_{Installation}$ is the installation factor:

$$\text{Total Installed Cost (TIC)} = f_{Installation} * \text{Total Purchased Equipment Cost (TPEC)} \quad (\text{Eq. 3})$$

Where possible, specific installation factors from vendor quotes or published data were applied to equipment or process units to estimate the total installed cost (TIC). When specific data was not available for equipment or package units, a default installation factor of 2.47 was applied to determine TIC. This value is based on the direct cost factor method presented by Peters, Timmerhaus, and West [16] for a solid-fluid processing plant, which is summarized in Table 3. Details for TPEC, installation factors, and TIC values for each process area are presented in Section 3. Harris Group Inc. prepared a detailed list of direct costs included in the equipment installation factors. The list is provided in Appendix K of this report.

Table 3. Direct Cost Factors for Estimating Installed Equipment Costs [16]

Direct Cost Description	Cost as Fraction of TPEC
Total purchased equipment cost	1.00
Purchased equipment installation	0.39
Instrumentation and controls	0.26
Piping	0.31
Electrical systems	0.10
Buildings	0.29
Yard improvements	0.12
Total installation factor ($f_{Installation}$)	2.47

Once the scaled TICs were determined, overhead and contingency factors were applied to determine a total capital investment (TCI) cost. The TCI along with plant operating expenses serves as the basis for the discounted cash flow analysis. The discounted cash flow analysis then yields the MESP, the primary metric by which the thermochemical ethanol process can be compared to alternate fuel production designs.

2 Plant Design Basis

2.1 Feedstock and Plant Size

Forest resources were chosen as the primary feedstock for the thermochemical ethanol process design based upon expected availability from a 2005 joint DOE-USDA report assessing the feasibility of a billion-ton annual supply of biomass as feedstock for the bioenergy and bioproducts industries [19]. The assessment describes the potential for biomass availability to increase significantly with advancements in technology such as higher crop yields and improved residue collection. Potential biomass production rates are provided in Figure 3. The data set “High Yield Growth With Energy Crops” represents availability projections based on improvements in agricultural technology and the creation of a new energy crop industry. The data set “High Yield Growth Without Energy Crops” considers only improvements in agricultural technology. The data set “Existing and Unexploited Resources” represents biomass availability as of 2005.

Studies for biochemical ethanol production have focused on using agricultural resources such as corn stover as feedstocks due to their lower lignin content relative to forest resources. Lignin does not readily break down in biochemical processes. Therefore, feedstocks with higher lignin content result in lower ethanol yields in biochemical processes. Because the thermochemical process by gasification is able to convert all feedstock carbon, including lignin, high-lignin forest resources serve as the base feedstock for the thermochemical plant design.

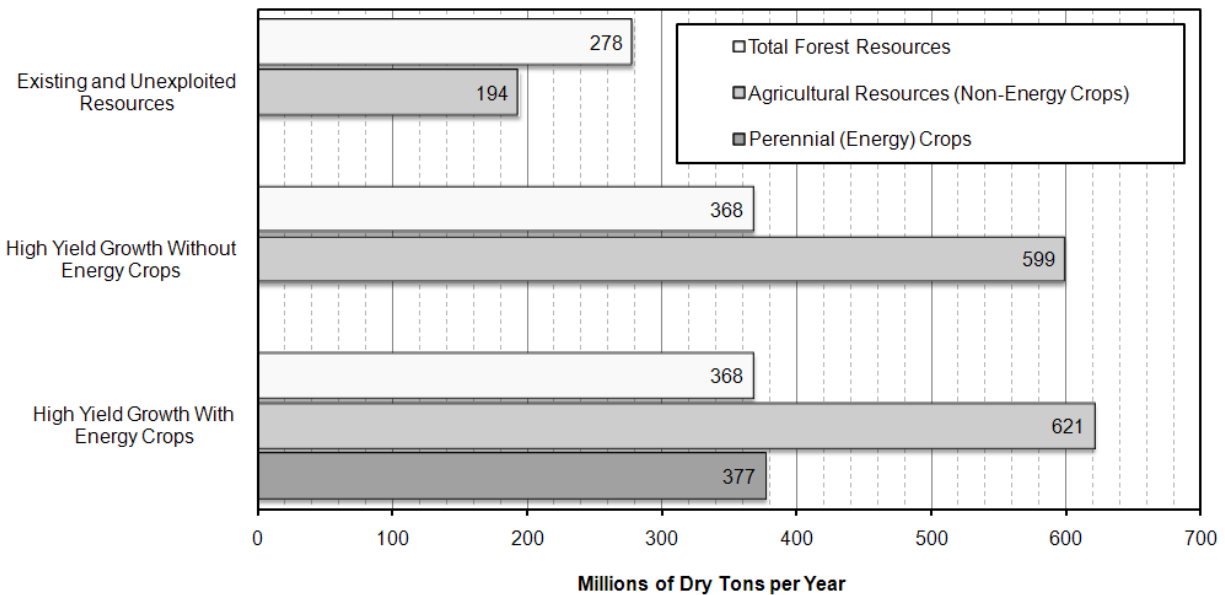

Figure 3. Current and predicted availability of biomass

The ultimate analysis for the feed considered in this study is presented in Table 4. The information sources for Table 4 indicate marginal differences in the ultimate analysis between hybrid poplar, used in the 2007 report [2], and pine, used as the basis for Idaho National Laboratory’s (INL) feedstock model. While this design maintains the wood composition from the 2007 report, the sulfur content was decreased from 0.09% to 0.03%, which is more

representative of woody material. The assumed moisture content of the biomass feedstock prior to drying is 35 wt % at the plant gate, with an additional 5 wt % moisture loss during in-plant processing, per specifications from INL. A detailed description of INL’s feedstock supply system is provided in Appendix F. The effects of changing compositions and moisture contents are also examined as part of the sensitivity analysis, presented in Section 5.

Table 4. Ultimate Analysis of Woody Biomass Feedstock

Component	Weight % (Dry Basis [20, 21])
Carbon	50.94
Hydrogen	6.04
Nitrogen	0.17
Sulfur	0.03
Oxygen	41.90
Ash	0.92
Heating value ^a (Btu/lb)	8,601 HHV
	7,996 LHV

^a Calculated using the Aspen Plus Boie correlation.

The design capacity for this study is 2,000 dry metric tonnes per day (2,205 dry tons per day), which matches that of previous design reports for both biochemical [22] and thermochemical [2] ethanol processes. With an expected 8,410 operating hours per year (96% on-stream factor / availability), the annual feedstock requirement is approximately 700,000 dry metric tonnes per year (772,000 dry tons per year). The assumed on-stream factor allows approximately 15 days of planned and unplanned downtime per year, which is consistent with mature (nth-plant) petroleum refining technologies such as fluid catalytic cracking (FCC) units [23]. The impact of lower on-stream factors is shown as part of the sensitivity studies in Section 5. The feedstock is assumed to be delivered to the plants from satellite storage and processing facilities, details of which are described in Appendix F.

The delivered feedstock cost was estimated using INL’s model. This cost of \$61.57 per dry ton includes all capital costs, operating costs, and dry matter losses associated with feed delivery, drying, and handling as determined by INL. Up to the throat of the gasifier, the only process input that is added to the feedstock is flue gas waste heat for drying the feedstock from 30% moisture (after in-plant handling) to 10% moisture (at the gasifier).

Impacts of plant size and feedstock cost on the MESP are included in the sensitivity analysis in Section 5.

2.2 Process Overview

A block flow diagram of the current design is shown in Figure 4. Detailed process flow diagrams (PFDs) with material and energy balances are provided in Appendix E.

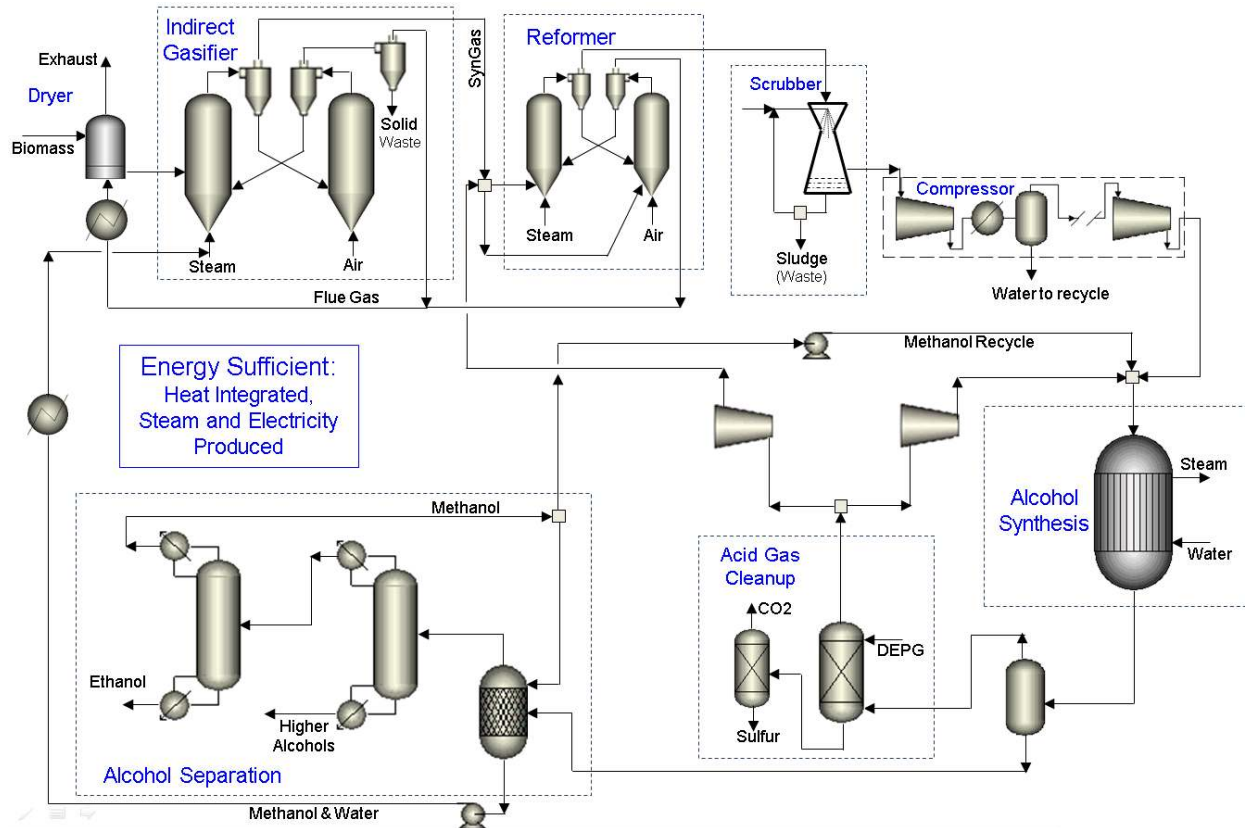

Figure 4. Simplified flow diagram for the thermochemical process

The proposed thermochemical ethanol production process includes the following steps:

- *Feed handling and preparation.* The biomass feedstock is dried to 10 wt % moisture using hot flue gases from the char combustor and tar reformer catalyst regenerator.
- *Gasification.* Biomass is indirectly gasified. Heat for the gasification reactions is supplied by circulating synthetic olivine¹ sand that is pre-heated in a char combustor and fed to the gasifier. Conveyors and hoppers feed biomass to the low-pressure entrained flow gasifier. Steam is injected into the gasifier to stabilize the flow of biomass and olivine through the gasifier. Within the gasifier, biomass thermally deconstructs to a mixture of syngas components (CO, H₂, CO₂, CH₄, etc.), tars, and solid char containing residual carbon from the biomass and coke deposited on the olivine. Cyclones at the exit of the gasifier

¹ Calcined magnesium silicate, primarily Enstatite (MgSiO₃), Forsterite (Mg₂SiO₃), and Hematite (Fe₂O₃). A small amount of magnesium oxide (MgO) is added to the fresh olivine to prevent the formation of glass-like agglomerations formed through biomass potassium interacting with silicate compounds.

separate the char and olivine from the syngas. The solids flow to the char combustor where the char is burned in air in a fluidized bed, resulting in olivine temperatures greater than 1,800°F (982°C). The hot olivine and residual ash is carried out of the combustor by the combustion gases and separated using a pair of cyclones. The first cyclone captures olivine while the second cyclone captures ash and olivine fines. Hot olivine flows back into the gasifier, completing the gasification loop. The hot flue gas from the char combustor is utilized for heat recovery and feedstock drying. Ash and olivine fines are cooled, moistened to minimize dust, and removed as waste.

- *Gas cleanup.* Syngas cleanup is defined in this report as reforming of tars, methane, and other hydrocarbons followed by cooling, quench, and scrubbing of the syngas for downstream operations. The water gas shift reaction also occurs in the reformer. Tars, methane, and light hydrocarbons are reformed to syngas in a circulating, fluidized, solid catalyst system that resembles a small-scale fluid catalytic cracker (FCC), complete with reforming and regeneration operations in separate beds. The syngas is reacted with tar reforming catalyst in an entrained flow reactor at a gas hourly space velocity of approximately $2,500 \text{ h}^{-1}$. The catalyst is then separated from the effluent syngas in a cyclone. From the cyclone, the spent catalyst flows to the catalyst regenerator vessel where residual coke from the reforming reactions is removed from the catalyst by combustion. The hot catalyst is separated from the combustion flue gas in the regenerator cyclone and flows back to the tar reformer reactor to provide the energy necessary for the reforming reactions. Additional syngas and unreacted gases from the alcohol synthesis reactor are also combusted in the regenerator to provide all the heat necessary for the endothermic reforming reactions. A similar approach is documented in a patent application by Rentech [24]. The hot reformed syngas is cooled through heat exchange with other process streams and scrubbed with water to remove persistent impurities like particulates, ammonia, halides, and recalcitrant tars. Scrubber water is purged and treated continuously at an on-site wastewater treatment facility. After heat recovery, the remaining low-quality heat in the flue gas from the catalyst regenerator is utilized for feedstock drying.
- *Alcohol synthesis.* Cooled low-pressure syngas enters a six-stage centrifugal compressor system where the pressure is increased to approximately 3,000 psi (207 bar). The pressurized syngas is fed to the tube sides of two vertical tubular reactors (shell and tube type) operating in parallel. A sulfide-type mixed alcohol catalyst is packed within the tubes of the reactor, which is oriented in a down-flow configuration. Reactions at above 570°F (300°C) convert a portion of the syngas to oxygenate and hydrocarbon products. Heat from the reactions is removed by steam generation in the shell side of the tubular reactor. The reactor effluent consisting of mixed alcohols, gaseous by-products (such as CO₂ and methane), and unconverted syngas is cooled through heat exchange with other process streams. As the reactor effluent cools, alcohols and water are condensed and sent to downstream separation and purification equipment. Unconverted syngas and gas-phase by-products flow to an acid gas removal system where a physical solvent (dimethyl ether of polyethylene glycol or DEPG) removes most of the H₂S and a portion of the CO₂. The DEPG system requires refrigeration, which is provided by an ammonia-water absorption refrigeration system. Absorption refrigeration has the advantage of using heat as the major driver instead of electricity used in conventional refrigeration systems. Once the

H₂S and CO₂ are removed, the syngas is recompressed to make up for pressure losses through the reactor and acid gas cleanup system, and is recycled to the alcohol synthesis reactors. A portion of the unconverted syngas is expanded through a power recovery turbine and recycled to the gas cleanup and conditioning section as feed to the tar reformer and fuel for the tar reformer catalyst regenerator. The CO₂ and H₂S from the acid gas removal system are further processed in an amine-based acid gas enrichment unit and a Merichem LO-CAT sulfur recovery unit where H₂S is converted to elemental sulfur and stockpiled for disposal. An intermediate CO₂-rich stream generated from the acid gas enrichment system is recycled to the reformer catalyst regeneration combustor to recover heat from residual combustible components in the stream and to prevent the emission of hydrocarbons into the atmosphere.

- *Alcohol separation.* Cooled crude alcohols are de-pressurized and de-gassed in a flash separator. The evolved gases are recycled to the gas cleanup section as a feed to the tar reformer. The depressurized liquid stream is dehydrated using a molecular sieve system. Downstream of the molecular sieve, the dehydrated alcohol stream is introduced to the crude alcohol distillation column, which separates methanol and ethanol from higher molecular weight alcohols. The overhead stream from the crude alcohol column is separated in a second column to a crude methanol stream and an ethanol product that meets ASTM fuel ethanol specifications (provided in Appendix J). The methanol overhead stream is split and utilized for the following purposes:
 - 15% (in the base case design) is sent to the molecular sieve system, which is adequate to regenerate the molecular sieve beds by flushing the adsorbed water [25]. The resulting methanol/water mixture is returned to the gasifier as a source of steam for fluidization.
 - From 0% to 15% (11% in the base case design) is chilled and mixed with an H₂S-rich stream from the sulfur recovery system. H₂S dissolves in the cold methanol and the resulting solution is pumped to the inlet of the alcohol synthesis reactor, providing sulfur for catalyst activity management. The amount of H₂S is adjusted to maintain an average concentration of 70 ppmv at the reactor inlet. It should be noted that a range of 0% to 15% is specified because the required amount of H₂S recycle will depend on the amount of H₂S (from sulfur present in the biomass feedstock) entering the alcohol synthesis reactor with fresh syngas.
 - A small vapor portion (5 wt % in the base case design) containing some methanol with gases and volatile compounds is utilized as fuel for the tar reformer catalyst regenerator.
 - The remaining material (69% in the base case design) is recycled to the alcohol synthesis reactor to improve ethanol yields.
- *Heat and power.* A conventional steam cycle produces steam for direct injection into the gasifier and reformer. Indirect steam is used for distillation, absorption refrigeration, and the acid gas strippers in the DEPG and acid gas enrichment units. Electricity is generated using two steam turbines, with intermediate reheat, to meet the demands of the plant. As mentioned earlier in the alcohol synthesis section, additional electricity is generated by sending a portion of the pressurized unreacted gases from the alcohol synthesis reactor through turbo-expanders. The majority of electricity is used for syngas compression. The

steam cycle is integrated with the biomass conversion process. Pre-heaters, steam generators, and super-heaters are integrated within the process design to generate the steam from boiler feed water. Process condensate is recycled to the steam cycle, de-gassed, treated, and combined with makeup water.

- *Heat integration.* Previous analyses of gasification processes have shown the importance of properly utilizing the heat from the high temperature streams to improve efficiency of the overall thermochemical ethanol plant design [2, 5]. A pinch analysis was performed and a heat exchanger network was designed for this ethanol production process. The pinch concept offers a systematic approach to optimizing the energy integration of the process. Details of the pinch analysis are provided in Section 3.9.
- *Cooling water.* A cooling water system is included in the Aspen Plus model to determine the requirements of each cooling water heat exchanger within the biomass conversion process as well as makeup water and power requirements. In a version of the design that includes additional water optimization, process condensate is treated and combined with the cooling water makeup to reduce fresh water consumption.

2.3 Aspen Plus Model

An Aspen Plus Version 2004.1 simulation was used as the basis for this report. The gaseous and liquid components that are important for the process were included as distinct molecular species using Aspen Technology's component properties database. The biomass feedstock, ash, and char components were modeled as non-conventional components. The thermochemical ethanol design requires processing of three different phases of matter (solid, liquid, and gas phases). Therefore, no single physical property package was sufficient to describe the entire plant from feed to products. Different property packages were used within the Aspen Plus simulation to more accurately represent chemical component behaviors in specific process areas. The Redlich-Kwong-Soave with Boston-Mathias correction (RKS-BM) equation of state was used throughout much of the process simulation for high temperature, high pressure gas and liquid phase behavior. The non-random, two-liquid (NRTL) option with ideal gas properties was used for alcohol separation calculations. The ASME 1967 steam table correlations were used for the steam cycle calculations. The ELECNRTL package was used to model the electrolyte species in the quench water system. The physical solvent absorption system and the ammonia-water absorption refrigeration system were modeled in separate simulations and their results were incorporated into the main model. The perturbed-chain statistical associating fluid theory (PC-SAFT) package was used to model physical solvent (DEPG) absorption processes in a separate simulation.

3 Process Design and Cost Estimation

The process design for the thermochemical ethanol production facility is based on current data and R&D performance goals for catalytic reforming and alcohol synthesis. The design therefore presents the anticipated results of achieving those technical goals. The specific technical goals are presented in Appendix I.

The process design broadly consists of the following areas:

- Feed handling and drying
- Gasification
- Gas cleanup
- Syngas compression, alcohol synthesis, and acid gas removal
- Alcohol separation
- Integrated steam system and power generation cycle
- Cooling water and other utilities

The following sections present process overviews, design bases, and installed equipment cost estimations for each process area of the plant. Heat exchanger equipment sizes and costs are discussed separately in Section 3.9.

3.1 Area 100: Feed Handling and Drying

The following section presents an overview of the feed handling and drying facilities. The basis for the system design is discussed, and cost estimates for the feedstock are provided based on capital requirements and operating costs of the facilities. The information provided is based on work done at the Idaho National Laboratory (INL).

3.1.1 Area 100 Overview

This area of the process accommodates the delivery of biomass feedstock from the field to the biorefinery, short term on-site storage, and the preprocessing/preparation of the feedstock for conversion in the gasifier. The design is based upon a specific woody biomass feedstock – southern pine trees. Process flow diagrams (PFD) for the feed handling and drying area are shown in PFD-P820-A101 and PFD-P820-A102 in Appendix E. A simplified flow diagram for the woody biomass feedstock supply system is provided in Figure 5.

Standing southern pine trees are cut with an average diameter at breast height (DBH) of 8–10 inches using a feller buncher with an accumulator arm. Material is harvested 8 hours per day, 5 days per week, and 50 weeks per year. The cut trees are piled on the ground and transpirationally dried from 50% moisture content (MC) to approximately 35% MC, wet basis [26–29]. A grapple skidder drags the piled trees to the landing, and the trees are piled near the flail chain debarker. The flail chain debarker is equipped with a grapple on the end that loads material from the deck into the flail chain debarker. Approximately 20% of the material is ejected during this step. The ejected material is bark, tree tops, and limbs. The debarked, delimbed logs are fed into the chipper, which uses a 2-inch internal screen. Pneumatics may be integrated into the chipper, which would increase grinder efficiency and provide additional drying beyond that which is

accomplished in the absence of pneumatics. Chips are ejected from the chipper directly into a flat floor chip trailer, and once the truck reaches capacity the material is taken to the biorefinery.

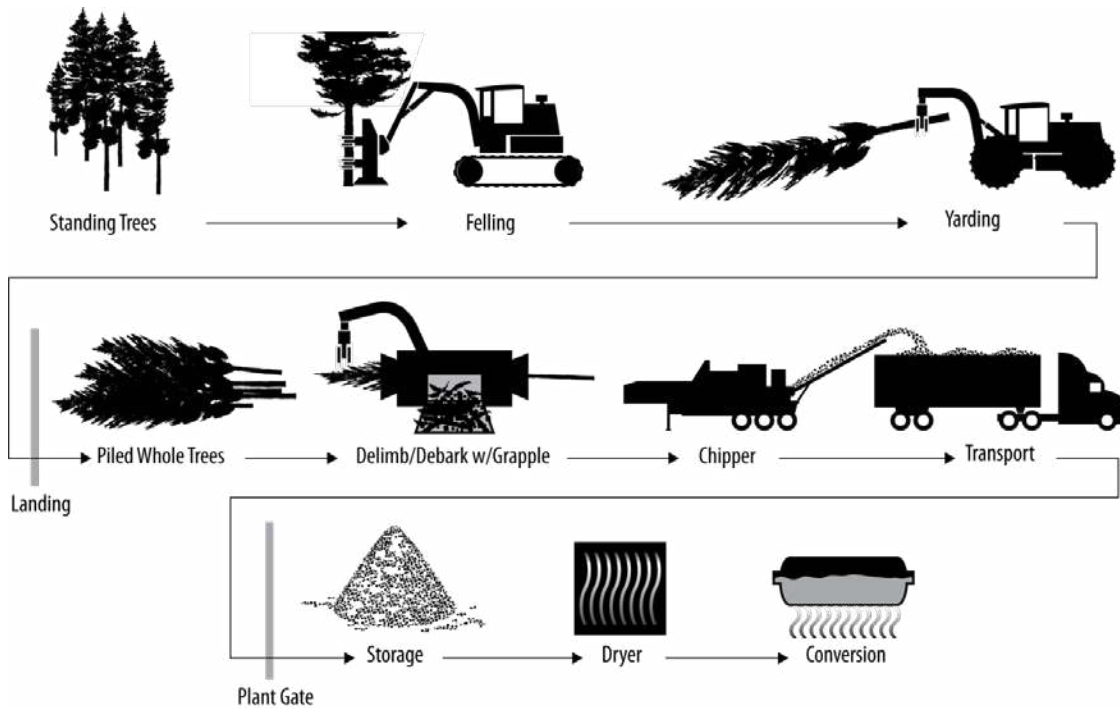

Figure 5. Woody biomass feedstock supply system

Note: Only biomass material streams are shown for simplification. See Appendix F for full schematic.

To increase material availability to the system, reduce dry matter losses, and meet cost targets, some of the limbs are fed through the chipper in a stream separate from the clean chips. This slash stream, as we denote it, is passed through a trommel screen to sift out high-ash dirt and bark. However, it is assumed that some of the ash and bark have already been separated from the limbs and tops during the high-impact flail process. The cleaned slash stream is also ejected into the back of a truck and transported to the biorefinery. At the biorefinery, the trucks are weighed and a truck dumper unloads the truck contents into a hopper. A dust collection system is present during unloading to prevent excessive dust accumulation and to limit dry matter losses. The chips are cleaned using an electromagnet, moisture is monitored, and material is passed over a vibratory conveyor to remove any excess dirt/ash that may still be present. The material is then conveyed into a pile using a circular stacker and an overpile reclaimer. A five-day supply of material is stored at the refinery. The pile, which acts as a queue, is on an asphalt pad with a long grate running through it that allows material to flow out of the pile, and up to an additional 5% moisture loss results from forced-air ambient air drying. A front end loader continuously pushes material onto the grate to maintain flow. A conveyor located at the bottom of the pit under the grate conveys the biomass into a waste heat dryer, where the biomass is dried to 10% moisture content using hot flue gas from the biomass conversion processes. From the dryer, the biomass is conveyed into a metering bin where it is fed into the conversion process.

3.1.2 Area 100 Design Basis

Table 5 presents the design basis for the feed handling and drying area of the plant. The primary objective of this equipment is to dry the biomass feed from 35 wt % moisture content to 10 wt % moisture content at the inlet to the gasifier in order to maximize the efficiency of the gasifier and minimize the required size of downstream equipment.

Table 5. Design Basis for Feed Handling and Drying Area

Biomass feed type	Wood from southern pine trees
Biomass feed rate (dry basis)	2,000 metric tonnes per day
Biomass feed moisture content	35 wt %
Additional ambient drying at plant	5 wt %
Target biomass moisture content to gasifier	10 wt %

Assuming biomass delivery by truck with a per truck capacity of 25 tons [30] of biomass at 35 wt % moisture content, approximately 136 truck deliveries per day would be required to operate the plant at design capacity of 2,000 metric tonnes per day (2,205 tons per day).

3.1.3 Area 100 Equipment Cost Estimations

INL, in partnership with other national labs, has developed a woody supply system design and modeled the costs using a woody biomass supply system model. The model is continuously refined through input from industry, academia, and national labs to improve the accuracy of the model parameters and output. Future model iterations will identify key sensitivities in the system in terms of costs, material flows, and equipment performance parameters.

Table 6 shows the costs associated with the operations in the supply system (Figure 5). The data presented include unit operation costs for the design case scenario for the supply of woody biomass (pulpwood-size southern pine) to a gasification process. All values are presented in units of 2007 U.S. dollars per dry ton of feedstock.

Table 6. Unit Cost Breakdown for Woody Biomass Feedstock (Southern Pine)

Unit Operation	Cost Contribution (\$/dry U.S. ton)
Total feedstock cost through gasifier reactor inlet	\$61.57
Total feedstock logistics (harvest through insertion to gasifier reactor inlet)	\$46.37
Total cost of grower payment	\$15.20
Harvest and collection	\$18.75
Capital costs	\$5.60
Operating costs	\$13.15
In-field preprocessing	\$11.42
Capital costs	\$4.20
Operating costs	\$7.22
Transportation and handling	\$8.95
Capital costs	\$2.95
Operating costs	\$6.00
In-plant receiving, storage, queuing, feed preprocessing	\$7.25
Capital costs	\$2.10
Receiving and handling costs	\$2.10
Other operating costs	\$3.05

The total delivered cost of woody biomass from pulpwood-size pine trees, as determined from the woody biomass supply system model, is \$46.37/dry U.S. ton (short ton). When the grower payment of \$15.20/dry U.S. ton is added, the total feedstock cost through the gasifier inlet is \$61.57/dry U.S. ton. This figure includes ownership costs and operating costs.

The supply system model incorporates a combination of values and relationships obtained from other national laboratories, publications, consultation with academia and staff from the U.S. Department of Agriculture and the U.S. Forest Service, and published and unpublished INL data. Further details on the model are provided in Appendix F.

Equipment lists for the feed handling and drying area, as well as other pertinent information, are provided in Appendix A and Appendix B. All purchased and installed equipment costs for this area are shown as zero for the plant economics because all of these capital costs are included in the delivered feedstock cost.

3.2 Area 200: Gasification

The following section presents an overview, basis for design, and cost estimates for construction of the gasification facilities.

3.2.1 Area 200 Overview

This area of the process converts a mixture of dried feedstock (10 wt % moisture) and steam to syngas and char. Heat is provided indirectly through circulation of olivine (heat transfer media) that is heated by the combustion of char downstream of the gasifier. Steam is injected into the gasifier to serve as a fluidizing medium and reactant at the high gasifier temperatures. A simplified flow diagram of the gasification process area is provided in Figure 6.

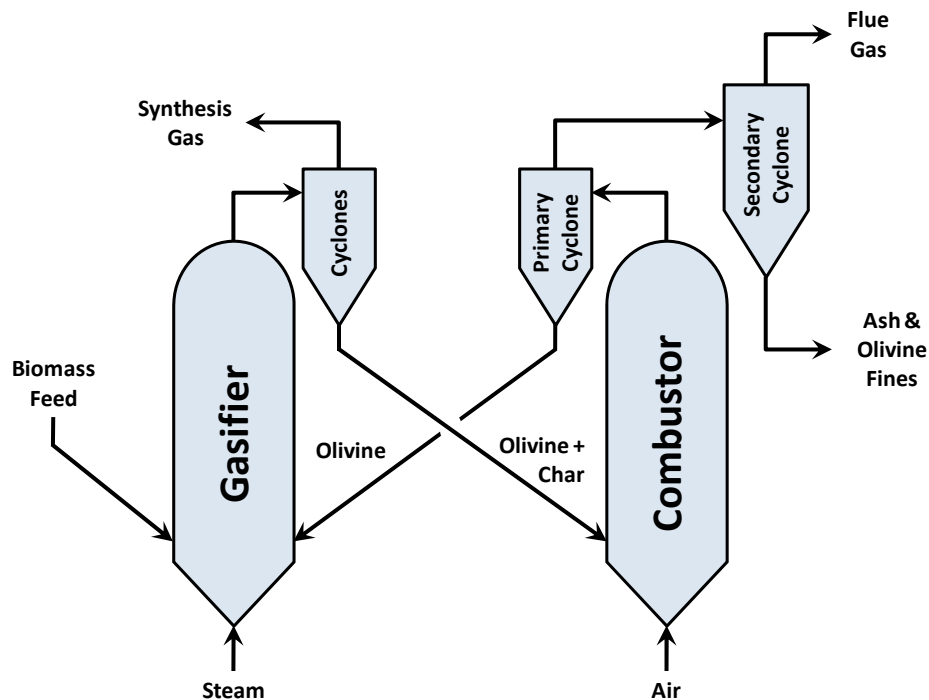

Figure 6. Simplified process flow diagram of gasification area

After going through the feed handling and drying area, the dried wood chips enter the gasification area, as shown in PFD-P820-A201 in Appendix E. The design includes two parallel gasifier trains, each with a biomass processing capacity of 1,000 dry metric tonnes per day. The gasifier (R-201) used in this analysis is a low-pressure indirectly-heated circulating fluidized bed (CFB) gasifier. The gasifier output was modeled using correlations based on run data from the Battelle Columbus Laboratory (BCL) 9 tonne/day test facility. These correlations are provided for reference in Appendix G.

Heat for the gasification reactions is supplied by circulating a hot medium between the gasifier vessel and the char combustor (R-202). In this case the medium is synthetic olivine – calcined magnesium silicate consisting of Enstatite (MgSiO_3), Forsterite (Mg_2SiO_3), and Hematite (Fe_2O_3). A small amount of magnesium oxide (MgO) is added to the fresh olivine. The MgO rejects the potassium present in biomass as ash by forming a high melting ($\sim 2,370^\circ\text{F}/1,300^\circ\text{C}$) ternary eutectic with the silica, thus sequestering it. Without MgO addition, the potassium will form glass (K_2SiO_4) by interacting with the silica in the system. K_2SiO_4 has a low melting point

(~930°F/500°C) and its formation would cause the bed media to become sticky, agglomerate, and eventually defluidize. Potassium carry-over from the gasifier to downstream processes is also significantly reduced with the addition of MgO. The biomass ash is assumed to contain 0.2 wt % potassium. The MgO molar flow rate is set at 2 times the molar flow rate of potassium. With an expected potassium inlet flow rate of 0.087 lb-moles per hour, the estimated MgO requirement is 0.174 lb-moles per hour or 7.0 lb per hour.

The fluidization medium in the gasifier is steam supplied from the steam cycle (area 600). The steam-to-feed ratio is set to 0.4 lb of steam per lb of bone dry biomass feedstock. The gasifier is designed to operate at 18 psig to allow for pressure drops in subsequent equipment so that no further compression is required until after gas cleanup and quench. The average olivine circulation rate is approximately 27 lb of olivine per lb of bone dry wood. Fresh olivine is added to compensate for losses from the gasifier and combustor cyclones.

The operation of the gasifier and char combustor resembles that of a fluid catalytic cracker (FCC), a common oil refinery unit operation. Like an FCC, the gasifier and char combustor will remain in heat balance by producing (gasifier) and burning (char combustor) enough char to satisfy the energy requirements of the operation. The amount of char formed in the gasifier is an inverse function of temperature. Unless supplemental fuel is provided to the char combustor for temperature control, the gasifier and combustor reach thermal equilibrium based on the amount of char formed in the gasifier. If the gasifier temperature is lower than the equilibrium temperature, then more char is formed and more heat is generated by char combustion. This results in more heat transfer from the combustor to the gasifier, thus bringing the gasifier temperature up toward equilibrium. Although the gasifier, char combustor, and associated piping will be insulated to maximize thermal efficiency, some heat losses will occur. Two percent (2%) of the lower heating value of the feed biomass (dry basis) is assumed to be lost from the system. The resulting gasifier temperature is 1,596°F (869°C) and the char combustor temperature is 1,808°F (987°C). The char combustor is operated with 20% excess air (based on the stoichiometric requirement) to ensure complete oxidation of char components.

Olivine is recovered from the raw syngas exiting the gasifier using two stages of cyclone separators. Nearly all of the olivine and char (99.9% of both) are separated in the primary gasifier cyclone (S-201) and fed by gravity to the char combustor. A secondary cyclone (S-202) removes 90% of residual fines.

The combustion flue gas and olivine from the char combustor are sent to a cyclone separation system similar to the gasifier cyclone. A primary combustor cyclone (S-203) separates the olivine (99.9%) from the combustion gases and the olivine is gravity-fed back to the gasifier. The flue gas from the primary cyclone is sent through a secondary cyclone (S-204) and then utilized for heat recovery before it is mixed with flue gas from the tar reformer area. The combined flue gas stream is utilized for feedstock drying and finally enters the flue gas scrubber for removal of residual particulate matter and regulated chemical species such as SO₂.

The mixture of olivine, ash, and catalyst fines from the secondary flue gas cyclone is indirectly cooled to 300°F in the water-cooled screw conveyor (M-201). Water is added directly to the solids for further cooling and dust prevention. The solids are disposed as landfill.

Another similarity to an FCC is the importance of pressure balance between the gasifier and char combustor in reliably controlling the circulation of olivine through the system. The pressure balance ensures that olivine circulation is maintained from the gasifier to the char combustor and back to the gasifier (not vice versa). The pressure balance in such systems is usually controlled by two slide valves (or L-valve loop seal or J-leg loop seal), one controlling the flow of spent olivine from the gasifier cyclones to the char combustor and the other controlling the flow of regenerated olivine from the primary char combustor cyclone to the gasifier. The pressure balance for these types of processes is addressed during the detailed design phase of a project.

3.2.2 Area 200 Design Basis

The design basis for the gasification area is presented in Table 7. This basis reflects the overall plant capacity of 2,000 dry metric tonnes per day (2,205 dry tons per day).

Table 7. Design Basis for Gasification Area

Parallel gasification trains	Two (2)	
Biomass feed rate per train (dry basis)	1,000 metric tonnes per day	
Biomass moisture content to gasifier	10 wt %	
	Gasifier	Char combustor
Operating pressure (psia)	33.0	29.0
Operating temperature (°F)	1,596	1,808

3.2.3 Area 200 Equipment Cost Estimations

Capital costs for the equipment in this area were estimated by Taylor Biomass Energy for a 500 metric tonnes per day (MTPD) unit. The estimate included the cost for a thermal tar reformer, which will be discussed in the following section. While the Taylor Biomass Energy base design is for a 500 MTPD modular unit, the company supports the feasibility of scaling the unit to a 1,000 MTPD capacity using a scaling exponent of 0.6 as shown below.

$$1,000 \text{ MTPD equipment cost} = 500 \text{ MTPD equipment cost} \times (1,000 / 500)^{0.6}$$

$$1,000 \text{ MTPD equipment cost} = \$9.7 \text{ MM} \times 1.5157 = \$14.7 \text{ MM}$$

Because the total capacity of the thermochemical plant design is 2,000 MTPD, two parallel 1,000 MTPD units will be incorporated in the design. The cost estimate from Taylor Biomass Energy is summarized in Table 8 along with scaled costs for two parallel 1,000 MTPD units. Taylor Biomass Energy's quotation for the 500 MTPD unit is more representative of a first-of-its-kind plant than an nth-plant, suggesting that the capital cost estimate is conservative. However, the design presented in this report has minor variations from the Taylor Biomass Energy design [31]. It is assumed that additional costs for these variations are adequately covered by the conservatism in the Taylor Biomass Energy quotation, as nth-plant costs are expected to be 10% to 15% lower than costs for first-of-a-kind predecessors. Because the quote also includes gas cleanup equipment (thermal cracker or tar reformer), two-thirds of the total equipment costs is allocated to the two 1,000 MTPD gasifiers and the remaining one-third is allocated to the tar reformer (cost details provided in Appendix B). The installation factor applied to calculate total installed cost (TIC) was determined from the Taylor Biomass Energy quotation.

Table 8. Estimates for Gasification and Tar Reforming Facilities

	Taylor Biomass Energy 500 MTPD Single Train (Aug 2010)	Scaled 1,000 MTPD Single Train (Aug 2010)	Two Scaled Parallel 1,000 MTPD Trains	
			(Aug 2010)	(2007)
Dry feedstock capacity (metric tonnes per day)	500	1,000	2,000	2,000
Total purchased equipment cost (TPEC)	\$9.7 MM	\$14.7 MM	\$29.4 MM	\$28.5 MM
Equipment installation factor	2.31	2.31	2.31	2.31
Total installed cost (TIC)	\$22.4 MM	\$33.9 MM	\$67.9 MM	\$64.9 MM
TIC allocated to gasifier (2/3)				\$43.3 MM
TIC allocated to tar reformer (1/3)				\$21.6 MM

The Taylor Biomass Energy system includes the following equipment:

- Biomass feeding system (excluding storage, pre-treatment, and transport equipment)
- Gasification process reactors (gasification, gas conditioning, and combustion)
- All cyclones and interconnecting ducting
- Combustion air blower
- Combustion air pre-heat exchanger(s)
- Start-up equipment
- Syngas polishing scrubber (final cleanup and particulate removal)
- Ash discharge system
- Emergency flare system
- Process instrumentation
- Olivine and magnesium oxide makeup system
- Inert gas system.

Table 9 presents the anticipated equipment requirements and costs for the gasification area. The gasifier cost presented in this table reflects the two-thirds cost assumption explained above.

Table 9. Cost Estimate for Gasification Area

Equipment Description	TPEC (2007 \$k)	TIC (2007 \$k)
Gasifier (ancillaries included)	18,744	43,254
Area A200 subtotal	18,744	43,254

3.3 Area 300: Gas Cleanup

The following section presents an overview, basis for design, and cost estimates for construction of the gas cleanup area.

3.3.1 Area 300 Overview

This section of the process cleans and cools the syngas so it can be compressed and converted into alcohols. Figure 7 presents a simplified process flow diagram for the gas cleanup area of the plant, which includes the following major steps:

- Tars, methane, and other hydrocarbons in the syngas are reformed to CO and H₂.
- Particulates and other contaminants are removed by a quenching and scrubbing process.

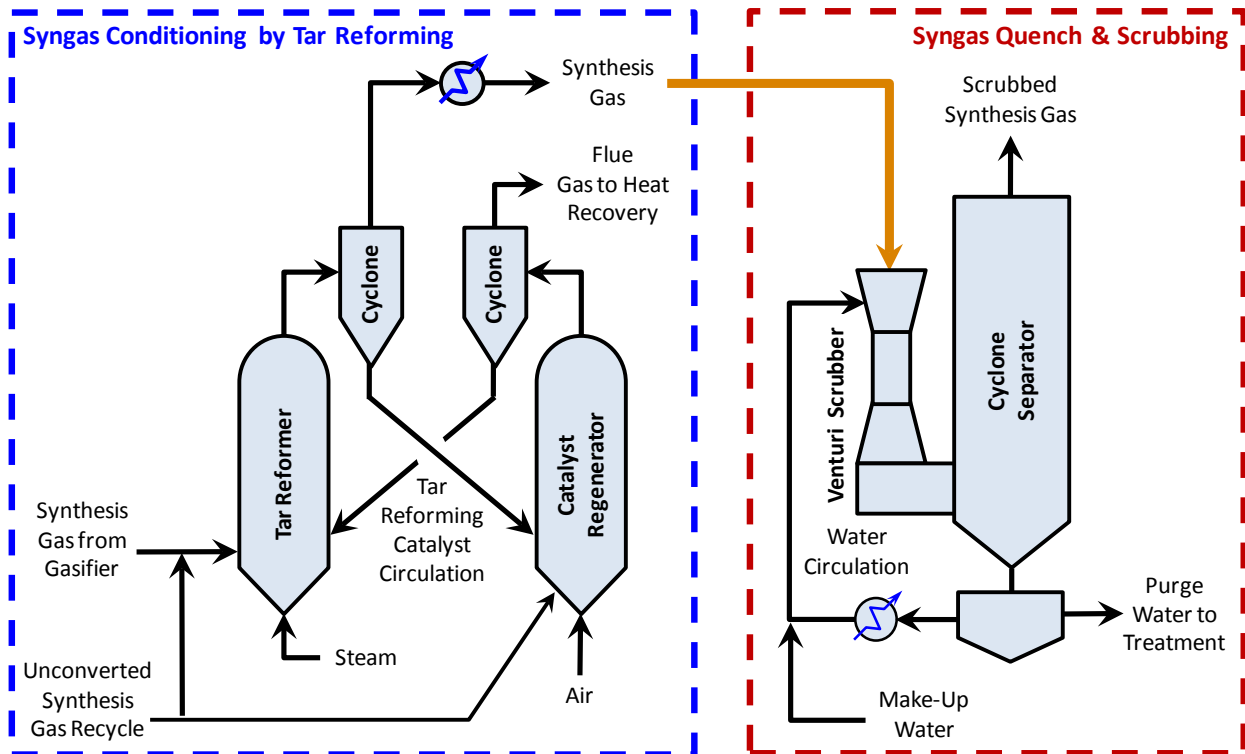

Figure 7. Simplified process flow diagram of gas cleanup area

The type and the extent of cleanup are dictated by the requirements of the alcohol synthesis catalyst and other downstream equipment. This design differs from the previous design [2] in that sulfur removal is not performed on the syngas upstream of the alcohol synthesis reactor (detailed discussion in Section 3.4).

The syngas from the secondary gasifier cyclone is sent to the catalytic tar reformer (R-303 in PFD-P820-A303, Appendix E), which is an entrained-flow, fluidized catalytic reactor. In the reformer, methane, tars, and other hydrocarbons are converted to CO and H₂, and NH₃ is converted to N₂ and H₂. Because the reforming catalyst has significant water-gas-shift activity, the syngas is assumed to exit the reformer at water-gas-shift equilibrium. In the Aspen Plus simulation, the conversion of each compound is set to match targets that are believed to be

attainable through near-term research efforts, as summarized in Table 10. Similar to the gasification area, the heat for tar conversion is supplied by circulating catalyst (Ni/Mg/K supported on alumina) [32] between the tar reformer reactor and the catalyst regenerator. The catalyst regenerator burns carbon (coke) deposits off the catalyst particles, regenerating the catalyst activity and providing heat for the tar reforming reactions. The concentration of coke precursors in the syngas feed to the tar reformer will vary depending on feedstock type and conversion in the gasifier. Because the rate of coke formation in the tar reformer is not sufficient to sustain the endothermic reforming reactions, supplemental combustion gases are supplied to the catalyst regenerator from various process areas. Air is supplied to the catalyst regenerator by the combustion air blower (K-305) to provide the oxygen for combustion. Continuous operation has been demonstrated with simulated syngas (including some H₂S) using NREL's reforming catalyst [24]. The raw syngas from the gasifier and supplemental steam serve as fluidization media for the catalyst in the reformer. No significant amount of supplemental steam is required in the base case design, as the steam present in the syngas from the gasifier is nearly sufficient to maintain a target molar steam-to-carbon ratio of 2. The spent catalyst from the tar reformer is separated from the syngas in a two-stage cyclone separator (S-306) and flows to the catalyst regenerator (R-301A). The base tar reformer operating temperature for this design is 1,670°F (910°C) at the reactor outlet. This temperature is based on experimental results using NREL's reforming catalyst, which showed that the catalyst maintains high reforming activity in the presence of biomass-derived syngas at 1,697°F (925°C). The lower temperature threshold of the high performance has not yet been determined. The model can be modified to maintain the reformer at 1,697°F instead of 1,670°F without significant changes in yields.

The combustion flue gas and catalyst from the regenerator are sent to a cyclone separator system. A two-stage cyclone (S-307) separates the regenerated catalyst from the combustion gases and the catalyst flows back to the tar reformer. The flue gas is then utilized for heat recovery before it is mixed with flue gas from the gasification area. The combined flue gas stream is used for the feed drying system and then sent to a flue gas scrubber.

Hot syngas from the tar reformer is cooled to 140°F (60°C) through heat exchangers, which are used to heat other process streams. A syngas scrubbing system removes impurities such as particulates, ammonia, halides, and residual tars. The scrubbing system consists of a venturi scrubber (M-302), cyclone separator (M-301), and a quench water circulation system. The quench water is contained in a closed recirculation loop with heat rejected to the cooling tower through the quench water cooler (H-301). The quench water circulation rate is set to an L/G (liquid flow to actual volumetric gas flow) ratio equal to 1 liter/m³. This ratio is based on a study of venturi scrubbers that suggests operating conditions for near-optimal performance [33]. The syngas exits the quench system at a temperature of 130°F (54°C). A continuous purge and fresh water makeup is maintained in the circulation loop at approximately 3 gpm to control the solids level in the circulating water. The purge stream is sent to a clarifier to separate the solids from the water. The solids are routed for disposal and the water, which includes process condensate, is recycled to the reverse osmosis (RO) purification system in the base case design. In a version of the design that includes water optimization, the water is treated and used for flue gas scrubbing and the remainder is mixed with the cooling water makeup stream (shown in PFD-P820-A701 in Appendix E).

3.3.2 Area 300 Design Basis

Table 10 summarizes the 2012 targets for hydrocarbon conversions during continuous operation. While most of these targets have been demonstrated at NREL at bench scale, future efforts are focused on continuous operation at the pilot scale for extended periods. Equipment is currently being installed at NREL for pilot-scale demonstrations.

Table 10. Target Performance of Reforming Catalyst

Compound	2012 Target Conversion
Methane (CH ₄)	80 %
Ethane (C ₂ H ₆)	99 %
Ethylene (C ₂ H ₄)	90 %
Tars (C ₁₀₊)	99 %
Benzene (C ₆ H ₆)	99 %
Ammonia (NH ₃)	90 %

These target conversions were incorporated into the Aspen Plus model to simulate expected tar reformer performance. The compositions of the reformer inlet and outlet streams are presented in Table 11.

Table 11. Reformer Conditions, Gas Compositions, and Reactor Basis for the Base Case

	Inlet		Outlet	
	Wet	Dry	Wet	Dry
Temperature, °F (°C)	1,632 (889)		1,670 (910)	
Pressure, psia	28.7		25.7	
H ₂ :CO molar ratio	0.864		1.247	
Gas composition (mole %)	Wet	Dry	Wet	Dry
Hydrogen (H ₂)	19.7	27.6	40.3	48.1
Carbon dioxide (CO ₂)	15.5	21.7	9.4	11.2
Carbon monoxide (CO)	22.8	32.0	32.3	38.5
Water (H ₂ O)	28.5	---	16.2	---
Methane (CH ₄)	9.3	13.0	1.5	1.8
Acetylene (C ₂ H ₂)	0.1	0.2	115 ppmv	138 ppmv
Ethylene (C ₂ H ₄)	1.6	2.3	1,295 ppmv	1,546 ppmv
Ethane (C ₂ H ₆)	1,608 ppmv	2,250 ppmv	13 ppmv	15 ppmv
Benzene (C ₆ H ₆)	449 ppmv	629 ppmv	3.6 ppmv	4.3 ppmv
Tars (C ₁₀ H ₈)	822 ppmv	1,150 ppmv	6.6 ppmv	7.9 ppmv
Ammonia (NH ₃)	1,158 ppmv	1,621 ppmv	93 ppmv	111 ppmv
Hydrogen sulfide (H ₂ S)	133 ppmv	186 ppmv	106 ppmv	127 ppmv
Nitrogen (N ₂)	1,539 ppmv	2,154 ppmv	1,647 ppmv	1,966 ppmv
Reactor space velocity (h ⁻¹)	2,476			
Reactor volume (ft ³)	2,713			

3.3.3 Area 300 Equipment Cost Estimations

Table 12 presents the equipment list and cost estimates for the gas cleanup area of the plant. The tar reformer cost presented in this table reflects the one-third cost assumption based on Taylor Biomass Energy's cost estimate for gasification and gas cleanup, as discussed in detail in Section 3.2.3. Equipment costs in the table were obtained from quotations by Taylor Biomass Energy (tar reformer) and TurboSonic (syngas quench and scrubbing system).

Table 12. Cost Estimate for Gas Cleanup Area

Equipment Description	TPEC (2007 \$k)	TIC (2007 \$k)
Tar reformer and syngas scrubber	11,697	24,330
Heat integration	929	2,610
Area A300 subtotal	12,626	26,940

3.4 Area 400: Alcohol Synthesis, Syngas Compression and Acid Gas Processing

The following section presents an overview, basis for design, and cost estimates for construction of the alcohol synthesis reactor, syngas and recycle compressors, turbo-expander, and acid gas removal facilities.

3.4.1 Area 400 Overview

The major function of this area is synthesis of mixed alcohols from syngas by catalytic conversion. The following major steps occur in the alcohol synthesis area:

- Syngas compression to 3,000 psia
- Alcohol synthesis
- Steam generation from cooling of the exothermic alcohol synthesis reaction
- Cooling and recovery of alcohols from reactor effluent (in the liquid phase)
- CO₂ and H₂S removal
- Partial recycle of H₂S into the reactor by dissolving in chilled methanol
- Sulfur recovery from removed H₂S
- Recycle of most of the cleaned, unreacted syngas to the reactor after recompression
- Power recovery from gaseous effluents in a turbo-expander. These gases are then sent to the reformer and reforming catalyst regenerator.

Figure 8 presents a simplified process flow diagram for the alcohol synthesis area.

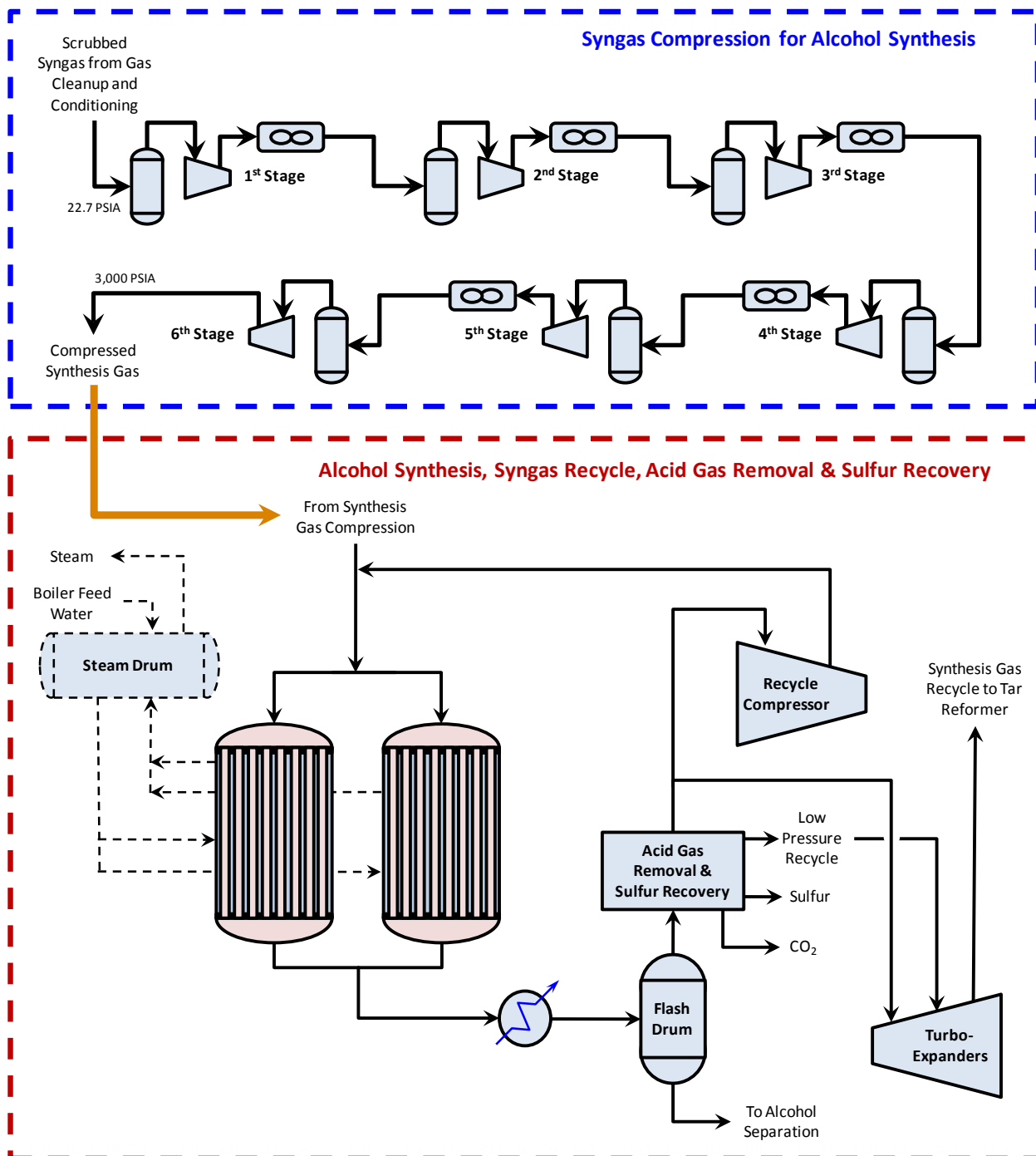

Figure 8. Simplified process flow diagram of alcohol synthesis area

The scrubbed syngas is compressed to 3,000 psi (207 bar) using a six-stage centrifugal compressor with inter-stage cooling as shown in Figure 8 and PFD-P820-A401 (Appendix E). The compressor was modeled such that each section has a polytropic efficiency of 78% to 87% (based on vendor quotes), assumed mechanical efficiency of 98%, and intercooler outlet temperatures of 110°F (43°C). Each inter-stage cooler includes water, air, and process stream

exchangers. These exchangers are deliberately oversized to minimize pressure drops to an average of 6 psi (0.41 bar) per inter-stage (i.e., an average of 2 psi pressure drop in each of the three inter-stage coolers).

Minimizing pressure drop in the coolers will minimize electrical consumption as the compressors represent the most significant electrical load on the system, consuming approximately 47 MW of electricity in the base case.

The compressed fresh syngas is mixed with recycled syngas and methanol, and pre-heated to 595°F (313°C) before entering the alcohol synthesis reactor. Within the reactor, the syngas contacts a metal-sulfide catalyst. For this report, performance was modeled after The Dow Chemical Company's potassium-promoted cobalt molybdenum sulfide catalyst. This catalyst is described in detail in U.S. Patent 4,882,360.

The overall stoichiometric reaction for alcohol synthesis is summarized in Equation 4:

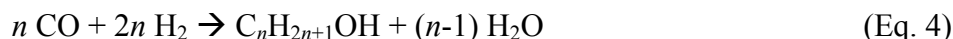

Light hydrocarbons, methyl esters, and aldehydes are produced in smaller quantities through similar chemical routes. The stoichiometry suggests an optimum H₂:CO ratio of 2.0. However, sulfide-type mixed alcohol catalysts have significant water-gas-shift activity and will generate H₂ and CO₂ from CO and H₂O as shown in Equation 5. For this reason, an H₂:CO ratio of less than 2.0 is preferred for this design.



A kinetic model, supplied to NREL by The Dow Chemical Company under confidentiality agreement, was used to model alcohol production over the promoted sulfide catalyst. The model was developed at The Dow Chemical Company using both bench-scale and pilot-scale data, and it shows agreement with recent experimental results, as shown in the parity plots in Figure 9. It should be noted that the model is dynamic and incorporates effects of reactant and product concentrations, reactor pressure, catalyst particle size, reactor geometry, heat transfer coefficients, and temperature. The predictions in the full process model are robust and represent a significant improvement in this design report relative to earlier predictions.

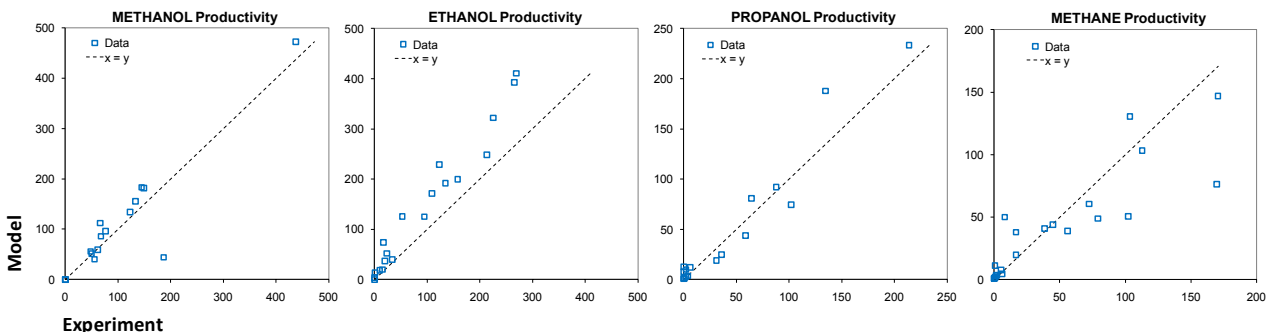

Figure 9. The Dow Chemical Company model predictions compared to experimental data

Notes: 1) Unit for productivity: g/kg catalyst/h. 2) Experimental data spans a wide range of operating temperatures, pressures, and feed compositions.

Other mixed alcohol catalysts may fit into this process configuration. However, the breadth of information available for sulfide-type catalysts, coupled with their relative cost and productivity and the availability of The Dow Chemical Company’s kinetic model, warranted significant consideration of metal sulfide-type catalysts. Further, because The Dow Chemical Company and NREL signed a cooperative research and development agreement (CRADA) in 2009, any demonstrated or anticipated improvements to catalyst performance can be incorporated into The Dow Chemical Company’s kinetic model and reflected in future State of Technology (SOT) reports.

Heat must be removed from the reactors because the synthesis reaction is exothermic. Temperature is controlled by steam generation on the shell side of the reactor. Steam is generated at 1,336 psia and 581°F (305°C) and maintained at these conditions by back-pressure control at the outlet of the steam drum (T-605).

The effluent gases from the reactor are cooled and flashed to remove a liquid stream rich in alcohols and other minor liquid components, which are sent for purification in area 500. The gaseous stream is cleaned to remove CO₂ and H₂S, as explained below, and recycled to the reactor. In the base case design, 12% of the recycle gas is purged to prevent excessive buildup of inert gases in the synthesis loop and expanded through a turbo-expander to recover power. After power recovery, purge gases are split between the reformer (75%) for carbon recovery and the reformer catalyst regenerator (25%) for heat generation. The fraction of the recycle split impacts the gas composition at the reactor inlet, especially with respect to methane and other hydrocarbon content.

A major difference in this design compared to previous designs is the location of the acid gas removal system. In the previous design [2], the amine-based acid gas removal system was located upstream of the alcohol synthesis reactor. In this design, the acid gas removal system resides within the alcohol synthesis reactor recycle loop. The new location was chosen due to several considerations:

- **CO₂ control** – The CO₂ concentration in the alcohol synthesis reactor can be maintained at low levels without necessitating a large purge from the recycle stream, which improves

reactor performance and overall carbon efficiency. The compression energy requirement for recycled syngas is low because the stream is already at high pressure within the recycle loop. This was the primary consideration for choosing the current acid gas removal design and location.

- ***Metal-sulfide alcohol synthesis catalyst*** – To maintain activity and selectivity, sulfide catalysts require a small co-feed of reactive sulfur and it is, therefore, not necessary to remove sulfur from the syngas stream prior to the reactor.
- ***Variability of feedstock sulfur*** – By placing the acid gas removal and sulfur reinjection operations within the alcohol synthesis recycle loop, the CO₂ and H₂S concentrations in the alcohol synthesis reactor and recycle can be more effectively controlled. This allows the flexibility of processing feedstocks with varying sulfur content without process modifications.
- ***Sulfur containment*** – With sulfur removal operations within the syngas recycle loop, purge gases are also cleaned of sulfur, thus reducing gaseous sulfur emissions from the plant and eliminating recycle of sulfur to the reformer.

H₂S/CO₂ removal and sulfur management systems represent a substantial portion of the alcohol synthesis area of the plant. Figure 10 presents a simplified schematic of these systems, and details of the systems are provided in PFD-P820-A403 through PFD-P820-A406 in Appendix E.

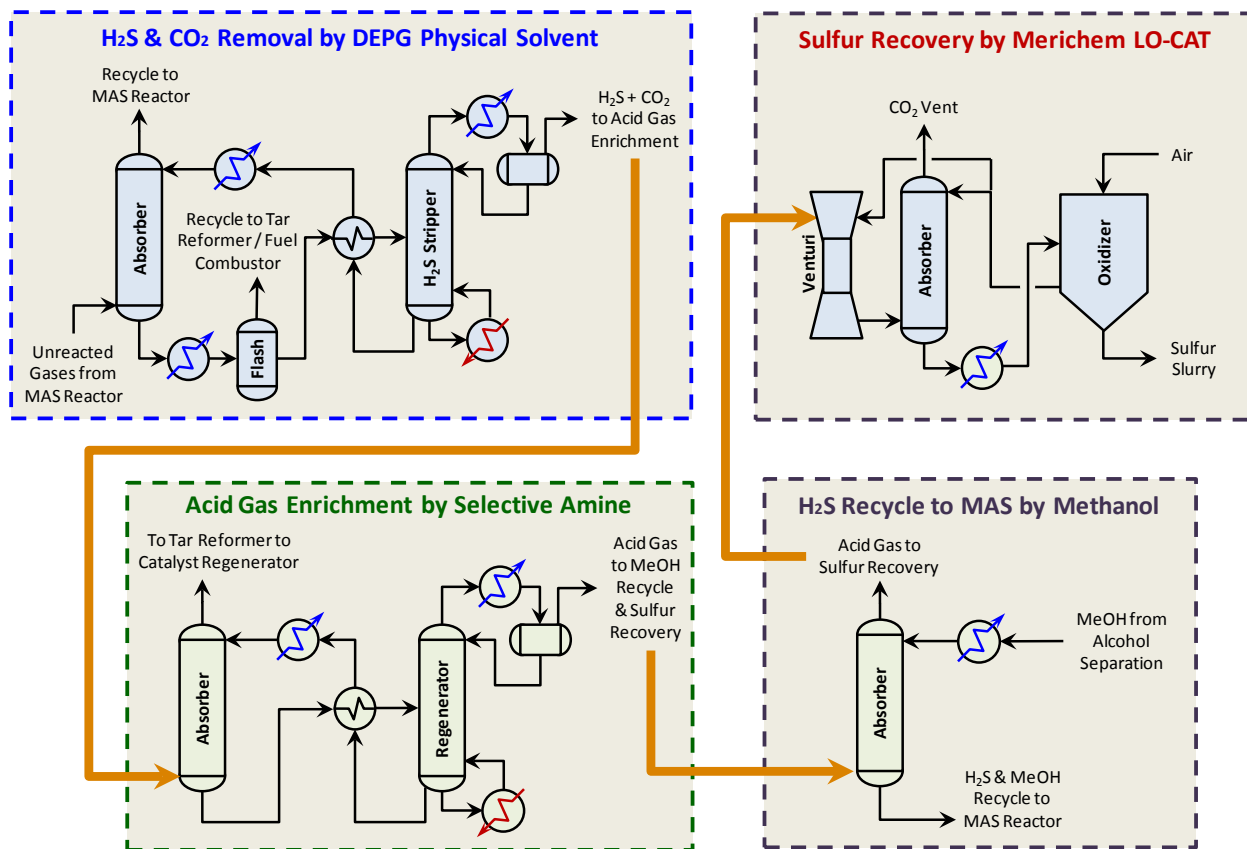

Figure 10. Simplified flow diagram of the H₂S/CO₂ removal and sulfur recovery

The H₂S/CO₂ removal and sulfur management systems include the following:

H₂S and CO₂ removal (M-401) – This system utilizes a physical solvent, dimethyl ethers of polyethylene glycol (DEPG), to remove nearly all of the H₂S and a portion of the CO₂ from the alcohol synthesis reactor effluent. The circulation rate of the DEPG solvent can be adjusted to control the removal rate of CO₂ from the stream. Because a significant portion of the effluent stream is recycled to the alcohol synthesis reactor, control of CO₂ removal allows control of CO₂ in the synthesis reactor inlet. The outlet from the DEPG absorber is split into two streams. A portion is recycled to the synthesis reactor (R-410) inlet and the remainder is sent through two expanders (K-412A and K-412B) and recycled to the tar reformer/fuel combustor. The DEPG from the absorber bottom is sent to a lower pressure flash drum to selectively expel less soluble compounds such as hydrogen, carbon monoxide, and methane. The 250 psia flash stream is sent to the low pressure expander (K-412B) and recycled to the tar reformer/fuel combustor. The DEPG solvent is then stripped of the remaining CO₂ and H₂S, chilled, and circulated back to the absorber. The stripper off-gas stream, rich in CO₂ and H₂S, is sent to acid gas enrichment (M-403).

Ammonia absorption refrigeration system (M-402) – This system provides 30°F chilling capacity for the DEPG acid gas removal system (M-401) and the methanol/H₂S absorption system (M-404). The unit utilizes ammonia absorption technology offered by Colibri-BV.

Acid gas enrichment system (M-403) – This system utilizes a selective amine to increase the H₂S concentration of the acid gas from M-401 for downstream processes. The selective amine absorbs nearly all of the H₂S entering from the DEPG stripper off-gas while absorbing only a small percentage of the entering CO₂. This creates a low-sulfur absorber off-gas that is recycled to the fuel combustor as low-energy-value fuel. The H₂S-rich acid gas from the amine regenerator is sent to the methanol/H₂S absorption system (M-404).

Methanol/H₂S absorption system (M-404) – This system utilizes a slip-stream of methanol from the alcohol separation area to absorb and recycle a controlled amount of H₂S to the alcohol synthesis reactor (R-410) to maintain an appropriate H₂S partial pressure for the metal-sulfide catalyst. The off-gas from the methanol absorber is sent to the LO-CAT sulfur recovery system (M-405).

LO-CAT sulfur recovery system (M-405) – This system utilizes Merichem’s LO-CAT technology to remove H₂S from the methanol absorber off-gas. LO-CAT is an iron-chelate-based process consisting of a venturi pre-contactor, liquid-filled absorber, air-blown oxidizer, air blower, solution circulation pump, and solution cooler. Elemental sulfur is produced in the oxidizer and stockpiled for disposal or for sale as an unconditioned product. The LO-CAT process was modeled to remove the H₂S to a concentration of 10 ppmv in the CO₂ vent.

The turbo-expander for the recycle purge gas is designed as two stages with intermediate reheat in order to maximize power recovery. The inlets to both stages operate at 950°F (510°C). The pressure at the inlet of the first expander is dropped from more than 2,900 psi to 1,500 psi, with the assumption that it will be difficult to find expander technologies that operate at 2,900 psi. This maximum inlet pressure of 1,500 psi was derived from the data in Figure 11, which correlate maximum operating pressure as a function of inlet temperatures. The maximum operating pressure curve is based on ASTM pressure rating data and an operating envelope data point from Dresser-Rand.

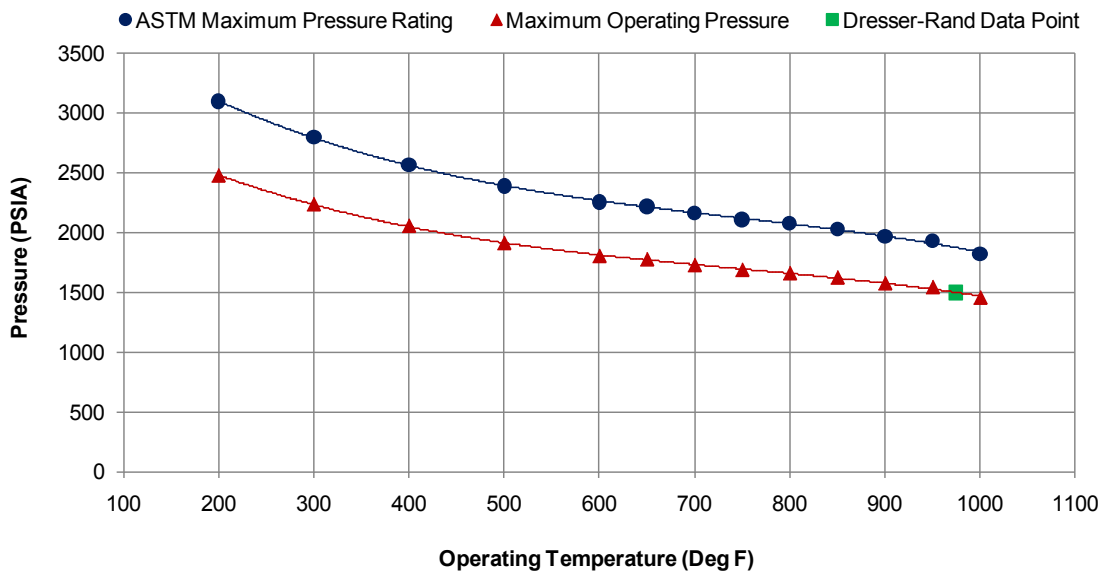

Figure 11. Maximum operating pressure for syngas turbo-expander

The first turbine drops the pressure from 1,500 psi to 250 psi and the second turbine drops the pressure from 248 psi to 34 psi. An efficiency of 75% was assumed for the expanders. Although vendor quotations were requested for this equipment, vendors were reluctant to provide quotations due to the custom nature of the expanders and because vendors were generally unenthusiastic about spending the time to develop an estimate for which there is low likelihood of equipment purchase. Instead, literature sources, steam turbine information, Aspen IPE estimates, and data from previous projects done by Harris Group Inc. on steam turbines were used as a guideline to estimate the cost of the expanders. It is expected that the capital cost shown in Appendix B is conservative, as it is 3.5 times the price per kW of the quoted steam turbines in area 600.

The recycle compressor is a low horsepower (706 hp in the base case) unit and was included in the quotation for the main syngas compressor.

The reactor effluent is cooled to 110°F (43°C) through a series of heat exchangers and is maintained at high pressure. The effluent is first heat-exchanged with cooler process streams, lowering the temperature to 175°F (79.4°C). This is followed by air-cooled exchangers that reduce the temperature to 140°F (60°C). Finally, cooling water is used to drop the temperature to 110°F (43°C). A knock-out drum (S-501) is used to separate the liquids (primarily alcohols) from non-condensable gas, comprised of unconverted syngas, CO₂, and methane. The non-random two-liquid (NRTL) physical property package in Aspen Plus was used to model this flash operation as well as the alcohol condensation exchanger train.

3.4.2 Area 400 Design Basis

The design basis for the alcohol synthesis reactor system is presented in Table 13. The alcohol productivity targets for 2012 assume a 20% increase in specific activity over the 2010 State of Technology. This activity improvement was simulated through an activity factor adjustment in the mixed alcohol synthesis kinetic model. Design basis parameters for the other parts of the alcohol synthesis process area are presented in Table 14.

Table 13. Target and Design Basis Parameters for Alcohol Synthesis Reactor

Technical Target Parameter		
Pressure, psi (bar)		3,000 (207)
Single-pass CO conversion		29%
Overall CO conversion		79%
CO selectivity to alcohols (CO ₂ -free)		81%
CO selectivity to ethanol		63%
Total alcohol productivity, g/kg-cat/h		368
Ethanol productivity, g/kg-cat/h		160
Design Basis Process Parameters		
	Inlet	Outlet
Reactor temperature, °F (°C)	595 (313)	611 (322)
Reactor pressure, psi (bar)	2,995 (206.5)	2,953 (203.6)
Steam (shell side) temperature, °F (°C)		581 (305)
Inlet gas composition		
H ₂ :CO molar ratio		1.5
CO ₂ , mole %		14.0
CH ₄ , mole%		7.7
Methanol, mole %		2.6
H ₂ S, ppmv		70
H ₂ O, wt %		0.04
Reactor Design Parameters		
Reactor tube length, ft		60
Total number of tubes		9,579
Number of reactors		2
Gas hourly space velocity, hour ⁻¹		5,000
Catalyst particle size (cylindrical)	5 mm dia. x 5 mm length	
Reactor pressure drop, psi		42.2
Tube outside diameter, inches		1.5
Tube wall thickness, inches		0.16
Reactor tube material	A213 T22 (2¼ Cr, 1 Mo)	

Table 14. Design Parameters for Compression, Power Recovery, and H₂S/CO₂ Systems

Syngas Compressor Design Parameters	
Service	Syngas + effluent recycle
Inlet pressure	22.7 psia
Outlet pressure	3,000 psia
Inlet mass flow	350,450 lb/h
Inlet molecular weight	17.2 lb/lb-mole
Drive power source	Electric motors
Inter-stage cooling	Process, air, cooling water
Number of stages	6
DEPG Acid Gas Removal (M-401) Design Parameters	
Absorber inlet pressure	2,937 psia
Vapor feed rate	49,121 lb-mole/h
H ₂ S concentration	59 ppmv
CO ₂ concentration	19.1 mole %
Target CO ₂ removal from synthesis recycle loop	22.8% of inlet CO ₂ removed
Solvent circulation rate	1,360 gpm
Required refrigeration duty	23.1 MMBtu/h
Stripping steam duty	13.9 MMBtu/h
Cooling water duty	5.6 MMBtu/h
Electrical consumption	3,310 kW
Ammonia Absorption Refrigeration (M-402) Design Parameters*	
Required solvent temperature	30°F
Refrigeration duty	23.4 MMBtu/h
Cooling water	68.8 MMBtu/h
Steam duty	40.6 MMBtu/h
Electrical consumption	179 kW
Amine Acid Gas Enrichment (M-403) Design Parameters	
Inlet molar flow rate	1,453 lb-mole/h
H ₂ S concentration	0.18 mole %
CO ₂ concentration	87.2 mole %
Selective amine concentration in solution	50 wt %
Amine solution circulation rate	80 gpm required 200 gpm maximum
Treated gas H ₂ S specification	< 50 ppmv
Steam duty	5.0 MMBtu/h
Cooling water duty	5.0 MMBtu/h
Electrical consumption	9 kW

* Values for ammonia absorption refrigeration (M-402) duties were extrapolated from vendor quotation.

Methanol/H₂S Absorption (M-404) Design Parameters	
Inlet vapor H ₂ S concentration	6.0 mole %
Base case H ₂ S recycle	1.38 lb-mole/h
Maximum H ₂ S recycle capacity	20 lb-mole/h
Base case methanol rate	230 lb-mole/h
Maximum methanol rate	2,000 lb-mole/h
Base case refrigeration duty	0.26 MMBtu/h
Maximum refrigeration duty	2.5 MMBtu/h
Base case electrical consumption	71 kW
Maximum electrical consumption	500 kW
LO-CAT Sulfur Recovery (M-405) Design Parameters	
Sulfur recovery rate	936 lb/day
CO ₂ vent H ₂ S concentration	10 ppmv
Expander/Power Recovery Design Parameters	
1 st stage inlet pressure	1,500 psia
1 st stage inlet temperature	950°F
1 st stage power recovery	4.73 MW
2 nd stage inlet pressure	245 psia
2 nd stage inlet temperature	950°F
2 nd stage power recovery	6.74 MW

3.4.3 Area 400 Equipment Cost Estimations

The estimated purchased equipment costs and total installed costs for the alcohol synthesis area were gathered from various sources including technology licensors, industrial suppliers, published literature, and Aspen Icarus Process Evaluator 2006.5 computer software (Q1 2007 cost basis). The sources of the cost data are summarized in Table 15.

Table 15. Sources of Equipment Costs for Alcohol Synthesis Area

Equipment or System	Source of Equipment Costs
Syngas compressors and motors	Elliott – Ebara Group
Compressor inter-stage air coolers	GEA Rainey Corporation
Compressor inter-stage KO drums	Aspen Icarus Process Evaluator 2006.5
Compressor inter-stage water coolers	Aspen Icarus Process Evaluator 2006.5
Alcohol synthesis reactors	Hooper Engineered Vessels International
Expanders and generators	Aspen Icarus Process Evaluator 2006.5
DEPG acid gas removal system	Docter et al. [34]
Ammonia absorption refrigeration system	Colibri – BV
Amine acid gas enrichment system	Gary and Handwerk [35]
	Aspen Icarus Process Evaluator 2006.5
	Multiple selective amine technology licensors
Methanol/H ₂ S absorption system	Aspen Icarus Process Evaluator 2006.5
LO-CAT sulfur recovery system	Adapted from a Merichem Company quotation for another project

Table 16 presents the equipment list and cost estimates for the alcohol synthesis area of the plant.

Table 16. Cost Estimate for Alcohol Synthesis Area

Equipment Description	TPEC (2007 \$k)	TIC (2007 \$k)
Synthesis gas compressors	32,537	59,057
Alcohol synthesis reactor and effluent cooling/flash	11,851	29,551
Purge gas expanders	9,961	17,929
H ₂ S/CO ₂ removal and sulfur recovery systems	13,586	28,199
Heat integration	6,788	15,805
Area A400 subtotal	74,722	150,541

Additional equipment lists and cost breakdowns for the DEPG acid gas removal system, amine acid gas enrichment system, methanol/H₂S absorption system, and LO-CAT sulfur recovery system are provided in Appendix H.

3.5 Area 500: Alcohol Separation

The following section presents an overview, basis for design, and cost estimates for construction of the alcohol separation area.

3.5.1 Area 500 Overview

This area of the process recovers the alcohol products from the synthesis area and recycles unconverted material for improved overall conversion. The following steps take place in the alcohol separation area:

- Molecular sieve for water removal from alcohol synthesis products
- Two-step distillation section for recovery of ethanol and higher alcohol products.

Figure 12 presents a simplified process flow diagram for the alcohol separation area of the plant.

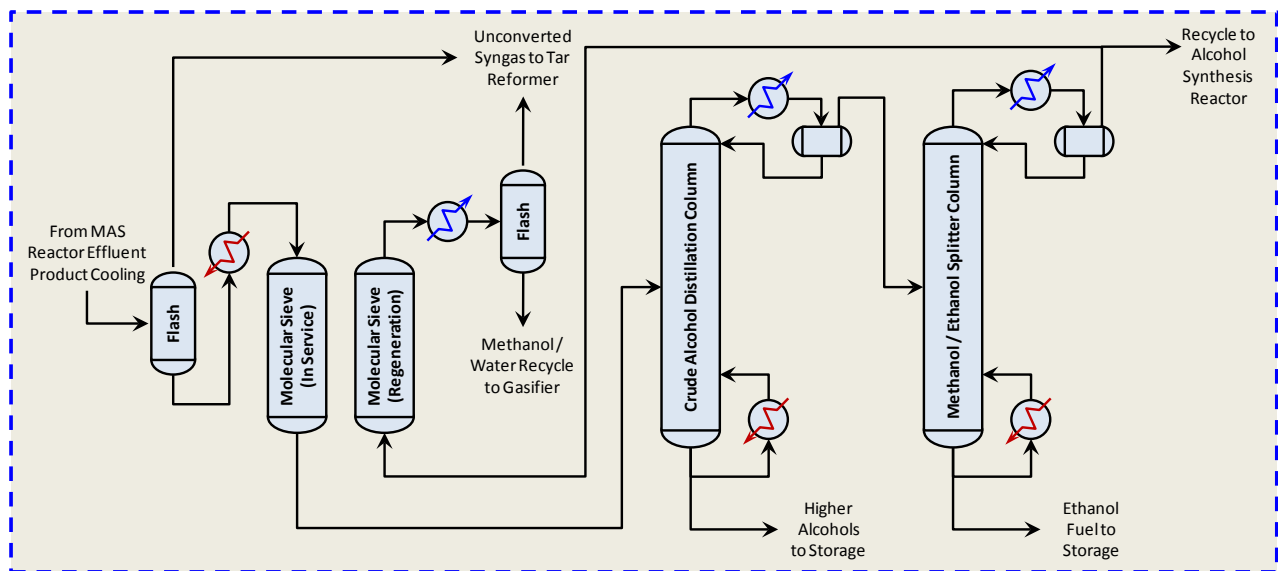

Figure 12. Simplified process flow diagram of alcohol separation area

The mixed alcohol stream from area 400 is sent to area 500 where it is de-gassed, dried, and separated into three streams: methanol, ethanol, and mixed higher-molecular-weight alcohols. Fifteen percent of the methanol stream is used to back-flush the molecular sieve drying column. This was deemed adequate based on available data for such mol-sieve purge operations [25]. The water/methanol stream from the purge is vaporized and fed to the gasifier (area 200) to satisfy part of its fluidization requirement and to recover carbon from the methanol. The remainder of the methanol is recycled back to the alcohol synthesis reactor (area 400) because methanol recycle has a positive impact on ethanol yields for The Dow Chemical Company's catalyst. A slip-stream of this recycle is chilled to 30°F in order to dissolve H₂S in the recycle and meet the 70-ppm H₂S specification at the alcohol synthesis reactor inlet. The ethanol and mixed alcohol streams are cooled and sent to product storage tanks.

After the effluent from the alcohol synthesis reactor is cooled, the unconverted syngas and non-condensables are separated from the condensed alcohols in S-501. Although the majority of the lighter molecules leaving the synthesis reactor are separated in S-501, the condensed alcohol stream retains substantial quantities of H₂, CH₄, CO, and CO₂ due to solubility at the high alcohol synthesis operating pressure. The condensed alcohol stream is then reduced in pressure from 2,937 psi to 60 psi and flashed in S-502 to reject the dissolved gases. The vapor from S-502

is recycled to the tar reformer (area 300). The liquid from S-502 is reheated to the vapor phase, superheated, and sent to the molecular sieve dehydrator (S-503) for water removal.

The molecular sieve dehydrator is based on previous ethanol studies [2, 22] and is assumed to have similar performance with mixed alcohols. The system consists of two parallel vessels containing fixed beds of porous alumino-silicate pellets, which are designed to selectively adsorb water. One molecular sieve vessel is in alcohol drying service while the material in the other vessel is being regenerated by recycled methanol. Once the material in drying service reaches water adsorption capacity, it enters the regeneration cycle and the regenerated vessel is placed in drying service. The methanol/water mixture resulting from the molecular sieve regeneration is cooled to 140°F (60°C) using a forced-air heat exchanger and separated from the uncondensed vapor in a flash drum. The vapor stream is recycled to the tar reformer and the water/methanol condensate is sent to the gasifier. Alumino-silicate molecular sieve products designed specifically for ethanol drying are commercially available through companies such as Grace [36] and UOP [37]. The capital cost for the unit was updated from recent vendor quotes.

In the biochemical ethanol cases, the molecular sieve is used to dry ethanol after it is distilled to near the azeotropic concentration of ethanol and water (92.5 wt % ethanol). The adsorbed water is flushed from the molecular sieves with a portion of the dried ethanol and recycled to the rectification column. The water is ultimately rejected from the bottom of the distillation column. In a thermochemical process, where water concentration is low in the crude alcohol, it has been determined that drying the entire mixed alcohol stream prior to distillation operations is preferred. The adsorbed water is desorbed from the molecular sieves through a combination of depressurization and flushing with methanol. The estimated power consumption for the unit is factored into the Aspen Plus model and included as a plant operating cost.

The dry mixed alcohol stream leaving the molecular sieve enters the first of two distillation columns, the crude alcohol column (D-504). The crude alcohol separation takes place in a typical distillation design incorporating a trayed column (D-504), an overhead condenser (H-504C), and a reboiler (H-504R). Essentially all of the methanol and 99% of the ethanol entering the column are recovered in the overhead product. The bottoms product consists of 1% of the feed ethanol, 99% of the feed propanol, and all of the higher alcohols (butanol and heavier). The D-504 bottoms stream is considered a co-product of the plant with a sale value of approximately 90% of its heating value (refer to Section 4.4 for details). The co-product is cooled and sent to product storage. The methanol/ethanol overhead from D-504 continues to a second distillation column, the methanol column (D-505), for further processing.

The methanol/ethanol separation takes place in another typical distillation design, which includes a trayed column (D-505), an overhead condenser (H-505C), and a reboiler (H-505R). The ethanol is recovered from the bottoms of D-505 and contains 99% of the feed ethanol. The ethanol product contains less than 0.5 vol % methanol, meeting ASTM product specifications for fuel ethanol (refer to fuel-grade ethanol specifications in Appendix J). The ethanol is cooled and sent to product storage. The methanol stream is recycled to several destinations throughout the plant, as explained, and is not considered a saleable product.

3.5.2 Area 500 Design Basis

Table 17 summarizes the design basis for the equipment in the alcohol separation area, including the molecular sieve dryer system and alcohol distillation systems.

Table 17. Design Basis Parameters for Alcohol Separation Area

Molecular Sieve Design Parameters	
Inlet mass flow	129,421 lb/h
Inlet water content	5.6 wt %
Target outlet water content	0.5 wt %
Crude Alcohol Distillation Design Parameters	
Ethanol recovery in overhead	99%
Propanol recovery in bottoms	99%
Column diameter	9.0 ft
Number of theoretical trays	60
Tray efficiency	60%
Number of actual trays	100
Type of trays	Valve
Tower and tray material	304SS
Methanol / Ethanol Distillation Design Parameters	
Ethanol recovery in bottoms	99%
Methanol in bottoms ethanol product	0.5%
Column diameter	12.0 ft
Number of theoretical trays	81
Tray efficiency	60%
Number of actual trays	135
Type of trays	Valve
Tower and tray material	304SS
Heat Exchanger and Vessel Design Parameters	
Column overhead condenser cooling media	Air
Column reboiler heating media	Low pressure steam
Column overhead accumulator sizing	10-minute liquid inventory 3 vapor space factor
Product rundown cooling media	Process + cooling water

3.5.3 Area 500 Equipment Cost Estimations

Table 18 presents the equipment list and cost estimates for the alcohol separation area of the plant. Costs for the molecular sieve drying system were extrapolated from a quotation by Delta-T Corporation provided for the biochemical ethanol design report [38]. All other equipment was priced using Aspen IPE 2006.5 software.

Table 18. Cost Estimate for Alcohol Separation Area

Equipment Description	TPEC (2007 \$k)	TIC (2007 \$k)
Molecular sieve separator system	4,081	7,500
Crude alcohol distillation	2,515	3,539
Methanol/ethanol distillation	6,134	7,942
Heat integration	493	1,326
Area A500 subtotal	13,223	20,307

3.6 Area 600: Steam System and Power Generation

The following section presents an overview, basis for design, and cost estimates for construction of the steam system and power generation facilities.

3.6.1 Area 600 Overview

The present design includes a steam cycle that produces steam through recovery of heat from the hot process streams throughout the plant. Operations requiring steam include gasification, reforming, acid gas removal, acid gas enrichment, ammonia-water refrigeration system, and alcohol distillation. Steam is directly injected into the gasifier and the reformer. In the base case design, a target steam-to-carbon ratio of 2 can be maintained in the reformer with minimal additional steam feed. Steam is also used for indirect heat exchange in the distillation reboilers and acid-gas cleanup systems. All indirect heating applications include condensate return loops.

Power for plant operations is produced from the steam cycle using a two-stage steam turbine with intermediate reheat to increase electricity production. The steam turbine efficiencies are assumed to be 75% and the generator mechanical efficiencies are assumed to be 97%. The first stage (M-602A) turbine drops the steam pressure from 1,321 psia to 350 psia. The second stage (M-602B) turbine drops the pressure from 345 psia to 3.5 psia. The steam inlets to both turbine stages are preheated to 1,000°F. Slip-streams of low pressure steam are extracted at 65 psia from the second stage for the uses described above. Power is also produced from the process turbo-expander system in area 400 (K-412A,B). The plant energy balance is controlled by the rate of syngas combustion in the reformer catalyst regenerator. The energy from syngas combustion is recovered from the flue gas and contributes to the conversion to electrical energy in the steam turbine generators. The rate of syngas combustion is controlled to generate only enough electricity to supply the plant, minimizing electricity exported to the grid. The steam and power generation systems are shown in PFD-P820-A601 through PFD-P820-A604 in Appendix E.

Low pressure (3.5 psia) steam exhaust from the turbine is cooled by exchanging heat with other process streams and is condensed in an air-cooled condenser (H-601). While an air-cooled

exchanger is considerably more expensive than a water cooler, it has the advantage of reducing water consumption through evaporation in the cooling towers and was preferred in this design for environmental considerations. A condensate collection tank (T-601) gathers condensate returns from indirect heat exchange along with the steam turbine condensate. The condensate from the collection tank is treated in the hot condensate polishing unit (M-601C), mixed with treated makeup water, and sent to the condensate surge tank (T-602). From the surge tank, the water is pumped, heated to the saturation temperature, and sent to the deaerator (T-603) to remove any dissolved gases from the water. The water from the deaerator is pumped to a pressure of 1,351 psia and then pre-heated to its saturation (bubble point) temperature using a series of exchangers. Steam is generated by heat exchange with flue gas (H-611) and on the shell side of the alcohol synthesis reactor (R-410). This saturated steam is collected in the steam drum (T-605). To prevent buildup of solids, water is periodically discharged from the steam drum (also known as blowdown). Saturated steam from the steam drum is superheated with another series of exchangers to 1,000°F (538°C) before it goes to the steam turbine.

The integration of the individual heat exchangers can be seen in the PFDs in Appendix E. The Aspen Plus model increases or decreases the boiler feed water flow rate through the steam cycle in order to close the heat balance. The control system in the plant will function in a similar fashion by controlling the flow rate of boiler feed water makeup to the steam system in order to maintain levels in the deaerator (T-603) and steam drum (T-605).

All compressors, pumps, fans, etc. utilize electric motor drives and are modeled and quoted accordingly. An allowance of 1 MW of excess power is specified to account for miscellaneous usage and general electric needs (lights, computers, etc.).

3.6.2 Area 600 Design Basis

Table 19 presents a summary of the power requirements for each area of the plant. As all necessary power is generated in the plant, these power requirements define the basis for design of the steam system and power generation facilities.

Table 19. Plant Power Requirements

Plant Area	Generated (kW)	Consumed (kW)
Feed handling and drying ^a		0
Gasification		7,112
Tar reforming and gas cleanup		1,395
Mixed alcohol synthesis, recycle compressor, turbo-expander, syngas compressor	11,467	51,724
Alcohol separation and purification		808
Steam system and power generation	52,944	1,519
Cooling water and other utilities		798
Miscellaneous		1,000
Balance to grid		55
Plant totals	64,411	64,411

^a Power costs for all feed handling, and for drying outside the plant, are included in the feedstock cost provided by INL. Energy for drying from 30% to 10% inside the plant is provided by process heat from flue gas.

Plant power demands and power production rates are designed to be balanced. Therefore, no significant excess power is claimed for by-product credits (sale to the grid) or bought from the grid. The plant design was conducted with an energy self-sufficiency requirement, and this was accomplished by burning portions of two syngas streams – 4% of the fresh, unreformed syngas and 25% of the unconverted syngas purged from the alcohol synthesis reactor recycle loop – in the tar reformer fuel combustor (area 300). While this does have a negative impact on the overall alcohol yields of the process, it negates the purchase of natural gas or grid power during normal operations.

3.6.3 Area 600 Equipment Cost Estimations

Table 20 presents the equipment list and cost estimates for the steam system and power generation area of the plant.

Table 20. Cost Estimate for Steam System and Power Generation Area

Equipment Description	TPEC (2007 \$k)	TIC (2007 \$k)
Water treatment system (RO and EDI units)	2,465	2,835
Boiler feed water/steam/condensate handling	1,333	3,226
Extraction steam turbines/generators	13,272	23,890
Steam turbine condenser	6,215	8,701
Heat integration	2,560	7,193
Area A600 subtotal	25,845	45,845

3.7 Area 700: Cooling Water and Other Utilities

The following section presents an overview, basis for design, and cost estimates for construction of the cooling water facilities and other plant utility equipment.

3.7.1 Area 700 Overview

The cooling water and other utilities systems are shown in PFD-P820-A701 and PFD-P820-A702 in Appendix E. A mechanical draft cooling tower (M-701) provides cooling water to several heat exchangers in the plant. The tower utilizes fans to force air through circulated water.

An instrument air system is included to provide compressed air for both service and instruments. The system consists of an air compressor (K-701), dryer (S-701), and receiver (T-701). The instrument air is delivered at a pressure of 115 psia and a moisture dew point of -40°F (-40°C), and it is oil free.

Other miscellaneous items that are taken into account in the design include the following:

- Firewater storage tank (T-702) and firewater pump (P-702) for fire emergencies
- Diesel tank (T-703) and diesel pump (P-703) to fuel the front loaders
- Olivine truck dump with scale (M-702) and olivine/MgO loading system (T-706)
- Tar reformer catalyst loading system (T-707)

- Ammonia storage tank (T-704), ammonia pump (P-704), BFW chemical storage tank (T-708), and BFW chemical pump (P-707) for boiler feed water treatment.
- Caustic (NaOH) storage tank (T-705) and pump (P-705).

3.7.2 Area 700 Design Basis

Table 21 summarizes the design basis parameters for the plant's cooling water system.

Table 21. Design Basis for Cooling Water System

Cooling Water System Design Parameters	
Cooling water supply temperature (T_S)	90°F
Cooling water return temperature (T_R)	110°F
Cooling water supply rate (F_S)	11,720 gpm
Losses from evaporation (F_{EVAP})	$0.00085 * F_S * (T_R - T_S)$
Losses from drift	$0.002 * F_S$
Cycles of concentration (C)	5
Required blowdown	$F_{EVAP} / (C - 1)$
Cooling water makeup pressure	14.7 psia
Cooling water makeup temperature	60°F

Water losses from the cooling water system include evaporation, drift (water entrained in the cooling tower exhaust air), and tower basin blowdown. Drift losses were estimated to be 0.2% of the cooling water supply rate. Evaporation losses and blowdown were calculated based on information and equations in Perry et al. [17] (as shown in Table 21).

3.7.3 Area 700 Cost Estimation

Table 22 presents the equipment list and cost estimates for the cooling water and other utilities area of the plant.

Table 22. Cost Estimate for Cooling Water and Other Utilities Area

Equipment Description	TPEC (2007 \$k)	TIC (2007 \$k)
Plant/instrument air systems	307	583
Cooling water system	660	1,480
Flue gas scrubber and stack	836	1,918
Purge water treatment	361	913
Catalyst, chemicals, and product storage	2,120	4,160
Miscellaneous utility systems	276	507
Area A700 subtotal	4,560	9,560

3.8 Additional Process Design Information

Table 23 contains additional information used in the Aspen Plus model and design basis.

Table 23. Utility and Miscellaneous Design Information

Item	Design Information
Ambient air conditions ^{a,b,c}	Pressure: 14.7 psia
	T _{dry bulb} : 90°F
	T _{wet bulb} : 80°F
	Air composition (mol %): N ₂ : 75.7% O ₂ : 20.3% Ar: 0.9% CO ₂ : 0.03% H ₂ O: 3.1%
Pressure drop allowance	Syngas compressor intercoolers = 2 psi per exchanger
	Air pre-heat exchangers = 1 psi
	Heat exchangers = 5 psi

^a In the *GPSA Engineering Data Book* [39], see Table 11.4 for typical design values for dry bulb and wet bulb temperature by geography. Selected values would cover summertime conditions for most lower 48 states.

^b In Weast [40], see F-172 for composition of dry air. Nitrogen value adjusted slightly to force mole fraction closure using only N₂, O₂, Ar, and CO₂ as air components.

^c In Perry et al. [17], see psychrometric chart, Figure 12-2, for moisture content of air.

3.9 Pinch Analysis

A pinch analysis was performed to design the heat exchange network of the biomass gasification to ethanol production process. The concept of pinch technology offers a systematic approach for optimizing energy integration in process design. Temperature and heat flow (Q) data were gathered for the hot process streams (streams cooled in the process), cold process streams (streams heated in the process), and utility streams like steam, flue gas, and cooling water. A composite curve, a graphical presentation of stream temperature and heat flow (Q) data, was constructed for the hot and cold process streams. These two curves are shifted so that they touch at the pinch point. From this shifted graph, a grand composite curve is constructed that plots the difference in heat flow between the hot and cold composite curves as a function of temperature.

The total hot duty equals the total cold duty, as the Aspen Plus model is designed to adjust the water flow rate through the steam cycle until the heat balance in the system is closed. The minimum vertical distance between the curves is ΔT_{min} , which is theoretically the smallest approach temperature in the exchanger network. For this design, the pinch occurs at $\sim Q = 285$ MMBtu/h where the upper and lower pinch temperatures are 331.6°F and 316.3°F, respectively, resulting in ΔT_{min} of 15.3°F.

There are a multitude of options for heat integration network design, depending on objectives and available capital. In general, as efficiency is increased in an exchanger network design, the required heat transfer area increases and therefore capital cost increases. The objective of this network design is to lower energy consumption and boost product yields, keeping in mind that very low ΔT can lead to impractically large exchangers and high capital costs. Figure 13 shows the cumulative hot and cold pinch curves after they were simplified by removing dedicated steam generation (from the alcohol synthesis reaction), indirect steam use systems (distillation reboilers and acid gas removal), and water- and air-cooling utilities. A specific network was designed based on this philosophy and the heating and cooling curves shown in Figure 13. The exchangers are listed in the equipment list in Appendix B, with the scaling stream entries listed as “Pinch.”

The exchangers in the heat integration network are also shown on the process flow diagrams in Appendix E, with details of each exchanger listed in Appendix M. A total of 53 exchangers were included in the design with a total installed cost of approximately \$27MM. Aspen Icarus Process Evaluator is the source of the equipment cost and installation estimates for the heat integration network.

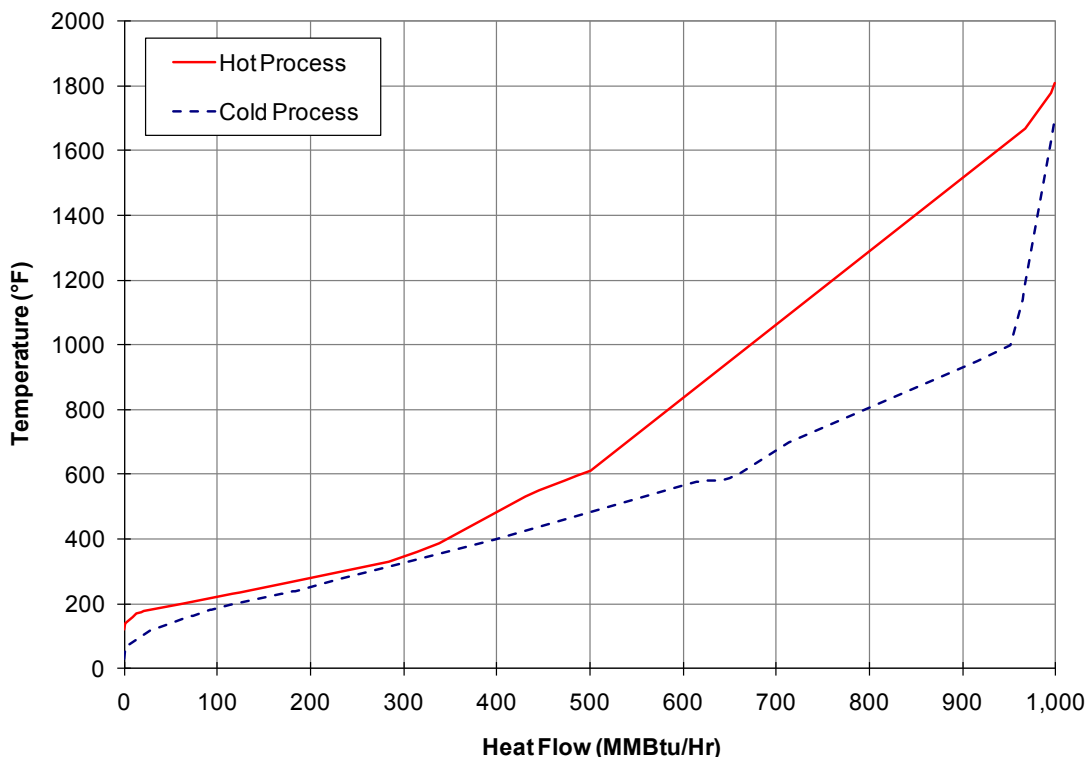

Figure 13. Pinch analysis composite curve

3.10 Energy Balance

Energy integration is important to the overall economics and efficiency of the process. Therefore a detailed understanding of how and where the energy is utilized and recovered is required. Detailed energy balances around the major process areas were derived using data from the Aspen Plus simulation. Comparing the process energy inputs and outputs allows the energy efficiency of the process to be quantified. Tracing energy transfer between process areas also makes it possible to identify potential improvements to the energy efficiency.

This design for thermochemical conversion of cellulosic biomass was constructed with the goal of energy self-sufficiency. Natural gas inputs that could be used to fire the char combustor and fuel combustor have been eliminated. Instead, a slip-stream of unreformed syngas and a portion of the unreacted syngas from the alcohol synthesis reactor are used to meet the fuel demand. The downside to this is a decrease in ethanol yield. Because no electricity is purchased from the grid, the integrated combined heat and power system must supply all steam and electricity needed by the plant. A negligible amount of electricity is sold as a co-product. The only saleable products are assumed to be fuel ethanol and higher-molecular-weight mixed alcohol co-product.

The distribution of the total energy content in dry wood (LHV basis) is shown in Figure 14. The total energy in the dry portion of the feed (0% moisture) is approximately 1,470 MMBtu/h. Figure 14 shows that approximately 45% of the LHV is recovered in ethanol and higher alcohol products. A significant amount (23%) is lost through air-cooled exchangers, and about 15% is lost because of moisture in the feed and other water input to the process. Electrical and thermal losses account for 11%.

Further optimization of the heat integration network can be evaluated. However, it is our expectation that further heat integration for this process design will have marginal impact on the MESP and should therefore be addressed only if there is a detailed plant design.

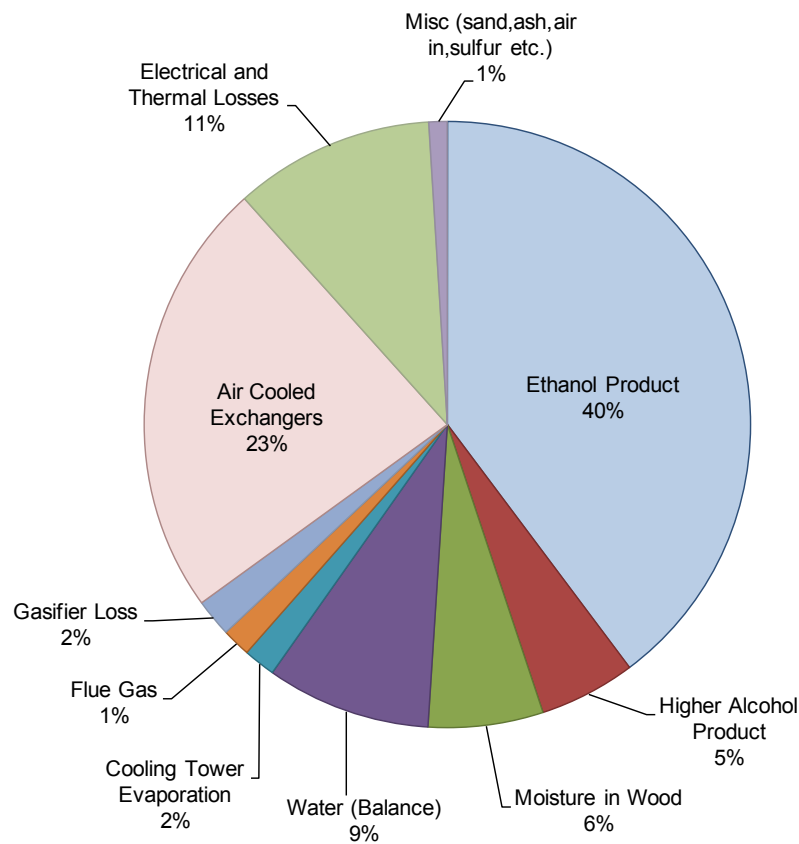

Figure 14. Overall energy analysis (dry wood LHV basis)

3.11 Sustainability Metrics

An important aspect of evaluating biomass-derived fuel processes is the quantification of life cycle resource consumption and environmental emissions. Life cycle assessment (LCA) provides a framework from which the environmental sustainability of a given process may be quantified. This section presents some key LCA input data from the thermochemical ethanol model. These data are not an exhaustive life cycle inventory and are only intended to facilitate populating the direct resource consumption and environmental emissions attributed to producing ethanol via indirect gasification and mixed alcohol synthesis.

Table 24 quantifies the consumption of resources and emissions from the plant. Two cases are presented in the table for water consumption values – the base design case and an optimized water consumption scenario recently developed by NREL and Harris Group Inc. The optimized scenario efficiently utilizes reverse osmosis (RO) and brine recovery units to recycle and reuse water in the plant. NREL continues to evaluate options for further reduction of water consumption and environmental emissions without significant economic penalty. Consumption and discharge of materials other than water are equal in both cases.

Table 24. Sustainability Metrics for Thermochemical Ethanol

	Base Case		Optimized Water Consumption (if varied from Base Case)	
	Flow rate lb/h	Per gal EtOH (gal/h) lb/gal (gal/gal)	Flow rate lb/h	Per gal EtOH (gal/h) lb/gal (gal/gal)
Water inputs				
Water in biomass	78,736	(9,463)	10.23	(1.23)
Water in air to char combustor	9,320	(1,120)	1.21	(0.15)
Water in air to catalyst regenerator	4,950	(595)	0.64	(0.08)
Water in air to LO-CAT	2	(0)	0.00	(0.00)
Makeup water to cooling tower	91,076	(10,946)	11.84	(1.42)
Makeup water to boiler system	76,348	(9,176)	9.92	(1.19)
24,070	(2,893)	3.13	(0.38)	
101,798	(12,234)	13.23	(1.59)	
Water outputs				
Ash wetting	243	(29)	0.03	(0.00)
Cooling tower drift	11,729	(1,410)	1.52	(0.18)
Cooling tower evaporation	98,651	(11,856)	12.82	(1.54)
Cooling tower blowdown to WWT	24,663	(2,964)	3.21	(0.39)
Other wastewater to WWT	28,828	(3,465)	3.75	(0.45)
7,710	(927)	1.00	(0.12)	
Flue gas	128,420	(15,434)	16.69	(2.01)
129,821	(15,602)	16.87	(2.03)	
CO ₂ exhaust	34	(4)	0.00	(0.00)
Syngas scrubber solids	52	(6)	0.01	(0.00)
Total water inputs	260,432	(31,299)	33.85	(4.07)
Total water outputs	292,620	(35,167)	38.03	(4.57)
218,876	(26,305)	28.45	(3.42)	
251,370	(30,210)	32.67	(3.93)	

Note: Water output is larger than water input because water is produced in the process.

Table 24 (continued). Sustainability Metrics for Thermochemical Ethanol

	Flow rate lb/h	Per gal EtOH lb/gal
Other inputs		
Biomass (water-free)	183,718	23.9
Olivine	538	7.0×10^{-2}
Magnesium oxide (MgO)	7.0	9.1×10^{-4}
Tar reforming catalyst	12.0	1.6×10^{-3}
Alcohol synthesis catalyst	19.4	2.5×10^{-3}
Caustic	40.0	5.2×10^{-3}
Boiler chemicals	3.3	4.3×10^{-4}
Cooling tower chemicals	1.2	1.5×10^{-4}
Diesel fuel	70.9	9.2×10^{-3}
LO-CAT chemicals	3.2	4.1×10^{-4}
DEPG makeup	1.8	2.3×10^{-4}
Amine makeup	0.2	2.3×10^{-5}
Air demand		
Carbon dioxide (CO ₂)	360	4.7×10^{-2}
Nitrogen (N ₂)	541,603	70.4
Oxygen (O ₂)	165,948	21.6
Air emissions		
Carbon dioxide (CO ₂)	232,769	30.2
Sulfur dioxide (H ₂ S)	9.4	1.2×10^{-3}
Nitrogen dioxide (NO ₂) ^a	8.6×10^{-3}	1.1×10^{-6}
Nitrogen (N ₂)	541,810	70.4
Oxygen (O ₂)	25,738	3.3
Waste streams		
Olivine, MgO, catalyst, ash, sulfate	2,708	3.5×10^{-1}
Alcohol synthesis catalyst ^b	23.3	3.0×10^{-3}
Products		
Ethanol	51,000	6.63
Mixed higher alcohols	6,448	8.4×10^{-1}
Sulfur	39	5.1×10^{-3}

^a Based on nitrogen in fuel. Additional NO_x from N₂ in combustion air is not quantified.

^b 20% additional mass applied to fixed bed catalyst waste to account for deposits.

Water usage is an increasingly important aspect of plant design, specifically for ethanol plants. Most U.S. ethanol plants reside in the Midwest where water supply is a significant concern [41]. For several years, significant areas of water stress have been reported during the growing season. In addition, livestock and irrigation operations compete for the available resources.

Table 25 presents a comparison of water consumption volumes for gasoline from crude oil, ethanol from corn, and ethanol from the thermochemical pathway. The water consumption

values for gasoline and corn ethanol are from a report by Wu et al. from Argonne National Laboratory [42]. The conversions of ethanol to gasoline energy equivalents use a factor of 1.52, a result of dividing the energy content of gasoline by that of ethanol (115,500 Btu per gallon gasoline / 76,000 Btu per gallon ethanol).

Table 25. Comparison of Water Usage for Transportation Fuel Processes

Transportation Fuel Description	Gal Water per Gal Product	Gal Water per Gal Gasoline Equiv.
Crude oil refining to gasoline	2.8–6.6	2.8–6.6
Corn ethanol	10.0–323.6	15.2–491.9
Thermochemical cellulosic ethanol (base case)	2.6	4.0
Thermochemical cellulosic ethanol (optimized water consumption case)	2.0	3.0

4 Process Economics

The first steps of the economic analysis are to determine the total capital investment (TCI), variable operating costs, and fixed operating costs associated with constructing and operating the plant. With these estimated costs, a discounted cash flow analysis is then used to determine the production cost of ethanol for a project having a net present value of zero at an assumed internal rate of return (IRR). This section describes the cost areas and the necessary assumptions required to complete the discounted cash flow analysis.

4.1 Total Capital Investment (TCI)

The following discussion summarizes the purchased and installed equipment costs presented in Section 3 of the design report and describes how the total installed costs (TIC) for the plant serve as the basis for determining the total capital investment (TCI).

As previously discussed, the capital costs for each plant area are based on data from various sources including technology licensors, industry equipment suppliers, cost estimates from Harris Group Inc., published literature, and Aspen Icarus Process Evaluator 2006.5 cost estimating software, which is based on first quarter 2007 costs. The purchased costs for the equipment and installation factors are used to determine the installed equipment cost. Table 26 presents a summary of total purchased equipment costs (TPEC), installation factors ($f_{\text{installation}}$), and total installed costs (TIC) for each area of the plant, the bases for which are discussed in further detail in Section 3, Appendix A, and Appendix B.

Table 26. General Cost Factors in Determining Total Installed Equipment Costs

Area	Process Description	TPEC (MM\$)	$f_{\text{Installation}}$	TIC (MM\$)
100	Feed handling and drying ^a	Capital costs included in feedstock price		
200	Gasification	18.7	2.31	43.3
300	Gas cleanup	12.6	2.14	26.9
400	Alcohol synthesis	74.7	2.01	150.5
500	Alcohol separation	13.2	1.54	20.3
600	Steam plant and power	25.8	1.77	45.8
700	Cooling water and other utilities	4.6	2.10	9.6
ISBL	(Areas 100–500)	119.3	2.02	241.0
OSBL	(Areas 600–700)	30.4	1.82	55.4
Total		149.7	1.98	296.4

^a Investment costs for feed handling and drying are included in the per-unit woody feedstock price.

The indirect costs (non-manufacturing fixed-capital investment costs) are estimated using factors based on the total direct cost (TDC). The TDC is shown in Table 28. The factors are summarized in Table 27 as percentages of total purchased equipment cost (TPEC), total direct cost (TDC), and fixed capital investment (FCI), which is equal to the sum of TDC and total indirect costs.

Table 27. Cost Factors for Indirect Costs

Indirect Costs	% of TPEC	% of TDC^a	% of FCI^a
Prorated expenses	20.4	10.0	6.3
Home office and construction fees	40.9	20.0	12.5
Field expenses	20.4	10.0	6.3
Project contingency	20.4	10.0	6.3
Other costs (start-up and permits)	20.4	10.0	6.3
Total indirect costs	122.7	60.0	37.5
Working capital			5.0

^a Percentages of TDC and FCI exclude land purchase cost.

With the calculated total installed cost and assumptions for indirect costs and working capital, the fixed capital investment (FCI) and total capital investment (TCI) are calculated. Table 28 presents a summary of these calculations.

Table 28. Project Cost Worksheet

Total purchased equipment cost (TPEC)		\$149,720,048
Installation factor		1.980
Total installed cost (TIC)		\$296,447,211
Other direct costs		
Land (not depreciated)		\$1,610,000
Site development	4.0% of ISBL	\$9,641,711
Total direct costs (TDC)		\$307,698,921
Indirect costs	% of TDC (ex Land)	
Prorated expenses	10.0%	\$30,608,892
Home office and construction fees	20.0%	\$61,217,784
Field expenses	10.0%	\$30,608,892
Project contingency	10.0%	\$30,608,892
Other costs (start-up and permits)	10.0%	\$30,608,892
Total indirect costs	60.0%	\$183,653,353
Fixed capital investment (FCI)		\$491,352,274
Working capital	5.0% of FCI (ex Land)	\$24,487,114
Total capital investment (TCI)		\$515,839,388
TCI / TPEC		3.445
FCI Lang Factor = FCI / ISBL TPEC		4.118
TCI Lang Factor = TCI / ISBL TPEC		4.323

4.2 Variable Operating Costs

There are two types of operating costs – variable and fixed. The following sections present assumptions and calculation approaches to determine the variable and fixed operating costs associated with thermochemical ethanol production.

The basis for variable operating costs considered in this analysis is summarized in Table 29. A detailed summary of variable plant operating costs is presented in Appendix C.

Table 29. Summary of Variable Operating Costs

Variable	Information and Operating Cost (cost year in parentheses)
Gasifier bed material	Synthetic olivine and MgO. Initial fill then a replacement rate of 0.01 wt % of circulation or 7.2 wt % per day of total inventory. Delivered to site by truck with self-contained pneumatic unloading equipment. Disposal by landfill. Olivine price: \$172.90/ton (2004) [43]. MgO price: \$365/ton (2004) [44].
Tar reformer catalyst	To determine the amount of catalyst inventory, the tar reformer was sized for a gas hourly space velocity (GHSV) of 2,476/h based on the operation of the tar reformer at NREL's TCPDU. GHSV is measured at standard temperature and pressure. Initial fill then a replacement rate of 0.1 wt % of catalyst inventory per day. Price: \$17.74/lb (2007) based on NREL calculations using metals pricing and costs for manufacturing processes.
Alcohol synthesis catalyst	Initial fill then replaced every 2 years based on expected catalyst lifetime. Catalyst inventory based on GHSV of 5,000/h. Price: \$29.70/lb (2007) based on NREL calculations using metals pricing and costs for manufacturing processes. Salvage value: \$4.12/lb (2007) based on metals reclamation quotations.
Solids disposal	Price: \$36/tonne (1998) [16]
Diesel fuel	Usage: 10 gal/h plant-wide use. 2012 price projection: \$21.29/MMBtu (2009) [45] = \$2.86/gal at 0.85 specific gravity [corrected to 2007 currency by EIA index (2007 = 106.2, 2009 = 109.8)].
Water makeup	Price: \$0.22/tonne (2001) [16] = \$0.20/ton.
Chemicals	Boiler feed water chemicals – Price: \$1.40/lb (1991) [2]. Cooling tower chemicals – Price: \$1.00/lb (1999) [2]. Caustic – Price: \$150/dry ton (2010) [38]. LO-CAT chemicals – Price: \$408/ton sulfur produced (2009) from NREL/Harris Group Inc. estimates based on other projects. DEPG makeup – Price: \$56.55/million lb acid gas removed (2004) [46]. Selective amine makeup – Price: \$16.94/million lb acid gas removed (2010).
Wastewater	The wastewater is sent to on-site treatment facility. Price: \$0.53/tonne (2001) [16]

Note: Costs shown in Table 29 were updated to 2007 dollars using an inorganic cost index [47].

Values used: 1991 = 125.6; 1998 = 148.7; 1999 = 149.7; 2001 = 158.4; 2004 = 172.8; 2007 = 203.3; 2010 = 233.9.

4.3 Fixed Operating Costs

This section considers the plant's fixed operating costs, which include employee salaries and benefits, overhead, plant maintenance costs, insurance, and taxes (other than income taxes). The fixed operating costs used in this analysis are shown in Table 30 (labor costs) and Table 31 (other fixed costs).

Table 30. Salary Costs for Plant Employees

Position Title	Salary (2007)	Number of Positions	Total Cost (2007)
Plant manager	\$147,000	1	\$147,000
Plant engineer	\$70,000	1	\$70,000
Maintenance supervisor	\$57,000	1	\$57,000
Laboratory manager	\$56,000	1	\$56,000
Shift supervisor	\$48,000	5	\$240,000
Lab technician	\$40,000	2	\$80,000
Maintenance technician	\$40,000	16	\$640,000
Shift operators	\$48,000	20	\$960,000
Yard employees	\$28,000	12	\$336,000
Clerks and secretaries	\$36,000	3	\$108,000
Total salaries (2007)			\$2,694,000

Note: Labor costs are indexed, if necessary, to values from the U.S. Bureau of Labor Statistics (<http://data.bls.gov/cgi-bin/srgate> CEU3232500008)

Because the salaries listed above do not include benefits, a general overhead factor is applied. The factors for other fixed costs in Table 31 also include general plant maintenance, plant security, janitorial services, communications, etc. A detailed summary of fixed plant operating costs is presented in Appendix C.

Table 31. Other Fixed Operating Costs

Cost Item	Factor	Cost
Benefits and general overhead	90.0% of total salaries	\$2,424,600
Maintenance	3.0% of fixed capital investment (FCI) ^a	\$14,694,771
Insurance and taxes	0.7% of fixed capital investment (FCI) ^a	\$3,428,780
Total other fixed operating costs (2007)		\$20,548,151

^a Percentages of FCI exclude land purchase cost.

4.4 Value of Higher Alcohol Co-Products

The alcohol synthesis process will create higher-molecular-weight alcohols in addition to ethanol. The valuation of this co-product is a function of the market in which it can be sold. Two extreme cases are considered here. At the high end, the co-product might be sold into the chemical market, commanding a high value of approximately \$4 per gallon [48]. However, it is unlikely that the market would support the co-products from more than a few biomass plants. Therefore, because this design report assumes nth-plant economics, the economic analysis does not take credit for higher alcohols sold into the chemical market.

At the low end, the co-product could command a value as a heating or transportation fuel with minimal ASTM standards on its specifications. In this scenario, the co-product would be priced relative to other heating and transportation fuels, such as gasoline, based on the heating value. This co-product valuation approach is applied for the base case economic analysis and calculation of MESP. Table 32 presents the co-product pricing calculations, which are based on the projected 2012 wholesale value of gasoline from the U.S. Energy Information Administration [49], inflation-adjusted to reflect a 2007 pricing basis. The calculated value of the mixed alcohols co-product is \$2.11 per gallon based on the energy value of the mixed alcohols stream. The co-product value conservatively assumed for the technoeconomic analysis is \$1.88 per gallon (approximately 90% of the calculated value).

Table 32. Higher Alcohols Co-Product Pricing

Description	Value
EIA projected 2012 wholesale gasoline price (U.S. 2007\$)	\$2.62/gallon
Gasoline energy value	5.218 MMBtu/bbl
Volume conversion	42 gallons/bbl
EIA projected 2012 wholesale gasoline value (U.S. 2007\$)	\$21.09/MMBtu
Higher alcohols product energy value (from Aspen Plus simulation results)	100,149 Btu/gallon
Calculated higher alcohols product value (U.S. 2007\$)	\$2.11/gallon
Higher alcohols product value for analysis (U.S. 2007\$)	\$1.88/gallon

4.5 Minimum Ethanol Selling Price

Once the capital and operating costs are determined, a minimum ethanol selling price (MESP) is determined using a discounted cash flow rate of return analysis. The general methodology used is identical to that applied by Aden et al. (2002) [22]. The MESP value represents the selling price of ethanol assuming a 30 year plant life and 40% equity financing with 10% internal rate of return and the remaining 60% debt financed at 8% interest. The base case economic parameters used in this analysis were presented in Section 1.3 and summarized in Table 1. The resulting base case MESP is \$2.05 per gallon of ethanol in U.S. 2007\$. Sensitivity analysis was performed to examine the variability of the MESP as a function of changes in various process parameters, raw material costs, and financial assumptions. The results of the sensitivity analysis are discussed in Section 5.

5 Process Economics and Sensitivity Analyses

The cost of ethanol as determined in the previous section was derived using technology that has been developed and demonstrated or is currently being developed as part of the U.S. Department of Energy's biomass research programs, which includes collaboration with industrial partners. The combination of all process, market, and financial targets as well as other assumptions presented in this design report result in a minimum ethanol selling price of \$2.05 per gallon. A summary of the costs contributing to the total ethanol selling price is presented in Figure 15 and tabulated in Appendix C.

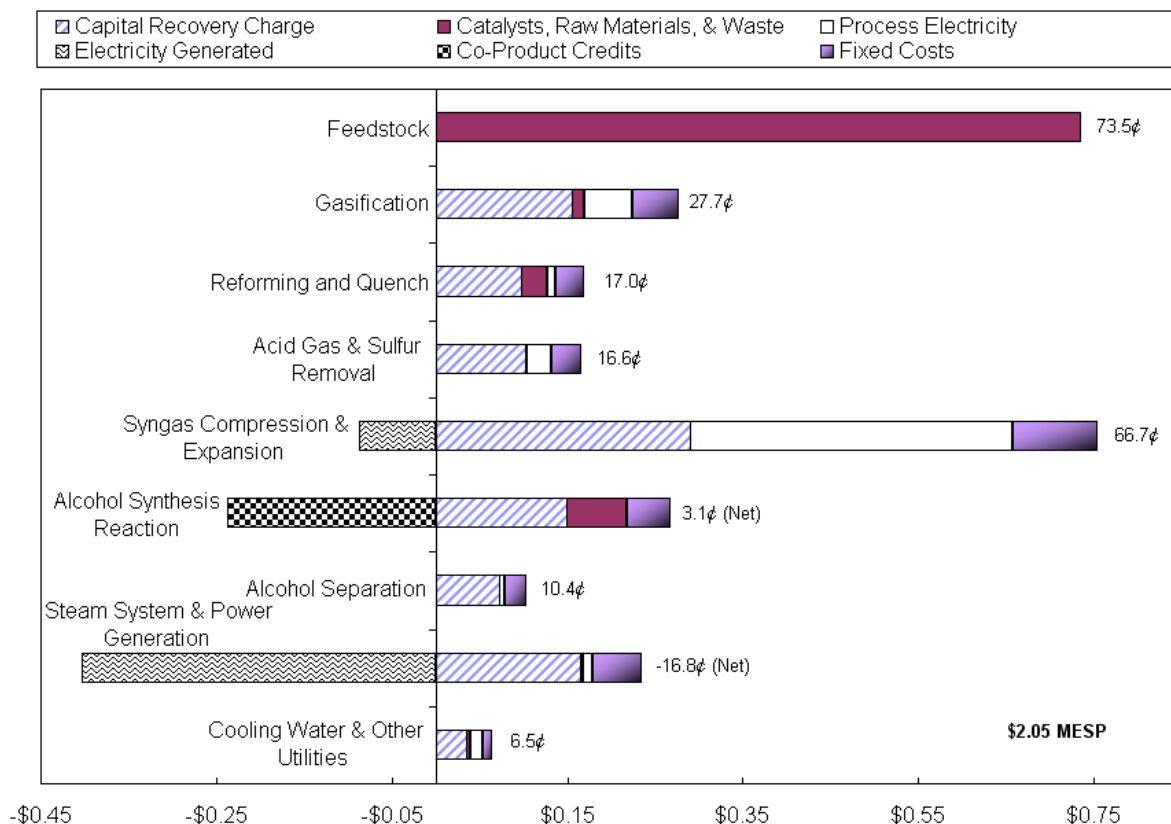

Figure 15. Cost contribution details from each process area

This cost contribution chart shows co-product credits for higher alcohols from the alcohol synthesis area, for electricity from the syngas expansion area, and for electricity from the steam system and power generation area. However, the process was adjusted so that the electricity generated is balanced by the electricity required by all other areas, so there is no net credit for electricity generation.

The total cost of ethanol production, as indicated by the MESP, is determined from the amalgamation of various assumptions, both technical and financial. The 2012 research targets for cost-competitive ethanol (Appendix I) were the basis for this design. Financial and market assumptions include future demand for products like higher alcohols, financing criteria like internal rate of return (IRR) for equity investors, and interest on debt. In addition, potential

variability in equipment design, installation, and construction costs may impact economics. Although the assumptions and estimated plant capital costs are reasonable, it is important to consider the impact of deviations from base case values. Sensitivity analysis results for project parameters identified by subject matter experts as critical factors in determining an accurate MESP are discussed here. The results for the sensitivity analysis are summarized in Figure 16. The data are organized by potential impact of parameter deviation on MESP value (highest to lowest). Most of the sensitivity scenarios represent a deviation in a single project parameter (e.g., higher alcohol co-product value or plant life) with all other parameters remaining constant at base case values. One exception is the scenario in which plant feedstock is varied from woody biomass to corn stover, requiring the entire feed composition (contents of carbon, hydrogen, nitrogen, sulfur, oxygen, ash, and moisture) to change simultaneously.

Note that each sensitivity scenario in Figure 16 has an associated deviation value from the base case. If a deviation bar is not visible, then the impact on MESP is negligible. All sensitivity scenarios are discussed further in the following sections. The case numbers in the text refer to the numbers shown in the labels of Figure 16.

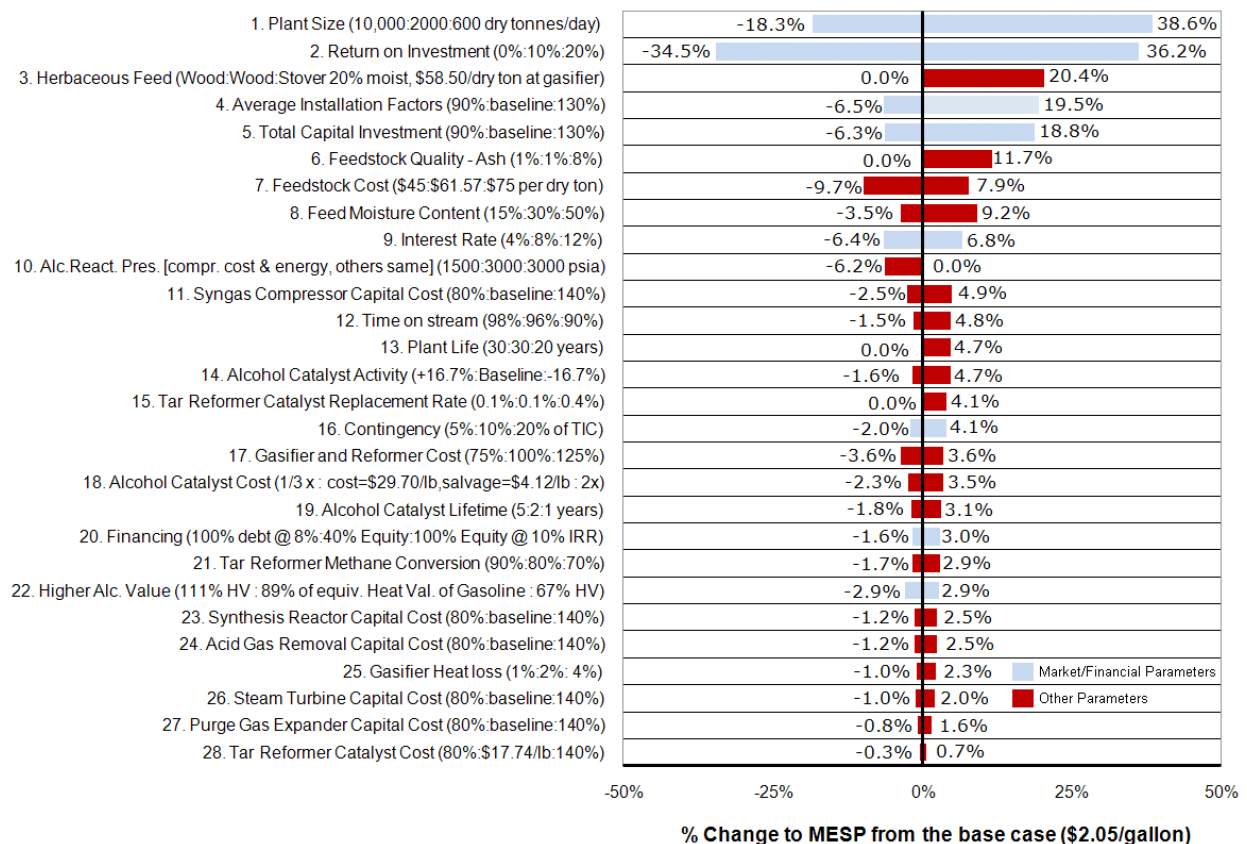

Figure 16. Results of sensitivity analyses

5.1 Financial Scenarios

Deviations from base case financial and market parameters can have significant impacts on the MESP. The base case financial assumptions are shown in Table 1. Case 1 in Figure 16 shows the possible savings realized by economies of scale from changes to the plant size. It is assumed in the plant size sensitivity scenario that the same technology is utilized for all plant sizes. A major constraint to larger plant sizes will be significantly higher feedstock transportation costs. An increase in required IRR for the project from 10% to 20% (case 2) would increase the MESP from \$2.05 to \$2.79 per gallon (an increase of 36%). An interest rate increase (case 9) from the base value of 8% to 12% increases MESP to \$2.19 per gallon (an increase of 7%). Successful R&D and demonstration projects would reduce investment and lending risks and ease the expected rate of return to investors and minimize loan interest rates, reducing the MESP toward the base case value.

Variability in total capital investment (TCI) can also have a major impact on MESP. Conceptual designs like this generally result in accuracy of $\pm 10\%$ to 30% for capital investment estimation [16]. Applying a variability range of -10% to $+30\%$ to a TCI sensitivity (case 5) results in an MESP range of \$1.92 to \$2.43 per gallon (-6% to $+19\%$). The impact of installation factors (case 4) yields nearly identical results because this study is based on factored estimates.

5.2 Feedstock

Although the plant design basis specifies woody biomass feedstock from southern pine, there is potential for other feedstocks to be introduced as feed, based on future biomass availability. The negative impacts of higher ash and moisture contents on the MESP are quantified in case 6 and case 8. Product yields decrease for higher moisture feedstocks because more energy is used for drying. The impacts of changes in the feedstock cost (case 7) and the use of a corn stover feedstock (case 3) – the feedstock for NREL’s biochemical process 2012 target base case design [38] – are also shown. The high ash, low carbon, and high oxygen content in corn stover results in a 20% increase in the MESP (case 3).

5.3 Gasification and Gas Cleanup

The impact of changes to the capital costs of the gasifier and reformer is shown in case 17. Additional heat losses from the gasifier (case 25) will decrease yields, leading to increases in the MESP.

Increasing methane conversion (case 21) to 90% in the reformer from a base case value of 80% will decrease the MESP by 2%. There is a potential for realizing this savings by the 2012 demonstration because NREL’s reforming catalyst has shown such conversions under some conditions. The impacts of changes to the reforming catalyst cost (case 28) and longevity (case 15) are also shown.

5.4 Alcohol Synthesis

Case 14 shows that improving the alcohol synthesis catalyst activity by 17% can reduce the MESP by 2% (keeping all other performance factors constant; the economic benefit can be slightly higher if the process is further optimized to take full advantage of the improved activity). Case 10 shows that the compressor capital cost and energy savings from operating the synthesis reactor at 1,500 psi (compared to 3,000 psi in the base design) can reduce the MESP by 6%, assuming there are no other changes to the process. Extending the catalyst lifetime (case 19)

from the base case of 2 years and reducing the catalyst cost from the base case value (case 18) will also reduce the MESP.

5.5 Co-Product Value

The higher alcohol co-product value for the base case is calculated from the product's heating value and the 2012 EIA projected gasoline value (Table 32). In the base case the co-product value is about 90% of the gasoline equivalent higher heating value. It is assumed that there will be demand for the higher-molecular-weight mixed alcohols in the liquid fuels market. This sensitivity analysis (case 22) shows the MESP impact from higher and lower co-product values, which can represent variability in demand. A co-product valuation range of 111% to 67% of the gasoline equivalent cost by heating value (125% to 75% of the heating value for the base case) results in an MESP range of \$1.99 to \$2.11 per gallon (-3% to +3%).

6 Conclusions

This analysis shows that biomass-derived ethanol from a thermochemical conversion process continues to show the potential to be cost-competitive with gasoline. The gasoline equivalent price by higher heating value is \$3.11 per gallon, not including retail taxes, tax credits, or costs for distribution, blending, and marketing. The sensitivity analysis shows there is less than $\pm 20\%$ prediction uncertainty in MESP resulting from a $\pm 30\%$ uncertainty in the total capital cost estimation. While there is always a chance of large escalations in capital costs, acquisition of recent estimates and vendor quotes for most of the equipment reduces the probability of gross over- or under-estimation of costs. All processes used in the plant design are commercially available with the exception of the gasifier and tar reformer. Experimental results continue to approach the 2012 technical targets (details in Appendix I), meaning that the predictions presented in this report are closer to practice than those of the previous report published in 2007. Bench-scale experiments have shown that, in areas like methane conversion, actual performance can surpass the technical targets, resulting in reduced actual costs.

7 Future Work

The ultimate success of OBP's program to demonstrate technologies capable of producing cost-competitive ethanol via biomass gasification by 2012 will depend on final scale-up and integration of research areas that have continued to make individual progress. Significant improvements have been made in the key areas of reforming and alcohol synthesis. Pilot-scale equipment to demonstrate continuous fluidized bed reforming and alcohol synthesis is expected to soon be operational at NREL.

Once test facilities become available, a significant effort will be required to demonstrate improved longevity of tar reforming and alcohol synthesis catalysts. While catalyst improvement is one path for achieving these goals, the identification of optimal operating conditions for existing catalysts will also play a significant role.

Research and development activities to improve the performance of both mixed alcohol and tar reforming catalysts are ongoing and are leveraged through collaboration with several industrial partners (names withheld for confidentiality). Improvements will be captured in the process model, and translated to full analysis of MESP, in future State of Technology (SOT) reports.

8 References

1. 110th United States Congress, H.R.6: Energy Independence and Security Act of 2007, in *Public Law 110-140*, January 2007. http://frwebgate.access.gpo.gov/cgi-bin/getdoc.cgi?dbname=110_cong_bills&docid=f:h6enr.txt.pdf.
2. Phillips, S.; Aden, A.; Jechura, J.; Dayton, D.; Eggeman, T. *Thermochemical Ethanol via Indirect Gasification and Mixed Alcohols Synthesis of Lignocellulosic Biomass*. Report No. NREL/TP-510-41168. Golden, CO: National Renewable Energy Laboratory, 2007. <http://www.nrel.gov/docs/fy07osti/41168.pdf>.
3. Wyman, C.E.; Bain, R.L.; Hinman, N.D.; Stevens, D.J. "Ethanol and Methanol from Cellulosic Materials," Chapter 21. Johansson, T.B., et al., ed. *Renewable Energy: Sources for Fuels and Electricity*. Washington, DC: Island Press, 1993.
4. Dutta, A.; Bain, R.L.; Bidy, M.J. "Techno-Economics of the Production of Mixed Alcohols from Lignocellulosic Biomass via High-Temperature Gasification." *Environmental Progress and Sustainable Energy*; Vol. 29, No. 2, July 2010; pp. 163-174.
5. Dutta, A.; Phillips, S.D. *Thermochemical Ethanol via Direct Gasification and Mixed Alcohol Synthesis of Lignocellulosic Biomass*. Report No. TP-510-45913. Golden, CO: National Renewable Energy Laboratory, 2009. <http://www.nrel.gov/docs/fy09osti/45913.pdf>.
6. Bain, R.L.; Craig, K.R.; Overend, R.P. "Gasification for Heat and Power, Methanol, and Hydrogen," Chapter 9.2. Rosillo-Calle, F., et al., ed. *Industrial Uses of Biomass Energy*. London: Taylor and Francis, 2000. ISBN-0-7484-0884-3.
7. Internal Revenue Service. *How to Depreciate Property*. Internal Revenue Service Publication 946. Washington, DC: United States Department of the Treasury, 2009. <http://www.irs.gov/pub/irs-pdf/p946.pdf>.
8. Tao, L.; Aden, A. "The Economics of Current and Future Biofuels." *In Vitro Cell Dev. Biol.*; Vol. 45, 2009; pp. 199-217.
9. F.O. Lichts. *Ethanol Production Costs: A Worldwide Survey*. Turnbridge Wells, Kent, UK: Agra Informa, 2007.
10. Kwiatkowski, J.R.; McAloon, A.J.; Taylor, F. "Modeling the Process and Costs of Fuel Ethanol Production by the Corn Dry-Grind Process." *Ind. Crops Prod.*; Vol. 233, 2006; pp. 288-296.
11. Rodrigues, A.P. *Participação dos fornecedores de cana na cadeia do açúcar e álcool*. Congresso Internacional de Tecnologias na Cadeia Produtiva, Concana Uberaba, MG, março de, 2007 (in Portuguese).
12. Seabra, J.E.A. *Technical-Economic Evaluation of Options for Whole Use of Sugar Cane Biomass in Brazil*. Ph.D. Thesis. Campinas Faculdade de Engenharia Mecânica Universidade Estadual de Campinas, 2007 (in Portuguese).

13. Graboski, M.S.; McCormick, R.L. "Combustion of Fat and Vegetable Oil Derived Fuels in Diesel Engines." *Prog. Energy Combust. Sci.*; Vol. 24, 1998; pp. 125-164.
14. Haas, M.J.; McAloon, A.J.; Yee, W.C.; Foglia, A.T. "A Process Model to Estimate Biodiesel Production Cost." *Biores. Technol.*; Vol. 97, 2006; pp. 671-678.
15. Garrett, D.E., *Chemical Engineering Economics*. New York: Van Nostrand Reinhold, 1989.
16. Peters, M.S.; Timmerhaus, K.D.; West, R. *Plant Design and Economics for Chemical Engineers*, 5th ed., International Edition. New York: McGraw-Hill, Inc., 2004.
17. Perry, R.H.; Green, D.W.; Maloney, J.O. *Perry's Chemical Engineers' Handbook*, 7th ed. New York: McGraw-Hill, 1997.
18. Plant Cost Index. *Chemical Engineering*. December 2010.
19. Perlack, R.D.; Wright, L.L.; Turhollow, A.F.; Graham, R.L.; Stokes, B.J.; Erbach, D.C. *Biomass as Feedstock for a Bioenergy and Bioproducts Industry: the Technical Feasibility of a Billion-Ton Annual Supply*. DOE/GO-102995-2135 & ORNL/TM-2005/66. A joint U.S. Department of Energy and U.S. Department of Agriculture report, April 2005. http://www1.eere.energy.gov/biomass/pdfs/final_billionton_vision_report2.pdf.
20. Craig, K.R.; Mann, M.K. *Cost and Performance Analysis of Biomass-Based Integrated Gasification Combined-Cycle (BIGCC) Power Systems*. Report No. NREL/TP-430-21657. Golden, CO: National Renewable Energy Laboratory, October 1996. <http://www.nrel.gov/docs/legosti/fy97/21657.pdf>.
21. Feldmann, H.F.; Paisley, M.A.; Appelbaum, H.R.; Taylor D.R. *Conversion of Forest Residues to a Methane-Rich Gas in a High-Throughput Gasifier*. Report DE88013138. Columbus, OH: Battelle, 1988. Ultimate analysis for pine wood retrieved from ECN Phyllis: <http://www.ecn.nl/phyllis/single.html>.
22. Aden, A.; Ruth, M.; Ibsen, K.; Jechura, J.; Neeves, K.; Sheehan, J.; Wallace, B.; Montague, L.; Slayton, A.; Lukas, J. *Lignocellulosic Biomass to Ethanol Process Design and Economics Utilizing Co-Current Dilute Acid Prehydrolysis and Enzymatic Hydrolysis for Corn Stover*. Report No. NREL/TP-510-32438. Golden, CO: National Renewable Energy Laboratory, June 2002. <http://www.nrel.gov/docs/fy02osti/32438.pdf>.
23. Magee, J.S. *Fluid Catalytic Cracking: Science and Technology*. The Netherlands: Elsevier Publishing Company, July 1993; p. 21.
24. Apanel, G.; Wright, H.A. "System and Method for Dual Fluidized Bed Gasification," U.S. Patent Application No. US 2010/0181539 A1, July 22, 2010.
25. Cohen, A.P.; Reynolds, T.M.; Davis, M.M. "Adsorbent for Drying Ethanol," U.S. Patent Application No. US 2010/0081851 A1, April 1, 2010.

26. Pottie, M.; Guimier, D. *Preparation of Forest Biomass for Optimal Conversion*. Pointe-Claire, Quebec, Canada: FERIC IEA (Forest Engineering Research Institute of Canada International Energy Agency), 1985. ISSN 0381-7733.
27. Rummer, Dr. R., Project Leader, Forest Operations Research, USDA Forest Service, Auburn, AL, personal communication with the INL authors.
28. Hall, P. *Storage Guidelines for Wood Residues for Bioenergy*. Prepared by Scion Next Energy Biomaterials for EECA (Energy Efficiency and Conservation Authority), 2009.
29. Sinclair, S.; Hassler, C.; Bolstad, K. "Moisture Loss in Aspen Logging Residue." *Wood and Fiber Science*; Vol. 16, No. 1, 1984; pp. 93-96.
30. Mann, M.K.; Spath, P.L. *Life Cycle Assessment of a Biomass Gasification Combined-Cycle Power System*. Report No. NREL/TP-430-23076. Golden, CO: National Renewable Energy Laboratory, 1997. <http://www.nrel.gov/docs/legosti/fy98/23076.pdf>.
31. Paisley, M.A. "Advanced Biomass Gasification for the Production of Biopower, Fuels and Chemicals." Presented at the 2007 AIChE Annual Meeting, Salt Lake City, Utah.
32. Yung, M. M.; Magrini-Bair, K. A.; Parent, Y. O.; Carpenter, D. L.; Feik, C. J.; Gaston, K. R.; Pomeroy, M. D.; Phillips, S. D. "Demonstration and Characterization of Ni/Mg/K/AD90 Used for Pilot-Scale Conditioning of Biomass-Derived Syngas." *Catalysis Letters*; Vol. 134(3-4), 2010; pp. 242-249.
33. Ravi, G.; Gupta, S.K.; Viswanathan, S.; Ray, M.B. "Optimization of Venturi Scrubbers Using Genetic Algorithm." *Ind. Eng. Chem. Res.*; Vol. 41, No. 12, 2002; pp. 2988-3002.
34. Doctor, R.D.; Molburg, J.C.; Thimmapuram, P.R. *KRW Oxygen-Blown Gasification Combined Cycle: Carbon Dioxide Recovery, Transport, and Disposal*. Argonne, Illinois: Argonne National Laboratory Energy Systems Division, August 1996. http://www.fischer-tropsch.org/DOE/DOE_reports/Doctor/ANL-ESD-34/ANL-ESD-34,%20Part%201,%20Pages%201-83.pdf.
35. Gary, J.H.; Handwerk, G.E. *Petroleum Refining Technology and Economics*, 4th ed. New York: Marcel Dekker, Inc., 2001.
36. "Sylobead Desiccant Process Adsorbents for Ethanol Enrichment." Grace Davison BioFuel Technologies Group Products website. <http://www.grace.com/Products/Sylobead/Default.aspx>.
37. *UOP Ethanol Dehydration Solutions*. UOP 4979. Des Plaines, IL: UOP LLC, June 2008. <http://www.uop.com/wp-content/uploads/2011/02/UOP-Ethanol-Dehydration-Solutions-Brochure.pdf>.

38. Humbird, D.; Davis, R.; Tao, L.; Kinchin, C.; Hsu, D.; Aden, A.; Schoen, P.; Lukas, J.; Olthof, B.; Worley, M.; Sexton, D.; Dudgeon, D. *Process Design and Economics for Biochemical Conversion of Lignocellulosic Biomass to Ethanol: Dilute-Acid Pretreatment and Enzymatic Hydrolysis of Corn Stover*. Report No. TP-5100-47764. Golden, CO: National Renewable Energy Laboratory, 2011. <http://www.nrel.gov/docs/fy11osti/47764.pdf>.
39. GPSA. *Engineering Data Book*, FPS Version, 12th ed. Tulsa, OK: Gas Processors Suppliers Association, 2004.
40. Weast, R.C., ed. *CRC Handbook of Chemistry and Physics*, 62nd ed. Boca Raton, FL: CRC Press, 1981.
41. Keeney, D.; Muller, M. *Water Use by Ethanol Plants: Potential Challenges*. Minneapolis, MN: Institute for Agriculture and Trade Policy, October 2006. <http://www.iatp.org/iatp/publications.cfm?accountID=258&refID=89449>.
42. Wu, M.; Mintz, M.; Wang, M.; Arora, S. *Consumptive Water Use in the Production of Ethanol and Petroleum Gasoline*. Report No. ANL/ESD/09-1. Argonne, IL: Center for Transportation Research, Energy Systems Division, Argonne National Laboratory, January 2009. <http://www.transportation.anl.gov/pdfs/AF/557.pdf>.
43. Jeakel, D., price quote from AGSCO for super sacks or bulk, 2004.
44. Chemical Prices. *Chemical Market Reporter*. August 23–30 issues. ICIS, 2004.
45. “Annual Energy Outlook 2011.” Data Table A3 – Energy Prices by Sector and Source. Energy Information Administration (EIA) website, <http://www.eia.gov/forecasts/aeo/index.cfm>.
46. Chen, C.; Rubin, E.S. *CO₂ Control Technology Effects on IGCC Plant Performance and Cost*. Pittsburgh, PA: Carnegie Mellon University, 2004.
47. SRI Consulting. “U.S. Producer Price Indexes—Total Index for Chemicals and Allied Products.” *Chemical Economics Handbook: The Economic Environment of the Chemical Industry*. Menlo Park, CA: SRI Consulting, March 2011.
48. *Chemical Marketing Reporter*. Week of October 17–23, 2005.
49. “Annual Energy Outlook 2009.” Table 112 – Components of Selected Petroleum Product Prices. Energy Information Administration (EIA) website, March 2009, http://www.eia.doe.gov/oiaf/archive/aeo09/supplement/suptab_112.xls.

Appendix A. Equipment Description and Design Basis Summary

NREL's Process Engineering Team has compiled information on the equipment in the benchmark model. The compilation contains information about the cost, reference year, scaling factor, scaling characteristic, design information, and back-up cost referencing. The information is stored in the economic spreadsheet portion of the model.

The following table summarizes the important fields of information contained in the spreadsheet model. A partial listing of the information is attached for each piece of equipment. Additional information from the spreadsheet model is presented in Appendix B.

Equipment number: ^{a,b}	Unique identifier, the first letter indicates the equipment type and the first number represents the process area, e.g., P-601 is a pump in Area 600
Equipment name: ^{a,b}	Descriptive name of the piece of equipment
Associated PFD:	PFD number on which the piece of equipment appears, e.g., PFD-P820-A101
Equipment category: ^a	Code indicating the general type of equipment, e.g., PUMP
Equipment type: ^a	Code indicating the specific type of equipment, e.g., CENTRIFUGAL for a pump
Equipment description: ^a	Short description of the size or characteristics of the piece of equipment, e.g., 20 gpm, 82 ft head for a pump
Number required: ^b	Number of duplicate pieces of equipment needed
Number spares: ^b	Number of on-line spares
Scaling stream: ^b	Stream number or other characteristic variable from the Aspen Plus model by which the equipment cost is be scaled
Base cost: ^b	Equipment cost
Cost basis: ^a	Source of the equipment cost, e.g., Aspen Icarus 2006.5 or vendor quotation
Cost year: ^b	Year in which the cost estimate is based
Base for scaling: ^b	Value of the scaling stream or variable used to obtain the base cost of the equipment
Base type:	Type of variable used for scaling, e.g., FLOW, DUTY, etc.
Base units:	Units of the scaling stream or variable, e.g., LB/HR, MMBTU/HR
Installation factor: ^b	Value of the installation factor. Installed Cost = Base Cost x Installation Factor
Installation factor basis:	Source of the installation factor, e.g., Aspen Icarus 2006.5, vendor quotation
Scale factor exponent: ^b	Value of the exponential scaling equation
Scale factor basis:	Source of the scaling exponent value, e.g., vendor quotation
Material of construction: ^a	Material of construction
Notes:	Any other important information about the design or cost
Document:	Complete, multi-page document containing design calculations, vendor literature and quotations, and any other important information. This is stored as an electronic document and can be pages from a spreadsheet, other electronic sources, or scanned information from vendors.
Design date:	Original date for the design of this piece of equipment
Modified date:	The system automatically marks the date in this field whenever any field is changed

^a These fields are listed for all pieces of equipment in Appendix A.

^b These fields are part of the equipment cost listing in Appendix B.

EQUIPMENT_NUM	EQUIPMENT_NAME	EQUIPMENT_CATEGORY	EQUIPMENT_TYPE	EQUIPMENT_DESCRIPTION	MATERIAL_CONST	COST_BASIS
PFD-P820-A101 to A102						
C-101	Hopper Feeder	CONVEYOR	VIBRATING-FEEDER	Included in per unit cost of feestock per Idaho National Laboratory (INL)	CS	Idaho National Lab (INL)
C-102	Screener Feeder Conveyor	CONVEYOR	BELT	Included in per unit cost of feestock per Idaho National Laboratory (INL)	CS	Idaho National Lab (INL)
C-103	Radial Stacker Conveyor	CONVEYOR	BELT	Included in per unit cost of feestock per Idaho National Laboratory (INL)	CS	Idaho National Lab (INL)
C-104	Dryer Feed Screw Conveyor	CONVEYOR	SCREW	Included in per unit cost of feestock per Idaho National Laboratory (INL)	CS	Idaho National Lab (INL)
C-105	Gasifier Feed Screw Conveyor	CONVEYOR	SCREW	Included in per unit cost of feestock per Idaho National Laboratory (INL)	316SS	Idaho National Lab (INL)
K-101	Flue Gas Blower	FAN	CENTRIFUGAL	Included in per unit cost of feestock per Idaho National Laboratory (INL)	SS304	Idaho National Lab (INL)
K-102	CO2 Booster Blower	COMPRESSOR	CENTRIFUGAL	Included in per unit cost of feestock per Idaho National Laboratory (INL)	SS304	Idaho National Lab (INL)
M-101	Hydraulic Truck Dump with Scale	SCALE	TRUCK-SCALE	Included in per unit cost of feestock per Idaho National Laboratory (INL)		Idaho National Lab (INL)
M-103	Front End Loaders	VEHICLE	LOADER	Included in per unit cost of feestock per Idaho National Laboratory (INL)	CS	Idaho National Lab (INL)
M-104	Waste Heat Dryer	DRYER	ROTARY-DRUM	Included in per unit cost of feestock per Idaho National Laboratory (INL)	CS	Idaho National Lab (INL)
S-101	Magnetic Head Pulley	SEPARATOR	MAGNET	Included in per unit cost of feestock per Idaho National Laboratory (INL)	CS	Idaho National Lab (INL)
S-102	Vibratory Conveyor	SEPARATOR	SCREEN	Included in per unit cost of feestock per Idaho National Laboratory (INL)	CS	Idaho National Lab (INL)
T-101	Dump Hopper	TANK	LIVE-BTM-BIN	Included in per unit cost of feestock per Idaho National Laboratory (INL)	CS	Idaho National Lab (INL)
T-103	Dryer Feed Bin	TANK	LIVE-BTM-BIN	Included in per unit cost of feestock per Idaho National Laboratory (INL)	CS	Idaho National Lab (INL)
T-104	Dried Biomass Hopper	TANK	VERTICAL-VESSEL	Included in per unit cost of feestock per Idaho National Laboratory (INL)	CS	Idaho National Lab (INL)
T-105	Lock Hopper	TANK	VERTICAL-VESSEL	Included in per unit cost of feestock per Idaho National Laboratory (INL)	CS	Idaho National Lab (INL)
T-106	Feed Hopper	TANK	VERTICAL-VESSEL	Included in per unit cost of feestock per Idaho National Laboratory (INL)	CS	Idaho National Lab (INL)

EQUIPMENT_NUM	EQUIPMENT_NAME	EQUIPMENT_CATEGORY	EQUIPMENT_TYPE	EQUIPMENT_DESCRIPTION	MATERIAL_CONST	COST_BASIS
PFD-P820-A201 to A202						
C-201	Sand / Ash Conditioner / Conveyor	CONVEYOR	SCREW	Included in overall cost for gasification & gas clean up based on quotation from Taylor Biomass Energy. 2 / 3 cost assumed for gasification.	CS	Taylor Biomass Energy
H-201	Syngas Quench Inlet / Combustion Air Pre-Heat Exchanger *	HEATX	SHELL-TUBE	Duty (MMBtu / Hr) = 4.64; LMTD (°F) = 14.48; U (Btu / Hr-ft ² -°F)=25; A (ft ²) = 12829; Included in Taylor Biomass Energy Cost	A214 / A285C	Taylor Biomass Energy
H-202	Tar Reformer Effluent / Combustion Air Pre-Heat Exchanger *	HEATX	SHELL-TUBE	Duty (MMBtu / Hr) = 9.95; LMTD (°F) = 24.44; U (Btu / Hr-ft ² -°F)=20; A (ft ²) = 20350; Included in Taylor Biomass Energy Cost	304SS / A285C	Taylor Biomass Energy
K-202	Char Combustor Air Blower	COMPRESSOR	CENTRIFUGAL	Included in overall cost for gasification & gas clean up based on quotation from Taylor Biomass Energy. 2 / 3 cost assumed for gasification.	CS	Taylor Biomass Energy
M-201	Sand / Ash Cooler	MISCELLANEOUS	MISCELLANEOUS	Included in overall cost for gasification & gas clean up based on quotation from Taylor Biomass Energy. 2 / 3 cost assumed for gasification.	SS304	Taylor Biomass Energy
R-201	Indirectly-Heated Biomass Gasifier	REACTOR	VERTICAL-VESSEL	Included in overall cost for gasification & gas clean up based on quotation from Taylor Biomass Energy. 2 / 3 cost assumed for gasification.	CS w/refractory	Taylor Biomass Energy
R-202	Char Combustor	REACTOR	VERTICAL-VESSEL	Included in overall cost for gasification & gas clean up based on quotation from Taylor Biomass Energy. 2 / 3 cost assumed for gasification.	CS w/refractory	Taylor Biomass Energy
S-201	Primary Gasifier Cyclone	SEPARATOR	GAS CYCLONE	Included in overall cost for gasification & gas clean up based on quotation from Taylor Biomass Energy. 2 / 3 cost assumed for gasification.	CS w/refractory	Taylor Biomass Energy
S-202	Secondary Gasifier Cyclone	SEPARATOR	GAS CYCLONE	Included in overall cost for gasification & gas clean up based on quotation from Taylor Biomass Energy. 2 / 3 cost assumed for gasification.	CS w/refractory	Taylor Biomass Energy
S-203	Primary Combustor Cyclone	SEPARATOR	GAS CYCLONE	Included in overall cost for gasification & gas clean up based on quotation from Taylor Biomass Energy. 2 / 3 cost assumed for gasification.	CS w/refractory	Taylor Biomass Energy
S-204	Char Combustor Secondary Cyclone	SEPARATOR	GAS CYCLONE	Included in overall cost for gasification & gas clean up based on quotation from Taylor Biomass Energy. 2 / 3 cost assumed for gasification.	CS w/refractory	Taylor Biomass Energy
T-201	Sand / Ash Bin	TANK	FLAT-BTM-STORAGE	Included in overall cost for gasification & gas clean up based on quotation from Taylor Biomass Energy. 2 / 3 cost assumed for gasification.	CS	Taylor Biomass Energy

EQUIPMENT_NUM	EQUIPMENT_NAME	EQUIPMENT_CATEGORY	EQUIPMENT_TYPE	EQUIPMENT_DESCRIPTION	MATERIAL_CONST	COST_BASIS
PFD-P820-A301 to A306						
H-301	Quench Water Recirculation Cooler	HEATX	SHELL-TUBE	Included in overall cost for gasification & gas clean up based on quotation from Taylor Biomass Energy. 1 / 3 cost assumed for gas conditioning.	CS	Taylor Biomass Energy
H-302	Steam Blowdown / Unreacted Syngas Exchanger	HEATX	SHELL-TUBE	Duty (MMBtu / Hr) = 4.38; LMTD (°F) = 43; U (Btu / Hr-ft ² -°F)=30; A (ft ²) = 3395	A214 / A285C	Aspen Icarus 2006.5
H-303	Syngas Quench Inlet / Make-Up Water Exchanger	HEATX	SHELL-TUBE	Duty (MMBtu / Hr) = 7.22; LMTD (°F) = 15.11; U (Btu / Hr-ft ² -°F)=30; A (ft ²) = 15919	A214 / A285C	Aspen Icarus 2006.5
H-304	Syngas Quench Inlet / Mol-Sieve Pre-Heat Exchanger	HEATX	SHELL-TUBE	Duty (MMBtu / Hr) = 5.66; LMTD (°F) = 92.05; U (Btu / Hr-ft ² -°F)=25; A (ft ²) = 2461	A214 / A285C	Aspen Icarus 2006.5
H-305	Alcohol Synthesis Effluent / Combustion Air Pre-Heat Exchanger	HEATX	SHELL-TUBE	Duty (MMBtu / Hr) = 1.58; LMTD (°F) = 44.04; U (Btu / Hr-ft ² -°F)=40; A (ft ²) = 894	A214 / A285C	Aspen Icarus 2006.5
H-306	Syngas Quench Inlet / Combustion Air Pre-Heat Exchanger	HEATX	SHELL-TUBE	Duty (MMBtu / Hr) = 2.64; LMTD (°F) = 44.04; U (Btu / Hr-ft ² -°F)=40; A (ft ²) = 1497	A214 / A285C	Aspen Icarus 2006.5
H-307	Syngas Quench Inlet / Combustion Air Pre-Heat Exchanger	HEATX	SHELL-TUBE	Duty (MMBtu / Hr) = 5.91; LMTD (°F) = 43.18; U (Btu / Hr-ft ² -°F)=40; A (ft ²) = 3422	A214 / A285C	Aspen Icarus 2006.5
H-308	Tar Reformer Effluent / Combustion Air Pre-Heat Exchanger	HEATX	SHELL-TUBE	Duty (MMBtu / Hr) = 5.33; LMTD (°F) = 24.44; U (Btu / Hr-ft ² -°F)=20; A (ft ²) = 10910	304SS / A285C	Aspen Icarus 2006.5
H-309	Tar Reformer Effluent / Combustion Air Pre-Heat Exchanger	HEATX	SHELL-TUBE	Duty (MMBtu / Hr) = 12.75; LMTD (°F) = 322.72; U (Btu / Hr-ft ² -°F)=20; A (ft ²) = 1975	304SS / 304SS	Aspen Icarus 2006.5
H-310	Catalyst Regenerator Flue Gas / Tar Reformer Steam & Recycle Exchanger	HEATX	SHELL-TUBE	Duty (MMBtu / Hr) = 69.86; LMTD (°F) = 244.39; U (Btu / Hr-ft ² -°F)=20; A (ft ²) = 14293	304SS / 304SS	Aspen Icarus 2006.5
H-311	Tar Reformer Effluent / Unreacted Syngas Exchanger	HEATX	SHELL-TUBE	Duty (MMBtu / Hr) = 9.08; LMTD (°F) = 397.35; U (Btu / Hr-ft ² -°F)=20; A (ft ²) = 1142	304SS / 304SS	Aspen Icarus 2006.5
K-305	Combustion Air Blower	COMPRESSOR	CENTRIFUGAL	Volumetric Inlet Flow Rate = 66,000 CFM; Design Inlet Pressure = 0 PSIG; Design Outlet Pressure = 5 PSIG; Work = 1926 hp	CS	Aspen Icarus 2006.5
M-300	Combustor Fuel Pre-Mix	MISCELLANEOUS	MISCELLANEOUS	Piping included in installation factor	CS	
M-300H	Tar Reformer Inlet Mix	MISCELLANEOUS	MISCELLANEOUS	Piping included in installation factor	CS	
M-301	Syngas Cyclone Separator	MISCELLANEOUS	VERTICAL-VESSEL	Included in overall cost for gasification & gas clean up based on quotation from Taylor Biomass Energy. 1 / 3 cost assumed for gas conditioning.	SS304	Taylor Biomass Energy
M-302	Syngas Venturi Scrubber	MISCELLANEOUS	VERTICAL-VESSEL	Included in overall cost for gasification & gas clean up based on quotation from Taylor Biomass Energy. 1 / 3 cost assumed for gas conditioning.	SS304	Taylor Biomass Energy
P-302	Quench Water Recirculation Pump	PUMP	CENTRIFUGAL	Flow = 1,010 GPM; Fluid Head = 60 Ft; Design Pressure = 30 PSIG	CS	Aspen Icarus 2006.5
R-301A	Tar Reformer Catalyst Regenerator	REACTOR	VERTICAL-VESSEL	Included in overall cost for gasification & gas clean up based on quotation from Taylor Biomass Energy. 1 / 3 cost assumed for gas conditioning.	CS w/refractory	Taylor Biomass Energy
R-303	Tar Reformer	REACTOR	VERTICAL-VESSEL	Included in overall cost for gasification & gas clean up based on quotation from Taylor Biomass Energy. 1 / 3 cost assumed for gas conditioning.	CS w/refractory	Taylor Biomass Energy
S-306	Tar Reformer 2-Stage Cyclone	SEPARATOR	GAS CYCLONE	Included in overall cost for gasification & gas clean up based on quotation from Taylor Biomass Energy. 1 / 3 cost assumed for gas conditioning.	CS w/refractory	Taylor Biomass Energy
S-307	Catalyst Regenerator 2-Stage Cyclone	SEPARATOR	GAS CYCLONE	Included in overall cost for gasification & gas clean up based on quotation from Taylor Biomass Energy. 1 / 3 cost assumed for gas conditioning.	CS w/refractory	Taylor Biomass Energy

EQUIPMENT_NUM	EQUIPMENT_NAME	EQUIPMENT_CATEGORY	EQUIPMENT_TYPE	EQUIPMENT_DESCRIPTION	MATERIAL_CONST	COST_BASIS
PFD-P820-A401 to A408						
H-401	Alcohol Synthesis Feed / Effluent Exchanger	HEATX	SHELL-TUBE	Duty (MMBtu / Hr) = 127.7; LMTD (°F) = 30.82; U (Btu / Hr-ft ² -°F)=90; A (ft ²) = 46034	A214 / A285C	Aspen Icarus 2006.5
H-402	Alcohol Synthesis Feed / Effluent Exchanger	HEATX	SHELL-TUBE	Duty (MMBtu / Hr) = 73.55; LMTD (°F) = 16.57; U (Btu / Hr-ft ² -°F)=90; A (ft ²) = 49332	A214 / A285C	Aspen Icarus 2006.5
H-403	Compressor Interstage / Deaerator Feed Exchanger	HEATX	SHELL-TUBE	Duty (MMBtu / Hr) = 25.04; LMTD (°F) = 25.9; U (Btu / Hr-ft ² -°F)=35; A (ft ²) = 27629	A214 / A285C	Aspen Icarus 2006.5
H-404	Compressor Interstage / Deaerator Feed Exchanger	HEATX	SHELL-TUBE	Duty (MMBtu / Hr) = 15.3; LMTD (°F) = 13.88; U (Btu / Hr-ft ² -°F)=50; A (ft ²) = 22037	A214 / A285C	Aspen Icarus 2006.5
H-405	Compressor Interstage / Deaerator Feed Exchanger	HEATX	SHELL-TUBE	Duty (MMBtu / Hr) = 15.53; LMTD (°F) = 13.4; U (Btu / Hr-ft ² -°F)=100; A (ft ²) = 11595	A214 / A285C	Aspen Icarus 2006.5
H-406	Compressor Interstage / Mol-Sieve Pre-Heat Exchanger	HEATX	SHELL-TUBE	Duty (MMBtu / Hr) = 15.96; LMTD (°F) = 42.34; U (Btu / Hr-ft ² -°F)=30; A (ft ²) = 12567	A214 / A285C	Aspen Icarus 2006.5
H-407	Compressor Interstage / Mol-Sieve Pre-Heat Exchanger	HEATX	SHELL-TUBE	Duty (MMBtu / Hr) = 11.1; LMTD (°F) = 42.34; U (Btu / Hr-ft ² -°F)=50; A (ft ²) = 5244	A214 / A285C	Aspen Icarus 2006.5
H-408	Compressor Interstage / Mol-Sieve Pre-Heat Exchanger	HEATX	SHELL-TUBE	Duty (MMBtu / Hr) = 11.39; LMTD (°F) = 42.34; U (Btu / Hr-ft ² -°F)=70; A (ft ²) = 3844	A214 / A285C	Aspen Icarus 2006.5
H-409	Alcohol Synthesis Effluent / LO-CAT Pre-Heat Exchanger	HEATX	SHELL-TUBE	Duty (MMBtu / Hr) = 0.05; LMTD (°F) = 70.58; U (Btu / Hr-ft ² -°F)=50; A (ft ²) = 14	A214 / A285C	Aspen Icarus 2006.5
H-410A	1st Stage Air Intercooler	HEATX	AIR-COOLED EXCHANGER	Duty = 37.4 MMBtu/Hr; Bare Tube Surface Area = 11,509 Ft ² ; Design Pressure = 40 PSIG; Overdesign for reduced pressure drop.	SA179	GEA Rainey Corp / Aspen Icarus 2006.5
H-410B	2nd Stage Air Intercooler	HEATX	AIR-COOLED EXCHANGER	Duty = 36.0 MMBtu/Hr; Bare Tube Surface Area = 8,613 Ft ² ; Design Pressure = 150 PSIG; Overdesign for reduced pressure drop.	SA179	GEA Rainey Corp / Aspen Icarus 2006.5
H-410C	3rd Stage Air Intercooler	HEATX	AIR-COOLED EXCHANGER	Duty = 32.6 MMBtu/Hr; Bare Tube Surface Area = 6,891 Ft ² ; Design Pressure = 500 PSIG; Overdesign for reduced pressure drop.	SA179	GEA Rainey Corp / Aspen Icarus 2006.5
H-410D	4th Stage Air Intercooler	HEATX	AIR-COOLED EXCHANGER	Duty = 38.6 MMBtu/Hr; Bare Tube Surface Area = 6,891 Ft ² ; Design Pressure = 1,500 PSIG; Overdesign for reduced pressure drop.	SA179	GEA Rainey Corp / Aspen Icarus 2006.5
H-410E	5th Stage Air Intercooler	HEATX	AIR-COOLED EXCHANGER	Duty = 36.0 MMBtu/Hr; Bare Tube Surface Area = 5,507 Ft ² ; Design Pressure = 3,300 PSIG; Overdesign for reduced pressure drop.	SA179	GEA Rainey Corp / Aspen Icarus 2006.5
H-411A	1st Stage Water Intercooler	HEATX	SHELL-TUBE	Duty = 11.1 MMBtu/Hr; LMTD = 20.0 F; U = 40 Btu/hr-ft ² -F; Surface Area = 13,875 Ft ² ; Fixed TS; Design Pressure = 40 PSIG	CS	Aspen Icarus 2006.5
H-411B	2nd Stage Water Intercooler	HEATX	SHELL-TUBE	Duty = 6.4 MMBtu/Hr; LMTD = 20.0 F; U = 55 Btu/hr-ft ² -F; Surface Area = 5,818 Ft ² ; Fixed TS; Design Pressure = 150 PSIG	CS	Aspen Icarus 2006.5
H-411C	3rd Stage Water Intercooler	HEATX	SHELL-TUBE	Duty = 4.4 MMBtu/Hr; LMTD = 20.0 F; U = 70 Btu/hr-ft ² -F; Surface Area = 3,143 Ft ² ; Fixed TS; Design Pressure = 500 PSIG	CS	Aspen Icarus 2006.5
H-411D	4th Stage Water Intercooler	HEATX	SHELL-TUBE	Duty = 3.3 MMBtu/Hr; LMTD = 20.0 F; U = 85 Btu/hr-ft ² -F; Surface Area = 1,941 Ft ² ; Fixed TS; Design Pressure = 1,500 PSIG	CS	Aspen Icarus 2006.5
H-411E	5th Stage Water Intercooler	HEATX	SHELL-TUBE	Duty = 3.3 MMBtu/Hr; LMTD = 20.0 F; U = 95 Btu/hr-ft ² -F; Surface Area = 1,650 Ft ² ; Fixed TS; Design Pressure = 3,300 PSIG	CS	Aspen Icarus 2006.5
H-413	Syngas Air Cooler	HEATX	AIR-COOLED EXCHANGER	Duty = 33.8 MMBtu/Hr; Bare Tube Surface Area = 11,438 Ft ² ; Design Pressure = 3,300 PSIG	SA179	Aspen Icarus 2006.5
H-414	Syngas Cooling Water Exchanger	HEATX	SHELL-TUBE	Duty = 15.6 MMBtu/Hr; LMTD = 24.7 F; U = 95 Btu/hr-ft ² -F; Surface Area = 6,658 Ft ² ; Fixed TS; Design Pressure = 3,300 PSIG	CS	Aspen Icarus 2006.5
H-415	Alcohol Synthesis Effluent / Syngas Recycle Exchanger	HEATX	SHELL-TUBE	Duty (MMBtu / Hr) = 19.56; LMTD (°F) = 36.34; U (Btu / Hr-ft ² -°F)=90; A (ft ²) = 5980	A214 / A285C	Aspen Icarus 2006.5
H-416	Alcohol Synthesis Effluent / CO2-Rich Gas Exchanger	HEATX	SHELL-TUBE	Duty (MMBtu / Hr) = 1.01; LMTD (°F) = 58.47; U (Btu / Hr-ft ² -°F)=80; A (ft ²) = 215	A214 / A285C	Aspen Icarus 2006.5
H-417	Alcohol Synthesis Effluent / Mol-Sieve Pre-Heat Exchanger	HEATX	SHELL-TUBE	Duty (MMBtu / Hr) = 5.35; LMTD (°F) = 59.33; U (Btu / Hr-ft ² -°F)=25; A (ft ²) = 3608	A214 / A285C	Aspen Icarus 2006.5
H-418	Alcohol Synthesis Effluent / Expander Inlet Exchanger	HEATX	SHELL-TUBE	Duty (MMBtu / Hr) = 9.71; LMTD (°F) = 62.15; U (Btu / Hr-ft ² -°F)=80; A (ft ²) = 1953	A214 / A285C	Aspen Icarus 2006.5
H-419	Tar Reformer Effluent / Expander Inlet Exchanger	HEATX	SHELL-TUBE	Duty (MMBtu / Hr) = 3.81; LMTD (°F) = 24.44; U (Btu / Hr-ft ² -°F)=30; A (ft ²) = 5202	304SS / 304SS	Aspen Icarus 2006.5
H-420	Tar Reformer Effluent / Expander Inlet Exchanger	HEATX	SHELL-TUBE	Duty (MMBtu / Hr) = 25.07; LMTD (°F) = 583.69; U (Btu / Hr-ft ² -°F)=30; A (ft ²) = 1432	304SS / 304SS	Aspen Icarus 2006.5
H-421	Alcohol Synthesis Effluent / Expander Inlet Exchanger	HEATX	SHELL-TUBE	Duty (MMBtu / Hr) = 4.31; LMTD (°F) = 78.57; U (Btu / Hr-ft ² -°F)=70; A (ft ²) = 783	A214 / A285C	Aspen Icarus 2006.5
H-422	Tar Reformer Effluent / Expander Inlet Exchanger	HEATX	SHELL-TUBE	Duty (MMBtu / Hr) = 10.97; LMTD (°F) = 630.9; U (Btu / Hr-ft ² -°F)=25; A (ft ²) = 695	304SS / 304SS	Aspen Icarus 2006.5
H-423	Tar Reformer Effluent / Expander Inlet Exchanger	HEATX	SHELL-TUBE	Duty (MMBtu / Hr) = 16.3; LMTD (°F) = 459.7; U (Btu / Hr-ft ² -°F)=25; A (ft ²) = 1418	304SS / 304SS	Aspen Icarus 2006.5
H-424	Alcohol Synthesis Effluent / CO2-Rich Gas Exchanger	HEATX	SHELL-TUBE	Duty (MMBtu / Hr) = 2.37; LMTD (°F) = 44.27; U (Btu / Hr-ft ² -°F)=45; A (ft ²) = 1192	A214 / A285C	Aspen Icarus 2006.5
H-425	Char Combustor Flue Gas / CO2-Rich Gas Exchanger	HEATX	SHELL-TUBE	Duty (MMBtu / Hr) = 4.52; LMTD (°F) = 550.38; U (Btu / Hr-ft ² -°F)=20; A (ft ²) = 410	304SS / 304SS	Aspen Icarus 2006.5
H-426	Tar Reformer Effluent / CO2-Rich Gas Exchanger	HEATX	SHELL-TUBE	Duty (MMBtu / Hr) = 10.14; LMTD (°F) = 524.35; U (Btu / Hr-ft ² -°F)=20; A (ft ²) = 967	304SS / 304SS	Aspen Icarus 2006.5
H-427	Catalyst Regenerator Flue Gas / Alcohol Synthesis Feed Exchanger	HEATX	SHELL-TUBE	Duty (MMBtu / Hr) = 20.42; LMTD (°F) = 364.97; U (Btu / Hr-ft ² -°F)=40; A (ft ²) = 1399	304SS / 304SS	Aspen Icarus 2006.5
K-410	Synthesis Gas Compressor	COMPRESSOR	CENTRIFUGAL	Quotation from Elliott includes multi-stage centrifugal compressor system, motors and variable frequency drives (VFDs)		Elliott Ebara Group
K-414	Unconverted Syngas Recycle Compressor	COMPRESSOR	CENTRIFUGAL	Cost for recycle compressor service included in quotation from Elliott		Elliott Ebara Group
K-412A	Purge Gas Expander Stage 1	COMPRESSOR	CENTRIFUGAL	Inlet Flow Rate = 795 CFM; Power Recovered = 10,058 HP	A285C	NETL / Aspen Icarus 2006.5
K-412B	Purge Gas Expander Stage 2	COMPRESSOR	CENTRIFUGAL	Inlet Flow Rate = 4,959 CFM; Power Recovered = 12,257 HP	A285C	NETL / Aspen Icarus 2006.5
M-401	DEPG Acid Gas Removal System	MISCELLANEOUS	PACKAGE UNIT	Detailed cost estimate for system is provided in Appendices		Literature
M-402	Ammonia Absorption Refrigeration System	MISCELLANEOUS	PACKAGE UNIT	Equipment sizing and cost estimate based on refrigeration demands of DEPG and Methanol / H2S systems		Colibri B.V.

EQUIPMENT_NUM	EQUIPMENT_NAME	EQUIPMENT_CATEGORY	EQUIPMENT_TYPE	EQUIPMENT_DESCRIPTION	MATERIAL_CONST	COST_BASIS
M-403	Amine Acid Gas Enrichment System	MISCELLANEOUS	PACKAGE UNIT	Detailed cost estimate for system is provided in Appendices		Aspen Icarus 2006.5
M-404	Methanol / H2S Absorption System	MISCELLANEOUS	PACKAGE UNIT	Detailed cost estimate for system is provided in Appendices		Aspen Icarus 2006.5
M-405	LO-CAT Sulfur Recovery System	MISCELLANEOUS	PACKAGE UNIT	Estimated cost was interpolated from other projects based on sulfur recovery rate and H2S concentration in atmospheric vent.		Adapted from Merichem Co quote for another project
R-410	Alcohol Synthesis Reactor	REACTOR	TUBULAR REACTOR	Tubular Reactor. Design Pressure = 3,300 PSIG; Tubes / Shell = 4500; Tube ID = 1.5 in; Tube Length = 60 ft	SA213 T22	Hooper Engineered Vessels / Aspen Icarus
S-410A	1st Interstage KO Drum	SEPARATOR	KNOCK-OUT DRUM	Vertical Drum; 225% of Critical Velocity; Diameter = 12 Ft; T-T Height = 24 Ft; Design Pressure = 40 PSIG	CS	Aspen Icarus 2006.5
S-410B	2nd Interstage KO Drum	SEPARATOR	KNOCK-OUT DRUM	Vertical Drum; 225% of Critical Velocity; Diameter = 9 Ft; T-T Height = 18 Ft; Design Pressure = 150 PSIG	CS	Aspen Icarus 2006.5
S-410C	3rd Interstage KO Drum	SEPARATOR	KNOCK-OUT DRUM	Vertical Drum; 225% of Critical Velocity; Diameter = 6 Ft; T-T Height = 15 Ft; Design Pressure = 500 PSIG	CS	Aspen Icarus 2006.5
S-410D	4th Interstage KO Drum	SEPARATOR	KNOCK-OUT DRUM	Vertical Drum; 225% of Critical Velocity; Diameter = 5 Ft; T-T Height = 12 Ft; Design Pressure = 1,500 PSIG	CS	Aspen Icarus 2006.5
S-410E	5th Interstage KO Drum	SEPARATOR	KNOCK-OUT DRUM	Vertical Drum; 225% of Critical Velocity; Diameter = 4 Ft; T-T Height = 12 Ft; Design Pressure = 3,300 PSIG	CS	Aspen Icarus 2006.5
S-415	Pre-Compressor KO Drum	SEPARATOR	KNOCK-OUT DRUM	Vertical Drum; 225% of Critical Velocity; Diameter = 16 Ft; T-T Height = 32 Ft; Design Pressure = 10 PSIG	CS	Aspen Icarus 2006.5

EQUIPMENT_NUM	EQUIPMENT_NAME	EQUIPMENT_CATEGORY	EQUIPMENT_TYPE	EQUIPMENT_DESCRIPTION	MATERIAL_CONST	COST_BASIS
PFD-P820-A501 to A503						
D-504	Crude Alcohol Distillation Column	COLUMN	DISTILLATION	60 Theoretical Stages at 60% Efficiency = 100 Trays; 24 in Tray Spacing; Diameter = 9 ft; T-T Height = 230 ft; Design Pressure = 50 PSIG	SS304	Aspen Icarus 2006.5
D-505	Methanol Column	COLUMN	DISTILLATION	81 Theoretical Stages at 60% Efficiency = 135 Trays; 24 in Tray Spacing; Diameter = 12 ft; T-T Height = 300 ft; Design Pressure = 50 PSIG	SS304	Aspen Icarus 2006.5
H-501	Ethanol Product / Mol-Sieve Pre-Heat Exchanger	HEATX	SHELL-TUBE	Duty (MMBtu / Hr) = 4.81; LMTD (°F) = 30.18; U (Btu / Hr-ft ² -°F)=90; A (ft ²) = 1770	A214 / A285C	Aspen Icarus 2006.5
H-502	Higher Alcohols Product / Mol-Sieve Pre-Heat Exchanger	HEATX	SHELL-TUBE	Duty (MMBtu / Hr) = 0.76; LMTD (°F) = 51.77; U (Btu / Hr-ft ² -°F)=90; A (ft ²) = 164	A214 / A285C	Aspen Icarus 2006.5
H-503	Syngas Quench Inlet / Water-Methanol Recycle Exchanger	HEATX	SHELL-TUBE	Duty (MMBtu / Hr) = 12.14; LMTD (°F) = 17.64; U (Btu / Hr-ft ² -°F)=30; A (ft ²) = 22949	A214 / A285C	Aspen Icarus 2006.5
H-504C	Crude Alcohol Column Condenser	HEATX	AIR-COOLED EXCHANGER	Duty = 36.0 MMBtu/Hr; Bare Tube Surface Area = 8,406 Ft ² ; Design Pressure = 50 PSIG	SS304	Aspen Icarus 2006.5
H-504R	Crude Alcohol Column Reboiler	HEATX	SHELL-TUBE	Duty = 33.4 MMBtu/Hr; LMTD = 30 F; U = 150 Btu/hr-ft ² -F; Surface Area = 7,480 Ft ² ; U-Tube Kettle Reboiler; Design Pressure = 50 PSIG	SS304	Aspen Icarus 2006.5
H-505C	Methanol Column Condenser	HEATX	AIR-COOLED EXCHANGER	Duty = 100.3 MMBtu/Hr; Bare Tube Surface Area = 23,460 Ft ² ; Design Pressure = 50 PSIG	SS304	Aspen Icarus 2006.5
H-505R	Methanol Column Reboiler	HEATX	SHELL-TUBE	Duty = 84.1 MMBtu/Hr; LMTD = 30 F; U = 150 Btu/hr-ft ² -F; Surface Area = 18,860 Ft ² ; U-Tube Kettle Reboiler; Design Pressure = 50 PSIG	SS304	Aspen Icarus 2006.5
H-506	Syngas Quench Inlet / Mol-Sieve Pre-Heat Exchanger	HEATX	SHELL-TUBE	Duty (MMBtu / Hr) = 10.42; LMTD (°F) = 47.31; U (Btu / Hr-ft ² -°F)=25; A (ft ²) = 8809	A214 / A285C	Aspen Icarus 2006.5
H-507	Alcohol Synthesis Effluent / Mol-Sieve Pre-Heat Exchanger	HEATX	SHELL-TUBE	Duty (MMBtu / Hr) = 1.03; LMTD (°F) = 40.7; U (Btu / Hr-ft ² -°F)=50; A (ft ²) = 505	A214 / A285C	Aspen Icarus 2006.5
H-508	Alcohol Synthesis Effluent / Mol-Sieve Pre-Heat Exchanger	HEATX	SHELL-TUBE	Duty (MMBtu / Hr) = 0.88; LMTD (°F) = 64.96; U (Btu / Hr-ft ² -°F)=40; A (ft ²) = 340	A214 / A285C	Aspen Icarus 2006.5
H-509	Catalyst Regenerator Flue Gas / Water-Methanol Recycle Exchanger	HEATX	SHELL-TUBE	Duty (MMBtu / Hr) = 0.48; LMTD (°F) = 509.13; U (Btu / Hr-ft ² -°F)=20; A (ft ²) = 47	304SS / 304SS	Aspen Icarus 2006.5
H-510	Tar Reformer Effluent / Water-Methanol Recycle Exchanger	HEATX	SHELL-TUBE	Duty (MMBtu / Hr) = 1.52; LMTD (°F) = 364.71; U (Btu / Hr-ft ² -°F)=20; A (ft ²) = 208	304SS / 304SS	Aspen Icarus 2006.5
H-513	Molecular Sieve Flush Cooler	HEATX	AIR-COOLED EXCHANGER	Duty = 36.0 MMBtu/Hr; Bare Tube Surface Area = 8,406 Ft ² ; Design Pressure = 50 PSIG	SS304	Included in Cost for Molecular Sieve
H-514	Methanol Condenser	HEATX	AIR-COOLED EXCHANGER	Duty = 36.0 MMBtu/Hr; Bare Tube Surface Area = 8,406 Ft ² ; Design Pressure = 50 PSIG	SS304	Aspen Icarus 2006.5
H-591	Higher Alcohols Product Finishing Cooler	HEATX	SHELL-TUBE	Duty = 0.1 MMBtu/Hr; LMTD = 15 F; U = 100 Btu/hr-ft ² -F; Surface Area = 30 Ft ² ; U-Tube; Design Pressure = 50 PSIG	CS	Aspen Icarus 2006.5
H-593	Ethanol Product Finishing Cooler	HEATX	SHELL-TUBE	Duty = 0.4 MMBtu/Hr; LMTD = 15 F; U = 100 Btu/hr-ft ² -F; Surface Area = 265 Ft ² ; U-Tube; Design Pressure = 50 PSIG	CS	Aspen Icarus 2006.5
P-504	Crude Alcohol Column Reflux Pump	PUMP	CENTRIFUGAL	Flow Rate = 200 gpm; Liquid Head = 50 ft	CS	Aspen Icarus 2006.5
P-505	Methanol Column Reflux Pump	PUMP	CENTRIFUGAL	Flow Rate = 550 gpm; Liquid Head = 50 ft	CS	Aspen Icarus 2006.5
P-514	Condensed Methanol Pump	PUMP	CENTRIFUGAL	Flow = 120 GPM; Fluid Head = 9,200 Ft; Design Pressure = 4,000 PSIG	CS	Aspen Icarus 2006.5
P-590	Crude Alcohol Column Bottoms Pump	PUMP	CENTRIFUGAL	Flow Rate = 300 gpm; Liquid Head = 70 ft	CS	Aspen Icarus 2006.5
P-592	Methanol Column Bottoms Pump	PUMP	CENTRIFUGAL	Flow Rate = 900 gpm; Liquid Head = 70 ft	CS	Aspen Icarus 2006.5
S-501	Mixed Alcohols Condensation Knock-out	SEPARATOR	KNOCK-OUT DRUM	Horizontal Drum; Diameter = 5 ft; T-T Length = 10 ft; Design Pressure = 3,300 PSIG	A515	Aspen Icarus 2006.5
S-502	Mol Sieve Pre-Flash Drum	SEPARATOR	KNOCK-OUT DRUM	Vertical Drum; 100% of Critical Velocity; Diameter = 10 ft; T-T Length = 30 ft; Design Pressure = 35 PSIG	A515	Aspen Icarus 2006.5
S-503	Molecular Sieve Separator System	MISCELLANEOUS	PACKAGE UNIT	Superheater, twin mole sieve columns, product cooler, condenser, pumps, vacuum source.	SS304	Adapted from Delta-T Corp quote for another project
S-514	Condensed Methanol Flash Drum	SEPARATOR	VERTICAL-VESSEL	Vertical Drum; 100% of Critical Velocity; Diameter = 2 Ft; T-T Height = 10 Ft; Design Pressure = 50 PSIG	SS304	Aspen Icarus 2006.5
T-504	Crude Alcohol Column Overhead Accumulator	SEPARATOR	HORIZONTAL-VESSEL	Reflux Flow = 200 gpm; 10 Minute Liquid Inventory; 2,000 Gallon Liquid Inventory; Vapor Space Factor = 3; 6,000 Gallon Total Vessel Volume	CS	Aspen Icarus 2006.5
T-505	Methanol Column Overhead Accumulator	SEPARATOR	HORIZONTAL-VESSEL	Reflux Flow = 550 gpm; 10 Minute Liquid Inventory; 5,500 Gallon Liquid Inventory; Vapor Space Factor = 3; 16,500 Gallon Total Vessel Volume	CS	Aspen Icarus 2006.5

EQUIPMENT_NUM	EQUIPMENT_NAME	EQUIPMENT_CATEGORY	EQUIPMENT_TYPE	EQUIPMENT_DESCRIPTION	MATERIAL_CONST	COST_BASIS
PFD-P820-A601 to A604						
H-601	Steam Turbine Condenser	HEATX	AIR-COOLED EXCHANGER	Modular units with cost of \$1.3 MM per unit. Cooling capacity of 58.25 MMBtu / Hr per module.		SPX Cooling Technologies, Inc.
H-602	Steam Turbine Exhaust / Syngas Recycle Exchanger	HEATX	SHELL-TUBE	Duty (MMBtu / Hr) = 3.92; LMTD (°F) = 49.3; U (Btu / Hr-ft ² -°F)=40; A (ft ²) = 1986	A214 / A285C	Aspen Icarus 2006.5
H-603	Blowdown Cooler	HEATX	SHELL-TUBE	Duty = 0.4 MMBtu/Hr; LMTD = 15 F; U = 100 Btu/hr-ft ² -F; Surface Area = 265 Ft ² ; U-Tube; Design Pressure = 50 PSIG	CS	Aspen Icarus 2006.5
H-604	Steam Turbine Exhaust / Mol-Sieve Pre-Heat Exchanger	HEATX	SHELL-TUBE	Duty (MMBtu / Hr) = 4.38; LMTD (°F) = 70.77; U (Btu / Hr-ft ² -°F)=35; A (ft ²) = 1767	A214 / A285C	Aspen Icarus 2006.5
H-605	Syngas Quench Inlet / Make-Up Water Exchanger	HEATX	SHELL-TUBE	Duty (MMBtu / Hr) = 6.5; LMTD (°F) = 138.95; U (Btu / Hr-ft ² -°F)=30; A (ft ²) = 1559	A214 / A285C	Aspen Icarus 2006.5
H-606	Syngas Quench Inlet / BFW Pre-Heat Exchanger	HEATX	SHELL-TUBE	Duty (MMBtu / Hr) = 6.5; LMTD (°F) = 23.48; U (Btu / Hr-ft ² -°F)=30; A (ft ²) = 9232	A214 / A285C	Aspen Icarus 2006.5
H-607	Alcohol Synthesis Effluent / BFW Pre-Heat Exchanger	HEATX	SHELL-TUBE	Duty (MMBtu / Hr) = 9.98; LMTD (°F) = 23.48; U (Btu / Hr-ft ² -°F)=30; A (ft ²) = 14178	A214 / A285C	Aspen Icarus 2006.5
H-608	Tar Reformer Effluent / BFW Pre-Heat Exchanger	HEATX	SHELL-TUBE	Duty (MMBtu / Hr) = 63.73; LMTD (°F) = 139.77; U (Btu / Hr-ft ² -°F)=30; A (ft ²) = 15198	304SS / 304SS	Aspen Icarus 2006.5
H-609	Catalyst Regenerator Flue Gas / BFW Pre-Heat Exchanger	HEATX	SHELL-TUBE	Duty (MMBtu / Hr) = 26.06; LMTD (°F) = 203.99; U (Btu / Hr-ft ² -°F)=30; A (ft ²) = 4259	304SS / 304SS	Aspen Icarus 2006.5
H-610	Char Combustor Flue Gas / BFW Pre-Heat Exchanger	HEATX	SHELL-TUBE	Duty (MMBtu / Hr) = 38.11; LMTD (°F) = 195.12; U (Btu / Hr-ft ² -°F)=30; A (ft ²) = 6511	304SS / 304SS	Aspen Icarus 2006.5
H-611	Catalyst Regenerator Flue Gas Steam Generator	HEATX	SHELL-TUBE	Duty (MMBtu / Hr) = 17.67; LMTD (°F) = 353.55; U (Btu / Hr-ft ² -°F)=30; A (ft ²) = 1666	304SS / 304SS	Aspen Icarus 2006.5
H-612	Char Combustor Flue Gas Steam Superheater	HEATX	SHELL-TUBE	Duty (MMBtu / Hr) = 147.91; LMTD (°F) = 441.64; U (Btu / Hr-ft ² -°F)=30; A (ft ²) = 11163	304SS / 304SS	Aspen Icarus 2006.5
H-613	Tar Reformer Effluent Steam Superheater	HEATX	SHELL-TUBE	Duty (MMBtu / Hr) = 74.62; LMTD (°F) = 362.62; U (Btu / Hr-ft ² -°F)=25; A (ft ²) = 8231	304SS / 304SS	Aspen Icarus 2006.5
M-601A	BFW Reverse Osmosis (RO) Unit	MISCELLANEOUS	PACKAGE UNIT	600 gpm package unit. Includes RO units, electrodeionization system, CIP skid, brine recovery and condensate polishing systems.		Siemens
M-601B	BFW Electrodeionization (EDI) Unit	MISCELLANEOUS	PACKAGE UNIT	600 gpm package unit. Includes RO units, electrodeionization system, CIP skid, brine recovery and condensate polishing systems.		Siemens
M-601C	Hot Condensate Polishing Unit	MISCELLANEOUS	PACKAGE UNIT	600 gpm package unit. Includes RO units, electrodeionization system, CIP skid, brine recovery and condensate polishing systems.		Siemens
M-602A	Extraction Steam Turbine / Generator Stage 1	GENERATOR	STEAM-TURBINE	Estimate based on vendor quotation for 30.14 MW system.		Shin Nippon Machinery Co, LTD
M-602B	Extraction Steam Turbine / Generator Stage 2	GENERATOR	STEAM-TURBINE	Estimate based on vendor quotation for 30.14 MW system. Includes associated equipment with exception of steam turbine condenser.		Shin Nippon Machinery Co, LTD
M-603	Startup Boiler	MISCELLANEOUS	PACKAGE UNIT	Assume steam requirement equal to 1/2 of steam requirement for gasifier at full rate steam rate = 36,560 lb/hr	CS	QUESTIMATE
M-604	Brine Recovery Reverse Osmosis (RO) Unit	MISCELLANEOUS	PACKAGE UNIT	600 gpm package unit. Includes RO units, electrodeionization system, CIP skid, brine recovery and condensate polishing systems.		Siemens
P-601	Make-Up Pump	PUMP	CENTRIFUGAL	Flow Rate = 160 gpm; Liquid Head = 35 ft	CS	Aspen Icarus 2006.5
P-602	Condensate Pump	PUMP	CENTRIFUGAL	Flow Rate = 500 gpm; Liquid Head = 60 ft	CS	Aspen Icarus 2006.5
P-603	EDI Pump	PUMP	CENTRIFUGAL	Flow Rate = 500 gpm; Liquid Head = 60 ft	CS	Aspen Icarus 2006.5
P-604	Boiler Feed Water Pump	PUMP	POSITIVE DISPLACEMENT	Flow Rate = 1,050 gpm; Liquid Head = 3,340 ft	CS	Aspen Icarus 2006.5
S-601	Blowdown Flash Drum	TANK	VERTICAL-VESSEL	Liquid Flow Rate = 30 gpm; 1,500 psig Design Pressure; 10 Minute Residence Time; Vapor Space Factor = 3; Vessel Volume = 900 Gallons	CS	Aspen Icarus 2006.5
T-601	Condensate Collection Tank	SEPARATOR	VERTICAL-VESSEL	Condensate Flow = 1,000 gpm; Residence Time = 5 Minutes; Liquid Volume = 5,000 Gallons	CS	Aspen Icarus 2006.5
T-602	Condensate Surge Tank	TANK	HORIZONTAL-VESSEL	Condensate Flow = 1,000 gpm; Residence Time = 5 Minutes; Liquid Volume = 5,000 Gallons	CS	Aspen Icarus 2006.5
T-603	Deaerator	TANK	HORIZONTAL-VESSEL	Liquid Flow Rate = 1,050 gpm; 50 psig Design Pressure; 10 Minute Residence Time; Vapor Space Factor = 2; Vessel Volume = 21,000 Gallons	CS	Aspen Icarus 2006.5
T-603A	Deaerator Packed Column	COLUMN	PACKED COLUMN	Inside Diameter = 2 ft; Height = 10 ft; Packing Height = 8 ft	CS	Aspen Icarus 2006.5
T-605	Steam Drum	TANK	HORIZONTAL-VESSEL	Horizontal Drum; < 100% of Critical Velocity; Diameter = 5 ft; T-T Length = 20 ft	CS	Aspen Icarus 2006.5

EQUIPMENT_NUM	EQUIPMENT_NAME	EQUIPMENT_CATEGORY	EQUIPMENT_TYPE	EQUIPMENT_DESCRIPTION	MATERIAL_CONST	COST_BASIS
PFD-P820-A701 to A702						
K-701	Plant Air Compressor	COMPRESSOR	RECIPROCATING	Flow Rate = 450 CFM; Outlet Pressure = 125 PSIG	CS	Aspen Icarus 2006.5
M-701	Cooling Tower System	COOLING-TOWER	INDUCED-DRAFT	15,000 gpm, 110 °F Cooling Tower Inlet Temperature	FIBERGLASS	Cooling Tower Depot
M-702	Hydraulic Truck Dump with Scale	SCALE	TRUCK-SCALE	Hydraulic Truck Dumper with Scale	CS	Vendor Quotation
M-703	Flue Gas Scrubber	MISCELLANEOUS	VERTICAL-VESSEL	Scrubber costs from TurboSonic Technologies, Inc. Quotation basis = 160,000 ACF / Minute	SS304	TurboSonic Technologies, Inc.
M-704	Flue Gas Stack	MISCELLANEOUS	MISCELLANEOUS	Base Diameter = 72 inches; Stack Height = 200 ft	CS	Aspen Icarus 2006.5
M-705	Clarifier	SEPARATOR	CLARIFIER	Sizing Basis = 1.4 Ft / Hr Rise Rate; 40' Diameter x 12' Height	CS	Aspen Icarus 2006.5
M-706	Belt Press	MISCELLANEOUS	MISCELLANEOUS	Estimate from Harris Group Inc.		Harris Group Inc.
M-707	Sand Filter	MISCELLANEOUS	MISCELLANEOUS	Estimate from Harris Group Inc.		Harris Group Inc.
M-708	Emergency Flare	MISCELLANEOUS	MISCELLANEOUS	Included in overall cost for gasification & gas clean up based on quotation from Taylor Biomass Energy.		Taylor Biomass Energy
M-709	Cooling Tower Reverse Osmosis (RO) Unit	MISCELLANEOUS	PACKAGE UNIT	600 gpm package unit. Includes RO units, electrodeionization system, CIP skid, brine recovery and condensate polishing systems.		Siemens
M-710	Product Loading Rack	MISCELLANEOUS	MISCELLANEOUS	Assumed to be included in Site Development and Equipment Installation		Included in Site Development and Installation Piping
P-701	Cooling Water Pump	PUMP	CENTRIFUGAL	Flow Rate = 18,620 gpm; Liquid Head = 185 ft	CS	Aspen Icarus 2006.5
P-702	Firewater Pump	PUMP	CENTRIFUGAL	Flow Rate = 2,500 gpm; Liquid Head = 120 ft	CS	Aspen Icarus 2006.5
P-703	Diesel Pump	PUMP	CENTRIFUGAL	Flow Rate = 5 gpm; Liquid Head = 150 ft	CS	Aspen Icarus 2006.5
P-704	Ammonia Pump	PUMP	CENTRIFUGAL	Flow Rate = 1 gpm; Liquid Head = 150 ft	CS	Aspen Icarus 2006.5
P-705	Caustic Pump	PUMP	CENTRIFUGAL	Flow = 0.5 GPM; Fluid Head = 10 Ft; Design Pressure = 150 PSIG	CS	Aspen Icarus 2006.5
P-707	BFW Chemical Pump	PUMP	CENTRIFUGAL	Flow Rate = 1 gpm; Liquid Head = 150 ft	CS	Aspen Icarus 2006.5
P-708	Flue Gas Scrubber Circulation Pump	PUMP	CENTRIFUGAL	Flow = 1,010 GPM; Fluid Head = 60 Ft; Design Pressure = 30 PSIG	CS	Aspen Icarus 2006.5
P-709	Slurry Pump	PUMP	CENTRIFUGAL	Flow = 2 GPM; Fluid Head = 10 Ft; Design Pressure = 45 PSIG	CS	Aspen Icarus 2006.5
P-790	Alcohol Product Pump	PUMP	CENTRIFUGAL	Flow Rate = 100 gpm; Liquid Head = 30 ft	CS	Aspen Icarus 2006.5
S-701	Instrument Air Dryer	DRYER	PACKAGE UNIT	Flow Rate = 400 SCFM; Outlet Dewpoint = -40 Deg F	CS	Richardson
T-701	Plant Air Receiver	TANK	VERTICAL-VESSEL	Vessel Volume = 1,000 Gallons; Design Pressure = 200 PSIG	CS	Aspen Icarus 2006.5
T-702	Firewater Storage Tank	TANK	FLAT-BTM-STORAGE	Tank Volume = 600,000 Gallon; Design Pressure = 0.5 PSIG; Flat Roof	A285C	Aspen Icarus 2006.5
T-703	Purchased Diesel Storage Tank	TANK	FLAT-BTM-STORAGE	Tank Volume = 12,000 Gallon; Design Pressure = 0.5 PSIG; Floating Roof	A285C	Aspen Icarus 2006.5
T-704	Ammonia Storage Tank	TANK	HORIZONTAL-STORAGE	Consumption Rate = 20 Gallon per Day (10 wppm in BFW); 4-Week Storage Capacity; Tank Volume = 560 Gallon; Design Pressure = 350 PSIG	A515	Aspen Icarus 2006.5
T-705	Caustic Storage Tank	TANK	FLAT-BTM-STORAGE	Tank Volume = 5,400 Gallon; Design Pressure = 0.5 PSIG; Flat Roof	A285C	Aspen Icarus 2006.5
T-706	Olivine / MgO Loading System	LOADER	PACKAGE UNIT	Included in overall cost for gasification & gas clean up based on quotation from Taylor Biomass Energy.	CS	Taylor Biomass Energy
T-707	Tar Reformer Catalyst Loading System	LOADER	PACKAGE UNIT	Solid Catalyst Loading System Including PLC; Maximum Loading Rate of 5 Tons per Day	CS	Vendor Quotation
T-708	BFW Chemical Storage Tank	TANK	HORIZONTAL-STORAGE	Consumption Rate = 14 Gallon per Day (10 wppm in BFW); 4-Week Storage Capacity; Tank Volume = 400 Gallon; Design Pressure = 10 PSIG	SS316	Aspen Icarus 2006.5
T-709	Slurry Tank	TANK	CONE-BTM-STORAGE	Tank Size = Purge Rate * Residence Time = 1.0 GPM * 2 Days = 2,880 Gallons	CS	Aspen Icarus 2006.5
T-790	Mixed Alcohol Product Storage Tank	TANK	FLAT-BTM-STORAGE	Flow Rate = 15 gpm; 7-Day Storage Capacity; Tank Capacity = 151,200 Gallon; Design Pressure = 5 PSIG; Floating Roof	CS	Aspen Icarus 2006.5
T-792	Ethanol Product Storage Tank	TANK	FLAT-BTM-STORAGE	Flow Rate = 130 gpm; 7-Day Storage Capacity; Tank Capacity = 1,310,400 Gallon; Design Pressure = 5 PSIG; Floating Roof	CS	Aspen Icarus 2006.5

Appendix B. Individual Equipment Cost Summary

Equipment Number	Number Required	Number Spares	No. Req. Variable	Equipment Name	Scaling Stream	Scaling Stream Flow (lb/hr or btu/hr)	New Stream Flow	Size Ratio	Original Equip Cost (per unit)	Base Year	Total Original Equip Cost (Req'd & Spare) in Base Year	Scaling Exponent	Scaled Cost in Base Year	Installation Factor	Installed Cost in Base Year	Installed Cost in 2007\$	Scaled Uninstalled Cost in 2007\$
Area A100: Feed Handling & Drying																	
C-101	4			Hopper Feeder	STRM.A100.101	262,454	262,455	1.00	\$0	2007	\$0	0.75	\$0	2.47	\$0	\$0	\$0
C-102	2			Screener Feeder Conveyor	STRM.A100.101	262,454	262,455	1.00	\$0	2007	\$0	0.75	\$0	2.47	\$0	\$0	\$0
C-103	2			Radial Stacker Conveyor	STRM.A100.101	262,454	262,455	1.00	\$0	2007	\$0	0.75	\$0	2.47	\$0	\$0	\$0
C-104	2			Dryer Feed Screw Conveyor	STRM.A100.101	262,454	262,455	1.00	\$0	2007	\$0	0.75	\$0	2.47	\$0	\$0	\$0
C-105	2			Gasifier Feed Screw Conveyor	STRM.A100.104	204,131	204,131	1.00	\$0	2007	\$0	0.75	\$0	2.47	\$0	\$0	\$0
K-101	2			Flue Gas Blower	STRM.112	977,060	938,445	0.96	\$0	2007	\$0	0.75	\$0	2.47	\$0	\$0	\$0
K-102	2			CO2 Booster Blower	STRM.A100.101	262,454	262,455	1.00	\$0	2007	\$0	0.75	\$0	2.47	\$0	\$0	\$0
M-101	4			Hydraulic Truck Dump with Scale	STRM.A100.101	262,454	262,455	1.00	\$0	2007	\$0	0.75	\$0	2.47	\$0	\$0	\$0
M-103	3			Front End Loaders	STRM.A100.101	262,454	262,455	1.00	\$0	2007	\$0	0.75	\$0	2.47	\$0	\$0	\$0
M-104	2			Waste Heat Dryer	STRM.A100.101	262,454	262,455	1.00	\$0	2007	\$0	0.75	\$0	2.47	\$0	\$0	\$0
S-101	2			Magnetic Head Pulley	STRM.A100.101	262,454	262,455	1.00	\$0	2007	\$0	0.75	\$0	2.47	\$0	\$0	\$0
S-102	2			Vibratory Conveyor	STRM.A100.101	262,454	262,455	1.00	\$0	2007	\$0	0.75	\$0	2.47	\$0	\$0	\$0
T-101	4			Dump Hopper	STRM.A100.101	262,454	262,455	1.00	\$0	2007	\$0	0.75	\$0	2.47	\$0	\$0	\$0
T-103	2			Dryer Feed Bin	STRM.A100.101	262,454	262,455	1.00	\$0	2007	\$0	0.75	\$0	2.47	\$0	\$0	\$0
T-104	2			Dried Biomass Hopper	STRM.A100.104	204,131	204,131	1.00	\$0	2007	\$0	0.75	\$0	2.47	\$0	\$0	\$0
T-105	2			Lock Hopper	STRM.A100.104	204,131	204,131	1.00	\$0	2007	\$0	0.75	\$0	2.47	\$0	\$0	\$0
T-106	2			Feed Hopper	STRM.A100.104	204,131	204,131	1.00	\$0	2007	\$0	0.75	\$0	2.47	\$0	\$0	\$0
Area A100 Subtotal											\$0		\$0		\$0	\$0	\$0

Equipment Number	Number Required	Number Spares	No. Req. Variable	Equipment Name	Scaling Stream	Scaling Stream Flow (lb/hr or btu/hr)	New Stream Flow	Size Ratio	Original Equip Cost (per unit)	Base Year	Total Original Equip Cost (Req'd & Spare) in Base Year	Scaling Exponent	Scaled Cost in Base Year	Installation Factor	Installed Cost in Base Year	Installed Cost in 2007\$	Scaled Uninstalled Cost in 2007\$
Area A200: Gasification																	
C-201	1			Sand / Ash Conditioner / Conveyor	STRM.A200.219	2,430	2,428	1.00	\$0	2002	\$0	0.65	\$0	2.47	\$0	\$0	\$0
H-201	1			Syngas Quench Inlet / Combustion Air Pre-Heat Exchanger *	Pinch	1,000	1,000	1.00	\$0	2010	\$0	0.65	\$0	2.04	\$0	\$0	\$0
H-202	1			Tar Reformer Effluent / Combustion Air Pre-Heat Exchanger *	Pinch	1,000	1,000	1.00	\$0	2010	\$0	0.65	\$0	4.28	\$0	\$0	\$0
K-202	2			Char Combustor Air Blower	WORK.A200.A200CC.WK202	8,624	8,624	1.00	\$0	2010	\$0	0.65	\$0	2.47	\$0	\$0	\$0
M-201	2			Sand / Ash Cooler	STRM.219	2,428	2,428	1.00	\$0	2010	\$0	0.65	\$0	2.47	\$0	\$0	\$0
R-201	2			Indirectly-Heated Biomass Gasifier	STRM.A200.201	500	1,000	2.00	\$6,466,667	2010	\$12,933,333	0.60	\$19,603,268	2.31	\$45,238,310	\$43,254,246	\$18,743,506
R-202	2			Char Combustor	STRM.A200.A200CC.210	5,452,890	5,468,902	1.00	\$0	2010	\$0	0.65	\$0	2.47	\$0	\$0	\$0
S-201	2			Primary Gasifier Cyclone	STRM.A200.202	5,237,857	5,236,499	1.00	\$0	2010	\$0	0.65	\$0	2.47	\$0	\$0	\$0
S-202	2			Secondary Gasifier Cyclone	STRM.A200.222	254,544	251,092	0.99	\$0	2010	\$0	0.65	\$0	2.47	\$0	\$0	\$0
S-203	2			Primary Combustor Cyclone	STRM.A200.A200CC.210	5,452,889	5,468,902	1.00	\$0	2010	\$0	0.65	\$0	2.47	\$0	\$0	\$0
S-204	2			Char Combustor Secondary Cyclone	STRM.A200.A200CC.212	502,930	518,943	1.03	\$0	2010	\$0	0.65	\$0	2.47	\$0	\$0	\$0
T-201	1			Sand / Ash Bin	STRM.219	2,430	2,428	1.00	\$0	2010	\$0	0.65	\$0	2.47	\$0	\$0	\$0
Area A200 Subtotal											\$12,933,333		\$19,603,268	2.31	\$45,238,310	\$43,254,246	\$18,743,506

Equipment Number	Number Required	Number Spares	No. Req. Variable	Equipment Name	Scaling Stream	Scaling Stream Flow (lb/hr or btu/hr)	New Stream Flow	Size Ratio	Original Equip Cost (per unit)	Base Year	Total Original Equip Cost (Req'd & Spare) in Base Year	Scaling Exponent	Scaled Cost in Base Year	Installation Factor	Installed Cost in Base Year	Installed Cost in 2007\$	Scaled Uninstalled Cost in 2007\$
Area A300: Gas Cleanup																	
H-301	1			Quench Water Recirculation Cooler	HEAT.A300.A300Q.QCM301	10,000,000	9,917,194	0.99	\$0	2007	\$0	0.65	\$0	3.96	\$0	\$0	\$0
H-302	1			Steam Blowdown / Unreacted Syngas Exchanger	Pinch	1,000	1,000	1.00	\$65,163	2007	\$65,163	0.65	\$65,163	3.78	\$246,601	\$246,601	\$65,163
H-303	1			Syngas Quench Inlet / Make-Up Water Exchanger	Pinch	1,000	1,000	1.00	\$176,012	2007	\$176,012	0.65	\$176,013	1.89	\$332,301	\$332,301	\$176,013
H-304	1			Syngas Quench Inlet / Mol-Sieve Pre-Heat Exchanger	Pinch	1,000	1,000	1.00	\$35,863	2007	\$35,863	0.65	\$35,863	3.73	\$133,701	\$133,701	\$35,863
H-305	1			Alcohol Synthesis Effluent / Combustion Air Pre-Heat Exchanger	Pinch	1,000	1,000	1.00	\$32,363	2007	\$32,363	0.65	\$32,363	5.19	\$168,001	\$168,001	\$32,363
H-306	1			Syngas Quench Inlet / Combustion Air Pre-Heat Exchanger	Pinch	1,000	1,000	1.00	\$42,463	2007	\$42,463	0.65	\$42,463	5.55	\$235,801	\$235,801	\$42,463
H-307	1			Syngas Quench Inlet / Combustion Air Pre-Heat Exchanger	Pinch	1,000	1,000	1.00	\$83,563	2007	\$83,563	0.65	\$83,563	4.07	\$339,701	\$339,701	\$83,563
H-308	1			Tar Reformer Effluent / Combustion Air Pre-Heat Exchanger	Pinch	1,000	1,000	1.00	\$26,163	2007	\$26,163	0.65	\$26,163	4.62	\$121,000	\$121,000	\$26,163
H-309	1			Tar Reformer Effluent / Combustion Air Pre-Heat Exchanger	Pinch	1,000	1,000	1.00	\$59,963	2007	\$59,963	0.65	\$59,963	3.24	\$194,501	\$194,501	\$59,963
H-310	1			Catalyst Regenerator Flue Gas / Tar Reformer Steam & Recycle Exchanger	Pinch	1,000	1,000	1.00	\$359,712	2007	\$359,712	0.65	\$359,713	1.83	\$657,303	\$657,303	\$359,713
H-311	1			Tar Reformer Effluent / Unreacted Syngas Exchanger	Pinch	1,000	1,000	1.00	\$47,663	2007	\$47,663	0.65	\$47,663	3.80	\$181,101	\$181,101	\$47,663
K-305	1			Combustion Air Blower	WORK.A300.A300TR.A300FC.WK305	1,926	1,730	0.90	\$2,469,748	2007	\$2,469,748	0.65	\$2,303,037	1.13	\$2,610,903	\$2,610,903	\$2,303,037
M-300	1			Combustor Fuel Pre-Mix	STRM.A300.A300TR.325A	363,102	379,371	1.04	\$0	2010	\$0	0.65	\$0	2.47	\$0	\$0	\$0
M-300H	1			Tar Reformer Inlet Mix	STRM.A300.A300TR.325A	363,102	379,371	1.04	\$0	2010	\$0	0.65	\$0	2.47	\$0	\$0	\$0
M-301	1			Syngas Cyclone Separator	STRM.A300.A300Q.300	489,600	379,359	0.77	\$0	2010	\$0	0.65	\$0	2.47	\$0	\$0	\$0
M-302	1			Syngas Venturi Scrubber	STRM.A300.A300Q.300	489,600	379,359	0.77	\$0	2010	\$0	0.65	\$0	2.47	\$0	\$0	\$0
P-302	1	1		Quench Water Recirculation Pump	STRM.A300.A300Q.308	504,844	341,407	0.68	\$12,510	2007	\$25,020	0.30	\$22,250	4.12	\$91,595	\$91,595	\$22,250
R-301A	2			Tar Reformer Catalyst Regenerator	STRM.A300.225A	500	236,707	473.41	\$0	2010	\$0	0.60	\$0	2.31	\$0	\$0	\$0
R-303	2			Tar Reformer	STRM.A300.225A	500	1,000	2.00	\$3,233,333	2010	\$6,466,667	0.60	\$9,801,634	2.31	\$22,619,155	\$21,627,123	\$9,371,753
S-306	1			Tar Reformer 2-Stage Cyclone	STRM.A300.225A	500	236,707	473.41	\$0	2010	\$0	0.60	\$0	2.31	\$0	\$0	\$0
S-307	1			Catalyst Regenerator 2-Stage Cyclone	STRM.A300.225A	500	236,707	473.41	\$0	2010	\$0	0.60	\$0	2.31	\$0	\$0	\$0
Area A300 Subtotal											\$9,890,363		\$13,055,852	2.14	\$27,931,663	\$26,939,631	\$12,625,971

Equipment Number	Number Required	Number Spares	No. Req. Variable	Equipment Name	Scaling Stream	Scaling Stream Flow (lb/hr or btu/hr)	New Stream Flow	Size Ratio	Original Equip Cost (per unit)	Base Year	Total Original Equip Cost (Req'd & Spare) in Base Year	Scaling Exponent	Scaled Cost in Base Year	Installation Factor	Installed Cost in Base Year	Installed Cost in 2007\$	Scaled Uninstalled Cost in 2007\$
Area A400: Alcohol Synthesis																	
H-401	1			Alcohol Synthesis Feed / Effluent Exchanger	Pinch	1,000	1,000	1.00	\$2,353,181	2007	\$2,353,181	0.65	\$2,353,190	1.99	\$4,673,418	\$4,673,418	\$2,353,190
H-402	1			Alcohol Synthesis Feed / Effluent Exchanger	Pinch	1,000	1,000	1.00	\$2,152,502	2007	\$2,152,502	0.65	\$2,152,511	1.91	\$4,107,516	\$4,107,516	\$2,152,511
H-403	1			Compressor Interstage / Deaerator Feed Exchanger	Pinch	1,000	1,000	1.00	\$450,719	2007	\$450,719	0.65	\$450,721	2.47	\$1,112,404	\$1,112,404	\$450,721
H-404	1			Compressor Interstage / Deaerator Feed Exchanger	Pinch	1,000	1,000	1.00	\$388,090	2007	\$388,090	0.65	\$388,092	2.28	\$885,104	\$885,104	\$388,092
H-405	1			Compressor Interstage / Deaerator Feed Exchanger	Pinch	1,000	1,000	1.00	\$274,322	2007	\$274,322	0.65	\$274,323	2.45	\$672,803	\$672,803	\$274,323
H-406	1			Compressor Interstage / Mol-Sieve Pre-Heat Exchanger	Pinch	1,000	1,000	1.00	\$132,222	2007	\$132,222	0.65	\$132,223	2.13	\$281,801	\$281,801	\$132,223
H-407	1			Compressor Interstage / Mol-Sieve Pre-Heat Exchanger	Pinch	1,000	1,000	1.00	\$67,763	2007	\$67,763	0.65	\$67,763	2.51	\$170,201	\$170,201	\$67,763
H-408	1			Compressor Interstage / Mol-Sieve Pre-Heat Exchanger	Pinch	1,000	1,000	1.00	\$68,763	2007	\$68,763	0.65	\$68,763	3.35	\$230,501	\$230,501	\$68,763
H-409	1			Alcohol Synthesis Effluent / LO-CAT Pre-Heat Exchanger	Pinch	1,000	1,000	1.00	\$22,566	2007	\$22,566	0.65	\$22,566	3.37	\$76,000	\$76,000	\$22,566
H-410A	1			1st Stage Air Intercooler	HEAT.A400.A400CMPR.QAK-410A	37,400,000	26,184,715	0.70	\$318,900	2010	\$318,900	0.65	\$252,941	1.20	\$303,377	\$290,072	\$241,847
H-410B	1			2nd Stage Air Intercooler	HEAT.A400.A400CMPR.QAK-410B	36,000,000	6,369,531	0.18	\$249,600	2010	\$249,600	0.65	\$80,969	1.20	\$97,102	\$92,843	\$77,418
H-410C	1			3rd Stage Air Intercooler	HEAT.A400.A400CMPR.QAK-410C	32,600,000	10,059,981	0.31	\$219,300	2010	\$219,300	0.65	\$102,126	1.23	\$125,106	\$119,619	\$97,647
H-410D	1			4th Stage Air Intercooler	HEAT.A400.A400CMPR.QAK-410D	38,600,000	6,530,871	0.17	\$231,900	2010	\$231,900	0.65	\$73,072	1.30	\$95,353	\$91,171	\$69,867
H-410E	1			5th Stage Air Intercooler	HEAT.A400.A400CMPR.QAK-410E	36,000,000	6,001,423	0.17	\$244,700	2010	\$244,700	0.65	\$76,366	1.36	\$103,691	\$99,143	\$73,017
H-411A	1			1st Stage Water Intercooler	HEAT.A400.A400CMPR.QKCW410A	11,100,000	7,941,726	0.72	\$128,506	2007	\$128,506	0.65	\$103,373	2.21	\$228,215	\$228,215	\$103,373
H-411B	1			2nd Stage Water Intercooler	HEAT.A400.A400CMPR.QKCW410B	6,400,000	4,231,187	0.66	\$70,035	2007	\$70,035	0.65	\$53,518	2.78	\$148,934	\$148,934	\$53,518
H-411C	1			3rd Stage Water Intercooler	HEAT.A400.A400CMPR.QKCW410C	4,400,000	4,295,205	0.98	\$49,835	2007	\$49,835	0.65	\$49,060	3.18	\$156,134	\$156,134	\$49,060
H-411D	1			4th Stage Water Intercooler	HEAT.A400.A400CMPR.QKCW410D	3,300,000	3,203,051	0.97	\$45,735	2007	\$45,735	0.65	\$44,857	3.79	\$169,973	\$169,973	\$44,857
H-411E	1			5th Stage Water Intercooler	HEAT.A400.A400CMPR.QKCW410E	3,300,000	3,198,308	0.97	\$50,935	2007	\$50,935	0.65	\$49,909	4.90	\$244,475	\$244,475	\$49,909
H-413	1			Syngas Air Cooler	HEAT.A400.QAH413GB	33,800,000	26,161,365	0.77	\$289,106	2007	\$289,106	0.65	\$244,760	3.01	\$736,466	\$736,466	\$244,760
H-414	1			Syngas Cooling Water Exchanger	HEAT.A400.QCH414GB	15,600,000	20,647,374	1.32	\$161,435	2007	\$161,435	0.65	\$193,700	3.24	\$626,808	\$626,808	\$193,700
H-415	1			Alcohol Synthesis Effluent / Syngas Recycle Exchanger	Pinch	1,000	1,000	1.00	\$258,230	2007	\$258,230	0.65	\$258,231	2.67	\$690,403	\$690,403	\$258,231
H-416	1			Alcohol Synthesis Effluent / CO2-Rich Gas Exchanger	Pinch	1,000	1,000	1.00	\$28,534	2007	\$28,534	0.65	\$28,534	3.89	\$111,000	\$111,000	\$28,534
H-417	1			Alcohol Synthesis Effluent / Mol-Sieve Pre-Heat Exchanger	Pinch	1,000	1,000	1.00	\$48,163	2007	\$48,163	0.65	\$48,163	2.96	\$142,801	\$142,801	\$48,163
H-418	1			Alcohol Synthesis Effluent / Expander Inlet Exchanger	Pinch	1,000	1,000	1.00	\$79,563	2007	\$79,563	0.65	\$79,563	3.64	\$289,601	\$289,601	\$79,563
H-419	1			Tar Reformer Effluent / Expander Inlet Exchanger	Pinch	1,000	1,000	1.00	\$32,280	2007	\$32,280	0.65	\$32,280	6.99	\$225,601	\$225,601	\$32,280
H-420	1			Tar Reformer Effluent / Expander Inlet Exchanger	Pinch	1,000	1,000	1.00	\$88,063	2007	\$88,063	0.65	\$88,063	5.15	\$453,202	\$453,202	\$88,063
H-421	1			Alcohol Synthesis Effluent / Expander Inlet Exchanger	Pinch	1,000	1,000	1.00	\$29,363	2007	\$29,363	0.65	\$29,363	5.64	\$165,701	\$165,701	\$29,363
H-422	1			Tar Reformer Effluent / Expander Inlet Exchanger	Pinch	1,000	1,000	1.00	\$38,063	2007	\$38,063	0.65	\$38,063	4.00	\$152,301	\$152,301	\$38,063
H-423	1			Tar Reformer Effluent / Expander Inlet Exchanger	Pinch	1,000	1,000	1.00	\$57,963	2007	\$57,963	0.65	\$57,963	3.49	\$202,501	\$202,501	\$57,963
H-424	1			Alcohol Synthesis Effluent / CO2-Rich Gas Exchanger	Pinch	1,000	1,000	1.00	\$35,963	2007	\$35,963	0.65	\$35,963	6.36	\$228,901	\$228,901	\$35,963
H-425	1			Char Combustor Flue Gas / CO2-Rich Gas Exchanger	Pinch	1,000	1,000	1.00	\$28,380	2007	\$28,380	0.65	\$28,380	3.97	\$112,600	\$112,600	\$28,380
H-426	1			Tar Reformer Effluent / CO2-Rich Gas Exchanger	Pinch	1,000	1,000	1.00	\$41,563	2007	\$41,563	0.65	\$41,563	4.21	\$174,801	\$174,801	\$41,563
H-427	1			Catalyst Regenerator Flue Gas / Alcohol Synthesis Feed Exchanger	Pinch	1,000	1,000	1.00	\$111,563	2007	\$111,563	0.65	\$111,563	5.79	\$645,403	\$645,403	\$111,563
K-410	1			Synthesis Gas Compressor	WORK.A400.WK410	78,374	63,374	0.81	\$38,716,300	2010	\$38,716,300	0.80	\$32,665,109	1.80	\$58,797,196	\$56,218,465	\$31,232,481
K-414	1			Unconverted Syngas Recycle Compressor	WORK.A400.WK414	510	706	1.39	\$0	2010	\$0	0.80	\$0	1.80	\$0	\$0	\$0
K-412A	1			Purge Gas Expander Stage 1	WORK.A400.WK412-1	-10,058	-6,342	0.63	\$3,300,000	2007	\$3,300,000	0.80	\$2,281,723	1.80	\$4,107,101	\$4,107,101	\$2,281,723
K-412B	1			Purge Gas Expander Stage 2	WORK.A400.WK412-2	-12,257	-9,036	0.74	\$9,800,000	2007	\$9,800,000	0.80	\$7,679,024	1.80	\$13,822,244	\$13,822,244	\$7,679,024

Equipment Number	Number Required	Number Spares	No. Req. Variable	Equipment Name	Scaling Stream	Scaling Stream Flow (lb/hr or btu/hr)	New Stream Flow	Size Ratio	Original Equip Cost (per unit)	Base Year	Total Original Equip Cost (Req'd & Spare) in Base Year	Scaling Exponent	Scaled Cost in Base Year	Installation Factor	Installed Cost in Base Year	Installed Cost in 2007\$	Scaled Uninstalled Cost in 2007\$	
M-401	1			DEPG Acid Gas Removal System	STRM.A400.SELEXOL.CO2-H2S	56,150	60,514	1.08	\$6,633,000	2007	\$6,633,000	0.75	\$7,016,026	2.53	\$17,750,547	\$17,750,547	\$7,016,026	
M-402	1			Ammonia Absorption Refrigeration System	STRM.A400.SELEXOL.CO2-H2S	56,150	60,514	1.08	\$3,200,000	2010	\$3,200,000	0.75	\$3,384,786	1.15	\$3,892,504	\$3,721,786	\$3,236,336	
M-403	1			Amine Acid Gas Enrichment System	STRM.A400.SELEXOL.CO2-H2S	56,150	60,514	1.08	\$1,241,000	2007	\$1,241,000	0.75	\$1,312,662	2.80	\$3,675,454	\$3,675,454	\$1,312,662	
M-404	1			Methanol / H2S Absorption System	STRM.A400.SELEXOL.RECY-H2S	6,400	7,749	1.21	\$428,000	2007	\$428,000	0.75	\$494,013	2.00	\$988,026	\$988,026	\$494,013	
M-405	1			LO-CAT Sulfur Recovery System	STRM.A400.SELEXOL.424	93	39	0.42	\$2,917,500	2009	\$2,917,500	0.75	\$1,516,719	1.35	\$2,049,585	\$2,063,330	\$1,526,890	
R-410	2			Alcohol Synthesis Reactor	NTUBES	4,500	4,790	1.06	\$5,763,000	2010	\$11,526,000	0.56	\$11,935,541	2.47	\$29,480,786	\$28,187,816	\$11,412,071	
S-410A	1			1st Interstage KO Drum	STRM.313	431,712	351,310	0.81	\$72,472	2007	\$72,472	0.65	\$63,386	3.63	\$230,027	\$230,027	\$63,386	
S-410B	1			2nd Interstage KO Drum	STRM.313	431,712	351,310	0.81	\$51,137	2007	\$51,137	0.65	\$44,726	3.21	\$143,526	\$143,526	\$44,726	
S-410C	1			3rd Interstage KO Drum	STRM.313	431,712	351,310	0.81	\$47,835	2007	\$47,835	0.65	\$41,838	2.87	\$120,261	\$120,261	\$41,838	
S-410D	1			4th Interstage KO Drum	STRM.313	431,712	351,310	0.81	\$83,101	2007	\$83,101	0.65	\$72,682	2.45	\$177,812	\$177,812	\$72,682	
S-410E	1			5th Interstage KO Drum	STRM.313	431,712	351,310	0.81	\$108,700	2007	\$108,700	0.65	\$95,072	2.00	\$190,581	\$190,581	\$95,072	
S-415	1			Pre-Compressor KO Drum	STRM.313	431,712	351,310	0.81	\$144,796	2007	\$144,796	0.65	\$126,643	2.65	\$336,032	\$336,032	\$126,643	
Area A400 Subtotal																		
											\$87,117,647		\$76,842,446	2.01	\$154,601,879	\$150,541,425	\$74,722,392	

Equipment Number	Number Required	Number Spares	No. Req. Variable	Equipment Name	Scaling Stream	Scaling Stream Flow (lb/hr or btu/hr)	New Stream Flow	Size Ratio	Original Equip Cost (per unit)	Base Year	Total Original Equip Cost (Req'd & Spare) in Base Year	Scaling Exponent	Scaled Cost in Base Year	Installation Factor	Installed Cost in Base Year	Installed Cost in 2007\$	Scaled Uninstalled Cost in 2007\$		
Area A500: Alcohol Separation																			
D-504	1			Crude Alcohol Distillation Column	STRM.A500.507	128,550	122,834	0.96	\$1,984,906	2007	\$1,984,906	0.65	\$1,927,078	1.25	\$2,413,864	\$2,413,864	\$1,927,078		
D-505	1			Methanol Column	STRM.A500.A504.510	123,000	116,386	0.95	\$3,855,479	2007	\$3,855,479	0.65	\$3,719,418	1.19	\$4,441,909	\$4,441,909	\$3,719,418		
H-501	1			Ethanol Product / Mol-Sieve Pre-Heat Exchanger	Pinch	1,000	1,000	1.00	\$30,263	2007	\$30,263	0.65	\$30,263	3.39	\$102,500	\$102,500	\$30,263		
H-502	1			Higher Alcohols Product / Mol-Sieve Pre-Heat Exchanger	Pinch	1,000	1,000	1.00	\$16,684	2007	\$16,684	0.65	\$16,684	3.94	\$65,700	\$65,700	\$16,684		
H-503	1			Syngas Quench Inlet / Water-Methanol Recycle Exchanger	Pinch	1,000	1,000	1.00	\$244,690	2007	\$244,690	0.65	\$244,691	1.87	\$458,202	\$458,202	\$244,691		
H-504C	1			Crude Alcohol Column Condenser	HEAT.A500.A504.QAH504	35,939,280	35,157,846	0.98	\$370,914	2007	\$370,914	0.65	\$365,652	1.29	\$470,726	\$470,726	\$365,652		
H-504R	1			Crude Alcohol Column Reboiler	HEAT.A500.A504.QRH504	-33,348,297	-32,400,695	0.97	\$142,353	2007	\$142,353	0.65	\$139,711	1.84	\$257,529	\$257,529	\$139,711		
H-505C	1			Methanol Column Condenser	HEAT.A500.A504.QAH505	100,301,348	94,492,276	0.94	\$949,928	2007	\$949,928	0.65	\$913,795	1.20	\$1,093,367	\$1,093,367	\$913,795		
H-505R	1			Methanol Column Reboiler	HEAT.A500.A504.QRH505	-84,068,475	-77,564,618	0.92	\$299,853	2007	\$299,853	0.65	\$284,563	1.63	\$464,350	\$464,350	\$284,563		
H-506	1			Syngas Quench Inlet / Mol-Sieve Pre-Heat Exchanger	Pinch	1,000	1,000	1.00	\$106,034	2007	\$106,034	0.65	\$106,034	2.14	\$226,701	\$226,701	\$106,034		
H-507	1			Alcohol Synthesis Effluent / Mol-Sieve Pre-Heat Exchanger	Pinch	1,000	1,000	1.00	\$24,080	2007	\$24,080	0.65	\$24,080	6.59	\$158,601	\$158,601	\$24,080		
H-508	1			Alcohol Synthesis Effluent / Mol-Sieve Pre-Heat Exchanger	Pinch	1,000	1,000	1.00	\$20,880	2007	\$20,880	0.65	\$20,880	5.52	\$115,200	\$115,200	\$20,880		
H-509	1			Catalyst Regenerator Flue Gas / Water-Methanol Recycle Exchanger	Pinch	1,000	1,000	1.00	\$25,366	2007	\$25,366	0.65	\$25,366	3.57	\$90,500	\$90,500	\$25,366		
H-510	1			Tar Reformer Effluent / Water-Methanol Recycle Exchanger	Pinch	1,000	1,000	1.00	\$24,934	2007	\$24,934	0.65	\$24,934	4.35	\$108,400	\$108,400	\$24,934		
H-513	1			Molecular Sieve Flush Cooler	HEAT.A500.A503MS.QASS13	35,939,280	11,705,592	0.33	\$0	2007	\$0	0.65	\$0	1.29	\$0	\$0	\$0		
H-514	1			Methanol Condenser	HEAT.A500.A503MS.QAH514	35,939,280	25,880,451	0.72	\$370,914	2007	\$370,914	0.65	\$299,630	1.29	\$385,731	\$385,731	\$299,630		
H-591	1			Higher Alcohols Product Finishing Cooler	HEAT.A500.QCH591	41,542	47,049	1.13	\$20,866	2007	\$20,866	0.65	\$22,625	3.16	\$71,563	\$71,563	\$22,625		
H-593	1			Ethanol Product Finishing Cooler	HEAT.A500.QCH593	381,671	397,956	1.04	\$16,780	2007	\$16,780	0.65	\$17,242	4.32	\$74,496	\$74,496	\$17,242		
P-504	1	1		Crude Alcohol Column Reflux Pump	STRM.A500.A504.510	122,900	116,386	0.95	\$6,967	2007	\$13,934	0.30	\$13,708	5.10	\$69,849	\$69,849	\$13,708		
P-505	1	1		Methanol Column Reflux Pump	STRM.A500.A504.512	73,980	65,385	0.88	\$9,571	2007	\$19,142	0.30	\$18,446	4.68	\$86,341	\$86,341	\$18,446		
P-514	1	1		Condensed Methanol Pump	STRM.A500.A503MS.514-ML1	44,808	44,966	1.00	\$396,462	2007	\$792,924	0.30	\$793,760	1.24	\$983,014	\$983,014	\$793,760		
P-590	1	1		Crude Alcohol Column Bottoms Pump	STRM.A500.A504.511	5,655	6,448	1.14	\$8,063	2007	\$16,126	0.30	\$16,773	4.55	\$76,347	\$76,347	\$16,773		
P-592	1	1		Methanol Column Bottoms Pump	STRM.A500.A504.592A	48,910	51,000	1.04	\$11,910	2007	\$23,820	0.30	\$24,121	4.27	\$102,884	\$102,884	\$24,121		
S-501	1			Mixed Alcohols Condensation Knock-out	STRM.A400.473A	869,375	1,077,813	1.24	\$116,973	2007	\$116,973	0.65	\$134,510	2.02	\$271,382	\$271,382	\$134,510		
S-502	1			Mol Sieve Pre-Flash Drum	STRM.A500.503	163,030	162,485	1.00	\$60,922	2007	\$60,922	0.65	\$60,790	3.84	\$233,391	\$233,391	\$60,790		
S-503	1			Molecular Sieve Separator System	STRM.A500.505	66,978	129,421	1.93	\$2,600,000	2009	\$2,600,000	0.60	\$3,860,264	1.80	\$6,948,474	\$6,995,073	\$3,886,152		
S-514	1			Condensed Methanol Flash Drum	STRM.A500.A503MS.514-M0	55,410	55,578	1.00	\$19,705	2007	\$19,705	0.65	\$19,744	4.89	\$96,489	\$96,489	\$19,744		
T-504	1			Crude Alcohol Column Overhead Accumulator	STRM.A500.A504.510	122,900	116,386	0.95	\$30,191	2007	\$30,191	0.65	\$29,141	6.16	\$179,531	\$179,531	\$29,141		
T-505	1			Methanol Column Overhead Accumulator	STRM.A500.A504.512	73,980	65,385	0.88	\$46,575	2007	\$46,575	0.65	\$42,982	4.97	\$213,828	\$213,828	\$42,982		
Area A500 Subtotal													\$12,245,236		\$13,196,883	1.54	\$20,260,870	\$20,307,468	\$13,222,771

Equipment Number	Number Required	Number Spares	No. Req. Variable	Equipment Name	Scaling Stream	Scaling Stream Flow (lb/hr or btu/hr)	New Stream Flow	Size Ratio	Original Equip Cost (per unit)	Base Year	Total Original Equip Cost (Req'd & Spare) in Base Year	Scaling Exponent	Scaled Cost in Base Year	Installation Factor	Installed Cost in Base Year	Installed Cost in 2007\$	Scaled Uninstalled Cost in 2007\$
Area A600: Steam System & Power Generation																	
H-601	1			Steam Turbine Condenser	HEAT.A600.A600ST.QAH601	1.00	5.00	5.00	\$1,300,000	2010	\$1,300,000	1.00	\$6,500,000	1.40	\$9,100,000	\$8,700,892	\$6,214,923
H-602	1			Steam Turbine Exhaust / Syngas Recycle Exchanger	Pinch	1,000	1,000	1.00	\$31,463	2007	\$31,463	0.65	\$31,463	3.45	\$108,500	\$108,500	\$31,463
H-603	1			Blowdown Cooler	HEAT.A600.QCH603	381,671	474,197	1.24	\$16,780	2007	\$16,780	0.65	\$19,323	4.32	\$83,486	\$83,486	\$19,323
H-604	1			Steam Turbine Exhaust / Mol-Sieve Pre-Heat Exchanger	Pinch	1,000	1,000	1.00	\$30,163	2007	\$30,163	0.65	\$30,163	3.53	\$106,600	\$106,600	\$30,163
H-605	1			Syngas Quench Inlet / Make-Up Water Exchanger	Pinch	1,000	1,000	1.00	\$27,063	2007	\$27,063	0.65	\$27,063	3.83	\$103,700	\$103,700	\$27,063
H-606	1			Syngas Quench Inlet / BFW Pre-Heat Exchanger	Pinch	1,000	1,000	1.00	\$107,834	2007	\$107,834	0.65	\$107,834	2.12	\$228,701	\$228,701	\$107,834
H-607	1			Alcohol Synthesis Effluent / BFW Pre-Heat Exchanger	Pinch	1,000	1,000	1.00	\$164,512	2007	\$164,512	0.65	\$164,513	1.95	\$320,201	\$320,201	\$164,513
H-608	1			Tar Reformer Effluent / BFW Pre-Heat Exchanger	Pinch	1,000	1,000	1.00	\$726,312	2007	\$726,312	0.65	\$726,315	2.53	\$1,840,607	\$1,840,607	\$726,315
H-609	1			Catalyst Regenerator Flue Gas / BFW Pre-Heat Exchanger	Pinch	1,000	1,000	1.00	\$207,063	2007	\$207,063	0.65	\$207,064	3.56	\$736,803	\$736,803	\$207,064
H-610	1			Char Combustor Flue Gas / BFW Pre-Heat Exchanger	Pinch	1,000	1,000	1.00	\$341,534	2007	\$341,534	0.65	\$341,535	3.23	\$1,102,704	\$1,102,704	\$341,535
H-611	1			Catalyst Regenerator Flue Gas Steam Generator	Pinch	1,000	1,000	1.00	\$89,663	2007	\$89,663	0.65	\$89,663	5.07	\$455,002	\$455,002	\$89,663
H-612	1			Char Combustor Flue Gas Steam Superheater	Pinch	1,000	1,000	1.00	\$518,334	2007	\$518,334	0.65	\$518,336	3.00	\$1,557,506	\$1,557,506	\$518,336
H-613	1			Tar Reformer Effluent Steam Superheater	Pinch	1,000	1,000	1.00	\$315,934	2007	\$315,934	0.65	\$315,935	2.00	\$632,403	\$632,403	\$315,935
M-601A	1			BFW Reverse Osmosis (RO) Unit	STRM.A600.A600BF.631	300,240	476,788	1.59	\$1,865,000	2010	\$1,865,000	0.70	\$2,577,973	1.15	\$2,964,669	\$2,834,645	\$2,464,908
M-601B	1			BFW Electrodeionization (EDI) Unit	STRM.A600.A600BF.631	300,240	476,788	1.59	\$0	2010	\$0	0.70	\$0	1.15	\$0	\$0	\$0
M-601C	1			Hot Condensate Polishing Unit	STRM.A600.616+SELSTRET+536	400,439	400,439	1.00	\$0	2010	\$0	0.70	\$0	1.15	\$0	\$0	\$0
M-602A	1			Extraction Steam Turbine / Generator Stage 1	WTURB1	-40,418	-23,244	0.58	\$7,700,000	2010	\$7,700,000	0.70	\$5,227,608	1.80	\$9,409,694	\$8,997,003	\$4,998,335
M-602B	1			Extraction Steam Turbine / Generator Stage 2	WTURB2	-40,418	-47,755	1.18	\$7,700,000	2010	\$7,700,000	0.70	\$8,653,643	1.80	\$15,576,558	\$14,893,400	\$8,274,111
M-603	1			Startup Boiler	STRM.A200.200	36,560	66,542	1.82	\$198,351	2002	\$198,351	0.60	\$284,111	2.47	\$701,754	\$932,006	\$377,331
M-604	1			Brine Recovery Reverse Osmosis (RO) Unit	STRM.H2O-MGMT.TOROBRIN	300,240	31,811	0.11	\$0	2010	\$0	0.70	\$0	1.15	\$0	\$0	\$0
P-601	1	1		Make-Up Pump	STRM.A600.A600WTR.618	80,411	101,798	1.27	\$6,528	2007	\$13,056	0.30	\$14,013	4.72	\$66,116	\$66,116	\$14,013
P-602	1	1		Condensate Pump	STRM.A600.633	247,010	476,788	1.93	\$9,810	2007	\$19,620	0.30	\$23,899	4.61	\$110,116	\$110,116	\$23,899
P-603	1	1		EDI Pump	STRM.A600.633	247,010	476,788	1.93	\$9,810	2007	\$19,620	0.30	\$23,899	4.61	\$110,116	\$110,116	\$23,899
P-604	1	1		Boiler Feed Water Pump	STRM.A600.633	494,622	476,788	0.96	\$304,578	2007	\$609,156	0.30	\$602,482	1.35	\$814,972	\$814,972	\$602,482
S-601	1			Blowdown Flash Drum	STRM.A600.604	9,892	9,536	0.96	\$47,205	2007	\$47,205	0.65	\$46,092	3.41	\$157,398	\$157,398	\$46,092
T-601	1			Condensate Collection Tank	STRM.A600.A600BF.627	500,400	476,788	0.95	\$28,505	2007	\$28,505	0.65	\$27,623	6.83	\$188,678	\$188,678	\$27,623
T-602	1			Condensate Surge Tank	STRM.A600.A600BF.627	500,400	476,788	0.95	\$27,704	2007	\$27,704	0.65	\$26,847	6.51	\$174,820	\$174,820	\$26,847
T-603	1			Deaerator	STRM.A600.633	494,619	476,788	0.96	\$53,299	2007	\$53,299	0.65	\$52,042	5.07	\$263,730	\$263,730	\$52,042
T-603A	1			Deaerator Packed Column	STRM.A600.633	494,619	476,788	0.96	\$18,405	2007	\$18,405	0.65	\$17,971	5.18	\$93,053	\$93,053	\$17,971
T-605	1			Steam Drum	STRM.A600.644	494,622	476,791	0.96	\$104,100	2007	\$104,100	0.65	\$101,645	2.28	\$231,509	\$231,509	\$101,645
Area A600 Subtotal											\$22,280,676		\$26,759,057	1.77	\$47,239,398	\$45,844,669	\$25,845,329

Equipment Number	Number Required	Number Spares	No. Req. Variable	Equipment Name	Scaling Stream	Scaling Stream Flow (lb/hr or btu/hr)	New Stream Flow	Size Ratio	Original Equip Cost (per unit)	Base Year	Total Original Equip Cost (Req'd & Spare) in Base Year	Scaling Exponent	Scaled Cost in Base Year	Installation Factor	Installed Cost in Base Year	Installed Cost in 2007\$	Scaled Uninstalled Cost in 2007\$
Area A700: Cooling Water & Other Utilities																	
K-701	2	1		Plant Air Compressor	STRM.A100.101	262,454	262,455	1.00	\$87,922	2007	\$263,766	0.30	\$263,766	1.57	\$413,700	\$413,700	\$263,766
M-701	1			Cooling Tower System	STRM.A700.715	7,506,000	5,864,499	0.78	\$260,852	2010	\$260,852	0.78	\$215,177	2.47	\$531,487	\$508,177	\$205,740
M-702	1			Hydraulic Truck Dump with Scale	STRM.A100.101	367,437	262,455	0.71	\$80,000	1998	\$80,000	0.60	\$65,375	2.47	\$161,477	\$217,817	\$88,185
M-703	1			Flue Gas Scrubber	STRM.112	489,600	938,445	1.92	\$436,250	2010	\$436,250	0.65	\$665,893	2.47	\$1,644,755	\$1,572,619	\$636,688
M-704	1			Flue Gas Stack	STRM.112	939,119	938,445	1.00	\$169,187	2007	\$169,187	0.65	\$169,108	1.30	\$219,697	\$219,697	\$169,108
M-705	1			Clarifier		220	220		\$96,221	2007	\$96,221	0.65	\$96,221	2.41	\$232,300	\$232,300	\$96,221
M-706	1			Belt Press		1	1		\$135,000	2010	\$135,000	0.65	\$135,000	2.47	\$333,450	\$318,826	\$129,079
M-707	1			Sand Filter		265	265		\$120,400	2010	\$120,400	0.65	\$120,400	2.47	\$297,388	\$284,345	\$115,119
M-708	1			Emergency Flare	STRM.A100.101	262,454	262,455	1.00	\$0	2010	\$0	0.00	\$0	2.47	\$0	\$0	\$0
M-709	1			Cooling Tower Reverse Osmosis (RO) Unit	STRM.A100.101	300,240	262,455	0.87	\$0	2010	\$0	0.70	\$0	1.15	\$0	\$0	\$0
M-710	1			Product Loading Rack	STRM.A100.101	262,454	262,455	1.00	\$0	2010	\$0	0.00	\$0	2.47	\$0	\$0	\$0
P-701	1	1		Cooling Water Pump	STRM.A700.715	7,001,377	5,864,499	0.84	\$239,375	2007	\$478,750	0.30	\$453,966	2.14	\$971,558	\$971,558	\$453,966
P-702	1	1		Firewater Pump	STRM.A100.101	262,454	262,455	1.00	\$23,043	2007	\$46,086	0.30	\$46,086	3.70	\$170,400	\$170,400	\$46,086
P-703	1	1		Diesel Pump	STRM.A100.101	262,454	262,455	1.00	\$3,842	2007	\$7,684	0.30	\$7,684	5.39	\$41,400	\$41,400	\$7,684
P-704	1	1		Ammonia Pump	STRM.A100.101	262,454	262,455	1.00	\$3,842	2007	\$7,684	0.30	\$7,684	5.21	\$40,000	\$40,000	\$7,684
P-705	1	1		Caustic Pump		1	1		\$4,906	2007	\$9,812	0.30	\$9,812	4.30	\$42,200	\$42,200	\$9,812
P-707	1	1		BFW Chemical Pump	STRM.A100.101	262,454	262,455	1.00	\$3,842	2007	\$7,684	0.30	\$7,684	5.21	\$40,000	\$40,000	\$7,684
P-708	1	1		Flue Gas Scrubber Circulation Pump	STRM.112	489,600	938,445	1.92	\$12,510	2007	\$25,020	0.30	\$30,413	4.12	\$125,201	\$125,201	\$30,413
P-709	1	1		Slurry Pump		1	1		\$3,242	2007	\$6,484	0.30	\$6,484	6.63	\$43,000	\$43,000	\$6,484
P-790	1	1		Alcohol Product Pump	STRM.A100.101	262,454	262,455	1.00	\$5,981	2007	\$11,962	0.30	\$11,962	5.03	\$60,200	\$60,200	\$11,962
S-701	1	1		Instrument Air Dryer	STRM.A100.101	262,454	262,455	1.00	\$8,349	2002	\$16,698	0.60	\$16,698	2.47	\$41,244	\$54,777	\$22,177
T-701	1			Plant Air Receiver	STRM.A100.101	262,454	262,455	1.00	\$21,005	2007	\$21,005	0.65	\$21,005	5.44	\$114,300	\$114,300	\$21,005
T-702	1			Firewater Storage Tank	STRM.A100.101	262,454	262,455	1.00	\$229,900	2007	\$229,900	0.65	\$229,900	1.46	\$336,100	\$336,100	\$229,900
T-703	1			Purchased Diesel Storage Tank	STRM.A100.101	262,454	262,455	1.00	\$104,674	2007	\$104,674	0.65	\$104,674	1.35	\$140,900	\$140,900	\$104,674
T-704	1			Ammonia Storage Tank	STRM.A100.101	262,454	262,455	1.00	\$15,704	2007	\$15,704	0.65	\$15,704	5.39	\$84,600	\$84,600	\$15,704
T-705	1			Caustic Storage Tank		1	1		\$16,005	2007	\$16,005	0.65	\$16,005	3.01	\$48,200	\$48,200	\$16,005
T-706	1			Olivine / MgO Loading System	STRM.A100.101	262,454	262,455	1.00	\$0	2010	\$0	0.00	\$0	2.00	\$0	\$0	\$0
T-707	1			Tar Reformer Catalyst Loading System	STRM.A100.101	262,454	262,455	1.00	\$235,000	2010	\$235,000	0.00	\$235,000	2.00	\$470,000	\$449,387	\$224,693
T-708	1			BFW Chemical Storage Tank	STRM.A100.101	262,454	262,455	1.00	\$22,004	2007	\$22,004	0.65	\$22,004	6.70	\$147,400	\$147,400	\$22,004
T-709	1			Slurry Tank	STRM.A100.101	1	1	1.00	\$14,205	2007	\$14,205	0.65	\$14,205	2.41	\$34,300	\$34,300	\$14,205
T-790	1			Mixed Alcohol Product Storage Tank	STRM.590	6,063	6,448	1.06	\$220,700	2007	\$220,700	0.65	\$229,699	1.34	\$308,174	\$308,174	\$229,699
T-792	1	1		Ethanol Product Storage Tank	STRM.592	51,427	51,000	0.99	\$690,900	2007	\$1,381,800	0.65	\$1,374,330	1.85	\$2,540,193	\$2,540,193	\$1,374,330
Area A700 Subtotal											\$4,440,537		\$4,591,939	2.10	\$9,633,624	\$9,559,771	\$4,560,078
Plant Total											\$148,907,792		\$154,049,444	1.98	\$304,905,745	\$296,447,211	\$149,720,048

**Appendix C. Discounted Cash Flow Rate of Return (DCFROR)
and Operating Cost Summary**

Process Engineering Analysis for Ethanol from Mixed Alcohol Synthesis

2012 Case Using Technical Targets for Tar Reforming & Mixed Alcohol Synthesis
 2,000 Dry Metric Tonnes Biomass per Day
 Indirect Gasifier, Tar Reformer, Sulfur Removal, MoS₂ Catalyst, Fuel Purification, Steam-Power Cycle
 All Values in 2007\$

Minimum Ethanol Selling Price (MESP) \$2.05 per Gallon

Contributions: Feedstock Costs	\$0.735	per Gallon
Operating Costs & Credits	\$0.244	per Gallon
Capital Charges & Taxes	\$1.069	per Gallon

Gasoline-Equivalent Price \$3.11 per Gallon

EtOH Production at Operating Capacity	64.7	MM Gallons per Year
EtOH Product Yield	83.8	Gallons per Dry US Ton Feedstock
Mixed Alcohols Production at Operating Capacity	72.5	MM Gallons per Year
Mixed Alcohols Product Yield	93.9	Gallons per Dry US Ton Feedstock
Delivered Feedstock Cost	\$61.57	per Dry US Ton (Includes Capital Up to Throat of Gasifier)
Internal Rate of Return (After-Tax)	10.0%	
Equity Percent of Total Investment	40.0%	

Capital Costs		Operating Costs (¢ / Gallon Product)	
Gasification	\$43,250,000	Feedstock	73.5
Tar Reforming & Quench	\$26,940,000	Natural Gas	0.0
Acid Gas & Sulfur Removal	\$28,490,000	Catalysts	9.9
Syngas Compression & Expansion	\$80,630,000	Olivine & Magnesium Oxide	0.7
Alcohol Synthesis Reaction	\$41,420,000	Other Raw Materials	0.9
Alcohol Separation	\$20,310,000	Waste Disposal	0.8
Steam System & Power Generation	\$45,840,000	Electricity	0.0
Cooling Water & Other Utilities	\$9,560,000	Fixed Costs	35.9
Total Installed Equipment Cost (TIC)	\$296,450,000	Co-Product Credits	-23.8
		Capital Depreciation	37.8
Land (115 acres at \$14000 per acre)	1,600,000	Average Income Tax	11.5
Site Development	9,640,000	Average Return on Investment	57.5
(% of ISBL)	4.0%		
Indirect Costs & Project Contingency	183,650,000	Operating Costs (\$ / Year)	
(% of TIC)	62.0%	Feedstock	\$47,560,000
		Natural Gas	\$0
Fixed Capital Investment (FCI)	491,350,000	Catalysts	\$6,380,000
Working Capital	24,490,000	Olivine & Magnesium Oxide	\$0
Total Capital Investment (TCI)	515,840,000	Other Raw Materials	\$380,000
		Waste Disposal	\$520,000
Total Installed Equipment Cost per Annual Gallon		Electricity	\$0
of Ethanol Product	4.58	Fixed Costs	\$23,240,000
of Mixed Alcohol Product	4.09	Co-Product Credits at \$1.88 per Gallon	-\$15,380,000
		Capital Depreciation	\$24,490,000
Fixed Capital Investment per Annual Gallon		Average Income Tax	\$7,450,000
of Ethanol Product	7.59	Average Return on Investment	\$37,210,000
of Mixed Alcohol Product	6.78		
		Total Plant Electricity Usage (KW)	64,356
Loan Interest Rate	8.0%	Electricity Produced Onsite (KW)	64,411
Loan Term (Years)	10	Electricity Purchased from Grid (KW)	0
		Electricity Sold to Grid (KW)	55
Maximum Yields Based on Feedstock Carbon Content		Steam Plant + Turboexpander Power Generated (hp)	86,377
Theoretical Ethanol Production (MM Gal / Year)	159.0	Used for Main Compressors (hp)	63,374
Theoretical Ethanol Yield (Gal / Dry Ton)	205.9	Other Electrical Consumption (hp)	23,003
Current Ethanol Yield (Actual / Theoretical)	40.7%		
		Plant Electricity Use (KWh / Gal EtOH)	8.36
Gasifier Efficiency - HHV %	74.3	Gasification & Reforming Steam Use (lb / Gal EtOH)	8.68
Gasifier Efficiency - LHV %	73.9		
Overall Plant Efficiency - HHV %	46.5	Specific Operating Conditions	
Overall Plant Efficiency - LHV %	44.9	Feed Rate	Dry Tonnes / Day 2,000
			Dry Tons / Day 2,205
Plant Operating Hours per Year	8,410	Feedstock Cost	\$ / Dry Ton \$61.57
On-Stream Percentage	96.0%		\$ / Moisture & Ash Free Ton \$62.14
Excel File:	R236H-V29.xls		

Discounted Cash Flow Rate of Return Worksheet

Year		-2	-1	0	1	2	3	4	5	6	7	8
Fixed Capital Investment		\$17,281,753	\$117,538,146	\$62,687,011								
Working Capital		\$0	\$0	\$24,487,114								
Loan Payment		\$0	\$0	\$0	\$43,791,624	\$43,791,624	\$43,791,624	\$43,791,624	\$43,791,624	\$43,791,624	\$43,791,624	\$43,791,624
Loan Interest Payment		\$1,880,610	\$15,985,188	\$23,507,629	\$23,507,629	\$21,884,910	\$20,132,372	\$18,239,632	\$16,195,473	\$13,987,781	\$11,603,473	\$9,028,421
Loan Principal		\$23,507,629	\$199,814,848	\$293,845,365	\$273,561,369	\$251,654,654	\$227,995,402	\$202,443,410	\$174,847,258	\$145,043,415	\$112,855,263	\$78,092,060
Ethanol Sales					\$115,930,257	\$132,491,722	\$132,491,722	\$132,491,722	\$132,491,722	\$132,491,722	\$132,491,722	\$132,491,722
By-Product Credit					\$13,455,987	\$15,378,271	\$15,378,271	\$15,378,271	\$15,378,271	\$15,378,271	\$15,378,271	\$15,378,271
Total Annual Sales					\$129,386,244	\$147,869,993	\$147,869,993	\$147,869,993	\$147,869,993	\$147,869,993	\$147,869,993	\$147,869,993
Annual Manufacturing Cost												
Raw Materials					\$44,590,082	\$47,562,754	\$47,562,754	\$47,562,754	\$47,562,754	\$47,562,754	\$47,562,754	\$47,562,754
Tar reforming catalysts					\$3,586,607	\$0	\$0	\$0	\$0	\$0	\$0	\$0
Mixed Alcohol Catalysts					\$10,212,364	\$0	\$8,866,301	\$0	\$8,866,301	\$0	\$8,866,301	\$0
Other Variable Costs					\$3,148,499	\$3,323,101	\$3,323,101	\$3,323,101	\$3,323,101	\$3,323,101	\$3,323,101	\$3,323,101
Fixed Operating Costs					\$23,239,064	\$23,239,064	\$23,239,064	\$23,239,064	\$23,239,064	\$23,239,064	\$23,239,064	\$23,239,064
Total Product Cost					\$84,776,616	\$74,124,919	\$82,991,220	\$74,124,919	\$82,991,220	\$74,124,919	\$82,991,220	\$74,124,919
Annual Depreciation												
Total Plant MACRS Schedule					14.29%	24.49%	17.49%	12.49%	8.93%	8.92%	8.93%	4.46%
Depreciation					\$69,984,171	\$119,937,883	\$85,655,924	\$61,168,810	\$43,733,985	\$43,685,011	\$43,733,985	\$21,842,505
Net Revenue					(\$48,882,173)	(\$68,077,719)	(\$40,909,524)	(\$5,663,369)	\$4,949,315	\$16,072,282	\$9,541,314	\$42,874,147
Losses Forward					\$0	(\$48,882,173)	(\$116,959,892)	(\$157,869,415)	(\$163,532,784)	(\$158,583,469)	(\$142,511,187)	(\$132,969,873)
Taxable Income					(\$48,882,173)	(\$116,959,892)	(\$157,869,415)	(\$163,532,784)	(\$158,583,469)	(\$142,511,187)	(\$132,969,873)	(\$90,095,725)
Income Tax					\$0	\$0	\$0	\$0	\$0	\$0	\$0	\$0
Annual Cash Income					\$818,003	\$29,953,449	\$21,087,148	\$29,953,449	\$21,087,148	\$29,953,449	\$21,087,148	\$29,953,449
Discount Factor		1.210	1.100	1.000	0.909	0.826	0.751	0.683	0.621	0.564	0.513	0.467
Annual Present Value	\$279,248,292				\$743,639	\$24,754,917	\$15,843,086	\$20,458,609	\$13,093,460	\$16,907,941	\$10,821,041	\$13,973,505
Total Capital Investment + Interest		\$23,186,459	\$146,875,667	\$110,681,754								
Net Present Worth				\$0								

Discounted Cash Flow Rate of Return Worksheet

Year	9	10	11	12	13	14	15	16	17	18	19	20
Fixed Capital Investment												
Working Capital												
Loan Payment	\$43,791,624	\$43,791,624	\$0	\$0	\$0	\$0	\$0	\$0	\$0	\$0	\$0	\$0
Loan Interest Payment	\$6,247,365	\$3,243,824	\$0	\$0	\$0	\$0	\$0	\$0	\$0	\$0	\$0	\$0
Loan Principal	\$40,547,800	\$0	\$0	\$0	\$0	\$0	\$0	\$0	\$0	\$0	\$0	\$0
Ethanol Sales	\$132,491,722	\$132,491,722	\$132,491,722	\$132,491,722	\$132,491,722	\$132,491,722	\$132,491,722	\$132,491,722	\$132,491,722	\$132,491,722	\$132,491,722	\$132,491,722
By-Product Credit	\$15,378,271	\$15,378,271	\$15,378,271	\$15,378,271	\$15,378,271	\$15,378,271	\$15,378,271	\$15,378,271	\$15,378,271	\$15,378,271	\$15,378,271	\$15,378,271
Total Annual Sales	\$147,869,993	\$147,869,993	\$147,869,993	\$147,869,993	\$147,869,993	\$147,869,993	\$147,869,993	\$147,869,993	\$147,869,993	\$147,869,993	\$147,869,993	\$147,869,993
Annual Manufacturing Cost												
Raw Materials	\$47,562,754	\$47,562,754	\$47,562,754	\$47,562,754	\$47,562,754	\$47,562,754	\$47,562,754	\$47,562,754	\$47,562,754	\$47,562,754	\$47,562,754	\$47,562,754
Tar reforming catalysts	\$0	\$0	\$0	\$0	\$0	\$0	\$0	\$0	\$0	\$0	\$0	\$0
Mixed Alcohol Catalysts	\$8,866,301	\$0	\$8,866,301	\$0	\$8,866,301	\$0	\$8,866,301	\$0	\$8,866,301	\$0	\$8,866,301	\$0
Other Variable Costs	\$3,323,101	\$3,323,101	\$3,323,101	\$3,323,101	\$3,323,101	\$3,323,101	\$3,323,101	\$3,323,101	\$3,323,101	\$3,323,101	\$3,323,101	\$3,323,101
Fixed Operating Costs	\$23,239,064	\$23,239,064	\$23,239,064	\$23,239,064	\$23,239,064	\$23,239,064	\$23,239,064	\$23,239,064	\$23,239,064	\$23,239,064	\$23,239,064	\$23,239,064
Total Product Cost	\$82,991,220	\$74,124,919	\$82,991,220	\$74,124,919	\$82,991,220	\$74,124,919	\$82,991,220	\$74,124,919	\$82,991,220	\$74,124,919	\$82,991,220	\$74,124,919
Annual Depreciation												
Total Plant MACRS Schedule	0.00%	0.00%	0.00%	0.00%	0.00%	0.00%	0.00%	0.00%	0.00%	0.00%	0.00%	0.00%
Depreciation	\$0	\$0	\$0	\$0	\$0	\$0	\$0	\$0	\$0	\$0	\$0	\$0
Net Revenue	\$58,631,408	\$70,501,250	\$64,878,773	\$73,745,074	\$64,878,773	\$73,745,074	\$64,878,773	\$73,745,074	\$64,878,773	\$73,745,074	\$64,878,773	\$73,745,074
Losses Forward	(\$90,095,725)	(\$31,464,318)	\$0	\$0	\$0	\$0	\$0	\$0	\$0	\$0	\$0	\$0
Taxable Income	(\$31,464,318)	\$39,036,932	\$64,878,773	\$73,745,074	\$64,878,773	\$73,745,074	\$64,878,773	\$73,745,074	\$64,878,773	\$73,745,074	\$64,878,773	\$73,745,074
Income Tax	\$0	\$13,662,926	\$22,707,570	\$25,810,776	\$22,707,570	\$25,810,776	\$22,707,570	\$25,810,776	\$22,707,570	\$25,810,776	\$22,707,570	\$25,810,776
Annual Cash Income	\$21,087,148	\$16,290,523	\$42,171,202	\$47,934,298	\$42,171,202	\$47,934,298	\$42,171,202	\$47,934,298	\$42,171,202	\$47,934,298	\$42,171,202	\$47,934,298
Discount Factor	0.424	0.386	0.350	0.319	0.290	0.263	0.239	0.218	0.198	0.180	0.164	0.149
Annual Present Value	\$8,943,009	\$6,280,702	\$14,780,749	\$15,273,345	\$12,215,495	\$12,622,599	\$10,095,451	\$10,431,900	\$8,343,348	\$8,621,405	\$6,895,329	\$7,125,128
Total Capital Investment + Interest												
Net Present Worth												

Discounted Cash Flow Rate of Return Worksheet

Year	21	22	23	24	25	26	27	28	29	30
Fixed Capital Investment										
Working Capital										(\$26,097,114)
Loan Payment	\$0	\$0	\$0	\$0	\$0	\$0	\$0	\$0	\$0	\$0
Loan Interest Payment	\$0	\$0	\$0	\$0	\$0	\$0	\$0	\$0	\$0	\$0
Loan Principal	\$0	\$0	\$0	\$0	\$0	\$0	\$0	\$0	\$0	\$0
Ethanol Sales	\$132,491,722	\$132,491,722	\$132,491,722	\$132,491,722	\$132,491,722	\$132,491,722	\$132,491,722	\$132,491,722	\$132,491,722	\$132,491,722
By-Product Credit	\$15,378,271	\$15,378,271	\$15,378,271	\$15,378,271	\$15,378,271	\$15,378,271	\$15,378,271	\$15,378,271	\$15,378,271	\$15,378,271
Total Annual Sales	\$147,869,993	\$147,869,993	\$147,869,993	\$147,869,993	\$147,869,993	\$147,869,993	\$147,869,993	\$147,869,993	\$147,869,993	\$147,869,993
Annual Manufacturing Cost										
Raw Materials	\$47,562,754	\$47,562,754	\$47,562,754	\$47,562,754	\$47,562,754	\$47,562,754	\$47,562,754	\$47,562,754	\$47,562,754	\$47,562,754
Tar reforming catalysts	\$0	\$0	\$0	\$0	\$0	\$0	\$0	\$0	\$0	\$0
Mixed Alcohol Catalysts	\$8,866,301	\$0	\$8,866,301	\$0	\$8,866,301	\$0	\$8,866,301	\$0	\$8,866,301	\$0
Other Variable Costs	\$3,323,101	\$3,323,101	\$3,323,101	\$3,323,101	\$3,323,101	\$3,323,101	\$3,323,101	\$3,323,101	\$3,323,101	\$3,323,101
Fixed Operating Costs	\$23,239,064	\$23,239,064	\$23,239,064	\$23,239,064	\$23,239,064	\$23,239,064	\$23,239,064	\$23,239,064	\$23,239,064	\$23,239,064
Total Product Cost	\$82,991,220	\$74,124,919	\$82,991,220	\$74,124,919	\$82,991,220	\$74,124,919	\$82,991,220	\$74,124,919	\$82,991,220	\$74,124,919
Annual Depreciation										
Total Plant MACRS Schedule	0.00%	0.00%	0.00%	0.00%	0.00%	0.00%	0.00%	0.00%	0.00%	0.00%
Depreciation	\$0	\$0	\$0	\$0	\$0	\$0	\$0	\$0	\$0	\$0
Net Revenue	\$64,878,773	\$73,745,074	\$64,878,773	\$73,745,074	\$64,878,773	\$73,745,074	\$64,878,773	\$73,745,074	\$64,878,773	\$73,745,074
Losses Forward	\$0	\$0	\$0	\$0	\$0	\$0	\$0	\$0	\$0	\$0
Taxable Income	\$64,878,773	\$73,745,074	\$64,878,773	\$73,745,074	\$64,878,773	\$73,745,074	\$64,878,773	\$73,745,074	\$64,878,773	\$73,745,074
Income Tax	\$22,707,570	\$25,810,776	\$22,707,570	\$25,810,776	\$22,707,570	\$25,810,776	\$22,707,570	\$25,810,776	\$22,707,570	\$25,810,776
Annual Cash Income	\$42,171,202	\$47,934,298	\$42,171,202	\$47,934,298	\$42,171,202	\$47,934,298	\$42,171,202	\$47,934,298	\$42,171,202	\$47,934,298
Discount Factor	0.135	0.123	0.112	0.102	0.092	0.084	0.076	0.069	0.063	0.057
Annual Present Value	\$5,698,619	\$5,888,535	\$4,709,602	\$4,866,558	\$3,892,233	\$4,021,949	\$3,216,722	\$3,323,925	\$2,658,448	\$2,747,045
Total Capital Investment + Interest										(\$1,495,588)
Net Present Worth										

Base Case Operating Cost Summary

Costing Code	Raw Material	Stream Number	kg / Hr (or kW)	lb / Hr (or HP)	Quoted Price (Cents / Ton or Cents / kWh)	Year of Price Quote	2007 Cost (Cents / Ton)	2007 Cost (\$ / lb)	2007 Cost (\$ / Hr)	2007 Cost (MM\$ / Year)	2007 Cost (Cents / Gal)
--------------	--------------	---------------	--------------------	--------------------	---	------------------------	----------------------------	------------------------	------------------------	----------------------------	----------------------------

Variable Operating Costs											
Feedstock, Catalyst & Chemicals											
F-3	Feedstock - Wood Chips	STRM.100	119,048	262,455	4,310	2007	4,310	0.022	5,655.77	47.563	73.50
P-2	Electricity	WORK.WNET	(47.64)	(63.89)	5.85	2007			(2.79)	(0.02)	(0.04)
R-12	Magnesium Oxide (MgO)	STRM.220	3.2	7.0	36,500	2004	42,942	0.215	1.50	0.013	0.02
R-13	Fresh Olivine	STRM.221	243.8	537.6	17,290	2004	20,342	0.102	54.68	0.460	0.71
R-14	Tar Reformer Catalyst	STRM.A300.A300TR.326	5.4	12.0	3,528,850	2007	3,528,850	17.644	211.73	1.781	2.75
S-20	50 wt% Caustic	Calc'd on SO2 in Flue Gas	18.1	40.0	15,000	2010	13,038	0.065	2.61	0.022	0.03
S-21	Boiler Chemicals	STRM.635	1.5	3.3	280,000	1991	453,217	2.266	7.56	0.064	0.10
S-22	Cooling Tower Chemicals	STRM.711	0.5	1.2	200,000	1999	271,610	1.358	1.59	0.013	0.02
S-23	Natural Gas for Reformer		0.0	0.1	30,177	2007	30,177	0.151	0.02	0.000	0.00
S-24	Cooling Tower Makeup	STRM.710	41,311	91,076	19.96	2001	26	0.000	11.66	0.098	0.15
S-25	Boiler Feed Water Makeup	STRM.618	34,631	76,348	19.96	2001	26	0.000	9.78	0.082	0.13
S-26	Natural Gas for Gasifier	STRM.206	0.0	0.0	30,177	2007	30,177	0.151	0.00	0.000	0.00
S-27	Diesel Fuel	Assumed rate of 10 gal / hr	32.2	70.9	80,589	2007	80,589	0.403	28.56	0.240	0.37
S-28	LO-CAT Chemicals	STRM.A400.SELEXOL.424			160,150	2009	Annual cost scaled on sulfur produced			0.061	0.09
S-31	DEPG Make-Up	STRM.A400.SELEXOL.CO2-H2S			26,702	2004	Annual cost scaled on CO2 + H2S removed			0.034	0.05
S-32	Amine Make-Up	STRM.A400.SELEXOL.CO2-H2S			8,000	2010	Annual cost scaled on CO2 + H2S removed			0.007	0.01
Subtotal									5,982.66	50.414	77.91
Waste Streams											
W-1	Sand and Ash Purge	STRM.219	1,101	2,428	3,266	1998	4,465	0.022	54.20	0.456	0.70
W-2	Tar Reformer Catalyst Disposal		5.4	12.0	3,266	1998	4,465	0.022	0.27	0.002	0.00
W-3	WWT Cost	STRM.305	13,129	28,945	48.08	2001	62	0.000	8.93	0.075	0.12
Subtotal									63.40	0.533	0.82
Co-Product Credits											
	Mixed Alcohol	STRM.590	2,925	6,448	56,722	2007	56,722	0.284	1,828.66	15.378	23.77
Subtotal									1,828.66	15.378	23.77
Total Variable Operating Costs									4,217.41	35.569	54.97

Fixed Operating Costs											
			2007 Salary	# Positions	2007 Cost	2007 Hourly Wage					
	Plant Manager		\$147,000	1	\$147,000	\$70.67					
	Plant Engineer		\$70,000	1	\$70,000	\$33.65					
	Maintenance Supr		\$57,000	1	\$57,000	\$27.40					
	Lab Manager		\$56,000	1	\$56,000	\$26.92					
	Shift Supervisor		\$48,000	5	\$240,000	\$23.08					
	Lab Technician		\$40,000	2	\$80,000	\$19.23					
	Maintenance Tech		\$40,000	16	\$640,000	\$19.23					
	Shift Operators		\$48,000	20	\$960,000	\$23.08					
	Yard Employees		\$28,000	12	\$336,000	\$13.46					
	Clerks & Secretaries		\$36,000	3	\$108,000	\$17.31					
Total Salaries				62	\$2,694,000				2.694	4.16	
						Avg Salary (w/ Benefits)					
	Overhead and Benefits	% of Labor & Supervision =	90.0%		\$2,424,600	\$39.69 per Hour			2.425	3.75	
	Maintenance	% of FCI =	3.0%		\$14,694,771	\$82,558 per Year			14.695	22.71	
	Insurance & Taxes	% of FCI =	0.7%		\$3,428,780				3.429	5.30	
Total Fixed Operating Costs									23.242	35.92	

Total Operating Costs									58.811	90.89	
------------------------------	--	--	--	--	--	--	--	--	---------------	--------------	--

Optimized Water Consumption Case Operating Cost Summary

Costing Code	Raw Material	Stream Number	kg / Hr (or kW)	lb / Hr (or HP)	Quoted Price (Cents / Ton or Cents / kWh)	Year of Price Quote	2007 Cost (Cents / Ton)	2007 Cost (\$ / lb)	2007 Cost (\$ / Hr)	2007 Cost (MM\$ / Year)	2007 Cost (Cents / Gal)
Variable Operating Costs											
Feedstock, Catalyst & Chemicals											
F-3	Feedstock - Wood Chips	STRM.100	119,048	262,455	4,310	2007	4,310	0.022	5,655.77	47.563	73.50
P-2	Electricity	WORK.WNET	(55.36)	(74.24)	5.85	2007			(3.24)	(0.03)	(0.04)
R-12	Magnesium Oxide (MgO)	STRM.220	3.2	7.0	36,500	2004	42,942	0.215	1.50	0.013	0.02
R-13	Fresh Olivine	STRM.221	243.8	537.6	17,290	2004	20,342	0.102	54.68	0.460	0.71
R-14	Tar Reformer Catalyst	STRM.A300.A300TR.326	5.4	12.0	3,528,850	2007	3,528,850	17.644	211.73	1.781	2.75
S-20	50 wt% Caustic	Calc'd on SO2 in Flue Gas	18.1	40.0	15,000	2010	13,038	0.065	2.61	0.022	0.03
S-21	Boiler Chemicals	STRM.635	1.5	3.3	280,000	1991	453,217	2.266	7.56	0.064	0.10
S-22	Cooling Tower Chemicals	STRM.711	0.5	1.2	200,000	1999	271,610	1.358	1.59	0.013	0.02
S-23	Natural Gas for Reformer		0.0	0.1	30,177	2007	30,177	0.151	0.02	0.000	0.00
S-24	Cooling Tower Makeup	STRM.710	10,918	24,070	19.96	2001	26	0.000	3.08	0.026	0.04
S-25	Boiler Feed Water Makeup	STRM.618	46,175	101,798	19.96	2001	26	0.000	13.04	0.110	0.17
S-26	Natural Gas for Gasifier	STRM.206	0.0	0.0	30,177	2007	30,177	0.151	0.00	0.000	0.00
S-27	Diesel Fuel	Assumed rate of 10 gal / hr	32.2	70.9	80,589	2007	80,589	0.403	28.56	0.240	0.37
S-28	LO-CAT Chemicals	STRM.A400.SELEXOL.424			160,150	2009	Annual cost scaled on sulfur produced			0.061	0.09
S-31	DEPG Make-Up	STRM.A400.SELEXOL.CO2-H2S			26,702	2004	Annual cost scaled on CO2 + H2S removed			0.034	0.05
S-32	Amine Make-Up	STRM.A400.SELEXOL.CO2-H2S			8,000	2010	Annual cost scaled on CO2 + H2S removed			0.007	0.01
Subtotal									5,976.89	50.365	77.83
Waste Streams											
W-1	Sand and Ash Purge	STRM.219	1,101	2,428	3,266	1998	4,465	0.022	54.20	0.456	0.70
W-1A	Scrubber Solids	STRM.H2O-MGMT.SCRB-SLD	101	224	3,266	1998	4,465	0.022	4.99	0.042	0.06
W-2	Tar Reformer Catalyst Disposal		5.4	12.0	3,266	1998	4,465	0.022	0.27	0.002	0.00
W-3	WWT Cost	STRM.H2O-MGMT.ROBRNWST	3,607	7,953	48.08	2001	62	0.000	2.45	0.021	0.03
Subtotal									61.92	0.521	0.80
Co-Product Credits											
	Mixed Alcohol	STRM.590	2,925	6,448	56,722	2007	56,722	0.284	1,828.66	15.378	23.77
Subtotal									1,828.66	15.378	23.77
Total Variable Operating Costs									4,210.15	35.508	54.87
Fixed Operating Costs											
			2007 Salary	# Positions	2007 Cost		2007 Hourly Wage				
	Plant Manager		\$147,000	1	\$147,000		\$70.67				
	Plant Engineer		\$70,000	1	\$70,000		\$33.65				
	Maintenance Supr		\$57,000	1	\$57,000		\$27.40				
	Lab Manager		\$56,000	1	\$56,000		\$26.92				
	Shift Supervisor		\$48,000	5	\$240,000		\$23.08				
	Lab Technician		\$40,000	2	\$80,000		\$19.23				
	Maintenance Tech		\$40,000	16	\$640,000		\$19.23				
	Shift Operators		\$48,000	20	\$960,000		\$23.08				
	Yard Employees		\$28,000	12	\$336,000		\$13.46				
	Clerks & Secretaries		\$36,000	3	\$108,000		\$17.31				
Total Salaries				62	\$2,694,000					2.694	4.16
							Avg Salary (w/ Benefits)				
	Overhead and Benefits	% of Labor & Supervision =	90.0%		\$2,424,600		\$39.69 per Hour			2.425	3.75
	Maintenance	% of FCI =	3.0%		\$14,692,268		\$82,558 per Year			14.692	22.71
	Insurance & Taxes	% of FCI =	0.7%		\$3,428,196					3.428	5.30
Total Fixed Operating Costs									23.239	35.91	
Total Operating Costs									58.747	90.79	

Appendix D. Process Parameters and Operation Summary

Base Case Process Parameters and Operation Summary

Energy Efficiencies		Tar Reformer		Alcohol Synthesis		Alcohol Synthesis		Alcohol Separation	
Gasifier Efficiency - HHV %	74.3	Inlet Molar Flow (MMscf/hr)	6.72	Syngas from Conditioning	315,330	Relative Alcohol Distribution After Reactor		Upstream of LP Separator Valve	
Gasifier Efficiency - LHV %	73.9	Space Velocity (hr-1)	2,476	Unreacted Syngas Recycle	709,768	Methanol	61.6%	Temperature (°F)	110.0
Overall Plant Efficiency - HHV %	46.5	Reactor Volume (ft³)	2,713	Recycled Methanol from Mol Sieve	44,966	Ethanol	35.6%	Pressure (psia)	2936.8
Overall Plant Efficiency - LHV %	44.9	Catalyst Replacement (%inventory/day)	0.10%	Recycled Methanol and H2S	7,749	Propanol	2.8%		
		Inlet:		Total	1,077,813	Butanol	0.0%	LP Separator	
		Temperature (°F)	1,632			Pentanol +	0.0%	Temperature (°F)	66.8
Dryer		Carbon as CO (mol%)	31.8%	Conditioned Syngas H2:CO Ratio	1.25			Pressure (psia)	60.0
Inlet:		Carbon as tar (ppmv)	8,089	Recycled Gas H2:CO Ratio	1.67	Flash Separator			
Temperature (°F)	60.0	H2:CO Ratio (mole)	0.86			Temperature (°F)	110	LP Separator Recoveries (Liquid)	
Moisture Content (wt%)	30.0%	Reformer Conversions:		<i>At Reactor Inlet</i>		Pressure (psia)	2,937	Methanol	99.3%
Outlet:		CO2 --> CO	24.6%	Temperature (°F)	595			Ethanol	99.7%
Temperature (°F)	219.7	Methane --> CO	80.0%	Pressure (psia)	2,995	Relative Alcohol Distribution After Flash Tank		Propanol	99.9%
Moisture Content (wt%)	10.0%	Ethane --> CO	99.0%	H2:CO Molar Ratio	1.50	Methanol	61.3%	Butanol	100.0%
Inlet Flue Gas (°F)	539	Ethylene --> CO	90.0%	CO2 (mol %)	14.0%	Ethanol	35.8%	Pentanol +	
Outlet Flue Gas (°F)	167.9	Benzene --> CO	100.0%	Methane (mol%)	7.7%	Propanol	2.8%	Water	99.9%
Dew Point Flue Gas (°F)	152.8	Tar --> CO	99.5%	H2O (wt%)	0.04%	Butanol	0.0%		
Difference	15.1	Ammonia --> CO	100.0%	Methanol (mol%)	2.6%	Pentanol +	0.0%	Mole Sieve Methanol Recycle (mol%)	
				Inlet Molar Flow (MMscf/hr)	23.2			H2O	0.0%
Gasifier		Outlet:		Space Velocity (hr-1)	5,000	Vapor Losses From Flash Tank		Methanol	99.4%
Temperature (°F)	1,596	Temperature (°F)	1,670	Reactor Volume (ft³)	4,365	Methanol	2.1%	Ethanol	0.6%
Pressure (psia)	33.0	Carbon as CO (mol%)	73.7%	Reactor Length (feet)	60	Ethanol	1.0%	Propanol	0.0%
H2:CO Molar Ratio After Gasifier	0.56	Carbon as tar (ppmv)	82.1	No of Tubes	9,579	Propanol	0.4%	Butanol	0.0%
Methane (vol%)	8.3%	H2:CO Ratio (mole)	1.25	Catalyst Density (lb/ft3)	75	Butanol	0.1%	Pentanol +	0.0%
Benzene (vol%)	0.07%	Methane (vol%)	1.5%			Pentanol +			
Tar (wt%)	0.89%	Benzene (ppmv)	0.0	CO Conversion - Overall	78.5%			Relative C3+ Alcohol Distribution	
Tar (g/Nm³)	9.6	Tars (ppmv)	3.6	CO Conversion - Singlepass	28.7%	Cleaned Gas Recycled to Reactor	88.5%	Methanol	0.0%
Char (wt%)	14.3%	Tars (g/Nm³)	0.02	Conversion To:				Ethanol	11.3%
H2S (ppm)	138.7	H2S (ppm)	92.6	CO2	8.9%	Sulfur (H2S) at Reactor Inlet (spec) ppmv	70.0	Propanol	88.6%
Residual Heat (MBtu/hr)	29,379	NH3 (ppm)	0.0	Methane	3.5%			Butanol	0.1%
Raw Dry Syngas Yield (lb/lb dry feed)	0.78	Methane (mole% dry basis)	1.8%	Ethane	0.2%			Pentanol +	0.0%
		Quench		Methanol	2.0%	Residual Syngas			
Char Combustor		Benzene (ppmv)	3.0	Ethanol	12.3%	Recycled to synthesis reactors (lb/hr)	709,768	Ethanol Recoveries:	
Temperature (°F)	1,808	Tars (ppmv)	3.2	Propanol	1.5%	To Tar Reformers (lb/hr)	145,046	Initial flash tank	99.0%
Pressure (psia)	29.0	Tars (g/Nm³)	0.01	Butanol	0.0%	To Fuel System (lb/hr)	36,261	LP Separator	99.7%
Ratio Actual:Minimum air for combustion	1.20	H2S (ppm)	114.2	Pentanol +	0.0%	To Reformer for Process (lb/hr)	108,784	C2OH/C3OH Splitter	99.0%
Residual Heat (MBtu/hr)	-0.1	NH3 (ppm)	57.1	Total	28.5%			Final MeOH Stripper	99.0%
								Overall	96.7%
Syngas Usage		Acid Gas Removal		Selectivity (CO2 Free)					
To Reformer (lb/hr)	236,707	Inlet:		Alcohols	80.8%	Electricity			
To Char Combustor (lb/hr)	0	CO2 (mol/hr)	9,386	Hydrocarbons	19.2%	Electricity Produced (kWh)	541,655,443		
To Fuel System (lb/hr)	9,080	CO2 (mol%)	19.1%	Ethanol	63.1%	Electricity Produced (kWh/gallon EtOH)	8.37		
		H2S (mol/hr)	2.9	<i>At Reactor Outlet</i>		Electricity Used (kWh)	541,254,810		
Fuel System		H2S (ppmv)	59.0	Temperature (°F)	611	Electricity Used (kWh/gallon)	8.36		
Additional fuel (lb/hr)	0	Outlet:		Pressure (psia)	2,953				
Raw Syngas (lb/hr)	9,080	CO2 (mol/hr)	7,243	CO2 (mol%)	18.9%	Water Usage			
Unconverted Syngas (lb/hr)	36,261	CO2 (mol%)	15.7%	Methane (mol%)	10.0%	Boiler Feed Water Makeup (MM lb/yr)	642		
		Fraction CO2 removed	22.8%	H2O (wt%)	0.67%	Cooling Water Makeup (MM lb/yr)	766		
Into Reformer (°F)	3,403	H2S (mol/hr)	0.3			Total Makeup Water (MM gal/yr)	169		
Out of Reformer (°F)	1,777	H2S (ppmv)	6.0	Total Alcohol Productivity (kg/kg/hr)	0.368	Water Usage (gal/gal ETOH)	2.61		
		Fraction H2S removed	99.5%	Total Ethanol Productivity (kg/kg/hr)	0.160				

Optimized Water Consumption Case Process Parameters and Operation Summary

Energy Efficiencies		Tar Reformer		Alcohol Synthesis		Alcohol Synthesis		Alcohol Separation	
Gasifier Efficiency - HHV %	74.3	Inlet Molar Flow (MMscf/hr)	6.72	Syngas from Conditioning	315,330	Relative Alcohol Distribution After Reactor		Upstream of LP Separator Valve	
Gasifier Efficiency - LHV %	73.9	Space Velocity (hr-1)	2,476	Unreacted Syngas Recycle	709,768	Methanol	61.6%	Temperature (°F)	110.0
Overall Plant Efficiency - HHV %	46.5	Reactor Volume (ft³)	2,713	Recycled Methanol from Mol Sieve	44,966	Ethanol	35.6%	Pressure (psia)	2936.8
Overall Plant Efficiency - LHV %	44.9	Catalyst Replacement (%inventory/day)	0.10%	Recycled Methanol and H2S	7,749	Propanol	2.8%		
		Inlet:		Total	1,077,813	Butanol	0.0%	LP Separator	
		Temperature (°F)	1,632			Pentanol +	0.0%	Temperature (°F)	66.8
Dryer		Carbon as CO (mol%)	31.8%	Conditioned Syngas H2:CO Ratio	1.25			Pressure (psia)	60.0
Inlet:		Carbon as tar (ppmv)	8,089	Recycled Gas H2:CO Ratio	1.67	Flash Separator			
Temperature (°F)	60.0	H2:CO Ratio (mole)	0.86			Temperature (°F)	110	LP Separator Recoveries (Liquid)	
Moisture Content (wt%)	30.0%	Reformer Conversions:		<i>At Reactor Inlet</i>		Pressure (psia)	2,937	Methanol	99.3%
Outlet:		CO2 --> CO	24.6%	Temperature (°F)	595			Ethanol	99.7%
Temperature (°F)	219.7	Methane --> CO	80.0%	Pressure (psia)	2,995	Relative Alcohol Distribution After Flash Tank		Propanol	99.9%
Moisture Content (wt%)	10.0%	Ethane --> CO	99.0%	H2:CO Molar Ratio	1.50	Methanol	61.3%	Butanol	100.0%
Inlet Flue Gas (°F)	539	Ethylene --> CO	90.0%	CO2 (mol %)	14.0%	Ethanol	35.8%	Pentanol +	
Outlet Flue Gas (°F)	167.9	Benzene --> CO	100.0%	Methane (mol%)	7.7%	Propanol	2.8%	Water	99.9%
Dew Point Flue Gas (°F)	152.8	Tar --> CO	99.5%	H2O (wt%)	0.04%	Butanol	0.0%		
Difference	15.1	Ammonia --> CO	100.0%	Methanol (mol%)	2.6%	Pentanol +	0.0%	Mole Sieve Methanol Recycle (mol%)	
				Inlet Molar Flow (MMscf/hr)	23.2			H2O	0.0%
Gasifier		Outlet:		Space Velocity (hr-1)	5,000	Vapor Losses From Flash Tank		Methanol	99.4%
Temperature (°F)	1,596	Temperature (°F)	1,670	Reactor Volume (ft³)	4,365	Methanol	2.1%	Ethanol	0.6%
Pressure (psia)	33.0	Carbon as CO (mol%)	73.7%	Reactor Length (feet)	60	Ethanol	1.0%	Propanol	0.0%
H2:CO Molar Ratio After Gasifier	0.56	Carbon as tar (ppmv)	82.1	No of Tubes	9,579	Propanol	0.4%	Butanol	0.0%
Methane (vol%)	8.3%	H2:CO Ratio (mole)	1.25	Catalyst Density (lb/ft3)	75	Butanol	0.1%	Pentanol +	0.0%
Benzene (vol%)	0.07%	Methane (vol%)	1.5%			Pentanol +			
Tar (wt%)	0.89%	Benzene (ppmv)	0.0	CO Conversion - Overall	78.5%			Relative C3+ Alcohol Distribution	
Tar (g/Nm³)	9.6	Tars (ppmv)	3.6	CO Conversion - Singlepass	28.7%	Cleaned Gas Recycled to Reactor	88.5%	Methanol	0.0%
Char (wt%)	14.3%	Tars (g/Nm³)	0.02	Conversion To:				Ethanol	11.3%
H2S (ppm)	138.7	H2S (ppm)	92.6	CO2	8.9%	Sulfur (H2S) at Reactor Inlet (spec) ppmv	70.0	Propanol	88.6%
Residual Heat (MBtu/hr)	29,379	NH3 (ppm)	0.0	Methane	3.5%			Butanol	0.1%
Raw Dry Syngas Yield (lb/lb dry feed)	0.78	Methane (mole% dry basis)	1.8%	Ethane	0.2%			Pentanol +	0.0%
		Quench		Methanol	2.0%	Residual Syngas			
Char Combustor		Benzene (ppmv)	3.0	Ethanol	12.3%	Recycled to synthesis reactors (lb/hr)	709,768	Ethanol Recoveries:	
Temperature (°F)	1,808	Tars (ppmv)	3.2	Propanol	1.5%	To Tar Reformers (lb/hr)	145,046	Initial flash tank	99.0%
Pressure (psia)	29.0	Tars (g/Nm³)	0.01	Butanol	0.0%	To Fuel System (lb/hr)	36,261	LP Separator	99.7%
Ratio Actual:Minimum air for combustion	1.20	H2S (ppm)	114.2	Pentanol +	0.0%	To Reformer for Process (lb/hr)	108,784	C2OH/C3OH Splitter	99.0%
Residual Heat (MBtu/hr)	-0.1	NH3 (ppm)	57.1	Total	28.5%			Final MeOH Stripper	99.0%
								Overall	96.7%
Syngas Usage		Acid Gas Removal		Selectivity (CO2 Free)					
To Reformer (lb/hr)	236,707	Inlet:		Alcohols	80.8%	Electricity			
To Char Combustor (lb/hr)	0	CO2 (mol/hr)	9,386	Hydrocarbons	19.2%	Electricity Produced (kWh)	541,672,459		
To Fuel System (lb/hr)	9,080	CO2 (mol%)	19.1%	Ethanol	63.1%	Electricity Produced (kWh/gallon EtOH)	8.37		
		H2S (mol/hr)	2.9	<i>At Reactor Outlet</i>		Electricity Used (kWh)	541,206,899		
Fuel System		H2S (ppmv)	59.0	Temperature (°F)	611	Electricity Used (kWh/gallon)	8.36		
Additional fuel (lb/hr)	0	Outlet:		Pressure (psia)	2,953				
Raw Syngas (lb/hr)	9,080	CO2 (mol/hr)	7,243	CO2 (mol%)	18.9%	Water Usage			
Unconverted Syngas (lb/hr)	36,261	CO2 (mol%)	15.7%	Methane (mol%)	10.0%	Boiler Feed Water Makeup (MM lb/yr)	856		
		Fraction CO2 removed	22.8%	H2O (wt%)	0.67%	Cooling Water Makeup (MM lb/yr)	202		
Into Reformer (°F)	3,403	H2S (mol/hr)	0.3			Total Makeup Water (MM gal/yr)	127		
Out of Reformer (°F)	1,777	H2S (ppmv)	6.0	Total Alcohol Productivity (kg/kg/hr)	0.368	Water Usage (gal/gal ETOH)	1.97		
		Fraction H2S removed	99.5%	Total Ethanol Productivity (kg/kg/hr)	0.160				

Appendix E. Process Flow Diagrams (PFDs) and Material and Energy Balances

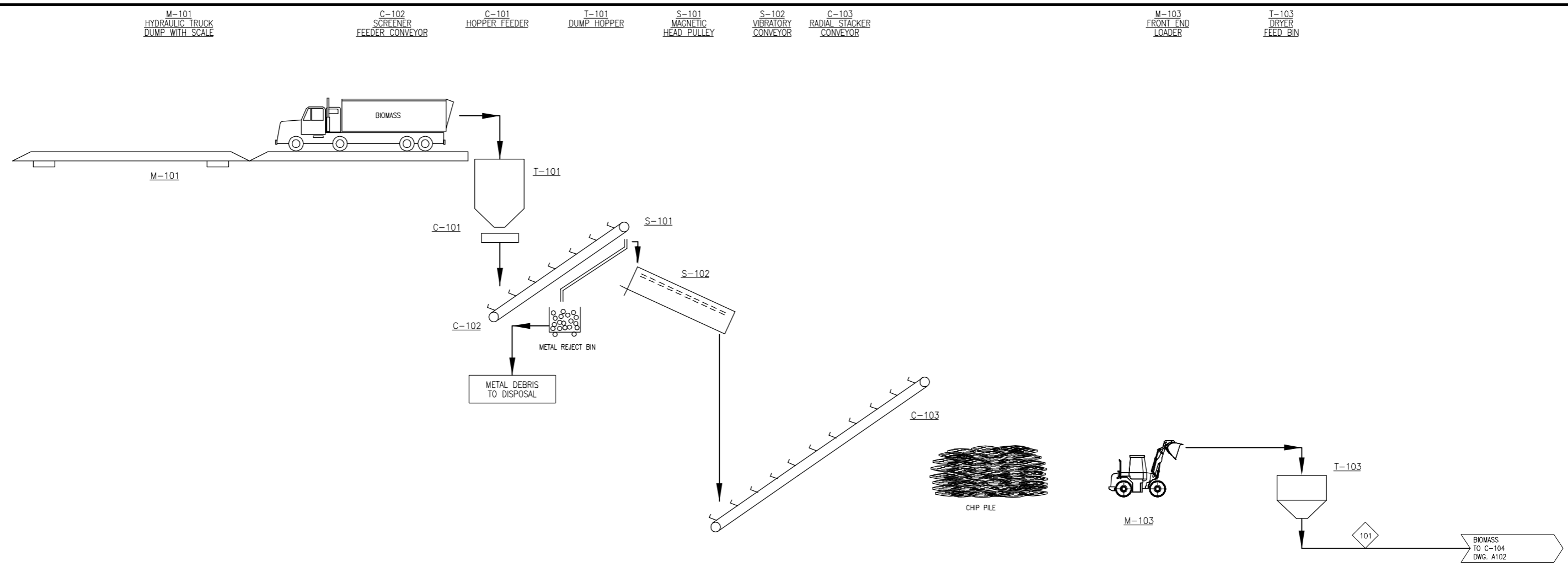

File Location: U:\30074.00\Drawings\PFDA\PFDA-P820-DRAWINGS\PFDA-P820-A101.dwg
 Plot Date: 5/27/11
 By: Kornek,Suzanne

COMPONENT	UNITS	101
Total Flow	lb/hr	262,455
Temperature	F	60
Pressure	Psia	14.7
Vapor Fraction		0.00
Hydrogen	lb/hr	-
Carbon Monoxide	lb/hr	-
Nitrogen	lb/hr	-
Oxygen	lb/hr	-
Argon	lb/hr	-
Carbon Dioxide	lb/hr	-
Water	lb/hr	78,736
Hydrogen Sulfide (H2S)	lb/hr	-
SO2	lb/hr	-
Ammonia (NH3)	lb/hr	-
NO2	lb/hr	-
Methane (CH4)	lb/hr	-
Ethane (C2H6)	lb/hr	-
Ethylene (C2H4)	lb/hr	-
Acetylene (C2H2)	lb/hr	-
Propane (C3H8)	lb/hr	-
1-Butane (C4H10)	lb/hr	-
N-Butane (C4H10)	lb/hr	-
Pentane +	lb/hr	-
Benzene (C6H6)	lb/hr	-
Tar (C10H8)	lb/hr	-
Carbon (Solid)	lb/hr	-
Sulfur (Solid)	lb/hr	-
Olivine + MgO (Solid)	lb/hr	-
Methanol	lb/hr	-
Ethanol	lb/hr	-
Propanol	lb/hr	-
n-Butanol	lb/hr	-
Pentanol+	lb/hr	-
Ash	lb/hr	0
Char	lb/hr	0
Wood	lb/hr	183,718
Enthalpy Flow	MMBTU/hr	(972.9)

Heat Stream No.	MM BTU/hr	Work Stream No.	HP



NREL
NATIONAL RENEWABLE ENERGY LABORATORY



Harris Group Inc.
Engineering for Optimum Performance®
www.harrisgroup.com

Scale: NONE		Drawn: RLL		Engr: MWW	
PMgr: MWW		Check: MWW		Check:	
NATIONAL RENEWABLE ENERGY LABORATORY GOLDEN, COLORADO					
2011 THERMOCHEMICAL DESIGN REPORT					
PROCESS FLOW DIAGRAM SECTION A100 FEED HANDLING & DRYING					
Project No.: 30074.00		Drawing: PFD-P820-A101		Rev: D	
Rev.	Date	By	Description		
D	05/27/11	MWW	ISSUED FOR REPORT		
C	04/28/11	MWW	ISSUED FOR REVIEW		
B	03/08/11	RLL	ISSUED FOR REVIEW		
A	12/13/10	RLL	ISSUED FOR REVIEW		

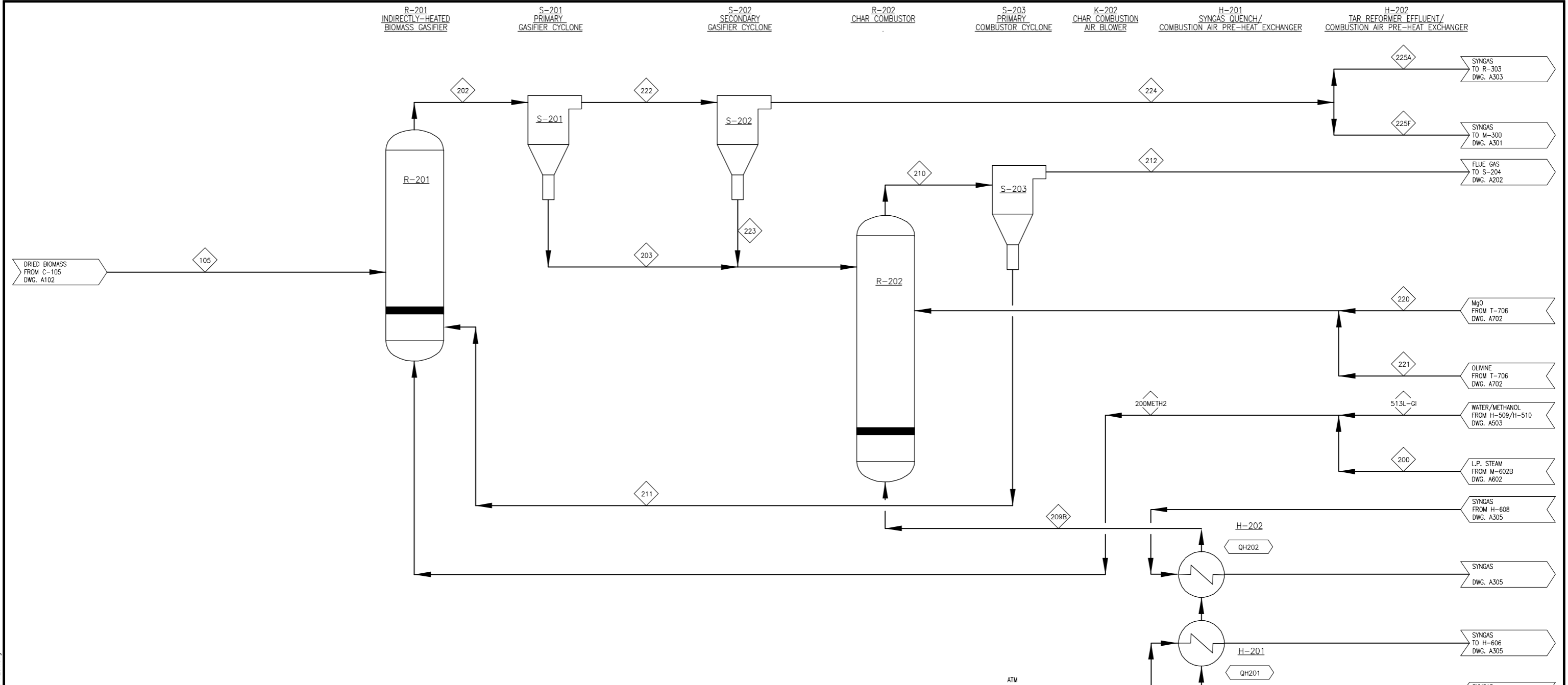

COMPONENT	UNITS	105	200	200METH2	202	203	208	209A	209B	210	211	212	220	221	222	223	224	225A	225F	513L-G1
Total Flow	lb/hr	204,131	66,542	82,409	5,236,499	4,985,407	477,646	477,646	5,468,902	4,949,959	518,943	7	538	251,092	5,305	245,787	236,707	9,080	15,867	
Temperature	F	220	590	590	1,596	1,596	90	277	400	1,808	1,808	1,808	60	60	1,596	1,596	1,596	1,596	1,596	590
Pressure	Psia	35.0	35.0	35.0	33.0	31.8	14.7	31.0	30.0	29.0	35.0	27.0	31.0	31.0	31.8	31.4	31.4	31.4	31.4	35.0
Vapor Fraction		0.00	1.00	1.00	1.00	0.00	1.00	1.00	1.00	1.00	0.00	1.00	1.00	1.00	1.00	0.00	1.00	1.00	1.00	1.00
Hydrogen	lb/hr	-	-	0	3,076	-	-	-	-	-	-	-	-	-	3,076	-	3,076	2,963	114	0
Carbon Monoxide	lb/hr	-	-	0	75,802	-	-	-	-	-	-	-	-	-	75,802	-	75,802	73,002	2,800	0
Nitrogen	lb/hr	-	-	0	0	-	353,688	353,688	353,688	353,709	-	353,709	-	-	0	-	0	0	0	0
Oxygen	lb/hr	-	-	-	-	-	108,371	108,371	108,371	18,058	-	18,058	-	-	-	-	-	-	-	-
Argon	lb/hr	-	-	-	-	-	6,032	6,032	6,032	-	6,032	-	-	-	-	-	-	-	-	-
Carbon Dioxide	lb/hr	-	-	69	36,225	-	235	235	235	107,159	-	107,159	-	-	36,225	-	36,225	34,886	1,338	69
Water	lb/hr	20,413	66,542	73,120	93,533	-	9,320	9,320	9,320	31,792	-	31,792	-	-	93,533	-	93,533	90,078	3,455	6,578
Hydrogen Sulfide (H2S)	lb/hr	-	-	2	56	-	-	-	-	-	-	-	0	0	56	-	56	54	2	2
SO2	lb/hr	-	-	-	-	-	-	-	9	-	9	-	-	-	-	-	-	-	-	-
Ammonia (NH3)	lb/hr	-	-	2	356	-	-	-	-	-	-	-	-	-	356	-	356	343	13	2
NO2	lb/hr	-	-	-	-	-	-	-	-	-	-	-	-	-	-	-	-	-	-	-
Methane (CH4)	lb/hr	-	-	0	15,816	-	-	-	-	-	-	-	-	-	15,816	-	15,816	15,232	584	0
Ethane (C2H6)	lb/hr	-	-	0	570	-	-	-	-	-	-	-	-	-	570	-	570	549	21	0
Ethylene (C2H4)	lb/hr	-	-	0	7,840	-	-	-	-	-	-	-	-	-	7,840	-	7,840	7,550	290	0
Acetylene (C2H2)	lb/hr	-	-	0	679	-	-	-	-	-	-	-	-	-	679	-	679	654	25	0
Propane (C3H8)	lb/hr	-	-	24	24	-	-	-	-	-	-	-	-	-	24	-	24	23	1	24
i-Butane (C4H10)	lb/hr	-	-	0	0	-	-	-	-	-	-	-	-	-	0	-	0	0	0	0
n-Butane (C4H10)	lb/hr	-	-	0	0	-	-	-	-	-	-	-	-	-	0	-	0	0	0	0
Pentane +	lb/hr	-	-	-	-	-	-	-	-	-	-	-	-	-	-	-	-	-	-	-
Benzene (C6H6)	lb/hr	-	-	0	641	-	-	-	-	-	-	-	-	-	641	-	641	617	24	0
Tar (C10H8)	lb/hr	-	-	-	1,923	-	-	-	-	-	-	-	-	-	1,923	-	1,923	1,852	71	-
Carbon (Solid)	lb/hr	-	-	-	-	-	-	-	-	-	-	-	-	-	-	-	-	-	-	-
Sulfur (Solid)	lb/hr	-	-	-	-	-	-	-	-	-	-	-	-	-	-	-	-	-	-	-
Olivine + MgO (Solid)	lb/hr	-	-	-	4,949,870	-	4,944,920	-	-	4,950,365	4,949,870	495	7	538	4,950	4,900	49	48	2	-
Methanol	lb/hr	-	-	9,069	9,069	-	-	-	-	-	-	-	-	-	9,069	-	9,069	8,734	335	9,069
Ethanol	lb/hr	-	-	76	76	-	-	-	-	-	-	-	-	-	76	-	76	73	3	76
Propanol	lb/hr	-	-	-	-	-	-	-	-	-	-	-	-	-	-	-	-	-	-	-
n-Butanol	lb/hr	-	-	-	-	-	-	-	-	-	-	-	-	-	-	-	-	-	-	-
Pentanol+	lb/hr	-	-	-	-	-	-	-	-	-	-	-	-	-	-	-	-	-	-	-
Ash	lb/hr	0	-	-	0	0	-	-	-	1,779	89	1,690	-	-	0	0	0	0	0	-
Char	lb/hr	0	-	-	40,896	40,887	-	-	-	-	-	-	-	-	409	405	4	4	0	-
Wood	lb/hr	183,718	-	-	0	0	-	-	-	-	-	-	-	-	0	0	0	0	0	-
Enthalpy Flow	MMBTU/hr	(553.0)	(368.7)	(428.3)	1,196.8	1,877.9	(53.3)	(31.3)	(16.7)	1,862.9	2,207.5	(344.7)	(0.0)	(0.0)	(681.0)	1.7	(682.8)	(657.5)	(25.2)	(59.6)

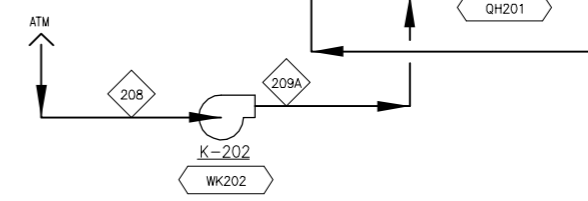

Heat Stream No.	MM BTU/hr	Work Stream No.	HP
QH201	4.64	WK202	8,624.1
QH202	9.95		



Scale: NONE
 PMgr: MWW
 Appr: [Signature]

Drawn: RLL
 Check: MWW

Engr: MWW
 Check: [Signature]

NATIONAL RENEWABLE ENERGY LABORATORY
 GOLDEN, COLORADO

2011 THERMOCHEMICAL DESIGN REPORT

PROCESS FLOW DIAGRAM
 SECTION A200
 GASIFICATION

Rev.	Date	By	Description
D	05/27/11	MWW	ISSUED FOR REPORT
C	04/28/11	MWW	ISSUED FOR REVIEW
B	03/08/11	RLL	ISSUED FOR REVIEW
A	12/13/10	RLL	ISSUED FOR REVIEW

Project No.: 30074.00
 Drawing: PFD-P820-A201
 Rev: [Signature]

File Location: U:\30074\00\Drawings\PFDs\P820 DRAWINGS\PF820-A201.dwg
 Plot Date: 5/27/11
 By: Kornek,Susanne

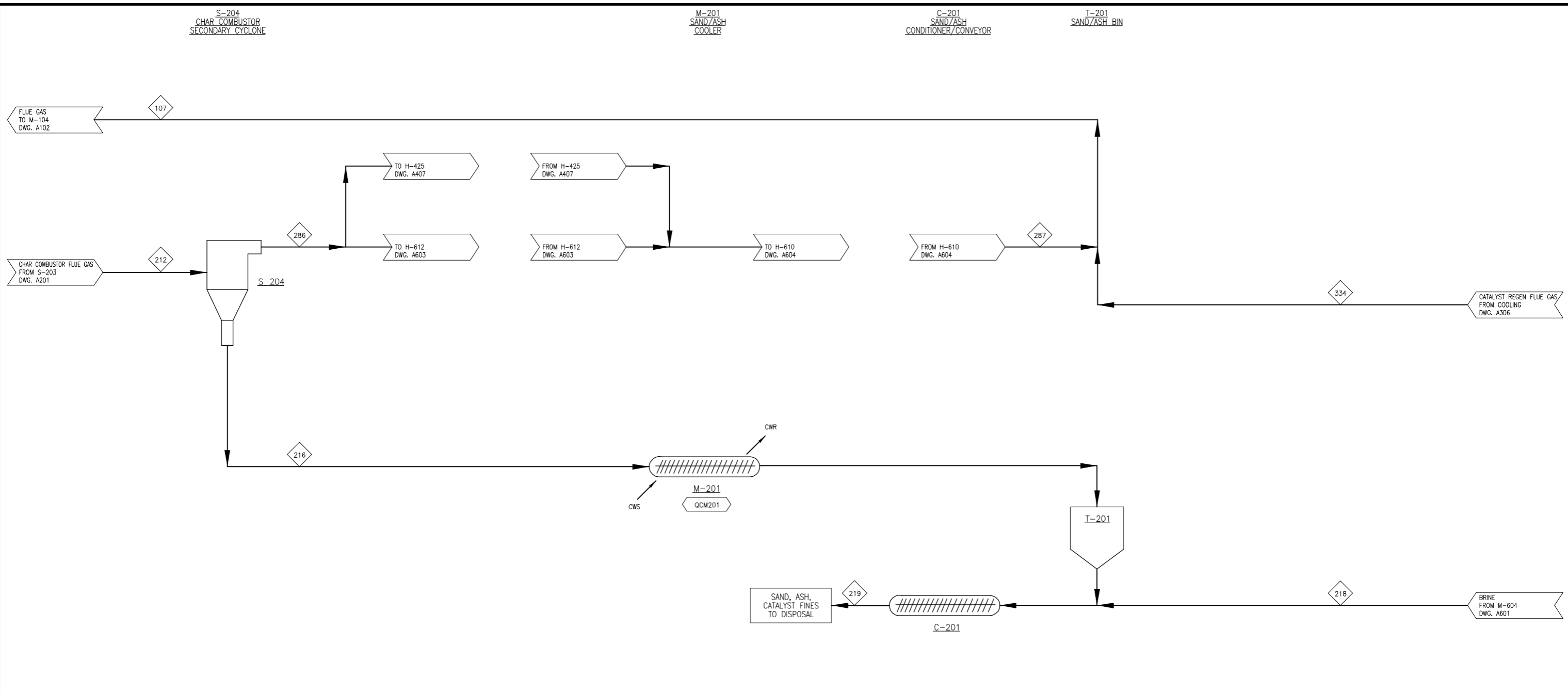

COMPONENT	UNITS	107	212	216	218	219	286	287	334
Total Flow	lb/hr	878,723	518,943	2,185	243	2,428	516,758	516,758	361,965
Temperature	F	539	1,808	1,808	66	206	1,808	532	549
Pressure	Psia	17.0	27.0	26.7	75.0	14.7	27.0	23.0	17.0
Vapor Fraction		1.00	1.00	0.00	0.00	0.00	1.00	1.00	1.00
Hydrogen	lb/hr	-	-	-	-	-	-	-	-
Carbon Monoxide	lb/hr	-	-	-	-	-	-	-	-
Nitrogen	lb/hr	541,810	353,709	-	-	-	353,709	353,709	188,101
Oxygen	lb/hr	25,738	18,058	-	-	-	18,058	18,058	7,680
Argon	lb/hr	9,236	6,032	-	-	-	6,032	6,032	3,204
Carbon Dioxide	lb/hr	231,742	107,159	-	-	-	107,159	107,159	124,583
Water	lb/hr	70,097	31,792	-	243	243	31,792	31,792	38,305
Hydrogen Sulfide (H2S)	lb/hr	-	-	-	-	-	-	-	-
SO2	lb/hr	29	9	-	-	-	9	9	20
Ammonia (NH3)	lb/hr	-	-	-	-	-	-	-	-
NO2	lb/hr	69	-	-	-	-	-	-	69
Methane (CH4)	lb/hr	-	-	-	-	-	-	-	-
Ethane (C2H6)	lb/hr	-	-	-	-	-	-	-	-
Ethylene (C2H4)	lb/hr	-	-	-	-	-	-	-	-
Acetylene (C2H2)	lb/hr	-	-	-	-	-	-	-	-
Propane (C3H8)	lb/hr	-	-	-	-	-	-	-	-
i-Butane (C4H10)	lb/hr	-	-	-	-	-	-	-	-
n-Butane (C4H10)	lb/hr	-	-	-	-	-	-	-	-
Pentane +	lb/hr	-	-	-	-	-	-	-	-
Benzene (C6H6)	lb/hr	-	-	-	-	-	-	-	-
Tar (C10H8)	lb/hr	-	-	-	-	-	-	-	-
Carbon (Solid)	lb/hr	-	-	-	-	-	-	-	-
Sulfur (Solid)	lb/hr	-	-	-	-	-	-	-	-
Olivine + MgO (Solid)	lb/hr	2	495	495	-	495	-	-	2
Methanol	lb/hr	-	-	-	-	-	-	-	-
Ethanol	lb/hr	-	-	-	-	-	-	-	-
Propanol	lb/hr	-	-	-	-	-	-	-	-
n-Butanol	lb/hr	-	-	-	-	-	-	-	-
Pentanol+	lb/hr	-	-	-	-	-	-	-	-
Ash	lb/hr	-	1,690	1,690	-	1,690	-	-	-
Char	lb/hr	0	-	-	-	-	-	-	0
Wood	lb/hr	-	-	-	-	-	-	-	-
Enthalpy Flow	MMBTU/hr	(1,191.0)	(344.7)	0.4	(1.7)	(2.2)	(345.0)	(535.6)	(655.4)

Heat Stream No.	MM BTU/hr	Work Stream No.	HP
QCM201	0.86		



NREL
NATIONAL RENEWABLE ENERGY LABORATORY



Harris Group Inc.
Engineering for Optimum Performance®
www.harrisgroup.com

Scale: NONE
 PMgr: MWW Drawn: RLL Engr: MWW
 Appr: Check: MWW Check:

**NATIONAL RENEWABLE ENERGY LABORATORY
GOLDEN, COLORADO**

2011 THERMOCHEMICAL DESIGN REPORT

**PROCESS FLOW DIAGRAM
SECTION A200
GASIFICATION**

Project No.:	30074.00	Drawing:	PFD-P820-A202	Rev:	D
--------------	----------	----------	---------------	------	---

Rev.	Date	By	Description
D	05/27/11	MWW	ISSUED FOR REPORT
C	04/28/11	MWW	ISSUED FOR REVIEW
B	03/08/11	RLL	ISSUED FOR REVIEW
A	12/13/10	RLL	ISSUED FOR REVIEW

File Location: U:\30074.00\Drawings\PDFs\A200\DRAWINGS\A200-PFD-P820-A202.dwg
 Plot Date: 5/27/11
 By: Kornek, Susanne

K-305
COMBUSTION AIR BLOWER

M-300
COMBUSTION FUEL
PRE-MIX

H-305
ALCOHOL SYNTHESIS EFFLUENT/
COMBUSTION AIR PRE-HEAT EXCHANGER

H-306
SYNGAS QUENCH INLET/
COMBUSTION AIR PRE-HEAT EXCHANGER

H-307
SYNGAS QUENCH INLET/
COMBUSTION AIR PRE-HEAT EXCHANGER

H-308
TAR REFORMER EFFLUENT/
COMBUSTION AIR PRE-HEAT EXCHANGER

H-311
TAR REFORMER EFFLUENT/
UNREACTED SYNGAS EXCHANGER

H-309
TAR REFORMER EFFLUENT/
COMBUSTION AIR PRE-HEAT EXCHANGER

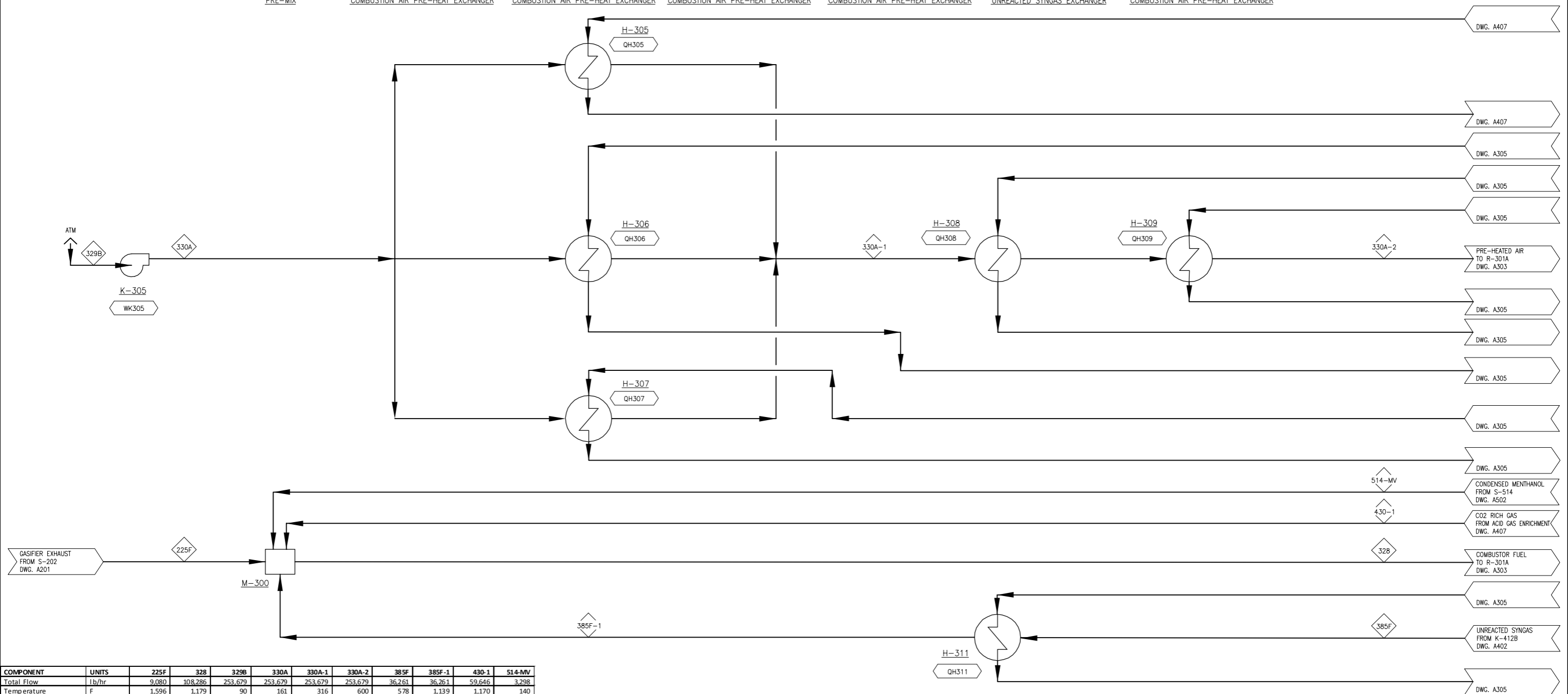

COMPONENT	UNITS	225F	328	329B	330A	330A-1	330A-2	385F	385F-1	430-1	514-MV
Total Flow	lb/hr	9,080	108,286	253,679	253,679	253,679	253,679	36,261	36,261	59,646	3,298
Temperature	F	1,596	1,179	90	161	316	600	578	1,139	1,170	140
Pressure	Psia	31.4	19.0	14.7	20.0	20.0	19.0	33.7	28.7	19.0	43.0
Vapor Fraction		1.00	1.00	1.00	1.00	1.00	1.00	1.00	1.00	1.00	1.00
Hydrogen	lb/hr	114	1,423	-	-	-	-	1,302	1,302	8	0
Carbon Monoxide	lb/hr	2,800	16,065	-	-	-	-	12,408	12,408	848	9
Nitrogen	lb/hr	0	257	187,845	187,845	187,845	187,845	242	242	15	0
Oxygen	lb/hr	-	-	57,556	57,556	57,556	57,556	-	-	-	-
Argon	lb/hr	-	-	3,204	3,204	3,204	3,204	-	-	-	-
Carbon Dioxide	lb/hr	1,338	77,087	125	125	125	125	18,796	18,796	54,481	2,472
Water	lb/hr	3,455	4,324	4,950	4,950	4,950	4,950	0	0	869	-
Hydrogen Sulfide (H2S)	lb/hr	2	11	-	-	-	-	0	0	1	8
SO2	lb/hr	-	-	-	-	-	-	-	-	-	-
Ammonia (NH3)	lb/hr	13	25	-	-	-	-	0	0	9	3
NO2	lb/hr	-	-	-	-	-	-	-	-	-	-
Methane (CH4)	lb/hr	584	4,998	-	-	-	-	3,319	3,319	1,083	12
Ethane (C2H6)	lb/hr	21	411	-	-	-	-	73	73	314	4
Ethylene (C2H4)	lb/hr	290	645	-	-	-	-	99	99	250	6
Acetylene (C2H2)	lb/hr	25	84	-	-	-	-	-	-	58	1
Propane (C3H8)	lb/hr	1	237	-	-	-	-	23	23	172	42
n-Butane (C4H10)	lb/hr	-	0	-	-	-	-	-	-	-	-
n-Butane (C4H10)	lb/hr	0	0	-	-	-	-	0	0	-	0
Pentane +	lb/hr	-	0	-	-	-	-	-	-	-	-
Benzene (C6H6)	lb/hr	24	24	-	-	-	-	0	0	24	0
Tar (C10H8)	lb/hr	71	71	-	-	-	-	0	0	-	-
Carbon (Solid)	lb/hr	-	-	-	-	-	-	-	-	-	-
Sulfur (Solid)	lb/hr	-	-	-	-	-	-	-	-	-	-
Olivine + MgO (Solid)	lb/hr	2	2	-	-	-	-	-	-	-	-
Methanol	lb/hr	335	2,121	-	-	-	-	-	-	1,054	732
Ethanol	lb/hr	3	470	-	-	-	-	-	-	464	3
Propanol	lb/hr	-	22	-	-	-	-	-	-	22	-
n-Butanol	lb/hr	-	0	-	-	-	-	0	0	-	-
Pentanol+	lb/hr	-	-	-	-	-	-	-	-	-	-
Ash	lb/hr	0	0	-	-	-	-	-	-	-	-
Char	lb/hr	0	0	-	-	-	-	-	-	-	-
Wood	lb/hr	0	0	-	-	-	-	-	-	-	-
Enthalpy Flow	MMBTU/hr	(25.2)	(324.7)	(28.3)	(23.9)	(14.2)	3.9	(92.9)	(83.9)	(204.1)	(11.5)

Heat Stream No.	MM BTU/hr	Work Stream No.	HP
QH305	1.58	WK305	1,729.7
QH306	2.64		
QH307	5.91		
QH308	5.33		
QH309	12.75		
QH311	9.08		

Plot Date: 5/27/11
 Br: Korinek, Suzanne
 File Location: U:\30074.00\Drawings\PEFD\A-PFD-PE80-DRAWINGS\PEFD-PE80-A301.dwg



NREL
NATIONAL RENEWABLE ENERGY LABORATORY



Harris Group Inc.
Engineering for Optimum Performance®
www.harrisgroup.com

Scale: NONE		Engr: MWW	
PMgr: MWW	Drawn: RLL	Check: MWW	
Appr:	Check: MWW	Engr: MWW	

NATIONAL RENEWABLE ENERGY LABORATORY
GOLDEN, COLORADO

2011 THERMOCHEMICAL DESIGN REPORT

PROCESS FLOW DIAGRAM
SECTION A300
TAR REFORMING, QUENCH & CLEANUP

Project No.:	30074.00	Drawing:	PFD-P820-A301	Rev:	D
--------------	----------	----------	---------------	------	---

Rev.	Date	By	Description
D	05/27/11	MWW	ISSUED FOR REPORT
C	04/28/11	MWW	ISSUED FOR REVIEW
B	03/08/11	RLL	ISSUED FOR REVIEW
A	12/13/10	RLL	ISSUED FOR REVIEW

H-302
STEAM BLOWDOWN/
UNREACTED SYNGAS EXCHANGER

M-300H
TAR REFORMER
INLET MIX

H-310
CATALYST REGENERATOR FLUE GAS/
TAR REFORMER STEAM AND RECYCLE EXCHANGER

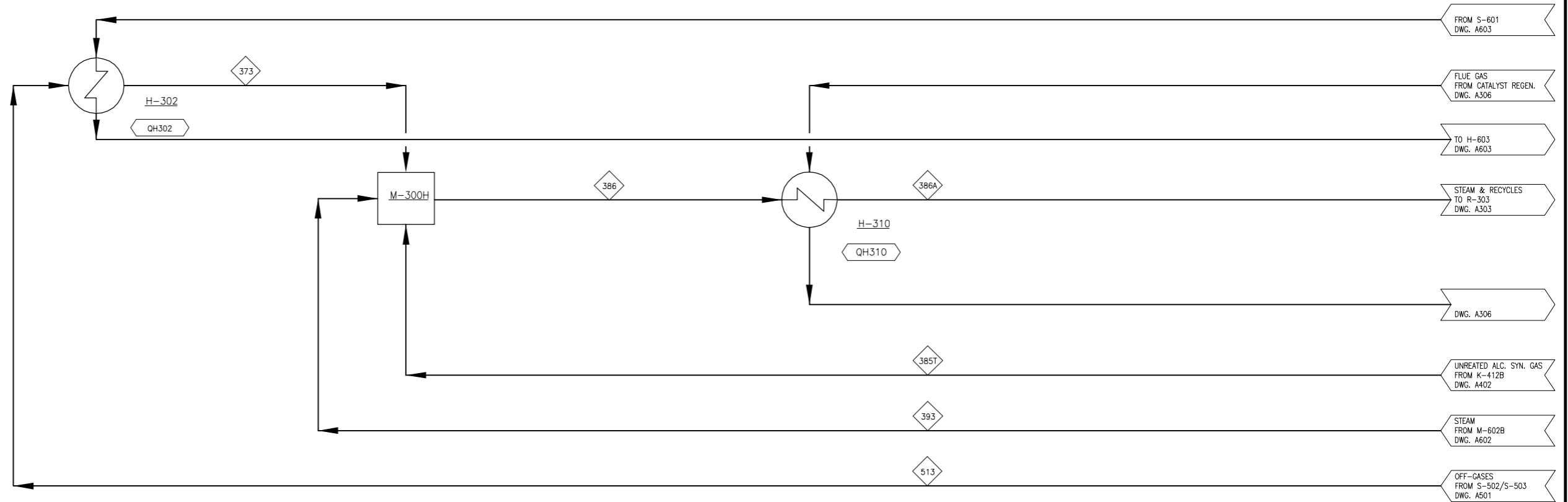

COMPONENT	UNITS	373	385T	386	386A	393	513
Total Flow	lb/hr	33,593	108,784	142,651	142,651	274	33,593
Temperature	F	564	578	575	1,700	590	72
Pressure	Psia	35.0	33.7	33.7	28.7	59.7	40.0
Vapor Fraction		1.00	1.00	1.00	1.00	1.00	1.00
Hydrogen	lb/hr	130	3,905	4,035	4,035	-	130
Carbon Monoxide	lb/hr	2,289	37,224	39,513	39,513	-	2,289
Nitrogen	lb/hr	32	726	758	758	-	32
Oxygen	lb/hr	-	-	-	-	-	-
Argon	lb/hr	-	-	-	-	-	-
Carbon Dioxide	lb/hr	28,996	56,387	85,383	85,383	-	28,996
Water	lb/hr	19	0	294	294	274	19
Hydrogen Sulfide (H2S)	lb/hr	25	1	26	26	-	25
SO2	lb/hr	-	-	-	-	-	-
Ammonia (NH3)	lb/hr	3	0	4	4	-	3
NO2	lb/hr	-	-	-	-	-	-
Methane (CH4)	lb/hr	1,100	9,956	11,056	11,056	-	1,100
Ethane (C2H6)	lb/hr	83	219	302	302	-	83
Ethylene (C2H4)	lb/hr	145	296	441	441	-	145
Acetylene (C2H2)	lb/hr	7	-	7	7	-	7
Propane (C3H8)	lb/hr	100	69	169	169	-	100
I-Butane (C4H10)	lb/hr	-	-	-	-	-	-
N-Butane (C4H10)	lb/hr	0	0	0	0	-	0
Pentane +	lb/hr	-	-	-	-	-	-
Benzene (C6H6)	lb/hr	0	0	0	0	-	0
Tar (C10H8)	lb/hr	0	0	0	0	-	0
Carbon (Solid)	lb/hr	-	-	-	-	-	-
Sulfur (Solid)	lb/hr	-	-	-	-	-	-
Olivine + MgO (Solid)	lb/hr	-	-	-	-	-	-
Methanol	lb/hr	487	-	487	487	-	487
Ethanol	lb/hr	164	-	164	164	-	164
Propanol	lb/hr	6	-	6	6	-	6
n-Butanol	lb/hr	0	0	0	0	-	0
Pentanol+	lb/hr	-	-	-	-	-	-
Ash	lb/hr	-	-	-	-	-	-
Char	lb/hr	-	-	-	-	-	-
Wood	lb/hr	-	-	-	-	-	-
Enthalpy Flow	MMBTU/hr	(115.2)	(278.8)	(395.5)	(325.7)	(1.5)	(119.6)

Heat Stream No.	MM BTU/hr	Work Stream No.	HP
QH302	4.38		
QH310	69.86		

File Location: U:\30074.00\Drawings\PDFs\PD-P820 DRAWINGS\PDF-P820-A30Z.dwg
By: Korinek,Susanne
Plot Date: 5/27/11



NREL
NATIONAL RENEWABLE ENERGY LABORATORY



Harris Group Inc.
Engineering for Optimum Performance®
www.harrisgroup.com

Scale: NONE
PMgr: MWW
Appr:

Drawn: RLL
Check: MWW

Engr: MWW
Check:

NATIONAL RENEWABLE ENERGY LABORATORY
GOLDEN, COLORADO

2011 THERMOCHEMICAL DESIGN REPORT

PROCESS FLOW DIAGRAM
SECTION A300
TAR REFORMING, QUENCH & CLEANUP

Project No.:	30074.00	Drawing:	PFD-P820-A30Z	Rev:	
Rev.	Date	By	Description		

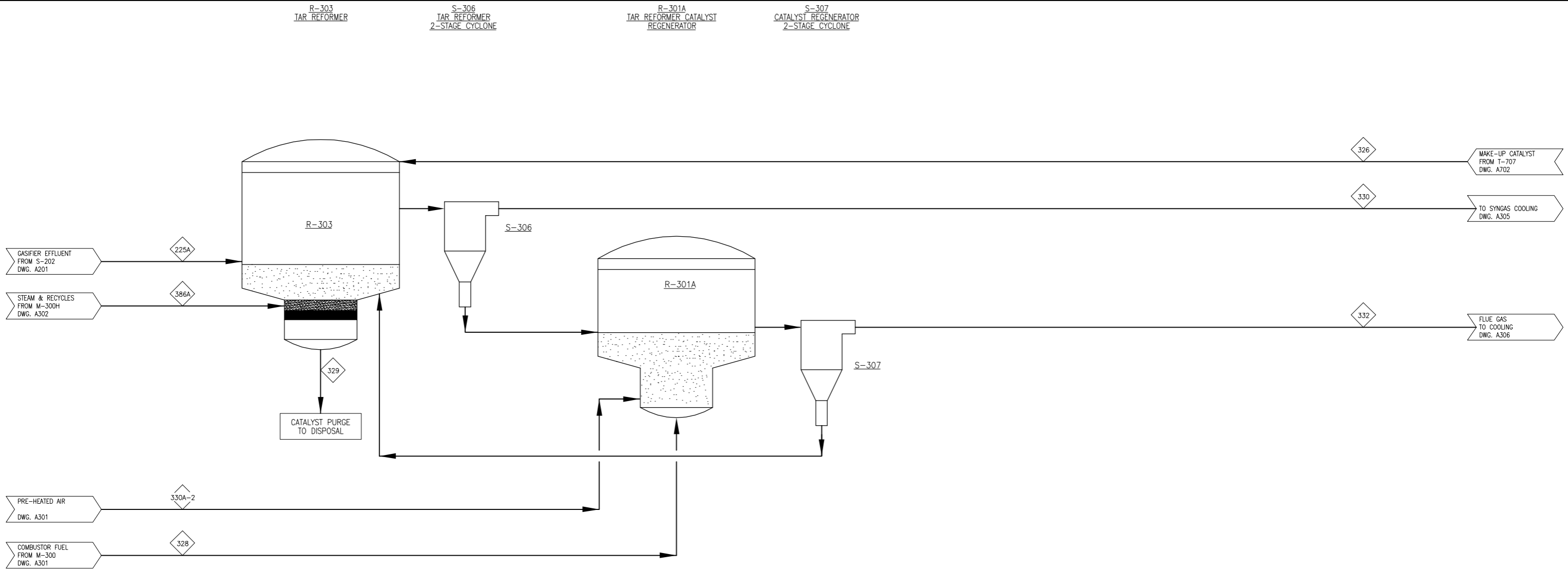

Plot Date: 5/27/11 By: Korinek,Susanne File Location: U:\30074.00\Drawings\PFDS\PFDS-P820 DRAWINGS\PFDS-P820-A303.dwg

COMPONENT	UNITS	225A	326	328	329	330	330A-2	332	386A
Total Flow	lb/hr	236,707	12	108,286	12	379,359	253,679	361,965	142,651
Temperature	F	1,596	60	1,179	1,670	1,670	600	1,777	1,700
Pressure	Psia	31.4	29.0	19.0	25.7	25.7	19.0	18.0	28.7
Vapor Fraction		1.00	0.00	1.00	0.00	1.00	1.00	1.00	1.00
Hydrogen	lb/hr	2,963	-	1,423	-	17,862	-	-	4,035
Carbon Monoxide	lb/hr	73,002	-	16,065	-	198,960	-	-	39,513
Nitrogen	lb/hr	0	-	257	-	1,015	187,845	188,101	758
Oxygen	lb/hr	-	-	-	-	-	57,556	7,680	-
Argon	lb/hr	-	-	-	-	-	3,204	3,204	-
Carbon Dioxide	lb/hr	34,886	-	77,087	-	90,677	125	124,583	85,383
Water	lb/hr	90,078	-	4,324	-	64,279	4,950	38,305	294
Hydrogen Sulfide (H2S)	lb/hr	54	-	11	-	80	-	-	26
SO2	lb/hr	-	-	-	-	-	-	20	-
Ammonia (NH3)	lb/hr	343	-	25	-	35	-	-	4
NO2	lb/hr	-	-	-	-	-	-	69	-
Methane (CH4)	lb/hr	15,232	-	4,998	-	5,258	-	-	11,056
Ethane (C2H6)	lb/hr	549	-	411	-	9	-	-	302
Ethylene (C2H4)	lb/hr	7,550	-	645	-	799	-	-	441
Acetylene (C2H2)	lb/hr	654	-	84	-	66	-	-	7
Propane (C3H8)	lb/hr	23	-	237	-	192	-	-	169
1-Butane (C4H10)	lb/hr	-	-	0	-	-	-	-	-
n-Butane (C4H10)	lb/hr	0	-	0	-	0	-	-	0
Pentane +	lb/hr	-	-	0	-	-	-	-	-
Benzene (C6H6)	lb/hr	617	-	24	-	6	-	-	0
Tar (C10H8)	lb/hr	1,852	-	71	-	19	-	-	0
Carbon (Solid)	lb/hr	-	-	-	-	-	-	-	-
Sulfur (Solid)	lb/hr	-	-	-	-	-	-	-	-
Olivine + MgO (Solid)	lb/hr	48	12	2	12	48	-	2	-
Methanol	lb/hr	8,734	-	2,121	-	0	-	-	487
Ethanol	lb/hr	73	-	470	-	0	-	-	164
Propanol	lb/hr	-	-	22	-	-	-	-	6
n-Butanol	lb/hr	-	-	0	-	-	-	-	0
Pentanol+	lb/hr	-	-	-	-	-	-	-	-
Ash	lb/hr	0	-	0	-	0	-	-	-
Char	lb/hr	4	-	0	-	4	-	0	-
Wood	lb/hr	0	-	0	-	0	-	-	-
Enthalpy Flow	MMBTU/hr	(657.5)	(0.0)	(324.7)	0.0	(783.1)	3.9	(520.9)	(325.7)

Heat Stream No.	MM BTU/hr	Work Stream No.	HP



NREL
NATIONAL RENEWABLE ENERGY LABORATORY



Harris Group Inc.
Engineering for Optimum Performance®
www.harrisgroup.com

Scale: NONE
 PMgr: MWW Drawn: RLL Engr: MWW
 Appr: Check: MWW Check:

**NATIONAL RENEWABLE ENERGY LABORATORY
GOLDEN, COLORADO**

2011 THERMOCHEMICAL DESIGN REPORT

**PROCESS FLOW DIAGRAM
SECTION A300
TAR REFORMING**

D	05/27/11	MWW	ISSUED FOR REPORT
C	04/28/11	MWW	ISSUED FOR REVIEW
B	03/08/11	RLL	ISSUED FOR REVIEW
A	12/13/10	RLL	ISSUED FOR REVIEW

Project No.: 30074.00

Drawing: PFD-P820-A303

Rev: 

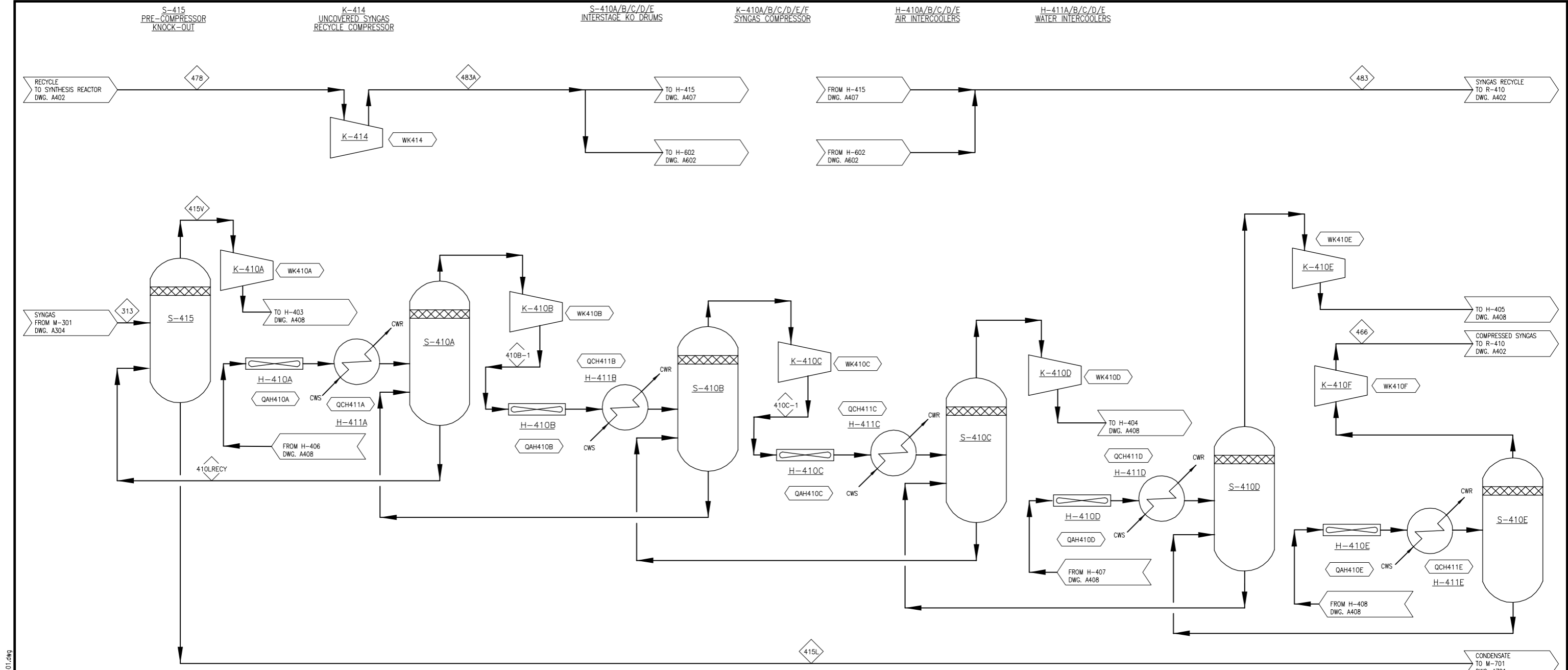

COMPONENT	UNITS	313	410B-1	410C-1	410LRECY	415L	415V	466	478	483	483A
Total Flow	lb/hr	351,310	320,378	318,986	35,120	35,980	350,451	315,330	709,768	709,768	709,768
Temperature	F	137	177	204	110	136	136	320	110	180	115
Pressure	Psia	22.7	90.2	140.0	64.0	22.7	22.7	3,000.0	2,916.8	3,000.0	3,005.0
Vapor Fraction		1.00	1.00	1.00	0.00	0.00	1.00	1.00	1.00	1.00	1.00
Hydrogen	lb/hr	17,862	17,862	17,862	0	-	17,862	17,862	37,299	37,299	37,299
Carbon Monoxide	lb/hr	198,936	198,936	198,936	0	-	198,936	198,936	311,136	311,136	311,136
Nitrogen	lb/hr	1,015	1,015	1,015	0	-	1,015	1,015	6,119	6,119	6,119
Oxygen	lb/hr	-	-	-	-	-	-	-	-	-	-
Argon	lb/hr	-	-	-	-	-	-	-	-	-	-
Carbon Dioxide	lb/hr	90,638	90,638	90,638	2	0	90,639	90,637	282,118	282,118	282,118
Water	lb/hr	36,398	5,463	4,072	35,111	35,978	35,531	420	1	1	1
Hydrogen Sulfide (H2S)	lb/hr	80	80	80	0	-	80	80	8	8	8
SO2	lb/hr	-	-	-	-	-	-	-	-	-	-
Ammonia (NH3)	lb/hr	20	22	21	8	1	26	19	2	2	2
NO2	lb/hr	-	-	-	-	-	-	-	-	-	-
Methane (CH4)	lb/hr	5,250	5,250	5,250	0	-	5,250	5,250	70,307	70,307	70,307
Ethane (C2H6)	lb/hr	8	8	8	0	-	8	8	1,097	1,097	1,097
Ethylene (C2H4)	lb/hr	797	797	797	0	-	797	797	1,584	1,584	1,584
Acetylene (C2H2)	lb/hr	66	66	66	0	-	66	66	-	-	-
Propane (C3H8)	lb/hr	190	190	190	0	-	190	190	88	88	88
1-Butane (C4H10)	lb/hr	-	-	-	-	-	-	-	-	-	-
n-Butane (C4H10)	lb/hr	0	0	0	0	-	0	0	0	0	0
Pentane +	lb/hr	-	-	-	-	-	-	-	-	-	-
Benzene (C6H6)	lb/hr	5	5	5	0	-	5	5	0	0	0
Tar (C10H8)	lb/hr	0	0	0	0	-	0	0	0	0	0
Carbon (Solid)	lb/hr	-	-	-	-	-	-	-	-	-	-
Sulfur (Solid)	lb/hr	-	-	-	-	-	-	-	-	-	-
Olivine + MgO (Solid)	lb/hr	-	-	-	-	-	-	-	-	-	-
Methanol	lb/hr	0	0	0	0	-	0	0	-	-	-
Ethanol	lb/hr	0	0	0	0	-	0	0	-	-	-
Propanol	lb/hr	-	-	-	-	-	-	-	-	-	-
n-Butanol	lb/hr	-	-	-	-	-	-	-	0	0	0
Pentanol+	lb/hr	-	-	-	-	-	-	-	-	-	-
Ash	lb/hr	-	-	-	-	-	-	-	-	-	-
Char	lb/hr	-	-	-	-	-	-	-	-	-	-
Wood	lb/hr	-	-	-	-	-	-	-	-	-	-
Enthalpy Flow	MMBTU/hr	(897.8)	(714.6)	(703.0)	(240.8)	(243.4)	(892.9)	(666.4)	(1,757.7)	(1,732.5)	(1,756.0)

Heat Stream No.	MM BTU/hr	Work Stream No.	HP
QAH410A	26.18	WK410A	15,296.7
QAH410B	6.37	WK410B	3,621.3
QAH410C	10.06	WK410C	5,078.0
QAH410D	6.53	WK410D	13,681.3
QAH410E	6.00	WK410E	13,640.1
QCH411A	7.94	WK410F	12,056.3
QCH411B	4.23	WK411A	706.4
QCH411C	4.30		
QCH411D	3.20		
QCH411E	3.20		



ONREL
NATIONAL RENEWABLE ENERGY LABORATORY



Harris Group Inc.
Engineering for Optimum Performance®
www.harrisgroup.com

Scale: NONE
PMgr: MWW
Appr:

Drawn: RLL
Check: MWW

Engr: MWW
Check:

NATIONAL RENEWABLE ENERGY LABORATORY
GOLDEN, COLORADO

2011 THERMOCHEMICAL DESIGN REPORT

PROCESS FLOW DIAGRAM
SECTION A400
SYNGAS COMPRESSION

Project No.: 30074.00

Drawing: PFD-P820-A401

Rev: 

Rev.	Date	By	Description
D	05/27/11	MWW	ISSUED FOR REPORT
C	04/28/11	MWW	ISSUED FOR REVIEW
B	03/08/11	RLL	ISSUED FOR REVIEW
A	12/13/10	RLL	ISSUED FOR REVIEW

File Location: U:\30074\Drawings\PFDS\PFDS-P820_DRAWINGS\PFDS-P820-A401.dwg
 Plot Date: 5/27/11
 By: Kojek,Suzanne

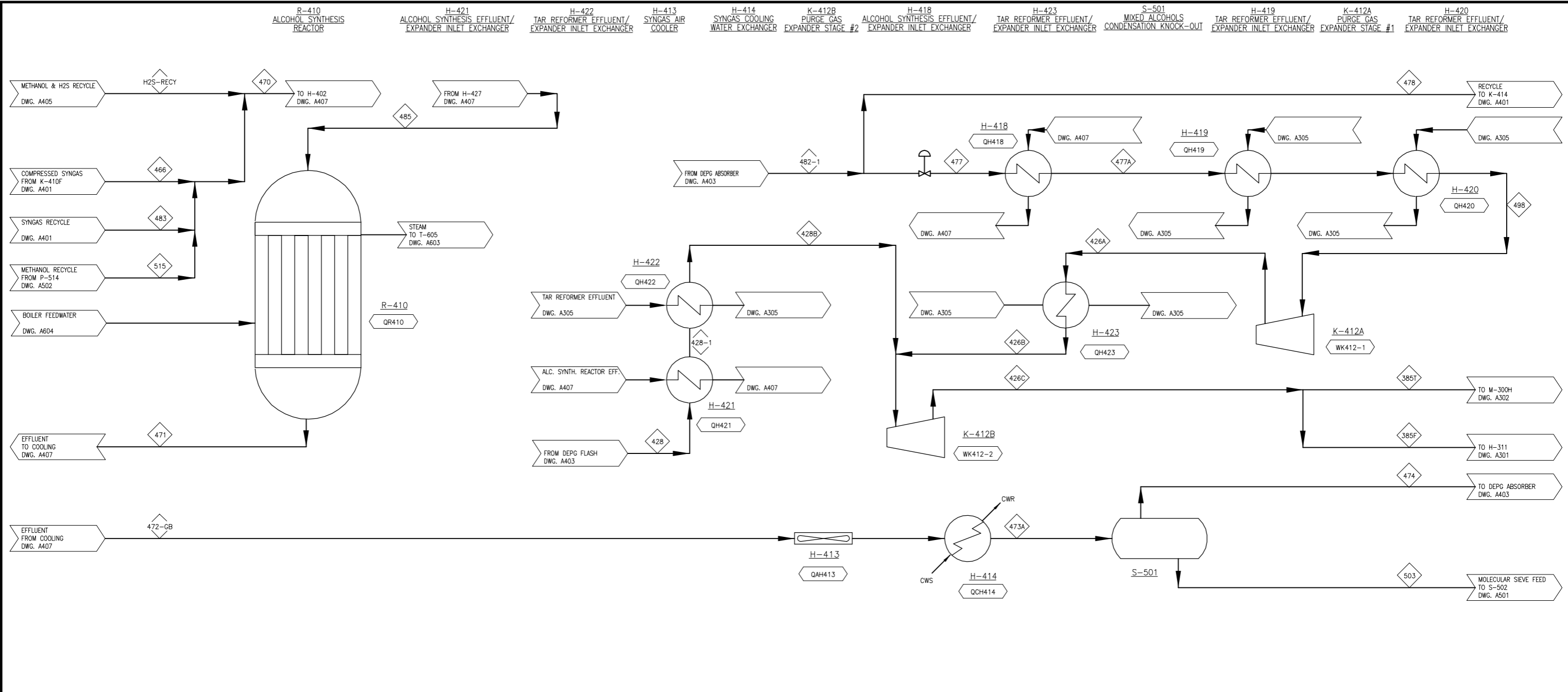

COMPONENT	UNITS	385F	385T	426A	426B	426C	428	428-1	428B	471	472-G8	473A	474	477	477A	478	482-1	483	485	498	503	515	H2S-RECY
Total Flow	lb/hr	36,261	108,784	92,230	92,230	145,046	52,816	52,816	52,816	1,077,813	1,077,813	1,077,813	915,328	92,230	709,768	801,997	709,768	1,077,813	92,230	162,485	44,966	7,749	
Temperature	F	578	578	595	950	578	30	316	950	611	175	110	110	95	316	110	110	180	595	950	110	164	80
Pressure	Psia	33.7	33.7	250.0	248.0	33.7	250.0	250.0	248.0	2,952.8	2,945.8	2,938.8	2,936.8	1,505.0	1,500.0	2,916.8	2,916.8	3,000.0	2,995.0	1,500.0	2,936.8	3,001.0	3,000.0
Vapor Fraction		1.00	1.00	1.00	1.00	1.00	1.00	1.00	1.00	1.00	0.94	0.92	1.00	1.00	1.00	1.00	1.00	1.00	1.00	0.00	0.00	0.00	0.00
Hydrogen	lb/hr	1,302	3,905	4,847	4,847	5,207	360	360	360	42,643	42,643	42,643	42,513	4,847	4,847	37,299	42,145	37,299	55,160	4,847	130	0	0
Carbon Monoxide	lb/hr	12,408	37,224	40,430	40,430	49,632	9,202	9,202	9,202	363,914	363,914	363,914	361,616	40,430	40,430	311,136	351,566	311,136	510,072	40,430	2,298	0	0
Nitrogen	lb/hr	242	726	795	795	968	173	173	173	7,134	7,134	7,134	7,102	795	795	6,119	6,914	6,119	7,134	795	33	0	0
Oxygen	lb/hr	-	-	-	-	-	-	-	-	-	-	-	-	-	-	-	-	-	-	-	-	-	-
Argon	lb/hr	-	-	-	-	-	-	-	-	-	-	-	-	-	-	-	-	-	-	-	-	-	-
Carbon Dioxide	lb/hr	18,796	56,387	36,659	36,659	75,183	38,523	38,523	38,523	445,094	445,094	445,094	413,064	36,659	36,659	282,118	318,777	282,118	373,433	36,659	32,030	423	255
Water	lb/hr	0	0	0	0	0	0	0	0	7,261	7,261	7,261	50	0	0	1	1	1	421	0	7,211	-	-
Hydrogen Sulfide (H2S)	lb/hr	0	1	1	1	1	-	-	-	144	144	144	99	1	1	8	8	8	144	1	45	9	47
SO2	lb/hr	-	-	-	-	-	-	-	-	-	-	-	-	-	-	-	-	-	-	-	-	-	-
Ammonia (NH3)	lb/hr	0	0	0	0	0	-	-	-	27	27	27	12	0	0	2	2	2	27	0	15	6	0
NO2	lb/hr	-	-	-	-	-	-	-	-	-	-	-	-	-	-	-	-	-	-	-	-	-	-
Methane (CH4)	lb/hr	3,319	9,956	9,136	9,136	13,275	4,139	4,139	4,139	85,778	85,778	85,778	84,665	9,136	9,136	70,307	79,443	70,307	75,558	9,136	1,112	0	-
Ethane (C2H6)	lb/hr	73	219	142	142	292	149	149	149	1,789	1,789	1,789	1,702	142	142	1,097	1,239	1,097	1,105	142	87	0	-
Ethylene (C2H4)	lb/hr	99	296	206	206	395	189	189	189	2,382	2,382	2,382	2,229	206	206	1,584	1,790	1,584	2,382	206	153	1	-
Acetylene (C2H2)	lb/hr	-	-	-	-	-	-	-	-	66	66	66	58	-	-	-	-	-	66	-	8	0	-
Propane (C3H8)	lb/hr	23	69	11	11	92	81	81	81	631	631	631	352	11	11	88	100	88	376	11	279	98	-
i-Butane (C4H10)	lb/hr	-	-	-	-	-	-	-	-	-	-	-	-	-	-	-	-	-	-	-	-	-	-
n-Butane (C4H10)	lb/hr	0	0	0	0	0	0	0	0	2	2	2	1	0	0	0	1	0	2	0	1	1	-
Pentane +	lb/hr	-	-	-	-	-	-	-	-	-	-	-	-	-	-	-	-	-	-	-	-	-	-
Benzene (C6H6)	lb/hr	0	0	0	0	0	0	0	0	5	5	5	0	0	0	0	0	0	5	0	5	0	-
Tar (C10H8)	lb/hr	0	0	0	0	0	0	0	0	0	0	0	0	0	0	0	0	0	0	0	0	0	-
Carbon (Solid)	lb/hr	-	-	-	-	-	-	-	-	-	-	-	-	-	-	-	-	-	-	-	-	-	-
Sulfur (Solid)	lb/hr	-	-	-	-	-	-	-	-	-	-	-	-	-	-	-	-	-	-	-	-	-	-
Olivine + MgO (Solid)	lb/hr	-	-	-	-	-	-	-	-	-	-	-	-	-	-	-	-	-	-	-	-	-	-
Methanol	lb/hr	-	-	-	-	-	-	-	-	62,811	62,811	62,811	1,301	-	-	-	-	-	51,214	-	61,510	43,836	7,377
Ethanol	lb/hr	-	-	-	-	-	-	-	-	52,192	52,192	52,192	533	-	-	-	-	-	439	-	51,659	370	69
Propanol	lb/hr	-	-	-	-	-	-	-	-	5,340	5,340	5,340	22	-	-	-	-	-	0	-	5,318	0	0
n-Butanol	lb/hr	0	0	0	0	0	0	0	0	7	7	7	0	0	0	0	0	0	0	0	7	-	-
Pentanol +	lb/hr	-	-	-	-	-	-	-	-	-	-	-	-	-	-	-	-	-	-	-	-	-	-
Ash	lb/hr	-	-	-	-	-	-	-	-	-	-	-	-	-	-	-	-	-	-	-	-	-	-
Char	lb/hr	-	-	-	-	-	-	-	-	-	-	-	-	-	-	-	-	-	-	-	-	-	-
Wood	lb/hr	-	-	-	-	-	-	-	-	-	-	-	-	-	-	-	-	-	-	-	-	-	-
Enthalpy Flow	MMBTU/hr	(92.9)	(278.8)	(206.4)	(190.2)	(371.8)	(173.2)	(168.9)	(157.9)	(2,601.1)	(2,859.7)	(2,891.1)	(2,366.2)	(228.4)	(218.7)	(1,757.7)	(1,986.1)	(1,732.5)	(2,344.7)	(189.8)	(524.9)	(142.3)	(25.1)

Heat Stream No.	MM BTU/hr	Work Stream No.	HP
QAH413	26.16	WK412-1	(6,341.6)
QCH414	20.65	WK412-2	(9,036.2)
QH418	9.71		
QH419	3.81		
QH420	25.07		
QH421	4.31		
QH422	10.97		
QH423	16.30		
QR410	256.42		



NREL
NATIONAL RENEWABLE ENERGY LABORATORY



Harris Group Inc.
Engineering for Optimum Performance®
www.harrisgroup.com

Scale: NONE
 PMgr: MWW
 Appr: MWW

Drawn: RLL
 Check: MWW
 Engr: MWW
 Check:

NATIONAL RENEWABLE ENERGY LABORATORY
GOLDEN, COLORADO

2011 THERMOCHEMICAL DESIGN REPORT

PROCESS FLOW DIAGRAM
SECTION A400
MIXED ALCOHOL SYNTHESIS

Rev.	Date	By	Description
D	05/27/11	MWW	ISSUED FOR REPORT
C	04/28/11	MWW	ISSUED FOR REVIEW
B	03/08/11	RLL	ISSUED FOR REVIEW
A	12/13/10	RLL	ISSUED FOR REVIEW

Project No.: 30074.00

Drawing: PFD-P820-A402

Rev.

File Location: U:\30074.00 Drawings\FDAs\FDAs-P820 DRAWINGS\FD-P820-A402.dwg
 By: Korinek,Suzanne
 Plot Date: 5/27/11

M-404
METHANOL/H2S
ABSORPTION SYSTEM

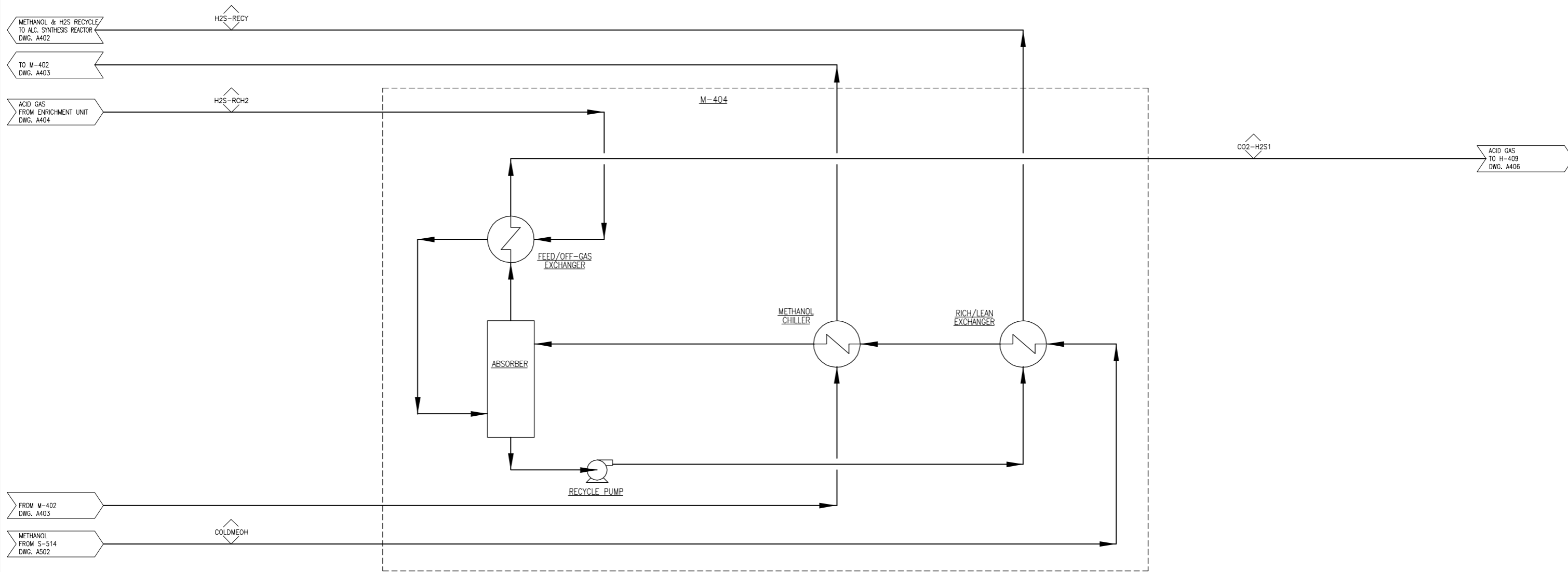

Plot Date: 5/27/11 By: Kacimick,Suzanne File Location: U:\30074.00\Drawings\PFDA\PFDA-PFD-P820 DRAWINGS\PFDA-PFD-P820-A405.dwg

COMPONENT	UNITS	CO2-H2S1	H2S-RCH2	H2S-RECY	COLDMEOH
Total Flow	lb/hr	1,103	1,722	7,749	7,130
Temperature	F	80	110	80	140
Pressure	Psia	28.0	30.0	3,000.0	43.0
Vapor Fraction	-	0.94	0.87	-	-
Hydrogen	lb/hr	-	-	-	-
Carbon Monoxide	lb/hr	-	-	-	-
Nitrogen	lb/hr	-	-	-	-
Oxygen	lb/hr	-	-	-	-
Argon	lb/hr	-	-	-	-
Carbon Dioxide	lb/hr	1,028	1,283	255	-
Water	lb/hr	34	34	-	-
Hydrogen Sulfide (H2S)	lb/hr	41	88	47	-
SO2	lb/hr	-	-	-	-
Ammonia (NH3)	lb/hr	-	0	0	-
NO2	lb/hr	-	-	-	-
Methane (CH4)	lb/hr	-	-	-	-
Ethane (C2H6)	lb/hr	-	-	-	-
Ethylene (C2H4)	lb/hr	-	-	-	-
Acetylene (C2H2)	lb/hr	-	-	-	-
Propane (C3H8)	lb/hr	-	-	-	-
i-Butane (C4H10)	lb/hr	-	-	-	-
n-Butane (C4H10)	lb/hr	-	-	-	-
Pentane +	lb/hr	-	-	-	-
Benzene (C6H6)	lb/hr	-	-	-	-
Tar (C10H8)	lb/hr	-	-	-	-
Carbon (Solid)	lb/hr	-	-	-	-
Sulfur (Solid)	lb/hr	-	-	-	-
Olivine + MgO (Solid)	lb/hr	-	-	-	-
Methanol	lb/hr	-	247	7,377	7,130
Ethanol	lb/hr	-	69	69	-
Propanol	lb/hr	-	0	0	-
n-Butanol	lb/hr	-	-	-	-
Pentanol+	lb/hr	-	-	-	-
Ash	lb/hr	-	-	-	-
Char	lb/hr	-	-	-	-
Wood	lb/hr	-	-	-	-
Enthalpy Flow	MMBTU/hr	(0.0)	(0.1)	(0.3)	(0.2)

Heat Stream No.	MM BTU/hr	Work Stream No.	HP



NREL
NATIONAL RENEWABLE ENERGY LABORATORY



Harris Group Inc.
Engineering for Optimum Performance®
www.harrisgroup.com

Scale: NONE
 PMgr: MWW Drawn: RLL Engr: MWW
 Appr: Check: MWW Check:

**NATIONAL RENEWABLE ENERGY LABORATORY
GOLDEN, COLORADO**

2011 THERMOCHEMICAL DESIGN REPORT

**PROCESS FLOW DIAGRAM
SECTION A400
METHANOL/H2S ABSORPTION**

Project No.:	30074.00	Drawing:	PFD-P820-A405	Rev:	D
--------------	----------	----------	---------------	------	---

Rev.	Date	By	Description
D	05/27/11	MWW	ISSUED FOR REPORT
C	04/28/11	MWW	ISSUED FOR REVIEW
B	03/08/11	RLL	ISSUED FOR REVIEW
A	12/13/10	RLL	ISSUED FOR REVIEW

Plot Date: 5/27/11 Br. Korinek, Susanne File Location: U:\30074.00\Drawings\PTD\A407-PFD-PR20-DRAWINGS\PTD-A407.dwg

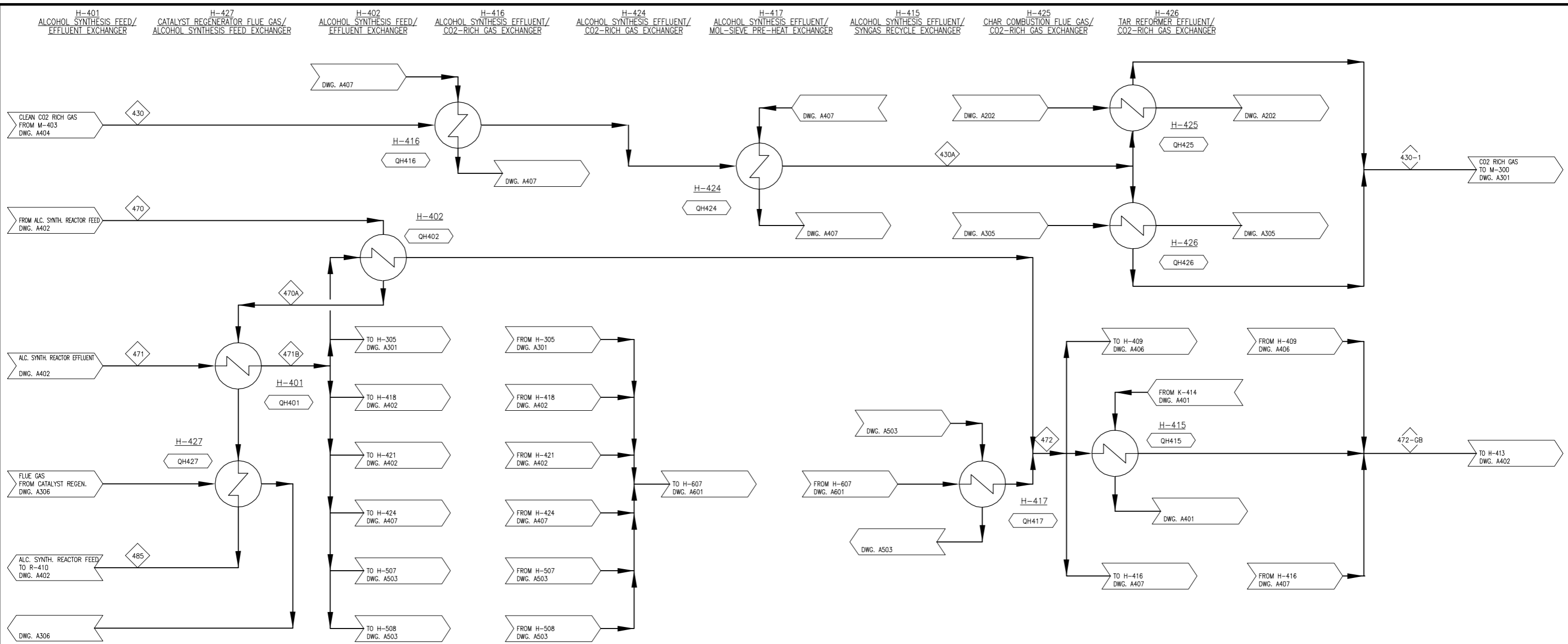

COMPONENT	UNITS	430	430A	430-1	470	470A	471	471B	472	472-GB	485
Total Flow	lb/hr	59,646	59,646	59,646	1,077,813	1,077,813	1,077,813	1,077,813	1,077,813	1,077,813	1,077,813
Temperature	F	94	316	1,170	182	316	611	332	200	175	595
Pressure	Psia	23.0	23.0	19.0	3,000.0	2,952.8	2,952.8	2,947.8	2,945.8	2,945.8	2,995.0
Vapor Fraction		0.99	1.00	1.00	1.00	1.00	1.00	1.00	0.93	0.94	1.00
Hydrogen	lb/hr	8	8	8	55,160	55,160	42,643	42,643	42,643	42,643	55,160
Carbon Monoxide	lb/hr	848	848	848	510,072	510,072	363,914	363,914	363,914	363,914	510,072
Nitrogen	lb/hr	15	15	15	7,134	7,134	7,134	7,134	7,134	7,134	7,134
Oxygen	lb/hr	-	-	-	-	-	-	-	-	-	-
Argon	lb/hr	-	-	-	-	-	-	-	-	-	-
Carbon Dioxide	lb/hr	54,481	54,481	54,481	373,433	373,433	445,094	445,094	445,094	445,094	373,433
Water	lb/hr	869	869	869	421	421	7,261	7,261	7,261	7,261	421
Hydrogen Sulfide (H2S)	lb/hr	1	1	1	144	144	144	144	144	144	144
SO2	lb/hr	-	-	-	-	-	-	-	-	-	-
Ammonia (NH3)	lb/hr	9	9	9	27	27	27	27	27	27	27
NO2	lb/hr	-	-	-	-	-	-	-	-	-	-
Methane (CH4)	lb/hr	1,083	1,083	1,083	75,558	75,558	85,778	85,778	85,778	85,778	75,558
Ethane (C2H6)	lb/hr	314	314	314	1,105	1,105	1,789	1,789	1,789	1,789	1,105
Ethylene (C2H4)	lb/hr	250	250	250	2,382	2,382	2,382	2,382	2,382	2,382	2,382
Acetylene (C2H2)	lb/hr	58	58	58	66	66	66	66	66	66	66
Propane (C3H8)	lb/hr	172	172	172	376	376	631	631	631	631	376
n-Butane (C4H10)	lb/hr	-	-	-	-	-	-	-	-	-	-
N-Butane (C4H10)	lb/hr	-	-	-	2	2	2	2	2	2	2
Pentane +	lb/hr	-	-	-	-	-	-	-	-	-	-
Benzene (C6H6)	lb/hr	-	-	-	5	5	5	5	5	5	5
Tar (C10H8)	lb/hr	-	-	-	0	0	0	0	0	0	0
Carbon (Solid)	lb/hr	-	-	-	-	-	-	-	-	-	-
Sulfur (Solid)	lb/hr	-	-	-	-	-	-	-	-	-	-
Olivine + MgO (Solid)	lb/hr	-	-	-	-	-	-	-	-	-	-
Methanol	lb/hr	1,054	1,054	1,054	51,214	51,214	62,811	62,811	62,811	62,811	51,214
Ethanol	lb/hr	464	464	464	439	439	52,192	52,192	52,192	52,192	439
Propanol	lb/hr	22	22	22	0	0	5,340	5,340	5,340	5,340	0
n-Butanol	lb/hr	-	-	-	0	0	7	7	7	7	0
Pentanol+	lb/hr	-	-	-	-	-	-	-	-	-	-
Ash	lb/hr	-	-	-	-	-	-	-	-	-	-
Char	lb/hr	-	-	-	-	-	-	-	-	-	-
Wood	lb/hr	-	-	-	-	-	-	-	-	-	-
Enthalpy Flow	MMBTU/hr	(2.2)	(2.2)	(2.0)	(25.7)	(24.9)	(26.0)	(27.3)	(28.4)	(28.6)	(23.4)

Heat Stream No.	MM BTU/hr	Work Stream No.	HP
QH401	127.70		
QH402	73.55		
QH415	19.56		
QH416	1.01		
QH417	5.35		
QH424	2.37		
QH425	4.52		
QH426	10.14		
QH427	20.42		



NATIONAL RENEWABLE ENERGY LABORATORY



Harris Group Inc.
Engineering for Optimum Performance®
www.harrisgroup.com

Scale: NONE
 PMgr: MWW
 Appr:

Drawn: RLL
 Check: MWW

Engr: MWW
 Check:

NATIONAL RENEWABLE ENERGY LABORATORY
GOLDEN, COLORADO

2011 THERMOCHEMICAL DESIGN REPORT

PROCESS FLOW DIAGRAM
SECTION A400
MIXED ALCOHOL SYNTHESIS

Project No.: 30074.00

Drawing: PFD-P820-A407

Rev: C

Rev.	Date	By	Description
C	05/27/11	MWW	ISSUED FOR REPORT
B	04/28/11	MWW	ISSUED FOR REVIEW
A	03/08/11	RLL	ISSUED FOR REVIEW

H-406
COMPRESSOR INTERSTAGE/
MOL-SIEVE PRE-HEAT EXCHANGER

H-403
COMPRESSOR INTERSTAGE/
DEAERATOR FEED EXCHANGER

H-407
COMPRESSOR INTERSTAGE/
MOL-SIEVE PRE-HEAT EXCHANGER

H-404
COMPRESSOR INTERSTAGE/
DEAERATOR FEED EXCHANGER

H-408
COMPRESSOR INTERSTAGE/
MOL-SIEVE PRE-HEAT EXCHANGER

H-405
COMPRESSOR INTERSTAGE/
DEAERATOR FEED EXCHANGER

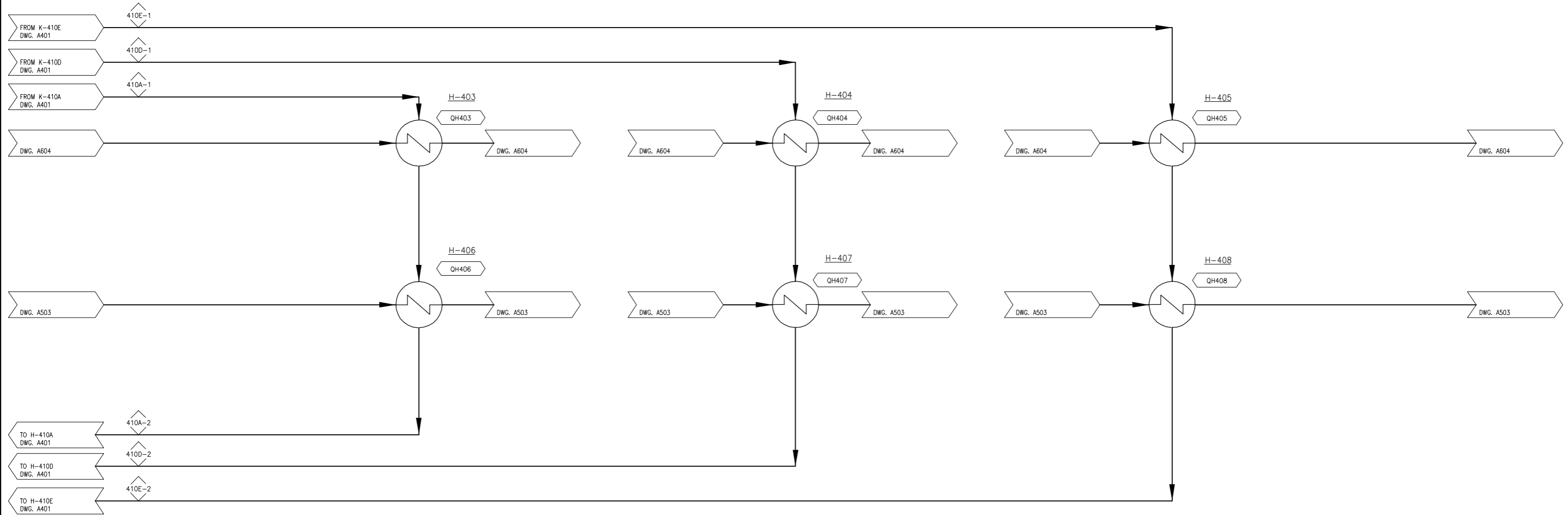

File Location: U:\30074.00\Drawings\PFDA\FD-P820-DRAMING\PFDA-P820-4A408.dwg
 By: Korinek, Suzanne
 Plot Date: 5/27/11

COMPONENT	UNITS	410A-1	410A-2	410D-1	410D-2	410E-1	410E-2
Total Flow	lb/hr	350,451	350,451	317,529	317,529	315,903	315,903
Temperature	F	388	170	360	170	359	170
Pressure	Psia	70.0	68.0	425.0	423.0	1,215.0	1,213.0
Vapor Fraction		1.00	0.98	1.00	1.00	1.00	1.00
Hydrogen	lb/hr	17,862	17,862	17,862	17,862	17,862	17,862
Carbon Monoxide	lb/hr	198,936	198,936	198,936	198,936	198,936	198,936
Nitrogen	lb/hr	1,015	1,015	1,015	1,015	1,015	1,015
Oxygen	lb/hr	-	-	-	-	-	-
Argon	lb/hr	-	-	-	-	-	-
Carbon Dioxide	lb/hr	90,639	90,639	90,638	90,638	90,637	90,637
Water	lb/hr	35,531	35,531	2,616	2,616	991	991
Hydrogen Sulfide (H2S)	lb/hr	80	80	80	80	80	80
SO2	lb/hr	-	-	-	-	-	-
Ammonia (NH3)	lb/hr	26	26	21	21	20	20
NO2	lb/hr	-	-	-	-	-	-
Methane (CH4)	lb/hr	5,250	5,250	5,250	5,250	5,250	5,250
Ethane (C2H6)	lb/hr	8	8	8	8	8	8
Ethylene (C2H4)	lb/hr	797	797	797	797	797	797
Acetylene (C2H2)	lb/hr	66	66	66	66	66	66
Propane (C3H8)	lb/hr	190	190	190	190	190	190
I-Butane (C4H10)	lb/hr	-	-	-	-	-	-
n-Butane (C4H10)	lb/hr	0	0	0	0	0	0
Pentane +	lb/hr	-	-	-	-	-	-
Benzene (C6H6)	lb/hr	5	5	5	5	5	5
Tar (C10H8)	lb/hr	0	0	0	0	0	0
Carbon (Solid)	lb/hr	-	-	-	-	-	-
Sulfur (Solid)	lb/hr	-	-	-	-	-	-
Olivine + MgO (Solid)	lb/hr	-	-	-	-	-	-
Methanol	lb/hr	0	0	0	0	0	0
Ethanol	lb/hr	0	0	0	0	0	0
Propanol	lb/hr	-	-	-	-	-	-
n-Butanol	lb/hr	-	-	-	-	-	-
Pentanol+	lb/hr	-	-	-	-	-	-
Ash	lb/hr	-	-	-	-	-	-
Char	lb/hr	-	-	-	-	-	-
Wood	lb/hr	-	-	-	-	-	-
Enthalpy Flow	MMBTU/hr	(8.5)	(9.0)	(6.7)	(7.0)	(6.6)	(6.9)

Heat Stream No.	MM BTU/hr	Work Stream No.	HP
QH403	25.04		
QH404	15.30		
QH405	15.53		
QH406	15.96		
QH407	11.10		
QH408	11.39		



NREL
NATIONAL RENEWABLE ENERGY LABORATORY



Harris Group Inc.
Engineering for Optimum Performance®
www.harrisgroup.com

Scale: NONE
 PMgr: MWW
 Appr: MWW

Drawn: RLL
 Check: MWW
 Engr: MWW
 Check:

NATIONAL RENEWABLE ENERGY LABORATORY
GOLDEN, COLORADO

2011 THERMOCHEMICAL DESIGN REPORT

PROCESS FLOW DIAGRAM
SECTION A400
SYNGAS COMPRESSION

Rev.	Date	By	Description
C	05/27/11	MWW	ISSUED FOR REPORT
B	04/28/11	MWW	ISSUED FOR REVIEW
A	03/08/11	RLL	ISSUED FOR REVIEW

Project No.:	30074.00
Drawing:	PFD-P820-A408
Rev:	C

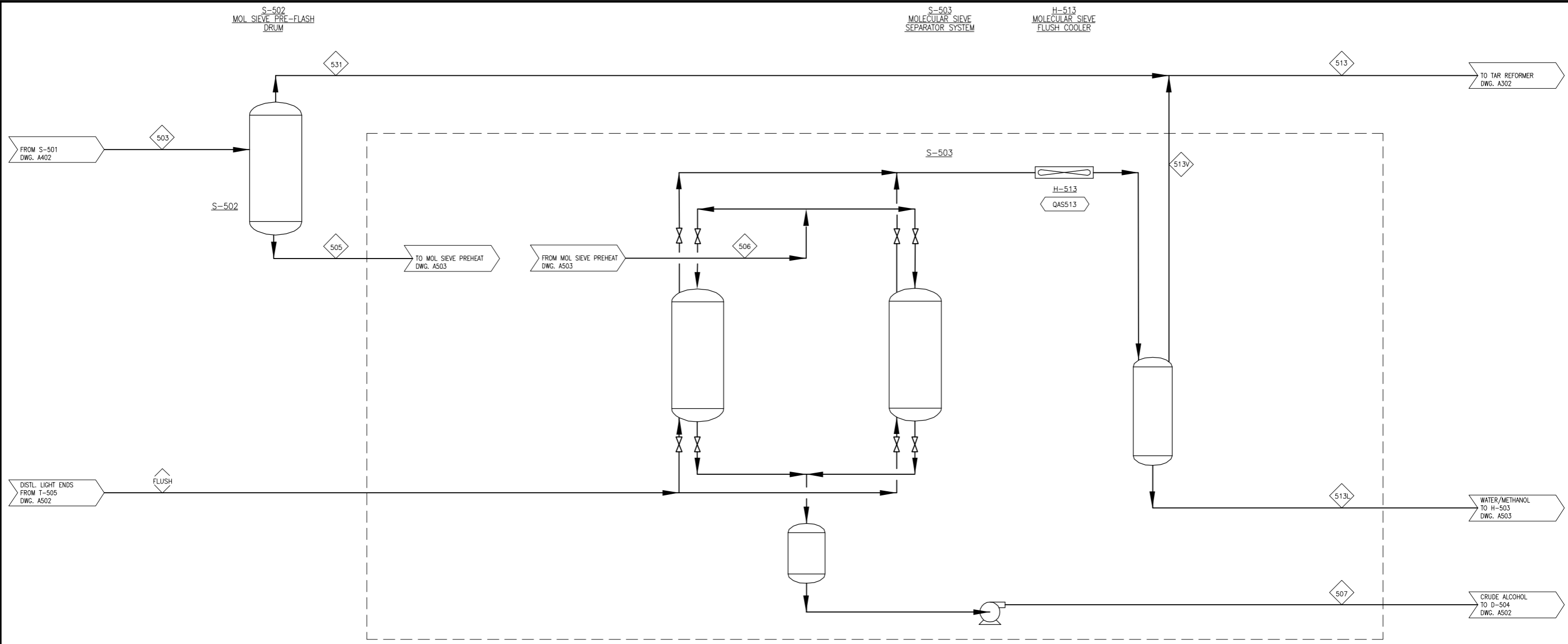

COMPONENT	UNITS	503	505	506	507	513	513L	513V	531	FLUSH
Total Flow	lb/hr	162,485	129,421	129,421	122,834	33,593	15,867	529	33,064	9,808
Temperature	F	110	67	258	229	72	140	140	67	202
Pressure	Psia	2,936.8	60.0	55.0	55.0	40.0	40.0	40.0	60.0	45.0
Vapor Fraction		-	-	1.00	1.00	1.00	-	1.00	1.00	1.00
Hydrogen	lb/hr	130	0	0	0	130	0	0	130	0
Carbon Monoxide	lb/hr	2,298	11	11	11	2,289	0	2	2,287	2
Nitrogen	lb/hr	33	0	0	0	32	0	0	32	0
Oxygen	lb/hr	-	-	-	-	-	-	-	-	-
Argon	lb/hr	-	-	-	-	-	-	-	-	-
Carbon Dioxide	lb/hr	32,030	3,487	3,487	3,487	28,996	69	454	28,543	523
Water	lb/hr	7,211	7,202	7,202	614	19	6,578	9	10	0
Hydrogen Sulfide (H2S)	lb/hr	45	21	21	21	25	2	1	24	3
SO2	lb/hr	-	-	-	-	-	-	-	-	-
Ammonia (NH3)	lb/hr	15	12	12	12	3	2	0	3	2
NO2	lb/hr	-	-	-	-	-	-	-	-	-
Methane (CH4)	lb/hr	1,112	15	15	15	1,100	0	2	1,097	2
Ethane (C2H6)	lb/hr	87	5	5	5	83	0	1	82	1
Ethylene (C2H4)	lb/hr	153	9	9	9	145	0	1	144	1
Acetylene (C2H2)	lb/hr	8	2	2	2	7	0	0	7	0
Propane (C3H8)	lb/hr	279	182	182	182	100	24	4	96	27
i-Butane (C4H10)	lb/hr	-	-	-	-	-	-	-	-	-
n-Butane (C4H10)	lb/hr	1	1	1	1	0	0	0	0	0
Pentane +	lb/hr	-	-	-	-	-	-	-	-	-
Benzene (C6H6)	lb/hr	5	5	5	5	0	0	0	0	0
Tar (C10H8)	lb/hr	0	0	0	0	0	-	-	0	-
Carbon (Solid)	lb/hr	-	-	-	-	-	-	-	-	-
Sulfur (Solid)	lb/hr	-	-	-	-	-	-	-	-	-
Olivine + MgO (Solid)	lb/hr	-	-	-	-	-	-	-	-	-
Methanol	lb/hr	61,510	61,078	61,078	61,078	487	9,069	55	432	9,123
Ethanol	lb/hr	51,659	51,495	51,495	51,495	164	76	0	164	76
Propanol	lb/hr	5,318	5,311	5,311	5,311	6	-	-	6	0
n-Butanol	lb/hr	7	7	7	7	0	-	-	0	-
Pentanol+	lb/hr	-	-	-	-	-	-	-	-	-
Ash	lb/hr	-	-	-	-	-	-	-	-	-
Char	lb/hr	-	-	-	-	-	-	-	-	-
Wood	lb/hr	-	-	-	-	-	-	-	-	-
Enthalpy Flow	MMBTU/hr	(5.2)	(4.1)	(3.4)	(3.0)	(1.2)	(0.7)	(0.0)	(1.2)	(0.3)

Heat Stream No.	MM BTU/hr	Work Stream No.	HP
QAS513	11.71		

Harris Group Inc.
Engineering for Optimum Performance®
www.harrisgroup.com

Scale: NONE
PMgr: MWW
Appr: MWW

Drawn: RLL
Check: MWW

Engr: MWW
Check:

NATIONAL RENEWABLE ENERGY LABORATORY
GOLDEN, COLORADO

2011 THERMOCHEMICAL DESIGN REPORT

PROCESS FLOW DIAGRAM
SECTION A500
ALCOHOL PURIFICATION

Project No.: 30074.00
Drawing: PFD-P820-A501
Rev:

Rev.	Date	By	Description
D	05/27/11	MWW	ISSUED FOR REPORT
C	04/28/11	MWW	ISSUED FOR REVIEW
B	03/08/11	RLL	ISSUED FOR REVIEW
A	12/13/10	RLL	ISSUED FOR REVIEW

File Location: U:\30074.00\Drawings\PDF\A500_DRAWINGS\FD-P820-P820-A501.dwg
 By: Korina, Susanne
 Plot Date: 5/27/11

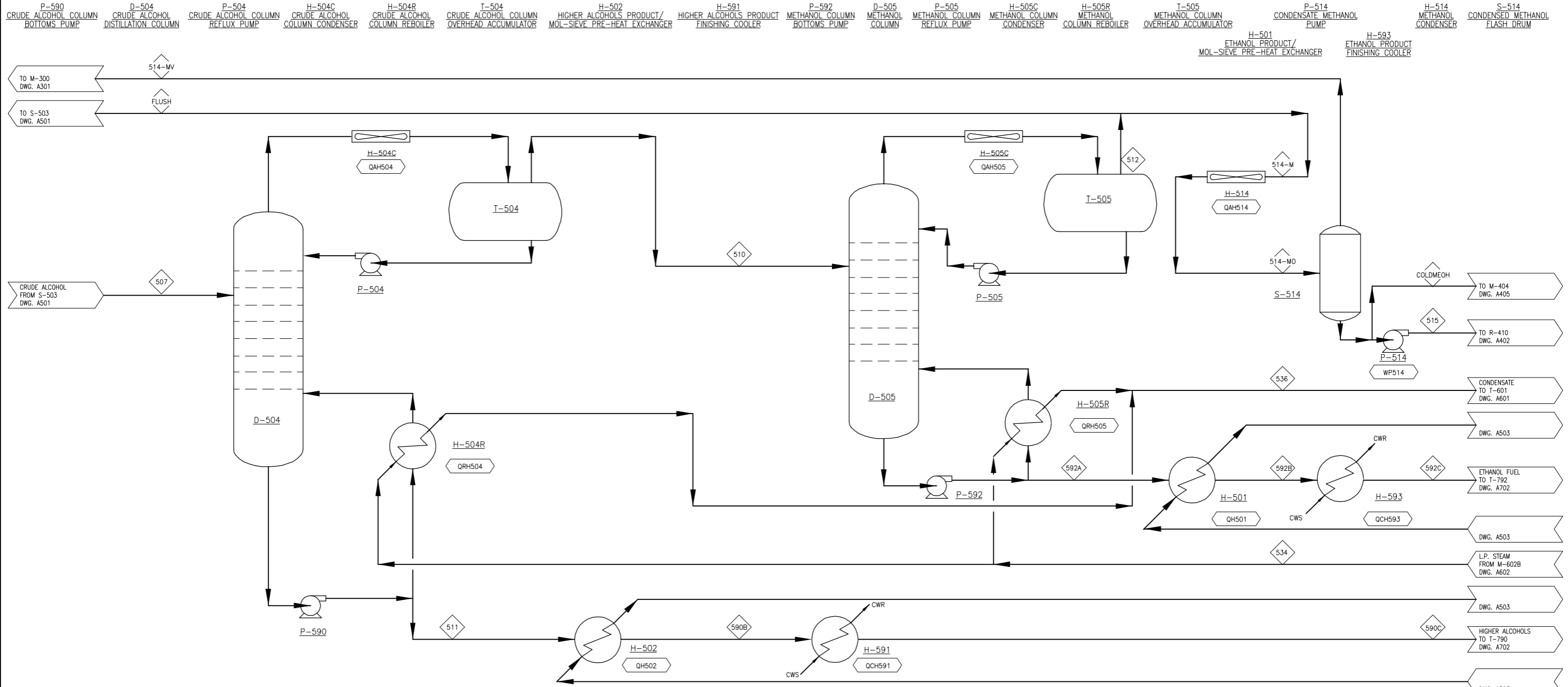

COMPONENT	UNITS	507	510	511	512	514-M	514-MO	514-MV	515	534	536	590B	590C	592A	592B	592C	COLDMEOH	FLUSH
Total Flow	lb/hr	122,834	116,386	6,448	65,385	55,578	55,578	3,298	44,966	102,663	102,663	6,448	6,448	51,000	3,298	51,000	7,314	9,808
Temperature	F	229	214	265	202	202	140	140	164	654	287	120	110	230	120	110	140	202
Pressure	Psia	55.0	45.0	45.0	45.0	45.0	43.0	43.0	3,001.0	64.7	54.7	40.0	35.0	45.0	40.0	35.0	43.0	45.0
Vapor Fraction		1.00	1.00	0.00	1.00	1.00	0.05	1.00		1.00							43.0	1.00
Hydrogen	lb/hr	0	0	-	0	0	0	0	0	-	-	-	-	-	-	-	0	0
Carbon Monoxide	lb/hr	11	11	-	11	10	10	9	0	-	-	-	-	-	-	-	0	2
Nitrogen	lb/hr	0	0	-	0	0	0	0	0	-	-	-	-	-	-	-	0	0
Oxygen	lb/hr	-	-	-	-	-	-	-	-	-	-	-	-	-	-	-	-	-
Argon	lb/hr	-	-	-	-	-	-	-	-	-	-	-	-	-	-	-	-	-
Carbon Dioxide	lb/hr	3,487	3,487	-	3,487	2,964	2,964	2,472	423	-	-	-	-	-	-	-	69	523
Water	lb/hr	614	0	614	0	0	0	-	-	102,663	102,663	614	614	0	0	0	-	0
Hydrogen Sulfide (H2S)	lb/hr	21	21	0	21	18	18	8	9	-	-	0	0	-	-	-	1	3
SO2	lb/hr	-	-	-	-	-	-	-	-	-	-	-	-	-	-	-	-	-
Ammonia (NH3)	lb/hr	12	12	0	12	10	10	3	6	-	-	0	0	-	-	-	1	2
NO2	lb/hr	-	-	-	-	-	-	-	-	-	-	-	-	-	-	-	-	-
Methane (CH4)	lb/hr	15	15	-	15	13	13	12	0	-	-	-	-	-	-	-	0	2
Ethane (C2H6)	lb/hr	5	5	-	5	4	4	4	0	-	-	-	-	-	-	-	0	1
Ethylene (C2H4)	lb/hr	9	9	0	9	8	8	6	1	-	-	0	0	-	-	-	0	1
Acetylene (C2H2)	lb/hr	2	2	-	2	1	1	1	0	-	-	-	-	-	-	-	0	0
Propane (C3H8)	lb/hr	182	182	0	182	155	155	42	98	-	-	0	0	-	-	-	16	27
i-Butane (C4H10)	lb/hr	-	-	-	-	-	-	-	-	-	-	-	-	-	-	-	-	-
n-Butane (C4H10)	lb/hr	1	1	0	1	1	1	0	1	-	-	0	0	0	0	0	0	0
Pentane +	lb/hr	-	-	-	-	-	-	-	-	-	-	-	-	-	-	-	-	-
Benzene (C6H6)	lb/hr	5	3	2	0	0	0	0	0	-	-	2	2	3	3	3	0	0
Tar (C10H8)	lb/hr	0	-	0	-	-	-	-	-	-	-	0	0	-	-	-	-	-
Carbon (Solid)	lb/hr	-	-	-	-	-	-	-	-	-	-	-	-	-	-	-	-	-
Sulfur (Solid)	lb/hr	-	-	-	-	-	-	-	-	-	-	-	-	-	-	-	-	-
Olivine + MgO (Solid)	lb/hr	-	-	-	-	-	-	-	-	-	-	-	-	-	-	-	-	-
Methanol	lb/hr	61,078	61,077	0	60,822	51,699	51,699	732	43,836	-	-	0	0	256	256	256	7,130	9,123
Ethanol	lb/hr	51,495	50,980	515	510	433	433	3	370	-	-	515	515	50,470	50,470	50,470	60	76
Propanol	lb/hr	5,311	53	5,258	0	0	0	-	-	-	-	5,258	5,258	53	53	53	-	0
n-Butanol	lb/hr	7	0	7	-	-	-	-	-	-	-	7	7	-	-	-	-	-
Pentanol +	lb/hr	-	-	-	-	-	-	-	-	-	-	-	-	-	-	-	-	-
Ash	lb/hr	-	-	-	-	-	-	-	-	-	-	-	-	-	-	-	-	-
Char	lb/hr	-	-	-	-	-	-	-	-	-	-	-	-	-	-	-	-	-
Wood	lb/hr	-	-	-	-	-	-	-	-	-	-	-	-	-	-	-	-	-
Enthalpy Flow	MMBTU/hr	(3.0)	(2.9)	(0.2)	(1.8)	(1.5)	(1.8)	(0.1)	(1.4)	(5.7)	(6.8)	(0.2)	(0.2)	(1.3)	(1.3)	(1.3)	(0.2)	13 (0.3)

Heat Stream No.	MM BTU/hr	Work Stream No.	HP
QH501	4.81	WP514	372.4
QH502	0.76		
QAH504	35.16		
QAH505	94.49		
QCH591	0.05		
QCH593	0.40		
QRH504	(32.40)		
QRH505	(77.56)		
QAH514	25.88		



NATIONAL RENEWABLE ENERGY LABORATORY



Harris Group Inc.
Engineering for Optimum Performance®
www.harrisgroup.com

Scale: NONE
 Pmgr: MWW
 Appr: MWW

Drawn: RLL
 Check: MWW

Engr: MWW
 Check:

**NATIONAL RENEWABLE ENERGY LABORATORY
GOLDEN, COLORADO**

2011 THERMOCHEMICAL DESIGN REPORT

**PROCESS FLOW DIAGRAM
SECTION A500
ALCOHOL PURIFICATION**

Rev.	Date	By	Description
D	05/27/11	MWW	ISSUED FOR REPORT
C	04/28/11	MWW	ISSUED FOR REVIEW
B	03/08/11	RLL	ISSUED FOR REVIEW
A	12/13/10	RLL	ISSUED FOR REVIEW

Project No.: 30074.00
 Drawing: PFD-P820-A502
 Rev: 

Plot Date: 5/27/11
 By: Koriek, Susanna
 File Location: U:\30074.00\Drawings\FPDs\FPD-P820-DRAWINGS\FPD-P820-A502.dwg

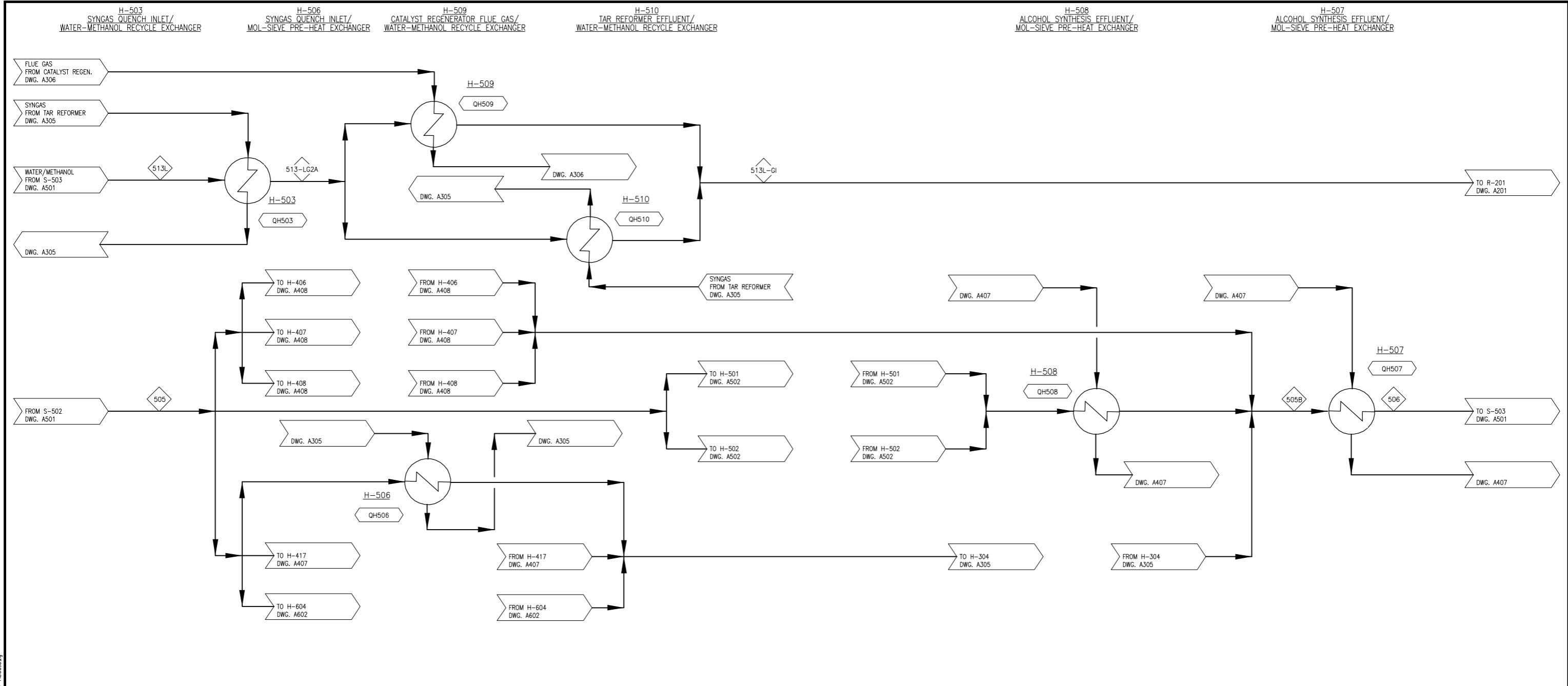

COMPONENT	UNITS	505	505B	506	513L	513L-G1	513-LG2A
Total Flow	lb/hr	129,421	129,421	129,421	15,867	15,867	15,867
Temperature	F	67	238	258	140	590	316
Pressure	Psia	60.0	55.0	55.0	40.0	35.0	35.0
Vapor Fraction		1.00	1.00	1.00	1.00	1.00	1.00
Hydrogen	lb/hr	0	0	0	0	0	0
Carbon Monoxide	lb/hr	11	11	11	0	0	0
Nitrogen	lb/hr	0	0	0	0	0	0
Oxygen	lb/hr	-	-	-	-	-	-
Argon	lb/hr	-	-	-	-	-	-
Carbon Dioxide	lb/hr	3,487	3,487	3,487	69	69	69
Water	lb/hr	7,202	7,202	7,202	6,578	6,578	6,578
Hydrogen Sulfide (H2S)	lb/hr	21	21	21	2	2	2
SO2	lb/hr	-	-	-	-	-	-
Ammonia (NH3)	lb/hr	12	12	12	2	2	2
NO2	lb/hr	-	-	-	-	-	-
Methane (CH4)	lb/hr	15	15	15	0	0	0
Ethane (C2H6)	lb/hr	5	5	5	0	0	0
Ethylene (C2H4)	lb/hr	9	9	9	0	0	0
Acetylene (C2H2)	lb/hr	2	2	2	0	0	0
Propane (C3H8)	lb/hr	182	182	182	24	24	24
i-Butane (C4H10)	lb/hr	-	-	-	-	-	-
n-Butane (C4H10)	lb/hr	1	1	1	0	0	0
Pentane +	lb/hr	-	-	-	-	-	-
Benzene (C6H6)	lb/hr	5	5	5	0	0	0
Tar (C10H8)	lb/hr	0	0	0	-	-	-
Carbon (Solid)	lb/hr	-	-	-	-	-	-
Sulfur (Solid)	lb/hr	-	-	-	-	-	-
Olivine + MgO (Solid)	lb/hr	-	-	-	-	-	-
Methanol	lb/hr	61,078	61,078	61,078	9,069	9,069	9,069
Ethanol	lb/hr	51,495	51,495	51,495	76	76	76
Propanol	lb/hr	5,311	5,311	5,311	-	-	-
n-Butanol	lb/hr	7	7	7	-	-	-
Pentanol+	lb/hr	-	-	-	-	-	-
Ash	lb/hr	-	-	-	-	-	-
Char	lb/hr	-	-	-	-	-	-
Wood	lb/hr	-	-	-	-	-	-
Enthalpy Flow	MMBTU/hr	(4.1)	(3.4)	(3.4)	(0.7)	(0.6)	(0.6)

Heat Stream No.	MM BTU/hr	Work Stream No.	HP
QH503	12.14		
QH506	10.42		
QH507	1.03		
QH508	0.88		
QH509	0.48		
QH510	1.52		



NREL
NATIONAL RENEWABLE ENERGY LABORATORY



Harris Group Inc.
Engineering for Optimum Performance®
www.harrisgroup.com

Scale: NONE
 PMgr: MWW
 Appr:

Drawn: RLL
 Check: MWW
 Engr: MWW
 Check:

NATIONAL RENEWABLE ENERGY LABORATORY
GOLDEN, COLORADO

2011 THERMOCHEMICAL DESIGN REPORT

PROCESS FLOW DIAGRAM
SECTION A500
ALCOHOL PURIFICATION

Rev.	Date	By	Description
C	05/27/11	MWW	ISSUED FOR REPORT
B	04/28/11	MWW	ISSUED FOR REVIEW
A	03/08/11	RLL	ISSUED FOR REVIEW

Project No.:	30074.00
Drawing:	PFD-P820-A503
Rev:	C

File Location: U:\30074.00\Drawings\FPDs\F820_DRMINGS\F820_P820-A503.dwg
 Plot Date: 5/27/11 By: Kocmek,Suzanne

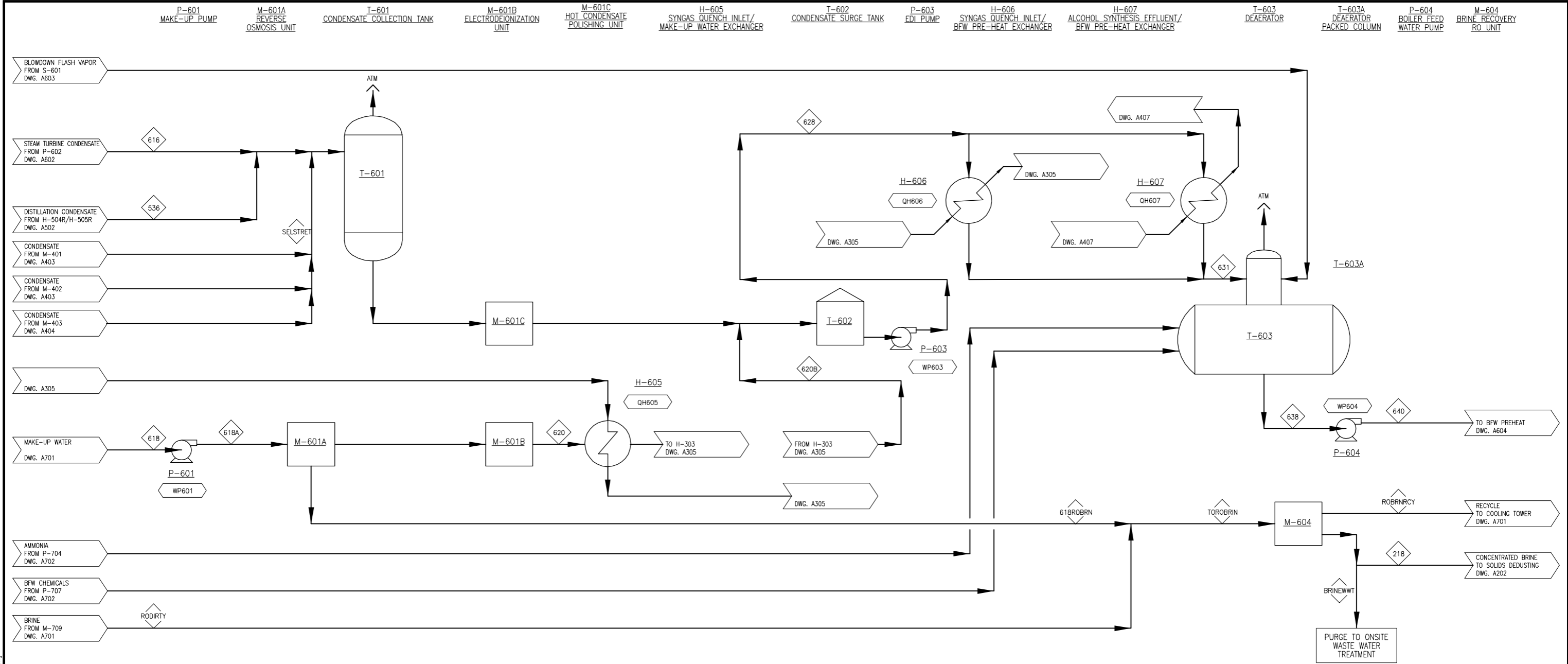

COMPONENT	UNITS	218	536	616	618	618A	620	620B	618ROBRN	628	631	638	640	BRINWWT	ROBRNRCY	RODIRTY	SELSTRET	TOROBRIN
Total Flow	lb/hr	243	102,663	245,642	101,798	101,798	76,349	76,349	25,450	476,788	476,788	476,791	476,791	7,710	23,858	6,361	52,134	31,811
Temperature	F	66	287	136	60	60	60	239	60	198	232	232	235	66	66	90	289	66
Pressure	Psia	75.0	54.7	24.7	14.7	75.0	29.7	24.7	15.0	39.7	21.7	21.7	1,351.0	75.0	75.0	14.7	54.7	14.7
Vapor Fraction																		
Hydrogen	lb/hr	-	-	-	-	-	-	-	-	-	-	-	-	-	-	-	-	-
Carbon Monoxide	lb/hr	-	-	-	-	-	-	-	-	-	-	-	-	-	-	-	-	-
Nitrogen	lb/hr	-	-	-	-	-	-	-	-	-	-	-	-	-	-	-	-	-
Oxygen	lb/hr	-	-	-	-	-	-	-	-	-	-	-	-	-	-	-	-	-
Argon	lb/hr	-	-	-	-	-	-	-	-	-	-	-	-	-	-	-	-	-
Carbon Dioxide	lb/hr	-	-	-	-	-	-	-	-	-	-	-	-	-	-	-	-	-
Water	lb/hr	243	102,663	245,642	101,798	101,798	76,349	76,349	25,450	476,788	476,788	476,791	476,791	7,710	23,858	6,361	52,134	31,811
Hydrogen Sulfide (H2S)	lb/hr	-	-	-	-	-	-	-	-	-	-	-	-	-	-	-	-	-
SO2	lb/hr	-	-	-	-	-	-	-	-	-	-	-	-	-	-	-	-	-
Ammonia (NH3)	lb/hr	-	-	-	-	-	-	-	-	-	-	-	-	-	-	-	-	-
NO2	lb/hr	-	-	-	-	-	-	-	-	-	-	-	-	-	-	-	-	-
Methane (CH4)	lb/hr	-	-	-	-	-	-	-	-	-	-	-	-	-	-	-	-	-
Ethane (C2H6)	lb/hr	-	-	-	-	-	-	-	-	-	-	-	-	-	-	-	-	-
Ethylene (C2H4)	lb/hr	-	-	-	-	-	-	-	-	-	-	-	-	-	-	-	-	-
Acetylene (C2H2)	lb/hr	-	-	-	-	-	-	-	-	-	-	-	-	-	-	-	-	-
Propane (C3H8)	lb/hr	-	-	-	-	-	-	-	-	-	-	-	-	-	-	-	-	-
i-Butane (C4H10)	lb/hr	-	-	-	-	-	-	-	-	-	-	-	-	-	-	-	-	-
n-Butane (C4H10)	lb/hr	-	-	-	-	-	-	-	-	-	-	-	-	-	-	-	-	-
Pentane +	lb/hr	-	-	-	-	-	-	-	-	-	-	-	-	-	-	-	-	-
Benzene (C6H6)	lb/hr	-	-	-	-	-	-	-	-	-	-	-	-	-	-	-	-	-
Tar (C10H8)	lb/hr	-	-	-	-	-	-	-	-	-	-	-	-	-	-	-	-	-
Carbon (Solid)	lb/hr	-	-	-	-	-	-	-	-	-	-	-	-	-	-	-	-	-
Sulfur (Solid)	lb/hr	-	-	-	-	-	-	-	-	-	-	-	-	-	-	-	-	-
Olivine + MgO (Solid)	lb/hr	-	-	-	-	-	-	-	-	-	-	-	-	-	-	-	-	-
Methanol	lb/hr	-	-	-	-	-	-	-	-	-	-	-	-	-	-	-	-	-
Ethanol	lb/hr	-	-	-	-	-	-	-	-	-	-	-	-	-	-	-	-	-
Propanol	lb/hr	-	-	-	-	-	-	-	-	-	-	-	-	-	-	-	-	-
n-Butanol	lb/hr	-	-	-	-	-	-	-	-	-	-	-	-	-	-	-	-	-
Pentanol+	lb/hr	-	-	-	-	-	-	-	-	-	-	-	-	-	-	-	-	-
Ash	lb/hr	-	-	-	-	-	-	-	-	-	-	-	-	-	-	-	-	-
Char	lb/hr	-	-	-	-	-	-	-	-	-	-	-	-	-	-	-	-	-
Wood	lb/hr	-	-	-	-	-	-	-	-	-	-	-	-	-	-	-	-	-
Enthalpy Flow	MMBTU/hr	(0.0)	(6.8)	(16.6)	(7.0)	(7.0)	(5.2)	(5.1)	(1.7)	(32.0)	(31.8)	(31.8)	(31.8)	(0.5)	(1.6)	(0.4)	(3.5)	(2.2)

Heat Stream No.	MM BTU/hr	Work Stream No.	HP
QH605	6.50	WP601	13.8
QH606	6.50	WP603	18.7
QH607	9.98	WP604	1,046.7



NREL
NATIONAL RENEWABLE ENERGY LABORATORY



Harris Group Inc.
Engineering for Optimum Performance®
www.harrisgroup.com

Scale: NONE
 PMgr: MWW
 Appr:

Drawn: RLL
 Check: MWW
 Engr: MWW
 Check:

NATIONAL RENEWABLE ENERGY LABORATORY
GOLDEN, COLORADO

2011 THERMOCHEMICAL DESIGN REPORT

PROCESS FLOW DIAGRAM
SECTION A600
STEAM SYSTEM & POWER GENERATION

Rev.	Date	By	Description
D	05/27/11	MWW	ISSUED FOR REPORT
C	04/28/11	MWW	ISSUED FOR REVIEW
B	03/08/11	RLL	ISSUED FOR REVIEW
A	12/13/10	RLL	ISSUED FOR REVIEW

Project No.: 30074.00
 Drawing: PFD-P820-A601
 Rev: 

File Location: U:\30074.00 Drawings\PFDs\A600\DRAWINGS\PFD-P820-A601.dwg
 Plot Date: 5/27/11
 Br: Kocinek,Susanne

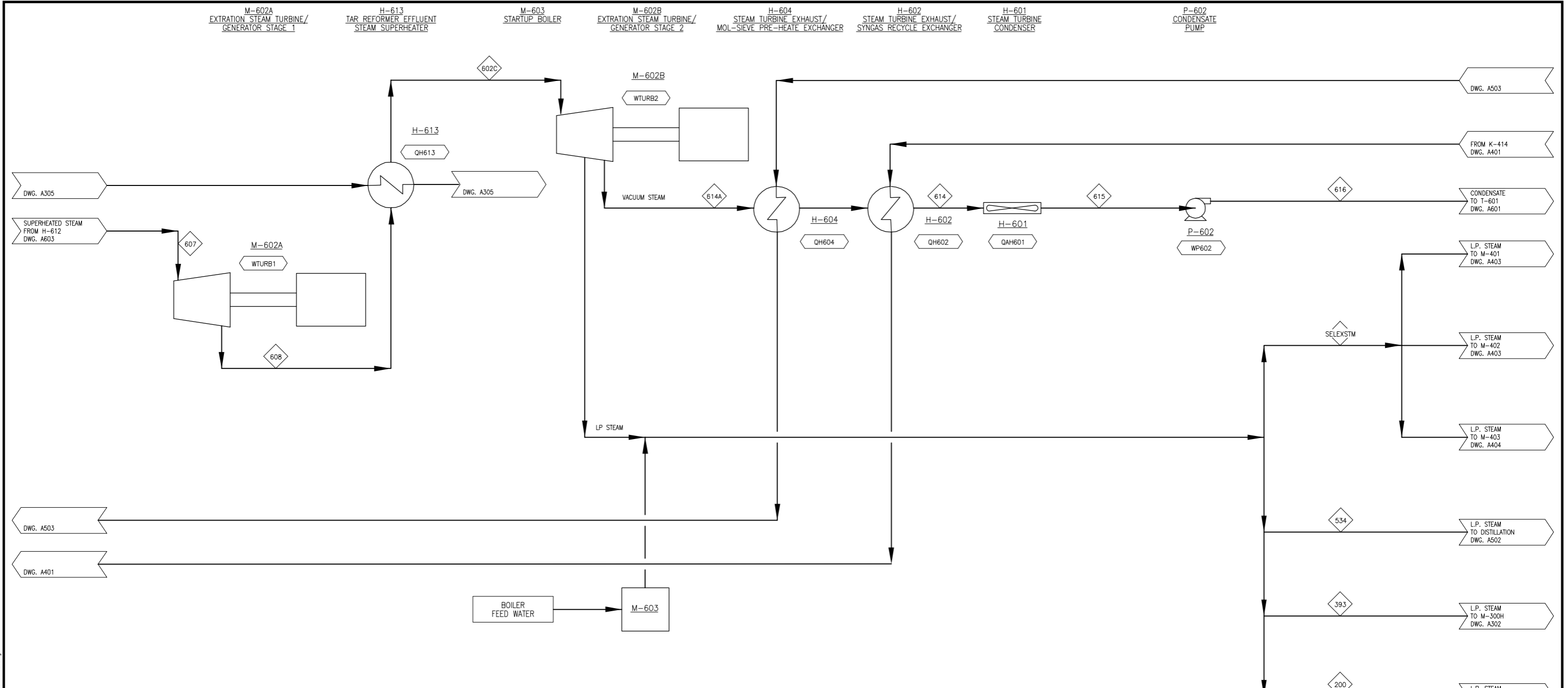

COMPONENT	UNITS	200	393	534	602C	607	608	614A	615	616	SELEXSTM
Total Flow	lb/hr	66,542	274	102,663	467,255	467,255	467,255	245,642	245,642	245,642	52,134
Temperature	F	649	654	654	1,000	1,000	698	234	136	136	654
Pressure	Psia	25.0	64.7	64.7	345.0	1,321.0	350.0	3.5	2.6	24.7	64.7
Vapor Fraction		1.00	1.00	1.00	1.00	1.00	1.00	1.00	1.00	1.00	1.00
Hydrogen	lb/hr	-	-	-	-	-	-	-	-	-	-
Carbon Monoxide	lb/hr	-	-	-	-	-	-	-	-	-	-
Nitrogen	lb/hr	-	-	-	-	-	-	-	-	-	-
Oxygen	lb/hr	-	-	-	-	-	-	-	-	-	-
Argon	lb/hr	-	-	-	-	-	-	-	-	-	-
Carbon Dioxide	lb/hr	-	-	-	-	-	-	-	-	-	-
Water	lb/hr	66,542	274	102,663	467,255	467,255	467,255	245,642	245,642	245,642	52,134
Hydrogen Sulfide (H2S)	lb/hr	-	-	-	-	-	-	-	-	-	-
SO2	lb/hr	-	-	-	-	-	-	-	-	-	-
Ammonia (NH3)	lb/hr	-	-	-	-	-	-	-	-	-	-
NO2	lb/hr	-	-	-	-	-	-	-	-	-	-
Methane (CH4)	lb/hr	-	-	-	-	-	-	-	-	-	-
Ethane (C2H6)	lb/hr	-	-	-	-	-	-	-	-	-	-
Ethylene (C2H4)	lb/hr	-	-	-	-	-	-	-	-	-	-
Acetylene (C2H2)	lb/hr	-	-	-	-	-	-	-	-	-	-
Propane (C3H8)	lb/hr	-	-	-	-	-	-	-	-	-	-
I-Butane (C4H10)	lb/hr	-	-	-	-	-	-	-	-	-	-
N-Butane (C4H10)	lb/hr	-	-	-	-	-	-	-	-	-	-
Pentane +	lb/hr	-	-	-	-	-	-	-	-	-	-
Benzene (C6H6)	lb/hr	-	-	-	-	-	-	-	-	-	-
Tar (C10H8)	lb/hr	-	-	-	-	-	-	-	-	-	-
Carbon (Solid)	lb/hr	-	-	-	-	-	-	-	-	-	-
Sulfur (Solid)	lb/hr	-	-	-	-	-	-	-	-	-	-
Olivine + MgO (Solid)	lb/hr	-	-	-	-	-	-	-	-	-	-
Methanol	lb/hr	-	-	-	-	-	-	-	-	-	-
Ethanol	lb/hr	-	-	-	-	-	-	-	-	-	-
Propanol	lb/hr	-	-	-	-	-	-	-	-	-	-
n-Butanol	lb/hr	-	-	-	-	-	-	-	-	-	-
Pentanol+	lb/hr	-	-	-	-	-	-	-	-	-	-
Ash	lb/hr	-	-	-	-	-	-	-	-	-	-
Char	lb/hr	-	-	-	-	-	-	-	-	-	-
Wood	lb/hr	-	-	-	-	-	-	-	-	-	-
Enthalpy Flow	MMBTU/hr	(3.7)	(0.0)	(5.7)	(25.0)	(25.1)	(25.7)	(14.0)	(16.6)	(16.6)	(2.9)

Heat Stream No.	MM BTU/hr	Work Stream No.	HP
QAH601	252.27	WTURB1	(23,244.0)
QH602	3.92	WTURB2	(47,755.1)
QH604	4.38	WP602	9.0
QH613	74.62		



NREL
NATIONAL RENEWABLE ENERGY LABORATORY



Harris Group Inc.
Engineering for Optimum Performance®
www.harrisgroup.com

Scale: NONE
 PMgr: MWW Drawn: RLL Engr: MWW
 Appr: Check: MWW Check:

NATIONAL RENEWABLE ENERGY LABORATORY
GOLDEN, COLORADO

2011 THERMOCHEMICAL DESIGN REPORT

PROCESS FLOW DIAGRAM
SECTION A600
STEAM SYSTEM & POWER GENERATION

Project No.: 30074.00 Drawing: PFD-P820-A602 Rev: A

Rev.	Date	By	Description
D	05/27/11	MWW	ISSUED FOR REPORT
C	04/28/11	MWW	ISSUED FOR REVIEW
B	03/08/11	RLL	ISSUED FOR REVIEW
A	12/13/10	RLL	ISSUED FOR REVIEW

Plot Date: 5/27/11 By: Korinek,Susanne File Location: U:\30074\00\Drawings\FEDS\FEDS-P820_DRAWINGS\FEDS-P820-A602.dwg

T-605
STEAM
DRUM

S-601
BLOWDOWN
FLASH DRUM

H-603
BLOWDOWN COOLER

H-612
CHAR COMBUSTION FLUE
GAS STEAM SUPERHEATER

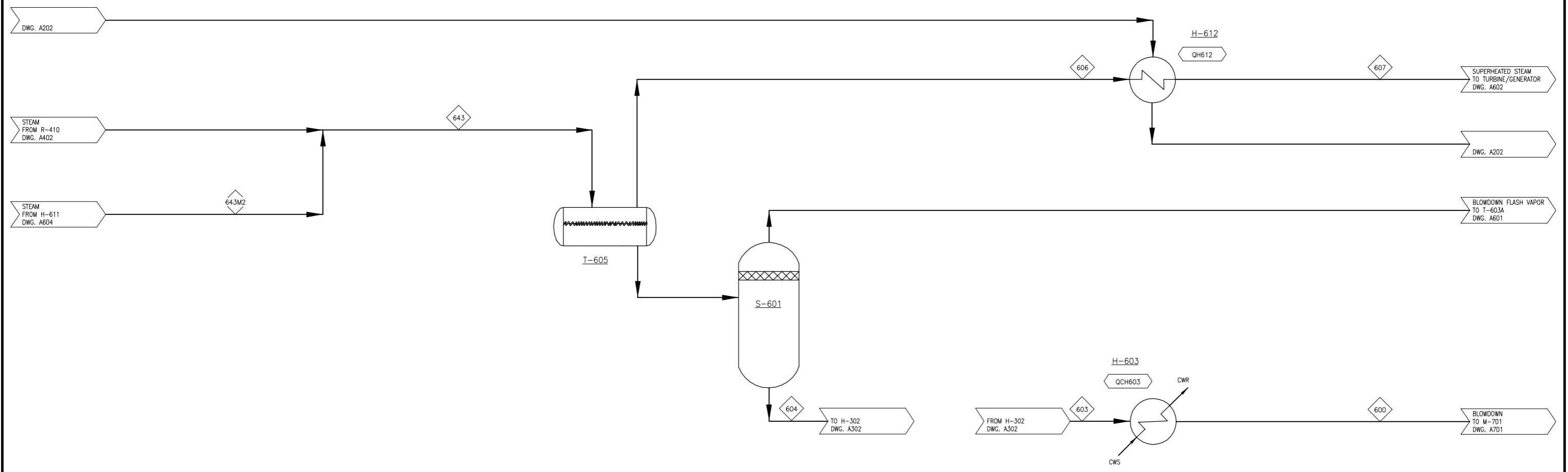

COMPONENT	UNITS	600	603	604	606	607	643	643M2
Total Flow	lb/hr	9,536	9,536	9,536	467,255	467,255	476,791	30,758
Temperature	F	113	160	581	580	1,000	581	581
Pressure	Psia	14.7	1,331.0	1,336.0	1,326.0	1,321.0	1,336.0	1,336.0
Vapor Fraction					1.00	1.00	0.98	0.98
Hydrogen	lb/hr	-	-	-	-	-	-	-
Carbon Monoxide	lb/hr	-	-	-	-	-	-	-
Nitrogen	lb/hr	-	-	-	-	-	-	-
Oxygen	lb/hr	-	-	-	-	-	-	-
Argon	lb/hr	-	-	-	-	-	-	-
Carbon Dioxide	lb/hr	-	-	-	-	-	-	-
Water	lb/hr	9,536	9,536	9,536	467,255	467,255	476,791	30,758
Hydrogen Sulfide (H2S)	lb/hr	-	-	-	-	-	-	-
SO2	lb/hr	-	-	-	-	-	-	-
Ammonia (NH3)	lb/hr	-	-	-	-	-	-	-
NO2	lb/hr	-	-	-	-	-	-	-
Methane (CH4)	lb/hr	-	-	-	-	-	-	-
Ethane (C2H6)	lb/hr	-	-	-	-	-	-	-
Ethylene (C2H4)	lb/hr	-	-	-	-	-	-	-
Acetylene (C2H2)	lb/hr	-	-	-	-	-	-	-
Propane (C3H8)	lb/hr	-	-	-	-	-	-	-
I-Butane (C4H10)	lb/hr	-	-	-	-	-	-	-
N-Butane (C4H10)	lb/hr	-	-	-	-	-	-	-
Pentane +	lb/hr	-	-	-	-	-	-	-
Benzene (C6H6)	lb/hr	-	-	-	-	-	-	-
Tar (C10H8)	lb/hr	-	-	-	-	-	-	-
Carbon (Solid)	lb/hr	-	-	-	-	-	-	-
Sulfur (Solid)	lb/hr	-	-	-	-	-	-	-
Olivine + MgO (Solid)	lb/hr	-	-	-	-	-	-	-
Methanol	lb/hr	-	-	-	-	-	-	-
Ethanol	lb/hr	-	-	-	-	-	-	-
Propanol	lb/hr	-	-	-	-	-	-	-
n-Butanol	lb/hr	-	-	-	-	-	-	-
Pentanol+	lb/hr	-	-	-	-	-	-	-
Ash	lb/hr	-	-	-	-	-	-	-
Char	lb/hr	-	-	-	-	-	-	-
Wood	lb/hr	-	-	-	-	-	-	-
Enthalpy Flow	MMBTU/hr	(0.7)	(0.6)	(0.6)	(26.6)	(25.1)	(27.2)	(1.8)

Heat Stream No.	MM BTU/hr	Work Stream No.	HP
QCH603	0.47		
QH612	147.91		



NREL
NATIONAL RENEWABLE ENERGY LABORATORY



Harris Group Inc.
Engineering for Optimum Performance®
www.harrisgroup.com

Scale: NONE
 PMgr: MWW
 Appr:

Drawn: RLL
 Check: MWW

Engr: MWW
 Check:

NATIONAL RENEWABLE ENERGY LABORATORY
GOLDEN, COLORADO

2011 THERMOCHEMICAL DESIGN REPORT

PROCESS FLOW DIAGRAM
SECTION A600
STEAM SYSTEM & POWER GENERATION

Project No.: 30074.00

Rev. Date By Description

D	05/23/11	MWW	ISSUED FOR REPORT
C	04/28/11	MWW	ISSUED FOR REVIEW
B	03/08/11	RLL	ISSUED FOR REVIEW
A	12/13/10	RLL	ISSUED FOR REVIEW

Drawing: **PFD-P820-A603**

Rev: 

File Location: U:\30074.00 Drawings\FPD\A600 PFD-P820 DRAMING\FPD-P820-A603.dwg
 Plt. Date: 5/27/11 By: Kornek,Susanne

H-608
TAR REFORMER EFFLUENT/
BFW PRE-HEAT EXCHANGER

H-609
CATALYST REGENERATOR FLUE GAS/
BFW PRE-HEAT EXCHANGER

H-610
CHAR COMBUSTION FLUE GAS/
BFW PRE-HEAT EXCHANGER

H-611
CATALYST REGENERATOR FLUE
GAS STEAM GENERATOR

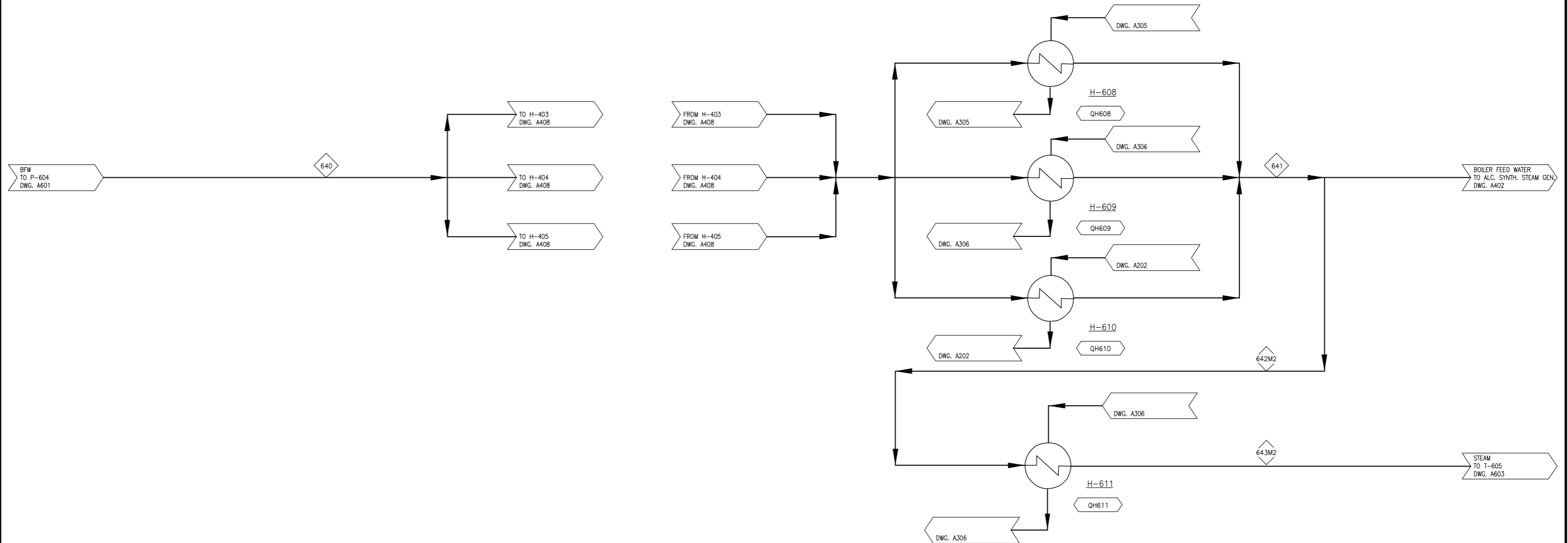

File Location: U:\30074.00\Drawings\PTD\A604-PFD-P820-DRAWINGS\PTD-P820-A604.dwg
 Plot Date: 5/27/11
 By: kochetk, Sasane

COMPONENT	UNITS	640	641	642M2	643M2
Total Flow	lb/hr	476,791	476,791	30,758	30,758
Temperature	F	235	582	581	581
Pressure	Psia	1,351.0	1,346.0	1,336.0	1,336.0
Vapor Fraction				0.00	0.98
Hydrogen	lb/hr	-	-	-	-
Carbon Monoxide	lb/hr	-	-	-	-
Nitrogen	lb/hr	-	-	-	-
Oxygen	lb/hr	-	-	-	-
Argon	lb/hr	-	-	-	-
Carbon Dioxide	lb/hr	-	-	-	-
Water	lb/hr	476,791	476,791	30,758	30,758
Hydrogen Sulfide (H2S)	lb/hr	-	-	-	-
SO2	lb/hr	-	-	-	-
Ammonia (NH3)	lb/hr	-	-	-	-
NO2	lb/hr	-	-	-	-
Methane (CH4)	lb/hr	-	-	-	-
Ethane (C2H6)	lb/hr	-	-	-	-
Ethylene (C2H4)	lb/hr	-	-	-	-
Acetylene (C2H2)	lb/hr	-	-	-	-
Propane (C3H8)	lb/hr	-	-	-	-
1-Butane (C4H10)	lb/hr	-	-	-	-
N-Butane (C4H10)	lb/hr	-	-	-	-
Pentane +	lb/hr	-	-	-	-
Benzene (C6H6)	lb/hr	-	-	-	-
Tar (C10H8)	lb/hr	-	-	-	-
Carbon (Solid)	lb/hr	-	-	-	-
Sulfur (Solid)	lb/hr	-	-	-	-
Olivine + MgO (Solid)	lb/hr	-	-	-	-
Methanol	lb/hr	-	-	-	-
Ethanol	lb/hr	-	-	-	-
Propanol	lb/hr	-	-	-	-
n-Butanol	lb/hr	-	-	-	-
Pentanol+	lb/hr	-	-	-	-
Ash	lb/hr	-	-	-	-
Char	lb/hr	-	-	-	-
Wood	lb/hr	-	-	-	-
Enthalpy Flow	MMBTU/hr	(31.8)	(29.9)	(1.9)	(1.8)

Heat Stream No.	MM BTU/hr	Work Stream No.	HP
QH608	63.73		
QH609	26.06		
QH610	38.11		
QH611	17.67		



NREL
NATIONAL RENEWABLE ENERGY LABORATORY



Harris Group Inc.
Engineering for Optimum Performance®
www.harrisgroup.com

Scale: NONE	Drawn: RLL	Engr: MWW
PMgr: MWW	Check: MWW	Check:
Appr:		

**NATIONAL RENEWABLE ENERGY LABORATORY
GOLDEN, COLORADO**

2011 THERMOCHEMICAL DESIGN REPORT

**PROCESS FLOW DIAGRAM
SECTION A600
STEAM SYSTEM & POWER GENERATION**

Project No.:	30074.00	Drawing:	PFD-P820-A604	Rev:	
--------------	----------	----------	---------------	------	--

Rev.	Date	By	Description
C	05/27/11	MWW	ISSUED FOR REPORT
B	04/28/11	MWW	ISSUED FOR REVIEW
A	03/08/11	RLL	ISSUED FOR REVIEW

Appendix F. Feedstock Supply Overview from Idaho National Laboratory (INL)

**Title: Woody Biomass Supply Chain Design for Gasification
2012 Design for NREL Design Report**

Authors: J. Richard Hess, Erin M. Searcy, and Christopher T. Wright

This section of the process accommodates the delivery of biomass feedstock from the field to the biorefinery, short term storage on-site, and the preprocessing/preparation of the feedstock for conversion in the gasifier. The design is based on a specific woody biomass feedstock. The feed handling and drying sections are shown in PFD-P820-A101 and PFD-P820-A102.

Standing southern pine trees are cut with an average diameter at breast height (DBH) of 7–10 inches using a feller buncher with an accumulator arm. Material is harvested 8 hours per day, 5 days per week, and 50 weeks per year. The cut trees are piled on the ground and transpirationally dried from 50% moisture content (MC) to approximately 35% MC, wet basis (for example, see Pottie and Guimier 1985, Rummer 2010, Hall 2009, Sinclair 1984). A grapple skidder drags the piled trees to the landing, and the trees are piled near the flail chain debarker. The flail chain debarker is equipped with a grapple on the end that loads material from the deck into the flail chain debarker. About 20% of the tree mass is ejected as bark and tree tops/limbs. The debarked, delimbed logs are fed into the chipper, which uses a 2-inch internal screen. Pneumatics may be integrated into the chipper, which increases grinder efficiency and provides additional drying beyond what would be accomplished without pneumatics. Chips are ejected from the chipper directly into a flat floor chip trailer, and once the truck reaches capacity the material is taken to the biorefinery. To increase material availability into the system, reduce dry matter losses, and to meet U.S. Department of Energy cost targets, some of the limbs are fed through the chipper in a stream separate from the clean chips. This slash stream, as we denote it, is passed through a trommel screen to sift out high-ash dirt and bark. However, it is assumed that some of the ash and bark have already been separated from the limbs and tops during the high-impact flail process. The cleaned slash stream is also ejected into the back of a truck and transported to the biorefinery. At the biorefinery, the trucks are weighed and a truck dumper unloads the truck into a hopper. A dust collection system is present during unloading to prevent excessive dust accumulation and limit dry matter losses. The chips are cleaned using an electromagnet, moisture is monitored, and material is passed over a vibratory conveyor to remove any excess dirt/ash that may still be present. Material is then conveyed into a pile using a circular stacker and overpile reclaimer. A five day supply of material is stored at the refinery. The pile, which acts as a queue, is on an asphalt pad with a long grate running through it that allows material to flow out of the pile, and up to an additional 5% moisture loss results from forced-air ambient air drying. A front end loader continuously pushes material onto the grate to maintain flow. A conveyor located at the bottom of the pit under the grate conveys the biomass into a waste heat dryer, where the biomass is dried to 10% moisture content using hot flue gas from biomass conversion processes. From the dryer, the biomass is conveyed into a metering bin where it is fed into the conversion process.

The Idaho National Laboratory (INL), in partnership with other national labs, has developed a woody supply system design that is modeled using a woody biomass supply system model. The model is being reviewed, and it will be revised to incorporate comments from industry, academia, and national labs to improve the accuracy of the model parameters and output. Future

model iterations will identify key sensitivities in the system in terms of costs, material flows, and equipment performance parameters. The output table from the model showing the costs associated with the operations in Figure F-1 is presented in Table F-1.

Table F-1. Unit Operation Costs for the Design Case Scenario of Gasification of Woody Biomass, Using Southern Pine Pulpwood-Size Trees as a Feedstock

Achieving these targets will support DOE biofuels production goals. All values are in U.S. 2007\$ per dry ton of material.

	Cost (\$/dry ton)
<i>Total feedstock cost through process feed</i>	<i>\$61.57</i>
<i>Total feedstock logistics (harvest through insertion to conversion reactor inlet)</i>	<i>\$46.37</i>
<i>Total cost of grower payment</i>	<i>\$15.20</i>
Harvest and collection	
Total cost contribution	\$18.75
Capital cost contribution	\$5.60
Operating cost contribution	\$13.15
In-field preprocessing	
Total cost contribution	\$11.42
Capital cost contribution	\$4.20
Operating cost contribution	\$7.22
Transportation and handling	
Total cost contribution	\$8.95
Capital cost contribution	\$2.95
Operating cost contribution	\$6.00
Plant receiving, storage and sueuing, and in-feed preprocessing	
Total cost contribution	\$7.25
Capital cost contribution	\$2.10
Operating cost contribution	\$5.15

The total delivered cost of woody biomass from pulpwood-size pine trees extracted from the woody biomass supply model is \$46.37/dry ton. When the grower payment of \$15.20/dry ton is added to this, the total feedstock cost through process feed is \$61.57/dry ton. This cost is a combination of ownership costs and operating costs.

The model incorporates a combination of values and relationships obtained from other national laboratories, publications, consultation with academics and staff from the U.S. Department of Agriculture Forest Service, and published and unpublished INL data. Inputs into the model include the following.

Equipment and Building Costs

- Ownership costs
 - Annual depreciation
 - Interest on the value of the machinery and equipment
 - Property taxes on equipment
 - Insurance
 - Housing (e.g., equipment shed)
- Operating costs
 - Repair and maintenance
 - Fuel (diesel and electricity)
 - Other materials
 - Labor

Variables Examined

- Feedstock variables
 - Biomass yield
 - Biomass removal limit
- Harvest and collection variables
 - Harvest window
 - Field losses (harvest efficiency)
 - Machine field speed/capacity
 - Machine field efficiency
 - Biomass moisture at harvest (e.g., standing tree moisture)
 - Biomass bulk density (e.g., tree pile or chip density)
 - Distance to landing
- Storage variables
 - Dry matter loss in storage
 - Machine (e.g., loader) capacity
- Preprocessing variables
 - Machine capacity
 - Biomass moisture
 - Dry matter losses
- Handling and transportation variables

- Transport distance/winding factor
- Transporter speed
- Loader/unloader capacity
- Plant receiving variables
 - Receiving hours per day
 - Feedstock inventory
 - Feedstock bulk density

INL will use the model to run sensitivity analyses, examining the impact of changing equipment performance parameters and material properties throughout the woody biomass supply chain. These analyses will help identify areas on which to focus future research. Ongoing and future work on equipment used in the supply chain, order of operations, and material properties will identify potential cost reductions achievable with supply-chain improvements and will develop feedstock logistics cost targets for future years.

Woody Biomass Supply System Design

For the design case scenario, the emphasis is on cost-effective removal of trees of approximately 7–10 inch diameter. The modeled annual biorefinery capacity is 800,000 dry tons of material and all material will be acquired from southern pine pulpwood plantation with a per-acre yield of 30 green tons at assumed harvest moisture content of 50%. The biomass removal limit is assumed to be 95%. 90% of the land is assumed to be forest land, 90% of the production is assumed to be pulpwood size trees, and 90% of the producers are assumed to be participating. Figure F-1 outlines the design for trees on private land.

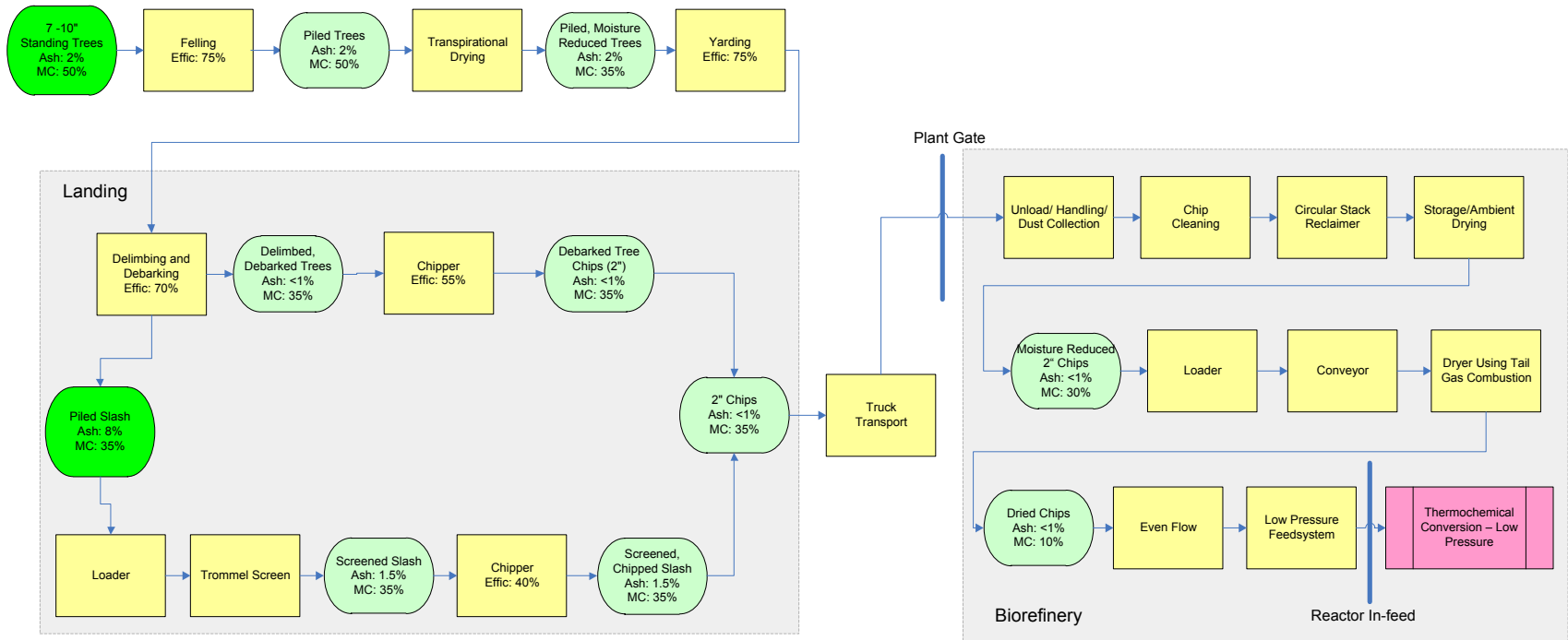

Figure F-1. Feedstock logistics supply system for the design case scenario, using woody biomass as a feedstock. The trees are cut and brought to the landing where they are debarked and delimited, then chipped and sent to the biorefinery for further preprocessing. A second material stream consisting of slash (the limbs and tops of trees) is fed through the chipper to decrease total system dry matter loss. Note that the ratio of the number of pieces of equipment shown is not 1:1 (i.e., there are, for example, more feller bunchers than chippers). The number of pieces of equipment is sized by the operation window and equipment operating capacity.

Appendix F References

Pottie, M.; Guimier, D. (1985). *Preparation of Forest Biomass for Optimal Conversion*. Forest Engineering Research Institute of Canada International Energy Agency, ISSN 0381-7733.

Personal communication with Dr. Robert Rummer, Project Leader, Forest Operations Research, USDA Forest Service, 521 Devall Drive, Auburn, AL, 36849.

Hall, P. (2009). *Storage Guidelines for Wood Residues for Bioenergy*. Prepared by Scion Next Energy Biomaterials for EECA (Energy Efficiency and Conservation Authority).

Sinclair, S.; Hassler, C.; Bolstad, K. (1984). "Moisture Loss in Aspen Logging Residue." *Wood and Fiber Science* (16:1); pp. 93-96.

Appendix G. Synthesis Gas and Char Correlations for Indirect Gasifier

The gasifier is modeled by correlations based on data from the Battelle Columbus Laboratory (BCL) 9 tonne per day test facility. The data and original correlations for the gasifier can be found in Bain (1992). Experimental runs were performed for several different wood types including red oak, birch, maple, and pine chips; sawdust; and other hard and soft wood chips. The original pilot plant data for these runs can be found in Feldmann et al. (1988). The temperature range for the data is 1,280°F to 1,857°F and the pressure range is 2.4 to 14.4 psig; the majority of the data are in the range of 1,500°F to 1,672°F.

The BCL test facility's gas production data was correlated to gasifier temperature with a quadratic function in the following form:

$$X = a + bT + cT^2$$

where the temperature, T, is in units of °F. The coefficients a, b, and c, as well as the units for the correlated variable, are shown in Table G-1. Even though there is a correlation for the char formation, it is not used; instead the amount and elemental analysis for the char is determined by mass differences between the produced syngas and the converted biomass.

Table G-1. Coefficients for Indirect Gasifier Correlations

Variable	a	b	c	Units
Dry syngas	28.993	-0.043325	0.000020966	scf gas/lb maf wood ^a
CO	133.46	-0.102900	0.000028792	mole % dry gas
CO ₂	-9.5251	0.037889	-0.000014927	mole % dry gas
CH ₄	-13.82	0.044179	-0.000016167	mole % dry gas
C ₂ H ₄	-38.258	0.058435	-0.000019868	mole % dry gas
C ₂ H ₆	11.114	-0.011667	0.000003064	mole % dry gas
H ₂	17.996	-0.026448	0.000018930	mole % dry gas
C ₂ H ₂	-4.3114	0.0054499	-0.000001561	mole % dry gas
Tar	0.045494	-0.000019759		lb/lb dry wood

^a Scf = standard cubic feet. The standard conditions are 1 atm pressure and 60°F temperature.

The following general procedure is used for the gasifier production:

- A gasifier temperature T is assumed.
- The mass and molar amounts of carbon, hydrogen, oxygen, sulfur, nitrogen, and ash (as a pseudo-element) are determined from the biomass's ultimate analysis.
- The amount of syngas and its composition is determined from the gasifier correlations.
- The amount of carbon in the syngas and tar is determined. Residual carbon is parsed in the char.
- The amount of oxygen in the syngas is determined. A minimum amount of oxygen is required to be parsed to the char (4% of biomass oxygen). If there is a deficit of oxygen, then the associated water is decomposed to make sure that this amount of oxygen is

parsed to the char; if there is excess oxygen, then it is parsed to the char without decomposing hydrogen.

- A set amount of sulfur is parsed to the char (8.3%). All remaining sulfur is set as H₂S in the syngas.
- A set amount of nitrogen is parsed to the char (6.6%). All remaining nitrogen is set as NH₃ in the syngas.
- The amount of hydrogen in the syngas (including tar, H₂S, NH₃, and decomposed water) is determined. All remaining hydrogen is parsed to the char.
- All ash is parsed to the char.
- The heat of formation of the char is estimated from the resulting ultimate analysis from this elemental material balance.
- The gasifier temperature is adjusted so that there is no net heat for an adiabatic reaction.

The syngas amount and composition will be dependent upon the biomass composition and the gasifier temperature. As an example, the resulting syngas composition for the woody biomass used in this design report can be seen in Figure G-1. Note from this figure that the amount of char decreases with increasing temperature and that the water does not start to decompose until high temperatures (here at 1,650°F and higher).

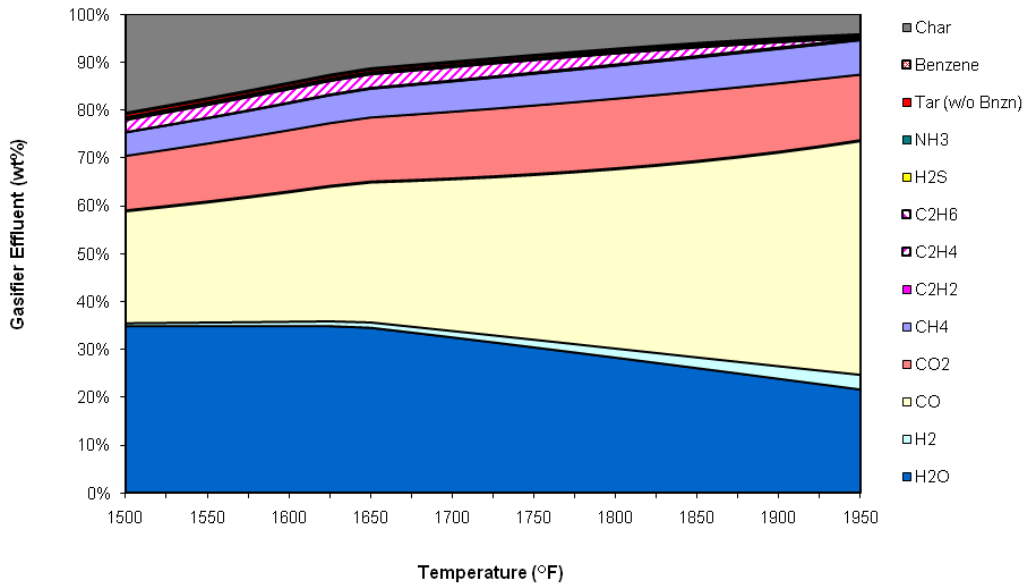

Figure G-1. Syngas composition for woody biomass used in design report

Appendix G References

Bain, R. (January 14, 1992). *Material and Energy Balances for Methanol from Biomass Using Biomass Gasifiers*.

Feldmann, H.F.; Paisley, M.A.; Applebaus, H.R.; Taylor, D.R. (July 1988). *Conversion of Forest Residues to A Medium-Rich Gas in a High-Throughput Gasifier*.

Appendix H. Equipment Lists and Cost Data for Package Systems

This appendix includes equipment lists and cost data for the following package systems:

- Gasifier design from Taylor Biomass Energy
- DEPG acid gas removal system
- Amine acid gas enrichment system
- Methanol/H₂S absorption system.

Equipment Included in Gasifier Design from Taylor Biomass Energy

- Biomass feeding system (excluding storage, pre-treatment, and transport equipment)
- Gasification process reactors (gasification, combustion, and gas conditioning)
- All cyclones and interconnecting ducting
- Air heater
- Start-up equipment
- Polishing scrubber (syngas final cleanup and particulate removal)
- Ash discharge system
- Steam generation system
- Emergency flare
- Air blower
- Process instrumentation
- Gasification process air heater
- Sand makeup system
- Inert gas system
- Gasification structural components
- All to be installed in modules delivered to site (estimated on-site erection 4 to 6 weeks)

Equipment Costs for DEPG Acid Gas Removal System

Basis for Cost Estimate

H ₂ S removal rate	5 lb-mole/h
CO ₂ removal rate	1,230 lb-mole/h
DEPG circulation rate	1,385 gpm
Absorber operating pressure	3,000 psia
Regenerator operating pressure	30 psia

Base Cost Estimate

	Total Purchased Equipment Cost (TPEC) (2007 k\$)	Installation Factor	Total Installed Cost (TIC) (2007 k\$)	Source
DEPG single-stage equipment list				
Absorber pre-cooler	812	3.00	2,433	Doctor et al.
Absorber column	2,250	2.47	5,558	Vendor quote
Flash drum	38	1.95	75	Doctor et al.
Solvent circulation pump	752	1.40	1,056	Doctor et al.
Lean-rich heat exchanger	519	3.00	1,556	Doctor et al.
Stripper column	206	2.47	509	Vendor quote
Stripper reboiler	525	3.00	1,571	Doctor et al.
Stripper OH condenser	979	3.00	2,933	Doctor et al.
Stripper OH accumulator	152	1.95	295	Doctor et al.
Misc. tanks, filters, pumps	400	2.00	800	Aspen Icarus
DEPG total	6,633*	2.53	16,786*	

* Package system costs correspond to the basis for the estimate. Package costs shown elsewhere in the report are scaled from these values based on capacity.

Equipment Costs for Selective Amine Acid Gas Enrichment System

Basis for Cost Estimate

H ₂ S feed rate	5 lb-mole/h
CO ₂ feed rate	1,230 lb-mole/h
CO ₂ slip	Maximize
Amine circulation rate	200 gpm
Absorber operating pressure	28 psia
Regenerator operating pressure	30 psia

Cost Estimate

	Total Purchased Equipment Cost (TPEC) (2007 k\$)	Installation Factor	Total Installed Cost (TIC) (2007 k\$)	Source
Acid gas enrichment (AGE) equipment list				
Absorber column	145	2.00	290	Vendor quote
Solution circulation pumps (rich and lean)	39	5.56	217	Aspen Icarus
Lean-rich heat exchanger	71	3.49	249	Aspen Icarus
Lean solution trim cooler	115	5.11	588	Aspen Icarus
Stripper column	170	2.00	340	Vendor quote
Stripper reboiler	105	1.87	196	Aspen Icarus
Stripper OH condenser	262	2.51	657	Aspen Icarus
Stripper OH accumulator	34	5.75	193	Aspen Icarus
Misc. tanks, filters, pumps	300	2.50	750	Aspen Icarus
AGE total	1,241*	2.80	3,480*	

* Package system costs correspond to the basis for the estimate. Package costs shown elsewhere in the report are scaled from these values based on capacity.

Equipment Costs for Methanol/H₂S Absorption System

Basis for Cost Estimate

Maximum H ₂ S recycle rate	20 lb-mole/h
Maximum methanol recycle	2,000 lb-mole/h
Absorber operating pressure	30 psia

Cost Estimate

	Total Purchased Equipment Cost (TPEC) (2007 k\$)	Installation Factor	Total Installed Cost (TIC) (2007 k\$)	Source
Methanol absorption equipment list				
Absorber column	45	3.36	150	Icarus
Methanol pump	76	1.86	141	Icarus
Lean-rich heat exchanger	33	3.31	110	Icarus
Methanol air cooler	214	1.40	300	Icarus
Methanol refrigeration chiller	61	2.55	155	Icarus
Total	428*	2.00	856*	

* Package system costs correspond to the basis for the estimate. Package costs shown elsewhere in the report are scaled from these values based on capacity.

Appendix I. Technology and Cost Targets for Gasification, Tar Reforming, and Alcohol Synthesis

**Unit Operation Cost Contribution Estimates (2007\$) and Technical Projections for Thermochemical Conversion to Ethanol Baseline
Process Concept**

(Process Concept: Woody Energy Crop, Gasification, Gas Cleanup, Mixed Alcohol Synthesis, Ethanol Recovery and Purification)

Processing Area Cost Contributions and Key Technical Parameters	Metric	2007 SOT ^a	2008 SOT	2009 SOT	2010 SOT	2011 Projection	2012 Projection
Process Concept: Gasification, Syngas Cleanup, Mixed Alcohol Synthesis & Recovery		Woody Feedstock	Woody Feedstock	Woody Feedstock	Woody Feedstock	Woody Feedstock	Woody Feedstock
Conversion Contribution	\$/gal EtOH	\$3.35	\$2.11	\$2.03	\$1.65	\$1.62	\$1.31
Year \$ basis		2007	2007	2007	2007	2007	2007
EIA reference case ^b	\$/GGE ^c	\$2.18	\$2.57	\$1.69	\$2.29	\$2.47	\$2.62
	\$/gal EtOH	\$1.46	\$1.72	\$1.13	\$1.53	\$1.66	\$1.76
Projected minimum ethanol selling price ^d	\$/gal EtOH	\$4.75	\$3.35	\$3.26	\$2.70	\$2.51	\$2.05
Total project investment per annual gallon	\$	\$12.76	\$9.47	\$9.24	\$7.96	\$7.85	\$7.60
Plant capacity (dry feedstock basis)	tonnes/day	2,000	2,000	2,000	2,000	2,000	2,000
Ethanol yield	gal EtOH/dry ton	62	70	70	79	80	84
Mixed alcohol yield	gal MA/dry ton	67	77	78	88	89	94
Feedstock							
Total cost contribution	\$/gal EtOH	\$1.40	\$1.24	\$1.22	\$1.05	\$0.90	\$0.73
Capital cost contribution	\$/gal EtOH	-	-	-	-	-	-
Operating cost contribution	\$/gal EtOH	\$1.40	\$1.24	\$1.22	\$1.05	\$0.90	\$0.73
Feedstock cost	\$/dry U.S. ton	\$86.25	\$86.25	\$86.25	\$82.70	\$71.60	\$61.57
Feedstock moisture at plant gate	wt % H ₂ O	50%	50%	50%	40%	40%	30%
In-plant handling and drying	\$/dry U.S. ton	\$22.65	\$22.65	\$22.65	\$20.60	\$14.30	\$7.25
Cost contribution	\$/gal EtOH	\$0.37	\$0.32	\$0.32	\$0.26	\$0.18	\$0.09
Feed moisture content to gasifier	wt % H ₂ O	10%	10%	10%	10%	10%	10%
Energy content (LHV, dry basis)	Btu/lb	8,000	8,000	8,000	8,000	8,000	8,000
Gasification							
Total cost contribution	\$/gal EtOH	\$0.37	\$0.33	\$0.33	\$0.29	\$0.29	\$0.28
Capital cost contribution	\$/gal EtOH	\$0.21	\$0.19	\$0.19	\$0.17	\$0.16	\$0.16
Operating cost contribution	\$/gal EtOH	\$0.16	\$0.14	\$0.14	\$0.13	\$0.13	\$0.12
Raw dry syngas yield	lb/lb dry feed	0.78	0.78	0.78	0.78	0.78	0.78
Raw syngas methane (dry basis)	mole %	15%	15%	15%	15%	15%	15%
Gasifier efficiency (LHV)	% LHV	74%	74%	74%	74%	74%	74%

Processing Area Cost Contributions and Key Technical Parameters	Metric	2007 SOT	2008 SOT	2009 SOT	2010 SOT	2011 Projection	2012 Projection
Synthesis gas cleanup (reforming and quench)							
Total cost contribution	\$/gal EtOH	\$1.22	\$0.61	\$0.58	\$0.42	\$0.43	\$0.17
Capital cost contribution	\$/gal EtOH	\$0.14	\$0.12	\$0.12	\$0.10	\$0.10	\$0.10
Operating cost contribution	\$/gal EtOH	\$1.07	\$0.49	\$0.46	\$0.32	\$0.33	\$0.07
Tar reformer (TR) exit CH ₄ (dry basis)	mole %	13%	5%	4%	2%	2%	2%
TR CH ₄ conversion	%	20%	50%	56%	80%	80%	80%
TR benzene conversion	%	80%	98%	98%	99%	99%	99%
TR tars conversion	%	97%	97%	97%	99%	99%	99%
Catalyst replacement	% inventory/day	1.0%	1.0%	1.0%	1.0%	1.0%	0.1%
Acid gas and sulfur removal							
Total cost contribution	\$/gal EtOH	\$0.27	\$0.21	\$0.20	\$0.17	\$0.17	\$0.17
Capital cost contribution	\$/gal EtOH	\$0.17	\$0.13	\$0.12	\$0.11	\$0.11	\$0.10
Operating cost contribution	\$/gal EtOH	\$0.10	\$0.08	\$0.08	\$0.07	\$0.06	\$0.06
Sulfur level at reactor inlet (as H ₂ S)	ppmv	70	70	70	70	70	70
Synthesis gas compression and power recovery expansion							
Total cost contribution	\$/gal EtOH	\$1.28	\$0.84	\$0.81	\$0.67	\$0.67	\$0.67
Capital cost contribution	\$/gal EtOH	\$0.65	\$0.39	\$0.37	\$0.29	\$0.30	\$0.29
Operating cost contribution	\$/gal EtOH	\$0.63	\$0.45	\$0.44	\$0.38	\$0.38	\$0.38
Electricity production from syngas expander (credit included in operating cost above)	\$/gal EtOH	(\$0.35)	(\$0.15)	(\$0.14)	(\$0.08)	(\$0.09)	(\$0.09)
Fuels synthesis reaction							
Total cost contribution	\$/gal EtOH	\$0.24	\$0.12	\$0.11	\$0.06	\$0.04	\$0.03
Capital cost contribution	\$/gal EtOH	\$0.24	\$0.19	\$0.18	\$0.16	\$0.16	\$0.15
Operating cost contribution	\$/gal EtOH	\$0.00	(\$0.07)	(\$0.08)	(\$0.10)	(\$0.12)	(\$0.12)
Pressure	psia	3,000	3,000	3,000	3,000	3,000	3,000
Single pass CO conversion	% CO	25%	24%	25%	26%	29%	29%
Overall CO conversion	% CO	55%	68%	70%	80%	79%	79%
Selectivity to alcohols	% CO (CO ₂ free)	78%	81%	81%	81%	81%	81%
Selectivity to ethanol	% CO (CO ₂ free)	59%	63%	63%	63%	63%	63%
Ethanol productivity	g/kg-cat/h	101	128	132	143	153	160
Mixed alcohols co-product (credit included in operating cost above)	\$/gal EtOH	(\$0.18)	(\$0.22)	(\$0.22)	(\$0.23)	(\$0.24)	(\$0.24)

Processing Area Cost Contributions and Key Technical Parameters	Metric	2007 SOT	2008 SOT	2009 SOT	2010 SOT	2011 Projection	2012 Projection
Product recovery and purification							
Total cost contribution	\$/gal EtOH	\$0.14	\$0.12	\$0.12	\$0.11	\$0.11	\$0.10
Capital cost contribution	\$/gal EtOH	\$0.10	\$0.09	\$0.08	\$0.08	\$0.08	\$0.07
Operating cost contribution	\$/gal EtOH	\$0.04	\$0.04	\$0.04	\$0.03	\$0.03	\$0.03
Balance of plant							
Total cost contribution	\$/gal EtOH	(\$0.17)	(\$0.12)	(\$0.11)	(\$0.09)	(\$0.09)	(\$0.10)
Capital cost contribution	\$/gal EtOH	\$0.30	\$0.24	\$0.23	\$0.21	\$0.21	\$0.20
Operating cost contribution	\$/gal EtOH	(\$0.47)	(\$0.35)	(\$0.35)	(\$0.31)	(\$0.30)	(\$0.30)
Electricity production from steam turbine (credit included in operating cost above)	\$/gal EtOH	(\$0.60)	(\$0.46)	(\$0.45)	(\$0.40)	(\$0.40)	(\$0.39)
Electricity production	kWh/gal EtOH	16.6	10.7	10.3	8.5	8.5	8.4
Electricity consumption (entire process)	kWh/gal EtOH	16.6	10.7	10.3	8.5	8.5	8.4
Water consumption ^e	gal H ₂ O/gal EtOH	7.0	3.7	3.5	2.8	2.7	2.6
Fuel ethanol case reference (model run #)		AD-FY07-R236-50pctMoisture-V24.xls	AD-FY08-R236-50pctMoisture-V24.xls	AD-FY09-R236-50pctMoisture-V24.xls	AD-FY10-R236-40pctMoisture-V24.xls	AD-FY11-R236-40pctMoisture-V24.xls	R236-V24.xls

^a SOT: State of Technology

^b EIA, "Annual Energy Outlook 2009," Table 112, U.S., http://www.eia.doe.gov/oiaf/archive/aeo09/supplement/suptab_112.xls

^c Using a 0.67 gallon gasoline per gallon ethanol conversion factor

^d Conceptual design result with expected margin of error ±30%

^e 2012 water consumption of 2.6 gallons of water per gallon of ethanol represents the base case value. The water consumption value resulting from an optimized water treatment and recycle design is 2.0 gallons of water per gallon of ethanol.

Appendix J. Fuel-Grade Ethanol Specifications

Fuel-Grade Ethanol Specifications

Below are the primary quality specifications for denatured fuel ethanol for blending with gasoline meeting Federal requirements. The state of California has additional restrictions that apply in addition to the performance requirements in ASTM D 4806.

Specifications Contained in ASTM D 4806 Standard Specification for Denatured Fuel Ethanol for Blending with Gasoline

Property	Specification	ASTM Test Method
Ethanol Content (Volume %)	92.1 Minimum	D 5501
Methanol Content (Volume %)	0.50 Maximum	D 5501
Solvent-Washed Gum (mg/100 ml)	5.0 Maximum	D 381
Water Content (Volume %)	1.0 Maximum	E 203
Denaturant Content (Volume %)	1.96 Minimum	D 4806
	4.76 Maximum	
Inorganic Chloride Content (mg/L)	40 Maximum	D 512
Copper Content (mg/kg)	0.10 Maximum	D1688
Acidity (Mass % as acetic acid CH ₃ COOH)	0.0070 Maximum	D1613
pHe	6.5 Minimum	D 6423
	9.0 Maximum	
Appearance	Visibly free of suspended or precipitated contaminants (clear & bright)	

Source:

Renewable Fuels Association, Industry Guidelines, Specifications, and Procedures.

<http://www.ethanolrfa.org/pages/industry-resources-guidelines>

Note:

ASTM = American Society for Testing and Materials

**Appendix K. Direct Costs Included in Equipment Installation
Factors from Harris Group Inc.**

Direct Costs Included in Installation Factors from Harris Group Inc.

Site Preparation/Civil

1. General site preparation (grading, cut, and backfill)
2. Excavation and backfill requirements related to equipment foundations. Generally, the excavated and backfill volume was estimated to be roughly 80%–90% of the in-ground concrete volume.
3. Underground piping
4. Excavation and backfill requirements for sanitary, storm water, firewater and process sewer culverts, piping, etc.
5. Excavation and backfill requirements for retention/drainage ponds, if necessary
6. Any other required cut/backfill
7. Any required paving and gravel including proper drainage (curbs and gutters, etc.)
 - A. Access
 - B. Parking
 - C. Truck staging/truck scales
 - D. Roads
8. Any required sumps and pumps for potentially contaminated waste streams or streams to be recycled back to the process
9. Containment berms
10. Any required retention ponds or in-ground water storage

Demolition

1. If not a green field project an allowance must be included for removal of the existing concrete, steel, equipment, etc.

Concrete/Foundations

1. Depending on soil quality the foundation design and requirement for piles can be determined. Typically we assume an unknown soil quality to be average, having approximately a 3000–4000 psf soil bearing pressure.
 - A. Any required piles and pile caps. Pile length determined from soil report.
 - B. Equipment foundations that are optimized for the arrangement of building columns and actual loads
 - C. Containment
 - D. All foundations are priced including rebar, rather than mesh, form work, hardware (anchor bolts, iron, etc.), concrete, finishing, and form stripping
2. Bulk storage slabs (chip piles, etc.)

Buildings

1. Possible necessary buildings include the following
 - A. Electrical building (switchgear, MCC, and rack room)
 - B. Control room
 - C. Maintenance shops
 - D. Spares and parts storage
 - E. Continuous emission monitoring (CEMS) building to house the monitoring and control equipment
 - F. Lockers/restrooms
 - G. Office space
 - H. Meeting space
 - I. Guard shack
2. Main process area can include the following
 - A. Cranes
 - B. Access doors, hatches, etc.
3. Elevators for multi-floor structures

Structural

1. Equipment support steel and hardware (assume an average wind and seismic zone for unknown locations)
2. Pipe bridges and miscellaneous support steel
3. Equipment access steel
 - A. Stairs
 - B. Grating/decking
 - C. Ladders
 - D. Railings
 - E. Gates
4. Structural steel for cranes
5. Maintenance monorails

Mechanical

1. At times the following equipment and/or systems can be included in the installation factors for preliminary/feasibility estimates
 - A. Process air systems

- B. Instrument air systems
- C. Wastewater treatment systems
- D. Cooling water systems
- E. Steam generating/water treatment systems

Pumps, Piping, Ductwork, and Valves

1. All pumps not included with equipment
2. All process and utility piping
 - A. Including all valves, flanges, fittings, and hardware not included with equipment
3. All process and utility ductwork
 - A. Including all dampers, flanges, fittings, and hardware
4. Miscellaneous storm drainage, sanitary sewer and process sewer piping
5. Utility piping runs to include connections, back flow prevention, etc. at sources
 - A. Process water (if not produced on-site)
 - B. Cooling water (if not produced on-site)
 - C. Process air (if not produced on-site)

Electrical

1. High voltage breaker and feeder located in a high voltage bus room
2. Medium voltage feeder to loop feed the unit substations
3. Unit substations
 - A. Outdoor oil-filled transformer(s) with close-coupled primary switch
 - B. Indoor secondary switchgear
 - C. Cable and conduit for the power distribution feeders between the outdoor transformers and the indoor switchgear and between the switchgear and the MCCs is included
4. MCCs
 - A. Low voltage motor control centers will contain variable frequency drives (VFDs) up to 250 HP. Low voltage VF drives larger than 250 HP will be free standing drives separately fed from a feeder breaker in the unit substation's 600 volt secondary switchgear. All VF drives will be furnished with input line reactor (to limit harmonics to upstream equipment) and output filters (to clamp voltage spikes and limit harmonics to the motors).
 - B. All VFDs larger than 400 HP will be medium voltage and will be separately fed from a feeder breaker in the unit substation's 5 kV secondary switchgear
 - C. Motors not included with equipment

5. Motor wiring
 - A. Motor lead wiring to include cable, conduit, and terminations
 - B. Motor lead wiring for VFDs shall be continuous corrugated aluminum sheath CLX type cable with three symmetrical grounding conductors installed in ladder type cable tray
6. Instrument wiring (including conduit)
7. Uninterrupted power supply (UPS) for control systems and any critical systems such as burner management systems, etc.
8. Grounding
9. Lightning protection
10. Lighting
11. Electrical building (switchgear, MCC, and rack room)
12. Cable trays

Instrumentation and Controls

1. Either DCS or PLC system (chassis, power supply, processors, etc.)
2. Operator stations (HMI software and PCs)
3. Hardware (I/O modules, etc.)
4. Field instruments and transducers are 4–20 mA type with twisted shield pair wiring, discrete devices are normally 120 VAC. Field bus?
5. Control/actuated valves
6. PLC programming and programming software
7. DCS interface to PLC(s) (if DCS is utilized)
8. DCS programming (if DCS is utilized)
9. Any statistics, data archiving, or other control related software.

Fire Protection/Safety

1. Fire Protection
 - A. Above- and below-ground piping, valves, fittings, flanges, hardware, etc.
 - B. Hydrants and sprinklers
2. Safety
 - A. Access stairs, ladder, etc. not included with structural steel
 - B. Eye wash and shower stations, including piping, valves, etc.

Painting

1. Allowance for painting structural steel and equipment

Insulation/Refractory/Heat Tracing

1. Piping insulation for heat conservation and/or personnel safety
2. Any refractory not included with equipment
3. Any heat tracing required for cold weather service

House Keeping

1. Wash up hose stations

Appendix L. Plant Footprint and Land Cost Calculation from Harris Group Inc.

Plant Footprint and Land Cost Calculation from Harris Group Inc.

Basis:

2,000 dry metric tons/day feedstock basis or 2,205 dry short tons/day or 83.7 gallons per dry short ton of feedstock or ~64.6 MM gal/year at ~ 350 day/year of operation

Areas	Estimated Footprint		Calculated Area	
	Width ft	Length ft	ft ²	Acre
1 Truck staging, scales, scale shack, guard shack etc.	250	500	125,000	2.87
2 Feedstock handling and storage - x2-truck dumps/hoppers, x2 scalping screens/hogs, x2-400' diameter stacker reclaimers and a bunch of conveyors	800	1,000	800,000	18.37
3 Feedstock drying and storage - x2-dryers/WESPs/RTOs and x2-dry feedstock silos	200	500	100,000	2.30
4 Gasifier Island - x2-gasifiers, x2-tar reformers, bed/sorbent media handling w/ silos, ash handling w/ silo(s), instrument air system etc.	125	150	18,750	0.43
5 Syngas scrubbing, compression, synthesis, heat exchangers, expander etc.	150	150	22,500	0.52
6 Acid gas removal, acid gas enrichment, sulfur recovery	150	150	22,500	0.52
7 Alcohol purification (distil, mole sieve etc.)	100	150	15,000	0.34
8 Waste water treatment, boiler water treatment, condensate treatment, DA, steam distribution, power generation etc.	200	200	40,000	0.92
9 Cooling towers, pumps etc.	100	150	15,000	0.34
10 Tank Farm - product tanks, fuel, chemicals, fire water, process water etc.	500	500	250,000	5.74
11 Air separation plant, compressors, tanks etc.	50	50	2,500	0.06
12 Storm water system - retention pond etc.	200	200	40,000	0.92
13 Electrical feed, transformers etc.	100	100	10,000	0.23
14 Electrical Building	25	100	2,500	0.06
15 Control Room	25	50	1,250	0.03
16 Offices, etc.	100	100	10,000	0.23
17 Maintenance shop, maintenance warehouse/yard	200	200	40,000	0.92
18 Parking, roads, etc.	500	500	250,000	5.74
19 Buffer			871,200	20.00
20 Unusable land (topography and environmentally)			1,306,800	30.00
21 Other (10% of process areas and buildings)			151,500	3.48
22 Easement (10% of all above)			409,450	9.40
23 Contingency (10% of all above)			450,395	10.34
Total			4,954,345	113.74

Specific Land Cost	\$ / Acre	14,000
Site area	Acre	113.74
Total Land Cost	\$	1,592,306

Appendix M. Pinch Analysis and Heat Integration System Design

Equip ID	Duty ID	Service	Duty (MMBTU/Hr)	Hot In T (Deg F)	Hot Out T (Deg F)	Cold In T (Deg F)	Cold Out T (Deg F)	LMTD	U ** (Btu/Hr-ft2-F)	A (ft2)	TPEC (2007 \$)	TIC (2007 \$)
H-201	QH201	Syngas Quench Inlet / Combustion Air Pre-Heat Exchanger *	4.6	331.6	290.8	277.1	316.3	14.5	25.00	12,829	-	-
H-202	QH202	Tar Reformer Effluent / Combustion Air Pre-Heat Exchanger *	9.9	436.7	331.6	316.3	400.0	24.4	20.00	20,350	-	-
H-302	QH302	Steam Blowdown / Unreacted Syngas Exchanger	4.4	581.0	160.0	72.3	564.1	43.0	30.00	3,395	65,163	246,600
H-303	QH303	Syngas Quench Inlet / Make-Up Water Exchanger	7.2	254.4	160.2	145.0	239.4	15.1	30.00	15,919	176,012	332,300
H-304	QH304	Syngas Quench Inlet / Mol-Sieve Pre-Heat Exchanger	5.7	331.6	290.8	200.4	237.9	92.1	25.00	2,461	35,863	133,700
H-305	QH305	Alcohol Synthesis Effluent / Combustion Air Pre-Heat Exchanger	1.6	331.6	257.3	160.9	316.3	44.0	40.00	894	32,363	168,000
H-306	QH306	Syngas Quench Inlet / Combustion Air Pre-Heat Exchanger	2.6	331.6	257.3	160.9	316.3	44.0	40.00	1,497	42,463	235,800
H-307	QH307	Syngas Quench Inlet / Combustion Air Pre-Heat Exchanger	5.9	331.6	254.4	160.9	316.3	43.2	40.00	3,422	83,563	339,700
H-308	QH308	Tar Reformer Effluent / Combustion Air Pre-Heat Exchanger	5.3	436.7	331.6	316.3	400.0	24.4	20.00	10,910	26,163	121,000
H-309	QH309	Tar Reformer Effluent / Combustion Air Pre-Heat Exchanger	12.7	865.8	787.3	400.0	600.0	322.7	20.00	1,975	59,963	194,500
H-310	QH310	Catalyst Regenerator Flue Gas / Tar Reformer Steam & Recycle Exchanger	69.9	1,776.8	1,139.3	575.1	1,700.0	244.4	20.00	14,293	359,712	657,300
H-311	QH311	Tar Reformer Effluent / Unreacted Syngas Exchanger	9.1	1,670.0	865.8	577.5	1,139.0	397.4	20.00	1,142	47,663	181,100
H-401	QH401	Alcohol Synthesis Feed / Effluent Exchanger	127.7	611.3	331.6	316.3	556.9	30.8	90.00	46,034	2,353,181	4,673,400
H-402	QH402	Alcohol Synthesis Feed / Effluent Exchanger	73.6	331.6	200.0	182.1	316.3	16.6	90.00	49,332	2,152,502	4,107,500
H-403	QH403	Compressor Interstage / Deaerator Feed Exchanger	25.0	388.1	249.9	235.0	346.7	25.9	35.00	27,629	450,719	1,112,400
H-404	QH404	Compressor Interstage / Deaerator Feed Exchanger	15.3	359.6	249.9	235.0	346.7	13.9	50.00	22,037	388,090	885,100
H-405	QH405	Compressor Interstage / Deaerator Feed Exchanger	15.5	358.7	249.9	235.0	346.7	13.4	100.00	11,595	274,322	672,800
H-406	QH406	Compressor Interstage / Mol-Sieve Pre-Heat Exchanger	16.0	249.9	170.0	66.8	237.9	42.3	30.00	12,567	132,222	281,800
H-407	QH407	Compressor Interstage / Mol-Sieve Pre-Heat Exchanger	11.1	249.9	170.0	66.8	237.9	42.3	50.00	5,244	67,763	170,200
H-408	QH408	Compressor Interstage / Mol-Sieve Pre-Heat Exchanger	11.4	249.9	170.0	66.8	237.9	42.3	70.00	3,844	68,763	230,500
H-409	QH409	Alcohol Synthesis Effluent / LO-CAT Pre-Heat Exchanger	0.0	200.0	176.1	80.0	150.0	70.6	50.00	14	22,566	76,000
H-415	QH415	Alcohol Synthesis Effluent / Syngas Recycle Exchanger	19.6	200.0	175.0	115.2	180.0	36.3	90.00	5,980	258,230	690,400
H-416	QH416	Alcohol Synthesis Effluent / CO2-Rich Gas Exchanger	1.0	200.0	176.1	94.0	160.2	58.5	80.00	215	28,534	111,000
H-417	QH417	Alcohol Synthesis Effluent / Mol-Sieve Pre-Heat Exchanger	5.4	220.0	200.0	66.8	200.4	59.3	25.00	3,608	48,163	142,800
H-418	QH418	Alcohol Synthesis Effluent / Expander Inlet Exchanger	9.7	331.6	257.3	95.4	316.3	62.1	80.00	1,953	79,563	289,600
H-419	QH419	Tar Reformer Effluent / Expander Inlet Exchanger	3.8	436.7	331.6	316.3	400.0	24.4	30.00	5,202	32,280	225,600
H-420	QH420	Tar Reformer Effluent / Expander Inlet Exchanger	25.1	1,670.0	865.8	400.0	950.0	583.7	30.00	1,432	88,063	453,200
H-421	QH421	Alcohol Synthesis Effluent / Expander Inlet Exchanger	4.3	331.6	257.3	30.0	316.3	78.6	70.00	783	29,363	165,700
H-422	QH422	Tar Reformer Effluent / Expander Inlet Exchanger	11.0	1,670.0	865.8	316.3	950.0	630.9	25.00	695	38,063	152,300
H-423	QH423	Tar Reformer Effluent / Expander Inlet Exchanger	16.3	1,670.0	865.8	594.5	950.0	459.7	25.00	1,418	57,963	202,500
H-424	QH424	Alcohol Synthesis Effluent / CO2-Rich Gas Exchanger	2.4	331.6	257.3	160.2	316.3	44.3	45.00	1,192	35,963	228,900
H-425	QH425	Char Combustor Flue Gas / CO2-Rich Gas Exchanger	4.5	1,808.2	787.3	316.3	1,170.0	550.4	20.00	410	28,380	112,600

Equip ID	Duty ID	Service	Duty (MMBTU/Hr)	Hot In T (Deg F)	Hot Out T (Deg F)	Cold In T (Deg F)	Cold Out T (Deg F)	LMTD	U ** (Btu/Hr-ft ² -F)	A (ft ²)	TPEC (2007 \$)	TIC (2007 \$)
H-426	QH426	Tar Reformer Effluent / CO ₂ -Rich Gas Exchanger	10.1	1,670.0	865.8	316.3	1,170.0	524.3	20.00	967	41,563	174,800
H-427	QH427	Catalyst Regenerator Flue Gas / Alcohol Synthesis Feed Exchanger	20.4	1,139.3	787.3	556.9	595.4	365.0	40.00	1,399	111,563	645,400
H-501	QH501	Ethanol Product / Mol-Sieve Pre-Heat Exchanger	4.8	229.5	120.0	66.8	214.5	30.2	90.00	1,770	30,263	102,500
H-502	QH502	Higher Alcohols Product / Mol-Sieve Pre-Heat Exchanger	0.8	264.8	120.0	66.8	214.5	51.8	90.00	164	16,684	65,700
H-503	QH503	Syngas Quench Inlet / Water-Methanol Recycle Exchanger	12.1	331.6	160.2	140.0	316.3	17.6	30.00	22,949	244,690	458,200
H-506	QH506	Syngas Quench Inlet / Mol-Sieve Pre-Heat Exchanger	10.4	220.0	160.2	66.8	200.4	47.3	25.00	8,809	106,034	226,700
H-507	QH507	Alcohol Synthesis Effluent / Mol-Sieve Pre-Heat Exchanger	1.0	331.6	257.3	237.9	257.9	40.7	50.00	505	24,080	158,600
H-508	QH508	Alcohol Synthesis Effluent / Mol-Sieve Pre-Heat Exchanger	0.9	331.6	257.3	214.5	237.9	65.0	40.00	340	20,880	115,200
H-509	QH509	Catalyst Regenerator Flue Gas / Water-Methanol Recycle Exchanger	0.5	1,139.3	787.3	316.3	590.0	509.1	20.00	47	25,366	90,500
H-510	QH510	Tar Reformer Effluent / Water-Methanol Recycle Exchanger	1.5	865.8	787.3	316.3	590.0	364.7	20.00	208	24,934	108,400
H-602	QH602	Steam Turbine Exhaust / Syngas Recycle Exchanger	3.9	234.1	160.0	115.2	180.0	49.3	40.00	1,986	31,463	108,500
H-604	QH604	Steam Turbine Exhaust / Mol-Sieve Pre-Heat Exchanger	4.4	234.1	195.0	66.8	200.4	70.8	35.00	1,767	30,163	106,600
H-605	QH605	Syngas Quench Inlet / Make-Up Water Exchanger	6.5	331.6	160.2	60.0	145.0	139.0	30.00	1,559	27,063	103,700
H-606	QH606	Syngas Quench Inlet / BFW Pre-Heat Exchanger	6.5	257.3	220.0	198.0	232.3	23.5	30.00	9,232	107,834	228,700
H-607	QH607	Alcohol Synthesis Effluent / BFW Pre-Heat Exchanger	10.0	257.3	220.0	198.0	232.3	23.5	30.00	14,178	164,512	320,200
H-608	QH608	Tar Reformer Effluent / BFW Pre-Heat Exchanger	63.7	787.3	436.7	346.7	582.0	139.8	30.00	15,198	726,312	1,840,600
H-609	QH609	Catalyst Regenerator Flue Gas / BFW Pre-Heat Exchanger	26.1	787.3	549.4	346.7	582.0	204.0	30.00	4,259	207,063	736,800
H-610	QH610	Char Combustor Flue Gas / BFW Pre-Heat Exchanger	38.1	787.3	532.0	346.7	582.0	195.1	30.00	6,511	341,534	1,102,700
H-611	QH611	Catalyst Regenerator Flue Gas Steam Generator	17.7	1,139.3	787.3	581.0	581.0	353.6	30.00	1,666	89,663	455,000
H-612	QH612	Char Combustor Flue Gas Steam Superheater	147.9	1,808.2	787.3	580.0	1,000.0	441.6	30.00	11,163	518,334	1,557,500
H-613	QH613	Tar Reformer Effluent Steam Superheater	74.6	1,670.0	865.8	698.1	1,000.0	362.6	25.00	8,231	315,934	632,400
Total			999.6							403,179	10,769,553	26,933,000

* Costs for H-201 and H-202 are included in total capital for the gasifier and tar reformer based on quotation provided by Taylor Biomass Energy.

** Heat transfer coefficients used for sizing equipment in the heat integration network are from the GPSA Engineering Data Book, FPS Version, Volume I, Section 9. Eleventh Edition - FPS. 1998.

Appendix N. Summary of Design Report Assumptions

The table below presents a summary of assumptions for the thermochemical ethanol design compared to the assumptions for the previous design version (2007) and the updated biochemical ethanol design. Sources of justification for changes in assumptions are experience and feedback from Harris Group Inc., feedback from peer reviewers, current financial atmosphere and markets, feedback from DOE, and inclusion of DOE programs such as loan guarantees.

Parameter	2011 Thermochemical Ethanol Design Report	2011 Biochemical Ethanol Design Report	2007 Thermochemical Ethanol Design Report
Cost year for analysis	2007	2007	2005
Plant financing by equity / debt	40% / 60%	40% / 60%	100% / 0%
Internal rate of return (IRR)	10% after-tax	10% after-tax	10% after-tax
Term for debt financing	10 years	10 years	N/A
Interest rate for debt financing	8%	8%	N/A
Plant life / analysis period	30 years	30 years	20 years
Depreciation method	MACRS 7 years general plant 7 years steam/power (no export of electricity)	MACRS 7 years general plant 15 years steam/power (export of electricity)	MACRS 7 years general plant 20 years steam/power
Income tax rate	35%	35%	39%
Plant construction cost schedule	3 years (8% Y1, 60% Y2, 32% Y3)	3 years (8% Y1, 60% Y2, 32% Y3)	2.5 years (8% Y1, 60% Y2, 32% Y3)
Plant decommissioning costs	\$0	\$0	\$0
Plant salvage value	\$0	\$0	\$0
Start-up period	3 months	3 months	6 months
Revenue and costs during start-up	Revenue = 50% of normal Variable costs = 75% of normal Fixed costs = 100% of normal	Revenue = 50% of normal Variable costs = 75% of normal Fixed costs = 100% of normal	Revenue = 50% of normal Variable costs = 75% of normal Fixed costs = 100% of normal

Parameter	2011 Thermochemical Ethanol Design Report	2011 Biochemical Ethanol Design Report	2007 Thermochemical Ethanol Design Report
On-stream percentage	96% (8,410 operating hours / year)	96% (8,410 operating hours / year)	~96% (8,406 operating hours / year)
Land purchase cost	\$1.61MM (115 acres at \$14,000 per acre)	\$1.85MM (132 acres at \$14,000 per acre)	\$3.34MM (6% of TPEC)
Equipment installation factor (TIC / TPEC)	1.98	1.50	2.47
Warehouse costs (direct)	\$0	4.0% of ISBL total installed costs	\$0
Site development costs (direct)	4.0% of ISBL total installed costs	9.0% of ISBL total installed costs	\$0
Additional piping (direct)	\$0	4.5% of ISBL total installed costs	\$0
Indirect costs	60% of total direct costs	60% of total direct costs	39% of total direct costs
Working capital cost	5% of fixed capital investment	5% of fixed capital investment	5% of fixed capital investment
FCI / TPEC	3.45	2.59	3.43
Annual plant maintenance costs	3% of total fixed capital investment	3% of ISBL fixed capital investment	2% of fixed capital investment
Annual insurance and taxes	0.7% of fixed capital investment	0.7% of fixed capital investment	2% of fixed capital investment
Feedstock basis	Woody biomass (southern pine)	Corn stover	Woody biomass (hybrid poplar)
Feedstock cost	\$61.57 per dry ton including capital and operating costs up to inlet of gasifier reactor	\$58.50 per dry ton including capital and operating costs up to inlet of pretreatment	\$35.00 per dry ton
Alcohol synthesis yield basis	Kinetic model from The Dow Chemical Company	N/A	Stoichiometric model

Appendix O. Reviewer Comments on Draft Design Report and Responses

This appendix presents a summary of reviewer comments from the draft version of the report, which was issued for peer review in December 2010. Each comment from the peer review panel is summarized below and followed by a response from NREL authors (and INL authors for Area 100 comments). The responses describe any actions taken to address the comments in the final draft of the report.

Area A100: Feed Handling and Drying

1. **Comment:** It is understood that power cost for feed handling is included in the INL feedstock cost. However, as a practical matter, that power needs to come from elsewhere in the plant. This means more syngas converted to power and less ethanol production than the model would otherwise predict. It's unclear from the report whether this allowance has been made.

Response: This allowance has not been made in the model with exception of the heat from flue gas required to dry the feedstock to target moisture content (from 30 wt % to 10 wt % in the base case design). However it can be said that the economic impact from increased syngas consumption for feedstock processing (electricity and other energy) will be offset by reduced feedstock cost. This is because the feedstock cost in the model already includes allowances for all capital and operating costs (including energy) associated with feedstock supply to the throat of the gasifier.

2. **Comment:** Though not modeled explicitly, the dryer exhaust is likely to contain VOCs (volatile organic compounds). I doubt you can just vent it to atmosphere. Perhaps this could be routed to combustors downstream?

Response: A flue gas scrubbing system was added to the design to control SO₂ and particulate emissions from the biorefinery flue gas. NREL and INL will assess additional environmental requirements in future design updates when data is available for VOC components in the dryer outlet flue gas.

3. **Comment:** Starting at 35% moisture is not realistic as we've done lots of feedstock work and you can't expect it to dry from a 50% moisture tree (just cut) to 35% moisture in any short period of time. It will cost too much to leave it there for a long time (sometimes months) and reclaim it later. Expecting it to dry to 30% is also not realistic by chipping and transporting in a truck. Unless it is spread out in the sun it doesn't dry by itself. So in the end, one has to dry it from 50% to 10%, which would cost more in capital and operating. Possibly close to \$10/dry ton just for these operations.

Response: Idaho National Laboratory (INL) has deemed the feedstock technical and cost targets presented in the report to be achievable by 2012. INL will release a report on woody feedstocks that will include more detail on processing methods and assumptions. The sensitivity study in Figure 16 (case 8) shows the impact on the MESP if feed is supplied with 50 wt % moisture at a cost of \$61.57/dry ton.

4. **Comment:** We don't necessarily disagree with the per ton biomass costs but it is noticeably different than before. A footnote to highlight the impacts of this major cost impact would be helpful.

Response: INL’s new woody feedstock handling system was designed to deliver feedstock to the gasifier at a lower cost, by optimizing the sequence and type of operations. Since drying equipment in the new design was changed from the previously used rotary dryer, a direct comparison is not applicable. Some information is provided here to give an idea of the cost impacts. If the feedstock cost is changed from \$61.57/dry ton (in this design) to \$50.70/dry ton (as shown in a previous version of the MYPP [DOE MYPP November 2010]) the MESP will decrease by 6.4%. Adding the capital cost for a rotary dryer, which was included in the previous version of the model, increases the MESP by 5.5%. It can be said that the increased feedstock cost is nearly offset by the inclusion of the dryer in the delivered feedstock cost. The major benefit of the new handling system is the lower moisture content. The impact of this change is captured in the sensitivity analysis.

5. **Comment:** Does the woody feedstock price include a realistic cost of storage? The high on-stream factor demands significant on-site feedstock storage (for example, two-week storage may require as much as 75,000 m³). A contingency factor added to the theoretical INL feedstock cost, or at least an uncertainty range associated with it, would also be in order.

Response: Harris Group Inc. has also included land requirements for feedstock handling and storage in estimating the plant footprint and land cost (refer to Appendix L). INL has included costs for receiving, storage, queuing, and preprocessing at the plant in Table 6 of the report. INL will soon release a report detailing the design of the woody feedstock handling system.

6. **Comment:** The use of hot flue gases to dry down to such moisture levels in a rotary drum type dryer would probably result in unacceptable emissions levels.

Response: The design basis for feedstock drying is no longer a rotary dryer and the feedstock moisture at the gasifier in this design is 10% (up from 5% in the previous design). A flue gas scrubbing system was also added to the design (refer to the response for comment #2).

7. **Comment:** Why not use a train instead of trucking in the biomass feedstock with 136 deliveries per day. There are many potential reasons for this including traffic, local emissions, overall efficiency and cost, etc.

Response: This will be dictated by local logistics and will be a suggestion for future consideration.

8. **Comment:** The statement “debarked, delimbed logs are fed into the chipper which uses a 2 inch internal screen” implies the bark and limbs are not utilized as feedstock. Is this correct?

Response: The bark and limbs are also utilized as feedstock. This information and additional details on the feedstock supply system are provided in Appendix F.

Area A200: Gasification

9. **Comment:** Should the fresh water used by ash wetting be replaced by using process condensate, like water from water scrubbing unit?

Response: Concentrated brine waste from the reverse osmosis brine recovery system was utilized for ash wetting in the final design case. This final design change reduced the wastewater and water consumption rates as shown by the “Optimized Water Consumption Case” in the Sustainability Metrics section.

10. **Comment:** Steam is indicated as a fluidization medium for the gasifier and tar reformer. This not only appears unnecessary, but is also counter-productive as described in a recent patent application.

Response: NREL authors understand that the fluidization of gasifier solids in the absence of supplemental steam has been demonstrated. However, this process scheme was not used in the design case since there is not substantial experimental information in the public domain to predict the gasifier outputs for such a configuration. Furthermore, this report represents an update to the 2007 Phillips et al. report (Phillips et al. 2007) and major changes to the process in the front section of the plant were not considered. The primary focus of this design update is to present the modifications in the alcohol synthesis and tar reforming areas along with updated capital costs for the plant. NREL plans to look at the technoeconomics of dry gasification and reforming when more data becomes available.

11. **Comment:** The olivine attrition basis described and make-up allowance for the riser type DFB (dual fluidized bed) gasifier appears to be too low.

Response: The olivine make-up rate due to attrition and system losses is assumed to be 0.011 wt % of the circulation rate (99.989% overall efficiency of two-stage cyclone systems). The per-stage efficiency required to achieve this overall efficiency is less than 99%. Single-stage cyclones in similar dual-fluidized bed designs, like fluid catalytic cracking units, typically achieve greater than 99.9% efficiency (Buell Refinery Cyclones 2008).

12. **Comment:** Suggest elevating the pressure of the front end gasifier and tar reformer units.

Response: The operating pressure was increased from 25 psia to 35 psia (at the gasifier inlet) per recommendation. The purpose of this change is to ensure adequate available pressure drop for the product vapor from the tar reformer to flow through the syngas cooling circuit and syngas scrubber to the suction of the compressor without risk of bottleneaking the gasifier and tar reformer systems.

13. **Comment:** Are there size estimates for the gasifiers? What would be the new size of the gasifiers when doubled to 1,000 MT/day per train?

Response: Sizing calculations for the dual fluidized-bed systems were not provided to NREL as part of Taylor Biomass Energy’s quotation for the packaged systems. However, Taylor Biomass Energy provided NREL with a basis for scaling the costs for the gasifier and tar reformer systems from the quoted 500 MTPD capacity to 1,000 MTPD.

14. **Comment:** What is the basis for the steam-to-feed ratio and the olivine per wood ratios? Perhaps this is covered in other NREL reports (Spath, Mann, et al. or Philips et al.) but a reference if nothing else would be helpful.

Response: The steam-to-feed ratio in the gasifier is within the range of experimental runs using the BCL indirect gasifier. The base case design provides enough steam for fluidization,

but at the same time does not exceed a steam-to-carbon ratio of 2, which is adequate for a fluidized bed tar reformer. Adding more steam in the tar reformer would increase the H₂-to-CO ratio in the syngas, adversely affecting ethanol productivity (as predicted by The Dow Chemical Company's alcohol synthesis model). The olivine-to-biomass ratio is dictated by the energy balance and thermal profile of the gasifier. Heat transfer takes place by moving hot solids from the char combustor to the gasifier. However, there are temperature limitations for the char combustor. The char combustor operates at 1,808°F and the gasifier operates at 1,596°F in the base design case. The heat capacity of the circulating solids should be sufficient to maintain the desired gasifier temperature without exceeding the temperature limits in the char combustor. The values used in this design are similar to those presented in previous NREL reports mentioned in the comment.

15. **Comment:** What is the basis for 2% LHV in gasifier heat loss? Is this a scaled result? If so, how? (Volume-to-area ratios?)

Response: NREL authors did not perform detailed calculations for the heat loss. 2% is simply a reasonable estimate. Heat loss estimated for a 500 TPD indirect (BCL) gasifier was approximately 4% (Feldmann et al. 1988). With improvements in insulation and scale-up to 1,000 MTPD, 2% heat loss is achievable. The impact of a higher heat loss of 4% is captured in the sensitivity analysis.

Area A300: Gas Cleanup

16. **Comment:** As the tar reformer is a significant research area, it might be helpful to have some discussion about the tar reformer – it seems like the costs aren't substantially different from the separate tar cracker/steam reformer, but there must be a significant savings in energy from not cooling down raw syngas then heating it back up.

Response: As mentioned in the comment, the fluidized tar reformer in this design converts tars, methane, and other hydrocarbons in a single operation. The capital cost for a single step fluidized bed reforming system will be less than or comparable to the cost of a design consisting of separate tar cracker and steam reformer systems, depending on the chosen configurations (fixed bed, fluid bed, etc.). A single step process is an elegant conversion method that prevents tar losses, does not require intermediate cooling and reheating, and minimizes associated capital costs and energy losses relative to two separate systems. NREL is further evaluating various options for tar reforming, internally and with industrial partners, and will conduct pilot plant tests in 2012.

17. **Comment:** What is the design basis for sending 75% of the recycled purge syngas to tar reformer and the remaining to the reformer catalyst regenerator? Or what is the specific effect of this split on the methane content? If splitting more purge gas to reformer, will it increase the final products yield? Artifact of power neutrality?

Response: Power neutrality requires the use of a portion of the syngas to provide heat via combustion. The design consideration here is to preferentially route unconverted syngas purge to the catalyst regenerator rather than raw syngas from the gasifier, as the purged syngas is sulfur free. This also prevents the buildup of chemical species that may not be

converted in the tar reformer. These species are effectively removed from the plant by combustion in the catalyst regenerator and purge through the flue gas system.

18. **Comment:** Space velocity indicated for reformer looks reasonable.

Response: Thank you for confirming this.

Area A400: Syngas Compression, Alcohol Synthesis, Acid-Gas Cleanup

19. **Comment:** Suggest that you get The Dow Chemical Company to at least provide a budgetary quote for the DEPG acid-gas removal system as opposed to the approach you used. I'm concerned that costs may be inadequate if one needs to be guaranteed by the licensor.

Response: The feasibility of using the DEPG physical solvent at the process conditions specified was confirmed by The Dow Chemical Company and UOP LLC. A preliminary review of the design basis and cost estimate by The Dow Chemical Company indicated conservatism in NREL authors' assumptions. The Dow Chemical Company suggested contacting UOP for a detailed assessment. NREL authors sent design information to UOP for evaluation but did not receive a response after multiple requests.

20. **Comment:** The work of adding the recent catalyst information from The Dow Chemical Company is valued. It would be helpful to understand how this catalyst differs from the hypothetical catalyst described in the previous report.

Response: NREL did not have access to the catalyst or kinetic data for the 2007 design. Assumptions on catalyst performance were based on data published in the literature. Since the 2007 design, NREL has entered into a Cooperative Research and Development Agreement (CRADA) with the Dow Chemical Company, allowing NREL limited use of The Dow Chemical Company's kinetic model for alcohol synthesis. The kinetic model has predictive capabilities for the behavior of the catalyst, which is especially useful for predicting the impact of recycle streams and inert components in the highly integrated process.

21. **Comment:** It seems that the H₂S/CO₂ recovery system is rather complex and costly. Consideration to commenting on this would be helpful.

Response: The H₂S/CO₂ recovery system appears complex as it is designed to accomplish two major objectives. The first objective is to control the CO₂ concentration in the total alcohol synthesis reactor feed. This is efficiently accomplished in the unconverted syngas recycle loop where the CO₂ partial pressure is high after alcohols have been removed by condensation. The high CO₂ partial pressure minimizes the DEPG circulation requirement, thus minimizing associated capital and operating costs. The second objective is to allow control of the H₂S concentration in the alcohol synthesis reactor, required to maintain catalyst sites in a sulfided state. The amine acid gas enrichment and methanol absorption systems are designed to accomplish this objective. The acid gas enrichment unit takes the weak (low in H₂S) acid gas stream from the DEPG system, rejects a significant amount of CO₂, and generates a more highly concentrated H₂S stream. This highly concentrated stream allows for H₂S absorption into a pure methanol stream. After the absorption, the methanol and H₂S are recycled to the alcohol synthesis reactor.

22. **Comment:** In the 2007 NREL design report, there is no syngas recycling in the mixed alcohol synthesis process and all the unreacted syngas is recycled to the tar reformer process. In this report, 88% of unreacted syngas is recycled to the synthesis reactor. What is the reason for this change?

Response: This change resulted from the incorporation of the alcohol synthesis kinetic model from The Dow Chemical Company into the current design. Using this tool, NREL has observed that the most economically attractive operating conditions are high pressure and low per-pass conversion, which favor ethanol yield and selectivity. The low per-pass conversion requires a high recycle ratio. Recycling large volumes of unconverted material to the tar reformer requires significant decompression and recompression of the syngas, which would significantly increase electrical consumption and negatively impact the overall product yield. By keeping the majority of the unreacted gases in the synthesis loop, recompression requirements are relatively low, improving the process economics.

23. **Comment:** Methanol absorption of H₂S and recycle to alcohol synthesis is used to maintain the H₂S partial pressure for the catalyst. Why not just use the DEPG process to control the removal of H₂S and thus maintain the H₂S in recycle gas and the H₂S partial pressure?

Response: The solubility ratios for CO₂ and H₂S in DEPG do not allow this simplification. The primary objective for the DEPG system is to control the concentration of CO₂ to the alcohol synthesis reactor. The high solubility of H₂S in DEPG results in near complete removal of the species from the recycle stream to the synthesis reactor. If sulfur content in the raw syngas (from raw biomass feed) is not adequate to maintain the minimum partial pressure of H₂S for sulfided catalysts, then another H₂S source must be maintained. NREL was opposed to adding an external sulfur source such as DMDS (dimethyl disulfide) for H₂S maintenance as this would negatively impact the sustainability of the process. An internal H₂S recycle loop was established in this design by first generating a high-purity H₂S stream (through amine-based acid gas enrichment) and then recycling the material by contacting the H₂S-rich stream with methanol.

24. **Comment:** Is the CO₂ mole fraction of 13.5% in the inlet syngas too high? Would higher CO₂ removal in the DEPG process lower the capital costs of the syngas compressor and mixed alcohol synthesis, or perhaps this is offset by increased DEPG costs.

Response: There is potential for further optimization by adjusting the CO₂ concentration. NREL has observed through many model predictions that varying the CO₂ content can have an economic impact of a few cents on the MESP. Based on NREL's observations, the optimal CO₂ concentration lies between 10% and 13.5% (base design concentration). Several factors impact the optimal operating point:

- The capital and operating costs associated with the DEPG system increase with decreasing CO₂ partial pressure.
- The energy penalty from recompression of CO₂ recycle is marginal because the recycle compressor has to compensate only for the pressure drop through the reactor and associated heat exchangers.

- Removing CO₂ results in increased partial pressures of other reactant species, which helps improve yields in general. On the other hand, because CO₂ participates in the reverse water gas shift reaction ($\text{CO} + \text{H}_2\text{O} \rightarrow \text{CO}_2 + \text{H}_2$) in the reactor, higher CO₂ in the recycle loop helps to maintain higher CO in the reactor feed, improving ethanol productivity and selectivity.

Technical targets are set for catalyst performance improvements by 2012 (refer to Appendix I), which are incorporated into the base case design. Adjusting the CO₂ concentration is one of the variables used by NREL to tune model predictions to align with technical targets. As mentioned, NREL's model runs indicate that the base case CO₂ concentration is near the optimal operating point. NREL will continue to optimize the model in future State of Technology reports if opportunities for reducing MESP are recognized.

25. **Comment:** Not sure why DEPG is used for CO₂ removal instead of an amine system. Normally DEPG is better for high pressure gases and an optimization evaluation would be necessary when considering compression of the gas.

Response: The decision was made to utilize a physical solvent for acid gas removal when the alcohol synthesis pressure was increased to 3,000 psia (to optimize product yields). Also refer to responses to comments #21 and #24.

26. **Comment:** The report says "The perturbed-chain statistical associating fluid theory (PC-SAFT) package was used to model physical solvent absorption processes in a separate simulation." This is an odd choice for the DEPG. What is the basis?

Response: The starting point of NREL's DEPG model was an Aspen Plus example that uses the PC-SAFT property method and already has physical property parameters available.

27. **Comment:** The location of the DEPG acid gas system is odd in that it is only on the residual syngas recycle, not on the fresh feed to the synthesis reactor.

Response: Complete H₂S removal is not required upstream of the alcohol synthesis reactor. The primary objective of the acid gas removal system is to control the CO₂ concentration at the throat of the synthesis reactor within a range that does not negatively impact conversion and selectivity to ethanol. As discussed in the response to comment #24, it is also beneficial to feed some CO₂ to the reactor to prevent loss of CO through the water gas shift reaction, which is very fast on metal sulfide catalysts. As discussed in the response to comment #21, the syngas recycle loop is currently believed to be the optimal location for the DEPG system.

28. **Comment:** I noticed you are using an absorption refrigeration system. Was there any trade study done on vapor compression refrigeration (whose COPs are much higher) and perhaps drive it with the onsite steam Rankine cycle (or use a higher temperature packaged organic Rankine cycle power generator)?

Response: NREL incorporated a vapor compression system in earlier design cases. The high power requirements of the vapor compression system and availability of heat streams in the plant prompted NREL authors to explore absorption refrigeration. The advantages of the absorption refrigeration system fit well and resulted in favorable economics compared to the vapor compression system scenario. Note that the plant design is energy neutral, meaning no

electricity is imported or exported. Therefore, energy benefits directly result in increased product yields and decreased MESP. The design includes a steam Rankine cycle to produce electricity. NREL did not consider an organic Rankine cycle for this design.

29. **Comment:** Compressor efficiency: In the 1st paragraph, polytropic compressor efficiencies are given. What is the total efficiency (including mechanical/motor efficiencies) employed?

Response: The six compressor stages have different efficiencies that were obtained from vendor quotes. A 98% mechanical efficiency was applied on top of the polytropic efficiencies quoted. A weighted average efficiency per stage (weighted by power required per stage) is approximately 82%.

30. **Comment:** It is stated that alcohol synthesis is highly exothermic. Please place a ΔH value for a representative synthesis reaction or a range for Eq. 4.

Response: For the ethanol synthesis reaction represented by:



This value was calculated using Aspen Plus with references of 25°F, 1 atm, and vapor phase.

31. **Comment:** More details on synthesis reactor sizing and steam-side heat transfer coefficients would be helpful.

Response: The reactor was sized based on commercially available tube dimensions and maximum tube length of 60 feet. Through an optimization exercise, NREL observed that two parallel reactors provided the optimal balance between capital costs and reactor performance. The maximum number of tubes per reactor is 5,000 based on fabrication constraints. The space velocity and reactor conditions (such as shell side temperature) were manipulated in the integrated simulation until optimal conditions were achieved (within the limitations described above). The results shown for the base case reflect this methodology for reactor sizing. The steam side heat transfer coefficient was conservatively assumed to be 500 $\text{W/m}^2/\text{K}$ (88 $\text{Btu/h/ft}^2/^\circ\text{F}$).

32. **Comment:** It is stated that the inlet pressure to the first expander had to be dropped from 2,900 to 1,500 psi. This represents potentially large exergy destruction. I believe this loss could be mitigated by looking for places where a gas ejector (aka jet pump for liquid-phase streams) could help with compression, such as at the inlet to the intercooled syngas compressor train. This could potentially lower the plant parasitic power. Please feel free to contact me regarding this if you have not already considered it.

Response: The large pressure drop (2,900 to 1,500 psi) is only in the stream that is purged from the recycle loop. This purge stream cannot be mixed with the fresh syngas feed, which is compressed after the quench system.

33. **Comment:** Expander efficiency was 75%...is this isentropic, total efficiency, other?

Response: The isentropic efficiency is 75% and the mechanical efficiency 97%, resulting in overall efficiency of 72.8%. The same is assumed for the steam turbines.

34. **Comment:** What is the design basis for purging 12% unreacted syngas? If the built-up of inert gas in recycle loop is the only basis, what is the limit of the inert gas built up? If

purging more and recycling it to the tar reforming, what are the effects of it on capital and operating cost? Is this an artifact of power neutrality?

Response: The purpose of the unconverted syngas purge is to control the build-up of inert components that are not removed effectively by the DEPG acid gas removal system. The presence of inert compounds in the alcohol synthesis reactor impacts the partial pressures of the reactants. Significant reductions in reactant partial pressures will have a negative impact on yields as predicted by The Dow Chemical Company's kinetic model. The basis for the unconverted syngas purge is the simultaneous optimization of the reactor model yields, energy requirements for recompression, and capital costs.

35. **Comment:** For the statement "Light hydrocarbons, methyl esters, and aldehydes are produced in smaller quantities through similar chemical routes," do you include those compounds in the model?

Response: The model includes small amounts of those species. However, the quantities are not significant and are not included in the material streams shown in Appendix E.

Area A500: Alcohol Separation

36. **Comment:** It is mentioned that the condensed methanol/water is recycled to the gasifier. But in Appendix E (process flow diagrams), it shows that this stream is recycled to the MAS synthesis preheater. Which one is correct?

Response: The condensed methanol/water stream from the molecular sieve system (stream 513L) is recycled to the gasifier. The ambiguity has been resolved in the final report.

Area A600: Steam System and Power Generation

37. **Comment:** While I support the vision of not utilizing natural gas and/or external power, I did not see any capital allocated to start-up the facility under this scenario. In specific, the gasifiers and associated equipment will be refractory lined, and will thus require gradual heat-up during start-up and after repairs. This is traditionally provided by natural gas, yet I saw no allocation of capital towards bulk storage or distribution of natural gas and/or LPG. Further, since internal power generation is based on the combustion of compressed synthesis gas and subsequent steam generation, the feed systems and gasifier will require external power for start-up. The capital estimate did not appear to include provisions for the estimated 5-15 MWh of electricity (depending on whether the first stage of compression is necessary to power the system).

Response: Equipment for start-up of the gasifier trains is included in the scope of the quotation from Taylor Biomass Energy. In addition, NREL has included approximately \$10MM in direct costs (\$15MM after indirect cost factors are applied) to cover site development costs. It is assumed that electrical supply from the grid to the plant will be covered under site development. Transformers, switching stations, and other power system infrastructure are assumed to be fully covered in equipment installation factors as summarized by Harris Group Inc. in Appendix K.

Area A700: Cooling Water & Other Utilities

38. **Comment:** The study assumes power self-sufficiency and a modest power export. This assumption needs to be supported by the process concept by including costs for power transforming stations and power switching stations in the cost estimate. Other OSBL equipment, such as flare systems, waste storage, etc., also should be included. These additional offsites will probably be a sizeable fraction of the assumed Area 700 cost, which is currently a diminutive 1.3% of the TIC. I understand that some supporting equipment and infrastructure is already included in the assumed installation factors, utility and waste processing costs, as well as Area 700 components. However, as comparison, NETL work cites OSBL costs totaling between 11% (NETL 2007) and 21% (NETL 2005) of the TIC for IGCC plants. The large difference in OSBL cost contribution between this work and existing literature requires clarification.

Response: NREL authors believe the capital costs presented in the report adequately cover allowances for OSBL facilities based on the following:

- The NETL IGCC OSBL costs referenced above (as percentages of total installed cost) include steam, power, condensate, and wastewater systems. When costs for these systems are considered for the thermochemical ethanol design (Areas 600 and 700), the installed cost relative to TIC is approximately 19% (\$55.7MM / \$296.7MM), which is at the high end of the NETL range referenced above.
- Transformers, switching stations, and other power system infrastructure are assumed to be fully covered in equipment installation factors as summarized by Harris Group Inc. in Appendix K.
- An emergency flare system is included in costs of the gasifier and tar reformer units as quoted by Taylor Biomass Energy.
- NREL has included approximately \$10MM in direct costs (\$15MM after indirect cost factors are applied) to the estimate to cover site development costs such as roads, logistical access points, wastewater treatment facilities, and other requirements for a green-field site.

39. **Comment:** The assumption that an existing publicly owned wastewater treatment system (POTW) will be available for the majority of the nth facilities is overoptimistic. In fact, the overall percentage of capital allocated towards environmental controls is well below industry averages. Based on my project background, one-third of the capital will typically be necessary to meet environmental regulations. Examples of potential issues with this project include raw water treatment, vent emission controls, waste water treatment, storm water, and spill control.

Response: NREL has incorporated a flue gas scrubber for control of flue gas emissions and a more rigorous water treatment and recycle system into the design after the December 2010 review draft. In addition, NREL has included approximately \$10MM in direct costs (\$15MM after indirect cost factors are applied) to cover site development costs. It is assumed that wastewater storage and treatment facilities will be covered under site development.

40. **Comment:** What are the sources for “water” in the Energy Balance section?

Response: The energy analysis table in the review draft has been replaced by a pie-chart in the final version (Figure 14). The major sources of water contributing to the energy analysis chart (LHV basis) are makeup to cooling tower and boiler system. The source of this water will be site specific.

41. **Comment:** Where are the wastewater treatment costs in the off-site facility from gas scrubbing accounted for in the economics? How is this transported (piped, trucked, train)?

Response: Additional equipment (e.g., reverse osmosis) was included in order to minimize quantities sent to wastewater treatment. Per reviewer comments, NREL has increased the site-development costs in the estimate to cover items such as an on-site wastewater treatment plant. Operating costs associated with the on-site wastewater treatment plant are also included in the analysis.

General

42. **Comment:** The 96% availability is extremely high given that current NGCC and liquid-fed IGCC plants (much lower complexity) strive to achieve 90% availability with a single-train configuration. A 2-week turnaround leaves no room for unplanned down time. This high availability needs to be supported by additional investment in spare trains, intermediate storage, automation, redundant power systems, etc. A critical equipment analysis should be conducted to identify equipment that needs to be fitted with redundant trains, or intermediates that need to be stored, to ensure uninterrupted operation. The sparing of the gasifier, reformer, and synthesis reactor is commended. However, I suggest at least a discussion of whether spare trains for the syngas train (i.e., compressor, gas scrubbing, acid gas removal) were included, and if not, the supporting rationale (e.g., high cost of compression, existing guard beds, etc.).

Response: The assumption that an nth thermochemical conversion plant will achieve 96% utilization is based on two factors. The first is simple – consistency of assumptions between the biochemical and thermochemical platform analyses. However, NREL recognizes the point that thermochemical conversion is a more severe operation than biochemical conversion, which necessitates additional support for the assumption. Petroleum refinery operations like fluid catalytic cracking and fluid coking are similar to the biomass gasification and tar reformer processes in that they are high temperature (although lower than the gasification reactor), dual fluidized bed systems. Refiners have gained tremendous improvement in operating reliability of these refinery applications as the technologies have matured. Similar reliability improvements can be expected for biomass conversion processes as the technology matures. John S. Magee states, “It is not uncommon today to have FCC units complete three-to-four-year runs between major turnarounds with nearly 100 percent stream factor” (Magee 1993). The on-stream factor assumed for the thermochemical design allows a 30-day turnaround per two-year run. NREL has provided MESP values below corresponding to varying on-stream factors. A 2% decrease in assumed on-stream factor increases the MESP by roughly 3 cents per gallon.

Assumed On-Stream Factor	MESP (\$/Gallon Ethanol)
96 % (Base Design Case)	\$2.05
94%	\$2.08
92%	\$2.11

43. **Comment:** The final area of concern with the project was with the estimated on-stream time. In my experience, the assumption of 96% on-stream reliability (without any redundant systems) would be unrealistic. Further, the best numbers I have seen to-date on biomass gasifiers is 92% after three years of continuous operation. And while I can appreciate that there is room for improvement above 92% for an nth facility, 96% is too high, especially given the planned maintenance budget and operations staffing. In my experience, to achieve 96% on-stream reliability requires redundant critical systems and a well developed preventative maintenance program.

Response: Please refer to the response to comment #42. The maintenance budget was also increased (see comment #54).

44. **Comment:** When you do the integration, keep in mind the cost of pipe and ductwork. You don't want to be routing pipe and duct all over the plant.

Response: NREL considered piping costs when incorporating the exchanger network into the plant design. During the design of the heat exchanger network some of the large exchangers were designed to exchange heat within the same plant area. For example, most of the alcohol synthesis inlet stream preheating and product stream cooling were done by exchanging heat between those streams. However, it was not possible to limit all the process heat exchange within the same unit operation area. For example, the hot syngas and flue gas streams have large amounts of heat available in a wide temperature range. Efficient recovery of that heat is possible only by considering the heating needs of the entire plant. The design of the exchanger network will be an area of focus during detailed design of commercial thermochemical plants in order to maximize efficiency while minimizing cost.

45. **Comment:** Though you need it for the DCF (discounted cash flow) analysis, I would not include working capital in the total project cost.

Response: In the final version of the report, the sum of the fixed capital investment (FCI) and working capital yields the total capital investment (TCI). This nomenclature was used for consistency with NREL's biochemical ethanol design report.

46. **Comment:** Look at replacing the water usage versus air coolers. Need to look carefully at the tradeoff between capital and operating costs here.

Response: NREL has incorporated several air coolers in the design to reduce water consumption for plant sustainability.

47. **Comment:** Please provide basis for converting to 2007 dollars.

Response: The conversion to 2007 U.S. dollars is accomplished through Equation 2 and the cost index values in Figure 2. For example, if equipment costs were quoted at \$1MM in 2005, the costs would be adjusted to \$1.12MM for the 2007 basis ($\$1\text{MM} * 525.4 / 468.2$), where 525.4 and 468.2 are the cost index values for 2007 and 2005, respectively. The basis for converting operating costs is noted in Table 29 (footnote). Labor costs are indexed (if necessary) to values from the U.S. Bureau of Labor Statistics (<http://data.bls.gov/cgi-bin/srgate> CEU3232500008).

48. **Comment:** Identify the basis for indirect costs and project contingency of 60%.

Response: The indirect cost factors are consistent with those applied in the biochemical ethanol design report. The values were recommended and agreed upon through the peer review process. For this design, 60% of total direct costs (TDC) correspond to 37.5% of fixed capital investment (FCI), which is consistent within the 16% to 61% of FCI range presented by Peters, Timmerhaus, and West (2004).

49. **Comment:** It may be worth looking into the economic interplay of the energy import/export and alcohol production with the ultimate goal to derive a globally optimum design that minimizes total production cost. This, however, may not have been DOE’s directive in regard to this work.

Response: The design consideration that biorefinery facilities will be energy self-sufficient for steady state operation is consistent between biochemical and thermochemical ethanol pathways. Though economics may improve by purchasing electricity and natural gas for plant operations, the long-term sustainability of the processes will suffer. The consistent assumption allows for easy comparison (a level playing field) among the various technology platforms without adjustments.

50. **Comment:** The study yields a lower Lang factor (3.4) than those universally accepted for any “nth plant” study. For example, Peters, Timmerhaus, and West (2004) recommends a TCI-based Lang factor range between 4.7 for solids processing plants and 6 for fluids processing. Along these lines, a discussion explaining the lower than expected Lang factor is warranted.

Response: There was a typographical error in the draft version of the design report. The 3.4 value is not the Lang factor as defined in Peters, Timmerhaus, and West. The value represents the quotient of the total capital investment (TCI) divided by the total purchased equipment costs (TPEC) including the OSBL equipment (Areas 600 and 700). Lang factors for FCI and TCI (defined below) have been included in the revised report.

	Design Report	Values from Peters, Timmerhaus, and West		
		Solid	Solid-Fluid	Fluid
FCI Lang Factor = FCI / ISBL TPEC	4.12	4.0	4.3	5.0
TCI Lang Factor = TCI / ISBL TPEC	4.32	4.7	5.0	6.0

51. **Comment:** Cost escalation is typically considered for a project that may take 1-2 years to complete engineering work on and 2-4 years to build. Thus, a 3%/yr escalation factor—in excess of normal inflation—may result in ~10% in additional investment costs. A short

discussion explaining whether cost escalation was considered and, if not, the reasons for not including it may prove useful.

Response: NREL did not consider cost escalation (or profit escalation) from inflation as all monetary values are presented on a constant basis of a cost year (2007 U.S. dollars in this case). The MESP is calculated by solving for net present value at start-up (after construction) equal to zero.

52. **Comment:** KWh-to-hp conversions appear to be at 95% efficiency versus the stated 75% efficiency (e.g., 19,683 hp generated to produce 13,953 KWh of electricity).

Response: In the review draft version this was left over from the previous version of the design, in which several pieces of rotating equipment were steam driven. In the current design all rotating equipment is electric motor driven. The efficiencies applied in the model are consistent with the values listed in this report.

53. **Comment:** It is stated in Section 2 that the preferred feedstock for these facilities would be wood biomass. Given the sustained demand for wood, and the required capture radius, it would seem reasonable to assume that the majority of the 350 theoretical facilities would be located within rural/remote areas. I believe that the expected costs for land and site development are underestimated. Specific gaps would include necessary upgrades to the transportation infrastructure around the facility, as well as those necessary on the site itself. This would ultimately include elements such as roads, bridges, rail systems, wetlands mitigation, wells, and outfall systems. As such, I believe that the costs for developing a green-field site in a remote area will exceed 6% of the TPEC, or in this case \$8.5MM.

Response: Since the review draft, NREL has included approximately \$10MM in direct costs (\$15MM after indirect cost factors are applied) to cover site development costs in addition to the land cost estimate of \$1.6MM based on the plant footprint estimate by Harris Group Inc. (refer to Appendix L).

54. **Comment:** Given a replacement asset base of \$470MM, the projected 2% of RAB as a maintenance budget will be insufficient to maintain the facility in good repair (e.g., the entire biomass through syngas generation system is high maintenance). Budgets notwithstanding, I also do not believe that two technicians per shift (or worse yet, eight working M-F on day shift) will be sufficient to maintain the facility at the stated operating factor.

Response: Based on this comment, NREL increased the maintenance budget by 50% to 3% of fixed capital investment (FCI) annually and doubled the number of maintenance technicians from 8 to 16 (2 per shift to 4 per shift).

55. **Comment:** The couple of things I did notice were on the financial front. First, even for the n^{th} plant, I think 60% leverage is very high. That is the kind of leverage we saw in 1st gen and unless the plants have hedged off take I think that will be difficult. I would be thinking more like 40%–50% leverage. Also, even for the n^{th} plant, I think the cost of debt and equity are going to be low (unless there are off take agreements). Equity would likely seek a 12%–15% return and I would look at debt in the 8%–10% range.

Response: Although this is a valuable comment, NREL maintained consistency of financial assumptions with similar reports produced for biomass conversion under the DOE Office of

the Biomass Program’s umbrella. Sensitivity scenarios based on these comments on financial assumptions are presented in Section 5 of the report. A sensitivity scenario is provided below to address the specific recommendations of the reviewer around project financing. With the equity increased to 55% of total financing, return to equity investors increased to 12%, and interest rate on debt increased to 9%, the resulting MESP is \$2.25 per gallon of ethanol.

56. **Comment:** Was the plant size scale-up based on scaling the total installed costs or did you take into account pieces that need to be number up (gasifier, tar reformer). A note to that effect in the sensitivity section would be helpful.

Response: The scale-up sensitivity case scales each piece of equipment or packaged unit based on the associated scaling factor. For the gasifier and tar reformer trains, the maximum capacity per train is limited to 1,000 metric tonnes per day. The 10,000 metric tonnes per day sensitivity case specifies 10 gasifier and tar reformer trains in the equipment list.

57. **Comment:** Accuracy of estimate. I've sent the AACE document separately that I've used as a basis to say that the accuracy is really within 50%, not 30%.

Response: NREL authors feel that with the use of recent experimental data and vendor quotes the uncertainty in the capital cost estimates is significantly lower than 50%. However, even if the uncertainty in the total capital cost is assumed to be the high value of +50%, the corresponding uncertainty in the MESP is approximately +30%. NREL authors mention $\pm 30\%$ as the range of accuracy of the MESP (Appendix I), which corresponds to the 50% uncertainty in capital cost estimates. The sensitivity analysis in Section 5, is based on the expected accuracy values presented in Peters, Timmerhaus, and West (2004).

58. **Comment:** The assumption of “nth plant” for a processing scheme that has yet to see its first commercial application as a whole makes any numerical prediction of estimate uncertainty questionable. The statistics connecting a feasibility or budgeting estimate to their expected accuracy ranges only apply for projects similar to those that statistics were built upon (i.e., commercially demonstrated technology). For example, the 2007 NREL Mixed Alcohol Report—an R&D target study—predicts \$1.01/gal breakeven product value with \$137MM TIC and a (+30)–(-10)% estimate accuracy, yet this year’s re-evaluation produces costs that are twice as large, well outside the previously assumed uncertainty range. This increase in estimated costs is a normal phenomenon as pre-project technical development progresses. Moreover, the practical feasibility of research targets is inherently uncertain making a prediction of accuracy difficult at this stage. Along these lines, I suggest qualifying the estimate class as a “Class 4–type (feasibility/study)” or “Class 3–type (budget authorization)” based on guidelines developed by the Association for the Advancement of Cost Engineering, but without including a numerical accuracy range.

Response: Please see the responses to related comments #57 and #61. Also note that the \$1.01/gal projection was based on a lower feedstock cost (\$35/dry ton) and is in 2005 U.S. dollars. The MESP was since revised to \$1.57/gallon in 2007 U.S. dollars, using a higher feedstock cost of \$50.70/dry ton, as documented in Table B-5 of the November 2010 Multi-Year Program Plan (DOE MYPP November 2010). The current MESP of \$2.05/gallon is roughly 30% higher than the previously projected \$1.57/gallon. The authors are confident that because estimates in this report are based on experimental results and recent vendor

estimates, the results presented in this report are representative of nth plant costs for the technologies proposed in this design. It should be noted that there were significant uncertainties in the alcohol synthesis section of the 2007 Phillips et al. (Phillips et al. 2007) report. In 2007, the performance of the alcohol synthesis reactor was inferred and improvements extrapolated to 2012 based on literature information because that was the best available information at that time. In the current design, which is based on experimental results, the cost estimates are based on current understanding of the state of technology. Increases in capital estimates can be categorized as follows:

- The increased capital estimates are primarily a result of obtaining recent vendor quotes through Harris Group Inc. For example, the recent estimates of gasifier and reformer installed costs are three times higher than those presented in the 2007 report. There are reviewer comments suggesting that the gasifier/reformer estimates may be high for nth-plant costs because they are based in today's quotes and costs should decrease with maturity associated with the nth-plant (comment #62). There remains some scope for a downward revision of the gasifier/reformer costs.
- The alcohol synthesis process conditions and flows were redesigned based on experimental and modeled data. The operating pressure is higher and conversions are lower than in the 2007 assumptions. The modified process led to higher capital costs. NREL was able to offset some of the increased capital costs in this area by improving the overall yields through improved process design and energy integration. There is a potential for the reduction of costs in this area with improvements in catalysis.
- The detailed vendor estimates for the compressors also showed a marked increase from the 2007 estimates (partly due to the higher operating pressure).

Although it is usually the case that cost revisions follow an upward trend, NREL authors feel that the projected nth-plant costs in this report are conservative in some areas and there is potential for a downward revision in the future.

59. **Comment:** The only consideration I have a slight issue with is that of the “nth plant” design in that it helps in providing justification and support for early technology adopters and pioneer plants. I believe even these types of investors will have to be reassured that it is not a matter of 3 to 5 years down the road before a lower cost plant could be designed and put on stream. In my experience the “nth plant” will have benefitted from the knowledge-basis of previously designed plants resulting in a plant capital cost that typically falls on the lower portion of the cost vs. number of plants built “curve.” To this end, I do not think in its present state this design falls in the “nth plant” category. However, as I said it is not a major issue and given the thoroughness of your sensitivity analysis the concern with the “nth plant” assumption is most likely a moot point.

Response: NREL authors agree with this observation and believe the estimates presented in this design may be on the conservative side of the range for nth plant costs.

60. **Comment:** I think you may have over-valued the co-products. I can't tell the petroleum-derived equivalent fuel price on a \$/gal basis from the report. I would think that you would want to be equivalent to a residual fuel oil, which is normally valued less than crude oil (on a

\$/gal basis) and about 60%–70% of gasoline. The \$1.90 per gal is almost the same as the MESP of your major product. Since this co-product contribution is about 10% of the MESP it should be calculated with care.

Response: Based on this comment, NREL authors reduced the co-product credit to approximately 90% of the calculated energy value. Refer to Table 32 for details on co-product pricing.

61. **Comment:** Regarding the comparison of market studies in Table 2: Were the TE model results independent of the market studies? Text below Table 2 seems to imply they were not, in which case the usefulness of the comparison is strongly limited for the present study since no biorefineries of this scale exist.

Response: The paragraph following Table 2 discusses this issue, stating that there are more uncertainties (less specific information) in the study of pre-commercial technologies. Based on the comment, NREL authors added an additional sentence stating that there will be more uncertainties in the cost predictions from such studies.

62. **Comment:** Using first-of-its-kind cost estimates for gasifier, tar reformer, and syn. reactor seems inconsistent given the nth generation plant TE model philosophy. While the sensitivity analysis results may capture some of this variability, economies of production (no. units per year) combined with the hardware production learning curve are likely to result in more significant cost reductions than the range explored in the sensitivity analysis section.

Response: NREL authors agree that there is a possibility of further cost reductions because the initial basis for the gasifier/reformer cost estimate is current technology costs. It should be noted that NREL's design configuration has slight variations from the Taylor Biomass Energy system in the reforming section, and it was assumed that some of the savings in the nth-plant will be absorbed by these variations in NREL's design.

63. **Comment:** In this section and periodically throughout the report, hardware performance assumptions or improvements over the 2007 report are made but justification is not given. It would be beneficial to understand NREL's reasoning behind performance improvements, such as those given in Table 10 and in Sec. 3.4.2. References and rationale behind such improvements should be presented.

Response: Table 10 referred above shows the performance of the tar reforming catalyst. Significant progress was made in this area through targeted research since the previous report in 2007. The performance improvements shown are based on experimental results. Sec. 3.4.2 refers to the performance of the alcohol synthesis catalyst, which is now based on experimental and modeled results for The Dow Chemical Company's catalyst. The previous values were based on information from literature. The updated values shown in this report represent the current state of technology and improvements achievable by 2012.

64. **Comment:** It would be very useful to understand the current technology status of hardware and have it accompany any rationale given for performance improvement expectations. For example, the use of Technology Readiness Levels (such as those used by Department of Defense, NASA, numerous aerospace corporations, and increasingly DOE—albeit informally) could inform one of the current status.

Response: This is a good suggestion and will be considered in future reports. The majority of the equipment and technology used in this design is commercial. The key areas that require further development are (1) reforming catalyst, (2) extended testing of the catalyst in a fluidized bed and detailed design based on the test results, (3) alcohol synthesis catalyst, and (4) scale-up of the gasifier from 500 MTPD to 1,000 MTPD. NREL and its partners will work on items (1), (2), and (3) for 2012. Commercial vendors will need to work on scale-up of the gasifier from 500 MTPD and a larger-than-pilot-scale demonstration of the reforming catalyst.

65. **Comment:** What kinds of pinch temperatures are employed in the heat exchangers?

Response: Details for all exchangers are included in Appendix A, Appendix B, and Appendix M.

66. **Comment:** Pinch Analysis section (of review draft). Perhaps 'temperature versus enthalpy' nomenclature is use in some circles, but I believe such figures are typically named T-Q diagrams, where Q is the amount of heat transferred on the x-axis.

Response: The text has been modified to state "heat flow" instead of "enthalpy."

67. **Comment:** Energy Balance section (of review draft): This is slightly confusing. It would make sense to report an overall plant efficiency on an HHV-basis in addition to LHV-basis and while keeping your LHV energy balance regarding the intermediate process streams. Further, the statement, "The enthalpies calculated and reported..." is also a little confusing. Perhaps you mean the total enthalpy ($hf + dh$) as the heat of formation only includes the energy of formation for a compound and the latent energy (at the standard state).

Response: NREL authors did not perform a detailed review of this section prior to the release of the December 2010 review draft. The text in this section has since been modified. As you point out, Aspen Plus does report total enthalpy. During review, NREL authors simplified the text because this section was unnecessarily wordy and trying to explain things readily available in textbooks. Energy balance is still reported on an LHV basis. NREL authors feel this is more valuable for capturing the negative impacts of water input into the process. Also LHV is an important quantity for end use as a transportation fuel (for internal combustion). NREL authors agree it will be useful to add another set of data on an HHV basis and will consider this in future reports.

68. **Comment:** It should be noted in the text that the sensitivity to plant size assumes use of the same technologies as those of the larger plants. This is not necessarily a good assumption when scaling costs. Perhaps this is reasonable for a 600-MTPD biorefinery, but it could be debatable as, for instance, multiple dolomite beds and catalytic candle filters may be preferred over water-scrubbing or warm gas desulfurization in conjunction with water-gas shift membrane reactors over Selexol type of gas cleanup. This also depends on your assessment of the technology readiness of alternative technologies.

Response: This is a very valid point. NREL authors added the note to the text.

69. **Comment:** It would be useful to summarize the uncertainty of key plant process areas shown in the cost summary (Appendix C). For instance, the uncertainty associated with alcohol synthesis reactor shown in the sensitivity analysis tornado chart is in the neighborhood of

-14.4% and +15.5% on MESP (when summing all associated capital and catalyst costs). This could also be done for the feedstock and other areas.

Response: The NREL authors felt that individual sensitivities shown in Section 5 provide the necessary information to get an idea of the impacts of uncertainties. A more detailed analysis of uncertainty ranges will be conducted in the future. A simple sum of uncertainties from the tornado chart for each process area will be misleading.

Appendix O References

Buell Refinery Cyclones. (2008). "Fluid Catalytic Cracking Cyclone Design and Modifications." Buell Refinery Cyclones website. Lebanon, PA: Fisher-Klosterman, Inc., a CECO Environmental Company. http://www.buellrefinery.com/refining_details.htm.

DOE MYPP. (November 2010). *Biomass Multi-Year Program Plan*. Washington, DC: U.S. Department of Energy. http://www1.eere.energy.gov/biomass/pdfs/biomass_mypp_november2010.pdf.

Feldmann, H.F.; Paisley, M.A.; Appelbaum, H.R.; Taylor D.R. (1998). *Conversion of Forest Residues to a Methane-Rich Gas in a High-Throughput Gasifier*. Report DE88013138. Columbus, OH: Battelle.

Magee, J.S. (1993). *Fluid Catalytic Cracking: Science and Technology*. Amsterdam, the Netherlands: Elsevier.

NETL. (2005). *Task 3 Gasification Plant Cost and Performance Optimization: Final Report*. Work performed by Nexant under DOE Contract No. DE-AC26-99FT40342. Pittsburgh, PA: National Energy Technology Laboratory.

NETL. (2007). *Baseline Technical and Economic Assessment of a Commercial Scale Fischer-Tropsch Liquids Facility*. DOE/NETL Report No. 2007/1260. Pittsburgh, PA: National Energy Technology Laboratory.

Peters, M.S.; Timmerhaus, K.D.; West, R. (2004). *Plant Design and Economics for Chemical Engineers*, 5th Edition, International Edition. New York: McGraw-Hill Inc.

Phillips, S.; Aden, A.; Jechura, J.; Dayton, D.; Eggeman, T. (2007). *Thermochemical Ethanol via Indirect Gasification and Mixed Alcohols Synthesis of Lignocellulosic Biomass*. Report No. NREL/TP-510-41168. Golden, CO: National Renewable Energy Laboratory. <http://www.nrel.gov/docs/fy07osti/41168.pdf>.