

AD-A134 138

PROFILE OF LASER-PRODUCED ACOUSTIC PULSE IN A LIQUID
(U) IBM RESEARCH LAB SAN JOSE CA A C TAM ET AL.
12 OCT 83 TR-4 N00014-83-C-0170

1/0

UNCLASSIFIED

F/G 20/1

NL



END
DATE
FILMED
BY
DTIC

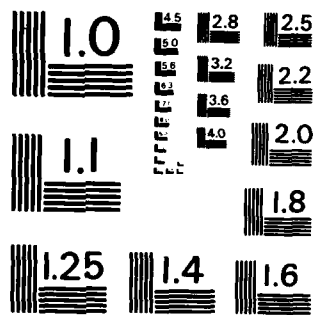

MICROCOPY RESOLUTION TEST CHART
NATIONAL BUREAU OF STANDARDS - 1963 - A

12

AD-A134138

DTIC FILE COPY

REPORT DOCUMENTATION PAGE		READ INSTRUCTIONS BEFORE COMPLETING FORM
1. REPORT NUMBER 4	2. GOVT ACCESSION NO.	3. RECIPIENT'S CATALOG NUMBER
4. TITLE (and Subtitle) Profile of Laser-produced Acoustic Pulse in a Liquid		5. TYPE OF REPORT & PERIOD COVERED Technical Report
		6. PERFORMING ORG. REPORT NUMBER
7. AUTHOR(s) A. C. Tam B. Sullivan		8. CONTRACT OR GRANT NUMBER(s) N00014-83-C-0170
9. PERFORMING ORGANIZATION NAME AND ADDRESS International Business Machines 5600 Cottle Road, Dept K46 San Jose, CA 95193		10. PROGRAM ELEMENT, PROJECT, TASK AREA & WORK UNIT NUMBERS NR 633-844
11. CONTROLLING OFFICE NAME AND ADDRESS Office of Naval Research 800 N. Quincy Street Arlington, VA 22217 Code 1231. MC		12. REPORT DATE October 12, 1983
		13. NUMBER OF PAGES 20
14. MONITORING AGENCY NAME & ADDRESS (if different from Controlling Office)		15. SECURITY CLASS. (of this report) Unclassified
		15a. DECLASSIFICATION/DOWNGRADING SCHEDULE
16. DISTRIBUTION STATEMENT (of this Report) This document has been approved for public release and sale; its distribution is unlimited.		
17. DISTRIBUTION STATEMENT (of the abstract entered in Block 20, if different from Report)		
18. SUPPLEMENTARY NOTES To be published in Journal of Acoustical Society of America		
19. KEY WORDS (Continue on reverse side if necessary and identify by block number) opto-acoustic profiles, probe beam deflection, opto-acoustic pulses		
20. ABSTRACT (Continue on reverse side if necessary and identify by block number) Recently, Lai and Young (J. Acoust. Soc. Am., 72, 2000 (1982)) and Heritier (Opt. Communic. 44, 267 (1983)) have independently calculated the profile of a thermo-elastically generated opto-acoustic pulse due to the passage of an excitation laser pulse of certain spatial and temporal intensity distributions in a weakly absorbing medium. We have found that their results are essentially equivalent for Gaussian intensity distributipn of the excitation laser. We report the first experimental verification of such theoretical opto-acoustic profiles (over)		

DTIC
ELECTE
S OCT 28 1983 D
B

DD FORM 1 JAN 73 1473

EDITION OF 1 NOV 65 IS OBSOLETE
S/N 0102-LF-014-6601

SECURITY CLASSIFICATION OF THIS PAGE (When Data Entered)

20. (cont)

excited by laser pulses of various pulse widths τ_{FWHM} (8nsec and 1.3 μ sec) focussed to different beam waists w_0 . Our observation of the profile is performed with a probe deflection technique instead of using conventional acoustic transducers which have limited risetimes and nonflat frequency response. Our results are in reasonable agreement with theory, and clearly indicate that sharp opto-acoustic pulses can be generated by laser pulses of short τ_{FWHM} and small w_0 .

Accession For	
NTIS	<input checked="" type="checkbox"/>
DTIC	<input type="checkbox"/>
Unannounced	<input type="checkbox"/>
Justification	
Distribution/	
Availability Codes	
Dist	Avail and/or Special
A	

1/5

OFFICE OF NAVAL RESEARCH
Contract N00014-83-C-0170
Task No. NR 633-844

TECHNICAL REPORT NO. 4

Profile of Laser-produced Acoustic Pulse
in a Liquid

By

A. C. Tam and B. Sullivan

IBM Research Laboratory
San Jose, California 95193

October 12, 1983

Reproduction in whole or in part is permitted for
any purpose of the United States Government

This document has been approved for public
release and sale, its distribution is unlimited

TECHNICAL REPORT DISTRIBUTION LIST, GEN

Office of Naval Research (2) Attn: Code 413 800 North Quincy Street Arlington, VA 22217	Naval Ocean Systems Center (1) Attn: Mr. Joe McCartney San Diego, AC 92152
ONR Pasadena Detachment (1) Attn: Dr. R. J. Marcus 1030 East Green Street Pasadena, CA 91106	Naval Weapons Center (1) Attn: Dr. A. B. Amster Chemistry Division China Lake, CA 93555
Commander, Naval Air Syst Comm. (1) Attn: Code 310C (H. Rosenwasser) Department of the Navy Washington, DC 20360	Naval Civil Eng. Laboratory (1) Attn: Dr. R. W. Drisko Port Hueneme, CA 93401
Defense Technical Inf. Center (12) Building 5, Cameron Station Alexandria, VA 22314	Dean William Tolles (1) Naval Postgraduate School Monterey, CA 93940
Dr. Fred Saalfeld (1) Chemistry Division, Code 6100 Naval Research Laboratory Washington, DC 20375	Scientific Advisor (1) Commandant of the Marine Corp. (Code RD-1) Washington, DC 20380
U.S. Army Research Office (1) Attn: CRD-AA-IP P. O. Box 12211 Research Triangle Park, NC 27709	Naval Ship Res. & Dev. Center (1) Attn: Dr. G. Bosmajian, Chemistry Division Annapolis, MA 21401
Mr. Vincent Schaper (1) DTNSRDC Code 2803 Annapolis, MA 21402	Mr. John Boyle (1) Materials Branch Naval Ship Engineering Center Philadelphia, PA 19112
Naval Ocean Systems Center (1) Attn: Dr. S. Yamamoto Marine Sciences Division San Diego, CA 91232	Mr. A. M. Anzalone (1) Administrative Librarian PLASTECH/ARRADCOM Bldg. 3401 Dover, NJ 07801
Dr. Henry Freiser (1) Chemistry Department University of Arizona Tucson, AZ 85721	Dr. Lynn Jarvis (1) Code 6170 Naval Research Laboratory Washington, DC 20375
Dr. Gregory D. Botsaris (1) Dept of Chemical Engineering Tufts University Medford, MA 36849	Dr. J. H. Hargis (1) Department of Chemistry Auburn University Auburn, AL 36849
Dr. Carl Heller (1) Code 3851 Naval Weapons Center China Lake, CA 93555	Dr. C. G. Enke (1) Department of Chemistry Michigan State University East Lansing, MI 48824
Director, Naval Research Lab (6) Attn: Code 2627 (DODAAD Code N00173) Washington, DC 20375	

965 - IBM - 50

12

Research Report

PROFILE OF LASER-PRODUCED ACOUSTIC PULSE IN A LIQUID

B. Sullivan
A. C. Tam

IBM Research Laboratory
San Jose, California 95193

LIMITED DISTRIBUTION NOTICE

The report has been submitted for publication outside of IBM and will probably be copyrighted if accepted for publication. It has been staged as a Research Report for early dissemination of its contents. In view of the transfer of copyright to the outside publisher, its distribution outside of IBM prior to publication should be limited to peer communications and specific requests. After outside publication, requests should be filled only by reprints or legally obtained copies of the article (e.g., payment of royalties).



Research Division
Yorktown Heights, New York • San Jose, California • Zurich, Switzerland

PROFILE OF LASER-PRODUCED ACOUSTIC PULSE IN A LIQUID*

B. Sullivan
A. C. Tam

IBM Research Laboratory
San Jose, California 95193

ABSTRACT: Recently, Lai and Young (*J. Acoust. Soc. Am.*, 72, 2000 (1982)) and Heritier (*Opt. Communic.* 44, 267 (1983)) have independently calculated the profile of a thermo-elastically generated opto-acoustic pulse due to the passage of an excitation laser pulse of certain spatial and temporal intensity distributions in a weakly absorbing medium.

Lai and Young's
We have found that their results are essentially equivalent for Gaussian intensity distribution of the excitation laser. *The value* We report the first experimental verification of such theoretical opto-acoustic profiles excited by laser pulses of various pulse widths τ_{FWHM} (8 nsec and 1.3 μ sec) focussed to different beam waists w_0 . *Sub 0.1* Our observation of the profile is performed with a probe beam deflection technique instead of using conventional acoustic transducers which have limited risetimes and nonflat frequency response. *For authors'* Our results are in reasonable agreement with theory, and clearly indicate that sharp opto-acoustic pulses can be generated by laser pulses of short τ_{FWHM} and small w_0 . *Sub 0.1*

*This work is partially supported by the Office of Naval Research.

1. INTRODUCTION

The phenomena of opto-acoustic (OA) pulse generation due to thermal expansion induced by a pulsed optical beam has been known for some twenty years now. Earlier observations of OA pulses produced by pulsed laser beams in liquids were reported, for example, by Askaryan *et al.*,¹ Carome *et al.*,² and Rentzepis and Pao.³ Important modern applications of pulsed OA generation include spectroscopy,⁴ energy transfer studies and ultrasonic measurements.⁵ However, most experimental detection of the OA pulses have been performed by using piezoelectric transducers or microphones, and the true OA pulse profile produced by an excitation laser pulse cannot be readily measured. The present work seems to be the first quantitative experimental investigation of the true OA profile (detected by a probe beam deflection technique^{6,7,8}) as a function of the excitation laser pulse parameters. Such quantitative understanding is important for the optimization of various OA applications.^{5,9}

The importance of theoretical understanding of the pulsed thermo-elastic OA generation phenomenon can be appreciated from the many theoretical papers on this topic, including White,¹⁰ Gournay,¹¹ Hu,¹² Lyamshev and Naugol'nykh¹³ and others. Recently, explicit mathematical forms for the OA pulse profile in a liquid excited by a Gaussian (spatial and temporal) laser pulse have been given independently by Lai and Young¹⁴ and Heritier.¹⁵ Both theoretical treatments have provided insight as to the method to produce OA pulses of desired profile; for example, laser pulses of narrow diameter and short duration should produce narrow OA pulses propagating in the lateral direction in a weakly absorbing medium. Their theoretical results, which turn out to be basically equivalent, are described in Section 2. Our experimental arrangement to verify these theoretical thermo-elastic OA profiles are described in Section 3, and our observations are presented in Section 4.

2. THEORY

Analytical solution of the pulsed OA generation due to thermo-elastic mechanism in a weakly absorbing medium is possible for the simple case of a Gaussian intensity distribution in space and time of the excitation laser beam. It should be noted that the exact form for the Gaussian distribution may vary among authors. Lai and Young¹⁴ have described a Gaussian laser beam in the following form:

$$I_{LY}(r,t) = \frac{E}{(2\pi)^{3/2} R^2 \tau_p} \exp\left(-\frac{r^2}{2R^2} - \frac{t^2}{2\tau_p^2}\right) \quad (1)$$

where I_{LY} is the laser intensity at distance r from the beam axis, E is the laser pulse energy, t is the time from the peak of the laser beam, R is a measure of the laser beam radius and τ_p is a measure of the pulse duration. Lai and Young have solved the acoustic wave equation with a source term being due to the thermal expansion produced by $I_{LY}(r,t)$, and obtained the OA pressure $P_{LY}(r,t)$ in terms of Bessel function:

$$P_{LY}(r,t) = K \tau_e^{-3/2} \frac{d\Phi_o(\xi)}{d\xi} \quad (2)$$

where

$$K = \frac{\alpha\beta E}{8\pi^{1/2} C_p} \left(\frac{v_a}{r}\right)^{1/2}, \quad (3)$$

$$\tau_e = [\tau_p^2 + \tau_a^2]^{1/2}, \quad (4)$$

$$\Phi_o(\xi) = |\xi|^{1/2} \exp(-\xi^2/4) \left[\frac{\sqrt{2}}{\pi} K_{1/4}\left(\frac{\xi^2}{4}\right) + 2\Theta(\xi) I_{1/4}\left(\frac{\xi^2}{4}\right) \right], \quad (5)$$

$$\xi = \left(t - \frac{r}{v_a}\right) / \tau_e = t' / \tau_e. \quad (6)$$

In Eq. (2), K determines the magnitude of the OA pulse, τ_e is a time scale factor which determines the width and the magnitude of the OA pulse, and $d\Phi_o/d\xi$ determines the shape of the pulse. The symbols used have the following meanings: α is the optical absorption coefficient, β is the volume expansivity, C_p is the specific heat at constant pressure, v_a is the acoustic velocity, $\tau_a = R/v_a$ is an acoustic transit time in the source, t' is the retarded time with $t'=0$ being at the moment r/v_a after the laser peak, ξ is a normalized retarded time, $K_{1/4}$ and $I_{1/4}$ are Bessel functions of imaginary arguments and Θ is the unit step function.

Independent of Lai and Young,¹⁴ Heritier¹⁵ has also solved the thermo-elastic wave equation for excitation by a Gaussian laser beam, with an intensity distribution $I_H(r,t)$ defined by

$$I_H(r,t) = \frac{2E}{\pi^{3/2} w_0^2 \tau} \exp\left(-\frac{2r^2}{w_0^2} - \frac{t^2}{\tau^2}\right). \quad (7)$$

Here w_0 is known as the beam waist¹⁶ and is equal to $2R$, and τ is the e^{-1} half width of the laser pulse, related to the full width at half maximum τ_{FWHM} by

$$\tau_{FWHM} = 1.665 \tau. \quad (8)$$

The solution for the OA pressure $P_H(r,t)$ obtained by Heritier due to the thermal expansion produced by $I_H(r,t)$ in a weakly absorbing medium is

$$P_H(r,t) = K' e^{-3/2} F(x) \quad (9)$$

where

$$K' = \frac{\alpha\beta E}{(2\pi)^{3/2} C_p} \left(\frac{v_a}{\tau}\right)^{1/2}, \quad (10)$$

$$\epsilon = (\tau^2 + w_0^2/2v_a^2)^{1/2} \quad (11)$$

$$x = \left(t - \frac{r}{v_a}\right) / \epsilon = t' / \epsilon \quad (12)$$

and

$$F(x) = \left[\Gamma\left(\frac{3}{4}\right) {}_1F_1\left(-\frac{1}{4}; \frac{1}{2}; x^2\right) - 2x\Gamma\left(\frac{5}{4}\right) {}_1F_1\left(\frac{1}{4}; \frac{3}{2}; x^2\right) \right] \exp(-x^2) \quad (13)$$

Here, analogous to the Lai and Young's solution in Eqs. (2)-(6), K' is an amplitude factor, ϵ is a time scale factor and F is the shape function expressed in terms of confluent (or degenerate) hypergeometric function ${}_1F_1(a;b;z)$. The symbols not previously introduced are x which is the retarded dimensionless time equal to the retarded time t' divided by ϵ , and Γ which is the Gamma function.

We have made comparison of the numerical results of Lai and Young's solution (Eqs. (2-6)) and those of Heritier's solution (Eqs. (9-13)). Both solutions state that the shape of the OA pressure pulse is dependent on time t only through the retarded dimensionless time $\xi = t'/\tau_e$ in Lai and Young's result and $x = t'/\epsilon$ in Heritier's result. Due to their different definitions of the Gaussian spatial and temporal dependence of the laser pulse, it should be noted that the two "time scale parameters" ϵ and τ_e differ by a factor of $\sqrt{2}$:

$$\epsilon = \sqrt{2}\tau_e \quad (14)$$

We have found that the solution for the time dependent OA pressure profiles $P_{LY}(r,t)$ and $P_H(r,t)$ given in Eqs. (2) and (9), respectively, are essentially equivalent; this is shown in

Fig. 1, where both theoretical profiles are plotted with respect to the dimensionless times ξ and x .

To be specific, we shall use Heritier's¹⁵ notation from here on. ϵ is called the "time scale parameter" of the OA pulse, because ϵ truly controls the temporal width of the OA pulse. For example, Heritier's¹⁵ line shape (Fig. 1) shows that the separation between the peak and the trough of the OA pressure pulse is $\Delta x = 1.66$, corresponding to a time separation being:

$$\Delta t_{\text{pk-tr}} = 1.66 \epsilon . \quad (15)$$

The same numerical result is obtained by analyzing Lai and Young's results.

3. EXPERIMENT

The present experiment is a first attempt to verify the theoretical OA pulse profile predicted by Lai and Young¹⁴ and Heritier.¹⁵ The schematics of our experimental arrangement is shown in Fig. 2. Two types of excitation lasers with different pulse durations are used. Most data were obtained with a Molelectron N_2 pumped dye laser providing laser pulses of $\tau_{\text{FWHM}} = 8$ nsec, and pulse energy $E = 0.16$ mJ at 10 Hz repetition rate. The dye laser wavelength is 580 nm with a bandwidth of 5 nm. The laser beam is spatially filtered and an iris is used to provide a 4 mm diameter collimated beam, which is directed to a 90° prism and a focussing lens mounted on a translation stage (see Fig. 2). This excitation laser pulse is thus focussed into the sample cell. Some of our data have also been obtained⁶ with an excitation laser of longer duration ($\tau_{\text{FWHM}} = 1.3$ μsec). To change the beam waist w_0 of the excitation laser, we use focussing lenses of different focal lengths f . For the N_2 pumped dye laser, values for f used are 60 mm, 120 mm and 254 mm; the corresponding values of

w_0 are measured by using a calibrated pinhole to be 20, 49 and 74 μm respectively. For the flashlamp pumped dye laser, f is 80 mm, and the waist w_0 is approximately 10 μm .

The probe laser beam from a 1 mW HeNe laser is beam expanded to a 10 mm diameter collimated beam, which is focussed in the cell by a lens of 135 mm focal length, producing a probe beam waist of about 9 μm . The direction of the probe beam is adjusted to be parallel to that of the excitation beam. This is done by first moving the translation stage controlling the excitation laser beam so that the two beams are made to be coincident. Subsequently, the two beams are displaced (by moving the translation stage) to a separation of typically 5 mm for the present measurements. The glass sample cell is of rectangular shape (5×3×8 cm) and contains methanol doped with a dye (e.g, Rhodamine 640) at about 23°C. The observed OA signal shape is independent of the dye concentration if the transmission of each laser beam is not less than ~30%.

The transmitted probe beam is directed onto a 6328Å interference filter (to block out scattered light from the dye laser) and a fast photodiode-preamplifier assembly (Analog Module model LNVA-O). The small active area of the photodiode (0.8 mm²) measures the intensity of only a small portion of the probe beam; its position in the probe beam (of diameter about 4 mm at the photodiode) can be adjusted by a translation stage. When the OA pulse produced by the excitation beam crosses the probe beam, a transient angular deflection¹⁷ ϕ of the probe is produced:

$$\phi(r,t) \approx \frac{\ell}{n_0} \frac{\partial n(r,t)}{\partial r} \propto \frac{\partial p(r,t)}{\partial t} \quad (17)$$

where n_0 is the normal refractive index of the liquid, $n(r,t)$ is the change in the refractive index which is proportional to the OA pressure $P(r,t)$, and ℓ is the interaction length of the OA pulse with the probe laser. The small transient probe deflection ϕ causes the probe

beam to move across the detection photodiode. If the photodiode is suitably positioned at a wing of the probe beam cross section, the deflection ϕ produces an optimum intensity change; however, if it is positioned at the center of the probe beam, ϕ produces much smaller intensity changes. This is explained in Fig. 3, where the observed signals are also shown. The photodiode and preamp assembly has a bandwidth of 100 Hz-100 MHz. Its output is displayed on a 75 MHz bandwidth oscilloscope (Tektronix 7854 with 7A24 plug in). The digitizing and signal averaging capability of the oscilloscope is too slow to be useful for recording the OA signal; hence, any signal averaging is presently performed by photographing the scope display with multiple exposures (e.g., for 50 laser shots).

The observed probe-beam deflection signal $S(t)$ from the photo-diode is given by the following equation:

$$S(t) = G I_p'(r_d) L \phi , \quad (18)$$

where G is a constant depending on the photo-diode sensitivity and electronic gain of the detection system, $I_p'(r_d)$ is the lateral spatial derivative of the probe-beam intensity distribution at the photo-diode position r_d (with the active area of the photo-diode being sufficiently small), and L is the "lever arm" of the probe beam (i.e., distance from the interaction region in the cell to the photo-diode). Combining Eq. (17) and Eq. (18), we have

$$S(t) \propto \partial p(r,t) / \partial t , \quad (19)$$

which means that our experimental probe-beam deflection signal is a measure of the *time-derivative* of the OA pulse at the probe-beam position in the liquid. To compare with theory, we should either compare the observed signal with the time-derivative of the theoretical OA profile, or equivalently, compare the time-integral of the observed signal with

the theoretical OA profile. We shall choose the former method, since we believe that it is better to make theoretical comparisons with the raw data rather than with "processed" data wherever possible.

4. EXPERIMENTAL RESULTS

The experimentally observed probe deflection signals for three different focussing of the N_2 pumped dye laser are shown in Fig. 4. These signals are obtained with the photodiode being in a wing of the probe beam cross section (Fig. 3a) so that the signals are maximized. These observed signals are replotted in Fig. 5 in dimensionless times; the best fits to the theoretical deflection signal are obtained with the time scale parameter ϵ being 10.6, 30.1 and 42.9 nsec for focussing lens of focal length 60, 120 and 254 mm, respectively. Our results are summarized in Table I, which gives the measured beam waist w_0 and the corresponding theoretical values of ϵ according to Eq. (11), and the best fit values of ϵ . We see that the theoretical time scale parameter according to Eq. (11) agrees with the value obtained by fitting the experimental profile to better than about $\pm 20\%$. This provides a first experimental verification of the theoretical profiles calculated.^{14,15}

The observed probe deflection signal for the case of flashlamp pumped dye laser excitation is shown in Fig. 6; the best fit to the theoretical signal (Fig. 7) is obtained with $\epsilon = 1.05 \mu\text{sec}$. Here, if we fit the excitation laser pulse of $\tau_{\text{FWHM}} = 1.3 \mu\text{sec}$ (see Fig. 6) by a Gaussian intensity distribution, we obtain a laser width parameter $\tau = 780 \text{ nsec}$. For such a long pulse duration and small beam waist ($w_0 = 10 \mu\text{m}$), Eq. (11) indicates that ϵ should be approximately equal to τ . The $\sim 25\%$ difference between the fitted OA time scale parameter ϵ and laser pulse width τ is partially because the laser intensity is significantly nonGaussian.

It is clear from Figs. 5 and 7 that there is an imperfect agreement between the experimentally observed OA signal and the theoretical signal predicted by Lai and Young¹⁴ or by Heritier.¹⁵ The agreement is better for the earlier half of the signal than the latter half. The time scale parameter ϵ obtained by fitting the observed signal to the theoretical one agrees with the value calculated from Eq. (11) to better than $\pm 30\%$. Some of the reasons for the limited agreement are the following: (a) Neither the spatial nor the temporal dependence of the excitation laser pulse is exactly Gaussian, as the theoretical results assumed; (b) The excitation and probe laser beams may not be exactly parallel, and they are also not of infinite lengths with uniform cross sections, so that the theoretical one-dimension treatment is not totally valid.

5. CONCLUSION

We have used a probe beam deflection technique to measure the time-derivative of the pulsed OA signal in a liquid generated by an excitation laser pulse of τ_{FWHM} being 8 nsec or 1.3 μ sec. The observed signals are in reasonable agreement with the theoretical results of Lai and Young¹⁴ and Heritier,¹⁵ which we have shown numerically to be equivalent.¹⁸ We have thus experimentally confirmed (to an accuracy of $\pm 30\%$) that the width of the pulsed OA signal is controlled by the magnitude of τ_e , as given by Eq. (4), or equivalently by the magnitude of ϵ , as given by Eq. (11). Thus, sharp OA pulse is generated by a narrow laser pulse of short duration τ and focussed to a small beam waist w_0 . For example, commercial lasers are readily available with $\tau \approx 0.5$ nsec; if the laser beam is focussed to a waist w_0 of 1 μ m, this would produce an OA signal with a time scale parameter $\epsilon \approx 0.8$ nsec. Since this corresponds to a peak to trough time separation of 1.33 nsec (see Eq. 15), a very sharp acoustic pulse with Fourier frequencies into the GHz regime is produced in the sample. The monitoring of the propagation of such an acoustic pulse in the sample should provide a novel

method of frequency multiplexed measurement of ultrasonic dispersion and attenuations in matter.⁹

ACKNOWLEDGMENTS

We sincerely thank W. Zapka for his help in the earlier phase of this experiment, and H. Coufal for providing us with enlightening ideas and suggestions. The critical reading of this manuscript by G. Bjorklund is greatly appreciated.

TABLE I

Summary of Experimental Parameters for Our Study of OA Pulse Generation
by a N_2 Pumped Dye Laser Beam ($\tau=4.8$ nsec).

Focal length f	Measured beam waist w_0	ϵ according to Eq (11) with measured w_0 and $\tau=4.8$ nsec	ϵ obtained by a best theoretical fit of the observed probe deflection signal
60 (mm)	20 (μm)	13.6 (nsec)	10.6 (nsec)
120	49	32.3	30.1
254	74	47.6	42.9

REFERENCES

1. G. A. Askar'yan, A. M. Prokhorov, G. F. Chanturiya and G. P. Shipulo, *Sov. Phys., JETP* 17, 1463 (1963).
2. E. F. Carome, N. A. Clark and C. E. Moeller, *Appl. Phys. Lett.* 4, 95 (1964).
3. P. M. Rentzepis and Y. H. Pao, *J. Chem. Phys.* 44, 2931 (1966).
4. C. K. N. Patel and A. C. Tam, *Rev. Mod. Phys.* 53, 517 (1981).
5. A. C. Tam, "Photoacoustics: Spectroscopy and Other applications," in *Ultrasensitive Laser Spectroscopy*, Paris, edited by D. Kliger (Academic, New York 1983).
6. W. Zapka and A. C. Tam, *Appl. Phys. Lett.* 40, 310 (1982).
7. G. C. Wetsel, Jr., in *Acoustic Imaging*, Vol. 12, edited by E. A. Ash and C. R. Hill (Plenum, New York, 1982), p. 137.
8. G. C. Wetsel, "Photothermal Excitation of Elastic Waves by 10 ns Laser Pulses and Detection by Photoelastic Laser Beam Deflection," to appear in Proceedings on 3rd International Topical Meeting on Photoacoustic and Photothermal Spectroscopy, Paris, published by *J. de Physique*, Paris (1983).
9. A. C. Tam, W. Zapka, H. Coufal and B. Sullivan, "Optical Probing of Photoacoustic Pulse Propagation for Noncontact Measurements of Flows, Temperatures and Chemical Compositions," to appear in same proceedings as in Ref. 8.
10. R. M. White, *J. Appl. Phys.* 34, 3559 (1963).
11. L. S. Gournay, *J. Acoust. Soc. Am.* 40, 1322 (1966).
12. C. L. Hu, *J. Acoust. Soc. Am.* 46, 728 (1969).
13. L. M. Lyamshev and K. A. Naugol'nykh, *Sov. Phys. Acoust.* 26, 351 (1980).
14. H. M. Lai and K. Young, *J. Acoust. Soc. Am.* 72, 2000 (1982).
15. J. M. Heritier, *Opt. Communic.* 44, 267 (1983).
16. A. Yariv, *Quantum Electronics*, 2nd Edition (J. Wiley & Sons, New York, 1975).

17. M. V. Klein, *Optics* (John Wiley, New York, 1970), Chapter 2.
18. We have been informed in private communication with K. Young of the Chinese University of Hong Kong that it is possible to show directly the mathematical equivalence of the theoretical results of Lai and Young¹⁴ and Heritier.¹⁵

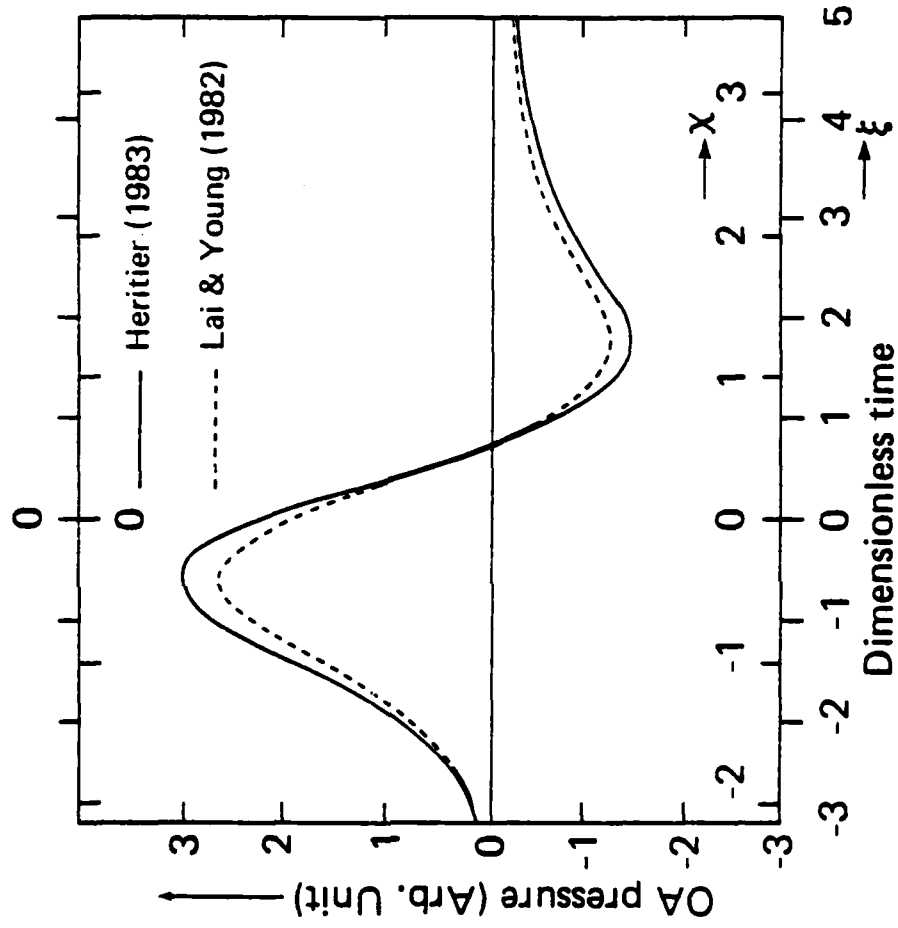

Figure 1. Theoretical OA pressure profiles according to Lai and Young¹⁴ and to Heritier.¹⁵ The amplitudes of the two profiles are made slightly different to show clearly the shape of each.

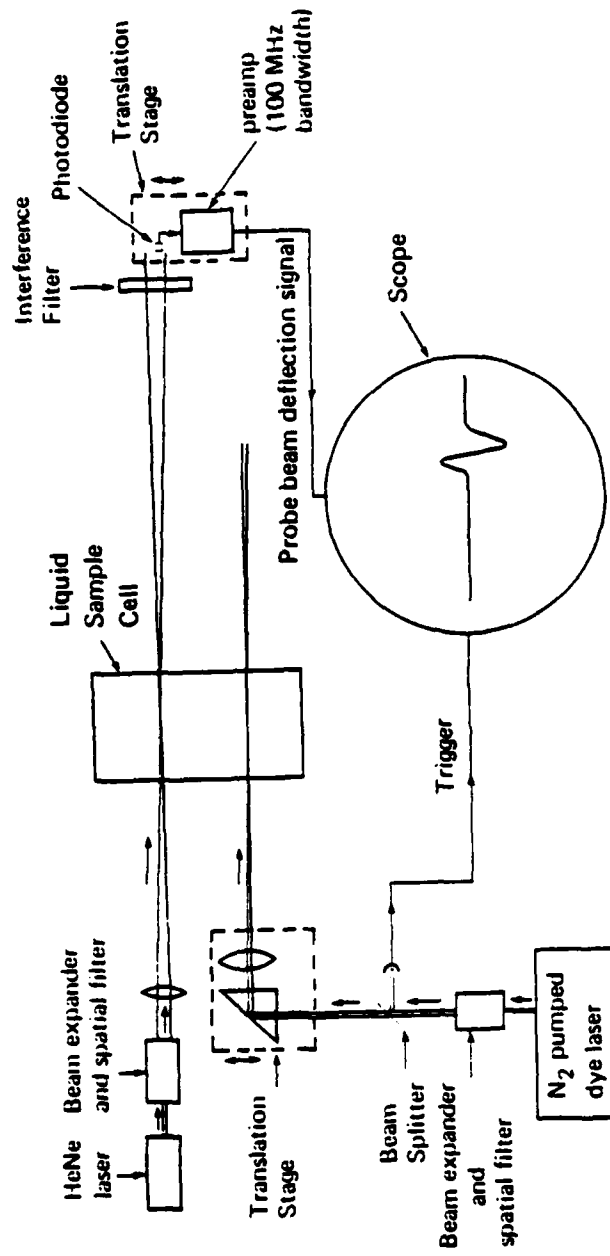
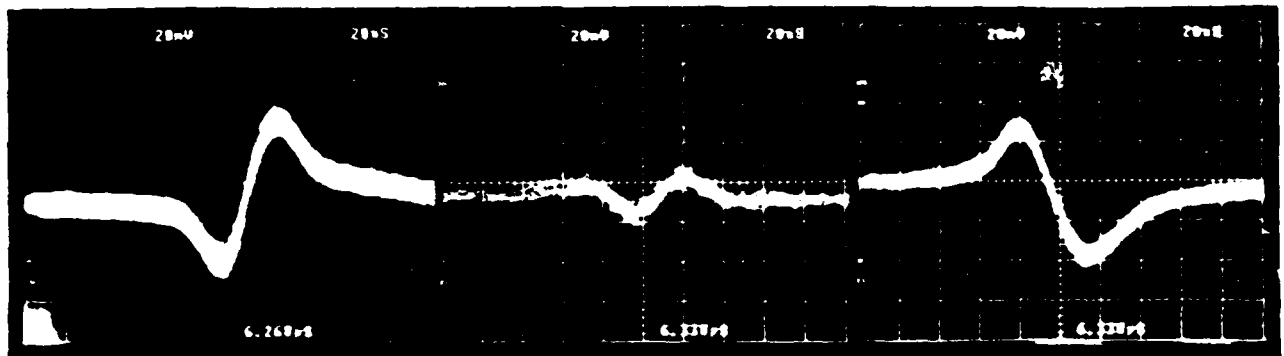
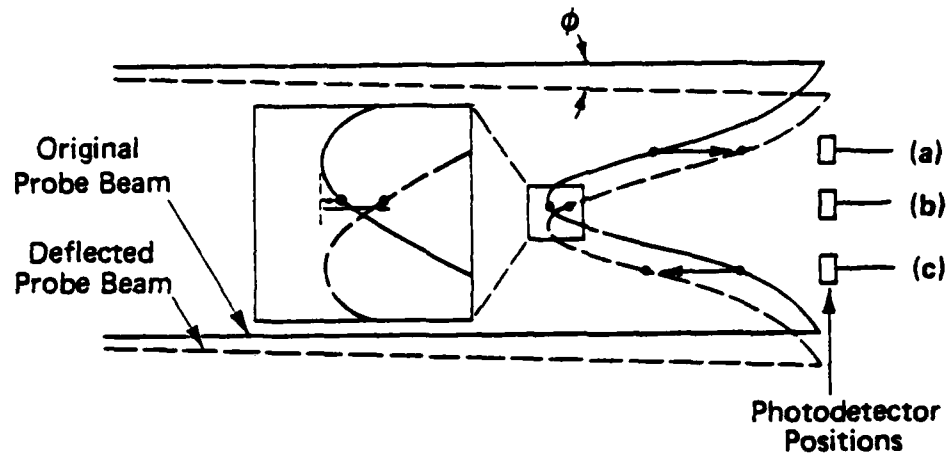

Figure 2. Experimental arrangement to measure the pulsed OA profile in liquids by a probe beam deflection technique.



(a)

(b)

(c)

Figure 3. Observed probe beam deflection signal depends on the position of the small photodiode in the probe beam cross section. This is shown in the observed signals shown in the scope photos for the photodiode being on one wing, on center and on the other wing of the probe beam cross section, respectively. The inset explains how a deflection ϕ of the probe beam produces different photodiode signals for the different cases.

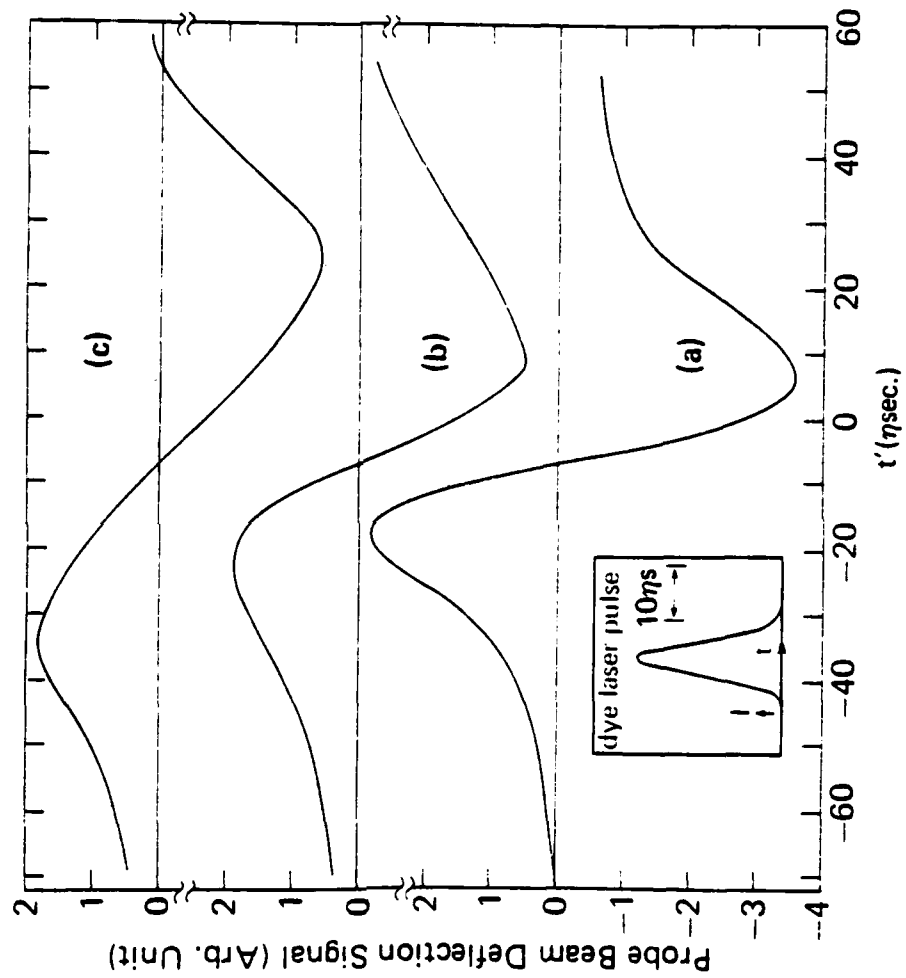

Figure 4. Observed probe beam deflection signals excited by various focussing of the N_2 pumped dye laser. The focal lengths f used are (a) 60 mm, (b) 120 mm and (c) 254 mm. The inset shows the temporal profile of the excitation laser pulse.

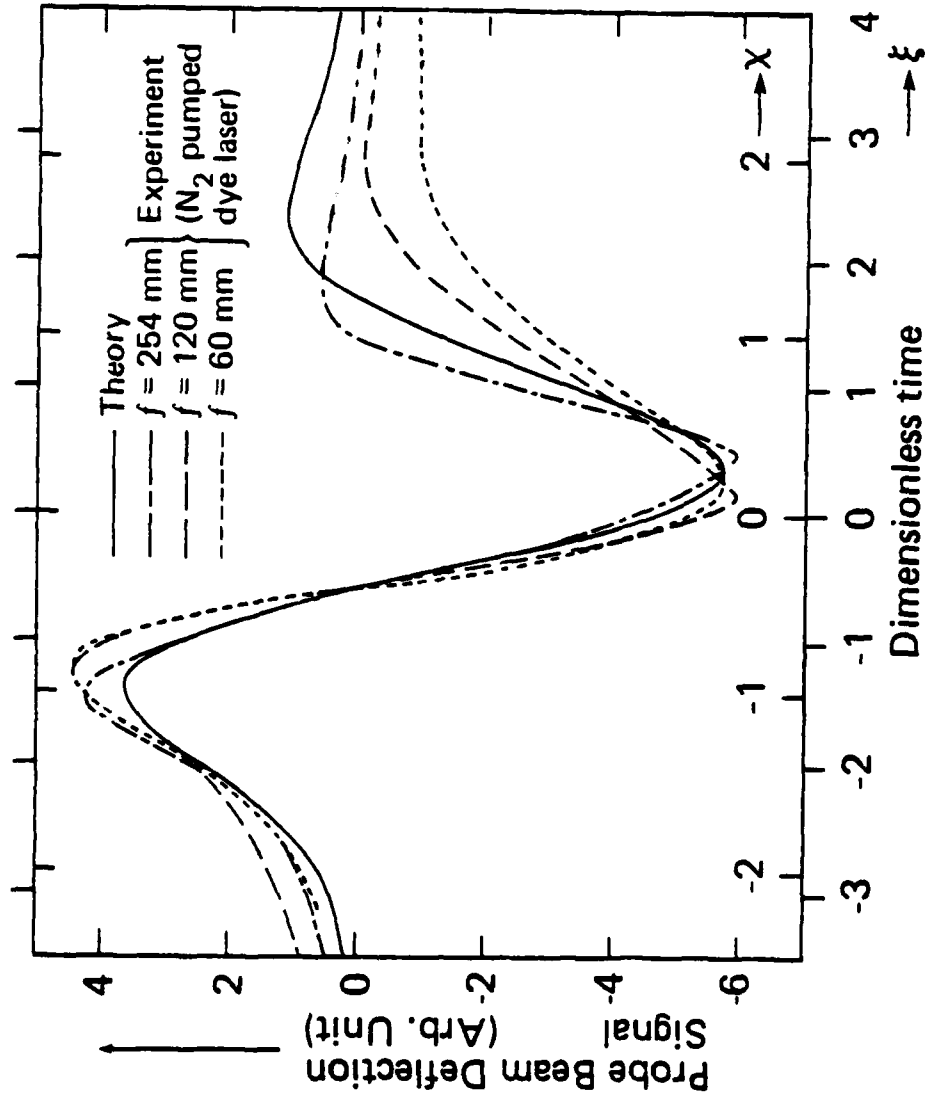

Figure 5. Comparison of theoretical probe beam deflection signal with the observed signals of Fig. 4 plotted against the dimensionless time x , with ϵ used being 10.6, 30.1 and 42.9 nsec for (a), (b) and (c), respectively.

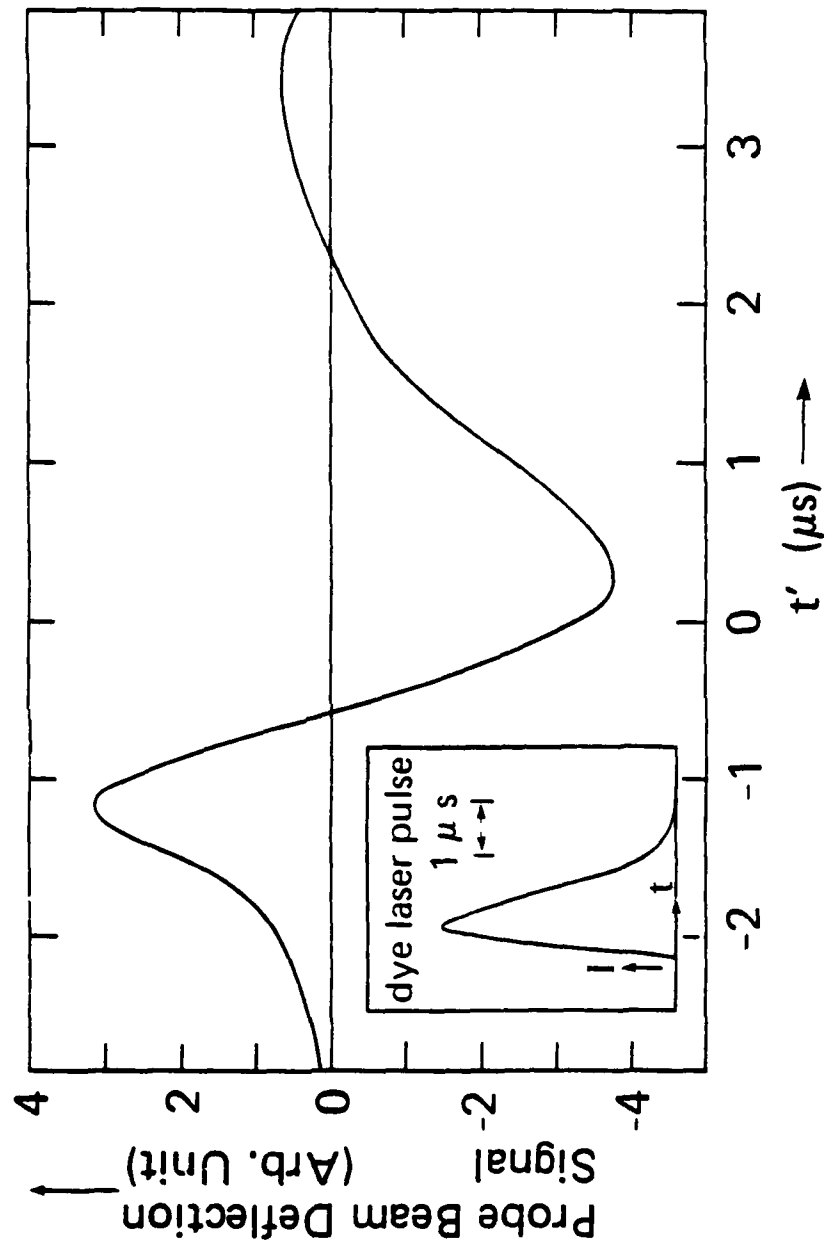

Figure 6. Observed probe beam deflection signal for excitation by the flashlamp pumped dye laser. The inset shows the temporal profile of the excitation laser pulse.

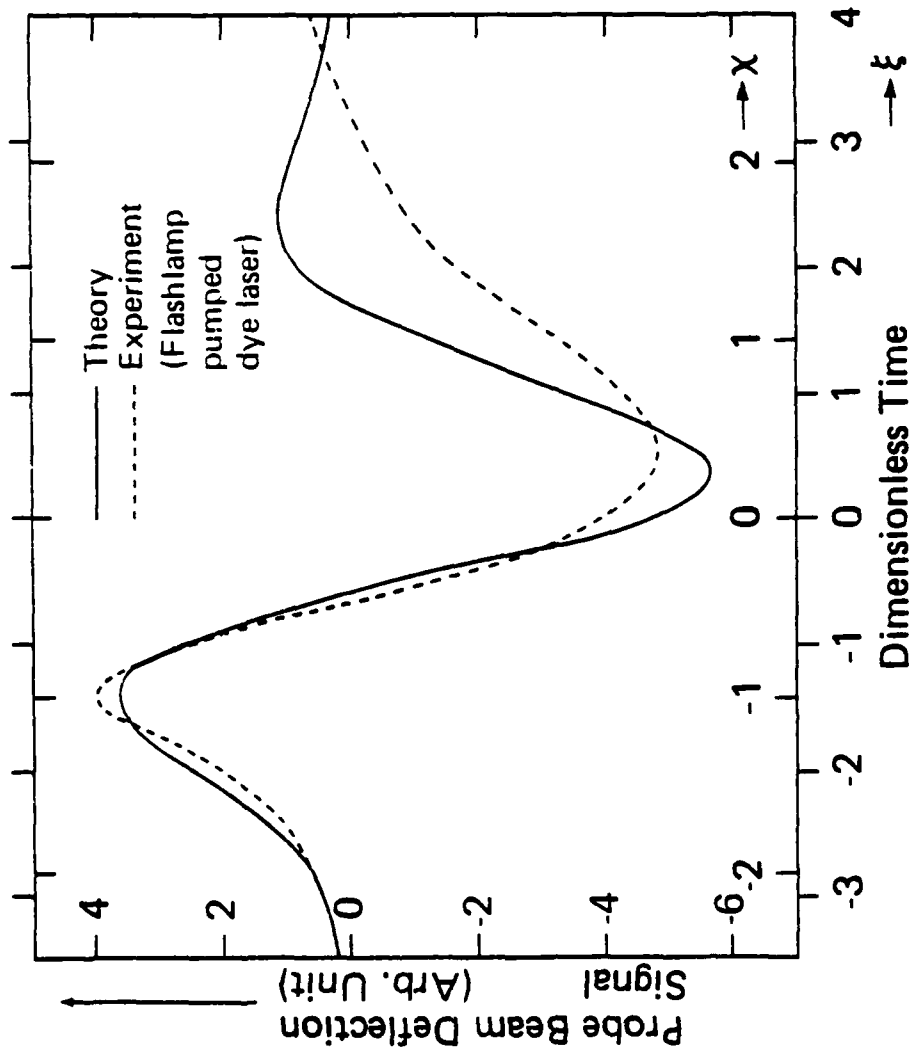

Figure 7. Comparison of theoretical probe beam deflection signal with the observed signal of Fig. 6 plotted against the dimensionless time ξ , with ϵ used being 1.05 μ sec.