PROGRAML: A Graph-based Program Representation for Data Flow Analysis and Compiler Optimizations

Chris Cummins^{*1} Zacharias V. Fisches^{*2} Tal Ben-Nun² Torsten Hoefer² Michael O’Boyle³ Hugh Leather¹

Abstract

Machine learning (ML) is increasingly seen as a viable approach for building compiler optimization heuristics, but many ML methods cannot replicate even the simplest of the data flow analyses that are critical to making good optimization decisions. We posit that if ML cannot do that, then it is insufficiently able to reason about programs. We formulate data flow analyses as supervised learning tasks and introduce a large open dataset of programs and their corresponding labels from several analyses. We use this dataset to benchmark ML methods and show that they struggle on these fundamental program reasoning tasks. We propose PROGRAML – *Program Graphs for Machine Learning* – a language-independent, portable representation of program semantics. PROGRAML overcomes the limitations of prior works and yields improved performance on downstream optimization tasks.

1. Introduction

Compiler implementation is a complex and expensive activity (Cooper & Torczon, 2012). For this reason, there has been significant interest in using machine learning to automate various compiler tasks (Allamanis et al., 2018). Most works have restricted their attention to selecting compiler heuristics or making optimization decisions (Leather & Cummins, 2020). Whether learned or engineered by human experts, these decisions naturally require reasoning about the program and its behavior. Human experts most often rely upon *data flow* analyses (Kildall, 1973; Kam & Ullman, 1976). These are algorithms on abstract interpretations of the program, propagating information of interest through the program’s control-flow graph until a fixed point is reached (Kam & Ullman, 1977). Two examples out of

^{*}Equal contribution ¹Facebook AI Research, USA ²ETH Zürich, Switzerland ³University of Edinburgh, United Kingdom. Correspondence to: Chris Cummins <cummins@fb.com>.

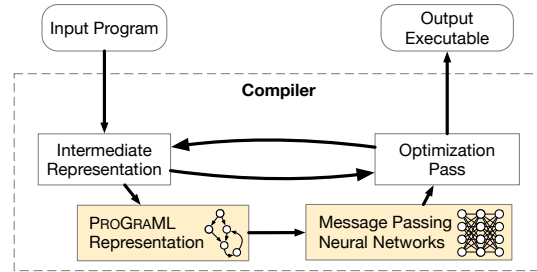

Figure 1: Our proposed approach for compiler analyses driven by graph-based deep learning.

many data flow analyses are: *liveness* – determining when resources become dead (unused) and may be reclaimed; and *available expressions* – discovering which expressions have been computed on all paths to points in the program. Prior machine learning works, on the other hand, have typically represented the entirety of the program’s behavior as a fixed-length, statically computed feature vector (Ashouri et al., 2018). Typical feature values might be the number of instructions in a loop or the dependency depth. The demonstrable weakness of these techniques is that they are trivially confused by the addition of dead code, which changes their feature vectors without changing the program’s behavior or its response to optimizations. Such learning algorithms are unable to learn their own abstract interpretations of the program and so cannot avoid these pitfalls or more subtle versions thereof (Barchi et al., 2019).

Recently, there have been attempts to develop representations that allow finer-grain program reasoning. Many, however, are limited both by how inputs are represented as well as how inputs are processed. Representations based on source code and its direct artifacts (e.g., AST) (Alon et al., 2018a; Yin et al., 2018; Haj-Ali et al., 2020; Cummins et al., 2017b) put unnecessary emphasis on naming and stylistic choices that may not correlate with the functionality of the code (e.g., Fig. 2a). Approaches based on intermediate representations (IR) (Ben-Nun et al., 2018; Mirhoseini et al., 2017; Brauckmann et al., 2020) remove such noise but fail to capture information about the program that is important for analysis (e.g., Fig. 2b variables, Fig. 2c commutativity). In both cases, models are expected

to reason about the flow of information in programs using representations that do not directly encode this information. Clearly, a program representation is needed that enables machine learning algorithms to reason about the execution of a program by developing its own data flow analyses.

Since current approaches are ill-suited to program-wide data flow analysis, we propose overcoming some of their limitations by making the program’s control, data, and call dependencies a central part of the program’s representation *and* a primary consideration when processing it. We achieve this by seeing the program as a graph in which individual statements are connected to other statements through relational dependencies. Each statement in the program is understood only in the context of the statements interacting with it. Through relational reasoning (Battaglia et al., 2018), a latent representation of each statement is learned that is a function of not just the statement itself, but also of the (latent) representations of its graph neighborhood. Notably, this formulation has a striking similarity to the IRs used by compilers, and the iterative propagation of information resembles the *transfer functions* and *meet operators* in traditional data flow analyses (Kildall, 1973).

Recently proposed techniques for learning over graphs have shown promise in a number of domains (Ziwei et al., 2020). With a suitable representation and graph-based model, we extend these approaches to the domain of compiler analysis, enabling downstream tasks built on top of such graph models to natively incorporate reasoning about data flow into their decision making. This improves performance on downstream tasks without requiring additional features, although challenges with respect to generalization to large programs at test-time remain and are discussed in detail. Figure 1 illustrates our approach. We make the following contributions:

- We propose a portable, language-independent graph representation of programs derived from compiler IRs. PROGRAML¹ simultaneously captures whole-program control-, data-, and call relations between instructions and operands as well as their order and data types. PROGRAML is a compiler-agnostic design for use at all points in the optimization pipeline; we provide implementations for LLVM and XLA IRs.
- We introduce a benchmark dataset that poses a suite of established compiler analysis tasks as supervised machine learning problems. DEEPDATAFLOW (Cummins, 2020b) comprises five tasks that require, in combination, the ability to model: control- and data-flow, function boundaries, instruction types, and the type and order of operands over complex programs. DEEPDATAFLOW is constructed from 461k

real-world program IRs covering a diverse range of domains and source languages, totaling 8.5 billion data flow analysis classification labels.

- We adapt Gated-Graph Neural Networks (GGNN) to the PROGRAML representation. We show that, within a bounded problem size, our approach achieves ≥ 0.939 F₁ score on all analysis tasks, a significant improvement over state-of-the-art representations. We set a new state-of-the-art on two downstream optimization tasks for which data flow analyses are important.

2. Related Work

Data flow analysis is a long established area of work firmly embedded in modern compilers. Despite its central role, there has been limited work in learning such analysis. Bielik et al. (2017) use ASTs and code synthesis to learn rule-sets for static analyses, some of which are dataflow-related. Our approach does not require a program generator or a hand-crafted DSL for rules. Shi et al. (2020) and Wang & Su (2020) use dynamic information (e.g., register snapshots and traces) from instrumented binaries to embed an assembler graph representation. We propose a static approach that does not need runtime features. Si et al. (2018) use a graph embedding of an SSA form to generate invariants. The lack of phi nodes and function call/return edges means that the representation is not suitable for interprocedural analysis as it stands. Kanade et al. (2020) explore a large-scale, context-dependent vector embedding. This is done at a token level, however, and is unsuited for dataflow analysis.

Prior work on learning over programs employed methods from Natural Language Processing that represented programs as a sequence of lexical tokens (Allamanis, 2016; Cummins, 2020a). However, source-level representations are not suited for analyzing partially optimized compiler IRs as the input source cannot be recovered. In program analysis it is critical to capture the structured nature of programs (Raychev et al., 2015; Allamanis et al., 2017; Alon et al., 2018b). Thus, syntactic (tree-based) as well as semantic (graph-based) representations have been proposed (Allamanis et al., 2018; Brauckmann et al., 2020). Dam et al. (2018) annotate nodes in Abstract Syntax Trees (ASTs) with type information and employ Tree-Based LSTMs (Tai et al., 2015) for program defect prediction. Both Raychev et al. (2015) and Alon et al. (2018a;b) use path-based abstractions of the AST as program representations, while Allamanis et al. (2017) augment ASTs with a hand-crafted set of additional typed edges and use GGNNs (Li et al., 2015) to learn downstream tasks related to variable naming. Another line of research considers modelling binary similarity via control-flow graphs (CFGs)

¹<https://github.com/ChrisCummins/ProGraML>

```

int f(int n) {
  if (n == 0) return 1;
  else return n * f(n-1);
}

int f(int x) {
  if (x == 0) return 1;
  else return n * f(x-1);
}

int fibonacci(int n) {
  if (n == 0) return 1;
  else return n * fibonacci(n-1);
}

```

factorial	50.93%
testRun	19.15%
Iter	8.92%
sinc	77.78%
times	3.89%
isPowerOfTwo	3.36%
factorial	99.09%
testRun	0.75%
Iter	0.07%

(a) code2vec is sensitive to naming over semantics.

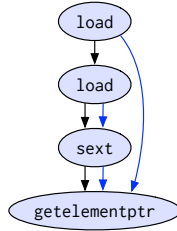

(b) CDFG omits operands.

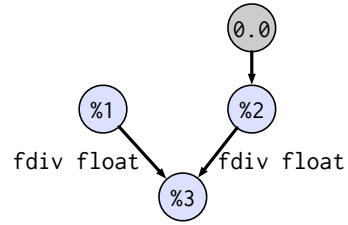

(c) XFG cannot distinguish non-commutative statements.

Figure 2: Limitations in state-of-the-art learnable code representations: code2vec (Alon et al., 2018a), CDFG (Brauckmann et al., 2020), and XFG (Ben-Nun et al., 2018).

with an adaptation of GNNs called Graph Matching Networks (Li et al., 2019).

The history of IR-based graph representations for optimization goes back to Ferrante et al. (1987), who remove superfluous control-flow edges to ease optimization with a compact graph representation. A more contemporary precursor to our approach is the ConteXtual Flow Graph (XFG) (Ben-Nun et al., 2018), which combines control-flow with data-flow relations in order to learn unsupervised embeddings of LLVM-IR statements. XFGs omit information that is critical to analysis including the notion of argument order, vertices for both variables and constants, and all control-flow edges. PROGRAMML, in combining call-graphs (CG), control-flow graphs, and data-flow graphs (DFG), offers an IR-level program representation that is designed to be useful for a variety of purposes from specific program analyses to downstream optimization tasks. Steiner et al. (2021) propose a representation based on data flow graphs where each node uses a hand crafted feature representation. The graphs are then serialized and processed using LSTMs. Control and Data Flow Graphs (CDFG) (Brauckmann et al., 2020) use graph vertices for statements and have bi-directional edges for control and data dependencies. The CDFG uses only the instruction opcode to represent a statement, omitting operands, variables, data types, and constants. This prohibits the reasoning about variables and expressions that are required for many data flow analyses, including 3 out of the 5 benchmark tasks that we establish below. Mendis et al. (2019) represent LLVM-IR using a graph that is specialized to a vectorization task. They use unique edge types to differentiate the first five operand positions and augment the graph structure with vectorization opportunities that they compute a priori. Our approach is not specialized to a task, enabling such opportunities learned (e.g., subexpression detection), and uses an embedding weighting to differentiate edge positions without having to learn separate edge transfer weights for each. Finally, an alternate approach is taken by IR2Vec (Keerthy S et al., 2019), an LLVM-IR-specific representation that elegantly models

part-of-statements as relations. However, in order to compute the values of the embeddings, IR2Vec requires access to the type of data flow analyses that our approach learns from data alone.

3. A Graphical Program Representation

This section presents PROGRAMML, a novel IR-based program representation that closely matches the data structures used traditionally in inter-procedural data flow analysis and can be processed natively by deep learning models. We represent programs as directed multigraphs where instructions, variables, and constants are vertices, and relations between vertices are edges. Edges are typed to differentiate control-, data-, and call-flow. Additionally, we augment edges with a local position attribute to encode the order of operands to instructions, and to differentiate between divergent branches in control-flow.

We construct a PROGRAMML graph $G = (V, E)$ by traversing a compiler IR. An initially empty graph $G = \emptyset$ is populated in three stages: control-flow, data-flow, and call-flow, shown in Figure 3. In practice the three stages of graph construction can be combined in a single $\mathcal{O}(|V| + |E|)$ pass.

(I) Control Flow We construct the full-flow graph of an IR by inserting a vertex for each instruction and connecting control-flow edges (Fig. 3a, 3b). Control edges are augmented with numeric positions using an ascending sequence based on their order in an instruction’s successors.

(II) Data Flow We introduce constant values and variables as graph vertices (Fig. 3c). Data-flow edges are inserted to capture the relation from constants and variables to the instructions that use them as operands, and from instructions to produced variables. As each unique variable and constant is a vertex, variables can be distinguished by their scope, and unlike the source-level representations of prior works, variables in different scopes map to distinct vertices and can thus be discerned. Data edges have a po-

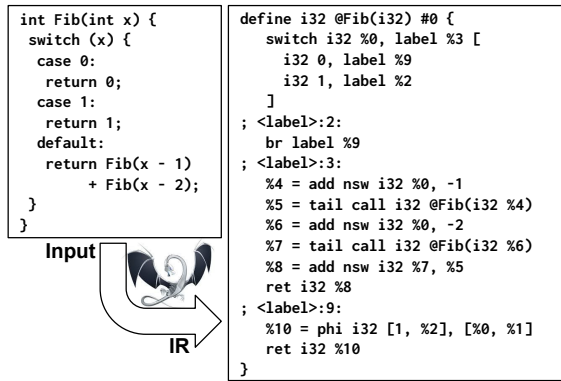

(a) The input program is passed through the compiler front-end to produce an IR. In this example, LLVM-IR is used.

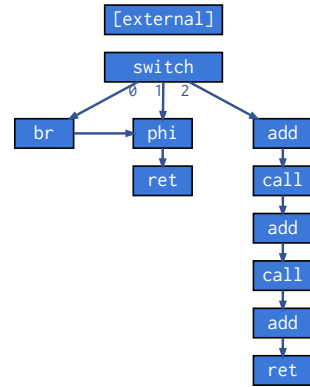

(b) A full-flow graph is constructed of instructions and control dependencies. All edges have position attributes; for clarity, we have omitted position labels where not required.

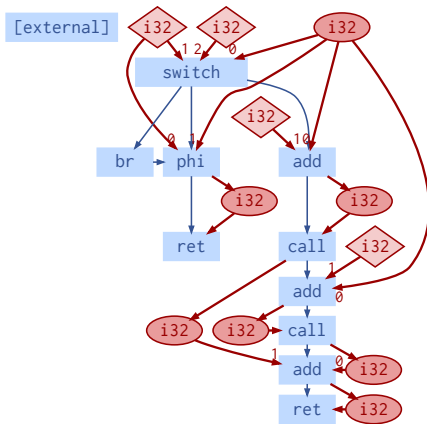

(c) Vertices are added for data elements (elliptical nodes are variables, diamonds are constants). Data edges capture use/def relations. *i32* indicates 32 bit signed integers. Numbers on edges indicate operand positions.

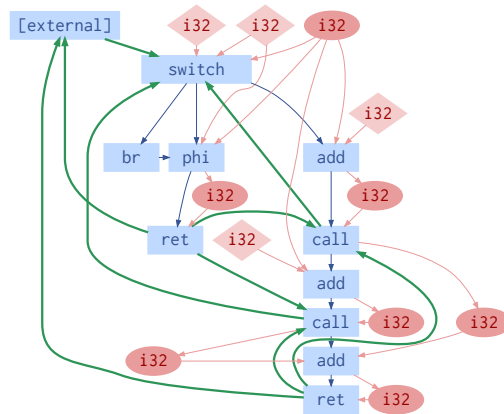

(d) Functions have a single entry instruction and zero or more exit instructions. Call edges are inserted from call sites to function entry instructions, and return-edges from function exits to call sites.

Figure 3: PROGRAML construction from a Fibonacci sequence implementation using LLVM-IR.

sition attribute that encodes the order of operands for instructions. The latent representation of a statement (e.g., `%1 = add i32 %0, 1`) is thus a function of the vertex representing the instruction and the vertices of any operand variables or constants, modulated by their order in the list of operands.

(III) Call Flow Call edges capture the relation between an instruction that calls a function and the entry instruction of the called function (Fig. 3d). Return call edges are added from each of the terminal instructions of a function to the calling statement. Control edges do not span functions, such that an IR with functions F produces $|F|$ disconnected subgraphs (the same is not true for data edges which may cross function boundaries, e.g., in the case of a global constant which is used across many parts of a program). For IRs that support external linkage, an additional vertex is created representing an external call site and connected to all externally visible functions. If a call site ref-

erences a function not defined in the current IR, a *dummy* function is created consisting of a single instruction vertex and connected through call edges to all call sites in the current IR. A unique dummy function is created for each externally defined function.

4. Graph-based Machine Learning for Program Analysis

We formulate our system in a Message Passing Neural Network (MPNN) framework (Gilmer et al., 2017). Our design mimics the *transfer functions* and *meet operators* of classical iterative data flow analysis (Kam & Ullman, 1977; Cooper et al., 2004), replacing the rule-based implementations with learnable analogues (message and update functions). This single unified model can be specialized through training to solve a diverse set of problems without human intervention or algorithm design.

The PROGRAML model is an adaptation of GGNN (Li et al., 2015) that takes as input an attributed directed multi-graph as presented in Section 3. It consists of three logical phases: input encoding, message propagation and update, and result readout.

(I) Input Encoding Starting from the augmented graph representation $G = (V, E)$, we capture the semantics of the program graph vertices by mapping every instruction, constant, and variable vertex $v \in V$ to a vector representation $h_v^0 \in \mathbb{R}^d$ by lookup in a fixed-size learnable embedding table. The mapping from vertex to embedding vector $f : v \mapsto h_v^0$ must be defined for each IR.

For LLVM-IR, we construct an embedding key from each vertex using the name of the instruction, e.g., `store`, and the data type for variables and constants, e.g., `i32*` (a pointer to a 32-bit integer). In this manner, we derive the set of unique embedding keys using the graph vertices of a training set of LLVM-IRs described in Section 5.1. This defines the embedding table used for training and deployment. An *unknown element* embedding is used during deployment to map embedding keys which were not observed in the training data. Since composite types make the size of the vocabulary unbounded in principle, our data-driven approach trades a certain amount of semantic resolution against good coverage of the vocabulary by the available datasets (cf. Table 1). The embedding vectors are trained jointly with the rest of the model.

(II) Message Propagation Each iteration step is divided into a message propagation followed by vertex state update. Receiving messages $M(h_w^{t-1}, e_{wv})$ are a function of neighboring states and the respective edge. Messages are mean-aggregated over the neighborhood after transformation with a custom position-augmented transfer function that scales h_w elementwise with a position-gating vector $p(e_{wv})$:

$$M(h_w^{t-1}, e_{wv}) = W_{\text{type}(e_{wv})} \left(h_w^{t-1} \odot p(e_{wv}) \right) + b_{\text{type}(e_{wv})}$$

The position-gating $p(e_{wv}) = 2\sigma(W_p \text{emb}(e_{wv}) + b_p)$ is implemented as a sigmoid-activated linear layer mapping from a constant sinusoidal position embedding (Vaswani et al., 2017; Gehring et al., 2017). It enables the network to distinguish non-commutative operations such as division, and the branch type in diverging control-flow. In order to allow for reverse-propagation of information, which is necessary for backward compiler analyses, we add backward edges for each edge in the graph as separate edge-types. In all our experiments, we employ Gated Recurrent Units (GRU) (Cho et al., 2014) as our update function.

Step (II) is iterated T times to extract vertex representations that are contextualized with respect to the graph structure.

(III) Result Readout Data flow analyses compute value sets composed of instructions or variables. We support per-instruction and per-variable classification tasks using a *readout head* on top of the iterated feature extraction, mapping, for each vertex, the extracted vertex features h_v^T to probabilities $R_v(h_v^T, h_v^0)$:

$$R_v(h_v^T, h_v^0) = \sigma(f(h_v^T, h_v^0)) \cdot g(h_v^T)$$

where $f(\cdot)$ and $g(\cdot)$ are linear layers and $\sigma(\cdot)$ is the sigmoid activation function. Allowing the readout head to access the initial node state h_v^0 in its gating function $\sigma(f(\cdot))$ acts as a skip connection from the input embedding to the readout.

5. Data Flow Experiments

Data flow analysis is at the heart of modern compiler technology. We pose a suite of data flow analyses as supervised learning tasks to benchmark the representational power of machine learning approaches. We selected a diverse set of tasks that capture a mixture of both forward and backward analyses, and control-, data-, and procedure-sensitive analyses. *Full details of the analyses are provided in Appendix A.* These particular data flow analyses can already be perfectly solved by non-ML techniques. Here, we use them to benchmark the capabilities of machine learning techniques.

5.1. The DEEPDATAFLOW Dataset

We assembled a 256M-line corpus of LLVM-IR files from a variety of sources and produced labeled datasets using five traditional data flow analyses: control reachability, dominators, data dependencies, liveness, and subexpressions (Cummins, 2020b). Each of the 15.4M analysis examples consists of an input graph in which a single vertex is annotated as the root node for analysis, and an output graph in which each vertex is annotated with a binary label corresponding to its value once the data flow analysis has completed (Fig. 4). A 3:1:1 ratio is used to divide the examples for the five problems into training, validation, and test instances. When formulated as supervised learning tasks, data flow analyses exhibit a strong class imbalance. A trivial baseline is to always predict *true*, which achieves an F_1 of 0.073. *For further details see Appendix B.*

5.2. Models

We evaluate the effectiveness of our approach against two contrasting state-of-the-art approaches for learning over programs: one sequential model and one other graph model.

(I) Sequential Model *inst2vec* (Ben-Nun et al., 2018) sequentially processes the IR statements of a program to perform whole-program classification. An IR is tokenized

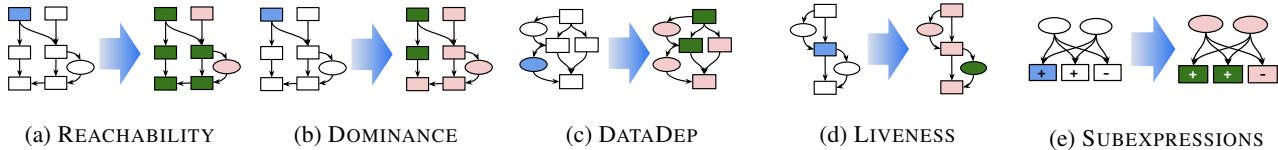

Figure 4: Example input-output graphs for each of the five DEEPDATAFLOW tasks. A single vertex is randomly selected from the input graph as the starting point for computing analysis results, indicated using the *vertex selector* (blue node). Each vertex in the output graph is annotated with a binary value after the analysis has completed. As a supervised classification task, the goal is to predict the output vertex labels given an input graph. These small graphs are for illustrative purposes, the average DEEPDATAFLOW graph contains 581 vertices and 1,051 edges.

and then mapped into a sequence of pre-trained 200 dimensional embedding vectors which are processed by an LSTM. The final state of the LSTM is fed through a two-layer fully connected neural network to produce a classification of the full sequence. We extend this approach by concatenating to the input sequence a one-hot *token-selector* to indicate the starting point for analysis. Then, we feed the LSTM state through a fully connected layer after every token, producing a prediction for each instruction of the IR. We use the same model parameters as in the original work.

(II) Graph Models We use the model design outlined in Section 4 with two input representations: CDFG (Brauckmann et al., 2020), and PROGRAMML. For both approaches we use 32 dimensional embeddings initialized randomly, as in Brauckmann et al. (2020). Input *vertex-selectors*, encoded as binary one-hot vectors, are used to mark the starting point for analyses and are concatenated to the initial embeddings. For CDFG, we use the vocabulary described in Brauckmann et al. (2020). For PROGRAMML, we derive the vocabulary from the training set.

Message Passing Neural Networks typically use a small number of propagation steps out of practical consideration for time and space efficiency (Gilmer et al., 2017; Brauckmann et al., 2020). In contrast, data flow analyses iterate until a fixed point is reached. In this work we iterate for a fixed number T of message passing steps and exclude from the training and validation sets graphs for which a traditional implementation of the analysis task requires greater than T iterations to solve. We set $T = 30$ for training in all experiments and trained a model per task. Once trained, we evaluate model inference using different T values to accommodate programs which required a greater number of steps to compute the ground truth. See Appendix C.2. for training details.

5.3. Evaluation

First, we evaluate the effectiveness of each vocabulary at representing unseen programs. Then we evaluate model

performance on increasingly large subsets of the DEEPDATAFLOW (DDF) test sets.

Vocabulary Coverage Each of the three approaches uses a vocabulary to produce embeddings that describe the instructions and operands of a program. *inst2vec* uses a vocabulary of 8,565 LLVM-IR statements (where a statement is an instruction and its operands) with identifiers and literals stripped. CDFG uses the 75 LLVM instruction opcodes. For PROGRAMML we derive a vocabulary on a set of training graphs that represents instructions and data types separately. Table 1 compares the coverage of these vocabularies as a percentage of the vertices in the test graphs that can be described using that vocabulary. PROGRAMML provides $2.1\times$ the coverage on unseen programs as state-of-the-art approaches, the best of which can represent fewer than half of the graph vertices of unseen programs.

DDF-30: Testing on Limited Problem Size We initially limit our testing to the subset of each task’s test set which can be solved using a traditional analysis implementation in ≤ 30 steps, denoted DDF-30. This matches the $T = 30$ message passing iterations used in computing the graph models’ final states to ensure that a learned model, if it has successfully approximated the mechanism of an analysis, has sufficient message passing iterations to solve each test input. Table 2 summarizes the performance of *inst2vec*, CDFG, and PROGRAMML.

The relational representation of our approach shows excellent performance across all of the tasks. CDFG, which also captures control-flow, achieves comparable performance on the REACHABILITY and DOMINANCE tasks. However, the lack of operand vertices, positional edges, and data types renders poor performance on the SUBEXPRESSIONS task. Neither CDFG nor *inst2vec* representations enable per-variable classification, so are incapable of the DATADEP and LIVENESS tasks. To simplify comparison, we exclude these two tasks from *inst2vec* and CDFG aggregate scores. In spite of this, PROGRAMML correctly labels $4.50\times$ and $1.12\times$ more vertices than the state-of-the-art approaches. The weakest PROGRAMML performance is on the

	Vocabulary Size	Vocabulary Test Coverage
inst2vec	8,565	34.0%
CDFG	75	47.5%
PROGRAML	2,230	98.3%

Table 1: Vocabularies for LLVM-IR.

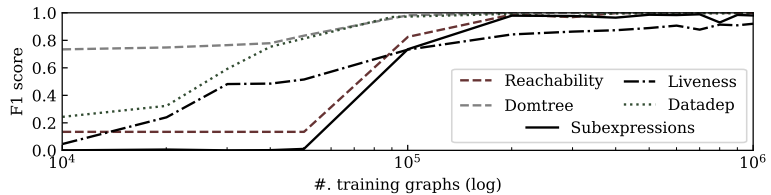
 Figure 5: F_1 score on a 10k-graph validation set as a function of the number of training graphs.

Analysis	Example Optimization		inst2vec	CDFG	PROGRAML		
			DDF-30	DDF-30	DDF-30	DDF-60	DDF
Reachability	Dead Code Elimination	Precision	0.105	1.000	0.998	0.997	0.996
		Recall	0.007	0.996	0.998	0.998	0.917
		F_1	0.012	0.998	0.998	0.997	0.943
Dominance	Global Code Motion	Precision	0.053	0.999	1.000	0.983	0.066
		Recall	0.002	1.000	1.000	1.000	0.950
		F_1	0.004	0.999	1.000	0.991	0.123
DataDep	Instruction Scheduling	Precision	—	—	0.998	0.992	0.987
		Recall	—	—	0.997	0.996	0.949
		F_1	—	—	0.997	0.993	0.965
Liveness	Register Allocation	Precision	—	—	0.962	0.931	0.476
		Recall	—	—	0.916	0.955	0.925
		F_1	—	—	0.937	0.939	0.625
Subexpressions	Global Common Subexpression Elimination	Precision	0.000	0.139	0.997	0.954	0.938
		Recall	0.000	0.005	0.996	0.999	0.992
		F_1	0.000	0.009	0.996	0.967	0.959

Table 2: Data flow analysis results. For the restricted subset DDF-30 PROGRAML obtains strong results. Results on the full dataset (DDF) highlight the scalability challenges of MPNNs.

LIVENESS task. When model performance is considered as a function of the number of training graphs, shown in Figure 5, we see that the performance of PROGRAML quickly converges towards near-perfect F_1 scores on a holdout validation set for all tasks except LIVENESS, where the model is still improving at the end of training. This suggests estimating the *transfer* (message) and *meet* (update) operators of this backwards analysis poses a greater challenge for the network, and may benefit from further training.

DDF-60: Generalizing to Larger Problems The DDF-30 set excludes 28.7% of DEEPDATAFLOW graphs which require more than 30 steps to compute ground truth labels. To test whether these learned models can generalize to solve larger problems, we used the models we trained at $T = 30$ but double the number of inference message passing steps to $T = 60$ and repeated the tests on all graphs which require ≤ 60 analysis steps (excluding 19.6%). The results of this experiment, denoted DDF-60, are shown in Table 2. We observe that performance is consistent on this larger problem set, demonstrating that PROGRAML models can generalize to problems larger than those they were trained on. The results indicate that an approximate fixed-

point algorithm is learned by the model, a critical feature for enabling practical machine learning over programs.

DDF: Scalability Challenges Finally, we test the analysis models that were trained for $T = 30$ message passing iterations on all DEEPDATAFLOW graphs, shown in Table 2 as DDF. We use $T = 200$ inference message passing iterations to test the limits of stability and generalization of current graph neural networks, irrespective of the number of steps required to compute ground truth labels, whereas 9.6% of DDF graphs require more than 200 steps to compute. Therefore, this experiment highlights two of the challenges in the formulation of data flow analysis in an MPNN framework: first, that using a fixed number of message passing iterations across each and every edge leads to unnecessary work for problems that can be solved in fewer iterations or by propagating only along a dynamic subset of the edges at each timestep (the maximum number of steps required by a graph in DDF is 28,727). Secondly, models that compute correct results for a graph when processed for an appropriate number of steps may prove unstable when processed for an excessively large number of steps. In Table 2 we see substantial degradations of model perfor-

mance in line with these two challenges. DOMINANCE and LIVENESS show reductions in precision as the models over-approximate and have a large number of false positives. REACHABILITY and DATADEP, in contrast, show drops in recall as the fixed $T = 200$ iterations is insufficient to propagate the signal to the edges of large problems.

MPNNs do not scale in the way that we should like for large programs. A part of this, we believe, is that using a generic MPNN system is wasteful. Ordinary data flow engines process nodes in a particular order (usually reverse post order) and are naturally able to identify that a fixed point has been reached. We believe that *dynamically-sparse* message passing strategies and an adaptive number of iterations could address these scalability challenges, which we will pursue in future work.

6. Downstream Tasks

In the previous section we focus on data flow analysis as a benchmark for the capabilities of machine learning for compiler analysis. For the analyses considered, non-ML techniques achieve perfect scores. In this section we apply PROGRAML to two downstream data flow tasks for which non-ML techniques fail: predicting heterogeneous compute device mappings and algorithm classification. In both domains PROGRAML outperforms prior graph-based and sequence-based representations, reducing test error by $1.20\times$ and $1.35\times$, respectively. Finally, we ablate every component of our representation and summarize the contribution of each.

6.1. Heterogeneous Device Mapping

We apply our methodology to the challenging domain of heterogeneous compute device mapping. Given an OpenCL kernel and a choice of two devices to run it on (CPU or GPU), the task is to predict the device which will provide the best performance. This problem has received significant prior attention, with previous approaches using both hand-engineered features (Grewe et al., 2013) and sequential models (Ben-Nun et al., 2018; Cummins et al., 2017a). We use the OPENCL DEVMAP dataset (Cummins et al., 2017a), which provides 680 labeled CPU/GPU instances derived from 256 OpenCL kernels sourced from seven benchmark suites on two combinations of CPU/GPU hardware, AMD and NVIDIA. *cf. Appendix D.1. in supplementary materials for details.*

The performance of PROGRAML and baseline models is shown in Table 3. As can be seen, PROGRAML outperforms prior works. We set new state-of-the-art F_1 scores of 0.88 and 0.80.

	AMD Error [%]	NVIDIA Error [%]
Static Mapping	41.2	43.1
DeepTune	28.1	39.0
DeepTune _{IR}	26.2	31.6
inst2vec	19.7	21.5
PROGRAML	13.4	20.0

Table 3: Predicting heterogeneous compute device mapping.

	Error [%]	Relative [%]
TBCNN	6.00	+77.5
NCC	5.17	+53.0
XFG w. inst2vec vocab	4.56	+34.9
XFG	4.29	+26.9
PROGRAML	3.38	-

(a) Comparison to state-of-the-art.

	Error [%]	Relative [%]
No vocab	3.70	+9.5
inst2vec vocab	3.78	+11.8
No control edges	3.88	+14.8
No data edges	7.76	+129.6
No call edges	3.88	+14.8
No backward edges	4.16	+23.1
No edge positions	3.43	+1.5

(b) PROGRAML ablations.

Table 4: Algorithm classification comparison to state-of-the-art, and ablations.

6.2. Algorithm Classification

We apply our approach to the task of classifying algorithms from unlabeled implementations. We use the Mou et al. (2016) dataset. It contains implementations of 104 different algorithms that were submitted to a judge system. All samples were written by students in higher education. There are around 500 samples per algorithm. We compile them with different combinations of optimization flags to generate a dataset of overall 240k samples, as in Ben-Nun et al. (2018). Approximately 10,000 files are held out each as development and test sets. *cf. Appendix D.2. for details.*

Table 4a compares the test error of our method against prior works, where we set a new state-of-the-art.

Ablation Studies We ablate the PROGRAML representation in Table 4b. Every component of our representation contributes positively to performance. We note that structure alone (*No vocab*) is sufficient to outperform prior work, suggesting that algorithm classification is a problem that lends itself especially well to judging the power of the representation structure, since most algorithms are well-defined independent of implementation details, such as data types. However, the choice of vocabulary is important. Replacing the PROGRAML vocabulary with that

of a prior approach (*inst2vec vocab* (Ben-Nun et al., 2018)) degrades performance. The greatest contribution to the performance of PROGRAML on this task is data flow edges. Backward edges (Li et al., 2015), which are required for reasoning about backward data flow analyses, provide the second greatest contribution. These results highlight the importance of data flow analysis for improving program reasoning through machine learning.

7. Conclusions

The evolution of ML for compilers requires more expressive representations. We show that current techniques cannot reason about simple data flows which are at the core of all compilers. We present PROGRAML, a graph-based representation for programs derived from compiler IRs that accurately captures the semantics of a program’s statements and the relations between them. We are releasing the DEEPDATAFLOW dataset as a community benchmark for evaluating approaches to learning over programs. PROGRAML and DEEPDATAFLOW open up new directions for research towards more flexible and useful program analysis. PROGRAML outperforms the state-of-the-art, but is limited by scalability issues imposed by MPNNs. In highlighting the limitations of our approach we wish to expedite future research to address key challenges that are faced in the domain of program analysis. As future work, we will investigate how MPNNs could be improved to learn efficient and stable fixed-point algorithms, regardless of input graph size.

Acknowledgments

This project received funding from the European Research Council (ERC) under the European Union’s Horizon 2020 program (grant agreements DAPP, No. 678880, DEEPSEA, No. 955606, and MAELSTROM, No. 955513). T.B.N. is supported by the Swiss National Science Foundation (Ambizione Project No. 185778).

References

Allamanis, M. *Learning Natural Coding Conventions*. PhD thesis, University of Edinburgh, 2016.

Allamanis, M., Brockschmidt, M., and Khademi, M. Learning to Represent Programs with Graphs. In *ICLR*, 2017.

Allamanis, M., Barr, E. T., Devanbu, P., and Sutton, C. A Survey of Machine Learning for Big Code and Naturalness. *ACM Computing Surveys*, 51(4), 2018.

Alon, U., Zilberstein, M., Levy, O., and Yahav, E. code2vec: Learning Distributed Representations of

Code. In *Symposium on Principles of Programming Languages (POPL)*, 2018a.

Alon, U., Zilberstein, M., Levy, O., and Yahav, E. A General Path-Based Representation for Predicting Program Properties. In *ACM SIGPLAN Conference on Programming Language Design and Implementation (PLDI)*. ACM, 2018b.

Ashouri, A. H., Killian, W., Cavazos, J., Palermo, G., and Silvano, C. A Survey on Compiler Autotuning using Machine Learning. *ACM Computing Surveys*, 51(5), 2018.

Barchi, F., Urgese, G., Macii, E., and Acquaviva, A. Code Mapping in Heterogeneous Platforms Using Deep Learning and LLVM-IR. In *DAC*. ACM, 2019.

Battaglia, P., Hamrick, J. B., Bapst, V., Sanchez-Gonzalez, A., Zambaldi, V., Malinowski, M., Tacchetti, A., Raposo, D., Santoro, A., Faulkner, R., Gulcehre, C., Song, F., Ballard, A., Gilmer, J., Dahl, G., Vaswani, A., Allen, K., Nash, C., Langston, V., Dyer, C., Heess, N., Wierstra, D., Kohli, P., Botvinick, M., Vinyals, O., Li, Y., and Pascanu, R. Relational Inductive Biases, Deep Learning, and Graph Networks. *arXiv:1806.01261*, 2018.

Ben-Nun, T., Jakobovits, A. S., and Hoefler, T. Neural Code Comprehension: A Learnable Representation of Code Semantics. In *NeurIPS*, 2018.

Bielik, P., Raychev, V., and Vechev, M. Learning a Static Analyzer from Data. In *CAV*, 2017.

Brauckmann, A., Ertel, S., Goens, A., and Castrillon, J. Compiler-Based Graph Representations for Deep Learning Models of Code. In *CC*, 2020.

Cho, K., van Merriënboer, B., Gulcehre, C., Bahdanau, D., Bougares, F., Schwenk, H., and Bengio, Y. Learning Phrase Representations using RNN Encoder-Decoder for Statistical Machine Translation. In *Empirical Methods in Natural Language Processing*, 2014.

Cooper, K. D. and Torczon, L. *Engineering a Compiler*. Elsevier, 2012.

Cooper, K. D., Harvey, T. J., and Kennedy, K. Iterative Data-flow Analysis, Revisited. Technical report, Department of Computer Science, Rice University, 2004.

Cummins, C. *Deep Learning for Compilers*. PhD thesis, University of Edinburgh, 2020a.

Cummins, C. DeepDataFlow. Zenodo, June 2020b. URL <https://doi.org/10.5281/zenodo.4247595>.

- Cummins, C., Petoumenos, P., Wang, Z., and Leather, H. End-to-end Deep Learning of Optimization Heuristics. In *PACT*. IEEE, 2017a.
- Cummins, C., Petoumenos, P., Wang, Z., and Leather, H. Synthesizing benchmarks for predictive modeling. In *CGO*. IEEE, 2017b.
- Dam, H. K., Grundy, J., Kim, T., and Kim, C. A Deep Tree-Based Model for Software Defect Prediction. *arXiv:1802.00921*, 2018.
- Ferrante, J., Ottenstein, K. J., and Warren, J. D. The Program Dependence Graph and Its Use in Optimization. *TOPLAS*, 9(3), 1987.
- Gehring, J., Auli, M., Grangier, D., Yarats, D., and Dauphin, Y. N. Convolutional Sequence to Sequence Learning. In *ICML*. PMLR, 2017.
- Gilmer, J., Schoenholz, S. S., Riley, P. F., Vinyals, O., and Dahl, G. E. Neural Message Passing for Quantum Chemistry. In *ICML*. PMLR, 2017.
- Grewe, D., Wang, Z., and O’Boyle, M. F. P. Portable Mapping of Data Parallel Programs to OpenCL for Heterogeneous Systems. In *CGO*. IEEE, 2013.
- Haj-Ali, A., Ahmed, N. K., Willke, T., Shao, S., Asanovic, K., and Stoica, I. NeuroVectorizer: End-to-End Vectorization with Deep Reinforcement Learning. *CGO*, 2020.
- Kam, J. B. and Ullman, J. D. Global Data Flow Analysis and Iterative Algorithms. *JACM*, 1976.
- Kam, J. B. and Ullman, J. D. Monotone Data Flow Analysis Frameworks. *Acta Informatica*, 7(3), 1977.
- Kanade, A., Maniatis, P., Balakrishnan, G., and Shi, K. Learning and Evaluating Contextual Embedding of Source Code. In *ICML*, 2020.
- Keerthy S, V., Aggarwal, R., Jain, S., Desarkar, M. S., Upadrasta, R., and Spkant, Y. N. IR2Vec: A Flow Analysis based Scalable Infrastructure for Program Encodings. *arXiv:1909.06228*, 2019.
- Kildall, G. A. A Unified Approach to Global Program Optimization. In *POPL*, 1973.
- Leather, H. and Cummins, C. Machine learning in compilers: Past, present and future. In *FDL*. IEEE, 2020.
- Li, L., Gu, C., Dullien, T., Vinyals, O., and Kohli, P. Graph Matching Networks for Learning the Similarity of Graph Structured Objects. In *ICML*. PMLR, 2019.
- Li, Y., Zemel, R., Brockschmidt, M., and Tarlow, D. Gated Graph Sequence Neural Networks. *arXiv:1511.05493*, 2015.
- Mendis, C., Yang, C., Pu, Y., Amarasinghe, S., and Michael, C. Compiler auto-vectorization with imitation learning. In *NeurIPS*, 2019.
- Mirhoseini, A., Pham, H., Le, Q. V., Steiner, B., Larsen, R., Zhou, Y., Kumar, N., Norouzi, M., Bengio, S., and Dean, J. Device Placement Optimization with Reinforcement Learning. In *ICML*, 2017.
- Mou, L., Li, G., Zhang, L., Wang, T., and Jin, Z. Convolutional Neural Networks over Tree Structures for Programming Language Processing. In *AAAI*, 2016.
- Raychev, V., Vechev, M., and Krause, A. Predicting Program Properties from "Big Code". In *POPL*, 2015.
- Shi, Z., Swersky, K., Tarlow, D., Ranganathan, P., and Hashemi, M. Learning Execution through Neural Code Fusion. In *ICLR*, 2020.
- Si, X., Dai, H., Raghothaman, M., Naik, M., and Song, L. Learning Loop Invariants for Program Verification. In *NeurIPS*, 2018.
- Steiner, B., Cummins, C., He, H., and Leather, H. Value learning for throughput optimization of deep learning workloads. *MLSys*, 2021.
- Tai, K. S., Socher, R., and Manning, C. D. Improved Semantic Representations From Tree-Structured Long Short-Term Memory Networks. *arXiv:1503.00075*, 2015.
- Vaswani, A., Shazeer, N., Parmar, N., Uszkoreit, J., Jones, L., Gomez, A. N., Kaiser, L., and Polosukhin, I. Attention Is All You Need. In *NIPS*, 2017.
- Wang, K. and Su, Z. Blended, precise semantic program embeddings. In *PLDI*, 2020.
- Yin, P., Neubig, G., Allamanis, M., Brockschmidt, M., and Gaunt, A. L. Learning to Represent Edits. *arXiv:1810.13337*, 2018.
- Ziwei, Z., Cui, P., and Zhu, W. Deep Learning on Graphs: A Survey. *TKDE*, 2020.