

Network Working Group
Request for Comments: 5213
Category: Standards Track

S. Gundavelli, Ed.
K. Leung
Cisco
V. Devarapalli
Wichorus
K. Chowdhury
Starent Networks
B. Patil
Nokia
August 2008

Proxy Mobile IPv6

Status of This Memo

This document specifies an Internet standards track protocol for the Internet community, and requests discussion and suggestions for improvements. Please refer to the current edition of the "Internet Official Protocol Standards" (STD 1) for the standardization state and status of this protocol. Distribution of this memo is unlimited.

Abstract

Network-based mobility management enables IP mobility for a host without requiring its participation in any mobility-related signaling. The network is responsible for managing IP mobility on behalf of the host. The mobility entities in the network are responsible for tracking the movements of the host and initiating the required mobility signaling on its behalf. This specification describes a network-based mobility management protocol and is referred to as Proxy Mobile IPv6.

Table of Contents

1.	Introduction	4
2.	Conventions and Terminology	5
2.1.	Conventions Used in This Document	5
2.2.	Terminology	5
3.	Proxy Mobile IPv6 Protocol Overview	9
4.	Proxy Mobile IPv6 Protocol Security	15
4.1.	Peer Authorization Database (PAD) Example Entries	16
4.2.	Security Policy Database (SPD) Example Entries	17
5.	Local Mobility Anchor Operation	17
5.1.	Extensions to Binding Cache Entry Data Structure	18
5.2.	Supported Home Network Prefix Models	19
5.3.	Signaling Considerations	20
5.3.1.	Processing Proxy Binding Updates	20
5.3.2.	Initial Binding Registration (New Mobility Session) ..	22
5.3.3.	Binding Lifetime Extension (No Handoff)	23
5.3.4.	Binding Lifetime Extension (After Handoff)	24
5.3.5.	Binding De-Registration	24
5.3.6.	Constructing the Proxy Binding Acknowledgement Message	25
5.4.	Multihoming Support	27
5.4.1.	Binding Cache Entry Lookup Considerations	28
5.5.	Timestamp Option for Message Ordering	34
5.6.	Routing Considerations	37
5.6.1.	Bi-Directional Tunnel Management	37
5.6.2.	Forwarding Considerations	38
5.6.3.	Explicit Congestion Notification (ECN) Considerations for Proxy Mobile IPv6 Tunnels	39
5.7.	Local Mobility Anchor Address Discovery	40
5.8.	Mobile Prefix Discovery Considerations	40
5.9.	Route Optimization Considerations	41
6.	Mobile Access Gateway Operation	41
6.1.	Extensions to Binding Update List Entry Data Structure ...	42
6.2.	Mobile Node's Policy Profile	43
6.3.	Supported Access Link Types	44
6.4.	Supported Address Configuration Modes	44
6.5.	Access Authentication and Mobile Node Identification	45
6.6.	Acquiring Mobile Node's Identifier	45
6.7.	Home Network Emulation	46
6.8.	Link-local and Global Address Uniqueness	46
6.9.	Signaling Considerations	48
6.9.1.	Binding Registrations	48
6.9.2.	Router Solicitation Messages	56
6.9.3.	Default-Router	57
6.9.4.	Retransmissions and Rate Limiting	58
6.9.5.	Path MTU Discovery	59
6.10.	Routing Considerations	60

6.10.1. Transport Network	60
6.10.2. Tunneling and Encapsulation Modes	61
6.10.3. Local Routing	62
6.10.4. Tunnel Management	62
6.10.5. Forwarding Rules	62
6.11. Supporting DHCP-Based Address Configuration on the Access Link	64
6.12. Home Network Prefix Renumbering	66
6.13. Mobile Node Detachment Detection and Resource Cleanup ...	66
6.14. Allowing Network Access to Other IPv6 Nodes	67
7. Mobile Node Operation	67
7.1. Moving into a Proxy Mobile IPv6 Domain	67
7.2. Roaming in the Proxy Mobile IPv6 Domain	69
8. Message Formats	69
8.1. Proxy Binding Update Message	69
8.2. Proxy Binding Acknowledgement Message	71
8.3. Home Network Prefix Option	72
8.4. Handoff Indicator Option	73
8.5. Access Technology Type Option	74
8.6. Mobile Node Link-layer Identifier Option	76
8.7. Link-local Address Option	77
8.8. Timestamp Option	77
8.9. Status Values	78
9. Protocol Configuration Variables	80
9.1. Local Mobility Anchor - Configuration Variables	80
9.2. Mobile Access Gateway - Configuration Variables	81
9.3. Proxy Mobile IPv6 Domain - Configuration Variables	82
10. IANA Considerations	83
11. Security Considerations	84
12. Acknowledgements	85
13. References	86
13.1. Normative References	86
13.2. Informative References	87
Appendix A. Proxy Mobile IPv6 Interactions with AAA Infrastructure	89
Appendix B. Routing State	89

1. Introduction

IP mobility for IPv6 hosts is specified in Mobile IPv6 [RFC3775]. Mobile IPv6 requires client functionality in the IPv6 stack of a mobile node. Exchange of signaling messages between the mobile node and home agent enables the creation and maintenance of a binding between the mobile node's home address and its care-of address. Mobility as specified in [RFC3775] requires the IP host to send IP mobility management signaling messages to the home agent, which is located in the network.

Network-based mobility is another approach to solving the IP mobility challenge. It is possible to support mobility for IPv6 nodes without host involvement by extending Mobile IPv6 [RFC3775] signaling messages between a network node and a home agent. This approach to supporting mobility does not require the mobile node to be involved in the exchange of signaling messages between itself and the home agent. A proxy mobility agent in the network performs the signaling with the home agent and does the mobility management on behalf of the mobile node attached to the network. Because of the use and extension of Mobile IPv6 signaling and home agent functionality, this protocol is referred to as Proxy Mobile IPv6 (PMIPv6).

Network deployments that are designed to support mobility would be agnostic to the capability in the IPv6 stack of the nodes that it serves. IP mobility for nodes that have mobile IP client functionality in the IPv6 stack as well as those nodes that do not, would be supported by enabling Proxy Mobile IPv6 protocol functionality in the network. The advantages of developing a network-based mobility protocol based on Mobile IPv6 are:

- o Reuse of home agent functionality and the messages/format used in mobility signaling. Mobile IPv6 is a mature protocol with several implementations that have undergone interoperability testing.
- o A common home agent would serve as the mobility agent for all types of IPv6 nodes.

The problem statement and the need for a network-based mobility protocol solution has been documented in [RFC4830]. Proxy Mobile IPv6 is a solution that addresses these issues and requirements.

2. Conventions and Terminology

2.1. Conventions Used in This Document

The key words "MUST", "MUST NOT", "REQUIRED", "SHALL", "SHALL NOT", "SHOULD", "SHOULD NOT", "RECOMMENDED", "MAY", and "OPTIONAL" in this document are to be interpreted as described in RFC 2119 [RFC2119].

2.2. Terminology

All the general mobility-related terms used in this document are to be interpreted as defined in the Mobile IPv6 base specification [RFC3775].

This document adopts the terms, Local Mobility Anchor (LMA) and Mobile Access Gateway (MAG) from the NETLMM Goals document [RFC4831]. This document also provides the following context-specific explanation to the following terms used in this document.

Proxy Mobile IPv6 Domain (PMIPv6-Domain)

Proxy Mobile IPv6 domain refers to the network where the mobility management of a mobile node is handled using the Proxy Mobile IPv6 protocol as defined in this specification. The Proxy Mobile IPv6 domain includes local mobility anchors and mobile access gateways between which security associations can be set up and authorization for sending Proxy Binding Updates on behalf of the mobile nodes can be ensured.

Local Mobility Anchor (LMA)

Local Mobility Anchor is the home agent for the mobile node in a Proxy Mobile IPv6 domain. It is the topological anchor point for the mobile node's home network prefix(es) and is the entity that manages the mobile node's binding state. The local mobility anchor has the functional capabilities of a home agent as defined in Mobile IPv6 base specification [RFC3775] with the additional capabilities required for supporting Proxy Mobile IPv6 protocol as defined in this specification.

Mobile Access Gateway (MAG)

Mobile Access Gateway is a function on an access router that manages the mobility-related signaling for a mobile node that is attached to its access link. It is responsible for tracking the mobile node's movements to and from the access link and for signaling the mobile node's local mobility anchor.

Mobile Node (MN)

Throughout this document, the term mobile node is used to refer to an IP host or router whose mobility is managed by the network. The mobile node may be an IPv4-only node, IPv6-only node, or a dual-stack node and is not required to participate in any IP mobility related signaling for achieving mobility for an IP address that is obtained in that Proxy Mobile IPv6 domain.

LMA Address (LMAA)

The global address that is configured on the interface of the local mobility anchor and is the transport endpoint of the bi-directional tunnel established between the local mobility anchor and the mobile access gateway. This is the address to which the mobile access gateway sends the Proxy Binding Update messages. When supporting IPv4 traversal, i.e., when the network between the local mobility anchor and the mobile access gateway is an IPv4 network, this address will be an IPv4 address and will be referred to as IPv4-LMAA, as specified in [IPV4-PMIP6].

Proxy Care-of Address (Proxy-CoA)

Proxy-CoA is the global address configured on the egress interface of the mobile access gateway and is the transport endpoint of the tunnel between the local mobility anchor and the mobile access gateway. The local mobility anchor views this address as the care-of address of the mobile node and registers it in the Binding Cache entry for that mobile node. When the transport network between the mobile access gateway and the local mobility anchor is an IPv4 network and if the care-of address that is registered at the local mobility anchor is an IPv4 address, the term, IPv4-Proxy-CoA is used, as specified in [IPV4-PMIP6].

Mobile Node's Home Network Prefix (MN-HNP)

The MN-HNP is a prefix assigned to the link between the mobile node and the mobile access gateway. More than one prefix can be assigned to the link between the mobile node and the mobile access gateway, in which case, all of the assigned prefixes are managed as a set associated with a mobility session. The mobile node configures its interface with one or more addresses from its home network prefix(es). If the mobile node connects to the Proxy Mobile IPv6 domain through multiple interfaces, simultaneously, each of the attached interfaces will be assigned a unique set of home network prefixes, and all the prefixes assigned to a given interface of a mobile node will be managed under one mobility session. For example, home network prefixes P1 and P2 assigned to

interface I1 will be managed under one mobility session and prefixes P3, P4, and P5 assigned to interface I2 of the mobile node will be managed under a different mobility session. Additionally, in some configurations the assigned prefix can be of 128-bit prefix length.

Mobile Node's Home Address (MN-HoA)

MN-HoA is an address from a mobile node's home network prefix. The mobile node will be able to use this address as long as it is attached to the access network that is in the scope of that Proxy Mobile IPv6 domain. If the mobile node uses more than one address from its home network prefix(es), any one of these addresses is referred to as mobile node's home address. Unlike in Mobile IPv6 where the home agent is aware of the home address of the mobile node, in Proxy Mobile IPv6, the mobility entities are only aware of the mobile node's home network prefix(es) and are not always aware of the exact address(es) that the mobile node configured on its interface from its home network prefix(es). However, in some configurations and based on the enabled address configuration modes on the access link, the mobility entities in the network can be certain about the exact address(es) configured by the mobile node.

Mobile Node's Home Link

This is the link on which the mobile node obtained its layer-3 address configuration for the attached interface after it moved into that Proxy Mobile IPv6 domain. This is the link that conceptually follows the mobile node. The network will ensure the mobile node always sees this link with respect to the layer-3 network configuration, on any access link that it attaches to in that Proxy Mobile IPv6 domain.

Multihomed Mobile Node

A mobile node that connects to the same Proxy Mobile IPv6 domain through more than one interface and uses these interfaces simultaneously is referred to as a multihomed mobile node.

Mobile Node Identifier (MN-Identifier)

The identity of a mobile node in the Proxy Mobile IPv6 domain. This is the stable identifier of a mobile node that the mobility entities in a Proxy Mobile IPv6 domain can always acquire and use for predictably identifying a mobile node. This is typically an identifier such as a Network Access Identifier (NAI) [RFC4282] or other identifier such as a Media Access Control (MAC) address.

Mobile Node Link-layer Identifier (MN-LL-Identifier)

An identifier that identifies the attached interface of a mobile node. For those interfaces that have a link-layer identifier, this identifier can be based on that. The link-layer identifier, in some cases, is generated by the mobile node and conveyed to the mobile access gateway. This identifier of the attached interface must be stable, as seen by any of the mobile access gateways in a given Proxy Mobile IPv6 domain. In some other cases, there might not be any link-layer identifier associated with the mobile node's interface. An identifier value of ALL_ZERO is not considered a valid identifier and cannot be used as an interface identifier.

Policy Profile

Policy Profile is an abstract term for referring to a set of configuration parameters that are configured for a given mobile node. The mobility entities in the Proxy Mobile IPv6 domain require access to these parameters for providing the mobility management to a given mobile node. The specific details on how the network entities obtain this policy profile is outside the scope of this document.

Proxy Binding Update (PBU)

A request message sent by a mobile access gateway to a mobile node's local mobility anchor for establishing a binding between the mobile node's home network prefix(es) assigned to a given interface of a mobile node and its current care-of address (Proxy-CoA).

Proxy Binding Acknowledgement (PBA)

A reply message sent by a local mobility anchor in response to a Proxy Binding Update message that it received from a mobile access gateway.

Per-MN-Prefix and Shared-Prefix Models

The term Per-MN-Prefix model is used to refer to an addressing model where there is a unique network prefix or prefixes assigned for each node. The term Shared-Prefix model is used to refer to an addressing model where the prefix(es) are shared by more than one node. This specification supports the Per-MN-Prefix model and does not support the Shared-Prefix model.

Mobility Session

In the context of Proxy Mobile IPv6 specification, the term mobility session refers to the creation or existence of state associated with the mobile node's mobility binding on the local mobility anchor and on the serving mobile access gateway.

DHCP

Throughout this document, the acronym DHCP refers to DHCP for IPv6, as defined in [RFC3315].

ALL_ZERO and NON_ZERO

Protocol message fields initialized with value 0 in each byte of the field. For example, an 8-byte link-layer identifier field with the value set to 0 in each of the 8 bytes, or an IPv6 address with the value 0 in all of the 16 bytes. Conversely, the term NON_ZERO is used to refer to any value other than an ALL_ZERO value.

3. Proxy Mobile IPv6 Protocol Overview

This specification describes a network-based mobility management protocol. It is called Proxy Mobile IPv6 and is based on Mobile IPv6 [RFC3775].

Proxy Mobile IPv6 protocol is intended for providing network-based IP mobility management support to a mobile node, without requiring the participation of the mobile node in any IP mobility related signaling. The mobility entities in the network will track the mobile node's movements and will initiate the mobility signaling and set up the required routing state.

The core functional entities in the NETLMM infrastructure are the Local Mobility Anchor (LMA) and the Mobile Access Gateway (MAG). The local mobility anchor is responsible for maintaining the mobile node's reachability state and is the topological anchor point for the mobile node's home network prefix(es). The mobile access gateway is the entity that performs the mobility management on behalf of a mobile node, and it resides on the access link where the mobile node is anchored. The mobile access gateway is responsible for detecting the mobile node's movements to and from the access link and for initiating binding registrations to the mobile node's local mobility anchor. There can be multiple local mobility anchors in a Proxy Mobile IPv6 domain each serving a different group of mobile nodes. The architecture of a Proxy Mobile IPv6 domain is shown in Figure 1.

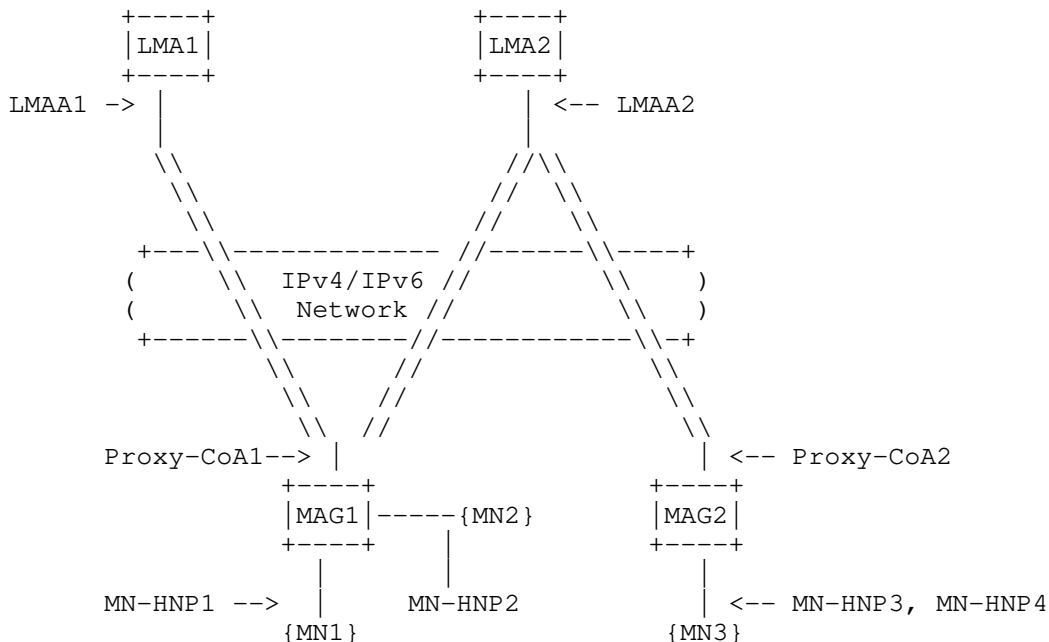

Figure 1: Proxy Mobile IPv6 Domain

When a mobile node enters a Proxy Mobile IPv6 domain and attaches to an access link, the mobile access gateway on that access link, after identifying the mobile node and acquiring its identity, will determine if the mobile node is authorized for the network-based mobility management service.

If the network determines that the mobile node is authorized for network-based mobility service, the network will ensure that the mobile node using any of the address configuration mechanisms permitted by the network will be able to obtain the address configuration on the connected interface and move anywhere in that Proxy Mobile IPv6 domain. The obtained address configuration includes the address(es) from its home network prefix(es), the default-router address on the link, and other related configuration parameters. From the perspective of each mobile node, the entire Proxy Mobile IPv6 domain appears as a single link, the network ensures that the mobile node does not detect any change with respect to its layer-3 attachment even after changing its point of attachment in the network.

The mobile node may be an IPv4-only node, IPv6-only node, or a dual-stack (IPv4/v6) node. Based on the policy profile information that indicates the type of address or prefixes to be assigned for the mobile node in the network, the mobile node will be able to obtain an IPv4, IPv6, or dual IPv4/IPv6 address and move anywhere in that Proxy Mobile IPv6 domain. However, this specification only supports IPv6 address/prefix mobility with the transport network being IPv6. The support for IPv4 addressing or an IPv4 transport network is specified in the companion document [IPV4-PMIP6].

If the mobile node connects to the Proxy Mobile IPv6 domain through multiple interfaces and over multiple access networks, the network will allocate a unique set of home network prefixes for each of the connected interfaces. The mobile node will be able to configure address(es) on those interfaces from the respective home network prefix(es). However, if the mobile node performs a handoff by moving its address configuration from one interface to the other, and if the local mobility anchor receives a handoff hint from the serving mobile access gateway about the same, the local mobility anchor will assign the same home network prefix(es) that it previously assigned prior to the handoff. The mobile node will also be able to perform a handoff by changing its point of attachment from one mobile access gateway to a different mobile access gateway using the same interface and will be able to retain the address configuration on the attached interface.

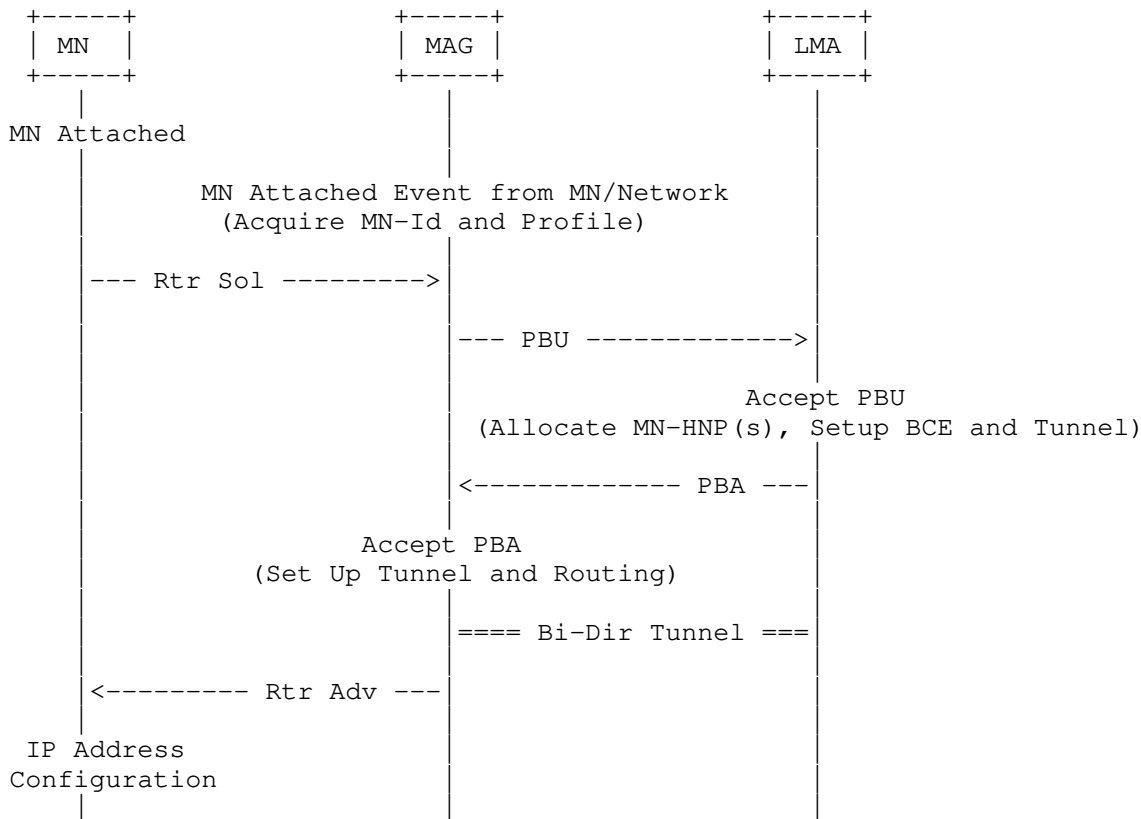

Figure 2: Mobile Node Attachment - Signaling Call Flow

Figure 2 shows the signaling call flow when the mobile node enters the Proxy Mobile IPv6 domain. The Router Solicitation message from the mobile node may arrive at any time after the mobile node's attachment and has no strict ordering relation with the other messages in the call flow.

For updating the local mobility anchor about the current location of the mobile node, the mobile access gateway sends a Proxy Binding Update message to the mobile node's local mobility anchor. Upon accepting this Proxy Binding Update message, the local mobility anchor sends a Proxy Binding Acknowledgement message including the mobile node's home network prefix(es). It also creates the Binding Cache entry and sets up its endpoint of the bi-directional tunnel to the mobile access gateway.

The mobile access gateway on receiving the Proxy Binding Acknowledgement message sets up its endpoint of the bi-directional tunnel to the local mobility anchor and also sets up the forwarding for the mobile node's traffic. At this point, the mobile access gateway has all the required information for emulating the mobile node's home link. It sends Router Advertisement messages to the mobile node on the access link advertising the mobile node's home network prefix(es) as the hosted on-link prefix(es).

The mobile node, on receiving these Router Advertisement messages on the access link, attempts to configure its interface using either stateful or stateless address configuration modes, based on the modes that are permitted on that access link as indicated in Router Advertisement messages. At the end of a successful address configuration procedure, the mobile node has one or more addresses from its home network prefix(es).

After address configuration, the mobile node has one or more valid addresses from its home network prefix(es) at the current point of attachment. The serving mobile access gateway and the local mobility anchor also have proper routing states for handling the traffic sent to and from the mobile node using any one or more of the addresses from its home network prefix(es).

The local mobility anchor, being the topological anchor point for the mobile node's home network prefix(es), receives any packets that are sent to the mobile node by any node in or outside the Proxy Mobile IPv6 domain. The local mobility anchor forwards these received packets to the mobile access gateway through the bi-directional tunnel. The mobile access gateway on other end of the tunnel, after receiving the packet, removes the outer header and forwards the packet on the access link to the mobile node. However, in some cases, the traffic sent from a correspondent node that is locally connected to the mobile access gateway may not be received by the local mobility anchor and may be routed locally by the mobile access gateway (refer to Section 6.10.3).

The mobile access gateway acts as the default router on the point-to-point link shared with the mobile node. Any packet that the mobile node sends to any correspondent node will be received by the mobile access gateway and will be sent to its local mobility anchor through the bi-directional tunnel. The local mobility anchor on the other end of the tunnel, after receiving the packet, removes the outer header and routes the packet to the destination. However, in some cases, the traffic sent to a correspondent node that is locally connected to the mobile access gateway may be locally routed by the mobile access gateway (refer to Section 6.10.3).

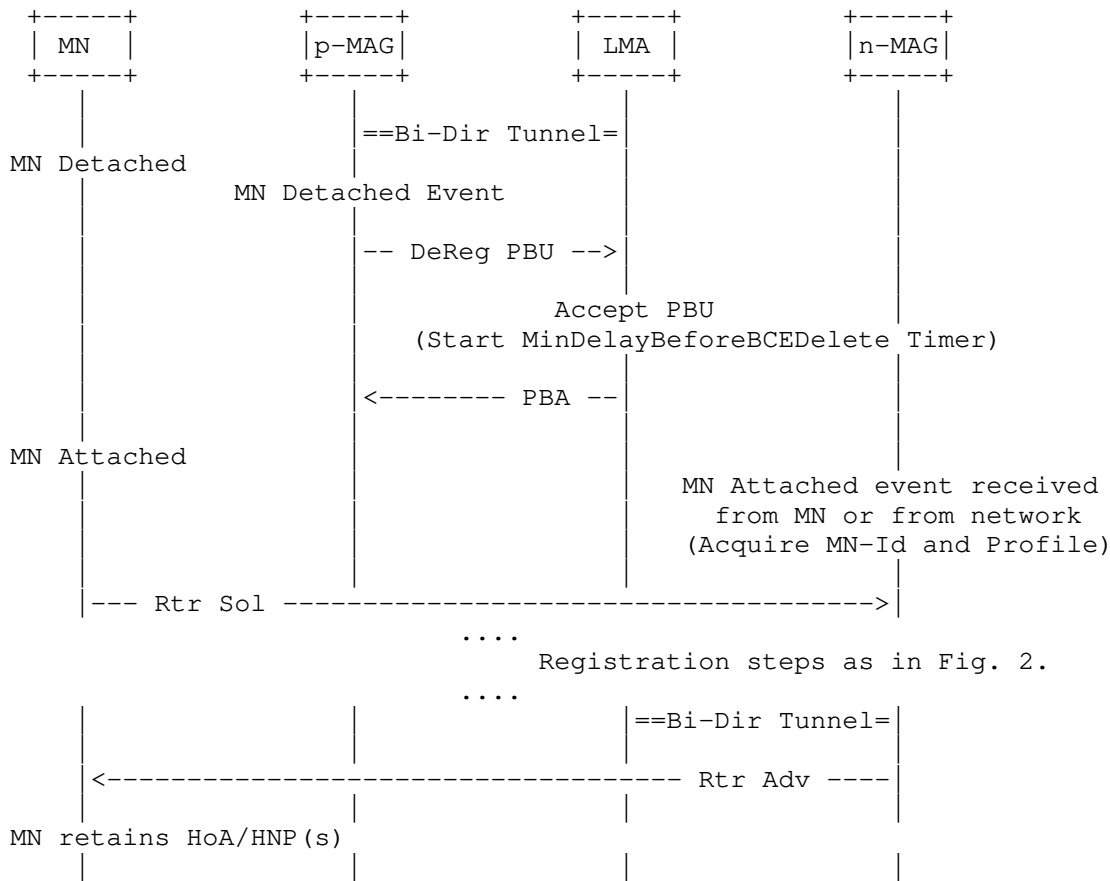

Figure 3: Mobile Node Handoff - Signaling Call Flow

Figure 3 shows the signaling call flow for the mobile node's handoff from the previously attached mobile access gateway (p-MAG) to the newly attached mobile access gateway (n-MAG). This call flow only reflects a specific message ordering, it is possible the registration message from the n-MAG may arrive before the de-registration message from the p-MAG arrives.

After obtaining the initial address configuration in the Proxy Mobile IPv6 domain, if the mobile node changes its point of attachment, the mobile access gateway on the previous link will detect the mobile node's detachment from the link. It will signal the local mobility anchor and will remove the binding and routing state for that mobile node. The local mobility anchor, upon receiving this request, will identify the corresponding mobility session for which the request was

received, and accepts the request after which it waits for a certain amount of time to allow the mobile access gateway on the new link to update the binding. However, if it does not receive any Proxy Binding Update message within the given amount of time, it will delete the binding cache entry.

The mobile access gateway on the new access link, upon detecting the mobile node on its access link, will signal the local mobility anchor to update the binding state. After completion of the signaling, the serving mobile access gateway will send the Router Advertisements containing the mobile node's home network prefix(es), and this will ensure the mobile node will not detect any change with respect to the layer-3 attachment of its interface.

4. Proxy Mobile IPv6 Protocol Security

The signaling messages, Proxy Binding Update, and Proxy Binding Acknowledgement, exchanged between the mobile access gateway and the local mobility anchor, MUST be protected using end-to-end security association(s) offering integrity and data origin authentication.

The mobile access gateway and the local mobility anchor MUST implement IPsec for protecting the Proxy Mobile IPv6 signaling messages [RFC4301]. IPsec is a mandatory-to-implement security mechanism. However, additional documents may specify alternative mechanisms and the mobility entities can enable a specific mechanism for securing Proxy Mobile IPv6 signaling messages, based on either a static configuration or after a dynamic negotiation using any standard security negotiation protocols. As in Mobile IPv6 [RFC3775], the use of IPsec for protecting a mobile node's data traffic is optional.

IPsec Encapsulating Security Payload (ESP) [RFC4303] in transport mode with mandatory integrity protection SHOULD be used for protecting the signaling messages. Confidentiality protection of these messages is not required.

IPsec ESP [RFC4303] in tunnel mode MAY be used to protect the mobile node's tunneled data traffic, if protection of data traffic is required.

Internet Key Exchange Protocol version 2 (IKEv2) [RFC4306] SHOULD be used to set up security associations between the mobile access gateway and the local mobility anchor to protect the Proxy Binding Update and Proxy Binding Acknowledgement messages. The mobile access gateway and the local mobility anchor can use any of the authentication mechanisms, as specified in [RFC4306], for mutual authentication.

The Mobile IPv6 specification [RFC3775] requires the home agent to prevent a mobile node from creating security associations or creating binding cache entries for another mobile node's home address. In the protocol described in this document, the mobile node is not involved in creating security associations for protecting the signaling messages or sending binding updates. Therefore, the local mobility anchor MUST restrict the creation and manipulation of proxy bindings to specifically authorized mobile access gateways and prefixes. The local mobility anchor MUST be locally configurable to authorize such specific combinations. Additional mechanisms, such as a policy store or Authentication, Authorization, and Accounting (AAA) may be employed, but these are outside the scope of this specification.

Unlike in Mobile IPv6 [RFC3775], these signaling messages do not carry either the Home Address destination option or the Type 2 Routing header, and hence the policy entries and security association selectors stay the same and require no special IPsec related considerations.

4.1. Peer Authorization Database (PAD) Example Entries

This section describes PAD entries [RFC4301] on the mobile access gateway and the local mobility anchor. The PAD entries are only example configurations. Note that the PAD is a logical concept and a particular mobile access gateway or a local mobility anchor implementation can implement the PAD in any implementation-specific manner. The PAD state may also be distributed across various databases in a specific implementation.

In the example shown below, the identity of the local mobility anchor is assumed to be `lma_identity_1` and the identity of the mobile access gateway is assumed to be `mag_identity_1`.

```
mobile access gateway PAD:
- IF remote_identity = lma_identity_1
  Then authenticate (shared secret/certificate/EAP)
  and authorize CHILD_SAs for remote address lma_address_1

local mobility anchor PAD:
- IF remote_identity = mag_identity_1
  Then authenticate (shared secret/certificate/EAP)
  and authorize CHILD_SAs for remote address mag_address_1
```

Figure 4: PAD Entries

The list of authentication mechanisms in the above examples is not exhaustive. There could be other credentials used for authentication stored in the PAD.

4.2. Security Policy Database (SPD) Example Entries

This section describes the security policy entries [RFC4301] on the mobile access gateway and the local mobility anchor required to protect the Proxy Mobile IPv6 signaling messages. The SPD entries are only example configurations. A particular mobile access gateway or a local mobility anchor implementation could configure different SPD entries as long as they provide the required security.

In the example shown below, the identity of the mobile access gateway is assumed to be `mag_identity_1`, the address of the mobile access gateway is assumed to be `mag_address_1`, and the address of the local mobility anchor is assumed to be `lma_address_1`. The acronym MH represents the protocol number for the Mobility Header [RFC3775], while the terms `local_mh_type` and `remote_mh_type` stand for local mobility header type and remote mobility header type, respectively.

```
mobile access gateway SPD-S:
- IF local_address = mag_address_1 &
  remote_address = lma_address_1 &
  proto = MH & (local_mh_type = BU | remote_mh_type = BA)
  Then use SA ESP transport mode
  Initiate using IDi = mag_identity_1 to address lma_address_1

local mobility anchor SPD-S:
- IF local_address = lma_address_1 &
  remote_address = mag_address_1 &
  proto = MH & (local_mh_type = BA | remote_mh_type = BU)
  Then use SA ESP transport mode
```

Figure 5: SPD Entries

5. Local Mobility Anchor Operation

The local mobility anchor MUST support the home agent function as defined in [RFC3775] and the extensions defined in this specification. A home agent with these modifications and enhanced capabilities for supporting the Proxy Mobile IPv6 protocol is referred to as a local mobility anchor.

This section describes the operational details of the local mobility anchor.

5.1. Extensions to Binding Cache Entry Data Structure

Every local mobility anchor MUST maintain a Binding Cache entry for each currently registered mobile node. A Binding Cache entry is a conceptual data structure, described in Section 9.1 of [RFC3775].

For supporting this specification, the Binding Cache Entry data structure needs to be extended with the following additional fields.

- o A flag indicating whether or not this Binding Cache entry is created due to a proxy registration. This flag is set to value 1 for Binding Cache entries that are proxy registrations and is set to value 0 for all other entries.
- o The identifier of the registered mobile node, MN-Identifier. This identifier is obtained from the Mobile Node Identifier Option [RFC4283] present in the received Proxy Binding Update message.
- o The link-layer identifier of the mobile node's connected interface on the access link. This identifier can be acquired from the Mobile Node Link-layer Identifier option, present in the received Proxy Binding Update message. If the option was not present in the request, this variable length field MUST be set to two (octets) and MUST be initialized to a value of ALL_ZERO.
- o The link-local address of the mobile access gateway on the point-to-point link shared with the mobile node. This is generated by the local mobility anchor after accepting the initial Proxy Binding Update message.
- o A list of IPv6 home network prefixes assigned to the mobile node's connected interface. The home network prefix(es) may have been statically configured in the mobile node's policy profile, or, they may have been dynamically allocated by the local mobility anchor. Each one of these prefix entries will also include the corresponding prefix length.
- o The tunnel interface identifier (tunnel-if-id) of the bi-directional tunnel between the local mobility anchor and the mobile access gateway where the mobile node is currently anchored. This is internal to the local mobility anchor. The tunnel interface identifier is acquired during the tunnel creation.
- o The access technology type, by which the mobile node is currently attached. This is obtained from the Access Technology Type option, present in the Proxy Binding Update message.

- o The 64-bit timestamp value of the most recently accepted Proxy Binding Update message sent for this mobile node. This is the time of day on the local mobility anchor, when the message was received. If the Timestamp option is not present in the Proxy Binding Update message (i.e., when the sequence-number-based scheme is in use), the value MUST be set to ALL_ZERO.

Typically, any one of the mobile node's home network prefixes from its mobility session may be used as a key for locating its Binding Cache entry in all cases except when there has been a handoff of the mobile node's session to a new mobile access gateway, and that mobile access gateway is unaware of the home network prefix(es) assigned to that mobility session. In such handoff cases, the Binding Cache entry can be located under the considerations specified in Section 5.4.1.

5.2. Supported Home Network Prefix Models

This specification supports the Per-MN-Prefix model and does not support the Shared-Prefix model. According to the Per-MN-Prefix model, home network prefix(es) assigned to a mobile node are for that mobile node's exclusive use and no other node shares an address from that prefix (other than the Subnet-Router anycast address [RFC4291] that is used by the mobile access gateway hosting that prefix on that link).

There may be more than one prefix assigned to a given interface of the mobile node; all of those assigned prefixes MUST be unique to that mobile node, and all are part of exactly one mobility session. If the mobile node simultaneously attaches to the Proxy Mobile IPv6 domain through multiple interfaces, each of the attached interfaces MUST be assigned one or more unique prefixes. Prefixes that are not assigned to the same interface MUST NOT be managed under the same mobility session.

The mobile node's home network prefix(es) assigned to a given interface of a mobile node (part of a mobility session) will be hosted on the access link where the mobile node is attached (using that interface). The local mobility anchor is not required to perform any proxy Neighbor Discovery (ND) operations [RFC4861] for defending the mobile node's home address(es), as the prefixes are not locally hosted on the local mobility anchor. However, from the routing perspective, the home network prefix(es) is topologically anchored on the local mobility anchor.

5.3. Signaling Considerations

This section provides the rules for processing the signaling messages. The processing rules specified in this section and other related sections are chained and are in a specific order. When applying these considerations for processing the signaling messages, the specified order MUST be maintained.

5.3.1. Processing Proxy Binding Updates

1. The received Proxy Binding Update message (a Binding Update message with the (P) flag set to value of 1, format specified in Section 8.1) MUST be authenticated as described in Section 4. When IPsec is used for message authentication, the Security Parameter Index (SPI) in the IPsec header [RFC4306] of the received packet is needed for locating the security association, for authenticating the Proxy Binding Update message.
2. The local mobility anchor MUST observe the rules described in Section 9.2 of [RFC3775] when processing the Mobility Header in the received Proxy Binding Update message.
3. The local mobility anchor MUST ignore the check, specified in Section 10.3.1 of [RFC3775], related to the presence of the Home Address destination option in the Proxy Binding Update message.
4. The local mobility anchor MUST identify the mobile node from the identifier present in the Mobile Node Identifier option [RFC4283] of the Proxy Binding Update message. If the Mobile Node Identifier option is not present in the Proxy Binding Update message, the local mobility anchor MUST reject the request and send a Proxy Binding Acknowledgement message with Status field set to MISSING_MN_IDENTIFIER_OPTION (Missing Mobile Node Identifier option) and the identifier in the Mobile Node Identifier option carried in the message MUST be set to a zero length identifier.
5. The local mobility anchor MUST apply the required policy checks, as explained in Section 4, to verify that the sender is a trusted mobile access gateway authorized to send Proxy Binding Update messages on behalf of this mobile node.
6. If the local mobility anchor determines that the requesting node is not authorized to send Proxy Binding Update messages for the identified mobile node, it MUST reject the request and send a Proxy Binding Acknowledgement message with the Status field set to MAG_NOT_AUTHORIZED_FOR_PROXY_REG (not authorized to send proxy binding updates).

7. If the local mobility anchor cannot identify the mobile node based on the identifier present in the Mobile Node Identifier option [RFC4283] of the Proxy Binding Update message, it MUST reject the request and send a Proxy Binding Acknowledgement message with the Status field set to `NOT_LMA_FOR_THIS_MOBILE_NODE` (Not a local mobility anchor for this mobile node).
8. If the local mobility anchor determines that the mobile node is not authorized for the network-based mobility management service, it MUST reject the request and send a Proxy Binding Acknowledgement message with the Status field set to `PROXY_REG_NOT_ENABLED` (Proxy Registration not enabled).
9. The local mobility anchor MUST apply the considerations specified in Section 5.5 for processing the Sequence Number field and the Timestamp option (if present) in the Proxy Binding Update message.
10. If there is no Home Network Prefix option(s) (with any value) present in the Proxy Binding Update message, the local mobility anchor MUST reject the request and send a Proxy Binding Acknowledgement message with the Status field set to `MISSING_HOME_NETWORK_PREFIX_OPTION` (Missing Home Network Prefix option).
11. If the Handoff Indicator option is not present in the Proxy Binding Update message, the local mobility anchor MUST reject the request and send a Proxy Binding Acknowledgement message with the Status field set to `MISSING_HANDOFF_INDICATOR_OPTION` (Missing Handoff Indicator option).
12. If the Access Technology Type option is not present in the Proxy Binding Update message, the local mobility anchor MUST reject the request and send a Proxy Binding Acknowledgement message with the Status field set to `MISSING_ACCESS_TECH_TYPE_OPTION` (Missing Access Technology Type option).
13. Considerations specified in Section 5.4.1 MUST be applied for performing the Binding Cache entry existence test. If those checks specified in Section 5.4.1 result in associating the received Proxy Binding Update message to a new mobility session creation request, considerations from Section 5.3.2 (Initial Binding Registration - New Mobility Session), MUST be applied. If those checks result in associating the request to an existing mobility session, the following checks determine the next set of processing rules that need to be applied.

- * If the received Proxy Binding Update message has the lifetime value of zero, considerations from Section 5.3.5 (Binding De-Registration) MUST be applied.
 - * If the Proxy-CoA in the Binding Cache entry matches the source address of the request (or the address in the Alternate Care-of Address option, if the option is present), considerations from Section 5.3.3 (Binding Lifetime Extension - No handoff) MUST be applied.
 - * For all other cases, considerations from Section 5.3.4 (Binding Lifetime Extension - After handoff) MUST be applied.
14. When sending the Proxy Binding Acknowledgement message with any Status field value, the message MUST be constructed as specified in Section 5.3.6.
- ### 5.3.2. Initial Binding Registration (New Mobility Session)
1. If there is at least one instance of the Home Network Prefix option present in the Proxy Binding Update message with the prefix value set to ALL_ZERO, the local mobility anchor MUST allocate one or more home network prefixes to the mobile node and assign it to the new mobility session created for the mobile node. The local mobility anchor MUST ensure the allocated prefix(es) is not in use by any other node or mobility session. The decision on how many prefixes to be allocated for the attached interface can be based on a global policy or a policy specific to that mobile node. However, when stateful address autoconfiguration using DHCP is supported on the link, considerations from Section 6.11 MUST be applied for the prefix assignment.
 2. If the local mobility anchor is unable to allocate any home network prefix for the mobile node, it MUST reject the request and send a Proxy Binding Acknowledgement message with the Status field set to 130 (Insufficient resources).
 3. If there are one or more Home Network Prefix options present in the Proxy Binding Update message (with each of the prefixes set to a NON_ZERO value), the local mobility anchor, before accepting that request, MUST ensure each one of those prefixes is owned by the local mobility anchor, and further that the mobile node is authorized to use these prefixes. If the mobile node is not authorized to use any one or more of those prefixes, the local mobility anchor MUST reject the request and send a Proxy Binding

Acknowledgement message with the Status field set to NOT_AUTHORIZED_FOR_HOME_NETWORK_PREFIX (mobile node not authorized for one or more of the requesting home network prefixes).

4. Upon accepting the request, the local mobility anchor MUST create a Binding Cache entry for the mobile node. It must set the fields in the Binding Cache entry to the accepted values for that registration.
5. If there is no existing bi-directional tunnel to the mobile access gateway that sent the request, the local mobility anchor MUST establish a bi-directional tunnel to that mobile access gateway. Considerations from Section 5.6.1 MUST be applied for managing the dynamically created bi-directional tunnel.
6. The local mobility anchor MUST create a prefix route(s) over the tunnel to the mobile access gateway for forwarding any traffic received for the mobile node's home network prefix(es) associated with this mobility session. The created tunnel and the routing state MUST result in the forwarding behavior on the local mobility anchor as specified in Section 5.6.2.
7. The local mobility anchor MUST send the Proxy Binding Acknowledgement message with the Status field set to 0 (Proxy Binding Update Accepted). The message MUST be constructed as specified in Section 5.3.6.

5.3.3. Binding Lifetime Extension (No Handoff)

1. Upon accepting the Proxy Binding Update message for extending the binding lifetime, received from the same mobile access gateway (if the Proxy-CoA in the Binding Cache entry is the same as the Proxy-CoA in the request) that last updated the binding, the local mobility anchor MUST update the Binding Cache entry with the accepted registration values.
2. The local mobility anchor MUST send the Proxy Binding Acknowledgement message with the Status field set to 0 (Proxy Binding Update Accepted). The message MUST be constructed as specified in Section 5.3.6.

5.3.4. Binding Lifetime Extension (After Handoff)

1. Upon accepting the Proxy Binding Update message for extending the binding lifetime, received from a new mobile access gateway (if the Proxy-CoA in the Binding Cache entry does not match the Proxy-CoA in the request) where the mobile node's mobility session is handed off, the local mobility anchor MUST update the Binding Cache entry with the accepted registration values.
2. The local mobility anchor MUST remove the previously created route(s) for the mobile node's home network prefix(es) associated with this mobility session. Additionally, if there are no other mobile nodes sharing the dynamically created bi-directional tunnel to the previous mobile access gateway, the tunnel SHOULD be deleted, applying considerations from section 5.6.1 (if the tunnel is a dynamically created tunnel and not a fixed pre-established tunnel).
3. If there is no existing bi-directional tunnel to the mobile access gateway that sent the request, the local mobility anchor MUST establish a bi-directional tunnel to that mobile access gateway. Considerations from Section 5.6.1 MUST be applied for managing the dynamically created bi-directional tunnel.
4. The local mobility anchor MUST create prefix route(s) over the tunnel to the mobile access gateway for forwarding any traffic received for the mobile node's home network prefix(es) associated with that mobility session. The created tunnel and routing state MUST result in the forwarding behavior on the local mobility anchor as specified in Section 5.6.2.
5. The local mobility anchor MUST send the Proxy Binding Acknowledgement message with the Status field set to 0 (Proxy Binding Update Accepted). The message MUST be constructed as specified in Section 5.3.6.

5.3.5. Binding De-Registration

1. If the received Proxy Binding Update message with the lifetime value of zero, has a Source Address in the IPv6 header (or the address in the Alternate Care-of Address option, if the option is present) different from what is present in the Proxy-CoA field in the Binding Cache entry, the local mobility anchor MUST ignore the request.
2. Upon accepting the Proxy Binding Update message, with the lifetime value of zero, the local mobility anchor MUST wait for MinDelayBeforeBCEDelete amount of time, before it deletes the

Binding Cache entry. However, it MUST send the Proxy Binding Acknowledgement message with the Status field set to 0 (Proxy Binding Update Accepted). The message MUST be constructed as specified in Section 5.3.6.

- * During this wait period, the local mobility anchor SHOULD drop the mobile node's data traffic.
- * During this wait period, if the local mobility anchor receives a valid Proxy Binding Update message for the same mobility session with the lifetime value of greater than zero, and if that request is accepted, then the Binding Cache entry MUST NOT be deleted, but must be updated with the newly accepted registration values, and the wait period should be ended.
- * By the end of this wait period, if the local mobility anchor did not receive any valid Proxy Binding Update messages for this mobility session, then it MUST delete the Binding Cache entry and remove the routing state created for that mobility session. The local mobility anchor can potentially reassign the prefix(es) associated with this mobility session to other mobile nodes.

5.3.6. Constructing the Proxy Binding Acknowledgement Message

- o The local mobility anchor, when sending the Proxy Binding Acknowledgement message to the mobile access gateway, MUST construct the message as specified below.

```

IPv6 header (src=LMAA, dst=Proxy-CoA)
  Mobility header
    - BA /* P flag must be set to value of 1 */
  Mobility Options
    - Mobile Node Identifier option          (mandatory)
    - Home Network Prefix option(s)         (mandatory)
    - Handoff Indicator option              (mandatory)
    - Access Technology Type option         (mandatory)
    - Timestamp option                      (optional)
    - Mobile Node Link-layer Identifier option (optional)
    - Link-local Address option             (optional)

```

Figure 6: Proxy Binding Acknowledgement Message Format

- o The Source Address field in the IPv6 header of the message MUST be set to the destination address of the received Proxy Binding Update message.

- o The Destination Address field in the IPv6 header of the message MUST be set to the source address of the received Proxy Binding Update message. When there is no Alternate Care-of Address option present in the request, the destination address is the same as the Proxy-CoA; otherwise, the address may not be the same as the Proxy-CoA.
- o The Mobile Node Identifier option [RFC4283] MUST be present. The identifier field in the option MUST be copied from the Mobile Node Identifier option in the received Proxy Binding Update message. If the option was not present in the request, the identifier in the option MUST be set to a zero length identifier.
- o At least one Home Network Prefix option MUST be present.
 - * If the Status field is set to a value greater than or equal to 128, i.e., if the Proxy Binding Update is rejected, all the Home Network Prefix options that were present in the request (along with their prefix values) MUST be present in the reply. But, if there was no Home Network Prefix option present in the request, then there MUST be only one Home Network Prefix option with the value in the option set to ALL_ZERO.
 - * For all other cases, there MUST be a Home Network Prefix option for each of the assigned home network prefixes (for that mobility session), and with the prefix value in the option set to the allocated prefix value.
- o The Handoff Indicator option MUST be present. The handoff indicator field in the option MUST be copied from the Handoff Indicator option in the received Proxy Binding Update message. If the option was not present in the request, the value in the option MUST be set to zero.
- o The Access Technology Type option MUST be present. The access technology type field in the option MUST be copied from the Access Technology Type option in the received Proxy Binding Update message. If the option was not present in the request, the value in the option MUST be set to zero.
- o The Timestamp option MUST be present only if the same option was present in the received Proxy Binding Update message and MUST NOT be present otherwise. Considerations from Section 5.5 must be applied for constructing the Timestamp option.
- o The Mobile Node Link-layer Identifier option MUST be present only if the same option was present in the received Proxy Binding Update message and MUST NOT be present otherwise. The link-layer

identifier value MUST be copied from the Mobile Node Link-layer Identifier option present in the received Proxy Binding Update message.

- o The Link-local Address option MUST be present only if the same option was present in the received Proxy Binding Update message and MUST NOT be present otherwise. If the Status field in the reply is set to a value greater than or equal to 128, i.e., if the Proxy Binding Update is rejected, then the link-local address from the request MUST be copied to the Link-local Address option in the reply, otherwise the following considerations apply.
 - * If the received Proxy Binding Update message has the Link-local Address option with ALL_ZERO value and if there is an existing Binding Cache entry associated with this request, then the link-local address from the Binding Cache entry MUST be copied to the Link-local Address option in the reply.
 - * If the received Proxy Binding Update message has the Link-local Address option with ALL_ZERO value and if there is no existing Binding Cache entry associated with this request, then the local mobility anchor MUST generate the link-local address that the mobile access gateway can use on the point-to-point link shared with the mobile node. This generated address MUST be copied to the Link-local Address option in the reply. The same address MUST also be copied to the link-local address field of Binding Cache entry created for this mobility session.
 - * If the received Proxy Binding Update message has the Link-local Address option with NON_ZERO value, then the link-local address from the request MUST be copied to the Link-local Address option in the reply. The same address MUST also be copied to the link-local address field of the Binding Cache entry associated with this request (after creating the Binding Cache entry, if one does not exist).
- o If IPsec is used for protecting the signaling messages, the message MUST be protected using the security association existing between the local mobility anchor and the mobile access gateway.
- o Unlike in Mobile IPv6 [RFC3775], the Type 2 Routing header MUST NOT be present in the IPv6 header of the packet.

5.4. Multihoming Support

This specification allows mobile nodes to connect to a Proxy Mobile IPv6 domain through multiple interfaces for simultaneous access. The following are the key aspects of this multihoming support.

- o When a mobile node connects to a Proxy Mobile IPv6 domain through multiple interfaces for simultaneous access, the local mobility anchor MUST allocate a mobility session for each of the attached interfaces. Each mobility session should be managed under a separate Binding Cache entry and with its own lifetime.
- o The local mobility anchor MAY allocate more than one home network prefix for a given interface of the mobile node. However, all the prefixes associated with a given interface MUST be managed as part of one mobility session, associated with that interface.
- o The local mobility anchor MUST allow for a handoff between two different interfaces of a mobile node. In such a scenario, all the home network prefixes associated with one interface (part of one mobility session) will be associated with a different interface of the mobile node. The decision on when to create a new mobility session and when to update an existing mobility session MUST be based on the Handover hint present in the Proxy Binding Update message and under the considerations specified in this section.

5.4.1. Binding Cache Entry Lookup Considerations

There can be multiple Binding Cache entries for a given mobile node. When doing a lookup for a mobile node’s Binding Cache entry for processing a received Proxy Binding Update message, the local mobility anchor MUST apply the following multihoming considerations (in the below specified order, starting with Section 5.4.1.1). These rules are chained with the processing rules specified in Section 5.3.

5.4.1.1. Home Network Prefix Option (NON_ZERO Value) Present in the Request

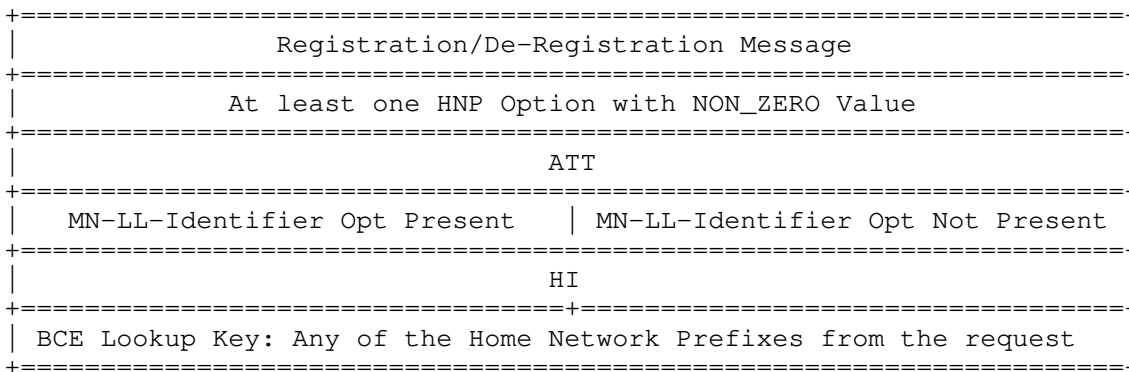

Figure 7: Binding Cache Entry (BCE) Lookup Using Home Network Prefix

If there is at least one Home Network Prefix option present in the request with a NON_ZERO prefix value and irrespective of the presence of the Mobile Node Link-layer Identifier option in the request, the following considerations MUST be applied. If there is more than one instance of the Home Network Prefix option, any one of the Home Network Prefix options present in the request (with NON_ZERO prefix value) can be used for locating the Binding Cache entry.

1. The local mobility anchor MUST verify if there is an existing Binding Cache entry with one of its home network prefixes matching the prefix value in one of the Home Network Prefix options of the received Proxy Binding Update message.
2. If a Binding Cache entry does not exist (with one of its home network prefixes in the Binding Cache entry matching the prefix value in one of the Home Network Prefix options of the received Proxy Binding Update message), the request MUST be considered as a request for creating a new mobility session.
3. If there exists a Binding Cache entry (with one of its home network prefixes in the Binding Cache entry matching the prefix value in one of the Home Network Prefix options of the received Proxy Binding Update message), but if the mobile node identifier in the entry does not match the mobile node identifier in the Mobile Node Identifier option of the received Proxy Binding Update message, the local mobility anchor MUST reject the request with the Status field value set to NOT_AUTHORIZED_FOR_HOME_NETWORK_PREFIX (mobile node is not authorized for one or more of the requesting home network prefixes).
4. If there exists a Binding Cache entry (matching MN-Identifier and one of its home network prefixes in the Binding Cache entry matching the prefix value in one of the Home Network Prefix options of the received Proxy Binding Update message), but if all the prefixes in the request do not match all the prefixes in the Binding Cache entry, or if they do not match in count, then the local mobility anchor MUST reject the request with the Status field value set to BCE_PBU_PREFIX_SET_DO_NOT_MATCH (all the home network prefixes listed in the BCE do not match all the prefixes in the received PBU).
5. If there exists a Binding Cache entry (matching MN-Identifier and all the home network prefixes in the Binding Cache entry matching all the home network prefixes in the received Proxy Binding Update message) and if any one or more of these below stated conditions are true, the request MUST be considered as a request for updating that Binding Cache entry.

- * If there is a Mobile Node Link-layer Identifier option present in the request and if the link-layer identifier in the option matches the link-layer identifier of the Binding Cache entry and the access technology type in the Access Technology Type option present in the request matches the access technology type in the Binding Cache entry.
 - * If the Handoff Indicator field in the Handoff Indicator option present in the request is set to a value of 2 (Handoff between two different interfaces of the mobile node).
 - * If there is no Mobile Node Link-layer Identifier option present in the request, the link-layer identifier value in the Binding Cache entry is set to ALL_ZERO, the access technology type field in the Access Technology Type option present in the request matches the access technology type in the Binding Cache entry, and if the Handoff Indicator field in the Handoff Indicator option present in the request is set to a value of 3 (Handoff between mobile access gateways for the same interface).
 - * If the Proxy-CoA in the Binding Cache entry matches the source address of the request (or the address in the Alternate Care-of Address option, if the option is present) and if the access technology type field in the Access Technology Type option present in the request matches the access technology type in the Binding Cache entry.
6. For all other cases, the message MUST be considered as a request for creating a new mobility session. However, if the received Proxy Binding Update message has the lifetime value of zero and if the request cannot be associated with any existing mobility session, the message MUST be silently ignored.

5.4.1.2. Mobile Node Link-layer Identifier Option Present in the Request

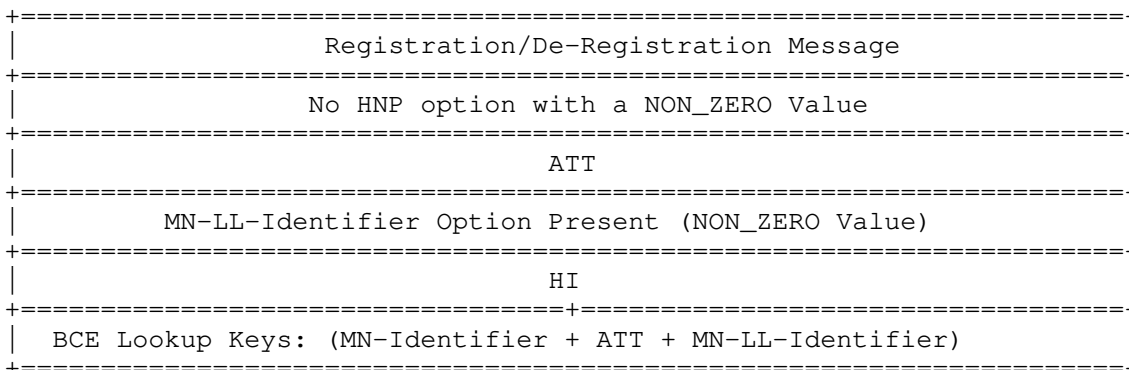

Figure 8: BCE Lookup Using Link-layer Identifier

If there is no Home Network Prefix option present in the request with a NON_ZERO prefix value, but if there is a Mobile Node Link-layer Identifier option present in the request, then the following considerations MUST be applied for locating the Binding Cache entry.

1. The local mobility anchor MUST verify if there is an existing Binding Cache entry, with the mobile node identifier matching the identifier in the received Mobile Node Identifier option, access technology type matching the value in the received Access Technology Type option, and the link-layer identifier value matching the identifier in the received Mobile Node Link-layer Identifier option.
2. If there exists a Binding Cache entry (matching MN-Identifier, Access Technology Type (ATT), and MN-LL-Identifier), the request MUST be considered as a request for updating that Binding Cache entry.
3. If there does not exist a Binding Cache entry (matching MN-Identifier, ATT, and MN-LL-Identifier) and the Handoff Indicator field in the Handoff Indicator option present in the request is set to a value of 2 (Handoff between two different interfaces of the mobile node). The local mobility anchor MUST apply the following additional considerations.
 - * The local mobility anchor MUST verify if there exists one and only one Binding Cache entry with the mobile node identifier matching the identifier in the Mobile Node Identifier option present in the request and for any link-layer identifier

value. If there exists only one such entry (matching the MN-Identifier), the request MUST be considered as a request for updating that Binding Cache entry.

4. If there does not exist a Binding Cache entry (matching MN-Identifier, ATT, and MN-LL-Identifier) and if the Handoff Indicator field in the Handoff Indicator option present in the request is set to a value of 4 (Handoff state unknown), the local mobility anchor MUST apply the following additional considerations.
 - * The local mobility anchor MUST verify if there exists one and only one Binding Cache entry with the mobile node identifier matching the identifier in the Mobile Node Identifier option present in the request and for any link-layer identifier value. If there exists only one such entry (matching the MN-Identifier), the local mobility anchor SHOULD wait until the existing Binding Cache entry is de-registered by the previously serving mobile access gateway, before the request can be considered as a request for updating that Binding Cache entry. However, if there is no de-registration message that is received within MaxDelayBeforeNewBCEAssign amount of time, the local mobility anchor, upon accepting the request, MUST consider the request as a request for creating a new mobility session. The local mobility anchor MAY also choose to create a new mobility session without waiting for a de-registration message, and this should be configurable on the local mobility anchor.
5. For all other cases, the message MUST be considered as a request for creating a new mobility session. However, if the received Proxy Binding Update message has the lifetime value of zero and if the request cannot be associated with any existing mobility session, the message MUST be silently ignored.

5.4.1.3. Mobile Node Link-layer Identifier Option Not Present in the Request

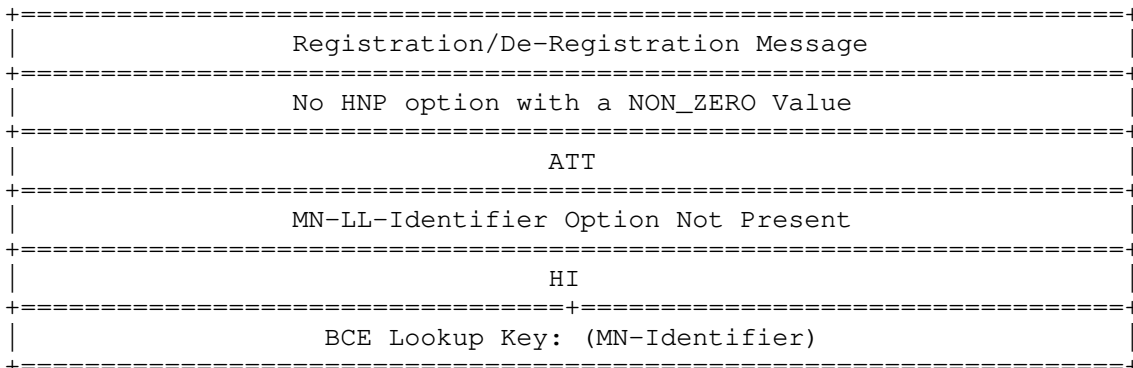

Figure 9: BCE Lookup Using Mobile Node Identifier

If there is no Home Network Prefix option present in the request with a NON_ZERO prefix value and if there is also no Mobile Node Link-layer Identifier option present in the request, then the following considerations MUST be applied for locating the Binding Cache entry.

1. The local mobility anchor MUST verify if there exists one and only one Binding Cache entry with the mobile node identifier matching the identifier in the Mobile Node Identifier option present in the request.
2. If there exists only one such entry (matching the MN-Identifier) and the Handoff Indicator field in the Handoff Indicator option present in the request is set to a value of 2 (Handoff between two different interfaces of the mobile node) or set to a value of 3 (Handoff between mobile access gateways for the same interface), then the request MUST be considered as a request for updating that Binding Cache entry.
3. If there exists only one such entry (matching the MN-Identifier) and the Handoff Indicator field in the Handoff Indicator option present in the request is set to a value of 4 (Handoff state unknown), the local mobility anchor SHOULD wait until the existing Binding Cache entry is de-registered by the previously serving mobile access gateway before the request can be considered as a request for updating that Binding Cache entry. However, if there is no de-registration message that is received within MaxDelayBeforeNewBCEAssign amount of time, the local mobility anchor, upon accepting the request, MUST consider the request as a request for creating a new mobility session. The

local mobility anchor MAY also choose to create a new mobility session without waiting for a de-registration message, and this should be configurable on the local mobility anchor.

4. For all other cases, the message MUST be considered as a request for creating a new mobility session. However, if the received Proxy Binding Update message has the lifetime value of zero and if the request cannot be associated with any existing mobility session, the message MUST be silently ignored.

5.5. Timestamp Option for Message Ordering

Mobile IPv6 [RFC3775] uses the Sequence Number field in binding registration messages as a way for the home agent to process the binding updates in the order they were sent by a mobile node. The home agent and the mobile node are required to manage this counter over the lifetime of a binding. However, in Proxy Mobile IPv6, as the mobile node moves from one mobile access gateway to another and in the absence of mechanisms such as context transfer between the mobile access gateways, the serving mobile access gateway will be unable to determine the sequence number that it needs to use in the signaling messages. Hence, the sequence number scheme, as specified in [RFC3775], will be insufficient for Proxy Mobile IPv6.

If the local mobility anchor cannot determine the sending order of the received Proxy Binding Update messages, it may potentially process an older message sent by a mobile access gateway where the mobile node was previously anchored, but delivered out of order, resulting in incorrectly updating the mobile node's Binding Cache entry and creating a routing state for tunneling the mobile node's traffic to the previous mobile access gateway.

For solving this problem, this specification adopts two alternative solutions. One is based on timestamps and the other based on sequence numbers, as defined in [RFC3775].

The basic principle behind the use of timestamps in binding registration messages is that the node generating the message inserts the current time of day, and the node receiving the message checks that this timestamp is greater than all previously accepted timestamps. The timestamp-based solution may be used when the serving mobile access gateways in a Proxy Mobile IPv6 domain do not have the ability to obtain the last sequence number that was sent in a Proxy Binding Update message for updating a given mobile node's binding.

Clock drift reduces the effectiveness of the timestamp mechanism. The time required for reconnection is the total of the time required for the mobile node to roam between two mobile access gateways and the time required for the serving mobile access gateway to detect the mobile node on its access link and construct the Proxy Binding Update message. If the clock skew on any one of these two neighboring mobile access gateways (relative to the common time source used for clock synchronization) is more than half this reconnection time, the timestamp solution will not predictably work in all cases and hence SHOULD NOT be used.

As an alternative to the Timestamp-based approach, the specification also allows the use of Sequence-Number-based scheme, as specified in [RFC3775]. However, for this scheme to work, the serving mobile access gateway in a Proxy Mobile IPv6 domain MUST have the ability to obtain the last sequence number that was sent in a binding registration message for that mobility session. The sequence number MUST be maintained on a mobile node's per mobility session basis and MUST be available to the serving mobile access gateway. This may be achieved by using context transfer schemes or by maintaining the sequence number in a policy store. However, the specific details on how the mobile node's sequence number is made available to the serving mobile access gateway prior to sending the Proxy Binding Update message is outside the scope of this document.

Using the Timestamp-Based Approach:

1. A local mobility anchor implementation MUST support the Timestamp option. If the Timestamp option is present in the received Proxy Binding Update message, then the local mobility anchor MUST include a valid Timestamp option in the Proxy Binding Acknowledgement message that it sends to the mobile access gateway.
2. All the mobility entities in a Proxy Mobile IPv6 domain that are exchanging binding registration messages using the Timestamp option MUST have adequately synchronized time-of-day clocks. This is the essential requirement for this solution to work. If this requirement is not met, the solution will not predictably work in all cases.
3. The mobility entities in a Proxy Mobile IPv6 domain SHOULD synchronize their clocks to a common time source. For synchronizing the clocks, the nodes MAY use the Network Time Protocol [RFC4330]. Deployments MAY also adopt other approaches suitable for that specific deployment. Alternatively, if there is a mobile node generated timestamp that is increasing at every attachment to the access link and if that timestamp is available

to the mobile access gateway (e.g., the Timestamp option in the SEND [RFC3971] messages that the mobile node sends), the mobile access gateway can use this timestamp or sequence number in the Proxy Binding Update messages and does not have to depend on any external clock source. However, the specific details on how this is achieved are outside the scope of this document.

4. When generating the timestamp value for building the Timestamp option, the mobility entities MUST ensure that the generated timestamp is the elapsed time past the same reference epoch, as specified in the format for the Timestamp option (Section 8.8).
5. If the Timestamp option is present in the received Proxy Binding Update message, the local mobility anchor MUST ignore the sequence number field in the message. However, it MUST copy the sequence number from the received Proxy Binding Update message to the Proxy Binding Acknowledgement message.
6. Upon receipt of a Proxy Binding Update message with the Timestamp option, the local mobility anchor MUST check the timestamp field for validity. In order for it to be considered valid, the following MUST be true.
 - * The timestamp value contained in the Timestamp option MUST be close enough (within TimestampValidityWindow amount of time difference) to the local mobility anchor's time-of-day clock. However, if the flag MobileNodeGeneratedTimestampInUse is set to a value of 1, the local mobility anchor MUST ignore this check and perform only the following check.
 - * The timestamp MUST be greater than all previously accepted timestamps in the Proxy Binding Update messages sent for that mobile node.
7. If the timestamp value in the received Proxy Binding Update is valid (validity as specified in the above considerations) or if the flag MobileNodeGeneratedTimestampInUse is set to value of 1, the local mobility anchor MUST return the same timestamp value in the Timestamp option included in the Proxy Binding Acknowledgement message that it sends to the mobile access gateway.
8. If the timestamp value in the received Proxy Binding Update is lower than the previously accepted timestamp in the Proxy Binding Update messages sent for that mobility binding, the local mobility anchor MUST reject the Proxy Binding Update message and send a Proxy Binding Acknowledgement message with the Status field set to `TIMESTAMP_LOWER_THAN_PREV_ACCEPTED` (Timestamp lower

than previously accepted timestamp). The message MUST also include the Timestamp option with the value set to the current time of day on the local mobility anchor.

9. If the timestamp value in the received Proxy Binding Update is not valid (validity as specified in the above considerations), the local mobility anchor MUST reject the Proxy Binding Update and send a Proxy Binding Acknowledgement message with the Status field set to `TIMESTAMP_MISMATCH` (Timestamp mismatch). The message MUST also include the Timestamp option with the value set to the current time of day on the local mobility anchor.

Using the Sequence-Number-Based Approach:

1. If the Timestamp option is not present in the received Proxy Binding Update message, the local mobility anchor MUST fall back to the Sequence-Number-based scheme. It MUST process the sequence number field as specified in [RFC3775]. Also, it MUST NOT include the Timestamp option in the Proxy Binding Acknowledgement messages that it sends to the mobile access gateway.
2. An implementation MUST support the Sequence-Number-based scheme, as specified in [RFC3775].
3. The Sequence-Number-based approach can be used only when there is some mechanism (such as context transfer procedure between mobile access gateways) that allows the serving mobile access gateway to obtain the last sequence number that was sent in a Proxy Binding Update message for updating a given mobile node's binding.

5.6. Routing Considerations

5.6.1. Bi-Directional Tunnel Management

The bi-directional tunnel MUST be used for routing the mobile node's data traffic between the mobile access gateway and the local mobility anchor. A tunnel hides the topology and enables a mobile node to use address(es) from its home network prefix(es) from any access link in that Proxy Mobile IPv6 domain. A tunnel may be created dynamically when needed and removed when not needed. However, implementations MAY choose to use static pre-established tunnels instead of dynamically creating and tearing them down on a need basis. The following considerations MUST be applied when using dynamically created tunnels.

- o A bi-directional tunnel MUST be established between the local mobility anchor and the mobile access gateway and the local mobility anchor with IPv6-in-IPv6 encapsulation, as described in [RFC2473]. The tunnel endpoints are the Proxy-CoA and LMAA. However, when using IPv4 transport, the endpoints of the tunnel are IPv4-LMAA and IPv4-Proxy-CoA with the encapsulation mode as specified in [IPV4-PMIP6].
- o Implementations MAY use a software timer for managing the tunnel lifetime and a counter for keeping a count of all the mobile nodes that are sharing the tunnel. The timer value can be set to the accepted binding lifetime and can be updated after each periodic re-registration for extending the lifetime. If the tunnel is shared for multiple mobile nodes, the tunnel lifetime must be set to the highest binding lifetime that is granted to any one of those mobile nodes sharing that tunnel.
- o The tunnel SHOULD be deleted when either the tunnel lifetime expires or when there are no mobile nodes sharing the tunnel.

5.6.2. Forwarding Considerations

Intercepting Packets Sent to the Mobile Node's Home Network:

- o When the local mobility anchor is serving a mobile node, it MUST be able to receive packets that are sent to the mobile node's home network. In order for it to receive those packets, it MUST advertise a connected route in to the Routing Infrastructure for the mobile node's home network prefix(es) or for an aggregated prefix with a larger scope. This essentially enables IPv6 routers in that network to detect the local mobility anchor as the last-hop router for the mobile node's home network prefix(es).

Forwarding Packets to the Mobile Node:

- o On receiving a packet from a correspondent node with the destination address matching a mobile node's home network prefix(es), the local mobility anchor MUST forward the packet through the bi-directional tunnel set up for that mobile node.
- o The format of the tunneled packet is shown below. Considerations from [RFC2473] MUST be applied for IPv6 encapsulation. However, when using IPv4 transport, the format of the packet is as described in [IPV4-PMIP6].

```

IPv6 header (src= LMAA, dst= Proxy-CoA /* Tunnel Header */
  IPv6 header (src= CN, dst= MN-HOA ) /* Packet Header */
  Upper layer protocols /* Packet Content*/

```

Figure 10: Tunneled Packet from LMA to MAG

- o The format of the tunneled packet is shown below, when payload protection using IPsec is enabled for the mobile node's data traffic. However, when using IPv4 transport, the format of the packet is as described in [IPV4-PMIP6].

```

IPv6 header (src= LMAA, dst= Proxy-CoA /* Tunnel Header */
  ESP Header in tunnel mode /* ESP Header */
  IPv6 header (src= CN, dst= MN-HoA ) /* Packet Header */
  Upper layer protocols /* Packet Content*/

```

Figure 11: Tunneled Packet from LMA to MAG with Payload Protection

Forwarding Packets Sent by the Mobile Node:

- o All the reverse tunneled packets that the local mobility anchor received from the mobile access gateway, after removing the tunnel header MUST be routed to the destination specified in the inner packet header. These routed packets will have the Source Address field set to the mobile node's home address. Considerations from [RFC2473] MUST be applied for IPv6 decapsulation.

5.6.3. Explicit Congestion Notification (ECN) Considerations for Proxy Mobile IPv6 Tunnels

This section describes how the ECN information needs to be handled by the mobility agents at the tunnel entry and exit points. The ECN considerations for IP tunnels are specified in [RFC3168], and the same considerations apply to Proxy Mobile IPv6 tunnels (using IPv6-in-IPv6 encapsulation mode). Specifically, the full-functionality option MUST be supported. The relevant ECN considerations from [RFC3168] are summarized here for convenience.

Encapsulation Considerations:

- o If the Explicit Congestion Notification (ECN) field in the inner header is set to ECT(0) or ECT(1), where ECT stands for ECN-Capable Transport (ECT), the ECN field from the inner header MUST be copied to the outer header. Additionally, when payload protection using IPsec is enabled for the mobile node's data traffic, the ECN considerations from [RFC4301] MUST be applied.

Decapsulation Considerations:

- o If the Explicit Congestion Notification (ECN) field in the inner header is set to ECT(0) or ECT(1), and if the ECN field in the outer header is set to Congestion Experienced (CE), then the ECN field in the inner header MUST be set to CE. Otherwise, the ECN field in the inner header MUST NOT be modified. Additionally, when payload protection using IPsec is enabled for the mobile node's data traffic, the ECN considerations from [RFC4301] MUST be applied.

5.7. Local Mobility Anchor Address Discovery

Dynamic Home Agent Address Discovery (DHAAD), as explained in Section 10.5 of [RFC3775], allows a mobile node to discover all the home agents on its home link by sending an ICMP Home Agent Address Discovery Request message to the Mobile IPv6 Home Agent's anycast address, derived from its home network prefix.

The DHAAD message in the current form cannot be used in Proxy Mobile IPv6 for discovering the address of the mobile node's local mobility anchor. In Proxy Mobile IPv6, the local mobility anchor will not be able to receive any messages sent to the Mobile IPv6 Home Agent's anycast address corresponding to the mobile node's home network prefix(es), as the prefix(es) is not hosted on any of its interfaces. Further, the mobile access gateway will not predictably be able to locate the serving local mobility anchor that has the mobile node's binding cache entry. Hence, this specification does not support Dynamic Home Agent Address Discovery protocol.

In Proxy Mobile IPv6, the address of the local mobility anchor configured to serve a mobile node can be discovered by the mobility access gateway entity via other means. The LMA to be assigned to a mobile node may be a configured entry in the mobile node's policy profile, or it may be obtained through mechanisms outside the scope of this document.

5.8. Mobile Prefix Discovery Considerations

This specification does not support mobile prefix discovery. The mobile prefix discovery mechanism as specified in [RFC3775] is not applicable to Proxy Mobile IPv6.

5.9. Route Optimization Considerations

The Route Optimization in Mobile IPv6, as defined in [RFC3775], enables a mobile node to communicate with a correspondent node directly using its care-of address and further the Return Routability procedure enables the correspondent node to have reasonable trust that the mobile node is reachable at both its home address and care-of address.

This specification does not support the Route Optimization specified in Mobile IPv6 [RFC3775]. However, this specification does support another form of route optimization, as specified in Section 6.10.3.

6. Mobile Access Gateway Operation

The Proxy Mobile IPv6 protocol described in this document introduces a new functional entity, the mobile access gateway (MAG). The mobile access gateway is the entity that is responsible for detecting the mobile node's movements to and from the access link and sending the Proxy Binding Update messages to the local mobility anchor. In essence, the mobile access gateway performs mobility management on behalf of a mobile node.

The mobile access gateway is a function that typically runs on an access router. However, implementations MAY choose to split this function and run it across multiple systems. The specifics on how that is achieved or the signaling interactions between those functional entities are beyond the scope of this document.

The mobile access gateway has the following key functional roles:

- o It is responsible for detecting the mobile node's movements on the access link and for initiating the mobility signaling with the mobile node's local mobility anchor.
- o Emulation of the mobile node's home link on the access link by sending Router Advertisement messages containing the mobile node's home network prefix(es), each prefix carried using the Prefix Information option [RFC4861].
- o Responsible for setting up the forwarding for enabling the mobile node to configure one or more addresses from its home network prefix(es) and use it from the attached access link.

6.1. Extensions to Binding Update List Entry Data Structure

Every mobile access gateway MUST maintain a Binding Update List. Each entry in the Binding Update List represents a mobile node's mobility binding with its local mobility anchor. The Binding Update List is a conceptual data structure, described in Section 11.1 of [RFC3775].

For supporting this specification, the conceptual Binding Update List entry data structure needs be extended with the following additional fields.

- o The identifier of the attached mobile node, MN-Identifier. This identifier is acquired during the mobile node's attachment to the access link through mechanisms outside the scope of this document.
- o The link-layer identifier of the mobile node's connected interface. This can be acquired from the received Router Solicitation messages from the mobile node or during the mobile node's attachment to the access network. This is typically a link-layer identifier conveyed by the mobile node; however, the specific details on how that is conveyed is out of scope for this specification. If this identifier is not available, this variable length field MUST be set to two (octets) and MUST be initialized to a value of ALL_ZERO.
- o A list of IPv6 home network prefixes assigned to the mobile node's connected interface. The home network prefix(es) may have been statically configured in the mobile node's policy profile, or, may have been dynamically allocated by the local mobility anchor. Each of these prefix entries will also include the corresponding prefix length.
- o The Link-local address of the mobile access gateway on the access link shared with the mobile node.
- o The IPv6 address of the local mobility anchor serving the attached mobile node. This address is acquired from the mobile node's policy profile or from other means.
- o The interface identifier (if-id) of the point-to-point link between the mobile node and the mobile access gateway. This is internal to the mobile access gateway and is used to associate the Proxy Mobile IPv6 tunnel to the access link where the mobile node is attached.

- o The tunnel interface identifier (tunnel-if-id) of the bi-directional tunnel between the mobile node's local mobility anchor and the mobile access gateway. This is internal to the mobile access gateway. The tunnel interface identifier is acquired during the tunnel creation.

6.2. Mobile Node's Policy Profile

A mobile node's policy profile contains the essential operational parameters that are required by the network entities for managing the mobile node's mobility service. These policy profiles are stored in a local or a remote policy store. The mobile access gateway and the local mobility anchor MUST be able to obtain a mobile node's policy profile. The policy profile MAY also be handed over to a serving mobile access gateway as part of a context transfer procedure during a handoff or the serving mobile access gateway MAY be able to dynamically generate this profile. The exact details on how this achieved is outside the scope of this document. However, this specification requires that a mobile access gateway serving a mobile node MUST have access to its policy profile.

The following are the mandatory fields of the policy profile:

- o The mobile node's identifier (MN-Identifier)
- o The IPv6 address of the local mobility anchor (LMAA)

The following are the optional fields of the policy profile:

- o The mobile node's IPv6 home network prefix(es) assigned to the mobile node's connected interface. These prefixes have to be maintained on a per-interface basis. There can be multiple unique entries for each interface of the mobile node. The specific details on how the network maintains this association between the prefix set and the interfaces, specially during the mobility session handoff between interfaces, is outside the scope of this document.
- o The mobile node's IPv6 home network Prefix lifetime. This lifetime will be the same for all the hosted prefixes on the link, as they all are part of one mobility session. This value can also be the same for all the mobile node's mobility sessions.
- o Supported address configuration procedures (Stateful, Stateless, or both) for the mobile node in the Proxy Mobile IPv6 domain

6.3. Supported Access Link Types

This specification supports only point-to-point access link types, and thus, it assumes that the mobile node and the mobile access gateway are the only two nodes on the access link. The link is assumed to have multicast capability.

This protocol may also be used on other link types, as long as the link is configured in such a way that it emulates point-to-point delivery between the mobile node and the mobile access gateway for all the protocol traffic.

It is also necessary to be able to identify mobile nodes attaching to the link. Requirements relating to this are covered in Section 6.6.

Finally, while this specification can operate without link-layer indications of node attachment and detachment to the link, the existence of such indications either on the network or mobile node side improves the resulting performance.

6.4. Supported Address Configuration Modes

A mobile node in the Proxy Mobile IPv6 domain can configure one or more global IPv6 addresses on its interface (using Stateless, Stateful address autoconfiguration procedures or manual address configuration) from the hosted prefix(es) on that link. The Router Advertisement messages sent on the access link specify the address configuration methods permitted on that access link for that mobile node. However, the advertised flags, with respect to the address configuration, will be consistent for a mobile node, on any of the access links in that Proxy Mobile IPv6 domain. Typically, these configuration settings will be based on the domain-wide policy or based on a policy specific to each mobile node.

When stateless address autoconfiguration is supported on the access link, the mobile node can generate one or more IPv6 addresses from the hosted prefix(es) by standard IPv6 mechanisms such as Stateless Autoconfiguration [RFC4862] or Privacy extensions [RFC4941].

When stateful address autoconfiguration is supported on the link, the mobile node can obtain the address configuration from the DHCP server located in the Proxy Mobile IPv6 domain, by standard DHCP mechanisms, as specified in [RFC3315]. The obtained address(es) will be from its home network prefix(es). Section 6.11 specifies the details on how this configuration can be achieved.

Additionally, other address configuration mechanisms specific to the access link between the mobile node and the mobile access gateway may also be used for delivering the address configuration to the mobile node. This specification does not modify the behavior of any of the standard IPv6 address configuration mechanisms.

6.5. Access Authentication and Mobile Node Identification

When a mobile node attaches to an access link connected to the mobile access gateway, the deployed access security protocols on that link SHOULD ensure that the network-based mobility management service is offered only after authenticating and authorizing the mobile node for that service. The exact specifics on how this is achieved or the interactions between the mobile access gateway and the access security service are outside the scope of this document. This specification goes with the stated assumption of having an established trust between the mobile node and the mobile access gateway before the protocol operation begins.

6.6. Acquiring Mobile Node's Identifier

All the network entities in a Proxy Mobile IPv6 domain MUST be able to identify a mobile node, using its MN-Identifier. This identifier MUST be stable and unique across the Proxy Mobile IPv6 domain. The mobility entities in the Proxy Mobile IPv6 domain MUST be able to use this identifier in the signaling messages and unambiguously identify a given mobile node. The following are some of the considerations related to this MN-Identifier.

- o The MN-Identifier is typically obtained as part of the access authentication or from a notified network attachment event. In cases where the user identifier authenticated during access authentication uniquely identifies a mobile node, the MN-Identifier MAY be the same as the user identifier. However, the user identifier MUST NOT be used if it identifies a user account that can be used from more than one mobile node operating in the same Proxy Mobile IPv6 domain.
- o In some cases, the obtained identifier, as part of the access authentication, can be a temporary identifier and further that temporary identifier may be different at each re-authentication. However, the mobile access gateway MUST be able to use this temporary identifier and obtain the mobile node's stable identifier from the policy store. For instance, in AAA-based systems, the Remote Authentication Dial-In User Service (RADIUS) attribute, Chargeable-User-Identifier [RFC4372] may be used, as long as it uniquely identifies a mobile node, and not a user account that can be used with multiple mobile nodes.

- o In some cases and for privacy reasons, the MN-Identifier that the policy store delivers to the mobile access gateway may not be the true identifier of the mobile node. However, the mobility access gateway MUST be able to use this identifier in the signaling messages exchanged with the local mobility anchor.
- o The mobile access gateway MUST be able to identify the mobile node by its MN-Identifier, and it MUST be able to associate this identity to the point-to-point link shared with the mobile node.

6.7. Home Network Emulation

One of the key functions of a mobile access gateway is to emulate the mobile node's home network on the access link. It must ensure the mobile node does not detect any change with respect to its layer-3 attachment even after it changes its point of attachment in that Proxy Mobile IPv6 domain.

For emulating the mobile node's home link on the access link, the mobile access gateway must be able to send Router Advertisement messages advertising the mobile node's home network prefix(es) carried using the Prefix Information option(s) [RFC4861] and with other address configuration parameters consistent with its home link properties. Typically, these configuration settings will be based on the domain-wide policy or based on a policy specific to each mobile node.

Typically, the mobile access gateway learns the mobile node's home network prefix(es) details from the received Proxy Binding Acknowledgement message, or it may obtain them from the mobile node's policy profile. However, the mobile access gateway SHOULD send the Router Advertisements advertising the mobile node's home network prefix(es) only after successfully completing the binding registration with the mobile node's local mobility anchor.

When advertising the home network prefix(es) in the Router Advertisement messages, the mobile access gateway MAY set the prefix lifetime value for the advertised prefix(es) to any chosen value at its own discretion. An implementation MAY choose to tie the prefix lifetime to the mobile node's binding lifetime. The prefix lifetime can also be an optional configuration parameter in the mobile node's policy profile.

6.8. Link-local and Global Address Uniqueness

A mobile node in the Proxy Mobile IPv6 domain, as it moves from one mobile access gateway to the other, will continue to detect its home network and does not detect a change of layer-3 attachment. Every

time the mobile node attaches to a new link, the event related to the interface state change will trigger the mobile node to perform Duplicate Address Detection (DAD) operation on the link-local and global address(es). However, if the mobile node is Detecting Network Attachment in IPv6 (DNAV6) enabled, as specified in [DNAV6], it may not detect the link change due to DNAV6 optimizations and may not trigger the duplicate address detection (DAD) procedure for its existing addresses, which may potentially lead to address collisions after the mobile node's handoff to a new link.

The issue of address collision is not relevant to the mobile node's global address(es). Since the assigned home network prefix(es) are for the mobile node's exclusive usage, no other node shares an address (other than Subnet-Router anycast address that is configured by the mobile access gateway) from the prefix(es), and so the uniqueness for the mobile node's global address is assured on the access link.

The issue of address collision is however relevant to the mobile node's link-local addresses since the mobile access gateway and the mobile node will have link-local addresses configured from the same link-local prefix (FE80::/64). This leaves a room for link-local address collision between the two neighbors (i.e., the mobile node and the mobile access gateway) on that access link. For solving this problem, this specification requires that the link-local address that the mobile access gateway configures on the point-to-point link shared with a given mobile node be generated by the local mobility anchor and be stored in the mobile node's Binding Cache entry. This address will not change for the duration of that mobile node's mobility session and can be provided to the serving mobile access gateway at every mobile node's handoff, as part of the Proxy Mobile IPv6 signaling messages. The specific method by which the local mobility anchor generates the link-local address is out of scope for this specification.

It is highly desirable that the access link on the mobile access gateway shared with the mobile node be provisioned in such a way that before the mobile node completes the DAD operation [RFC4862] on its link-local address, the mobile access gateway on that link is aware of its own link-local address provided by the local mobility anchor that it needs to use on that access link. This essentially requires a successful completion of the Proxy Mobile IPv6 signaling by the mobile access gateway before the mobile node completes the DAD operation. This can be achieved by ensuring that link-layer attachment does not complete until the Proxy Mobile IPv6 signaling is

completed. Alternatively, network and local mobility anchor capacity and signaling retransmission timers can be provisioned in such a way that signaling is likely to complete during the default waiting period associated with the DAD process.

Optionally, implementations MAY choose to configure a fixed link-local address across all the access links in a Proxy Mobile IPv6 domain and without a need for carrying this address from the local mobility anchor to the mobile access gateway in the Proxy Mobile IPv6 signaling messages. The configuration variable `FixedMAGLinkLocalAddressOnAllAccessLinks` determines the enabled mode in that Proxy Mobile IPv6 domain.

6.9. Signaling Considerations

6.9.1. Binding Registrations

6.9.1.1. Mobile Node Attachment and Initial Binding Registration

1. After detecting a new mobile node on its access link, the mobile access gateway MUST identify the mobile node and acquire its MN-Identifier. If it determines that the network-based mobility management service needs to be offered to the mobile node, it MUST send a Proxy Binding Update message to the local mobility anchor.
2. The Proxy Binding Update message MUST include the Mobile Node Identifier option [RFC4283], carrying the MN-Identifier for identifying the mobile node.
3. The Home Network Prefix option(s) MUST be present in the Proxy Binding Update message. If the mobile access gateway learns the mobile node's home network prefix(es) either from its policy store or from other means, the mobile access gateway MAY choose to request the local mobility anchor to allocate the specific prefix(es) by including a Home Network Prefix option for each of those requested prefixes. The mobile access gateway MAY also choose to include just one Home Network Prefix option with the prefix value of `ALL_ZERO`, for requesting the local mobility anchor to do the prefix assignment. However, when including a Home Network Prefix option with the prefix value of `ALL_ZERO`, there MUST be only one instance of the Home Network prefix option in the request.
4. The Handoff Indicator option MUST be present in the Proxy Binding Update message. The Handoff Indicator field in the Handoff Indicator option MUST be set to a value indicating the handoff hint.

- * The Handoff Indicator field MUST be set to a value of 1 (Attachment over a new interface) if the mobile access gateway determines (under the Handoff Indicator considerations specified in this section) that the mobile node's current attachment to the network over this interface is not as a result of a handoff of an existing mobility session (over the same interface or through a different interface), but as a result of an attachment over a new interface. This essentially serves as a request to the local mobility anchor to create a new mobility session and not update any existing Binding Cache entry created for the same mobile node connected to the Proxy Mobile IPv6 domain through a different interface.
 - * The Handoff Indicator field MUST be set to a value of 2 (Handoff between two different interfaces of the mobile node) if the mobile access gateway definitively knows the mobile node's current attachment is due to a handoff of an existing mobility session between two different interfaces of the mobile node.
 - * The Handoff Indicator field MUST be set to a value of 3 (Handoff between mobile access gateways for the same interface) if the mobile access gateway definitively knows the mobile node's current attachment is due to a handoff of an existing mobility session between two mobile access gateways and for the same interface of the mobile node.
 - * The Handoff Indicator field MUST be set to a value of 4 (Handoff state unknown) if the mobile access gateway cannot determine if the mobile node's current attachment is due to a handoff of an existing mobility session.
5. The mobile access gateway MUST apply the below considerations when choosing the value for the Handoff Indicator field.
- * The mobile access gateway can choose to use the value 2 (Handoff between two different interfaces of the mobile node), only when it knows that the mobile node has, on purpose, switched from one interface to another, and the previous interface is going to be disabled. It may know this due to a number of factors. For instance, most cellular networks have controlled handovers where the network knows that the host is moving from one attachment to another. In this situation, the link-layer mechanism can inform the mobility functions that this is indeed a movement, not a new attachment.

- * Some link layers have link-layer identifiers that can be used to distinguish (a) the movement of a particular interface to a new attachment from (b) the attachment of a new interface from the same host. Option value 3 (Handoff between mobile access gateways for the same interface) is appropriate in case (a) and a value of 1 (Attachment over a new interface) in case (b).
 - * The mobile access gateway MUST NOT set the option value to 2 (Handoff between two different interfaces of the mobile node) or 3 (Handoff between mobile access gateways for the same interface) if it cannot be determined that the mobile node can move the address between the interfaces involved in the handover or that it is the same interface that has moved. Otherwise, Proxy Mobile IPv6-unaware hosts that have multiple physical interfaces to the same domain may suffer unexpected failures.
 - * Where no support from the link layer exists, the host and the network would need to inform each other about the intended movement. The Proxy Mobile IPv6 protocol does not specify this and simply requires that knowledge about movements can be derived either from the link-layer or from somewhere else. The method by which this is accomplished is outside the scope of this specification.
6. Either the Timestamp option or a valid sequence number maintained on a per mobile node's mobility session basis as specified in [RFC3775] (if the Sequence-Number-based scheme is in use) MUST be present. This can be determined based on the value of the configuration flag `TimestampBasedApproachInUse`. When Timestamp option is added to the message, the mobile access gateway SHOULD also set the Sequence Number field to a value of a monotonically increasing counter (maintained at each mobile access gateway and not to be confused with the per mobile node sequence number specified in [RFC3775]). The local mobility anchor will ignore this field when there is a Timestamp option present in the request, but will return the same value in the Proxy Binding Acknowledgement message. This will be useful for matching the reply to the request message.
 7. The Mobile Node Link-layer Identifier option carrying the link-layer identifier of the currently attached interface MUST be present in the Proxy Binding Update message, if the mobile access gateway is aware of the same. If the link-layer identifier of the currently attached interface is not known or if the identifier value is `ALL_ZERO`, this option MUST NOT be present.

8. The Access Technology Type option MUST be present in the Proxy Binding Update message. The access technology type field in the option SHOULD be set to the type of access technology by which the mobile node is currently attached to the mobile access gateway.
9. The Link-local Address option MUST be present in the Proxy Binding Update message only if the value of the configuration variable FixedMAGLinkLocalAddressOnAllAccessLinks is set to a value of ALL_ZERO; otherwise, the Link-local Address option MUST NOT be present in the request. Considerations from Section 6.8 MUST be applied when using the Link-local Address option.
 - * For querying the local mobility anchor to provide the link-local address that it should use on the point-to-point link shared with the mobile node, this option MUST be set to ALL_ZERO value. This essentially serves as a request to the local mobility anchor to provide the link-local address that it can use on the access link shared with the mobile node.
10. The Proxy Binding Update message MUST be constructed as specified in Section 6.9.1.5.
11. If there is no existing Binding Update List entry for that mobile node, the mobile access gateway MUST create a Binding Update List entry for the mobile node upon sending the Proxy Binding Update message.

6.9.1.2. Receiving Proxy Binding Acknowledgement

On receiving a Proxy Binding Acknowledgement message (format specified in Section 8.2) from the local mobility anchor, the mobile access gateway MUST process the message as specified below.

1. The received Proxy Binding Acknowledgement message (a Binding Acknowledgement message with the (P) flag set to value of 1) MUST be authenticated as described in Section 4. When IPsec is used for message authentication, the SPI in the IPsec header [RFC4306] of the received packet is needed for locating the security association, for authenticating the Proxy Binding Acknowledgement message.
2. The mobile access gateway MUST observe the rules described in Section 9.2 of [RFC3775] when processing Mobility Headers in the received Proxy Binding Acknowledgement message.

3. The mobile access gateway MUST apply the considerations specified in Section 5.5 for processing the Sequence Number field and the Timestamp option (if present) in the message.
4. The mobile access gateway MUST ignore any checks, specified in [RFC3775], related to the presence of a Type 2 Routing header in the Proxy Binding Acknowledgement message.
5. The mobile access gateway MAY use the mobile node identifier present in the Mobile Node Identifier option for matching the response to the request messages that it sent recently. However, if there is more than one request message in its request queue for the same mobile node, the sequence number field can be used for identifying the exact message from those messages. There are other ways to achieve this and implementations are free to adopt the best approach that suits their implementation. Additionally, if the received Proxy Binding Acknowledgement message does not match any of the Proxy Binding Update messages that it sent recently, the message MUST be ignored.
6. If the received Proxy Binding Acknowledgement message has any one or more of the following options, Handoff Indicator option, Access Technology Type option, Mobile Node Link-layer Identifier option, Mobile Node Identifier option, carrying option values that are different from the option values present in the corresponding request (Proxy Binding Update) message, the message MUST be ignored as the local mobility anchor is expected to echo back all these listed options and with the same option values in the reply message. In this case, the mobile access gateway MUST NOT retransmit the Proxy Binding Update message until an administrative action is taken.
7. If the received Proxy Binding Acknowledgement message has the Status field value set to PROXY_REG_NOT_ENABLED (Proxy registration not enabled for the mobile node), the mobile access gateway SHOULD NOT send a Proxy Binding Update message again for that mobile node until an administrative action is taken. It MUST deny the mobility service to that mobile node.
8. If the received Proxy Binding Acknowledgement message has the Status field value set to TIMESTAMP_LOWER_THAN_PREV_ACCEPTED (Timestamp value lower than previously accepted value), the mobile access gateway SHOULD try to register again to reassert the mobile node's presence on its access link. The mobile access gateway is not specifically required to synchronize its clock upon receiving this error code.

9. If the received Proxy Binding Acknowledgement message has the Status field value set to `TIMESTAMP_MISMATCH` (Invalid timestamp value), the mobile access gateway **SHOULD** try to register again only after it has synchronized its clock to a common time source that is used by all the mobility entities in that domain for their clock synchronization. The mobile access gateway **SHOULD** **NOT** synchronize its clock to the local mobility anchor's system clock, based on the timestamp present in the received message.
10. If the received Proxy Binding Acknowledgement message has the Status field value set to `NOT_AUTHORIZED_FOR_HOME_NETWORK_PREFIX` (The mobile node is not authorized for one or more of the requesting home network prefixes), the mobile access gateway **SHOULD** **NOT** request the same prefix(es) again, but **MAY** request the local mobility anchor to do the assignment of prefix(es) by including only one Home Network Prefix option with the prefix value set to `ALL_ZERO`.
11. If the received Proxy Binding Acknowledgement message has the Status field value set to any value greater than or equal to 128 (i.e., if the binding is rejected), the mobile access gateway **MUST** **NOT** advertise the mobile node's home network prefix(es) in the Router Advertisement messages sent on that access link and **MUST** deny the mobility service to the mobile node by not forwarding any packets received from the mobile node using an address from the home network prefix(es). It **MAY** also tear down the point-to-point link shared with the mobile node.
12. If the received Proxy Binding Acknowledgement message has the Status field value set to 0 (Proxy Binding Update accepted), the mobile access gateway **MUST** establish a bi-directional tunnel to the local mobility anchor (if there is no existing bi-directional tunnel to that local mobility anchor). Considerations from Section 5.6.1 **MUST** be applied for managing the dynamically created bi-directional tunnel.
13. The mobile access gateway **MUST** set up the route for forwarding the packets received from the mobile node using address(es) from its home network prefix(es) through the bi-directional setup for that mobile node. The created tunnel and the routing state **MUST** result in the forwarding behavior on the mobile access gateway as specified in Section 6.10.5.
14. The mobile access gateway **MUST** also update the Binding Update List entry to reflect the accepted binding registration values. It **MUST** also advertise the mobile node's home network prefix(es) as the hosted on-link prefixes, by including them in the Router Advertisement messages that it sends on that access link.

15. If the received Proxy Binding Acknowledgement message has the address in the Link-local Address option set to a NON_ZERO value, the mobile access gateway SHOULD configure that link-local address on that point-to-point link and SHOULD NOT configure any other link-local address without performing a DAD operation [RFC4862]. This will avoid any potential link-local address collisions on that access link. However, if the link-local address generated by the local mobility anchor happens to be already in use by the mobile node on that link, the mobile access gateway MUST NOT use that address, but SHOULD configure a different link-local address. It SHOULD also upload this link-local address to the local mobility anchor by immediately sending a Proxy Binding Update message and by including this address in the Link-local Address option.

6.9.1.3. Extending Binding Lifetime

1. For extending the lifetime of a currently registered mobile node (i.e., after a successful initial binding registration from the same mobile access gateway), the mobile access gateway can send a Proxy Binding Update message to the local mobility anchor with a new lifetime value. This re-registration message MUST be constructed with the same set of options as the initial Proxy Binding Update message, under the considerations specified in Section 6.9.1.1. However, the following exceptions apply.
2. There MUST be a Home Network Prefix option for each of the assigned home network prefixes assigned for that mobility session and with the prefix value in the option set to that respective prefix value.
3. The Handoff Indicator field in the Handoff Indicator option MUST be set to a value of 5 (Handoff state not changed - Re-Registration).

6.9.1.4. Mobile Node Detachment and Binding De-Registration

1. If at any point the mobile access gateway detects that the mobile node has moved away from its access link, or if it decides to terminate the mobile node's mobility session, it SHOULD send a Proxy Binding Update message to the local mobility anchor with the lifetime value set to zero. This de-registration message MUST be constructed with the same set of options as the initial Proxy Binding Update message, under the considerations specified in Section 6.9.1.1. However, the following exceptions apply.

2. There MUST be a Home Network Prefix option for each of the assigned home network prefixes assigned for that mobility session and with the prefix value in the option set to the respective prefix value.
3. The Handoff Indicator field in the Handoff Indicator option MUST be set to a value of 4 (Handoff state unknown).

Either upon receipt of a Proxy Binding Acknowledgement message from the local mobility anchor with the Status field set to 0 (Proxy Binding Update Accepted), or after INITIAL_BINDACK_TIMEOUT [RFC3775] timeout waiting for the reply, the mobile access gateway MUST do the following:

1. It MUST remove the Binding Update List entry for the mobile node from its Binding Update List.
2. It MUST remove the created routing state for tunneling the mobile node's traffic.
3. If there is a dynamically created tunnel to the mobile node's local mobility anchor and if there are not other mobile nodes for which the tunnel is being used, then the tunnel MUST be deleted.
4. It MUST tear down the point-to-point link shared with the mobile node. This action will force the mobile node to remove any IPv6 address configuration on the interface connected to this point-to-point link.

6.9.1.5. Constructing the Proxy Binding Update Message

- o The mobile access gateway, when sending the Proxy Binding Update message to the local mobility anchor, MUST construct the message as specified below.

```

IPv6 header (src=Proxy-CoA, dst=LMAA)
  Mobility header
    - BU /* P & A flags MUST be set to value 1 */
  Mobility Options
    - Mobile Node Identifier option           (mandatory)
    - Home Network Prefix option(s)          (mandatory)
    - Handoff Indicator option                (mandatory)
    - Access Technology Type option           (mandatory)
    - Timestamp option                        (optional)
    - Mobile Node Link-layer Identifier option (optional)
    - Link-local Address option               (optional)

```

Figure 12: Proxy Binding Update Message Format

- o The Source Address field in the IPv6 header of the message MUST be set to the global address configured on the egress interface of the mobile access gateway. When there is no Alternate Care-of Address option present in the request, this address will be considered as the Proxy-CoA for this Proxy Binding Update message. However, when there is an Alternate Care-of Address option present in the request, this address will not be considered as the Proxy-CoA, but the address in the Alternate Care-of Address option will be considered as the Proxy-CoA.
- o The Destination Address field in the IPv6 header of the message MUST be set to the local mobility anchor address.
- o The Mobile Node Identifier option [RFC4283] MUST be present.
- o At least one Home Network Prefix option MUST be present.
- o The Handoff Indicator option MUST be present.
- o The Access Technology Type option MUST be present.
- o The Timestamp option MAY be present.
- o The Mobile Node Link-layer Identifier option MAY be present.
- o The Link-local Address option MAY be present.
- o If IPsec is used for protecting the signaling messages, the message MUST be protected, using the security association existing between the local mobility anchor and the mobile access gateway.
- o Unlike in Mobile IPv6 [RFC3775], the Home Address option [RFC3775] MUST NOT be present in the IPv6 Destination Options extension header of the Proxy Binding Update message.

6.9.2. Router Solicitation Messages

A mobile node may send a Router Solicitation message on the access link shared with the mobile access gateway. The Router Solicitation message that the mobile node sends is as specified in [RFC4861]. The mobile access gateway, on receiving the Router Solicitation message or before sending a Router Advertisement message, MUST apply the following considerations.

1. The mobile access gateway, on receiving the Router Solicitation message, SHOULD send a Router Advertisement message containing the mobile node's home network prefix(es) as the on-link prefix(es). However, before sending the Router Advertisement

message containing the mobile node's home network prefix(es), it SHOULD complete the binding registration process with the mobile node's local mobility anchor.

2. If the local mobility anchor rejects the Proxy Binding Update message, or, if the mobile access gateway failed to complete the binding registration process for whatever reason, the mobile access gateway MUST NOT advertise the mobile node's home network prefix(es) in the Router Advertisement messages that it sends on the access link. However, it MAY choose to advertise a local visited network prefix to enable the mobile node for regular IPv6 access.
3. The mobile access gateway SHOULD add the MTU option, as specified in [RFC4861], to the Router Advertisement messages that it sends on the access link. This will ensure the mobile node on the link uses the advertised MTU value. The MTU value SHOULD reflect the tunnel MTU for the bi-directional tunnel between the mobile access gateway and the local mobility anchor. Considerations from Section 6.9.5 SHOULD be applied for determining the tunnel MTU value.

6.9.3. Default-Router

In Proxy Mobile IPv6, the mobile access gateway is the IPv6 default-router for the mobile node on the access link. However, as the mobile node moves from one access link to another, the serving mobile access gateway on those respective links will send the Router Advertisement messages. If these Router Advertisements are sent using a different link-local address or a different link-layer address, the mobile node will always detect a new default-router after every handoff. For solving this problem, this specification requires all the mobile access gateways in the Proxy Mobile IPv6 domain to use the same link-local and link-layer address on any of the access links wherever the mobile node attaches. These addresses can be fixed addresses across the entire Proxy Mobile IPv6 domain, and all the mobile access gateways can use these globally fixed address on any of the point-to-point links. The configuration variables FixedMAGLinkLocalAddressOnAllAccessLinks and FixedMAGLinkLayerAddressOnAllAccessLinks SHOULD be used for this purpose. Additionally, this specification allows the local mobility anchor to generate the link-local address and provide it to the mobile access gateway as part of the signaling messages.

However, both of these approaches (a link-local address generated by the local mobility anchor or when using a globally fixed link-local address) have implications on the deployment of SEcure Neighbor Discovery (SEND) [RFC3971]. In SEND, routers have certificates and

public key pairs, and their Router Advertisements are signed with the private keys of these key pairs. When a number of different routers use the same addresses, the routers either all have to be able to construct these signatures for the same key pair, or the used key pair and the router's cryptographic identity must change after a movement. Both approaches are problematic. Sharing of private key information across multiple nodes in a PMIPv6 domain is poor design from a security perspective. And changing even the cryptographic identity of the router goes against the general idea of the Proxy Mobile IPv6 being as invisible to the hosts as possible.

There is, however, ongoing work in the IETF to revise the SEND specifications. It is suggested that these revisions also address the above problem. Other revisions are needed to deal with other problematic cases (such as Neighbor Discovery proxies) before wide-spread deployment of SEND.

6.9.4. Retransmissions and Rate Limiting

The mobile access gateway is responsible for retransmissions and rate limiting the Proxy Binding Update messages that it sends to the local mobility anchor. The Retransmission and the Rate Limiting rules are as specified in [RFC3775]. However, the following considerations MUST be applied.

1. When the mobile access gateway sends a Proxy Binding Update message, it should use the constant, INITIAL_BINDACK_TIMEOUT [RFC3775], for configuring the retransmission timer, as specified in Section 11.8 [RFC3775]. However, the mobile access gateway is not required to use a longer retransmission interval of InitialBindackTimeoutFirstReg, as specified in [RFC3775], for the initial Proxy Binding Update message.
2. If the mobile access gateway fails to receive a valid matching response for a registration or re-registration message within the retransmission interval, it SHOULD retransmit the message until a response is received. However, the mobile access gateway MUST ensure the mobile node is still attached to the connected link before retransmitting the message.
3. As specified in Section 11.8 of [RFC3775], the mobile access gateway MUST use an exponential back-off process in which the timeout period is doubled upon each retransmission, until either the node receives a response or the timeout period reaches the value MAX_BINDACK_TIMEOUT [RFC3775]. The mobile access gateway MAY continue to send these messages at this slower rate indefinitely.

4. If the Timestamp-based scheme is in use, the retransmitted Proxy Binding Update messages MUST use the latest timestamp. If the Sequence Number scheme is in use, the retransmitted Proxy Binding Update messages MUST use a Sequence Number value greater than that was used for the previous transmission of this Proxy Binding Update message, just as specified in [RFC3775].

6.9.5. Path MTU Discovery

It is important that mobile node, mobile access gateway, and local mobility anchor have a correct understanding of MTUs. When the mobile node uses the correct MTU, it can send packets that do not exceed the local link MTU and do not cause the tunneled packets from the mobile access gateway to be fragmented. This is important both from the perspective of efficiency, as well as preventing hard-to-diagnose MTU problems. The following are some of the considerations related to Path MTU discovery.

- o The local mobility anchor and mobile access gateway MAY use the Path MTU discovery mechanisms, as specified in [RFC1981] or in [RFC4821], for determining the Path MTU (PMTU) for the (LMA-MAG) paths. The specific discovery mechanism to be used in a given deployment can be configurable.
- o The mobility entities MUST implement and SHOULD support ICMP-based Path MTU discovery mechanism, as specified in [RFC1981]. However, this mechanism may not work correctly if the Proxy Mobile IPv6 network does not deliver or process ICMP Packet Too Big messages.
- o The mobility entities MAY implement Packetization Layer Path MTU discovery mechanisms, as specified in [RFC4821], and use any application traffic as a payload for the PMTU discovery. Neither the Proxy Mobile IPv6 protocol or the tunnel between the mobile access gateway and local mobility agent can easily be used for this purpose. However, implementations SHOULD support at least the use of an explicit ICMP Echo Request/Response for this purpose.
- o The mobility entities MAY choose to perform Path MTU discovery for all the (LMA-MAG) paths at the boot time and may repeat this operation periodically to ensure the Path MTU values have not changed for those paths. If the dynamic PMTU discovery mechanisms fail to determine the Path MTU, an administratively configured default value MUST be used.

- o The IPv6 tunnel MTU for an established tunnel between the local mobility anchor and the mobile access gateway MUST be computed based on the determined Path MTU value for that specific path and the computation should be as specified in Section 6.7 of [RFC2473].
- o The mobile access gateway SHOULD use the determined tunnel Path MTU value (for the tunnel established with the mobile node's local mobility anchor) as the MTU value in the MTU option that it sends in the Router Advertisements on the access link shared with the mobile node. But, if the MTU value of the access link shared with the mobile node is lower than the determined Path MTU value, then the MTU of the access link MUST be used in the MTU option.
- o If the mobile access gateway detects a change in the MTU value for any of the paths (LMA-MAG) and at any point of time, the corresponding tunnel MTU value MUST be updated to reflect the change in Path MTU value. The adjusted tunnel MTU value (lower of the Path MTU and the access link MTU) SHOULD be notified to the impacted mobile nodes by sending additional Router Advertisement messages. Additionally, the adjusted tunnel MTU value MUST be used in all the subsequent Router Advertisement messages as well.

6.10. Routing Considerations

This section describes how the mobile access gateway handles the traffic to/from the mobile node that is attached to one of its access interfaces.

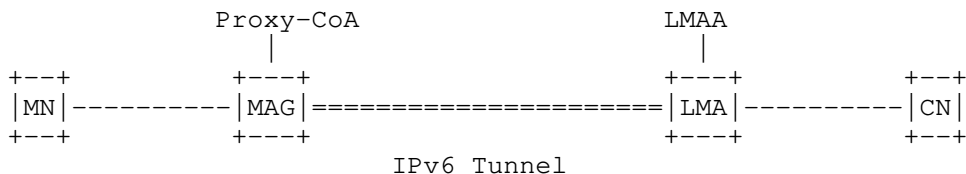

Figure 13: Proxy Mobile IPv6 Tunnel

6.10.1. Transport Network

As per this specification, the transport network between the local mobility anchor and the mobile access gateway is an IPv6 network. The document [IPV4-PMIP6] specifies the required extensions for negotiating IPv4 transport and the corresponding encapsulation mode.

6.10.2. Tunneling and Encapsulation Modes

An IPv6 address that a mobile node uses from its home network prefix(es) is topologically anchored at the local mobility anchor. For a mobile node to use this address from an access network attached to a mobile access gateway, proper tunneling techniques have to be in place. Tunneling hides the network topology and allows the mobile node's IPv6 datagram to be encapsulated as a payload of another IPv6 packet and to be routed between the local mobility anchor and the mobile access gateway. The Mobile IPv6 base specification [RFC3775] defines the use of IPv6-over-IPv6 tunneling [RFC2473] between the home agent and the mobile node, and this specification extends the use of the same tunneling mechanism for use between the local mobility anchor and the mobile access gateway.

On most operating systems, a tunnel is implemented as a virtual point-to-point interface. The source and the destination address of the two endpoints of this virtual interface along with the encapsulation mode are specified for this virtual interface. Any packet that is routed over this interface gets encapsulated with the outer header as specified for that point-to-point tunnel interface.

For creating a point-to-point tunnel to any local mobility anchor, the mobile access gateway may implement a tunnel interface with the Source Address field set to a global address on its egress interface (Proxy-CoA) and the destination address field set to the global address of the local mobility anchor (LMAA).

The following is the supported packet encapsulation mode that can be used by the mobile access gateway and the local mobility anchor for routing mobile node's IPv6 datagrams.

- o IPv6-In-IPv6 - IPv6 datagram encapsulated in an IPv6 packet [RFC2473].

The companion document [IPV4-PMIP6] specifies other encapsulation modes for supporting IPv4 transport.

- o IPv6-In-IPv4 - IPv6 datagram encapsulation in an IPv4 packet. The details on how this mode is negotiated are specified in [IPV4-PMIP6].
- o IPv6-In-IPv4-UDP - IPv6 datagram encapsulation in an IPv4 UDP packet. This mode is specified in [IPV4-PMIP6].
- o IPv6-In-IPv4-UDP-TLV - IPv6 datagram encapsulation in an IPv4 UDP packet with a TLV header. This mode is specified in [IPV4-PMIP6].

6.10.3. Local Routing

If there is data traffic between a visiting mobile node and a correspondent node that is locally attached to an access link connected to the mobile access gateway, the mobile access gateway MAY optimize on the delivery efforts by locally routing the packets and by not reverse tunneling them to the mobile node's local mobility anchor. The flag EnableMAGLocalRouting MAY be used for controlling this behavior. However, in some systems, this may have an implication on the mobile node's accounting and policy enforcement as the local mobility anchor is not in the path for that traffic and it will not be able to apply any traffic policies or do any accounting for those flows.

This decision of path optimization SHOULD be based on the policy configured on the mobile access gateway, but enforced by the mobile node's local mobility anchor. The specific details on how this is achieved are beyond of the scope of this document.

6.10.4. Tunnel Management

All the considerations mentioned in Section 5.6.1 for the tunnel management on the local mobility anchor apply for the mobile access gateway as well.

6.10.5. Forwarding Rules

Forwarding Packets Sent to the Mobile Node's Home Network:

- o On receiving a packet from the bi-directional tunnel established with the mobile node's local mobility anchor, the mobile access gateway MUST use the destination address of the inner packet for forwarding it on the interface where the destination network prefix is hosted. The mobile access gateway MUST remove the outer header before forwarding the packet. Considerations from [RFC2473] MUST be applied for IPv6 decapsulation. If the mobile access gateway cannot find the connected interface for that destination address, it MUST silently drop the packet. For reporting an error in such a scenario, in the form of an ICMP control message, the considerations from [RFC2473] MUST be applied.
- o On receiving a packet from a correspondent node that is connected to the mobile access gateway as a regular IPv6 host (see Section 6.14) destined to a mobile node that is also locally attached, the mobile access gateway MUST check the flag EnableMAGLocalRouting to determine if the packet can be delivered directly to the mobile node. If the mobile access gateway is not allowed to route the

packet directly, it MUST route the packet towards the local mobility anchor where the destination address is topologically anchored, else it can route the packet directly to the mobile node.

Forwarding Packets Sent by the Mobile Node:

- o On receiving a packet from a mobile node connected to its access link, the mobile access gateway MUST ensure that there is an established binding for that mobile node with its local mobility anchor before forwarding the packet directly to the destination or before tunneling the packet to the mobile node's local mobility anchor.
- o On receiving a packet from a mobile node connected to its access link for a destination that is locally connected, the mobile access gateway MUST check the flag EnableMAGLocalRouting, to ensure the mobile access gateway is allowed to route the packet directly to the destination. If the mobile access gateway is not allowed to route the packet directly, it MUST route the packet through the bi-directional tunnel established between itself and the mobile node's local mobility anchor. Otherwise, it MUST route the packet directly to the destination.
- o On receiving a packet from a mobile node connected to its access link, to a destination that is not directly connected, the packet MUST be forwarded to the local mobility anchor through the bi-directional tunnel established between itself and the mobile node's local mobility anchor. However, the packets that are sent with the link-local source address MUST NOT be forwarded.
- o The format of the tunneled packet is shown below. Considerations from [RFC2473] MUST be applied for IPv6 encapsulation. However, when using IPv4 transport, the format of the tunneled packet is as described in [IPV4-PMIP6].

```

IPv6 header (src= Proxy-CoA, dst= LMAA /* Tunnel Header */
  IPv6 header (src= MN-HoA, dst= CN ) /* Packet Header */
  Upper layer protocols /* Packet Content*/

```

Figure 14: Tunneled Packet from MAG to LMA

- o The format of the tunneled packet is shown below, when payload protection using IPsec is enabled for the mobile node's data traffic. However, when using IPv4 transport, the format of the packet is as described in [IPV4-PMIP6].

```

IPv6 header (src= Proxy-CoA, dst= LMAA      /* Tunnel Header */
  ESP Header in tunnel mode                /* ESP Header */
  IPv6 header (src= MN-HoA, dst= CN )      /* Packet Header */
  Upper layer protocols                    /* Packet Content*/

```

Figure 15: Tunneled Packet from MAG to LMA with Payload Protection

6.11. Supporting DHCP-Based Address Configuration on the Access Link

This section explains how Stateful Address Configuration using DHCP support can be enabled in a Proxy Mobile IPv6 domain. It also identifies the required configuration in DHCP and mobility infrastructures for supporting this address configuration mode and also identifies the protocol interactions between these two systems.

- o For supporting Stateful Address Configuration using DHCP, the DHCP relay agent [RFC3315] service MUST be supported on all the mobile access gateways in the Proxy Mobile IPv6 domain. Further, as specified in Section 20 of [RFC3315], the DHCP relay agent should be configured to use a list of destination addresses, which MAY include unicast addresses, the All_DHCP_Servers multicast address, or other addresses as required in a given deployment.
- o The DHCP infrastructure needs to be configured to assign addresses from each of the prefixes assigned to a link in that Proxy Mobile IPv6 domain. The DHCP relay agent indicates the link to which the mobile node is attached by including an IPv6 address from any of the prefixes assigned to that link in the link-address field of the Relay Forward message. Therefore, for each link in the Mobile IPv6 domain, the DHCP infrastructure will:
 - * be configured with a list of all of the prefixes associated with that link;
 - * identify the link to which the mobile node is attached by looking up the prefix for the link-address field in the Relay Forward message in the list of prefixes associated with each link;
 - * assign to the host an address from each prefix associated with the link to which the mobile node is attached.

This DHCP infrastructure configuration requirement is identical to other IPv6 networks; other than receiving DHCP messages from a mobile node through different relay agents (MAGs) over time, the DHCP infrastructure will be unaware of the mobile node's capability with respect to mobility support.

- o The local mobility anchor needs to have the same awareness with respect to the links along with the associated prefixes in a Proxy Mobile IPv6 domain. When a local mobility anchor assigns prefix(es) to a mobile node, it MUST assign all the prefixes associated with a given link and all of those assigned prefixes will remain as the home network prefixes for that mobile node throughout the life of that mobility session. The serving mobile access gateway that hosts these prefixes is physically connected to that link and can function as the DHCP relay agent. This common understanding between DHCP and mobility entities about all the links in the domain along with the associated prefixes provides the required coordination for allowing mobility entities to perform prefix assignment dynamically to a mobile node and still allow the DHCP infrastructure to perform address assignment for that mobile node only from its home network prefixes.
- o When a mobile node sends a DHCP request message, the DHCP relay agent function on the mobile access gateway will set the link-address field in the DHCP message to an address in the mobile node's home network prefix (any one of the mobile node's home network prefixes assigned to that mobile node's attached interface). The mobile access gateway can generate an autoconfiguration address from one of the mobile node's home network prefixes [RFC4862] and can use this address link-address option, so as to provide a hint to the DHCP Server for the link identification. The DHCP server, on receiving the request from the mobile node, will allocate addresses from all the prefixes associated with that link (identified using the link-address field of the request).
- o Once the mobile node obtains address(es), moves to a different link, and sends a DHCP request (at any time) for extending the DHCP lease, the DHCP relay agent on the new link will set the link-address field in the DHCP Relay Forward message to one of the mobile node's home network prefixes. The DHCP server will identify the client from the Client-DUID option and will identify the link from the link-address option present in the request and will allocate the same address(es) as before.
- o For correct operation of the model of network-based mobility management in which the host does not participate in any mobility management, the mobile node MUST always be assigned an identical set of IPv6 addresses regardless of the access link to which the mobile node is attached. For example, the mobile access gateways

in the Proxy Mobile IPv6 domain should be configured so that DHCP messages from a mobile node will always be handled by the same DHCP server or by a server from the same group of coordinated DHCP servers serving that domain. DHCP-based address configuration is not recommended for deployments in which the local mobility anchor and the mobile access gateway are located in different administrative domains.

6.12. Home Network Prefix Renumbering

If the mobile node's home network prefix(es) gets renumbered or becomes invalid during the middle of a mobility session, the mobile access gateway MUST withdraw the prefix(es) by sending a Router Advertisement message on the access link with zero prefix lifetime for the prefix(es) that is being renumbered. Also, the local mobility anchor and the mobile access gateway MUST delete the created routing state for the renumbered prefix(es). However, the specific details on how the local mobility anchor notifies the mobile access gateway about the mobile node's home network prefix(es) renumbering are outside the scope of this document.

6.13. Mobile Node Detachment Detection and Resource Cleanup

Before sending a Proxy Binding Update message to the local mobility anchor for extending the lifetime of a currently existing binding of a mobile node, the mobile access gateway MUST make sure the mobile node is still attached to the connected link by using some reliable method. If the mobile access gateway cannot predictably detect the presence of the mobile node on the connected link, it MUST NOT attempt to extend the registration lifetime of the mobile node. Further, in such a scenario, the mobile access gateway SHOULD terminate the binding of the mobile node by sending a Proxy Binding Update message to the mobile node's local mobility anchor with lifetime value set to 0. It MUST also remove any local state such as the Binding Update List entry created for that mobile node.

The specific detection mechanism of the loss of a visiting mobile node on the connected link is specific to the access link between the mobile node and the mobile access gateway and is outside the scope of this document. Typically, there are various link-layer-specific events specific to each access technology that the mobile access gateway can depend on for detecting the node loss. In general, the mobile access gateway can depend on one or more of the following methods for the detection presence of the mobile node on the connected link:

- o Link-layer event specific to the access technology
- o Session termination event on point-to-point link types
- o IPv6 Neighbor Unreachability Detection event from IPv6 stack
- o Notification event from the local mobility anchor

6.14. Allowing Network Access to Other IPv6 Nodes

In some Proxy Mobile IPv6 deployments, network operators may provision the mobile access gateway to offer network-based mobility management service only to some visiting mobile nodes and enable just regular IP access to some other nodes. This requires the network to have control on when to enable network-based mobility management service to a mobile node and when to enable regular IPv6 access. This specification does not disallow such configuration.

Upon detecting a mobile node on its access link and after policy considerations, the mobile access gateway **MUST** determine if network-based mobility management service should be offered to that mobile node. If the mobile node is entitled to network-based mobility management service, then the mobile access gateway must ensure the mobile node does not detect any change with respect to its layer-3 attachment, as explained in various sections of this specification.

If the mobile node is not entitled to the network-based mobility management service, as determined from the policy considerations, the mobile access gateway **MAY** choose to offer regular IPv6 access to the mobile node, and in such a scenario, the normal IPv6 considerations apply. If IPv6 access is enabled, the mobile node **SHOULD** be able to obtain IPv6 address(es) using the normal IPv6 address configuration procedures. The obtained address(es) must be from a local visitor network prefix(es). This essentially ensures that the mobile access gateway functions as a normal access router to a mobile node attached to its access link and without impacting its host-based mobility protocol operation.

7. Mobile Node Operation

This non-normative section explains the mobile node's operation in a Proxy Mobile IPv6 domain.

7.1. Moving into a Proxy Mobile IPv6 Domain

When a mobile node enters a Proxy Mobile IPv6 domain and attaches to an access network, the mobile access gateway on the access link detects the attachment of the mobile node and completes the binding

registration with the mobile node's local mobility anchor. If the binding update operation is successfully performed, the mobile access gateway will create the required state and set up the forwarding for the mobile node's data traffic.

When a mobile node attaches to the access link, it will typically send a Router Solicitation message [RFC4861]. The mobile access gateway on the access link will respond to the Router Solicitation message with a Router Advertisement message. The Router Advertisement message will carry the mobile node's home network prefix(es), default-router address, and other address configuration parameters.

If the mobile access gateway on the access link receives a Router Solicitation message from the mobile node, before it completes the signaling with the mobile node's local mobility anchor, the mobile access gateway may not know the mobile node's home network prefix(es) and may not be able to emulate the mobile node's home link on the access link. In such a scenario, the mobile node may notice a delay before it receives a Router Advertisement message. This will also affect mobile nodes that would be capable of handling their own mobility, or mobile nodes that do not need to maintain the same IP address through movements.

If the received Router Advertisement message has the Managed Address Configuration flag set, the mobile node, as it would normally do, will send a DHCP Request [RFC3315]. The DHCP relay service enabled on that access link will ensure the mobile node can obtain one or more addresses from its home network prefix(es).

If the received Router Advertisement message does not have the Managed Address Configuration flag set and if the mobile node is allowed to use autoconfigured address(es), the mobile node will be able to obtain IPv6 address(es) from each of its home network prefixes using any of the standard IPv6 address configuration mechanisms permitted for that mode.

If the mobile node is IPv4-enabled and if the network permits, it will be able to obtain the IPv4 address configuration, as specified in the companion document [IPV4-PMIP6].

Once the address configuration is complete, the mobile node can continue to use this address configuration as long as it is attached to the network that is in the scope of that Proxy Mobile IPv6 domain.

Proxy Registration Flag (P)

A new flag (P) is included in the Binding Update message to indicate to the local mobility anchor that the Binding Update message is a proxy registration. The flag MUST be set to the value of 1 for proxy registrations and MUST be set to 0 for direct registrations sent by a mobile node.

Mobility Options

Variable-length field of such length that the complete Mobility Header is an integer multiple of 8 octets long. This field contains zero or more TLV-encoded mobility options. The encoding and format of defined options are described in Section 6.2 of [RFC3775]. The local mobility anchor MUST ignore and skip any options that it does not understand.

As per this specification, the following mobility options are valid in a Proxy Binding Update message. These options can be present in the message in any order. There can be one or more instances of the Home Network Prefix options present in the message. However, there cannot be more than one instance of any of the following options.

Mobile Node Identifier option

Home Network Prefix option

Handoff Indicator option

Access Technology Type option

Timestamp option

Mobile Node Link-layer Identifier option

Link-local Address option

Additionally, there can be one or more instances of the Vendor-Specific Mobility option [RFC5094].

For descriptions of other fields present in this message, refer to Section 6.1.7 of [RFC3775].

8.2. Proxy Binding Acknowledgement Message

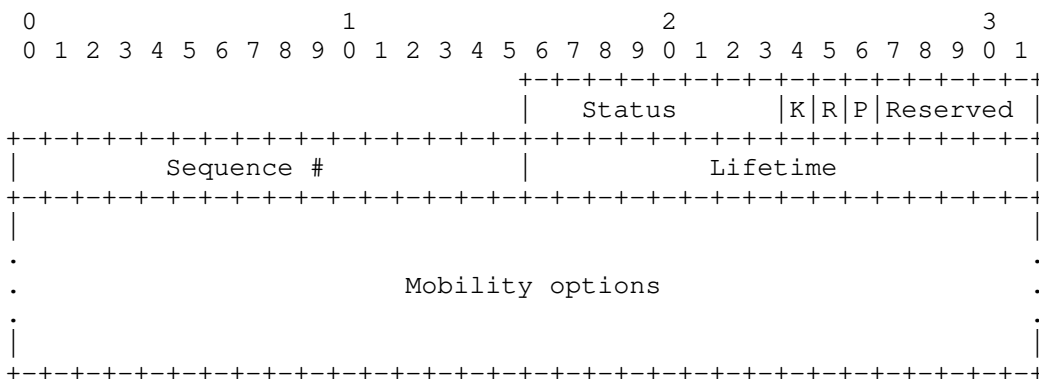

A Binding Acknowledgement message that is sent by a local mobility anchor to a mobile access gateway is referred to as the "Proxy Binding Acknowledgement" message. A new flag (P) is included in the Binding Acknowledgement message. The rest of the Binding Acknowledgement message format remains the same as defined in [RFC3775] and with the additional (R) flag as specified in [RFC3963].

Proxy Registration Flag (P)

A new flag (P) is included in the Binding Acknowledgement message to indicate that the local mobility anchor that processed the corresponding Proxy Binding Update message supports proxy registrations. The flag is set to a value of 1 only if the corresponding Proxy Binding Update had the Proxy Registration Flag (P) set to value of 1.

Mobility Options

A variable-length field of such length that the complete Mobility Header is an integer multiple of 8 octets long. This field contains zero or more TLV-encoded mobility options. The encoding and format of defined options are described in Section 6.2 of [RFC3775]. The mobile access gateway MUST ignore and skip any options that it does not understand.

As per this specification, the following mobility options are valid in a Proxy Binding Acknowledgement message. These options can be present in the message in any order. There can be one or

more instances of the Home Network Prefix options present in the message. However, there cannot be more than one instance of any of the following options.

- Mobile Node Identifier option
- Home Network Prefix option
- Handoff Indicator option
- Access Technology Type option
- Timestamp option
- Mobile Node Link-layer Identifier option
- Link-local Address option

Additionally, there can be one or more instances of the Vendor-Specific Mobility option [RFC5094].

Status

An 8-bit unsigned integer indicating the disposition of the Proxy Binding Update. Values of the Status field less than 128 indicate that the Proxy Binding Update was accepted by the local mobility anchor. Values greater than or equal to 128 indicate that the Proxy Binding Update message was rejected by the local mobility anchor. Section 8.9 defines the Status values that can be used in Proxy Binding Acknowledgement message.

For descriptions of other fields present in this message, refer to Section 6.1.8 of [RFC3775].

8.3. Home Network Prefix Option

A new option, Home Network Prefix option is defined for use with the Proxy Binding Update and Proxy Binding Acknowledgement messages exchanged between a local mobility anchor and a mobile access gateway. This option is used for exchanging the mobile node's home network prefix information. There can be multiple Home Network Prefix options present in the message.

The Home Network Prefix Option has an alignment requirement of $8n+4$. Its format is as follows:

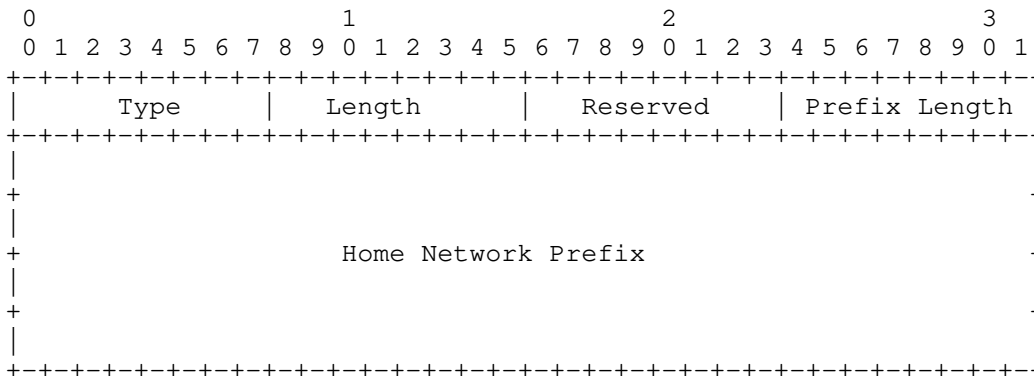

Type
22

Length

8-bit unsigned integer indicating the length of the option in octets, excluding the type and length fields. This field MUST be set to 18.

Reserved (R)

This 8-bit field is unused for now. The value MUST be initialized to 0 by the sender and MUST be ignored by the receiver.

Prefix Length

8-bit unsigned integer indicating the prefix length of the IPv6 prefix contained in the option.

Home Network Prefix

A sixteen-byte field containing the mobile node's IPv6 Home Network Prefix.

8.4. Handoff Indicator Option

A new option, Handoff Indicator option is defined for use with the Proxy Binding Update and Proxy Binding Acknowledgement messages exchanged between a local mobility anchor and a mobile access gateway. This option is used for exchanging the mobile node's handoff-related hints.

The Handoff Indicator option has no alignment requirement. Its format is as follows:

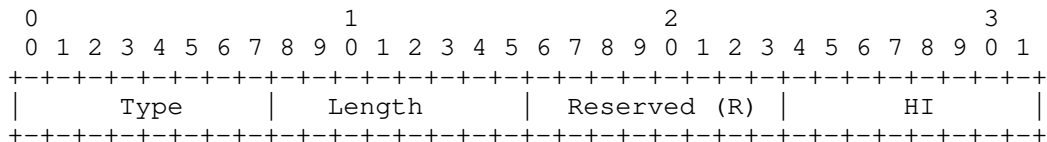

Type
23

Length

8-bit unsigned integer indicating the length of the option in octets, excluding the type and length fields. This field MUST be set to 2.

Reserved (R)

This 8-bit field is unused for now. The value MUST be initialized to 0 by the sender and MUST be ignored by the receiver.

Handoff Indicator (HI)

An 8-bit field that specifies the type of handoff. The values (0 - 255) will be allocated and managed by IANA. The following values are currently defined.

- 0: Reserved
- 1: Attachment over a new interface
- 2: Handoff between two different interfaces of the mobile node
- 3: Handoff between mobile access gateways for the same interface
- 4: Handoff state unknown
- 5: Handoff state not changed (Re-registration)

8.5. Access Technology Type Option

A new option, Access Technology Type option is defined for use with the Proxy Binding Update and Proxy Binding Acknowledgement messages exchanged between a local mobility anchor and a mobile access gateway. This option is used for exchanging the type of the access technology by which the mobile node is currently attached to the mobile access gateway.

The Access Technology Type Option has no alignment requirement. Its format is as follows:

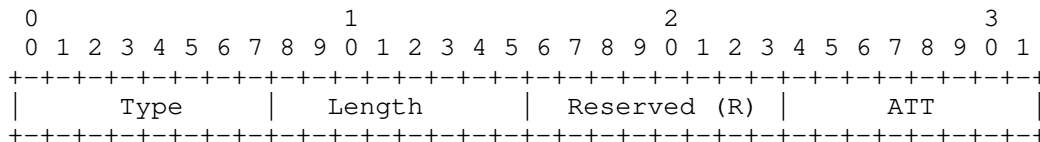

Type
24

Length

8-bit unsigned integer indicating the length of the option in octets, excluding the type and length fields. This field MUST be set to 2.

Reserved (R)

This 8-bit field is unused for now. The value MUST be initialized to 0 by the sender and MUST be ignored by the receiver.

Access Technology Type (ATT)

An 8-bit field that specifies the access technology through which the mobile node is connected to the access link on the mobile access gateway.

The values (0 - 255) will be allocated and managed by IANA. The following values are currently reserved for the below specified access technology types.

- 0: Reserved ("Reserved")
- 1: Virtual ("Logical Network Interface")
- 2: PPP ("Point-to-Point Protocol")
- 3: IEEE 802.3 ("Ethernet")
- 4: IEEE 802.11a/b/g ("Wireless LAN")
- 5: IEEE 802.16e ("WIMAX")

8.6. Mobile Node Link-layer Identifier Option

A new option, Mobile Node Link-layer Identifier option is defined for use with the Proxy Binding Update and Proxy Binding Acknowledgement messages exchanged between a local mobility anchor and a mobile access gateway. This option is used for exchanging the mobile node's link-layer identifier.

The format of the Link-layer Identifier option is shown below. Based on the size of the identifier, the option MUST be aligned appropriately, as per mobility option alignment requirements specified in [RFC3775].

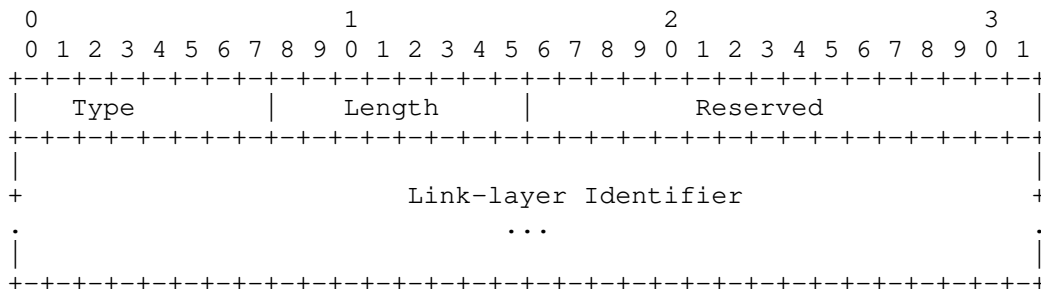

Type
25

Length
8-bit unsigned integer indicating the length of the option in octets, excluding the type and length fields.

Reserved

This field is unused for now. The value MUST be initialized to 0 by the sender and MUST be ignored by the receiver.

Link-layer Identifier

A variable length field containing the mobile node's link-layer identifier.

The content and format of this field (including byte and bit ordering) is as specified in Section 4.6 of [RFC4861] for carrying link-layer addresses. On certain access links, where the link-layer address is not used or cannot be determined, this option cannot be used.

8.7. Link-local Address Option

A new option, Link-local Address option is defined for use with the Proxy Binding Update and Proxy Binding Acknowledgement messages exchanged between a local mobility anchor and a mobile access gateway. This option is used for exchanging the link-local address of the mobile access gateway.

The Link-local Address option has an alignment requirement of 8n+6. Its format is as follows:

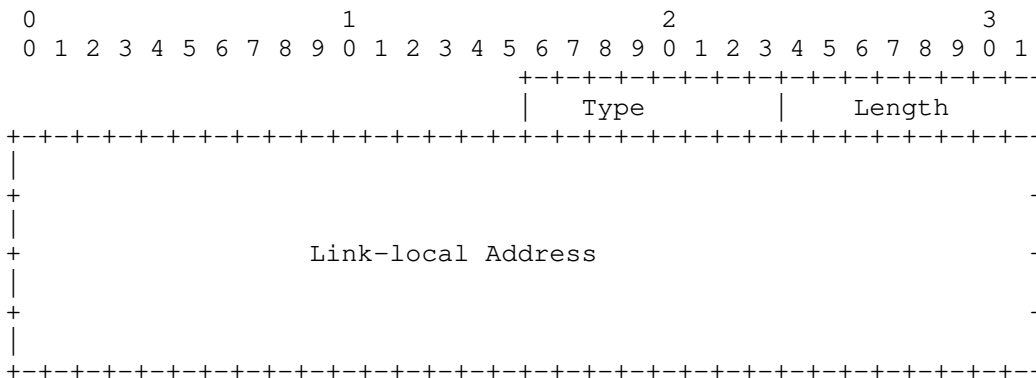

Type
26

Length

8-bit unsigned integer indicating the length of the option in octets, excluding the type and length fields. This field MUST be set to 16.

Link-local Address

A sixteen-byte field containing the link-local address.

8.8. Timestamp Option

A new option, Timestamp option is defined for use in the Proxy Binding Update and Proxy Binding Acknowledgement messages.

The Timestamp option has an alignment requirement of 8n+2. Its format is as follows:

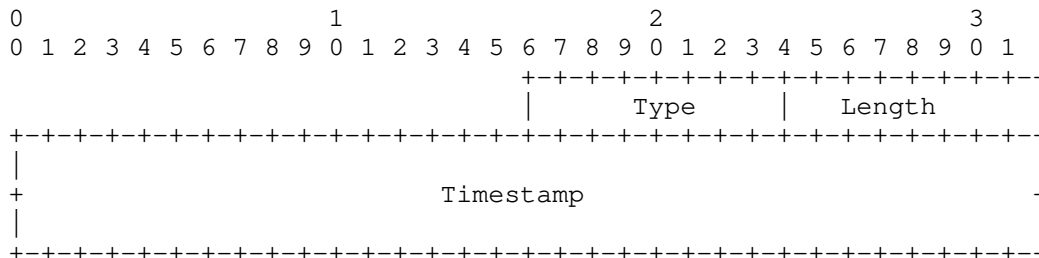

Type
27

Length

8-bit unsigned integer indicating the length in octets of the option, excluding the type and length fields. The value for this field MUST be set to 8.

Timestamp

A 64-bit unsigned integer field containing a timestamp. The value indicates the number of seconds since January 1, 1970, 00:00 UTC, by using a fixed point format. In this format, the integer number of seconds is contained in the first 48 bits of the field, and the remaining 16 bits indicate the number of 1/65536 fractions of a second.

8.9. Status Values

This document defines the following new Status values for use in Proxy Binding Acknowledgement messages. These values are to be allocated from the same number space, as defined in Section 6.1.8 of [RFC3775].

Status values less than 128 indicate that the Proxy Binding Update message was accepted by the local mobility anchor. Status values greater than 128 indicate that the Proxy Binding Update was rejected by the local mobility anchor.

PROXY_REG_NOT_ENABLED: 152

Proxy registration not enabled for the mobile node

NOT_LMA_FOR_THIS_MOBILE_NODE: 153

Not local mobility anchor for this mobile node

MAG_NOT_AUTHORIZED_FOR_PROXY_REG: 154

The mobile access gateway is not authorized to send proxy binding updates

NOT_AUTHORIZED_FOR_HOME_NETWORK_PREFIX: 155

The mobile node is not authorized for one or more of the requesting home network prefixes

TIMESTAMP_MISMATCH: 156

Invalid timestamp value (the clocks are out of sync)

TIMESTAMP_LOWER_THAN_PREV_ACCEPTED: 157

The timestamp value is lower than the previously accepted value

MISSING_HOME_NETWORK_PREFIX_OPTION: 158

Missing home network prefix option

BCE_PBU_PREFIX_SET_DO_NOT_MATCH: 159

All the home network prefixes listed in the BCE do not match all the prefixes in the received PBU

MISSING_MN_IDENTIFIER_OPTION: 160

Missing mobile node identifier option

MISSING_HANDOFF_INDICATOR_OPTION: 161

Missing handoff indicator option

MISSING_ACCESS_TECH_TYPE_OPTION: 162

Missing access technology type option

Additionally, the following Status values defined in [RFC3775] can also be used in a Proxy Binding Acknowledgement message.

0 Proxy Binding Update accepted

128 Reason unspecified

129 Administratively prohibited

130 Insufficient resources

9. Protocol Configuration Variables

9.1. Local Mobility Anchor - Configuration Variables

The local mobility anchor MUST allow the following variables to be configured by the system management. The configured values for these protocol variables MUST survive server reboots and service restarts.

MinDelayBeforeBCEDelete

This variable specifies the amount of time in milliseconds the local mobility anchor MUST wait before it deletes a Binding Cache entry of a mobile node, upon receiving a Proxy Binding Update message from a mobile access gateway with a lifetime value of 0. During this wait time, if the local mobility anchor receives a Proxy Binding Update for the same mobility binding, with a lifetime value greater than 0, then it must update the binding cache entry with the accepted binding values. By the end of this wait-time, if the local mobility anchor did not receive any valid Proxy Binding Update message for that mobility binding, it MUST delete the Binding Cache entry. This delay essentially ensures a mobile node's Binding Cache entry is not deleted too quickly and allows some time for the new mobile access gateway to complete the signaling for the mobile node.

The default value for this variable is 10000 milliseconds.

MaxDelayBeforeNewBCEAssign

This variable specifies the amount of time in milliseconds the local mobility anchor MUST wait for the de-registration message for an existing mobility session before it decides to create a new mobility session.

The default value for this variable is 1500 milliseconds.

Note that there is a dependency between this value and the values used in the retransmission algorithm for Proxy Binding Updates. The retransmissions need to happen before MaxDelayBeforeNewBCEAssign runs out, as otherwise there are situations where a de-registration from a previous mobile access gateway may be lost, and the local mobility anchor creates, needlessly, a new mobility session and new prefixes for the mobile node. However, this affects situations where there is no information from the lower layers about the type of a handoff or other parameters that can be used for identifying the mobility session.

TimestampValidityWindow

This variable specifies the maximum amount of time difference in milliseconds between the timestamp in the received Proxy Binding Update message and the current time of day on the local mobility anchor, that is allowed by the local mobility anchor for the received message to be considered valid.

The default value for this variable is 300 milliseconds. This variable must be adjusted to suit the deployments.

9.2. Mobile Access Gateway - Configuration Variables

The mobile access gateway MUST allow the following variables to be configured by the system management. The configured values for these protocol variables MUST survive server reboots and service restarts.

EnableMAGLocalRouting

This flag indicates whether or not the mobile access gateway is allowed to enable local routing of the traffic exchanged between a visiting mobile node and a correspondent node that is locally connected to one of the interfaces of the mobile access gateway. The correspondent node can be another visiting mobile node as well, or a local fixed node.

The default value for this flag is set to a value of 0, indicating that the mobile access gateway MUST reverse tunnel all the traffic to the mobile node's local mobility anchor.

When the value of this flag is set to a value of 1, the mobile access gateway MUST route the traffic locally.

This aspect of local routing MAY be defined as policy on a per mobile basis and when present will take precedence over this flag.

9.3. Proxy Mobile IPv6 Domain - Configuration Variables

All the mobile entities (local mobility anchors and mobile access gateways) in a Proxy Mobile IPv6 domain MUST allow the following variables to be configured by the system management. The configured values for these protocol variables MUST survive server reboots and service restarts. These variables MUST be globally fixed for a given Proxy Mobile IPv6 domain resulting in the same values being enforced on all the mobility entities in that domain.

TimestampBasedApproachInUse

This flag indicates whether or not the timestamp-based approach for message ordering is in use in that Proxy Mobile IPv6 domain. When the value for this flag is set to 1, all the mobile access gateways in that Proxy Mobile IPv6 domain MUST apply the timestamp-based considerations listed in Section 5.5. When the value of this flag is set to 0, sequence-number-based considerations listed in Section 5.5 MUST be applied. The default value for this flag is set to value of 1, indicating that the timestamp-based mechanism is in use in that Proxy Mobile IPv6 domain.

MobileNodeGeneratedTimestampInUse

This flag indicates whether or not the mobile-node-generated timestamp approach is in use in that Proxy Mobile IPv6 domain. When the value for this flag is set to 1, the local mobility anchors and mobile access gateways in that Proxy Mobile IPv6 domain MUST apply the mobile node generated timestamp considerations as specified in Section 5.5.

This flag is relevant only when timestamp-based approach is in use. The value for this flag MUST NOT be set to value of 1, if the value of the TimestampBasedApproachInUse flag is set to 0.

The default value for this flag is set to value of 0, indicating that the mobile node generated timestamp mechanism is not in use in that Proxy Mobile IPv6 domain.

FixedMAGLinkLocalAddressOnAllAccessLinks

This variable indicates the link-local address value that all the mobile access gateways SHOULD use on any of the access links shared with any of the mobile nodes in that Proxy Mobile IPv6 domain. If this variable is initialized to ALL_ZERO value, it implies the use of fixed link-local address mode is not enabled for that Proxy Mobile IPv6 domain.

FixedMAGLinkLayerAddressOnAllAccessLinks

This variable indicates the link-layer address value that all the mobile access gateways SHOULD use on any of the access links shared with any of the mobile nodes in that Proxy Mobile IPv6 domain. For access technologies where there is no link-layer address, this variable MUST be initialized to ALL_ZERO value.

10. IANA Considerations

This document defines six new Mobility Header options, the Home Network Prefix Option, Handoff Indicator Option, Access Technology Type Option, Mobile Node Link-layer Identifier Option, Link-local Address Option, and Timestamp Option. These options are described in Section 8. The Type value for these options has been assigned from the same numbering space as allocated for the other mobility options, as defined in [RFC3775].

The Handoff Indicator Option, defined in Section 8.4 of this document, introduces a new Handoff Indicator (HI) numbering space, where the values from 0 to 5 have been reserved by this document. Approval of new Handoff Indicator type values are to be made through IANA Expert Review.

The Access Technology Type Option, defined in Section 8.5 of this document, introduces a new Access Technology type (ATT) numbering space, where the values from 0 to 5 have been reserved by this document. Approval of new Access Technology type values are to be made through IANA Expert Review.

This document also defines new Binding Acknowledgement status values, as described in Section 8.9. The status values MUST be assigned from the same number space used for Binding Acknowledgement status values, as defined in [RFC3775]. The allocated values for each of these status values must be greater than 128.

This document creates a new registry for the flags in the Binding Update message called the "Binding Update Flags".

The following flags are reserved:

(A) 0x8000 [RFC3775]

(H) 0x4000 [RFC3775]

(L) 0x2000 [RFC3775]

(K) 0x1000 [RFC3775]

(M) 0x0800 [RFC4140]

(R) 0x0400 [RFC3963]

This document reserves a new flag (P) as follows:

(P) 0x0200

The rest of the values in the 16-bit field are reserved. New values can be assigned by Standards Action or IESG approval.

This document also creates a new registry for the flags in the Binding Acknowledgment message called the "Binding Acknowledgment Flags". The following values are reserved.

(K) 0x80 [RFC3775]

(R) 0x40 [RFC3963]

This document reserves a new flag (P) as follows:

(P) 0x20

The rest of the values in the 8-bit field are reserved. New values can be assigned by Standards Action or IESG approval.

11. Security Considerations

The potential security threats against any network-based mobility management protocol are described in [RFC4832]. This section explains how Proxy Mobile IPv6 protocol defends itself against those threats.

Proxy Mobile IPv6 protocol recommends the signaling messages, Proxy Binding Update and Proxy Binding Acknowledgement, exchanged between the mobile access gateway and the local mobility anchor to be protected using IPsec using the established security association between them. This essentially eliminates the threats related to the impersonation of the mobile access gateway or the local mobility anchor.

This specification allows a mobile access gateway to send binding registration messages on behalf of a mobile node. If proper authorization checks are not in place, a malicious node may be able to hijack a mobile node's mobility session or may carry out a denial-of-service attack. To prevent this attack, this specification requires the local mobility anchor to allow only authorized mobile access gateways that are part of that Proxy Mobile IPv6 domain to send Proxy Binding Update messages on behalf of a mobile node.

To eliminate the threats on the interface between the mobile access gateway and the mobile node, this specification requires an established trust between the mobile access gateway and the mobile node and to authenticate and authorize the mobile node before it is allowed to access the network. Further, the established authentication mechanisms enabled on that access link will ensure that there is a secure binding between the mobile node's identity and its link-layer address. The mobile access gateway will definitively identify the mobile node from the packets that it receives on that access link.

To address the threat related to a compromised mobile access gateway, the local mobility anchor, before accepting a Proxy Binding Update message for a given mobile node, may ensure that the mobile node is attached to the mobile access gateway that sent the Proxy Binding Update message. This may be accomplished by contacting a trusted entity, which is able to track the mobile node's current point of attachment. However, the specific details of the actual mechanisms for achieving this is outside the scope of this document.

12. Acknowledgements

The authors would like to specially thank Jari Arkko, Julien Laganier, Christian Vogt, Dave Thaler, Pasi Eronen, Pete McCann, Brian Haley, Ahmad Muhanna, JinHyeock Choi, and Elwyn Davies for their thorough reviews of this document.

The authors would also like to thank Alex Petrescu, Alice Qinxia, Alper Yegin, Ashutosh Dutta, Behcet Sarikaya, Charles Perkins, Domagoj Premec, Fred Templin, Genadi Velez, George Tsirtsis, Gerardo Giaretta, Henrik Levkowitz, Hesham Soliman, James Kempf, Jean-Michel

Combes, John Jason Brzozowski, Jun Awano, John Zhao, Jong-Hyouk Lee, Jonne Soininen, Jouni Korhonen, Kalin Getov, Kilian Weniger, Lars Eggert, Magnus Westerlund, Marco Liebsch, Mohamed Khalil, Nishida Katsutoshi, Pierrick Seite, Phil Roberts, Ralph Droms, Ryuji Wakikawa, Sangjin Jeong, Suresh Krishnan, Tero Kauppinen, Uri Blumenthal, Ved Kafle, Vidya Narayanan, Youn-Hee Han, and many others for their passionate discussions in the working group mailing list on the topic of localized mobility management solutions. These discussions stimulated much of the thinking and shaped the document to the current form and we acknowledge that!

The authors would also like to thank Ole Troan, Akiko Hattori, Parviz Yegani, Mark Grayson, Michael Hammer, Vojislav Vucetic, Jay Iyer, Tim Stammers, Bernie Volz, and Josh Littlefield for their input on this document.

13. References

13.1. Normative References

- [RFC2119] Bradner, S., "Key words for use in RFCs to Indicate Requirement Levels", BCP 14, RFC 2119, March 1997.
- [RFC2473] Conta, A. and S. Deering, "Generic Packet Tunneling in IPv6 Specification", RFC 2473, December 1998.
- [RFC3168] Ramakrishnan, K., Floyd, S., and D. Black, "The Addition of Explicit Congestion Notification (ECN) to IP", RFC 3168, September 2001.
- [RFC3315] Droms, R., Bound, J., Volz, B., Lemon, T., Perkins, C., and M. Carney, "Dynamic Host Configuration Protocol for IPv6 (DHCPv6)", RFC 3315, July 2003.
- [RFC3775] Johnson, D., Perkins, C., and J. Arkko, "Mobility Support in IPv6", RFC 3775, June 2004.
- [RFC4282] Aboba, B., Beadles, M., Arkko, J., and P. Eronen, "The Network Access Identifier", RFC 4282, December 2005.
- [RFC4283] Patel, A., Leung, K., Khalil, M., Akhtar, H., and K. Chowdhury, "Mobile Node Identifier Option for Mobile IPv6 (MIPv6)", RFC 4283, November 2005.
- [RFC4291] Hinden, R. and S. Deering, "IP Version 6 Addressing Architecture", RFC 4291, February 2006.

- [RFC4301] Kent, S. and K. Seo, "Security Architecture for the Internet Protocol", RFC 4301, December 2005.
- [RFC4303] Kent, S., "IP Encapsulating Security Payload (ESP)", RFC 4303, December 2005.
- [RFC4861] Narten, T., Nordmark, E., Simpson, W., and H. Soliman, "Neighbor Discovery for IP version 6 (IPv6)", RFC 4861, September 2007.

13.2. Informative References

- [RFC1981] McCann, J., Deering, S., and J. Mogul, "Path MTU Discovery for IP version 6", RFC 1981, August 1996.
- [RFC2865] Rigney, C., Willens, S., Rubens, A., and W. Simpson, "Remote Authentication Dial In User Service (RADIUS)", RFC 2865, June 2000.
- [RFC3588] Calhoun, P., Loughney, J., Guttman, E., Zorn, G., and J. Arkko, "Diameter Base Protocol", RFC 3588, September 2003.
- [RFC3963] Devarapalli, V., Wakikawa, R., Petrescu, A., and P. Thubert, "Network Mobility (NEMO) Basic Support Protocol", RFC 3963, January 2005.
- [RFC3971] Arkko, J., Kempf, J., Zill, B., and P. Nikander, "SEcure Neighbor Discovery (SEND)", RFC 3971, March 2005.
- [RFC4140] Soliman, H., Castelluccia, C., El Malki, K., and L. Bellier, "Hierarchical Mobile IPv6 Mobility Management (HMIPv6)", RFC 4140, August 2005.
- [RFC4306] Kaufman, C., "Internet Key Exchange (IKEv2) Protocol", RFC 4306, December 2005.
- [RFC4330] Mills, D., "Simple Network Time Protocol (SNTP) Version 4 for IPv4, IPv6 and OSI", RFC 4330, January 2006.
- [RFC4372] Adrangi, F., Lior, A., Korhonen, J., and J. Loughney, "Chargeable User Identity", RFC 4372, January 2006.
- [RFC4821] Mathis, M. and J. Heffner, "Packetization Layer Path MTU Discovery", RFC 4821, March 2007.

- [RFC4830] Kempf, J., "Problem Statement for Network-Based Localized Mobility Management (NETLMM)", RFC 4830, April 2007.
- [RFC4831] Kempf, J., "Goals for Network-Based Localized Mobility Management (NETLMM)", RFC 4831, April 2007.
- [RFC4832] Vogt, C. and J. Kempf, "Security Threats to Network-Based Localized Mobility Management (NETLMM)", RFC 4832, April 2007.
- [RFC4862] Thomson, S., Narten, T., and T. Jinmei, "IPv6 Stateless Address Autoconfiguration", RFC 4862, September 2007.
- [RFC4941] Narten, T., Draves, R., and S. Krishnan, "Privacy Extensions for Stateless Address Autoconfiguration in IPv6", RFC 4941, September 2007.
- [RFC5094] Devarapalli, V., Patel, A., and K. Leung, "Mobile IPv6 Vendor Specific Option", RFC 5094, December 2007.
- [IPV4-PMIP6] Wakikawa, R. and S. Gundavelli, "IPv4 Support for Proxy Mobile IPv6", Work in Progress, May 2008.
- [DNAV6] Narayanan, S., Ed., "Detecting Network Attachment in IPv6 Networks (DNAV6)", Work in Progress, February 2008.

Appendix A. Proxy Mobile IPv6 Interactions with AAA Infrastructure

Every mobile node that roams in a proxy Mobile IPv6 domain would typically be identified by an identifier, MN-Identifier, and that identifier will have an associated policy profile that identifies the mobile node's home network prefix(es) on a per-interface basis, permitted address configuration modes, roaming policy, and other parameters that are essential for providing network-based mobility management service. This information is typically configured in AAA. In some cases, the home network prefix(es) may be dynamically assigned to the mobile node's interface, after its initial attachment to the Proxy Mobile IPv6 domain over that interface and may not be configured in the mobile node's policy profile.

The network entities in the proxy Mobile IPv6 domain, while serving a mobile node, will have access to the mobile node's policy profile and these entities can query this information using RADIUS [RFC2865] or DIAMETER [RFC3588] protocols.

Appendix B. Routing State

The following section explains the routing state created for a mobile node on the mobile access gateway. This routing state reflects only one specific way of implementation, and one MAY choose to implement it in other ways. The policy based route defined below acts as a traffic selection rule for routing a mobile node's traffic through a specific tunnel created between the mobile access gateway and that mobile node's local mobility anchor and with the specific encapsulation mode, as negotiated.

The below example identifies the routing state for two visiting mobile nodes, MN1 and MN2, with their respective local mobility anchors, LMA1 and LMA2.

For all traffic from the mobile node, identified by the mobile node's MAC address, ingress interface or source prefix (MN-HNP) to _ANY_DESTINATION_ route via interface tunnel0, next-hop LMAA.

Packet Source	Destination Address	Destination Interface
MAC_Address_MN1, (IPv6 Prefix or Input Interface)	_ANY_DESTINATION_	Tunnel0
	Locally Connected	Tunnel0
MAC_Address_MN2, (IPv6 Prefix or Input Interface)	_ANY_DESTINATION_	Tunnel1
	Locally Connected	direct

Example - Policy-Based Route Table

Interface	Source Address	Destination Address	Encapsulation
Tunnel0	Proxy-CoA	LMAA1	IPv6-in-IPv6
Tunnel1	Proxy-CoA	LMAA2	IPv6-in-IPv6

Example - Tunnel Interface Table

Authors' Addresses

Sri Gundavelli (editor)
Cisco
170 West Tasman Drive
San Jose, CA 95134
USA

EEmail: sgundave@cisco.com

Kent Leung
Cisco
170 West Tasman Drive
San Jose, CA 95134
USA

EEmail: kleung@cisco.com

Vijay Devarapalli
Wichorus
3590 North First Street
San Jose, CA 95134
USA

EEmail: vijay@wichorus.com

Kuntal Chowdhury
Starent Networks
30 International Place
Tewksbury, MA

EEmail: kchowdhury@starentnetworks.com

Basavaraj Patil
Nokia
6000 Connection Drive
Irving, TX 75039
USA

EEmail: basavaraj.patil@nokia.com

Full Copyright Statement

Copyright (C) The IETF Trust (2008).

This document is subject to the rights, licenses and restrictions contained in BCP 78, and except as set forth therein, the authors retain all their rights.

This document and the information contained herein are provided on an "AS IS" basis and THE CONTRIBUTOR, THE ORGANIZATION HE/SHE REPRESENTS OR IS SPONSORED BY (IF ANY), THE INTERNET SOCIETY, THE IETF TRUST AND THE INTERNET ENGINEERING TASK FORCE DISCLAIM ALL WARRANTIES, EXPRESS OR IMPLIED, INCLUDING BUT NOT LIMITED TO ANY WARRANTY THAT THE USE OF THE INFORMATION HEREIN WILL NOT INFRINGE ANY RIGHTS OR ANY IMPLIED WARRANTIES OF MERCHANTABILITY OR FITNESS FOR A PARTICULAR PURPOSE.

Intellectual Property

The IETF takes no position regarding the validity or scope of any Intellectual Property Rights or other rights that might be claimed to pertain to the implementation or use of the technology described in this document or the extent to which any license under such rights might or might not be available; nor does it represent that it has made any independent effort to identify any such rights. Information on the procedures with respect to rights in RFC documents can be found in BCP 78 and BCP 79.

Copies of IPR disclosures made to the IETF Secretariat and any assurances of licenses to be made available, or the result of an attempt made to obtain a general license or permission for the use of such proprietary rights by implementers or users of this specification can be obtained from the IETF on-line IPR repository at <http://www.ietf.org/ipr>.

The IETF invites any interested party to bring to its attention any copyrights, patents or patent applications, or other proprietary rights that may cover technology that may be required to implement this standard. Please address the information to the IETF at ietf-ipr@ietf.org.