

Document downloaded from:

<http://hdl.handle.net/10251/52490>

This paper must be cited as:

Vilar Mateo, R.; Czarny, R.; Lee, ML.; Loiseaux, B.; Sypek, M.; Makowski, M.; Martel, C... (2014). Q-Band Millimeter-Wave Antennas: An Enabling Technology for MultiGigabit Wireless Backhaul. *IEEE Microwave Magazine*. 15(4):121-130. doi:10.1109/MMM.2014.2308769.



The final publication is available at

<http://dx.doi.org/10.1109/MMM.2014.2308769>

Copyright Institute of Electrical and Electronics Engineers (IEEE)

Q-band millimetre wave antennas: an enabling technology for multi-gigabit wireless backhaul

Authors: R. Vilar¹, R. Czarny², MS. L. Lee², B. Loiseaux², M. Sypek³, M. Makowski³, C. Martel⁴, T. Crépin⁴, F. Boust⁴, R. Joseph⁵, K. Herbertz⁵, T. Bertuch⁵, J. Marti¹

¹Universitat Politecnica de Valencia, Spain

²Thales Research and Technology, France

³Ortech SP. Z O.O., Poland

⁴The French Aerospace Lab - ONERA, France

⁵Fraunhofer Institute for High Frequency Physics and Radar Techniques FHR, Germany

The bandwidth demands in mobile communication systems are growing exponentially day-by-day, as the number of users has increased drastically over the last five years. This mobile data explosion, together with the fixed service limitations, requires a new approach to support this increase in bandwidth demand. Solutions based on lower frequency microwave wireless systems may be able to meet the bandwidth demand in a short-term; with the small cell mass deployment requiring total capacities of 1 Gbps per km², scalable, multi-gigabit backhaul systems are required. Millimetre wave technology fits nicely into these new backhaul scenarios as it provides extended bandwidth for high capacity links and adaptive throughput rate, which allows efficient and flexible deployment. Besides these advantages, millimetre wave solutions become even more attractive when the cost of backhaul solutions and the cost of spectrum licenses are factored in. Compared to the cost of laying fibre to a cell base station, which is the only other scalable solution, the millimetre wave solution becomes the most appropriate approach.

Within the millimetre wave frequency band, Q-band (40.5 – 43.5 GHz) technology offers various advantages over currently proposed or existing communication systems. One of the key advantages of Q-band is the large amount of spectral bandwidth available suitable for wide channels (three consecutive 1 GHz bands have been allocated by CEPT and regulated by ETSI). The availability of this amount of bandwidth also enables the capability to scale the capacity of millimetre wave wireless links as demanded by market needs. When wider

channels are needed, i.e. for very high bit rate applications, a flexible number of consecutive channels may be aggregated to obtain a single channel. In addition, highly directional, pencil-beam signal characteristics of the systems operating in this band facilitates a high degree of frequency reuse in the deployment of backhaul links so that operators can deliver very large amounts of capacity in a given area. On the other hand, from an operational point of view, Q-band radios can withstand higher amounts of interference and more adverse weather conditions such as rain, fog, and snow, when compared with higher frequencies (E-band and V-band). Q-band offers better coverage than V-band as signals in the 57–66 GHz spectrum are subject to the resonance of oxygen molecules and hence propagation in this spectrum is severely attenuated, leading to very short link ranges. Moreover, Q-band has a better link budget compared with E-band (it suffers from less atmospheric and rain attenuation, and has better noise figure and power), and lower fabrication costs.

From the reasons above, Q-band technology seems to be an enabling technology for the efficient design of multi-gigabit backhaul networks. Despite their huge potential to achieve multi-gigabit wireless communications, Q-band antennas present a series of technical challenges in terms of performance, cost efficiency and acceptability that needs to be resolved before its full deployment. In particular, low-profile high-gain antennas with gain values higher than 20-30 dBi will be needed to enhance throughput and extend the link range. Agile electronic beam scanning antennas with moderate gain and either large (270°) or limited field of view (180°) in the horizontal plane will be required to enhance coverage, reduce interference and save energy.

This article presents a review of existing antenna technologies in Q-band and some improvements developed in the FP7 SARABAND project to meet the requirements of multi-gigabit backhaul in terms of capacity and coverage. Detailed descriptions of the project objective can be found on the SARABAND web page [1].

1. LOW-PROFILE HIGH-GAIN ANTENNAS

In mobile communication systems, point-to-point communication is achieved using medium- to high-gain antennas which transmit the RF signal from one base station to another and across the entire wireless network. Apart from having medium to high-gain characteristics, point-to-point communication antennas must comply with a series of electrical and mechanical requirements: a directive pencil-beam is required to direct the energy at a specific point, a relatively large bandwidth is desired for high data rate information transfer, and, the antenna must be small, discrete, lightweight, and must be produced at low cost.

This section provides a review of available Q-band medium- and high-gain antennas as a starting point to identify and investigate the relevant technologies for Q-band multi-gigabit wireless links.

1.1. Review of available Q-band high-gain antennas

1.1.1. Microstrip antenna

Microstrip antenna technology is an attractive candidate at lower frequencies as it can provide planar, lightweight, and low-cost solutions. This type of antenna consists of a conducting patch of any planar or non-planar geometry on one side of a dielectric substrate with a ground plane on the other side. Feeding is achieved through the use of coaxial line with an inner conductor that terminates on a microstrip line feeding the patch elements of the antenna. The microstrip patch antenna radiates primarily because of the fringing fields between the patch edge and the ground plane. Figure 1 shows the generic structure of a microstrip patch antenna.

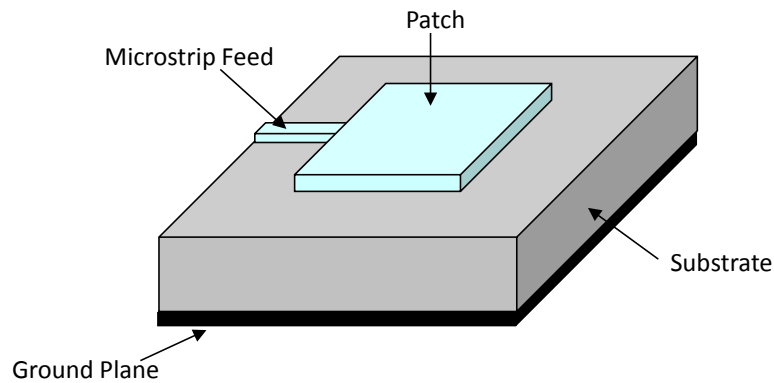

Figure 1. Generic structure of a microstrip antenna

Bandwidth and efficiency depend upon several factors such as patch size, shape, substrate thickness, dielectric constant of substrate, or feed point type and its location. For good antenna performance, a thick dielectric substrate having a low dielectric constant is desirable since this provides better efficiency, larger bandwidth and better radiation [2-4]. A single patch antenna can provide a maximum directive gain of around 5-7dBi depending on the size of the surrounding ground plane. High-gain requirements imply the implementation of an array having a relatively large number of radiating elements that in turn requires a complex feed network. Recently, an array of 4×4 patch elements for operation close to 35 GHz with 17-dB gain has been developed [5]. The dimensions of the patch elements are 3 mm × 4 mm. The prototype of this antenna is shown in Figure 2. But for higher gains, more elements are required. As a result, such complicated feed networks are likely to be too lossy and will considerably reduce the efficiency and the performance of the antenna. Other examples of microstrip patch arrays operating in millimetre waves can be found in the literature [6-8].

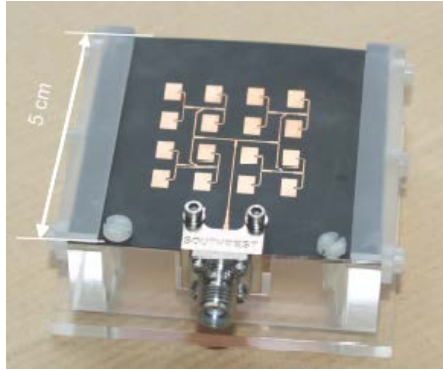

Figure 2. Antenna prototype at 35 GHz [5]

1.1.2. Reflectarray antenna

Reflectarray antennas are typically used for many high-gain, high-frequency applications. A reflectarray consists of a source placed above a flat and electrically large reflecting surface, which redirects the energy in the opposite direction [9-10]. The reflecting surface is made of multiple elements providing the appropriate surface impedance. The elements can be passive although driven elements are also used as they allow reconfiguration capabilities in terms of beam steering. Figure 3 shows the basic geometry of a microstrip reflectarray.

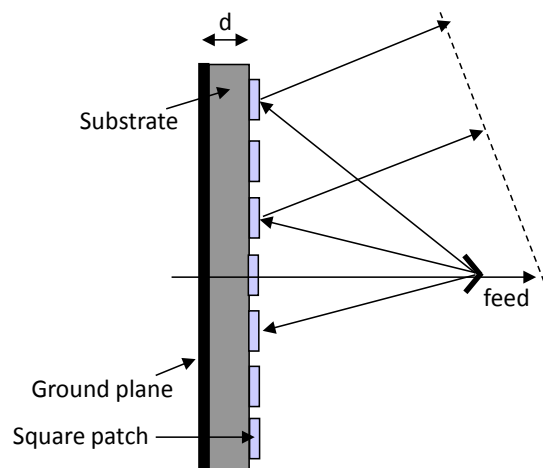

Figure 3. Basic geometry of a microstrip reflectarray

In general, the feed may be positioned at an arbitrary angle and distance from the reflectarray, but is assumed to be far enough from the reflectarray so that the incident field can be approximated by a plane wave. This makes the antenna size large and therefore currently available reflectarray antennas at Q-band do not accomplish the low-profile requirement [11], as shown in Figure 4.



Figure 4.42 GHz reflectarray (\varnothing 220 mm \times 115 mm) [10]

1.1.3. Dielectric lens antenna

Lens antennas based on dielectric lens technology can provide gain figures comparable to reflectarray antennas, while having relaxed manufacturing tolerances and reduced cost [12]. In lens antennas, a quasi-point source (the feeder) generates a quasi-spherical wave that is collected and collimated by a dielectric lens. This results in quasi-plane wave generation at the antenna output that could provide diffraction-limited gain. Figure 5 schematically depicts the lens antenna principle.

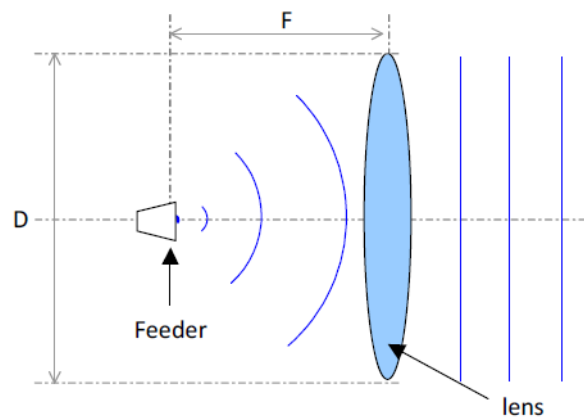

Figure 5. Lens antenna principle

Figure 6 shows a typical example of a Q-band lens antenna [12]. Despite their good electrical performance, lens antennas have some disadvantages when low-profile requirement should be accomplished. Actually, such property implies small F/D values (ratio between the focal

length and the lens diameter), resulting in an increment of the lens complexity and the lens thickness, leading to higher weight and cost of the lens.



Figure 6.42 GHz lens antenna (200 mm × 150 mm) [11]

1.2. Q-band low-profile high-gain antennas proposed in the SARABAND project

None of the current Q-band antenna technologies reviewed in previous section provides the required performance for future backhaul networks in terms of gain, size and cost. In the FP7 SARABAND project, two promising families of low-profile high-gain antennas are analyzed: the sub-wavelength lens antenna and the Fabry-Perot antenna.

1.2.1. Sub-wavelength structured lens antenna

Dielectric lens antennas exhibit disadvantages in terms of size and weight when a small F/D ratio is required. To overcome these limitations, the introduction of diffractive Fresnel lenses has been investigated [13-14]. These lenses are relatively thin and, for large quantities, they can be produced at low cost by using inexpensive plastic molding fabrication techniques, making them suitable for consumer applications. Their operation is based on diffraction and constructive interferences between zones composing the lens with a 2π phase shift step at the transition zone. This leads to lightweight and thin plates compared to traditional lenses, while allowing for the same aperture and focal length figures. Figure 7 compares the profile of a diffractive Fresnel lens with a standard refractive lens. As can be seen, Fresnel lens antennas

are much thinner than a conventional refractive lens, thus reducing the size and weight of the antenna.

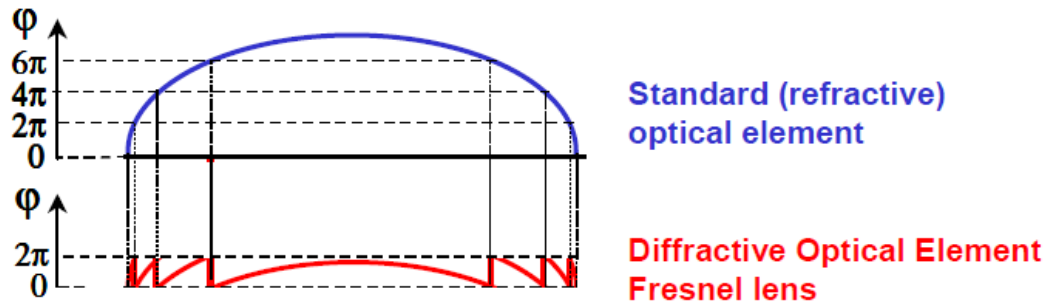

Figure 7. From a standard refractive lens to a diffractive optical element: the Fresnel lens

Because of their diffraction operation, Fresnel lenses suffer from narrowband operation due to the phase relation between each zone and from reduced efficiency due to angular shadowing effect for high numerical aperture lenses (i.e. at low F/D value).

To obtain the required performance for a Q-band low-profile high-gain antenna, several innovative lens designs are being investigated in the SARABAND project. To this end, optical techniques are used to develop and design innovative “quasi-optical” RF components, which are based on sub-wavelength structures; i.e., a family of optical components composed of features with size smaller than the operating wavelength that behave like an effective index medium. Such devices allow overcoming the usual Fresnel-lens limitations as they do not suffer from efficiency and bandwidth reduction when implemented in a low-profile configuration, while providing an efficient diffractive design and a low-profile RF lens. Therefore, sub-wavelength binary diffractive lens provides the key requirement for the target application.

An example of the on-going investigation is presented on Figure 8, where the comparison between bulk hyperbolic design and structured design is illustrated. In the studied antenna configuration (same aperture size, same feeder position), the sub-wavelength structured lens

thickness is reduced by a factor 4.5 compared to the bulk configuration while allowing both efficiency and gain enhancement (up to 1 dB) in the required frequency band.

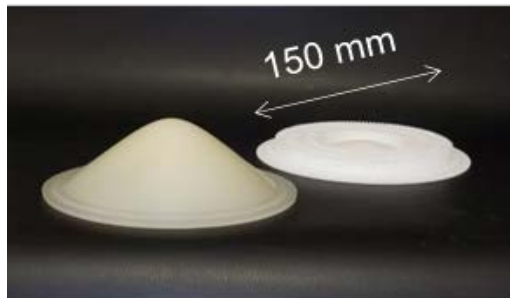

Figure 8. Comparison between bulk hyperbolic lens and structured lens (for Q-band operation)

Based on these preliminary results, the Table 1 summarizes the pros and cons of the previously presented technologies for the lens.

	Thickness	Reflection losses	Design process	Shadow effect	Feature size	Technology for Q-band
Refractive element	big	big	easy	no	$\gg \lambda$	easy
Diffractive element (classical)	small	medium	easy	yes	$> \lambda$	easy
Diffractive element (sub- λ)	small	medium	complex	no	$< \lambda$	easy

Table 1. Selected features of the different technologies presented for lens antennas

1.2.2. Fabry-Perot antennas

Fabry-Perot (FP) antennas are an attractive antenna solution to meet the point-to-point communication requirements as they are planar structures capable of offering a highly directive beam. Compared to other point-to-point antenna technologies such as horn antennas, the FP antenna has the advantage of being low-profile, discrete and lightweight. Furthermore, as compared to a standard microstrip patch array, the FP antenna has the advantage of requiring a simple and low-loss feed mechanism since a single source or a small number of sources are required to excite the leaky wave inside the cavity. The FP antenna is a type of leaky wave antenna consisting of a dielectrically filled cavity that is backed by a totally reflective surface (TRS) such as a ground plane at the bottom and a partially reflective surface (PRS) at the top [15]. The side walls of the cavity usually remain open. The excitation

mechanism is done by using a source that is placed inside the cavity. Figure 9 shows a scheme of the FP cavity antenna.

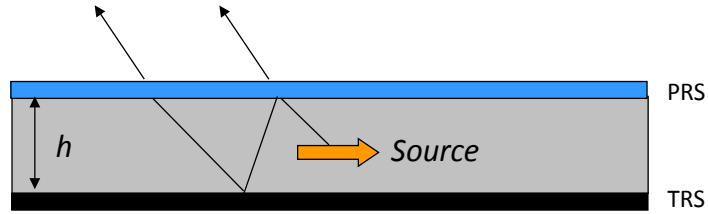

Figure 9. Fabry-Perot cavity antenna

With an appropriate design, parallel plate types of modes are excited in the cavity by the source. The power carried by the modes leaks through the PRS and leads to a broadside pencil-beam in the far-field. The distance between the two reflecting surfaces (h) of the cavity and the source position are important antenna parameters. Considering that the source is positioned at the same level as the TRS, the power radiated in the boresight direction is maximum when the following condition is satisfied:

$$\phi_R + \psi_R - \frac{2\pi}{\lambda} \cdot 2h = 2n\pi ,$$

where ϕ_R is the reflection phase of the PRS, ψ_R is the reflection phase of the TRS, h is the Fabry-Perot cavity height, and $n = 0,1,2,3,\dots$. The above equation states the phase condition for efficient radiation. Phase shifts of the wave originating from the source are introduced by successive reflections on the PRS and TRS and by the propagation path length in the cavity. The relationship assumes that the wave originating from the source is a plane wave in the direction normal to the reflecting surfaces, which is not entirely true in practice.

For Q-band application, the following design guidelines are considered:

- *PRS design*: The PRS is a type of periodic structure similar to a Frequency Selective Surface (FSS) [16-17] that can be made by various means. One option consists of using a single low-loss dielectric slab or a thin metallic plate. The latter solution has the

advantage of limiting the losses since no dielectric material is present in the PRS. Another option is to use multiple layers of periodic elements.

- *Cavity design:* The FP cavity can be filled with dielectric slabs or air. Although the dielectric slab option provides mechanical support to the structure, the air-filled cavity option provides the best compromise for maximum directivity and pattern bandwidth while reducing significantly the total loss in the antenna.
- *Cavity height:* The resonant nature of the FP cavity makes the antenna sensitive to the height variation of the cavity. In view of overcoming manufacture tolerances of the PRS and other antenna components, a variability of the cavity height should be envisaged. This could easily be done with an air-filled cavity with a tuning screw moving the PRS up and down or alternatively by using dielectric spacers with different heights.
- *Source:* The basic FP antenna configuration is excited by a source, which is composed of a single radiating element of low directivity. The size of the source is typically half-wavelength, which is small in comparison to the size of the PRS. For instance, considering a large PRS with a length of 10 wavelengths, the source is 20 times smaller than the PRS. Depending on the source type, the vertical position of the source can be chosen to maximise the power radiated by the source [15]. For instance, a horizontal electric dipole source should be placed at mid-height in the cavity, where the horizontal electric field of the leaky mode is maximum. On the contrary, a horizontal magnetic dipole source should be placed on the TRS to radiate maximum power. The high directivity property of the antenna is achieved with a proper utilization of the PRS aperture. A homogeneous energy distribution across the PRS aperture is required to obtain maximum directivity values. Basic FP antennas have a fixed directivity-bandwidth product. An improved energy distribution on the PRS aperture can be

achieved by feeding the FP cavity with an array of elements. These types of configurations result in even higher directivity values as compared to a single element source.

For the SARABAND project, the proposed antenna configuration is based on an air-filled FP cavity in order to reduce loss. The PRS is made of periodic patches (2.88 mm × 2.88 mm with a 4.2 mm square periodicity) printed on a 0.51mm thick dielectric substrate and is placed at 2.79mm above the TRS. A patch is used as the source for the excitation of the air-filled FP cavity. Figure 10 shows a Q-band FP antenna prototype with 15-dB gain. The use of multiple sources inside the cavity is being investigated to increase the antenna gain.

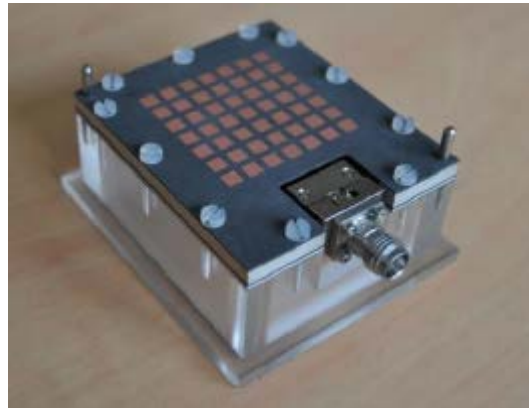

Figure 10. FP antenna prototype at Q-band

2. ANTENNAS WITH ELECTRONIC BEAM SCANNING CAPABILITIES

Besides low-profile high-gain antennas, smart antennas are a key element for next generation multi-gigabit backhaul networks. Typical antennas in communication systems have a fixed radiation pattern with a wide field of view to cover the whole area where potential users may sojourn. To efficiently make use of the allocated electromagnetic spectrum, minimize the cost of establishing new wireless networks, and ensure a service of constant quality it is necessary to adapt the antenna radiation pattern according to the instantaneous requirements and steer the antenna beam to the connected users. To this end, programmable Q-band antennas with

electronic beamforming and beam scanning capability, which adapt dynamically to the changing environment and form the antenna radiation pattern to provide optimum system performance, are required.

In particular, agile circular configurations for large field of view and several approaches for antennas with reduced field of view are analyzed.

2.1. Agile antennas with large field of view

A large number of publications focus on the principle of beam steering using the parasitic array concept, e.g. [18-20] and associated references. The parasitic radiators are electronically reconfigurable by either continuously tuneable or switchable loads, resulting in electronic beam scanning or shaping capability. The parasitic elements are typically placed at equiangular distances on a circular path, whose centre is the position of the active element, allowing for beam scanning or beam shaping in a single plane. Such a configuration employing switchable loads is called a circular switched parasitic array (CSPA) [19]. A conventional CSPA antenna with a monopole antenna as the central active element surrounded by parasitic monopoles is shown in Figure 11.

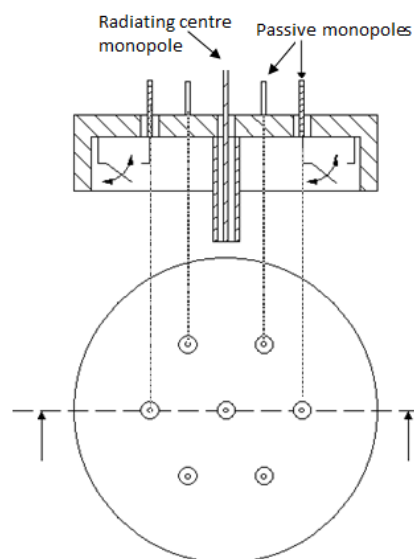

Figure 11. Basic concept of monopole CSPA antenna [19]

These monopoles have to be designed with a height of approximately $\lambda/4$. Also the distance between the active element and the parasitic elements should be approximately $\lambda/4$. By short circuiting (reflectors) and open circuiting (directors) the desired parasitic elements through switching circuits, beam steering in the required direction can be achieved. There are several options for loading the parasitic elements with electronically steerable RF loads. If only two states are sufficient PIN diodes, solid state switches, or micro mechanical switches can be applied. Continuously tunable loads can be realized by varactor diodes with a controlled DC bias voltage [19].

Two different designs for the steerable beam antenna, centered at 42 GHz, were investigated in the SARABAND project. The first approach is a CSPA antenna based on monopoles whereas the second one is based on microstrip technology. In both cases PIN diodes were considered to activate and deactivate the parasitic elements.

2.1.1. Monopole CSPA antenna

The antenna design is based on the enhanced monopole CSPA antenna with high RF transmit power for C-band proposed in [20]. This design uses wire monopole antennas as active and parasitic radiators, sharing a common metallic ground plane of circular shape with the active element placed at its center. The conventional configuration in [19] is complemented with a metallic top cover that forms, together with the likewise modified ground plane, a flared parallel plate waveguide (PPW) terminated by metallic skirts. The top cover is supported by a foam spacer and a cylindrical radome. A three-dimensional computer model of the enhanced C-band CSPA antenna and the radiation patterns for different angular directions are shown in Figure 12.

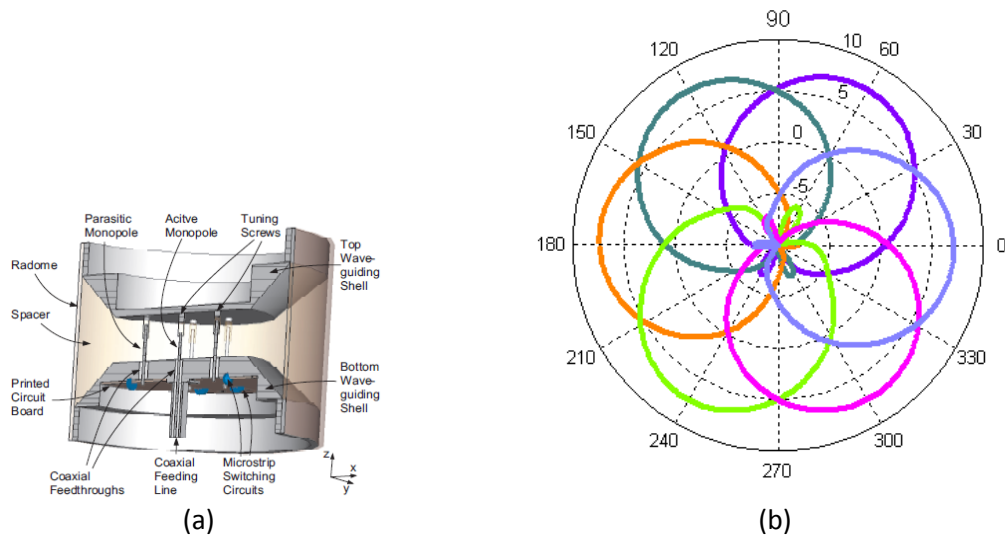

Figure 12. (a) Enhanced C-band CSPA antenna; (b) radiation pattern measured in [20]

This antenna design has a number of advantages since it has low fabrication cost, linear polarization, and selectable gain during the design process, and at the same time it offers sufficient relative bandwidth. For Q-band operation the design of the monopole-based CSPA is no longer convenient because the height of the monopoles would be only 1.8 mm ($\lambda/4$) and the additional circuitry would be much bigger than the antenna elements. So the antenna is designed resorting to printed microstrip technology based on the CSPA concept.

2.1.2. Printed microstrip CSPA antenna

In the printed microstrip CSPA antenna, the central radiating antenna is surrounded by switchable elements that act as reflectors or transparent elements depending on whether they are activated or deactivated through PIN diode switches. The antenna scanning is in the horizontal (azimuth) plane. A fabricated example of a fixed-beam antenna (without any switching elements) is shown in Figure 13. As the central active antenna cannot achieve high gain by itself, the radiated signal is guided through a circular flared horn structure. At the central frequency of 42 GHz, a standard horn structure would have a length of approximately 300 mm. Because of external limitations the size of the horn has to be reduced significantly, but this would result in the reduction of the antenna gain. Special measures are incorporated in the horn structure to reduce the size and increase the gain, and thus to achieve the desired

characteristics. Simulation results indicate that the designed antenna has a relative impedance bandwidth of 4.87 %, centred at 42 GHz, and a gain of approximately 16 dBi with a beamwidth of 6° and 60° in the E and the H plane, respectively, to cover a horizontal angular range of 360°. The simulated radiation patterns in the horizontal plane without the horn structure are shown in Figure 13 for various beam directions corresponding to different configurations of tuned/detuned reflector elements.



(a)

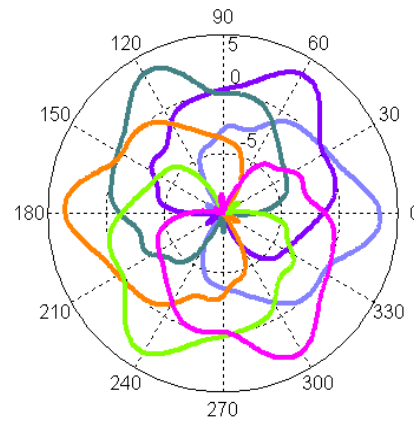

(b)

Figure 13.(a) Photograph of fabricated antenna proposed for Q-band; (b) Simulated radiation pattern without circumferential horn structure for the Q-band antenna

2.2. Agile antennas with reduced field of view

For beam scanning or switching within a reduced field of view several alternative planar structures are being investigated in the SARABAND project.

2.2.1. Reconfigurable aperture (RECAP) antennas

Reconfigurable aperture antennas (RECAP) appear a promising concept to shape the radiation pattern in various directions. As its name indicates, the antenna can have its aperture reconfigured so as to provide different antenna performance. The aperture reconfiguration tends to modify the current distribution on the radiating elements and leads to a different frequency of operation or a different radiated beam shape. The switched patch aperture is a good example of RECAP antennas [21]. The switched patch aperture is a planar antenna that is

based on an array of electrically small patches that are interconnected with switches. The state of the switches is optimised to provide an aperture configuration compatible with a given antenna coverage. This antenna concept allows optimisation of the radiation pattern in some predetermined direction by changing the state of the switches. Figure 14 show the basic structure of a RECAP antenna.

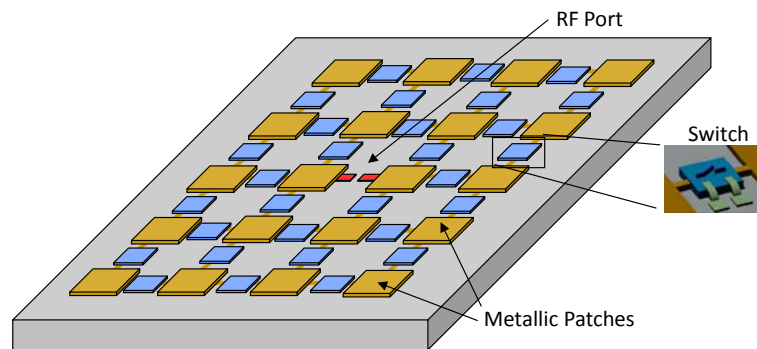

Figure 14. RECAP antenna basic structure

There are some technical issues associated with the design of RECAP antennas operating at Q-band. On one hand, the switches represent a tremendous technical challenge, as they can be difficult to integrate and lossy, resulting in a reduction of the antenna gain. On the other hand, the size of the patches is 273 microns, which can be difficult and expensive to manufacture.

2.2.2. Leaky wave antennas

Flat radiating panels based on leaky wave principles are attractive solutions as they provide compact, lightweight and discrete antennas. Many variants of these antennas have been proposed in the literature, with the travelling wave property the most common characteristic. With this type of structure, the radiation of electromagnetic waves occurs as the waves propagate along the antenna. Beam steering can be achieved by varying the propagation constant of the guided waves [22], as shown in Figure 15. The disadvantage of this technique is that the scan angle is frequency dependant, what limits its use for many applications. The alternative is to work with fixed frequency beam scanning techniques.

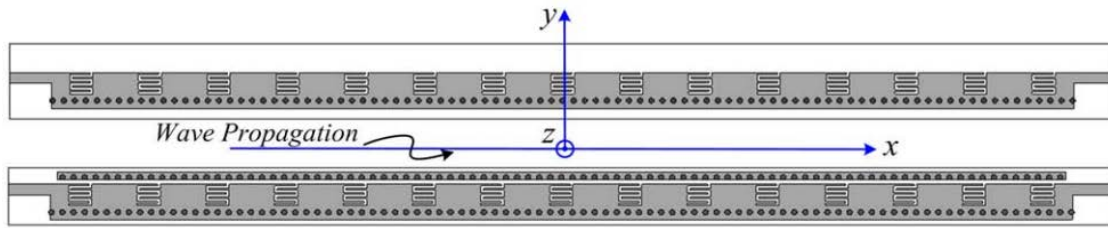

Figure 15. Example of a substrate integrated waveguide leaky wave antenna [22]

In the literature several proposals that provide beam steering capabilities in a limited field of view have been proposed [23-25]. The main disadvantage of these solutions with respect to the SARABAND requirements is that ghost beam effects are likely to be strong. This is due to the fact that a wide beamwidth is needed in the H plane (the scan plane). As a result, only a leaky aperture with a short length should be implemented in this plane, resulting in reflections from the end of the line.

2.2.3. Continuous Transverse Stub (CTS) antennas

Beam shape reconfiguration can be achieved with the Continuous Transverse Stub (CTS) technology. A CTS antenna differs significantly from other planar array and electronically-scanned array implementations in terms of architecture, radiator realization, coupling mechanism(s), and transmission-line properties. Figure 16 illustrates the typical architecture of a CTS antenna. The radiating structure is comprised of two parallel plates in which a guided wave is propagating. The top plate is comprised of a series of continuous transverse stubs opened to the air. These transverse-oriented stubs interrupt longitudinal current components within the parallel-plate structure, resulting in efficient radiation from such structures into free-space as a linearly-polarized wave [26]. A slight inclination of the stub with respect to the wave front inside the guide leads to a continuous phase shift along the stub. As a result, a beam can be steered in the plane parallel to the stub [27].

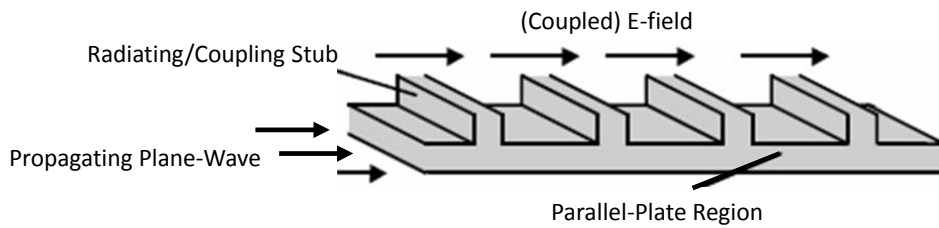

Figure 16. Typical cross-sectional view of a CTS antenna

While this technology can be used for satellite communication-on-the-move antenna applications, for the SARABAND project requirements, several difficulties related to the CTS technology can be identified:

- A plane wave launcher must be implemented within the CTS antenna. This is likely to make the antenna design complex and may increase the cost.
- Stubs with short lengths are needed to comply with the large beamwidth requirement in the H plane. Further investigations should be performed to verify that the principle of operation of the CTS antenna remains valid in this case.
- The antenna can be sensitive to ghost beam effects.

2.2.4. Microstrip array

Microstrip arrays represent an attractive antenna solution due to their benefits in terms of weight, cost and size. Reconfiguration of the beam direction is classically achieved with the integration of phase shifters. These phase shifters can either be added components that are mounted on a feed network circuit or be designed to be totally integrated with the antenna. Although phase shifters are good candidates for providing beam steering capabilities, at Q-band, the use of integrated components is likely to degrade the antenna gain performance and increase the cost.

The use of parasitic elements is more well-known for frequency tuning purposes; these elements can also be used for generating specific beam shapes. A number of publications

demonstrate the potentiality of this technique [28-31]. The principle of operation is based on EM coupling between elements to shape the beam pattern in the required direction. The antenna is usually comprised of one driven element, which is fed by a feed line, and one or several parasitic elements, which are physically close to the driven element so that coupling can take place. The position of the parasitic elements with respect to the driven element is an important parameter and can affect greatly the beam direction.

For Q-band operation, the antenna could be comprised of multiple panels providing different beam directions in a similar way to [28]. For example, for an azimuth coverage of 180° the antenna could be comprised of 3 radiating panels providing 3 beams directed at -60° from broadside, broadside, and $+60^\circ$ from broadside, as shown in Figure 17. Each radiating panel can be composed of a linear array of $1 \times N$ microstrip elements to provide the required beamwidth.

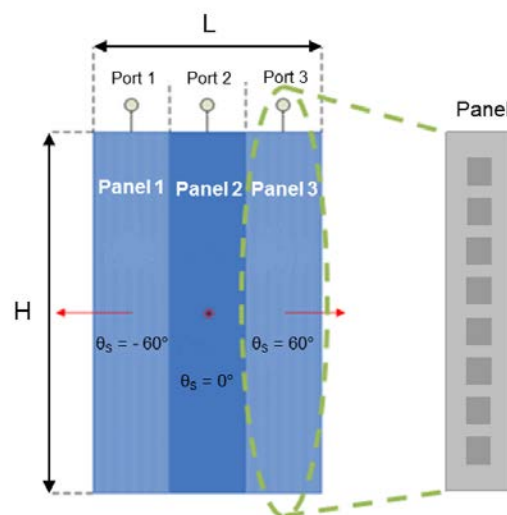

Figure 17. Proposed antenna architecture

3. Conclusion

Given the growing demand for bandwidth in mobile communication, service providers that depend on wireless backhaul solutions are turning to new, wider frequency spectral ranges to lower their backhaul costs. Wireless backhaul solutions operating in the Q-band have clear technological and economic advantages, such as significant bandwidth availability, resulting in massive amounts of capacity. For the full deployment of such backhaul networks improvement in Q-band antenna technology will be needed to enhance throughput, improve coverage, reduce interference and save energy. This paper presented a review of existing antennas technologies as a starting point to identify the most relevant structures to provide the required performances in terms of gain, size and cost in the Q-band. In particular, for low-profile high-gain antennas the most promising technologies are sub-wavelength structured lens and Fabry-Perot antennas. For programmable switchable antennas the CSPA approach and planar structures have been investigated. Along the paper on-going antenna development within the SARABAND project has been presented.

Acknowledgments

The research leading to these results has received funding from the European Commission's seventh Framework Programme under grant agreement no. 288267.

References

- [1] www.sarabandfp7.eu
- [2] C. A. Balanis, *Antennas Theory - Analysis and Design*, 3rd ed., John Wiley&Sons, Inc, 1997.
- [3] P. S. Nakar, "Design of a compact microstrip patch antenna for use in wireless/cellular devices," Master's thesis, The Florida State University, 2004.
- [4] R. Dakir, J. Zbitou, A. Mouhsen, A. Tribak, A. Mediavilla-Sanchez, and M. Latrach, "Rectangular Planar Antenna Using U-Slot for Bandwidth Improvement," *Electrical and Electronic Engineering*, vol. 3, no. 4, pp. 118-121, 2013.

- [5]H. Jeuland, "Array antenna design in millimeter waves," in *2nd SONDRRA Workshop*, 2010.
- [6] M. A. Islam, N. Karmakar, A. K. M. Azad, "Aperture coupled UWB microstrip patch antenna array for mm-Wave chipless RFID tag reader", in *IEEE International Conference on RFID Technologies and Applications (RFID-TA)*, 2012.
- [7] Y-C. Lilia Liu, Y. E. Wang, "A 16 × 16 Ka band aperture coupled microstrip planar array", in *IEEE Antennas and Propagation Society International Symposium*, 2007.
- [8] Y. Chong, D. Wenbin, "Microstrip series fed antenna array for millimetre wave automotive radar applications", in *Microwave Workshop Series on Millimeter Wave Wireless Technology and Applications (IMWS)*, 2012.
- [9] D. Pozar, "Design of millimetre wave microstrip reflectarrays," *IEEE Trans. Antennas Propagat.*, vol. 45, no. 2, pp. 287-296, Feb. 1997.
- [10] A. Munir, "Design of Planar Reflector Antenna Based-on Textured Surface Technology for S-band Satellite Television Receiver Application," *ITB Journal on ICT*, 2011.
- [11] www.bluwan.com
- [12] A. Petosa, and A. Ittipiboon, "Dielectric Lenses for LMCS Applications," in *Proc. International Conference on Electromagnetics in Advanced Applications (ICEAA'99)*, Sept. 1999, pp.273-276.
- [13]C. Chen, D.W. Prather, and P.H. Siegel, "Design of a 600 GHz Fresnel Lens Antenna for Passive and Active Imaging," in *Proc. IEEE Antennas and Propagation Society Int. Symp.*, Jun. 2007, pp. 4385-4388.
- [14]A.Petosa, N. Gagnon, and A. Ittipiboon, "Effects of Fresnel lens thickness on aperture efficiency," in *ANTEM*, 2004, pp.175-178.
- [15] D. Jackson, P. Burghignoli, G. Lovat, F. Capolino, J. Chen, D. Wilton, and A. Oliner, "The Fundamental Physics of Directive Beaming at Microwave and Optical Frequencies and the Role of Leaky Waves," *Proc. of the IEEE*, vol. 99, no. 110, pp. 1780-1805, 2011.

[16] B. Munk, "Frequency Selective Surfaces: Theory and Design", Wiley, 2000, ISBN: 978-0-471-37047-5.

[17] B. Munk, "Finite Antenna Arrays and FSS", Wiley-IEEE Press, 2003, ISBN: 978-0-471-27305-9.

[18] R.F. Harrington, "Reactively controlled directive arrays," *IEEE Trans. Antennas Propagat.*, vol.26, no.3, pp. 390-395, May 1978.

[19] H. Kawakami, and T. Ohira, "Electrically steerable passive array radiator (ESPAR) antennas," *IEEE Antennas Propagation Mag.*, vol. 47, no. 2, pp. 43–49, Apr. 2005.

[20] T. Bertuch, "A circular switched parasitic array antenna for high power data link applications," in *Proc. 3rd European Conference on Antennas and Propagation (EuCAP)*, Mar. 2009, pp. 2483-2487.

[21] L. Pringle, P. Harms, S. Blalock, G. Kiesel, E. Kuster, P. Friederich, R. Prado, J. Morris, and G. Smith, "A reconfigurable aperture antenna based on switched links between electrically small metallic patches," *IEEE Trans. Antennas Propagat.*, vol. 52, no. 6, pp. 1434-1445, Jun. 2004.

[22] Y. Dong, and T. Itoh, "Composite Right/Left-Handed Substrate Integrated Waveguide and Half Mode Substrate Integrated Waveguide Leaky-Wave Structures," *IEEE Trans. Antennas Propagat.*, vol. 59, no. 3, pp. 767-775, Mar. 2011.

[23] A. Suntives, and S. Hum, "A fixed-frequency beam steerable half-mode substrate integrated waveguide leakywave antenna," *IEEE Trans. Antennas Propagat.*, vol. 60, no. 5, pp. 2540-2544, May 2012.

[24] S. Matsuzawa, K. Sato, Y. Inoue, and T. Nomura, "Beam steering left-handed leaky wave antenna for millimetre-wave applications", in *Proc. IEEE Antennas and Propagation Society Int. Symp.*, Jul. 2005, pp. 709-712, vol. 1A.

[25] L. Huang, J. Chiao, and M. De Liso, "An electronically switchable leaky wave antenna," *IEEE Trans. Antennas Propagat.*, vol. 48, no.11, pp. 1769-1772, Nov. 2000.

[26] W. Milroy, "Continuous transverse stub element devices and methods of making the same," U.S. Patent, 5266961, Nov. 30, 1993.

- [27] W. Henderson, and W. Milroy, "Wireless communication applications of the continuous transverse stub(CTS) array at microwave and millimeter wave frequencies," in *Proc. IEEE/ACES International Conference*, 2005.
- [28] S. Zhang, G. Huff, J. Feng, and J. Bernhard, "A pattern reconfigurable microstrip parasitic array", *IEEE Trans. Antennas Propagat.*, vol. 52, no. 10, pp. 2773-2776, Oct. 2004.
- [29] S. Preston, D. Thiel, J. Lu, S. O'Keefe, and T. Bird, "Electronic beam steering using switched parasitic elements," *Electron.Lett.*, vol. 33, no. 1, pp. 07-08, Jan. 1997.
- [30] D. Thiel, S. O'Keefe, and J. Lu, "Electronic beam steering in wire and patch antenna systems using switched parasitic elements", in *Proc. IEEE Antennas and Propagation Society Int. Symp.*, Jul. 1996, pp. 534-537, vol.1.
- [31] M. Ali, T. Rahman, M. Kamarudin, M. Tan, and R. Sauleau, "Planar array antenna with parasitic elements for beam steering control," in *Proc. Progress In Electromagnetics Research Symp.*, Aug. 2009, pp. 181-185.