

NASA Technical Memorandum 87232

NASA TM 87232

NASA-TM-87232 19860012385

Quasi-Modal Vibration Control by Means of Active Control Bearings

Kenzou Nonami and David P. Fleming
Lewis Research Center
Cleveland, Ohio

Prepared for the
International Conference on Rotordynamics
cosponsored by the IFTOMM and the Japan Society of Mechanical Engineers
Tokyo, Japan, September 14-17, 1986



NF01502

NASA

LIBRARY COPY

JUN 16 1986

LANGLEY RESEARCH CENTER
LIBRARY NASA
HAMPTON, VIRGINIA

QUASI-MODAL VIBRATION CONTROL BY MEANS OF ACTIVE CONTROL BEARINGS

Kenzou Nonami* and David P. Fleming
National Aeronautics and Space Administration
Lewis Research Center
Cleveland, Ohio 44135

ABSTRACT

This paper investigates a design method of an active control bearing system with only velocity feedback. The study provides a new quasi-modal control method for a control system design of an active control bearing system in which feedback coefficients are determined on the basis of a modal analysis. Although the number of sensors and actuators is small, this quasi-modal control method produces a control effect close to an ideal modal control.

1. INTRODUCTION

There are two approaches to reduce the vibration of rotating shafts. One is the approach using passive elements and the other is the case using active elements.¹⁻¹³ The studies of the former based on damped flexible supports have been done by many authors. However, it is difficult to obtain desirable optimum tuned conditions in actual rotating machinery. Conversely, it is very easy for an active vibration control method to obtain desirable optimum values because the support conditions can be varied by only feedback coefficients. The first author proposed an active control bearing wherein the bearing housings are actively controlled by using a state feedback control method.^{12,13} The experiment for a two degree of freedom system proved that active control bearings are effective for vibration control of rotating shafts. However, for a multidegree of freedom system, it is necessary for a control system with state feedback to get complete state variables of displacements and velocities for a rotor system. A control system is thus complicated. Therefore, in the case of a multidegree of freedom system such as a multi-bearing and multi-disk system, active control bearings with only velocity feedback are to be desired. This paper investigates a design method of an active control bearing system with only velocity feedback. The study provides a new quasi-modal control method for a control system design of an active control bearing system in which feedback

coefficients are determined on the basis of a modal analysis. The features of the new quasi-modal control method proposed in this paper differ depending on the number of measurements and the number of controlled modes. There are three cases. The first case is when the number of measurements of vibration velocity is equivalent to the number of controlled modes. The second case when the number of measurements is less than the number of controlled modes. The third case is when the number of measurements is more than the number of controlled modes. The method does not depend on the number of active control bearings.

On the basis that it is sufficient for active control of a system to provide critical damping on each mode, the control system is assembled independently for each mode. Simulations of the active control of a three bearing and three disk rotor system are carried out to verify the efficiency of this method. Although the number of sensors and actuators is small, this quasi-modal control method produces a control effect close to an ideal modal control or an optimal state feedback control.

2. QUASI-MODAL VIBRATION CONTROL METHOD

2.1 Ideal Modal Control System Design Method

First, a control system design method is described in general. The following equation is considered.

$$M_n \ddot{x}_n + C_n \dot{x}_n + K_n x_n = p(t) + u(t) \quad (1)$$

where M_n , C_n , and K_n are mass, damping, and stiffness matrices. x_n is a general nodal displacement vector. $p(t)$ is a general nodal unbalance force vector and $u(t)$ is a general nodal control input vector. Equation (1) is written with n degree of freedom system. For x_n of Eq. (1), the following transformation is performed.

$$x_n = I a \quad \text{or} \quad a = I^{-1} x_n \quad (2)$$

where I is a modal matrix assumed to be normalized. With Eq. (2), Eq. (1) is transformed as follows:

$$I^T M_n I \ddot{a} + I^T C_n I \dot{a} + I^T K_n I a = I^T p(t) + I^T u(t) \quad (3)$$

*NRC NASA Research Associate, on leave from Chiba University, Yayoi-cho 1-33, Chiba 260, Japan.

E-2899

where $\underline{I}^T \underline{M}_n \underline{I}$ is a unit matrix, $\underline{I}^T \underline{K}_n \underline{I}$ is a diagonal frequency matrix, and

$$\underline{I}^T \underline{C}_n \underline{I} = \begin{bmatrix} c_{11} & & & \\ c_{21} & c_{22} & & \\ \vdots & \vdots & \ddots & \vdots \\ c_{n1} & c_{n2} & \dots & c_{nn} \end{bmatrix} \quad (4)$$

If constant damping coefficients (proportional damping) are assumed,

$$\underline{I}^T \underline{C}_n \underline{I} = \begin{bmatrix} c_{11} & & & 0 \\ & c_{22} & & \\ & & \ddots & \\ 0 & & & c_{nn} \end{bmatrix} = \underline{c} \quad (5)$$

Therefore Eq. (3) is reduced to the following equation.

$$\ddot{\underline{a}} + \underline{c} \dot{\underline{a}} + \underline{\Omega}^2 \underline{a} = \underline{I}^T \underline{P}(t) + \underline{I}^T \underline{U}(t) \quad (6)$$

where $\underline{\Omega}^2$ symbolizes a frequency matrix, and \underline{c} is a principal damping matrix. Thus Eq. (1) is reduced to Eq. (6) separated on each mode and uncoupled. It is very easy to determine the optimal control inputs to each mode in the above expressed modal domain. The input $\underline{I}^T \underline{U}(t)$ is taken to be a portion of critical damping times the modal velocity $\dot{\underline{a}}$. That is,

$$\underline{I}^T \underline{U} = \underline{F} \dot{\underline{a}} \quad (7)$$

$$\underline{F} = \begin{bmatrix} -2\zeta_1 \omega_1 & & & \\ & -2\zeta_2 \omega_2 & & 0 \\ & & \ddots & \\ 0 & & & -2\zeta_n \omega_n \end{bmatrix} \quad (8)$$

and $\zeta_1, \zeta_2, \dots, \zeta_n$ are modal damping ratios, or percentage of critical damping, and $\omega_1, \omega_2, \dots, \omega_n$ are undamped critical speeds.

If modal damping ratios inherent in the system (obtained by measurement) are very small, let $\zeta_i = 0.7$ ($i = 1, 2, \dots, n$) in Eq. (8). If the system damping is not negligible, then the values of ζ_i in Eq. (8) should be taken as 0.7 minus the measured value. The control input, from Eq. (7), is then

$$\underline{U} = (\underline{I}^T)^{-1} \underline{F} \dot{\underline{a}} \quad (9)$$

or, using the definition of \underline{a} (Eq. 2),

$$\underline{U} = \underline{G} \dot{\underline{x}}_n \quad (10)$$

where

$$\underline{G} = (\underline{I}^T)^{-1} \underline{F} \underline{I}^{-1} \quad (11)$$

In n degree of freedom system, if the number of control inputs or number of velocity measurements is less than n , this control system is not a true modal control system. This paper names such a control system a quasi-modal control system. For example, for two control force inputs and three vibration measurements, the quasi-modal control system is expressed as follows:

$$\underline{U} = \underline{G}' \dot{\underline{x}}_n \quad (12)$$

$$\begin{bmatrix} u_a \\ u_b \end{bmatrix} = \begin{bmatrix} g'_{11} & g'_{12} & g'_{13} \\ g'_{21} & g'_{22} & g'_{23} \end{bmatrix} \begin{bmatrix} \dot{x}_f \\ \dot{x}_q \\ \dot{x}_r \end{bmatrix} \quad (13)$$

where \underline{G}' is a modified feedback coefficient matrix. Determining \underline{G}' is the subject of the next section.

2.2 Modification of Feedback Coefficient for Quasi-Modal Control

Equation (11) provides feedback coefficients for the case when vibration velocities are measured at every station. If this is not the case, satisfactory control is unlikely using Eq. (11). Therefore for a quasi-modal control system, it is necessary to modify the value of \underline{G} depending on the number of measurements and positions of measurements (probe locations) in order to produce the maximum of control efficiency. The assumptions are as follows; (1) the number of active control bearings and their positions are given, (2) the vibration from the first mode to the s th mode ($s < n$) is to be controlled, and (3) the positions of measurements (probe locations) are unconstrained. The modification of \underline{G} differs depending on the number of measurements and the number of controlled modes. They are divided into three cases depending on the relationship of the number of measurements (k) to the number of controlled modes (s): (1) $k = s$, (2) $k < s$, and (3) $k > s$.

2.2.1 Case when the number of measurements of vibration velocity is equivalent to the number of controlled modes. ($k = s$). As the first step, write the \underline{G} matrix with zero rows where there are no active control bearings.

$$\underline{G}_1 = \underline{H}^{-1} \underline{F} \underline{I}^{-1} = \begin{matrix} & \text{locations of measurements} \\ & \downarrow \quad \downarrow \quad \downarrow \\ \begin{bmatrix} 0 & 0 & \dots & 0 \\ g_{a1} & g_{a2} & \dots & g_{an} \\ g_{b1} & g_{b2} & \dots & g_{bn} \\ \vdots & \vdots & \ddots & \vdots \\ g_{e1} & g_{e2} & \dots & g_{en} \\ 0 & 0 & \dots & 0 \end{bmatrix} & \left\{ \begin{array}{l} \text{locations of active} \\ \text{control} \\ \text{bearings} \end{array} \right. \end{matrix} \quad (14)$$

From Eq. (14), the locations of active control bearings are positions in which row vectors in the matrix \underline{G} are not zero.

For the first mode, the control force coefficients supplied to each active control bearing may be computed by using \underline{G} from Eq. (14).

$$V_1 = \underline{G}_1 T_1 = \begin{bmatrix} 0 & 0 & \dots & 0 \\ g_{a1} & g_{a2} & \dots & g_{an} \\ g_{b1} & g_{b2} & \dots & g_{bn} \\ \cdot & \cdot & \cdot & \cdot \\ \cdot & \cdot & \cdot & \cdot \\ g_{e1} & g_{e2} & \dots & g_{en} \\ 0 & 0 & \dots & 0 \end{bmatrix} \begin{bmatrix} t_{11} \\ t_{21} \\ \cdot \\ \cdot \\ t_{n1} \end{bmatrix} = \begin{bmatrix} 0 \\ v_{a1} \\ v_{b1} \\ \cdot \\ \cdot \\ v_{e1} \\ 0 \end{bmatrix} \quad (15)$$

where $[t_{11}, t_{21}, \dots, t_{n1}]^T$ is the eigen vector for the first mode in the modal matrix T . Namely, this vector multiplied by an angular velocity ω and modal amplitude is the first modal component of the vibration velocity vector. On the right side of Eq. (15), $v_{a1}, v_{b1}, \dots, v_{e1}$ are the control force coefficients supplied to positions a, b, \dots, e to actively control the first mode vibration. In the same manner for the other modes, the following relations are obtained.

$$V_2 = \underline{G}_1 T_2 = \begin{bmatrix} 0 \\ v_{a2} \\ v_{b2} \\ \cdot \\ \cdot \\ v_{e2} \\ 0 \end{bmatrix}, \dots, V_s = \underline{G}_1 T_s = \begin{bmatrix} 0 \\ v_{as} \\ v_{bs} \\ \cdot \\ \cdot \\ v_{es} \\ 0 \end{bmatrix} \quad (16)$$

Combining these relations,

$$\begin{bmatrix} 0 & 0 & \dots & 0 \\ g_{a1} & g_{a2} & \dots & g_{an} \\ g_{b1} & g_{b2} & \dots & g_{bn} \\ \cdot & \cdot & \cdot & \cdot \\ \cdot & \cdot & \cdot & \cdot \\ g_{e1} & g_{e2} & \dots & g_{en} \\ 0 & 0 & \dots & 0 \end{bmatrix} \begin{bmatrix} t_{11} & t_{12} & \dots & t_{1s} \\ t_{21} & t_{22} & \dots & t_{2s} \\ \cdot & \cdot & \cdot & \cdot \\ \cdot & \cdot & \cdot & \cdot \\ t_{n1} & t_{n2} & \dots & t_{ns} \end{bmatrix} = \begin{bmatrix} 0 & 0 & \dots & 0 \\ v_{a1} & v_{a2} & \dots & v_{as} \\ v_{b1} & v_{b2} & \dots & v_{bs} \\ \cdot & \cdot & \cdot & \cdot \\ \cdot & \cdot & \cdot & \cdot \\ v_{e1} & v_{e2} & \dots & v_{es} \\ 0 & 0 & \dots & 0 \end{bmatrix} \quad (17)$$

The right side of Eq. (17) shows the control force coefficients supplied on each mode to each position of active control bearings. The control forces applied to any one bearing are independent of the forces applied to the other bearings. With respect to the active control bearing at position a , it is the most desirable to supply control forces of v_{a1} for the first mode, v_{a2} for the second mode, \dots , and v_{as} for the s th mode. Therefore, even if the number of vibration velocities measured are less than n , we only have to modify the elements in the matrix \underline{G} to satisfy the right side of Eq. (17).

As the number of measurements (k) equals the number of controlled modes (s) from assumption, replacing n with s and writing Eq. (17) again after omitting zero elements, we obtain the following expression.

$$\begin{bmatrix} g'_{a1} & g'_{a2} & \dots & g'_{as} \\ g'_{b1} & g'_{b2} & \dots & g'_{bs} \\ \cdot & \cdot & \cdot & \cdot \\ \cdot & \cdot & \cdot & \cdot \\ g'_{e1} & g'_{e2} & \dots & g'_{es} \end{bmatrix} \begin{bmatrix} t_{11} & t_{12} & \dots & t_{1s} \\ t_{21} & t_{22} & \dots & t_{2s} \\ \cdot & \cdot & \cdot & \cdot \\ \cdot & \cdot & \cdot & \cdot \\ t_{s1} & t_{s2} & \dots & t_{ss} \end{bmatrix} = \begin{bmatrix} v_{a1} & v_{a2} & \dots & v_{as} \\ v_{b1} & v_{b2} & \dots & v_{bs} \\ \cdot & \cdot & \cdot & \cdot \\ \cdot & \cdot & \cdot & \cdot \\ v_{e1} & v_{e2} & \dots & v_{es} \end{bmatrix} \quad (18)$$

$r \times s \qquad \qquad \qquad s \times s \qquad \qquad \qquad r \times s$

or

$$G'T = V \quad (19)$$

where the dimensions of the matrices G' and V are $r \times s$ and the matrix T has the dimension $s \times s$. From Eq. (19), we have

or

$$G' = VT^{-1} \quad (20)$$

The matrix G' is the modified feedback coefficient matrix to be used instead of the matrix G . In Eq. (11) G' is the one and only solution.

The number of active control bearings is equivalent to the number of row vectors of the matrix G' in Eqs. (20) and (21), namely r . Whether $r > s$ or $r < s$, the matrix G' is certainly determined. However, the eigen value assignments and the unbalance responses actually depend on the number of active control bearings as shown later. In this section, an optimization of control inputs is carried out concerning how to supply the control forces to active control bearings assigned. Even if the number of measurements of vibration velocities is at most equivalent to the number of controlled modes, it is possible to achieve the control effect similar to the case when the number of measurements is n . It is important to note that this control effect does not depend on the location of measurements.

2.2.2 Case when the number of measurements of vibration velocity is less than the number of controlled modes. ($k < s$). In this case, Eq. (18) appears as

$$\begin{bmatrix} g_{a1}^i & g_{a2}^i & \dots & g_{ak}^i \\ g_{b1}^i & g_{b2}^i & \dots & g_{bk}^i \\ \vdots & \vdots & \ddots & \vdots \\ g_{e1}^i & g_{e2}^i & \dots & g_{ek}^i \end{bmatrix} \begin{bmatrix} t_{11} & t_{12} & \dots & t_{1s} \\ t_{21} & t_{22} & \dots & t_{2s} \\ \vdots & \vdots & \ddots & \vdots \\ t_{k1} & t_{k2} & \dots & t_{ks} \end{bmatrix} = \begin{bmatrix} v_{a1} & v_{a2} & \dots & v_{as} \\ v_{b1} & v_{b2} & \dots & v_{bs} \\ \vdots & \vdots & \ddots & \vdots \\ v_{e1} & v_{e2} & \dots & v_{es} \end{bmatrix} \quad (21)$$

$r \times k$ $k \times s$ $r \times s$

or

$$G^i T = V \quad (22)$$

where the matrix G^i has the dimension $r \times k$ ($k < s$), the matrix T has $k \times s$ and the matrix V has $r \times s$. Thus T becomes a rectangular matrix and cannot be inverted. Therefore, the number of controlled modes is reduced to k to be able to get the inversion of the matrix. After this reduction, matrices T and G'' are obtained as follows:

$$\begin{bmatrix} g_{a1}'' & g_{a2}'' & \dots & g_{ak}'' \\ g_{b1}'' & g_{b2}'' & \dots & g_{bk}'' \\ \vdots & \vdots & \ddots & \vdots \\ g_{e1}'' & g_{e2}'' & \dots & g_{ek}'' \end{bmatrix} \begin{bmatrix} t_{11} & t_{12} & \dots & t_{1k} \\ t_{21} & t_{22} & \dots & t_{2k} \\ \vdots & \vdots & \ddots & \vdots \\ t_{k1} & t_{k2} & \dots & t_{kk} \end{bmatrix} = \begin{bmatrix} v_{a1} & v_{a2} & \dots & v_{ak} \\ v_{b1} & v_{b2} & \dots & v_{bk} \\ \vdots & \vdots & \ddots & \vdots \\ v_{e1} & v_{e2} & \dots & v_{ek} \end{bmatrix} \quad (23)$$

$r \times k$ $k \times k$ $r \times k$

or

$$G'' T' = V \quad (24)$$

Accordingly,

$$G'' = V(T')^{-1} \quad (25)$$

Then, it requires the following consideration for the modes eliminated from a control object.

Assuming that the modes eliminated are i th and j th, we estimate errors as regards the i th and the j th modes between the control force determined by Eq. (25) and the optimal control force in section 2.2.1 using the matrix G' (Eq. (18))

$$\begin{bmatrix} g_{a1}'' & g_{a2}'' & \dots & g_{ak}'' \\ g_{b1}'' & g_{b2}'' & \dots & g_{bk}'' \\ \vdots & \vdots & \ddots & \vdots \\ g_{e1}'' & g_{e2}'' & \dots & g_{ek}'' \end{bmatrix} \begin{bmatrix} t_{1i} & t_{1j} \\ t_{2i} & t_{2j} \\ \vdots & \vdots \\ t_{ki} & t_{kj} \end{bmatrix} = \begin{bmatrix} \hat{v}_{a1} & \hat{v}_{aj} \\ \hat{v}_{b1} & \hat{v}_{bj} \\ \vdots & \vdots \\ \hat{v}_{e1} & \hat{v}_{ej} \end{bmatrix} \quad (26)$$

where $\hat{v}_{a1}, \hat{v}_{b1}, \dots, \hat{v}_{e1}$ and $\hat{v}_{aj}, \hat{v}_{bj}, \dots, \hat{v}_{ej}$ of the right side are control forces supplied for the i th and the j th modes eliminated. Accordingly, k positions of measurements have to be optimized so as to satisfy the following performance index.

$$J = \min \left[(v_{a1} - \hat{v}_{a1})^2 + (v_{b1} - \hat{v}_{b1})^2 + \dots + (v_{e1} - \hat{v}_{e1})^2 + (v_{aj} - \hat{v}_{aj})^2 + (v_{bj} - \hat{v}_{bj})^2 + \dots + (v_{ej} - \hat{v}_{ej})^2 \right] \quad (27)$$

The dynamic characteristics sensitivity depends on k positions of measurements in this case. In general, it is impossible to realize $J = 0$; however it is possible to make J small. It is very important to find out the optimal positions of measurements. Moreover, it has to be also evaluated which mode can minimize the performance index J .

2.2.3 Case when the number of measurements of vibration velocity is more than the number of controlled modes. ($k > s$). This case is $k > s$ in contrast to section 2.2.2. We only have to determine the feedback coefficients by increasing controlled modes as to $k = s$.

The three cases above mentioned are summarized as follows: (1) in the first case of $k = s$, unique feedback coefficients are determined independent of measuring positions and the number of active control bearings, (2) in the second case of $k < s$, the feedback coefficients are not determined such as the first case. Accordingly, the number of controlled modes must be decreased so the number of controlled modes agrees with the number of measurements. Then the feedback coefficients can be determined. After this, on the basis of a performance index for uncontrolled modes, the positions of measurements must be selected so as to minimize the performance index. These positions of measurements are the best positions to measure and the feedback coefficients in this case are best for vibration control. (3) In the third case of $k > s$, as in the second case, feedback coefficients are not determined. In this case, contrary to the second case, the number of controlled modes must be increased.

The control effect in the case where velocities are measured at all positions can be realized by measuring velocities at only s positions

minimize the performance index. It is possible to control a vibration of rotating shaft from the first mode to the third mode as shown in Fig. 5 (a) and (b). The first mode is evaluated for the performance index J in this example.

4. CONCLUSION

According to the results of the simulations, if the optimal feedback coefficients are chosen, the unbalance vibration up to the third mode can be sufficiently controlled by means of only two active control bearings and measurements of vibration velocities at only two locations. The unbalance amplitude can be reduced to less than the center of gravity eccentricity. In this case, it is very important to choose the positions of measurements to avoid instability.

The quasi-modal control method for active control of rotor vibrations proposed in this paper results in near maximum control efficiency using the minimum number of active control bearings and the minimum measurements of vibration velocities.

REFERENCES

1. Schweitzer, G.: Dynamics of Rotors, Springer, New York, 1975, pp. 472-493.
2. Nikolajsen, J.L., Holmes, R., and Gondhalekar, V.: Investigation of an Electromagnetic Damper for Vibration Control of a Transmission Shaft, Proc. Inst. Mech. Eng., Vol. 193, 1979, pp. 331-336.
3. Moore, J.W., Lewis, D.W., and Heizman, J.D.: Feasibility of Active Feedback Control of Rotordynamic Instability, NASA CP-2133, 1980, pp. 467-476.
4. Lewis, D.W., Moore, J.W., Bradley, P.L., and Allaire, P.E.: Vibration Limiting of Rotors by Feedback Control, NASA CP-2250, 1982, pp. 434-439.
5. Salm, J., and Schweitzer, G.: I. Mech. E. Conf. C277/84, 1984, p. 553.
6. Ulbrich, H., and Anton, E.: I. Mech. E. Conf. C299/84, 1984, p. 543.
7. Gondhalekar, V., and Holmes, R.: Design of Electromagnetic Bearing for Vibration Control of Flexible Transmission Shaft, NASA CP-2338, 1984, pp. 351-364.
8. Stanway, R., and Burrows, C.R.: Active Vibration Control of a Flexible Rotor on Flexibly-Mounted Journal Bearings. Trans. of the ASME, J. Dyn. Meas. Control, Vol. 103, No. 4, 1981, pp. 383-388.
9. Stanway, R., and O'Reilly, J.: I. Mech. E. Conf. C274/84, 1984, p. 515.
10. Anton, E., and Ulbrich, H.: Active Control of Vibrations in the Case of Asymmetrical High-Speed Rotors by Using Magnetic Bearings, Trans. of the ASME, J. Vibr. Acoust. Stress Rel. Des., Vol. 108, No. 1, 1986, p. 1-6.
11. Redmond, I., Mclean, R.F., and Burrows, C.R.: Vibration Control of Flexible Rotors, American Society of Mechanical Engineers, New York, NY, ASME Paper 85-DET-127, Sept. 1985.
12. Nonami, K.: Flexural Vibration Control of Rotating Shaft System by Means of Active Control Bearings, Trans. JSME, Vol. 51, No. 470, 1985, pp. 2463-2472. (In Japanese).
13. Nonami, K.: Vibration Control of Rotor Shaft Systems by Active Control Bearings, American Society of Mechanical Engineers, New York, NY, ASME Paper 85-DET-126, Sept. 1985.

in the first case and the third case. In all three cases, the greater the number of active control bearings, the better the response of vibration control will be.

3. MODEL OF ROTOR-BEARING SYSTEM AND SIMULATION

3.1 Rotor Model and Equation of Motion

Simulations of a three bearing and three disk rotor system are carried out in this chapter. The rotor model and its undamped natural modes are shown in Fig. 2. The equation of motion is derived by a finite element method. In this case, the equation of motion is a fourteenth-order matrix differential equation because this rotor model is divided into six elements. Now, it is assumed that there are three active control bearings at positions 1, 3, and 6 and this system is uncoupled between x and y directions. The vibrations from the first mode to the third mode are to be controlled and it is possible to measure vibration velocities at any position. For simplicity, only measurements in the x direction are considered.

3.2 Case When the Number of Measurements of Vibration Velocity is Equivalent to the Number of Controlled Modes

This section describes the case where the number of measurements of vibration velocities is three. In order to investigate the stability of the rotor-bearing system, a complex eigenvalue analysis is carried out and the eigenvalues are shown on a complex plane as an eigenvalue assignment. The unbalance responses in these cases are also shown. Figure 3 (a) and (b) shows the eigenvalue assignment and their unbalance responses. In the case of three inputs and three outputs like this one, it is observed that the unbalance responses are almost the same independent of the positions of measurements. The unbalance responses are similar to the case in which all velocities at all positions are measured. This section also shows the responses when the number of active control bearings is changed. These results prove the summary in chapter 2.

3.3 Case When the Number of Measurements of Vibration Velocity is Less than the Number of Controlled Modes

This section illustrates the case of three control inputs and two measurements as the second case in chapter 2. The control characteristics depend on the mode of the performance index. The positions where the performance index is minimum should be selected for measuring positions of vibration velocities. These are shown in Fig. 4 (a) and (b) as typical example. These show the case in which the performance index J is based on the third mode. These figures indicate that measuring positions x_1 and x_2 are the best positions in this case. Since some cases become unstable in such a system with three inputs and two outputs, care is required in the selection of measuring positions to avoid having unstable modes.

Lastly, Fig. 5 shows the case of two control inputs and two measurements where both the number of measurements and the number of active control bearings are less than the number of controlled modes. Even if there are only two active control bearings, the maximum effect is afforded by selecting the positions of measurements so as to

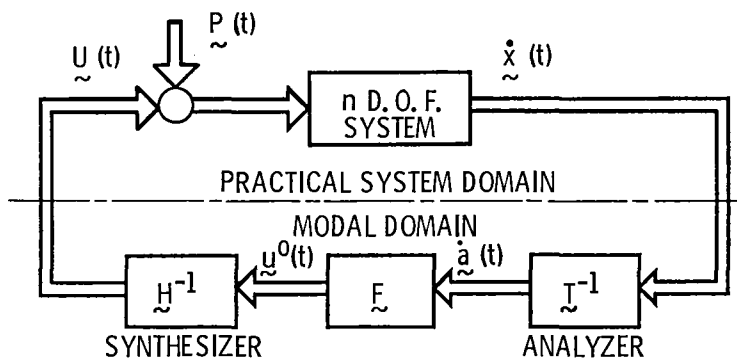
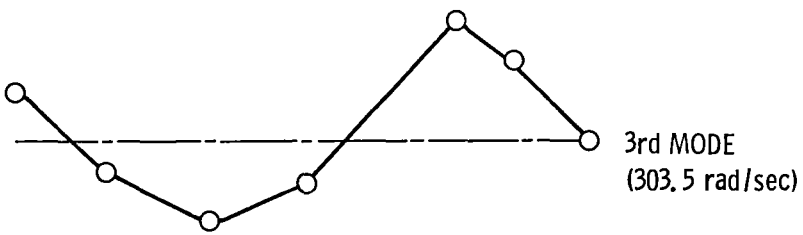
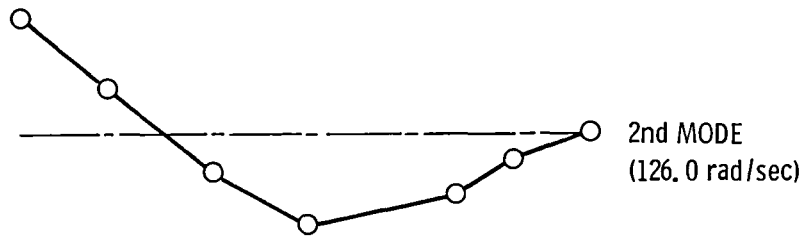
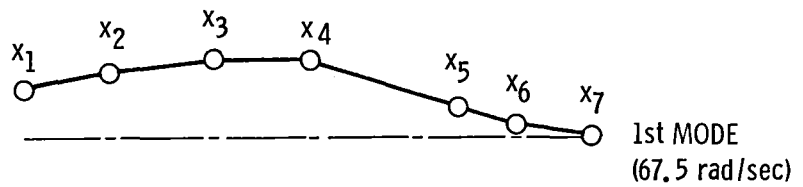
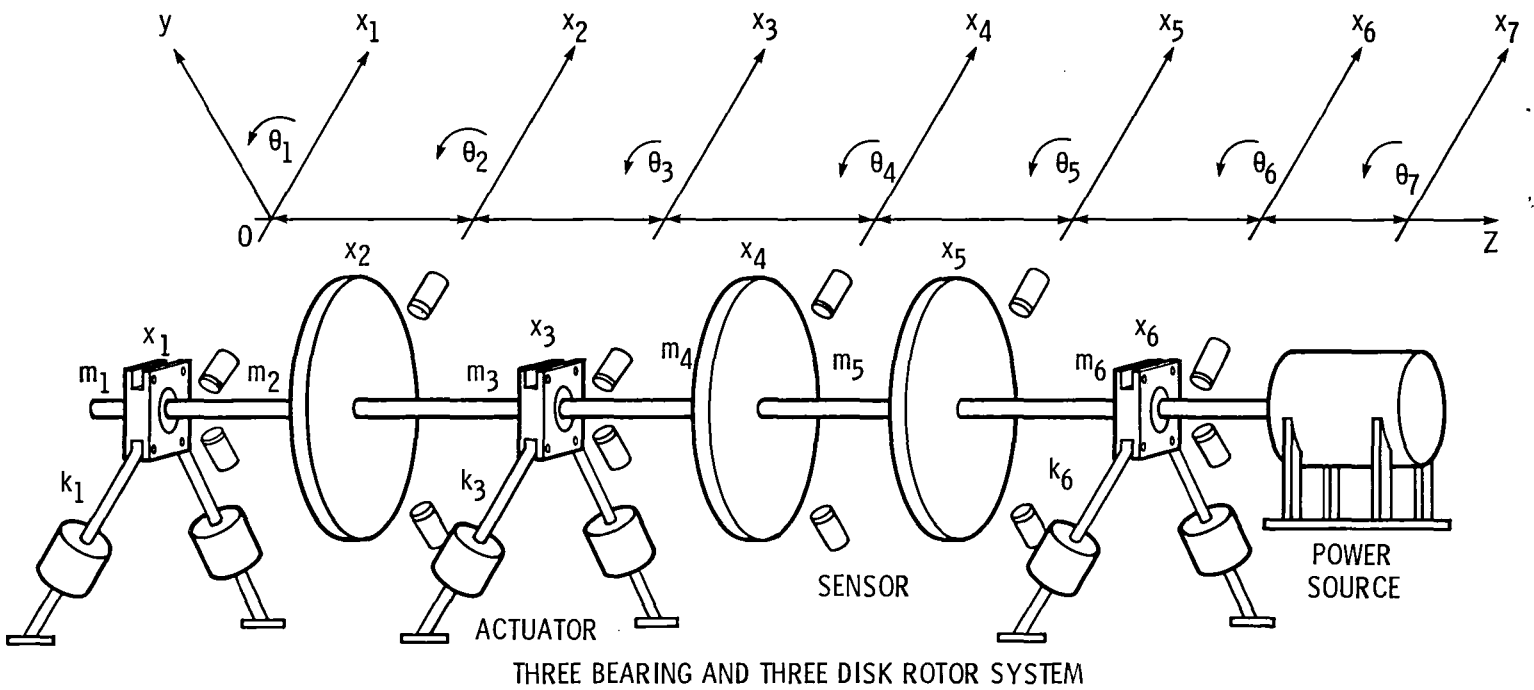
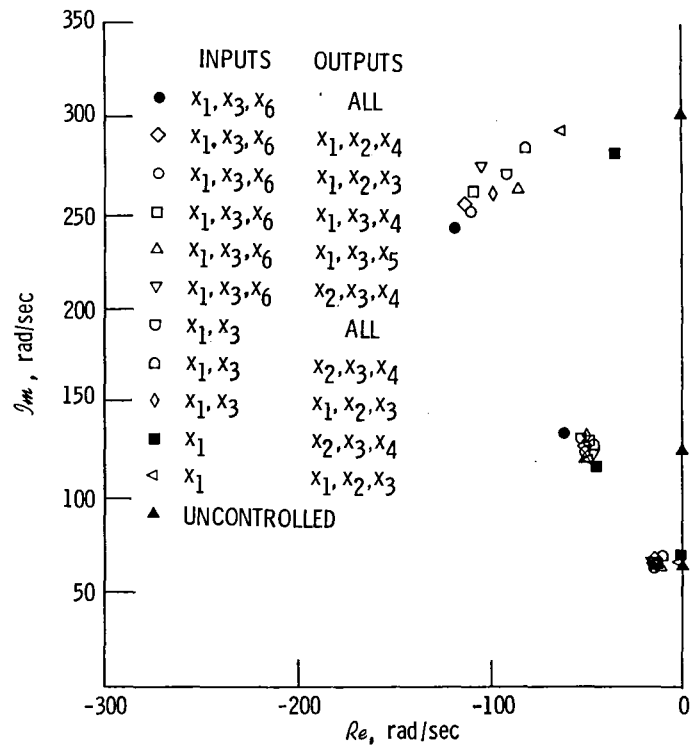

Figure 1. - Modal control system with velocity feedback.



UNDAMPED NATURAL MODES

Figure 2. - Rotor model and undamped natural modes.



(a) Eigenvalue assignment.

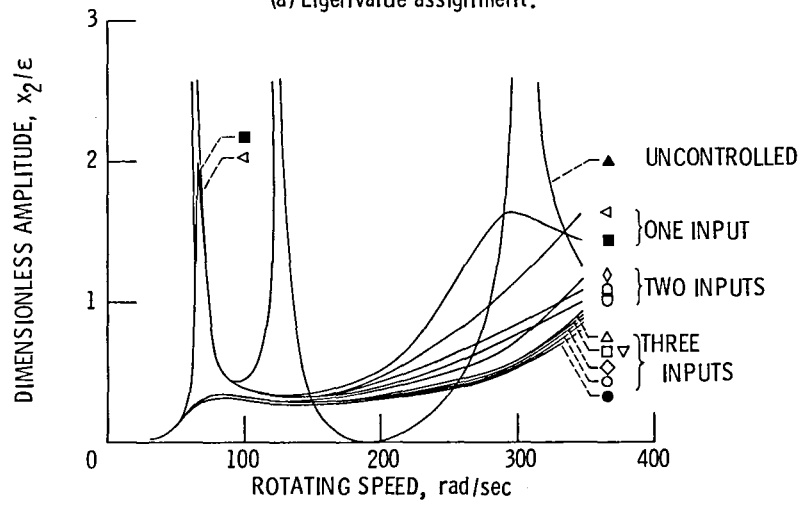

(b) Unbalance response.

Figure 3. - Eigenvalue assignment and unbalance response.

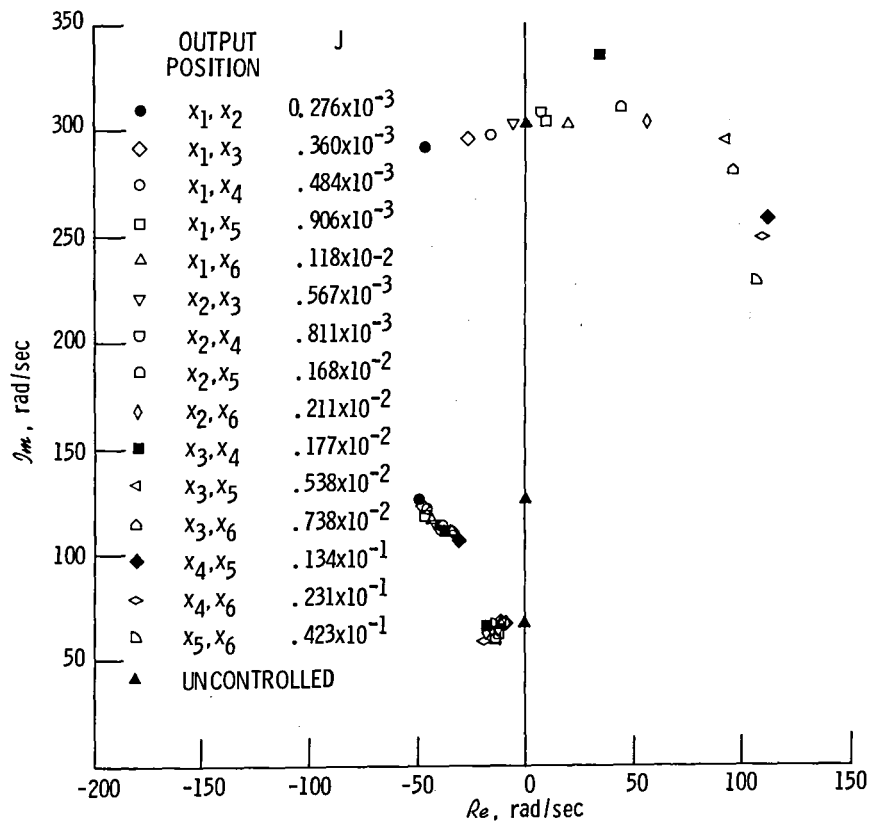

(a) Eigenvalue assignment.

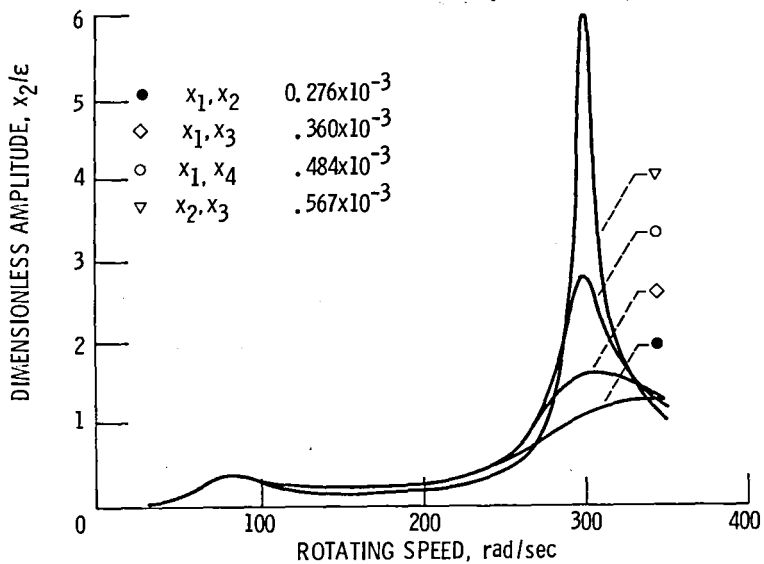

(b) Unbalance response (only stable cases).

Figure 4. - Eigenvalue assignment and unbalance response in the case of three inputs and two outputs in which J is based on the third mode.

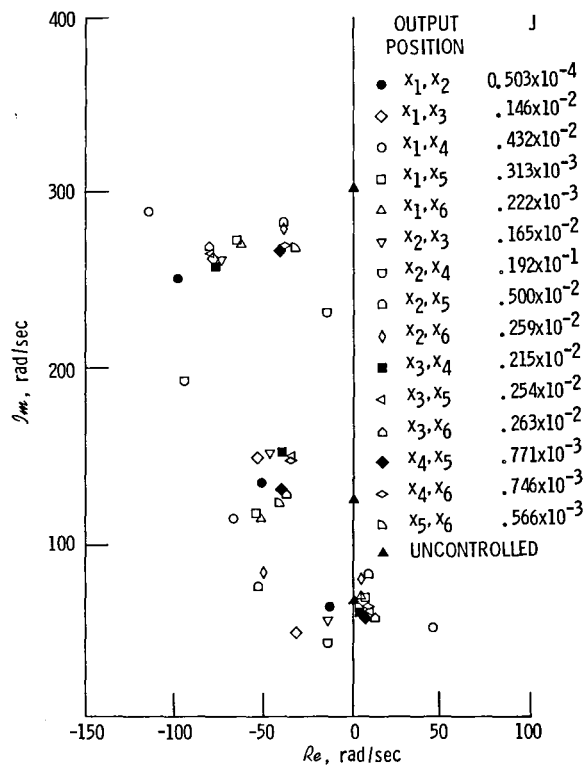

(a) Eigenvalue assignment.

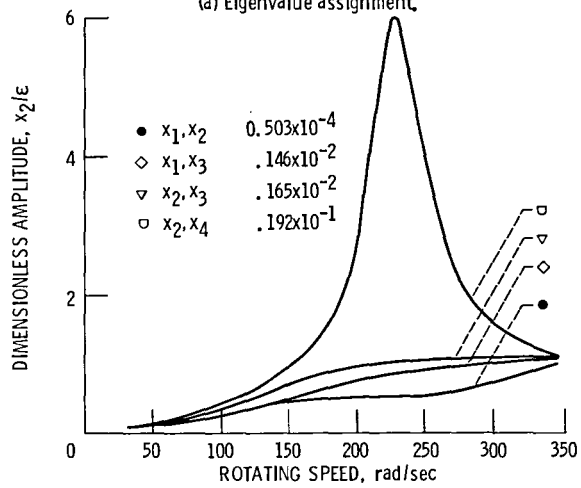

(b) Unbalance response (only stable cases).

Figure 5. - Eigenvalue assignment and unbalance response in the case of two inputs and two outputs in which J is based on the first mode.

1. Report No. NASA TM-87232		2. Government Accession No.		3. Recipient's Catalog No.	
4. Title and Subtitle Quasi-Modal Vibration Control by Means of Active Control Bearings				5. Report Date	
				6. Performing Organization Code 505-63-11	
7. Author(s) Kenzou Nonami and David P. Fleming				8. Performing Organization Report No. E-2899	
				10. Work Unit No.	
9. Performing Organization Name and Address National Aeronautics and Space Administration Lewis Research Center Cleveland, Ohio 44135				11. Contract or Grant No.	
				13. Type of Report and Period Covered Technical Memorandum	
12. Sponsoring Agency Name and Address National Aeronautics and Space Administration Washington, D.C. 20546				14. Sponsoring Agency Code	
15. Supplementary Notes Prepared for the International Conference on Rotordynamics, cosponsored by the IFTOMM and the Japan Society of Mechanical Engineers, Tokyo, Japan, September 14-17, 1986. Kenzou Nonami, NRC-NASA Research Associate on leave from Chiba University, Yayoi-cho 1-33, Chiba 260, Japan; David P. Fleming, NASA Lewis Research Center.					
16. Abstract This paper investigates a design method of an active control bearing system with only velocity feedback. The study provides a new quasi-modal control method for a control system design of an active control bearing system in which feedback coefficients are determined on the basis of a modal analysis. Although the number of sensors and actuators is small, this quasi-modal control method produces a control effect close to an ideal modal control.					
17. Key Words (Suggested by Author(s)) Active vibration control; Rotordynamics; Quasi-modal control; Unbalance vibration			18. Distribution Statement Unclassified - unlimited STAR Category 37		
19. Security Classif. (of this report) Unclassified		20. Security Classif. (of this page) Unclassified		21. No. of pages	22. Price*

End of Document