

 Open access • Proceedings Article • DOI:10.1109/PIMRC.2008.4699501

## Radio-Triggered Wake-ups with Addressing Capabilities for extremely low power sensor network applications — [Source link](#)

Junaid Ansari, Dmitry Pankin, Petri Mahonen

**Institutions:** RWTH Aachen University

**Published on:** 08 Dec 2008 - Personal, Indoor and Mobile Radio Communications

**Topics:** Sensor node, Energy consumption, Wireless sensor network, Sleep mode and Duty cycle

Related papers:

- [A prototype low-cost wakeup radio for the 868 MHz band](#)
- [Radio-Triggered Wake-Up for Wireless Sensor Networks](#)
- [Radio-triggered Wake-ups with Addressing Capabilities for Extremely Low Power Sensor Network Applications](#)
- [Low power wake-up receiver for wireless sensor nodes](#)
- [Wake-up receivers for wireless sensor networks: benefits and challenges](#)

Share this paper:    

View more about this paper here: <https://typeset.io/papers/radio-triggered-wake-ups-with-addressing-capabilities-for-1shgmy4qqp>

# Radio-Triggered Wake-ups with Addressing Capabilities for Extremely Low Power Sensor Network Applications

Junaid Ansari, Dmitry Pankin and Petri Mähönen

Department of Wireless Networks, RWTH Aachen University,

Kackertstrasse 9, D-52072 Aachen, Germany

Email: {jan, dpa, pma}@mobnets.rwth-aachen.de

## Abstract

Sensor network applications are generally characterized by long idle durations and intermittent communication patterns. The traffic loads are typically so low that overall idle duration energy consumption dominates. Low duty cycle MAC protocols are used in order to reduce the energy consumption in idle periods. However, lowering the duty cycle value in favour of energy consumption results in increased latency, which makes this approach undesirable for many practical applications. In this paper, we propose Radio Triggered Wake-up with Addressing Capabilities (RTWAC) that allows suppressing the idle duration current consumption. Our solution consists of an external low-cost hardware wake-up circuit attached to the microcontroller of a sensor node. In order to communicate with a sensor node, a special kind of out-of-band modulated wake-up signal is transmitted. The modulated signal contains data that enables one to distinguish between differently addressed nodes in order to avoid undesired node wake-ups. Furthermore, we advocate the idea of combining RTWAC to a MAC protocol running on the normal sensor node radio in order to simultaneously achieve low energy consumption and low latency for reliable data communication.<sup>1</sup>

*Keywords*—Radio triggered wake-ups, low-power, Sensor network MAC protocols, Design and implementation

## 1. INTRODUCTION

Owing to the severe resource constraints, sensor network applications make use of the hardware peripherals in a prudent manner. One of the common techniques is through controlling mechanisms that turns off the unused hardware resources. Since the available

<sup>1</sup>This is an extended version of the earlier paper by Ansari *et al.* [1], presented in IEEE PIMRC 2008.

battery power is the most precious resource at a sensor node and directly affects the lifetime of the network, energy aware techniques are particularly important. In typical Wireless Sensor Network (WSN) applications, wireless data communication exhibits the highest power consumption budget. Since the actual data traffic in WSNs is generally very low, most of the energy is wasted in idle listening by a radio, i.e., while waiting in anticipation for a data packet. This makes minimizing the idle duration power consumption at a sensor node highly important. Radio duty cycling is a popular solution in which, the radio is turned on and off according to a pre-defined scheme, specific to each MAC protocol [2]. However, there exists a trade-off between energy consumption and the corresponding latency for data communication in duty cycling MAC protocols. Lower duty cycles result in higher energy savings, but at the same time imply increased latency for data communication.

In this paper, we present a radio triggered wake-up circuit attached to a sensor node that allows it to keep its on-board radio module completely switched off until it is required to be used for data communication. In order to initiate data communication, an out-of-band modulated signal is transmitted as the wake-up signal. The wake-up circuit board attached externally to a sensor node triggers an interrupt to the microcontroller of the sensor node platform. Upon this interrupt, the microcontroller switches from sleep state to active mode and interprets the data transmitted in the modulated wake-up signal. The data contains address information and command messages, which allows a sensor node to quickly switch back to sleep if it is not addressed. On the contrary, an addressed receiver executes the command message transmitted in the wake-up signal. For example, the command may include turning on the normal radio on the sensor node for data communication. A sensor node uses the normal on-board radio with a sophisticated MAC protocol for data communication. A MAC protocol coordinates efficient channel sharing among nodes and gives higher reliability in data communication, while radio triggering allows saving significant amount of energy wasted in idle listening. This way our solution advocates the idea of combining together the advantages of radio triggered wake-up techniques with sophisticated MAC procedures for reliable data communication and highly energy efficient operation.

The rest of the paper is organized as follows: we give an overview of the related research in Section 2. Section 3 describes the design and implementation details of RTWAC. In Section 4, a detailed experimental performance evaluation of RTWAC is presented and a performance comparison with one of the most widely used duty cycled MAC protocol [3] is made on various duty cycle values. Section 5 outlines an extremely low-power asset tracking system

based on our solution. Finally, the article is concluded in Section 6.

## 2. RELATED WORK

One of the most widely used approaches for reducing power consumption at sensor nodes is through power management schemes, which try to minimize energy consumption by keeping the unused peripherals and radio resource in the off state. Experimental studies on real sensor network deployments in various applications have shown that data communication characterize the highest energy consumption budget [4]. While it is easy to define when data transmission is required, reception is usually unpredictable and asynchronous to a sensor node. Either continuous listening to the wireless medium or duty-cycled scheme is used by the receiving node. An evident drawback of duty cycling schemes is the increased latency compared to the always on mode. When the radio is always on in anticipation of a data packet, energy is wasted. One of the possible alternatives to minimize latency as well as energy consumption is through an additional wake-up radio hardware, which is thoroughly optimized for negligible power consumption and is capable of reacting instantly on an event of interest i.e. wireless channel activity.

PicoRadio [5], [6] proposes a carefully designed very low power transceiver module (build as a prototype IC), which is capable of monitoring radio environment. It can be used either as a stand-alone radio module on the sensor node or as an additional wake-up module in combination to a more advanced radio transceiver. The total power consumption of the module in the receive mode is  $380 \mu\text{W}$  with a supply voltage of 1 V and receiver sensitivity of -75 dBm. In the transmit mode, it consumes 1.6 mW with an output power of 0 dBm. Although these power consumption ratings are much lower than many state-of-the-art radio transceivers used in sensor nodes (typically using 2-3 V supply voltage and consuming 10-30 mA current consumption), this solution still consumes significantly high power consumption while staying always-on. Furthermore, no working prototype has been evaluated for performance characteristics.

M. J. Miller and N. H. Vaidya [7] proposed a MAC protocol using two radios. The primary radio is used to wake-up nodes by sending a wake-up signal. The nodes communicate in the secondary channel after waking up. This scheme has attractive energy saving possibilities, e.g. when compared to STEM approach [8], where the primary radio sends a busy tone signal and the nodes are required to listen to the primary channel all the time in anticipation of an upcoming signal. The authors devise a scheduling based method for waking-up the nodes

depending upon the traffic loads. The authors carried out simulations based studies using *ns-2* in order to find out the optimal value for node wake-up periods, which leads to minimum energy consumption for a given number of packet transmission and reception.

L. Gu *et al.* proposed to use an external circuit for radio triggered wake-ups attached to wireless sensor nodes [9]. The idea is to use only passive components in order to collect energy from on-going radio transmissions, similar to the principle of passive RFID technology. When the power induced at the receiving antenna is large enough, it interrupts the microcontroller, which wakes-up the “normal” sensor node radio for data communication. Due to simplicity of the wake-up hardware, it reacts to any strong electromagnetic field in the operating frequency. Having no addressing mechanism in the design leads to undesired wake-up of nodes. Additionally, in order to avoid the unwanted node wake-ups, Radio-Triggered-ID (RTID) was proposed, where different nodes are addressed by performing simultaneous transmissions at several different frequencies. This solution involves practical shortcomings such as the need for an additional wake-up hardware corresponding to each frequency and a transmitter capable of transmitting at different frequencies simultaneously. Furthermore, the approach used in RTID has obviously a very limited addressing space.

M. Malinowski *et al.* developed a direct amplifying RF detector, operating at 300 MHz as a part of the CargoNet project [10]. The main building blocks of this RF detector are antenna matching network, envelope detector and micropower amplifier. The receiver sensitivity and power consumption of the circuit are -65 dBm and 2.8  $\mu$ W, respectively. The RF detector is able to detect an On-Off-Keying (OOK) signal modulated with baseband square pulses of 25 Hz.

WISP is a wirelessly powered platform for sensing and computation [11]. Its main building blocks are passive power harvesting hardware, demodulator circuitry, microcontroller and sensors. Although WISP is not directly related to WSNs, its hardware components and the research philosophy are close to our work. WISP is a battery-free platform for sensing and computation. A standard UHF-RFID reader is used to power it wirelessly and control its sensing and data transmission capabilities. WISP’s main building blocks are passive power harvesting hardware, demodulator, microcontroller unit and sensors.

The work by B. v. d. Doorn *et al.* [12] aims at achieving energy efficiency through a low cost radio triggered wake-up circuit attached to a sensor node platform. Similar to the approach proposed earlier by L. Gu *et al.* [9], a sensor node’s on-board radio is used to transmit wake-up signals. B. v. d. Doorn *et al.* use Texas Instrument Inc.’s CC1000 on

SOWNet Technologies' T-node platform to transmit wake-up signals for triggering the wake-up circuit attached to other sensor nodes. Their prototype works in 868 MHz frequency band, and achieves a range of only 2 m with 3 mW of transmit power. Having no addressing mechanism, radio signals cause undesired node wake-ups, which can cause considerable energy loss especially in high density networks. The overall dormant/sleep state power consumption of the prototype varies from 171 mW to 819 mW, which is significantly higher as compared to our prototype.

### 3. DESIGN AND IMPLEMENTATION

In this section, we describe our solution which alleviates the need for periodic wake-ups of the radio module on a sensor node unlike duty cycling MAC protocols. The radio remains completely switched-off and the microcontroller operates in low-power mode. By using an additional hardware circuit attached to a sensor node, the microcontroller on the sensor node can be woken-up from low power mode by sending a specific RF signal. This additional hardware circuit is either completely passive or active with an extremely low power consumption (just a few  $\mu\text{A}$ ). A sensor node can operate for several years in the sleep mode with this low power consumption and at the same time, it is able to instantaneously wake-up upon the need for data communication over the standard on-board radio. Before sending the wake-up signal, we perform clear channel assessment, which helps in avoiding potential collisions. We use a modulated RF signal to wake-up sensor nodes, unlike [9], where no modulated signal is used for the wake-up process. The "data modulation feature" in our design allows uniquely addressing different nodes or groups of nodes and sending additional data (e.g. command messages) in the wake-up signal.

#### 3.1. Design Goals and Objectives

We aimed at the following goals by introducing new radio triggered wake-up scheme with an additional hardware circuit attached to the sensor nodes:

- Suppressing the idle listening power consumption significantly by avoiding radio duty cycling at sensor nodes and keeping the on-board radio of the nodes completely switched off and the microcontroller in the sleep state.
- A sensor node must consume only negligible power in the sleep/dormant mode.
- Instantly waking-up the nodes from the sleep state, i.e. as soon as a sensor node completely receives a wake-up signal, it should be ready to communicate over its normal

radio.

- Unique addressing capability, i.e. possibility to wake-up a single sensor node or group of nodes. The wake-up address is the same as the MAC address of a sensor node.
- Capability of sending simple command messages to a sensor node within the wake-up signal in order to perform a particular task.
- Compliance of the circuit board to the frequency usage regulations in Europe.
- Keeping the cost of the wake-up circuit board as low as possible.
- Causing radio triggered wake-ups with high reliability and suppressing false triggers.
- Maximizing the operating range of the wake-up hardware. One of the most difficult engineering task is to have a good communication range and at the same time achieving a negligible power consumption. With a completely passive structure, a communication range of more than one meter is difficult to reach under European frequency regulations. By introducing some active components in the wake-up hardware circuit, it is possible to increase the operating range to more than 10 m and still keeping power consumption of the wake-up circuit at an extremely low level.

### *3.2. Choice of the Operating Frequency*

We investigated the possible operating frequency ranges that best suit our needs according to the application requirements stated earlier. In this subsection, we present the rationale behind the selection of the frequency band. The main factors that strongly influenced the choice were:

- Communication range
- Size of the antenna and complexity of the hardware circuit
- Availability of the appropriate electronic components
- Possibility to operate license free

We evaluated and compared the use of the following ISM frequency ranges: 13.56 MHz, 433 MHz, 868 MHz, 2.4 GHz and an RFID specific frequency range of 100-135 kHz. Table I summarizes the comparison of these frequency bands based on our criteria.

For 100-135 kHz frequency range, Atmel's U3280M [13] transponder interface for microcontroller perfectly suits our needs. It is completely powered from the external magnetic field and requires no biasing power supply. It is able to interrupt an external microcontroller, when the transponder comes in the vicinity of an alternating magnetic field. Unfortunately, a large antenna size requirement and only a small resulting communication range because

<i>Frequency range</i>	<i>Communication distance</i>	<i>Antenna size</i>	<i>Hardware circuit size</i>	<i>Components availability</i>
100-135 kHz	-	-	++	++
13.56 MHz	-	-	+	+
433 MHz	+	-	+	+
868 MHz	+	+ -	+	+
2.4 GHz	+ -	+	+	+ -

TABLE I

SUITABILITY OF DIFFERENT FREQUENCY BANDS FOR RADIO-TRIGGERED WAKE-UPS.

of the inductive coupling makes the use of this frequency unfavorable. Devices operating at 13.56 MHz also rely on inductive coupling and therefore, suffer from having a limited range of approximately one meter. In 433 MHz, 869 MHz and 2.4 GHz frequency ranges, the principle of operation is similar. According to the Friis transmission formula, the propagation loss increases for higher frequencies, thereby making 433 MHz range a preferable choice. However, since the antenna size is proportional to the wavelength, 2.4 GHz becomes a bit more attractive option with smaller antenna size. On the other hand, the non-availability of discrete circuit components at 2.4 GHz frequency makes the choice difficult. Overall, 868 MHz frequency range turns out to be the most suitable design choice for our needs with having reasonable antenna size, operating ranges and the easier availability of circuit components. We built our prototype working at 868.5 MHz. According to the frequency regulations in Europe, an Effective Radiation Power (ERP) of 500 mW is permissible for this frequency with a maximum duty cycle of 10%. We designed our solution working in 868 MHz band for European frequency regulations. However, the same selection criteria for the operating frequency band also holds for the available 902-928 MHz band in Americas and other parts of the world.

### 3.3. Antennae Considerations

In the reception mode, the primary task of an antenna is to transfer the maximum amount of power from air to the wake-up circuitry. In order to keep the price of the circuit as low as possible, we have chosen using a half-wavelength dipole antenna made of a copper wire in our prototype. Radiation pattern of an ideal half-wavelength dipole is omnidirectional in the plane perpendicular to the antenna, with an input impedance of  $73\Omega$  at the resonant frequency and has a gain of 1.64. Balanis [14] states that for a given wavelength  $\lambda$ , the length of the dipole for the first resonance (imaginary part of input impedance becomes zero) is



approximately between  $0.47\lambda$  and  $0.48\lambda$  depending upon the radius of the wire. The thinner the length of the wire is, the closer to  $0.48\lambda$  the length becomes. We made our antenna from 1 mm thick copper wire. For the antenna length calculations we use the coefficient of 0.475. The wavelength of the 868.5 MHz frequency wave is,  $\lambda = \frac{c}{f} = \frac{3 \cdot 10^8}{868.5 \cdot 10^6} = 34.5$  cm, which gives the antenna length,

$$l = 0.475\lambda = 0.475 \cdot 34.5 \text{ cm} \approx 16.4 \text{ cm}. \quad (1)$$

The power induced at the antenna is extremely low because of the path loss. Therefore, it is required to transfer the maximum possible power from the antenna to the rest of the wake-up circuit through an appropriate matching network. The matching network is built on two lumped reactive elements – a parallel capacitor and a series inductor.

### 3.4. Wake-Up Signal Transmitter

Our prototype wake-up signal transmitter consists of a Moteiv Inc.'s TelosB node, Texas Instruments Inc.'s CC1000 radio transceiver and optionally a ZHL-2010 radio frequency amplifier from Mini-Circuits(R). The block diagram of the wake-up signal transmitter is shown in Fig. 1. CC1000 radio generates a wake-up signal in 868.5 MHz band; the radio

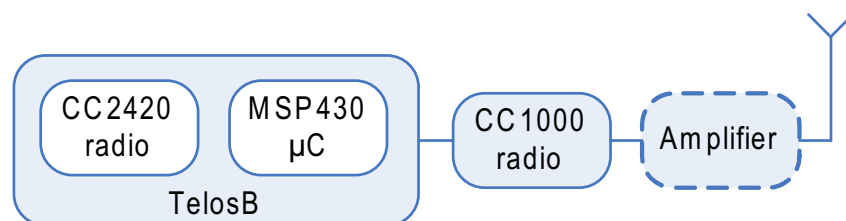

Fig. 1. Wake-up transmitter block diagram.

frequency amplifier can be used to increase the communication range. We use Texas Instruments Inc.'s CC1000PPK-868 radio module attached externally to a TelosB node as shown in Fig. 2. In order to generate an OOK modulated signal on CC1000 radio, which is primarily an FSK radio, we control the transmit amplifier's output power. The difference in the two frequencies (corresponding to a one and a zero) in the FSK modulator is set to zero. The amplifier's output power is controlled by sending a command byte over the configuration bus interface of the CC1000 chip. Commands for enabling and disabling the output transmit power on the chip correspondingly lead to ones and zeros in the OOK modulation.



Fig. 2. Snapshot of RTWAC transmitter.

### 3.5. Wake-Up Signal Receiver

A node receiving the wake-up signal consists of a TelosB node and the wake-up hardware circuit. The hardware circuit interrupts the microcontroller on the TelosB, when it receives a wake-up signal. The block diagram of the receiving wake-up circuit is shown in Fig. 3. The main building blocks include an impedance matching network, a voltage multiplier and a digital comparator. The power induced at the antenna is extremely low due to the path loss during the radio waves propagation; thus the task of the matching network is to transfer the maximum possible power from the antenna to the voltage multiplier circuit. The matching network is built on two lumped reactive elements: a parallel capacitor and a series inductor, in order to provide maximum power transfer from the antenna to the rest of the circuitry. The induced power at the output of the antenna and the matching network is potentially very small to trigger the digital logic of the microcontroller; moreover the voltage alternates at the radio frequency. Our design includes a five stage Voltage Multiplier (VM) structure (also known as charge pump) to increase the induced voltage to sufficiently high level and to detect the slowly varying envelope signal from the modulated high frequency carrier. The diodes are chosen carefully to be able to turn on at very low forwarding voltages and operate at high switching frequencies. We use low threshold RF Schottky diodes (HSMS-2852) from Avago Technologies [15].

In order to observe the frequency response of our prototype receiver and its tuning sensitivity levels at different nearby frequencies, we used a signal generator to generate signals with a constant transmit power of 20 dBm. The wake-up receiver circuit was placed at a fixed distance of 15 cm from the signal generator. It may be noted that the transmit power level

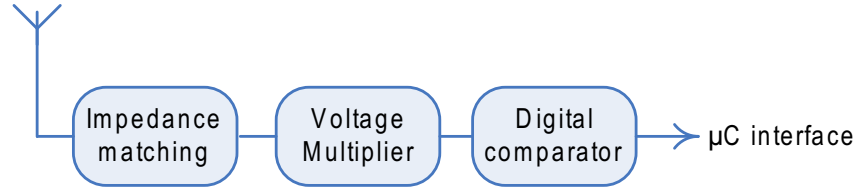

Fig. 3. Wake-up receiver block diagram.

<i>Frequency [MHz]</i>	<i>Voltage Induced [Volts]</i>
840	3.4
850	3.9
860	4.3
868.5	4.8
870	4.6
880	3.0
890	2.1

TABLE II

FREQUENCY SENSITIVITIES OF THE PROTOTYPED RTWAC RECEIVING NODE. AVERAGE VOLTAGE INDUCED AT THE OUTPUT OF THE VOLTAGE-MULTIPLIER CIRCUIT AT DIFFERENT CENTER FREQUENCIES. THE TRANSMIT POWER IS SET TO BE 20dBm AND THE DISTANCE BETWEEN THE TRANSMITTER AND THE RTWAC RECEIVER IS FIXED TO 15 CM.

and the distance used in particular is not important for studying frequency sensitivities. We measured the voltage induced at the output of the 5-stage voltage multiplier circuit at different frequencies. Table II shows the mean voltage induced at the 5-stage voltage multiplier circuit when the transmitter uses 20 dBm of output power and the RTWAC receiving node is placed at a distance of 15 cm. It can be observed that the circuit is very well tuned to 868.5 MHz. However, it has a wider sensitivity bandwidth, which makes it susceptible to out-of-band interference from GSM-900. We use a digital comparator based threshold selector to lessen the effect of interference from the adjacent GSM band. Digital comparator is the only active component in our wake-up circuit. It is used for digitizing the analog signal and shifting the voltage levels to “high” and “low” logical levels of the microcontroller. Digital comparator also performs an over-voltage protection for the microcontroller because it is likely that voltage multiplier in the close vicinity to the transmitter can produce voltage levels as high as 10 V. The complete schematic of the wake-up circuit is shown in Fig. 4.

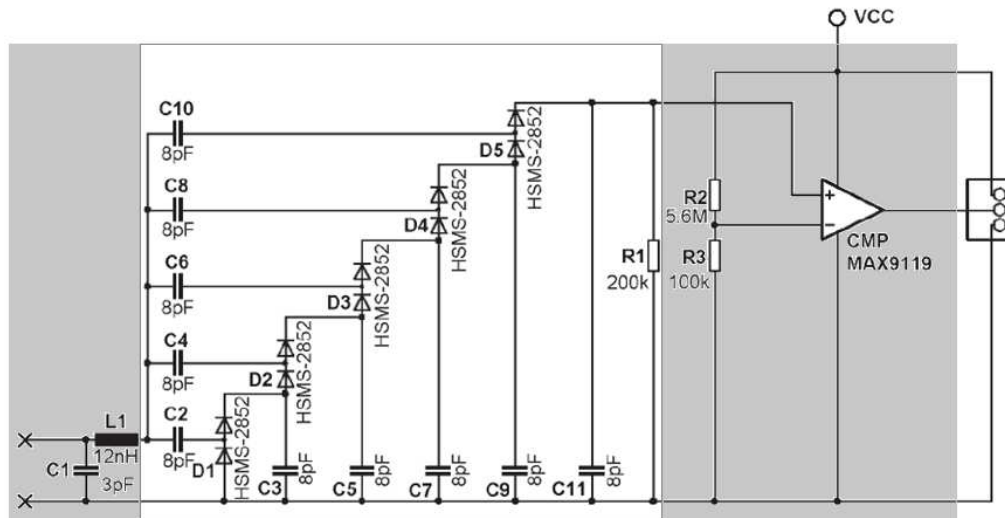

Fig. 4. Schematic of the wake-up board.

The resistor R1 is the main load for the VM part of the circuit because the load of the digital comparator input pin is negligible. R1 constantly drains out the current from the charging capacitors C2-C11. When the power induced by the antenna is decreased, the voltage at the output of the VM is also decreased. Thus the VM and the load resistor R1 form a simple envelope detector. The obtained amplitude envelope is compared to a predefined threshold of the digital comparator in order to detect the transmission of a high or a low level. The predefined threshold level is configured by the voltage divider consisting of resistors R2 and R3. The selected threshold level is higher than the noise level in order to avoid false interrupts at the microcontroller. Decreasing the threshold level can lead to an increase in the operating range, however this also causes an increase in the number of false positives. We empirically found out that a noise threshold level of 50-60 mV gives reasonably good operating range of more than 10 m using the permitted transmit power level and duty cycle constraint of 27 dBm and 10% duty cycle, respectively. With this empirical threshold value, we did not observe any false alarm triggers. Fig. 5 shows the snapshot of our prototype RTWAC receiving node consisting of the radio triggered wake-up circuit attached to a TelosB node. One design enhancement includes using a band pass filter after the antenna matching network in order to suppress adjacent channel interference. This allows to lower the noise/interference level threshold value and hence leads to a larger operating range. For this purpose, we suggest using a SAW filter, for instance, Golledge Electronics Ltd.'s 868.60 MHz or EPCOS AG's

868.30 MHz, which require no biasing voltage, have low band-pass filtering loss and have high attenuation for the undesired interference from adjacent GSM band. There are only two

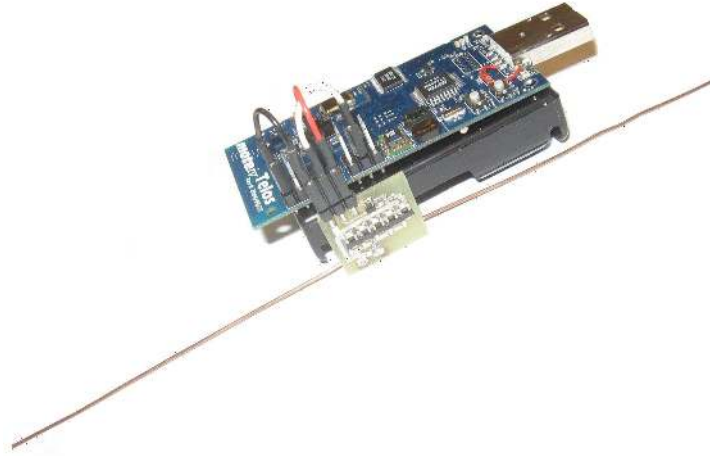

Fig. 5. An RTWAC receiver node consisting of an external wake-up circuit connected to a TelosB sensor node platform.

sources of power consumption in the wake-up circuit. The first is an extremely low power MAX9119 digital comparator [16], typically consuming only 350 nA of supply current at bias voltage of 3 V. The second source of power consumption is the voltage divider that forms the threshold voltage (reference voltage for the comparator). Voltage divider is composed of two resistors, R2 and R3, and consumes 526 nA. The total current drained by the wake-up circuit is therefore,

$$I_{\text{wakeup}} = I_{\text{comp}} + I_{\text{div}} = 350\text{nA} + 526\text{nA} = 876\text{nA}. \quad (2)$$

Since the wake-up circuit interrupts the microcontroller externally, we use the deepest sleep mode (LPM4) of MSP430 series microcontroller, which consumes a current  $I_{\text{TelosB}} = 3.3 \mu\text{A}$  on TelosB.

### 3.6. Wake-Up Signal Protocol Packet

We have designed a very simple and lightweight protocol for the wake-up signalling. CC1000 radio chip is used to perform OOK by simply turning on and off its power amplifier. These turn-on and turn-off periods are controlled completely by the on-board microcontroller (MSP430 of the TelosB node in our case). For the encoding of digital data, we have chosen Pulse Interval Encoding (PIE). Fig. 6 shows the PIE scheme that we have used in our solution. Encoding of 0 and 1 starts with a fixed interval T of high level transmission, followed by

a low level period equal to  $T$  for 1 and  $2T$  for 0. The total bit transmission time, therefore varies from  $2T$  to  $3T$ .

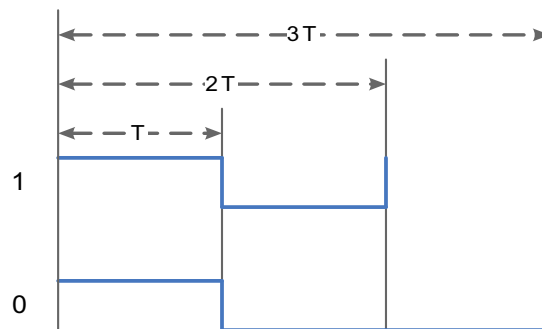

Fig. 6. Pulse Interval Encoding (PIE).

Using PIE instead of Manchester encoding in our implementation causes a lower number of required interrupt events to be handled by the microcontroller during decoding of a single bit. In order to decode data sequence from Manchester encoded signal, the microcontroller has to track all the transitions from low-to-high and from high-to-low. In PIE, it is enough for the microcontroller to track only low-to-high transitions and the time intervals between them in order to successfully decode the data sequence. The reduced number of interrupts saves power consumption required to invoke and process additional interrupt service routines. A synchronization sequence of zeros and ones is sent at the beginning of each packet. This sequence also allows dynamic calculation of the timing characteristics for the transmissions of zeros and ones, i.e. determining the time duration  $2T$  for “1” and the time duration  $3T$  for “0”. Thus the receiver has no hard built-in timing values, rather it can adapt to the transmitter’s timing characteristics using the synchronization sequence. At the link layer, we designed the following packet structure for the wake-up signal transmission. A packet starts with 8 bits synchronization sequence (SYNC), followed by 16 bits address (ADDR), 16 bits command (CMD) and 8 bits CRC value. The total packet size therefore is of six bytes. It should be noted that the address space of the wake-up packet is shared with the MAC addressing scheme of the communication radio. The packet structure is shown in Fig. 7.

Before sending the wake-up packet, RTWAC transmitter makes sure that the medium is free by performing clear channel assessment in order to avoid any potential collisions. This is done by polling the received signal strength indicator pin of the CC1000 radio chip. Fig. 8 shows the basic functionality of an RTWAC receiving node. The sensor node stays in the sleep



Fig. 7. Wake-up packet structure.

state with the on-board radio completely switched off and MSP430 series microcontroller working in the extremely low-power mode (LPM4). When an external radio signal is detected at 868.5 MHz, the microcontroller is triggered on and tries to catch the radio message. If a synchronization sequence is not detected within a certain time duration, the node times-out and switches back to the sleep state. Based on the synchronization sequence, the node also estimates the decoding timings for PIE message and decodes the message. In the case, CRC fails or the wake-up packet is not addressed to the node (i.e. the MAC address of the node is different than that in the wake-up packet), it switches back to the sleep state. Otherwise, the node executes the command message, which might be taking a sensor reading and storing it in the EEPROM, reporting a sensory data etc. The radio chip on the sensor node is turned on only if data communication is required. Immediately after performing the indicated task, the node switches back to the sleep state. For data communication, we use a CSMA/CA based MAC protocol implemented on the on-board sensor node radio. CSMA/CA based MAC protocol implemented on a faster on-board radio of the sensor node has much higher efficiency and reliability for data communication than wake-up radio channel without using any medium sharing mechanisms.

#### 4. PERFORMANCE EVALUATION

In this section, we will describe the performance evaluation results. We present a comprehensive discussion on the range analysis and the comparison of RTWAC against duty cycling MAC protocols in the light of empirical measurements.

##### 4.1. Range Analysis

We can roughly estimate the received power,  $P_{rx}$  induced in the antenna using the Friis' equation,  $P_r(d) = \frac{P_t G_t G_r \lambda^2}{(4\pi d)^2}$ . The peak voltage at the antenna is calculated to be

$$V_{ant} = \sqrt{2P_{rx}R_{ant}} \quad , \quad (3)$$

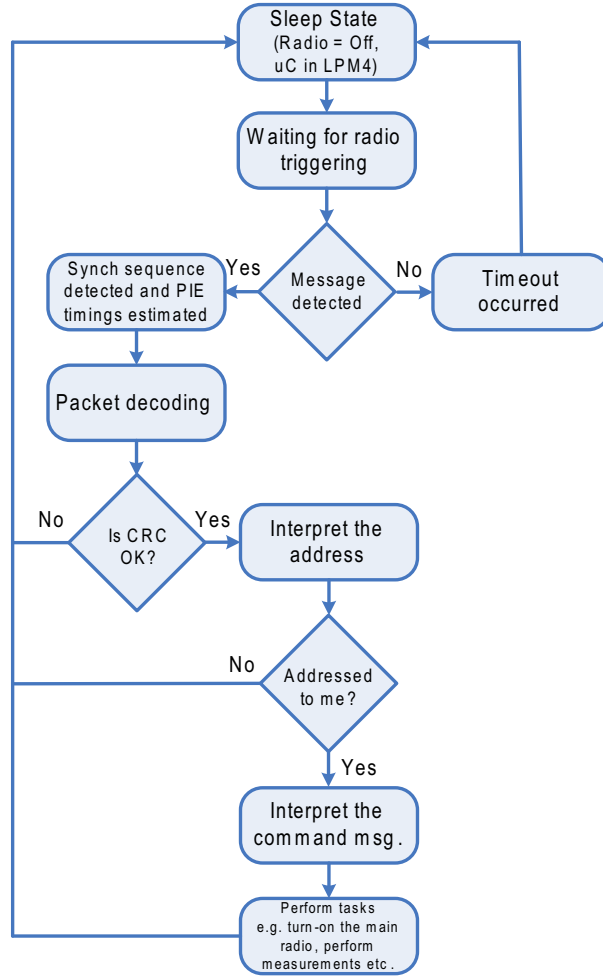

Fig. 8. Flow chart describing RTWAC functionality.

where  $R_{\text{ant}}$  is the antenna resistance. We use an equivalent circuit of the wake-up hardware to calculate the voltage delivered from the antenna to the input of the voltage multiplier and the digital comparator. The equivalent circuit is shown in Fig. 9. It is composed of the antenna resistance  $R_{\text{ant}}$ , matching network reactance  $X_{\text{match}}$ , VM resistance  $R_{\text{vm}}$  and VM reactance  $X_{\text{vm}}$ . We define impedance of the antenna and matching network as:

$$Z_{\text{ant}} = R_{\text{ant}} + jX_{\text{match}}. \quad (4)$$

The impedance of the VM is:

$$Z_{\text{vm}} = R_{\text{vm}} + jX_{\text{vm}}. \quad (5)$$



The voltage transferred from antenna and matching network to the voltage multiplier is calculated by the formula:

$$V_{vm} = V_{ant} \left| \frac{Z_{ant}}{Z_{ant} + Z_{vm}} \right|. \quad (6)$$

When the matching network is tuned for the maximum power transfer:

$$\begin{aligned} Z_{ant} &= Z_{vm}^*, \\ R_{ant} &= R_{vm}, \\ X_{match} &= -X_{vm}. \end{aligned} \quad (7)$$

For this case the voltage level at the VM input is:

$$V_{vm} = V_{ant} \left| \frac{Z_{vm}}{2R_{vm}} \right| = \frac{V_{ant}}{2} \sqrt{1 + Q^2}, \quad (8)$$

where  $Q$  is quality factor and is given by,

$$Q = \frac{X_{vm}}{R_{vm}}. \quad (9)$$

For our voltage multiplier,  $Q$  is less than one and  $Q^2 \ll 1$ , thus we can neglect it and approximate the input voltage for VM as,

$$V_{vm} = \frac{V_{ant}}{2}. \quad (10)$$

Theoretically, a five stages voltage multiplier gives ten times higher voltage as that at

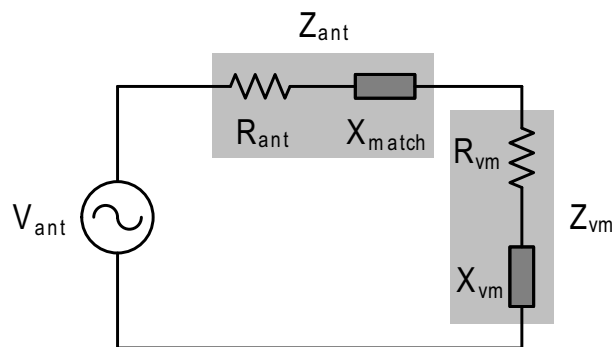

Fig. 9. Equivalent circuit of the wake-up hardware.

the output of the antenna matching circuit. But in reality, the voltage multiplier's output is reduced due to the forward bias voltage of the diodes, parasitic capacitances and constantly draining load current. At the very low input voltages the forward bias voltage loss becomes

comparable to the applied voltage, thereby decreasing the efficiency significantly. We used SPICE simulation tool to estimate the multiplication factor at different input voltage levels. Based on the simulation results we have chosen the multiplication factor to be five. Thus the voltage at the input of the digital comparator is,  $V_{\text{comp}} = 5V_{\text{vm}}$ . As we have mentioned earlier, the sufficient voltage at the input of the comparator is  $V_{\text{comp}} = 50 \text{ mV}$ , thus we can calculate the required power delivered from the antenna, using the equations, (3), (4) and (5). The minimum required receive power comes out to be,  $P_{\text{rx}} = 2.74 \text{ mW} = 4.37 \text{ dBm}$ . For the 500 mW transmit power, the operating distance using Friis transmission formula is calculated to be 15 m. Naturally, the range is smaller in realistic conditions especially indoors.

In the above calculations, we assume no polarization loss and perfect power transfer matching between the antenna and the voltage multiplier. If we take into account 3 dB polarization loss, when one antenna is circularly polarized and the second antenna is linearly polarized, the operating distance reduces to 10 m. For imperfect matching the operating distance is further reduced by a value depending on the mismatch loss.

We measured the communication range of RTWAC nodes with and without the amplifier (ZHL-2010). The measurements were carried out in an indoor environment for the line-of-sight propagation condition and repeated multiple times in order to eliminate possible statistical fluctuations. Before determining the communication range, we measured the output power of the RTWAC transmitter node. For the transmitting node without the amplifier, the output power was measured to be  $P_{\text{out}} = -1.1 \text{ dBm}$ . We attached a half-wavelength dipole antenna to the output of such command node. The command node with the amplifier (ZHL-2010) has an output power of  $P_{\text{out,amp}} = 20.56 \text{ dBm}$ . At the output of the amplifier, a  $\lambda/4$  monopole antenna is attached. The receiving wake-up circuit also uses a linearly polarized dipole antenna. Thus it is possible that the signal is significantly attenuated due to the cross-polarization effect, even if the distance between transmitter and receiver is small. In order to avoid this effect, a circularly polarized antenna can be used either on the transmitter or on the receiver side.

During our measurements, we distinguished three main operating zones, where the receiving capability of the RTWAC receiver differs significantly. The first zone is the zone of the consistent reception. Inside this zone, a node receives the wake-up signal regardless of its position in space. This area is in close proximity to the transmitter, so that polarization loss cannot completely block the signal reception. In the second zone, an RTWAC node receives the signal in most of the places and orientations in space, but there are some blind spots,

where reception is not possible, due to significant polarization loss or multipath propagation effects. In the third zone blind spots dominate, and reception spots are infrequent, i.e. one has to look for the place and correct orientation in space of the RTWAC node to receive the wake-up signal. The borders between the zones are quite relative and may differ for different experimental environments. According to our experimental measurements, for the command node with the amplifier we defined:

$$\text{Zone1} = 1.6 \text{ m}, \quad (11a)$$

$$\text{Zone2} = 3.0 \text{ m}, \quad (11b)$$

$$\text{Zone3} = 7.5 \text{ m}. \quad (11c)$$

Zones denote the radius of the corresponding circle with center in the transmitting point. For the Zone3, 7.5 m is actually the most distant point from the transmitter, where RTWAC node was able to receive the wake-up signal.

Without using the amplifier, we found the 3 zones for the transmitter:

$$\text{Zone1} = 5 \text{ cm}, \quad (12a)$$

$$\text{Zone2} = 30 \text{ cm}, \quad (12b)$$

$$\text{Zone3} = 65 \text{ cm}. \quad (12c)$$

The reader may notice that here the zone interpretation is slightly different. The reason is that for this case, cross-polarization effects significantly dominate over the multipath effect, so even in a very close proximity there is a block-out in case of cross-polarized orientation of the antennas. The Zone1 defines the consistent reception regardless of the antennas' orientation. In the Zone2, reception is consistent only when the orientation of the antennas is identical. The Zone3 shows the maximum distance where reception is still possible.

The obtained results are comparable to the analytical calculations as described above. If we calculate analytically the operating distance for  $P_{\text{out.amp}} = 20.56 \text{ dBm}$ , we get the operating distance equals to 8.6 m. The result is close to the maximum measured distance of 7.5 m. But it may be noted that analytical calculations do not take into account antennae mismatch in the receiver and transmitter and use free space radio waves propagation model. As can be seen from our experiments, we can treat the analytical results as a rough estimation of the maximum operating distance.

We generated an ASK modulated RTWAC packet and fed it to the ZHL-2010 amplifier using Agilent's E4438C Vector Signal Generator. We set the amplitude of the waveform from

the signal generator so that the ERP out of the ZHL-2010 amplifier becomes equal to the maximum allowed power of 27 dBm in the 868.5 MHz frequency in Europe. We obtained the following ranges for the three zones:

$$\text{Zone1} = 2.3 \text{ m}, \quad (13a)$$

$$\text{Zone2} = 3.9 \text{ m}, \quad (13b)$$

$$\text{Zone3} = 10.1 \text{ m}. \quad (13c)$$

We also calculated the number of packets received with errors. An 8-bit CRC is included in the wake-up packet, thus we could calculate the percentage of the packets received with CRC failures in all the received packets. The CRC was failed to a maximum of 10% in all the received packets regardless of the distance and zone. Even in Zone3, the mean packet receive error ratio did not exceed 10%, if the RTWAC receiving node was in the packet reception spot. CRC failures and triggering of false alarms both cause wastage of energy at the nodes. False alarms are caused by the external interferers while CRC failures occur when an RTWAC receiver fails to correctly receive the data packet after detecting a synchronization pattern. Energy is also wasted when an RTWAC receiver receives a packet, which is not addressed to it. However, since the packet transmission lasts only for a short time and correspondingly involves switching of the microcontroller from LPM4 mode to active mode, the amount of energy spent is very low. The microcontroller switches back to LPM4 mode immediately after interpreting the address.

#### *4.2. Performance Comparison with Duty Cycled MACs*

In this section, we compare and analyze the power consumption and latency of our implementation of RTWAC on the TelosB sensor node platform with B-MAC [3] operating at different duty cycles on the same platform. B-MAC is the most widely used sensor network MAC protocol. It is based on the preamble sampling principle and allows sensor nodes to poll the channel asynchronously. Each node periodically checks the channel for a short interval in order to detect any activity and goes back to sleep. The ratio of the on-time of the radio to the channel check interval defines the duty cycle. A transmitting node needs to send a long preamble equal to the length of the channel check interval, so that all the nodes, asynchronously polling the channel are able to detect the presence of the carrier. The nodes do not go to sleep if they detect activity in the medium and receive the data packet followed by the preamble. Since the traffic loads is very low in sensor networks, the

implicit synchronization of nodes through preamble reservation in preamble sampling MAC protocols have the advantage of not wasting energy in maintaining common sleep schedules of the nodes unlike other approaches [2].

The power consumption of RTWAC is calculated in the sleep mode whereas that of B-MAC is calculated while performing only low-power listening (LPL) or channel polling operation without packet receptions. This is justified because it represents the most common (idle) state of a sensor node. In the sleep mode, the current drawn by RTWAC node is the sum of the currents drawn by the wake-up circuit board and the current consumed by TelosB node ( $3.1\mu A$  for the biasing voltage of the FTDI chip handling the UART-USB communication +  $0.2\mu A$  for MSP430 microcontroller in LPM4) and is given by

$$I_{RTWAC} = I_{TelosB} + I_{wakeup} = 3.3\mu A + 876nA = 4.176\mu A. \quad (14)$$

Hence the operating power consumption of an RTWAC node is  $P_{RTWAC} = 12.528\mu W$ . Unlike the constant power consumption of an RTWAC node, the power consumed by a MAC protocol strongly depends upon the operating duty cycle. We calculated the power consumption for the reference implementation of B-MAC in TinyOS 2.0 at various duty cycles with the default channel polling duration of 1 ms when CC2420's hardware acknowledgements are disabled. The power consumption is calculated by,

$$P_{LPL\_MAC} = P_{TelosB.sleep} + DutyCycle \cdot P_{listen}. \quad (15)$$

Fig.10 shows a comparison of the power consumption during the idle duration of RTWAC and B-MAC protocol on TelosB platform. It is evident that the RTWAC node has a remarkably low power consumption. Only the MAC duty cycles of below 0.001 % have a comparable power consumption but with a costly price of very high latencies. In order to calculate the latency of RTWAC solution, we need to measure the time required to transmit a complete modulated signal containing the data. Since RTWAC uses PIE at the PHY layer, the latency depends upon the number of zeros and ones contained in one complete wake-up packet. The transmission time of "1" and "0" are  $2T$  and  $3T$ , respectively. In our reference implementation,  $T=530\mu s$ . So the average transmission time for 6 bytes of packet is 63.6 ms.

We use the average latency for data communication on the reference B-MAC implementation. The maximum latency for a particular packet is given by

$$B\_MAC\_latency_{max} = T_{duty-cycle} + T_{packet}. \quad (16)$$

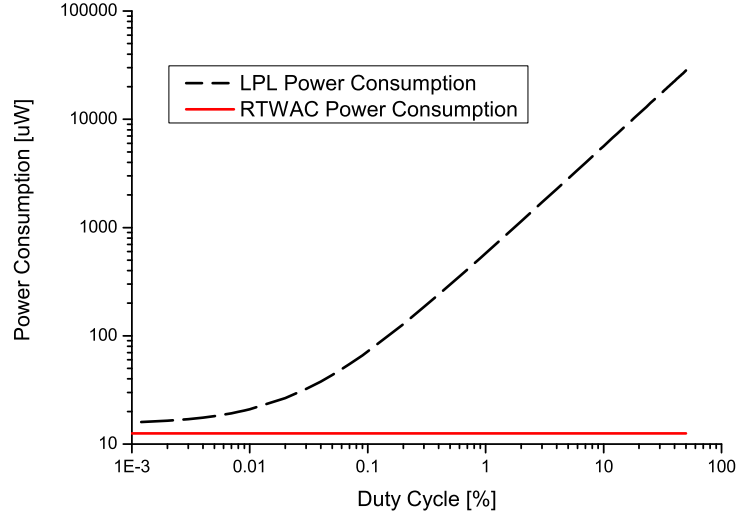

Fig. 10. The average power consumption comparison of RTWAC against a Low-Power-Listening (LPL) MAC protocol at different duty cycles, implemented on CC2420 radio. The channel polling duration for the MAC protocol is 1 ms.

The minimum latency is equal to the time required to transmit a complete packet and is actually dependent on the packet size:

$$\text{B-MAC\_latency}_{\min} = T_{\text{packet}}. \quad (17)$$

The average latency of the B-MAC is:

$$\text{B-MAC\_latency}_{\text{avg}} = \frac{\text{B-MAC\_latency}_{\max} + \text{B-MAC\_latency}_{\min}}{2}. \quad (18)$$

In order to calculate  $T_{\text{packet}}$  of B-MAC, we use the raw packet size with default payload size of 28 bytes. The MAC layer overhead is 12 bytes, and the synchronization header of the IEEE 802.15.4 PHY layer is 5 bytes. For the CC2420 raw data rate of 250 kbps, we have:

$$T_{\text{packet}} = \frac{45 \text{ bytes}}{250 \text{ kbps}} = 1.44 \text{ ms}. \quad (19)$$

The average latency comparison of the RTWAC node and B-MAC's implementation on TelosB is shown in Fig. 11. One should observe that the latency of RTWAC is comparable to that of B-MAC protocol with 1% duty cycle. However, RTWAC consumes significantly less power at this duty cycle of B-MAC. Furthermore, it may be noted that the latency of RTWAC can easily be improved by sending the RTWAC data packet at a faster rate. In our reference implementation, it is restricted by the software implementation of the SPI protocol through bit-banging on MSP430 microcontroller. It is also interesting to observe the amount of energy consumed in interpreting a single wake-up data packet. The amount of energy

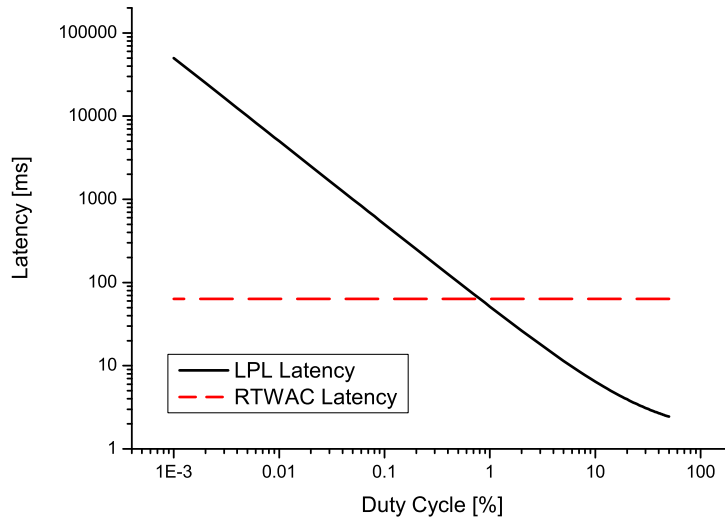

Fig. 11. The average latency comparison of RTWAC against a Low-Power-Listening (LPL) MAC protocol implemented on CC2420 radio at different duty cycles.

spent in receiving an addressed and a non-addressed packet is the same. The average time a packet takes to be transmitted is 63.6 ms and the microcontroller switches to from LPM4 mode to the active mode, where it consumes  $340 \mu\text{A}$  at 3 V). Therefore, the energy spent turns out to be  $64.7 \mu\text{J}$ .

## 5. INTEGRATION INTO APPLICATIONS

Many sensor network applications demand rare, irregular and short usage of radio resources. In these applications, when the event of interest occurs, it has to be often reported quickly and large latencies are unaffordable. In the following, we describe an RTWAC-based low power cargo delivery and asset tracking application, which was demonstrated in [17] and belongs to this very typical class of sensor network applications. RTWAC-based receiving nodes are attached to cargo or inventory items, which might remain under storage for years. However, when required, the goods can be quickly located in large ware-houses using a single wake-up message. Since there are potentially a large number of assets or goods stored in a warehouse, addressing mechanism in radio wake-ups helps non-addressed nodes to avoid undesired wake-ups. Furthermore, when the goods are transported over the sea, it may take as long as a month and during this time, command messages can be sent to take the sensor readings (e.g. temperature, humidity, shock, etc.) and store in the local EEPROM for monitoring purposes. After the carriage is completed, appropriate command messages

are sent on the wake-up radio to turn on the normal radio on the sensor nodes and quickly flush the stored sensor readings for evaluating health and conditions of the goods during transportation.

## 6. CONCLUSIONS

In this paper, we have presented radio triggered wake-up solution with addressing capabilities. We have described the rationale behind various hardware aspects and the protocol details. Performance evaluation of the prototype platform has also been carried out. RTWAC not only helps sensor nodes avoid idle listening to the medium unlike duty cycled MAC protocols but also suppress unnecessary radio wake-ups due to the addressing information included in the wake-up signal. We have also conducted comparative empirical studies against duty cycled MACs and have shown that duty cycled MACs consume more energy and have higher latency. In the case of duty cycled MACs, either a long preamble needs to be transmitted before a data packet or a high synchronization overhead has to be paid in order to align the active periods of the nodes for data communication. In contrast to the energy consumption and latency trade-off in duty cycled MAC protocols, RTWAC allows keeping the power consumption of a node at a negligible level when communication is not required and instantly waking-up when desired. Our prototypical RTWAC wake-up circuit works in 868.5 MHz ISM band and complies with the power level and duty cycle constraints imposed by the frequency regulators in Europe. Our approach of combining RTWAC with low-power MAC protocols running on the standard on-board radio of sensor nodes can also efficiently address application specific requirements. One of our test cases and scenarios for RTWAC has been its use for asset tracking logistic value chain. The initial results are promising and warrant future development work.

## ACKNOWLEDGMENT

We would like to thank financial support from European Union (project IST-034963-WASP), Deutsche Forschungsgemeinschaft through the UMIC research center and RWTH Aachen University.

## REFERENCES

- [1] J. Ansari, D. Pankin, and P. Mähönen, "Radio-triggered wake-ups with addressing capabilities for extremely low power sensor network applications," in *IEEE 19th International Symposium on Personal, Indoor and Mobile Radio Communications*, September 2008.



- [2] I. Demirkol, C. Ersoy, and F. Alagoz, "MAC protocols for wireless sensor networks: a survey," *Communications Magazine, IEEE*, vol. 44, no. 4, pp. 115–121, 2006.
- [3] J. Polastre, J. Hill, and D. Culler, "Versatile low power media access for wireless sensor networks," in *Proceedings of the 2nd international conference on Embedded networked sensor systems (SenSys)*, Nov. 2004.
- [4] I. Akyildiz, W. Su, Y. Sankarasubramaniam, and E. Cayirci, "A survey on sensor networks," *Communications Magazine, IEEE*, vol. 40, no. 8, pp. 102–114, Aug 2002.
- [5] B. Otis, "Ultra-low power wireless technologies for sensor networks," Ph.D. dissertation, University of California, Berkeley, 2005.
- [6] J. Rabaey, J. Ammer, T. Karalar, S. Li, B. Otis, M. Sheets and T. Tuan, "PicoRadios for wireless sensor networks: the next challenge in ultra-low-power design," *IEEE Int'l Solid-State Ckts*, 2002.
- [7] M. J. Miller and N. H. Vaidya, "A MAC protocol to reduce sensor network energy consumption using a wakeup radio," *IEEE Transactions on Mobile Computing*, vol. 4, no. 3, pp. 228–242, 2005.
- [8] C. Schurgers, V. Tsiatsis, S. Ganeriwal, and M. Srivastava, "Optimizing sensor networks in the energy-latency-density design space," *IEEE Transactions on Mobile Computing*, pp. 70–80, Jan.-Mar. 2002.
- [9] L. Gu and J. Stankovic, "Radio-Triggered Wake-Up for Wireless Sensor Networks," *Real-Time Systems*, vol. 29, pp. 157–182, 2005.
- [10] M. Malinowski, M. Moskwa, M. Feldmeier, M. Laibowitz and J. Paradiso, "CargoNet: A low-cost micropower sensor node exploiting quasi-passive wakeup for adaptive asynchronous monitoring of exceptional events," *The 5th ACM Conference on Embedded Networked Sensor Systems (SenSys)*, pp. 145–159, November 2007.
- [11] A. Sample, D. Yeager, P. Powledge, and J. Smith, "Design of a Passively-Powered, Programmable Sensing Platform for UHF RFID Systems," *IEEE International Conference on RFID*, March 2007.
- [12] B. van der Doorn, W. Kavelaars and K. Langendoen, "A Prototype Low-Cost Wakeup Radio for the 868MHz Band," *International Journal of Sensor Networks (IJSNet)*, vol. 5, no. 1, pp. 22–32, 2009.
- [13] Atmel Corporation, "U3280M transponder interface for microcontroller, datasheet," [http://atmel.com/dyn/resources/prod\\_documents/doc4688.pdf](http://atmel.com/dyn/resources/prod_documents/doc4688.pdf). Last visited: 20.11.2008.
- [14] C. A. Balanis, *Antenna theory: analysis and design*. John Wiley & Sons, Ltd, 1996.
- [15] Avago Technologies, "Surface mount zero bias schottky detector diodes, HSMS-285x series, datasheet," <http://www.avagotech.com/assets/downloadDocument.do?id=2475>. Last visited: 20.11.2007.
- [16] Maxim Integrated Products, "Nanopower, beyond-the-rails comparators MAX9117 - MAX9120, datasheet," <http://datasheets.maxim-ic.com/en/ds/MAX9117-MAX9120.pdf>. Last visited: 20.11.2008.
- [17] J. Ansari, D. Pankin and P. Mähönen, "Demo abstract: Radio-triggered wake-ups with addressing capabilities for extremely low power sensor network applications," in *5th European Conference on Wireless Sensor Networking*, 2008.