

Radioisotope Power: A Key Technology for Deep Space Exploration

George R. Schmidt¹, Thomas J. Sutliff¹ and Leonard A. Dudzinski²

¹NASA Glenn Research Center,

²NASA Headquarters

USA

1. Introduction

Radioisotope Power Systems (RPS) generate electrical power by converting heat released from the nuclear decay of radioactive isotopes into electricity. Because all the units that have flown in space have employed thermoelectrics, a static process for heat-to-electrical energy conversion that employs no moving parts, the term, Radioisotope Thermoelectric Generator (RTG), has been more popularly associated with these devices. However, the advent of new generators based on dynamic energy conversion and alternative static conversion processes favors use of "RPS" as a more accurate term for this power technology. RPS were first used in space by the U.S. in 1961. Since that time, the U.S. has flown 41 RTGs, as a power source for 26 space systems on 25 missions. These applications have included Earth-orbital weather and communication satellites, scientific stations on the Moon, robotic explorer spacecraft on Mars, and highly sophisticated deep space interplanetary missions to Jupiter, Saturn and beyond. The New Horizons mission to Pluto, which was launched in January 2006, represents the most recent use of an RTG. The former U.S.S.R. also employed RTGs on several of its early space missions. In addition to electrical power generation, the U.S. and former U.S.S.R. have used radioisotopes extensively for heating components and instrumentation.

RPS have consistently demonstrated unique capabilities over other types of space power systems. A comparison between RPS and other forms of space power is shown in Fig. 1, which maps the most suitable power technologies for different ranges of power level and mission duration. In general, RPS are best suited for applications involving long-duration use beyond several months and power levels up to one to 10 kilowatts.

It is important to recognize that solar power competes very well within this power level range, and offers much higher specific powers (power per unit system mass) for applications up to several Astronomical Units (AU) from the Sun. However, RPS offer the unique advantage of being able to operate continuously, regardless of distance and orientation with respect to the Sun. The flight history of RTGs has demonstrated that these systems are long-lived, rugged, compact, highly reliable, and relatively insensitive to radiation and other environmental effects. Thus, RTGs and the more capable RPS options of the future are ideally suited for missions at distances and extreme conditions where solar-based power generation becomes impractical. These include travel beyond the asteroid belt, operation within the radiation-intensive environments around Jupiter and close to the Sun,

extended operation within permanently shadowed and occulted areas on planetary surfaces, and general applications requiring robust, unattended operations.

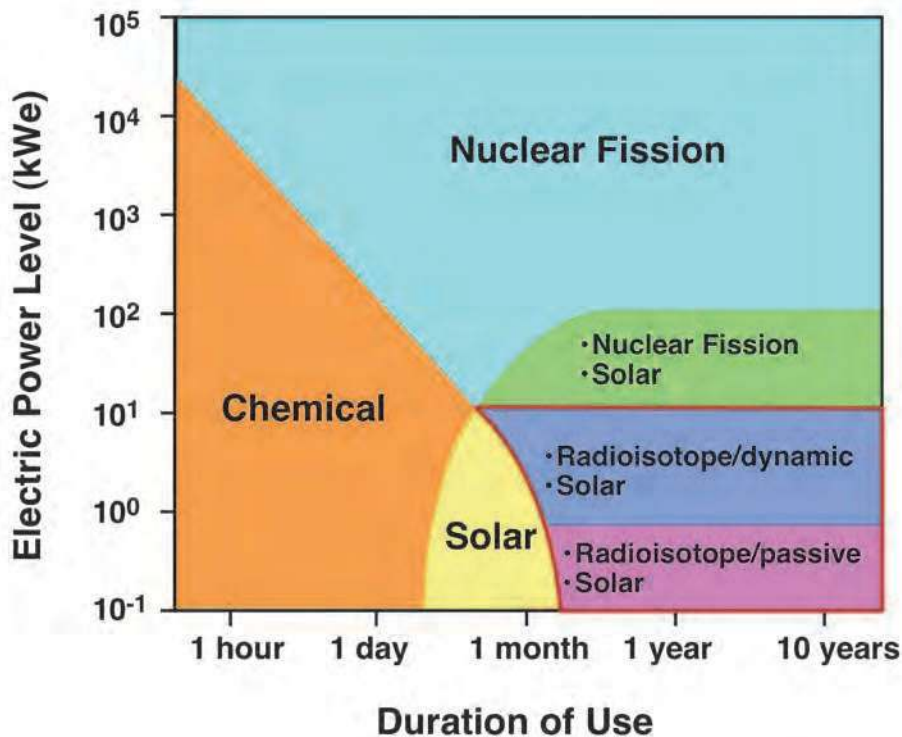

Fig. 1. Suitability of space power system technologies.

Table 1 presents a chronological summary of the U.S. missions that have utilized radioisotopes for electrical power generation. Although three missions were aborted by launch vehicle or spacecraft failures, all of the RTGs that flew met or exceeded design expectations, and demonstrated the principles of safe and reliable operation, long life, high reliability, and versatility of operating in hostile environments. All of the RTGs flown by the U.S. comprise seven basic designs: SNAP-3/3B, SNAP-9A, SNAP-19/19B, SNAP-27, TRANSIT-RTG, MHW-RTG and GPHS-RTG. The first four types were developed by the Atomic Energy Commission (AEC) under the auspices of its Systems for Nuclear Auxilliary Power (SNAP) program. Although the original objective was to provide systems for space, the SNAP program also developed generators for non-space, terrestrial applications.

The GPHS-RTG is the most recently developed unit, and has been the workhorse on all RPS missions since 1989. A cutaway view of the unit is shown in Fig. 2. NASA and the Department of Energy (DOE) are looking beyond this capability, and are currently developing two new units: the Multi-Mission RTG (MMRTG), which draws on the design heritage of the SNAP-19, and the new Advanced Stirling Radioisotope Generator (ASRG) with its much more efficient dynamic conversion cycle.

	Spacecraft/ System	Principal Energy Source (#)	Destination/ Application	Launch Date	Status
1	Transit 4A	SNAP-3B7 RTG (1)	Earth Orbit/ Navigation Sat	29 June 1961	RTG operated for 15 yrs. Satellite now shutdown.
2	Transit 4B	SNAP-3B8 RTG (1)	Earth Orbit/ Navigation Sat	15 Nov 1961	RTG operated for 9 yrs. Operation intermittent after 1962 high alt test. Last signal in 1971.
3	Transit 5BN-1	SNAP-9A RTG (1)	Earth Orbit/ Navigation Sat	28 Sep 1963	RTG operated as planned. Non-RTG electrical problems on satellite caused failure after 9 months.
4	Transit 5BN-2	SNAP-9A RTG (1)	Earth Orbit/ Navigation Sat	5 Dec 1963	RTG operated for over 6 yrs. Satellite lost navigational capability after 1.5 yrs.
5	Transit 5BN-3	SNAP-9A RTG (1)	Earth Orbit/ Navigation Sat	21 Apr 1964	Mission aborted because of launch vehicle failure. RTG burned up on reentry as designed.
6	Nimbus B-1	SNAP-19B2 RTG (2)	Earth Orbit/ Meteorology Sat	18 May 1968	Mission aborted because of range safety destruct. RTG fuel recovered and reused.
7	Nimbus III	SNAP-19B3 RTG (2)	Earth Orbit/ Meteorology Sat	14 Apr 1969	RTGs operated for over 2.5 yrs. No data taken after that.
8	Apollo 12	SNAP-27 RTG (1)	Lunar Surface/ Science Station	14 Nov 1969	RTG operated for about 8 years until station was shutdown.

	Spacecraft/ System	Principal Energy Source (#)	Destination/ Application	Launch Date	Status
9	Apollo 13	SNAP-27 RTG (1)	Lunar Surface/ Science Station	11 Apr 1970	Mission aborted. RTG reentered intact with no release of Pu-238. Currently located at bottom of Tonga Trench in South Pacific Ocean.
10	Apollo 14	SNAP-27 RTG (1)	Lunar Surface/ Science Station	31 Jan 1971	RTG operated for over 6.5 years until station was shutdown.
11	Apollo 15	SNAP-27 RTG (1)	Lunar Surface/ Science Station	26 July 1971	RTG operated for over 6 years until station was shutdown.
12	Pioneer 10	SNAP-19 RTG (4)	Planetary/Payload & Spacecraft	2 Mar 1972	Last signal in 2003. Spacecraft now well beyond orbit of Pluto.
13	Apollo 16	SNAP-27 RTG (1)	Lunar Surface/ Science Station	16 Apr 1972	RTG operated for about 5.5 years until station was shutdown.
14	Triad-01-1X	Transit- RTG (1)	Earth Orbit/ Navigation Sat	2 Sep 1972	RTG still operating as of mid-1990s.
15	Apollo 17	SNAP-27 RTG (1)	Lunar Surface/ Science Station	7 Dec 1972	RTG operated for almost 5 years until station was shutdown.
16	Pioneer 11	SNAP-19 RTG (4)	Planetary/Payload & Spacecraft	5 Apr 1973	Last signal in 1995. Spacecraft now well beyond orbit of Pluto.
17	Viking 1	SNAP-19 RTG (2)	Mars Surf/Payload & Spacecraft	20 Aug 1975	RTGs operated for over 6 years until lander was shutdown.
18	Viking 2	SNAP-19 RTG (2)	Mars Surf/Payload & Spacecraft	9 Sep 1975	RTGs operated for over 4 years until relay link was lost.

	Spacecraft/ System	Principal Energy Source (#)	Destination/ Application	Launch Date	Status
19	LES 8, LES 9	MHW-RTG (4)	Earth Orbit/ Com Sats	14 Mar 1976	Single launch with double payload. LES 8 shutdown in 2004. LES 9 RTG still operating.
20	Voyager 2	MHW-RTG (3)	Planetary/ Payload & Spacecraft	20 Aug 1977	RTGs still operating. Spacecraft successfully operated to Jupiter, Saturn, Uranus, Neptune, and beyond.
21	Voyager 1	MHW-RTG (3)	Planetary/ Payload & Spacecraft	5 Sep 1977	RTGs still operating. Spacecraft successfully operated to Jupiter, Saturn, and beyond.
22	Galileo	GPHS-RTG (2)	Planetary/Payload & Spacecraft	18 Oct 1989	RTGs continued to operate until 2003, when spacecraft was intentionally deorbited into Jupiter atmosphere.
23	Ulysses	GPHS-RTG (1)	Planetary/Payload & Spacecraft	6 Oct 1990	RTG continued to operate until 2008, when spacecraft was deactivated.
24	Cassini	GPHS-RTG (3)	Planetary/Payload & Spacecraft	15 Oct 1997	RTGs continue to operate successfully. Scientific mission and operations still continue.
25	New Horizons	GPHS-RTG (1)	Planetary/Payload & Spacecraft	Jan 19 2006	RTG continues to operate successfully. Spacecraft in transit to Pluto.

Table 1. U.S. Missions Using Radioisotope Power Systems (RPS)

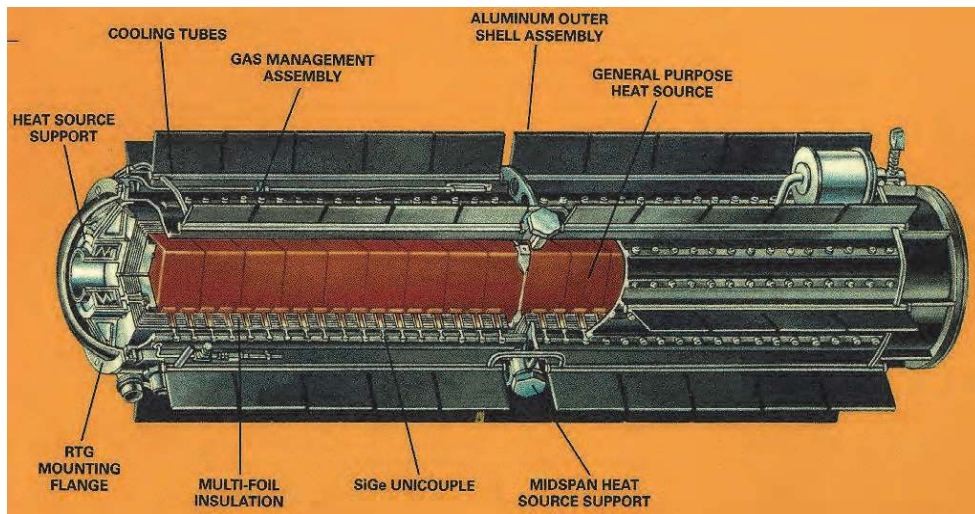

Fig. 2. GPHS-RTG.

2. RPS design

A typical RPS generator consists of two subsystems: a thermal source and an energy conversion system. The thermal source provides heat, which is produced by the decay process within the radioisotope fuel. This heat is partially transformed into electricity in the energy conversion system. Most of the remaining amount is rejected to space via radiators, although a small portion can be used to heat spacecraft components.

2.1 Thermal source

The performance characteristics of an attractive fuel include: a long half-life (i.e., the time it takes for one-half of the original amount of fuel to decay) compared to the operational mission lifetime; low radiation emissions; high specific power and energy; and a stable fuel form with a high enough melting point. The fuel must be producible in useful quantities and at a reasonable cost (compared to its benefits). It must be capable of being produced and used safely, including in the event of potential launch accidents.

Thermal source designs have been driven by aerospace nuclear safety standards, which have evolved considerably over time. For example, the fuel form for the early SNAP-3B and 9A systems was designed to burn up in the event of an atmospheric reentry, and disperse at high altitudes. Later systems, such as SNAP-19, were designed for fuel containment in the event of reentry. A key design feature now is to immobilize the Pu-238 fuel during all nominal and potentially abnormal phases of the mission, including launch abort, reentry into Earth's atmosphere, and post-reentry impact.

Establishing a fuel production and a fuel form fabrication capability is a very costly and time-consuming endeavor. Flight qualification of a new fuel form requires considerable effort in terms of costs and schedule. In addition, there are only a limited number of radioisotope fuels that meet the requirements for half-life, radiation, power density, fuel form, and availability for use in space power applications.

A variety of radioisotopes have been evaluated for space and terrestrial applications. The isotope initially selected for development was Cerium-144 (Ce-144), because it was one of the most plentiful fission products available from reprocessing defense reactor fuel at AEC's Hanford Site. Its short half-life (290 days) made Ce-144 compatible with the 6-month military reconnaissance satellite mission envisioned as the RPS application at that time. The cerium oxide fuel form and its heavy fuel capsule met all safety tests for intact containment of the fuel during potential launch abort fires, explosions, and terminal impacts. However, the high radiation field associated with the beta/gamma emission of Ce-144 complicated handling and caused problems with payload interaction, as well as safety issues upon reentry from orbit. Although Ce-144 was used to fuel SNAP-1, the first RTG, it was never used in space.

By the late 1950s, large amounts of Polonium-210 (Po-210) became available, also as a by-product of the nuclear weapons program. Po-210 is an alpha emitter with a very high power density (~1,320 W/cm³) and low radiation emissions. It is made by neutron irradiation of Bismuth-209 targets in a nuclear reactor. It was used in polonium-beryllium neutron sources. Po-210 metal was used to fuel the small (5 We) SNAP-3 RTG in order to demonstrate RTG technology. It was first displayed at the White House in January 1959. Several SNAP-3 RTGs were fueled with Po-210 and used in various exhibits. However, the short 138-day half-life of Po-210 makes it suitable for only limited duration space power applications.

In order to provide a longer-lived radioisotope fuel, Strontium-90 (Sr-90), an abundant fission product with a 28.6-year half-life, was recovered from defense wastes at Hanford. A very stable and insoluble fuel form, strontium-titanate, was developed and widely used in terrestrial power systems. Because Sr-90 and its daughter Yttrium-90 emit high-energy beta particles, they give off significant bremsstrahlung radiation and require heavy shielding. However, shield mass is not as critical for most terrestrial power systems as it is for space power applications.

By 1960, Plutonium-238 (Pu-238) had been identified as an attractive radioisotope fuel. It could be made by irradiating Neptunium-237 (Np-237) targets in defense production reactors. The availability of Pu-238 was extremely limited due to a shortage of Np-237 target material, which must be recovered from processing (and recycling) high burn-up, enriched uranium fuel. However, Pu-238 has all the desirable characteristics for a space power system fuel: long half-life (87.74 years), low radiation α -particle emissions, high power density and useful fuel forms (as the metal or the oxide form). Therefore, after flight qualification of its heat source, a Pu-238 fueled SNAP-3A RTG was launched on the Transit 4A Navy navigation satellite in June 1961 – the first use of nuclear power in space.

The first Pu-238 heat sources used in space were relatively small and employed Pu-238 metal or plutonium-zirconium alloy fuel forms contained in tantalum-lined superalloy (Haynes-25) fuel capsules. These heat sources withstood all postulated launch pad accident and downrange impact environments, but they were designed to burn-up and disperse throughout the upper atmosphere in the event of reentry from space. This type of accident happened during the fifth launch of an RTG (SNAP-9A aboard Transit 5BN-3) when the spacecraft failed to achieve orbit and the RTG burned up over the Indian Ocean in April 1964.

Subsequent Pu-238 fueled space power systems were designed to use progressively higher temperature fuel forms and containment materials with a progressively higher degree of containment of the fuel under all postulated accident conditions (including reentry). As the

intact reentry heat source technology was developed, the fuel inventories (power levels) per launch also increased. A number of RTGs were launched on NASA and Navy missions with Pu-238 dioxide microsphere and plutonia-molybdenum-cermet (PMC) fuel forms in the late-1960s and early-1970s. Since the mid-1970s, pressed Pu-238 oxide fuel forms have been exclusively used in all RPS launched into space.

The amount of Pu-238 that could be produced has always been a limiting factor in its use in space missions. Therefore, several other radioisotopes have been thoroughly evaluated for space use over the years. Sr-90 and Po-210 fuels were considered for use in higher powered military satellite constellations for which there were insufficient quantities of Pu-238 available. These programs were cancelled before they were completed, so these fuels were never used in space by the U.S.

Curium-242 (Cm-242) was selected to fuel an isotope power system for the 90-day Surveyor mission to the Moon. Both the SNAP-11 RTG and SNAP-13 thermionic generators were developed for the Surveyor mission. Cm-242 is produced by reactor irradiation of Americium-241 (Am-241) targets. Cm-242 has a short half-life of 162 days, which is acceptable for a 90 day mission, and has a very high power density, which is necessary for a thermionic heat source. It also has a high melting point oxide fuel form capable of the high operating temperature necessary for thermionic energy conversion. A Cm-242 demonstration heat source was produced for the SNAP-13 engineering unit. However, it was decided that the Surveyor program would not use isotope power units, and Cm-242 fueled power systems have never been used in space. Due to its short half-life, Cm-242 is not suitable for the longer durations required by most space missions.

At one time, Curium-244 (Cm-244) was investigated as a potential alternative to Pu-238, because it was expected to become available in significant quantities from the U.S. program to develop breeder reactor fuel cycles. Cm-244 was considered an attractive space fuel because it has a relatively long half-life (18.2 years), a power density five times greater than that of Pu-238 and has a very stable, high temperature oxide fuel form. However, higher neutron and gamma emissions due to the higher rate of spontaneous fission of Cm-244 would increase shielding requirements for handling and for protection of spacecraft instrumentation. The increase weight of shielding and power flattening equipment required with Cm-244 makes it less desirable than Pu-238, especially for long duration missions. Cm-244 is also more difficult to produce, requiring successive neutron captures starting with Pu-239. Many years ago, several kilograms of Cm-244 were made as a target material for the Californium-252 program, but there is currently no practical production or processing capability for large quantities of Cm-244.

In the final analysis, Pu-238 is clearly superior to other radioisotope fuels for use in long duration space missions. The technology for producing and processing Pu-238 fuel forms has been refined over the past 50 years. Pu-238 fueled heat sources have been through rigorous flight qualification testing and have performed reliably in all of the RPS employed in the U.S. space program to date.

The most significant issue with Pu-238 is its limited availability. For the past 50 years the production and processing of Pu-238 fuel has been accomplished as a by-product of the production of materials for nuclear weapons. The discontinuation of this production in the 1990s eliminated the traditional means for producing Pu-238. During the 2000s, the U.S. began to purchase Pu-238 from Russia. However, this supply is also limited, so in the long-term, resumption of production is necessary.

2.2 Fuel encapsulation and containment

Encapsulation is an important aspect of the design of the thermal source and consists of several elements, each of which serves one or more important functions in the safe handling and use of the fuel. The state-of-the-art in fuel encapsulation and containment is the General Purpose Heat Source (GPHS) module shown in Fig. 3.

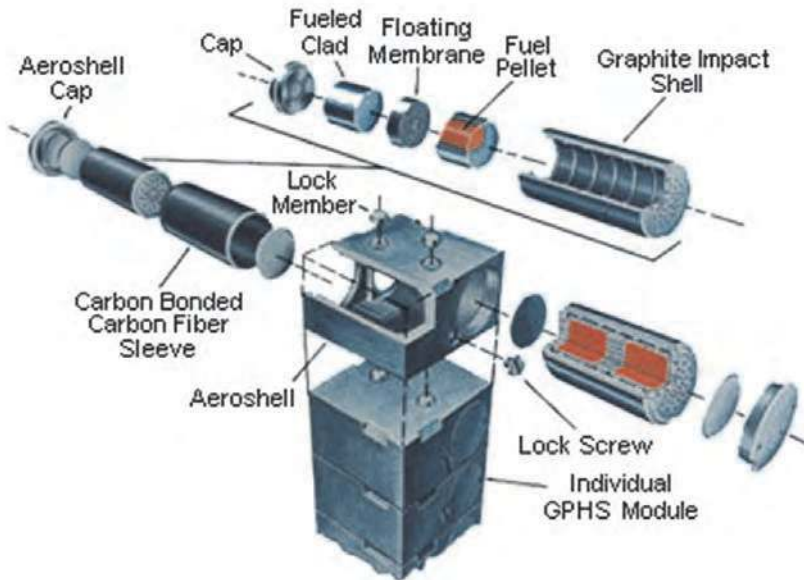

Fig. 3. GPHS module assembly.

The GPHS is modular in design, thus allowing it to be stacked into variable thermal source configurations. Eighteen of these modules are stacked together to serve as the thermal source for the GPHS-RTG, shown in Fig. 2. It is being used in an 8-module stack for the recently developed MMRTG, and two individual GPHS will be used as the heat source for the new ASRG, currently under development.

Safety is the principal design driver for the GPHS. The main objective is to keep the fuel contained or immobilized to prevent inhalation or ingestion by humans. Each module is composed of five main elements: the fuel; the fuel cladding; the graphite impact shell (GIS); the carbon-bonded carbon fiber (CBCF) insulation; and the Fine Weave Pierced Fabric (FWPFTM) aeroshell. Each GPHS module contains four fuel pellets made of a high-temperature PuO₂ ceramic with a thermal inventory of approximately 62.5 Wt (Watts-thermal) per pellet and 250.0 Wt per module. Each module has a total mass of about 1.43 kg.

During its development program in the late 1970's, the GPHS went through a number of exacting engineering tests to assess its performance under operating conditions, including vibration and operating temperature. An extensive safety testing and analyses program was conducted to assess the GPHS performance under a range of postulated accident conditions such as launch pad explosions, projectile impacts, propellant fires, impacts, and atmospheric reentry.

The fuel pellets, one of which is shown in Fig. 4, are individually encapsulated in a welded iridium alloy clad.



Fig. 4. GPHS PuO₂ Fuel Pellet.

The alloy is capable of resisting oxidation in a hypothetical post-impact environment while also being chemically compatible with the fuel and graphitic components during high-temperature operation and postulated accident environments.

Two fueled clads are encased in a cylindrical graphite impact shell (GIS) made of FWPFTM, a carbon-carbon composite material. The GIS is designed to provide protection to the fueled clads for postulated impact. Two of these GIS assemblies, each containing two fueled clads, are located in each FWPFTM aeroshell. A carbon-bonded carbon fiber (CBCF) insulator surrounds each GIS within the aeroshell to limit the peak temperature of the fueled clad during inadvertent reentry and to maintain a sufficiently high temperature to ensure its ductility upon the subsequently postulated impact.

The aeroshell serves as the primary structural member of the GPHS module as it is stacked inside the RPS unit. The aeroshell is designed to contain the two graphite impact shell assemblies under a wide range of postulated reentry conditions and to provide additional protection against postulated impacts on hard surfaces at terminal velocity. FWPFTM was selected because its composite structure gave it a high margin of safety against the thermal stresses associated with postulated atmospheric reentries. The aeroshell also provides protection for the fueled clads from postulated launch vehicle explosion overpressures and fragment impacts and it can provide protection in the event of a propellant fire.

2.3 Power conversion systems

A portion of the heat generated from the thermal source is converted to useful electrical energy in the power conversion system. There are two general classes of energy conversion systems: static and dynamic. Static systems include thermoelectric, thermionic, and thermophotovoltaic conversion devices which can convert heat to electricity directly with no moving parts. Dynamic systems involve heat engines with working fluids that transform heat to mechanical energy which in turn is used to generate electricity. Dynamic systems include Stirling, Brayton and Rankine cycle engines that operate with various types of working fluids.

After passing through the energy conversion system, the unconverted waste heat must be rejected to the environment at lower temperatures. For space power systems some of the waste heat can be utilized to control the temperature of the spacecraft equipment, but ultimately the waste heat must be radiated to the space vacuum environment.

Thus, the operating temperatures for an RPS are set on the hot side by the heat source and conversion system material limitations (T_{hot}) and on the cold side by the size, weight, and heat sink conditions of the radiator (T_{cold}). The overall efficiency of the energy conversion system is limited to something less than the Carnot efficiency of $(T_{hot} - T_{cold})/T_{hot}$. Higher efficiencies can significantly reduce fuel usage, which has many implications for cost, availability, size, weight, and safety.

Conversion system reliability is another important consideration. Since mission success depends on having sufficient electrical power over the life of the mission, conversion system selection must be consistent with mission power levels and lifetimes. For instance, it makes little sense to combine an unreliable or short-lived energy conversion unit with a 100% reliable, long-lived isotope heat source. Graceful power degradation over the life of a mission is acceptable as long as it is within predictable limits.

Other important considerations in selecting a system include mass, size, ruggedness to withstand shock and vibration loads, survivability in hostile particle and radiation environments, scalability in power levels, flexibility in integration with various types of spacecraft (and launch vehicles), and versatility to operate in the vacuum of deep space or on planetary surfaces with or without solar energy.

2.4 Thermoelectric energy conversion

All of the RPS units flown in space have utilized thermoelectric energy conversion. Thermoelectric converters are useful over a very wide range of power levels (from milliwatts to kilowatts) and their operating temperatures are ideally suited for radioisotope heat sources. Thermoelectric converters are reliable over operational lifetimes of several decades, compact, rugged, radiation resistant, easily adapted to a wide range of applications, and produce no noise, vibration or torque during operation. Thermoelectric converters require no start-up devices to operate, and begin producing electrical power (direct current and voltage) as soon as the heat source is installed. Power output is easily regulated at design level by maintaining a matched resistive load on the converter. The only disadvantage of thermoelectrics is their relatively low conversion efficiencies, which is typically less than 10%.

Thermoelectric materials, when operating over a temperature gradient, produce a voltage due to the Seebeck effect. When connected in series with a load, the internally generated voltage causes a current to flow through the load producing useful power. The Seebeck effect was discovered in 1825, but had little practical use, except in measuring temperatures with dissimilar metal thermocouples. With the advent of semiconductor materials in the 1950s, application of thermoelectrics has expanded dramatically.

Power is produced in a thermoelectric element by placing it between a heat source and a heat sink. Good thermoelectric semiconductor materials have large Seebeck voltages in combination with a relatively high electrical conductivity and low thermal conductivity (in contrast to most metals). By proper doping, n and p type elements can be formed so that current will flow in the same or opposite directions as the heat. By electrically joining the n and p elements through a hot shoe, a thermocouple is formed which can be connected to other

thermocouples at the cold shoe to form a converter with the desired output voltage and current. Thermocouples can be connected in a series-parallel arrangement to enhance reliability by minimizing the effect on total power due to an open circuit or short circuit failure in a single thermocouple. Typically, thermoelectric couples are low voltage, high current devices so a number of them must be connected in series to produce normal load voltages.

The most widely used thermoelectric materials in order of increasing temperature capability, are: Bismuth Telluride (BiTe); Lead Telluride (PbTe); Tellurides of Antimony, Germanium and Silver (TAGS); Lead Tin Telluride (PbSnTe); and Silicon Germanium (SiGe). All except BiTe have been used in space RTG applications. Many more materials have been, and are still being, investigated in hopes of finding that ideal thermoelectric material from which to produce higher efficiency, lower mass, and more stable performance over longer operating lifetimes.

The telluride materials are limited to a maximum hot junction temperature of 550 C. Due to the deleterious effects of oxygen on these materials and their high vapor pressure, the tellurides must be operated in a sealed generator with an inert cover gas to retard sublimation and vapor phase transport within the converter. Bulk-type, fibrous thermal insulation must be used due to the presence of the cover gas. Buildup of helium gas from α -particle emission must be controlled by using a separate container around the heat source or permeable seals in the generator design. Gas management considerations in the generator housing design and the use of bulk insulation materials increase the size and weight of the generator. However, this type of RTG is equally useful for space vacuum or for planetary atmospheric applications.

SiGe materials can be operated at hot junction temperatures up to 1,000 C. Their sublimation rates and oxidation effects, even at these higher temperatures, can be controlled by use of sublimation barriers around the elements and an inert cover gas within the generator during ground operation. A pressure release device, designed to open upon reaching orbital altitude, opens the generator to space vacuum for operation on deep space missions. This allows use of multifoil thermal insulation and also vents the helium to space as it is generated. A SiGe RTG is usually smaller and lighter than is a telluride RTG of similar power level.

The overall efficiency of the two types of thermoelectric generators are comparable. Although the tellurides have a higher material efficiency than SiGe, the SiGe operates over a larger temperature gradient. Cold junction temperatures are determined more by radiator weight than by efficiency considerations for space RTGs and are normally in the range of 200-300 C. Although various convectively cooled radiator systems have been developed (e.g., heat pipes), conductively coupled finned radiators attached to the generator housing are normally more weight efficient for low-powered RTGs of up to 300 We.

2.5 Stirling energy conversion

For higher power levels of 100 We and above, the more efficient dynamic power conversion technologies enable better use of the limited radioisotope fuel, offer systems with a higher power-to-weight ratio and make it easier to integrate the radioisotope power system with the spacecraft compared to the number of RTGs required to produce kilowatts of power. Dynamic heat-to-electricity conversion efficiencies of 25% and more are achievable, which reduce the radioisotope inventory by at least one-quarter of that for RTGs. This reduces mass, cost, and potential safety risks for higher-powered radioisotope systems.

Stirling cycle engines use a light working gas that expands by absorption of heat on the hot side and contracts by rejection of heat on the cold side causing rapidly changing pressure cycles across a piston forcing it to move in a reciprocating fashion. The movement of the piston can drive a linear alternator to produce electricity.

Traditional Stirling engines use a rhombic drive mechanism to convert the reciprocating motion into a rotary motion that drives an ordinary rotating alternator. This requires lubrication of a gear-box and seals to separate the working gas from the lubricating oil. The engine housing cannot be hermetically sealed because of the penetration of the rotary power shaft. Such Stirling engines have been widely used throughout the world.

A more recent development is the Free Piston Stirling engine which requires no lubricating fluids and produces electricity by means of a linear alternator within the hermetically sealed engine housing. The piston moves back and forth at a resonant frequency on a cushion of working gas between it and the surrounding cylinder wall. Piston displacement is controlled by gas pressure across the piston. A permanent magnet is attached to the power piston and produces electrical currents in surrounding alternator coils as it vibrates back and forth. Since the reciprocating motion of the piston would cause unbalanced vibration loads, these Stirling engines usually are designed in pairs with dynamically opposed pistons so that no net load is transmitted to the engine mounts.

Heat is also exchanged between the hot and cold gas flowing from one side of the piston to the other to enhance the conversion efficiency. Due to the limited volume of working gas within the Stirling engine, heat transfer between the heat source and the heater head of the engine, between the hot and cold gas, and between the cold gas and a radiator system are the most challenging requirements for an optimum engine design. The Stirling cycle provides the highest conversion efficiencies of any dynamic cycles at the same cycle temperatures. Therefore, efficiencies of 30% or more are possible at operating temperatures achievable with isotope heat sources and oxidation-resistant superalloy structural materials. The Stirling engine also promises to retain its high performance characteristics at lower power levels compared to the other dynamic systems, which is also attractive for radioisotope power systems.

2.6 Other energy conversion technologies

Research and development of other energy conversion technologies has been an important aspect of RPS programs in the past. Although thermoelectrics and Stirling have received the most attention, there are several other technologies that could achieve higher heat-to-electric conversion efficiencies and considerably lower masses than the systems in use today.

One of these is Thermophotovoltaics (TPV), which is another static form of electrical power conversion. A thermophotovoltaic (TPV) converter transforms the energy from infrared photons emitted by a hot surface into electricity using photovoltaic (PV) cells. TPV converters use advanced PV cells, spectrally-tuned to optimize conversion of the emitted photon energy. Controlling the frequency of photon energy impinging on the PV cells by means of selective emitters, PV cell materials and filter properties are key to achieving high performance. Studies in the past have suggested the possibility of achieving efficiencies of up to 20% with TPV.

On the dynamic side, the Brayton is another thermodynamic cycle consisting of a turbine/alternator, compressor and heat exchangers. An additional recuperator heat exchanger is often used to transfer heat within the cycle and improve cycle efficiency. An inert gas working fluid, typically a mixture of helium and xenon, is sequentially heated in

one heat exchanger, expanded through the turbine, passed through a gas cooler and pressurized by the compressor thus completing the cycle. A rotary alternator attached to the turbine shaft produces alternating current (AC) electrical power.

3. The early years

The history of RPS began in the early years of the Cold War, when surveillance satellites were a major impetus for the early space race. The Manhattan project and the years leading up to it had yielded a wealth of knowledge on nuclear physics, particularly the radio-decay properties of actinides and other alpha particle-producing materials. The energy released from the radioactive decay of different elements had become well characterized, and it was recognized early on that radioisotopes could provide power for military satellites and other remote applications. An early study by the North American Aviation Corporation had considered radioisotopes for space power. Then a RAND Corporation report in 1949 evaluated options for space power, and concluded that a radioactive cell-mercury vapor system could feasibly supply 500 We (watts-electric) for up to one year. In 1952, RAND issued a report with an extensive discussion on radioisotope power for space applications, which spurred interest in applying the technology on satellites.

Recognizing the viability of nuclear power for reconnaissance satellites, the Department of Defense (DOD) requested in August 1955 that the Atomic Energy Commission (AEC) perform studies and limited experimental work toward developing a nuclear reactor auxiliary power unit for an Air Force satellite system concept. AEC agreed, but wanted to broaden its examination to both radioisotope and reactor heat sources. This marked the beginning of the SNAP program, which was structured into parallel power plant efforts with two corporations. Odd-numbered SNAP projects focused on RPS and were spearheaded by the Martin Company, while even-numbered SNAP projects using reactors were performed by the Atomics International Division of North American Aviation, Inc.

In these early days, efforts focused on dynamic energy conversion. The work of the Martin Company progressed through an early SNAP-1 effort that used the decay heat of Cerium-144 to boil Mercury and drive a small turbine in a Rankine cycle. In early 1954, a new simpler static energy conversion method was conceived by Kenneth Jordan and John Birden of the AEC's Mound Laboratory in Miamisburg, Ohio. Having been frustrated in their efforts to use radioisotope heat sources to generate electricity via steam turbines, these two researchers considered using two metals with markedly different electrical conductivities to generate electricity directly from an applied heat load. This thermoelectric method was patented by Jordan and Birden, and has remained the basis for all RTGs to the present day. In 1958, work began on two thermoelectric demonstration devices at Westinghouse Electric and 3M, while AEC contracts with other companies explored the development of demonstration thermionic units.

The project to develop a generator based on thermoelectric energy conversion was given the designation, SNAP-3. The 3M Company delivered a workable converter to the Martin Company in December 1958. Shortly thereafter, a complete radioisotope-powered generator was delivered to the AEC as a proof-of-principle device, producing 2.5 We with a half charge of Polonium-210 (Po-210) fuel.

That SNAP-3 actually never flew in space, but it became an invaluable showpiece for RPS and the SNAP program. President Eisenhower, who had been keenly interested in developing nuclear power for U.S. surveillance satellites, was shown this breakthrough device in January 1959, when the SNAP-3 was displayed on his desk in the Oval Office (Fig. 5). Eisenhower used the opportunity to emphasize his view of “peaceful uses” of nuclear technology, and it afforded him an opportunity to issue a challenge to NASA to develop missions that could exploit the device’s potential. The SNAP-3 continued its marketing role, and was shown at several foreign capitals as part of the U.S.’s “Atoms for Peace” exhibits.



Fig. 5. SNAP-3 presentation to President Eisenhower.

4. Flight systems

4.1 SNAP-3B

The first successful use of RTGs in space took place with the U.S. Navy’s Transit satellite program. Also known as the NNS (Navy Navigation Satellite), the Transit system was used by the Navy to provide accurate location information to its ships. It was also used for general navigation by the Navy, as well as hydrographic and geodetic surveying, and was the first such system to be used operationally. The Johns Hopkins Applied Physics Laboratory (APL) developed the system, starting in 1957. Many of the technologies developed under the Transit program are now in use on the Global Positioning System (GPS).

Several of the Transit developers had been considering the use of RPS since the beginning of the program. Although solar cells and batteries had powered the first six Transit satellites, there was concern that the battery hermetic seals would not meet the five-year mission requirement. Thus, APL accepted an offer from the AEC to include an auxiliary nuclear power source on the satellite. At that time, however, the radioisotope fuel of choice, Plutonium-238 (Pu-238), was unavailable due to AEC restrictions, and APL refused to use beta-decaying Strontium-90 because of the excessive weight associated with its necessary shielding. The AEC eventually acquiesced and agreed to provide the Pu-238 fuel. The SNAP-3 was converted from use of Po-210 to Pu-238, and acquired the new designation, SNAP-3B. The SNAP-3B RTGs on board these spacecraft supplemented solar cell arrays and demonstrated operation of nuclear systems for space power applications.

A schematic of the SNAP-3B generator is shown in Fig. 6. Each unit had a mass of 2.1 kg and an initial power output of 2.7 We, and was designed to last five years. Although this power level was quite low, the RTG performed the critical function of powering the crystal oscillator that was the heart of the electronic system used for Doppler-shift tracking. It also powered the buffer-divider-multiplier, phase modulators and power amplifiers. The heat source produced approximately 52.5 Wt from 92.7 grams of encapsulated plutonium metal, which had an isotopic mass composition of 80% Pu-238, 16% Pu-239, 3% Pu-240, and 1% Pu-241. The power conversion assembly consisted of 27 spring-loaded, series-connected pairs of Lead-Telluride (Pb-Te) thermoelectric elements operating at a hot-juncture temperature of about 783 K and a cold-juncture temperature of about 366 K. The power system had a power-conversion efficiency of 5 to 6 percent and a specific power of 1.3 We/kg.

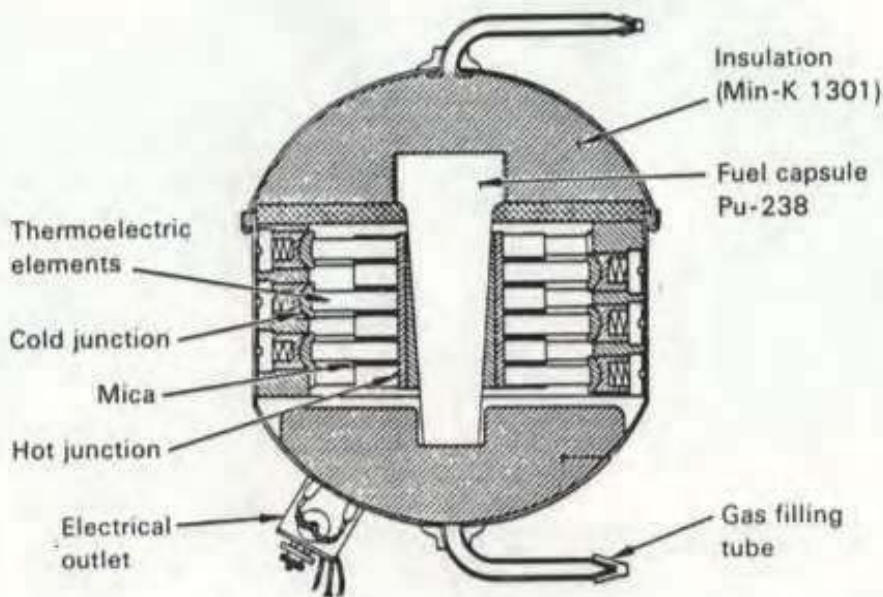

Fig. 6. SNAP-3B Schematic.

Transit 4A was launched, along with two other satellites (Fig. 7), on June 29, 1961 aboard a Thor-Able rocket. Transit 4B was launched soon afterward on November 15, 1961. Even for this first use of nuclear power in space, there was controversy stemming from concerns over launch safety. The State Department, in particular, expressed concern with its trajectory over Cuba and South America. As part of the aerospace nuclear safety philosophy at that time, the generators were designed for burnup and high altitude fuel dispersal to concentrations below the background radiation attributed to atmospheric nuclear weapons testing. In addition, the spacecraft were placed into 1,100-km orbits, which provided orbital lifetimes (>1,000 years) sufficient for the fuel to decay to these background levels. The Transit 4A generator operated for 15 years, and was shutdown in 1976. The last reported signal from Transit 4B was in April 1971.

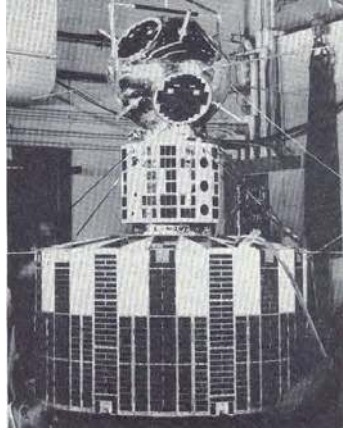

Fig. 7. Integrated Transit payload. Transit satellite is positioned at bottom of stack.

4.2 SNAP-9A

After the success of SNAP-3B, the team consisting of the AEC, Martin, 3M, Mound Laboratory and APL proceeded to develop the SNAP-9A for the next series of Transit satellites. There was also a growing demand for isotope power for terrestrial applications. For instance, the SNAP-7 series of devices was under development for the Navy, Coast Guard, and Weather Bureau for navigation lights and weather stations on Earth.

DOD decided to continue using RTGs for its navigational satellites because of their resistance to radiation. A high-altitude nuclear explosive test in 1962 had adversely impacted the solar cells of earlier Transit satellites, and DOD was concerned with their susceptibility to radiation and other space effects in the future. The SNAP-9A was essentially an expanded version of the SNAP-3B, and was the first RTG employed as the primary spacecraft power source. Its power capability of 26.8 We at beginning of mission (BOM) was nearly an order of magnitude greater than the SNAP-3B.

Each 12.3-kg SNAP-9A was designed to provide continuous power for five years in space after one year of storage on Earth. The thermal inventory of 525 Wt (watts-thermal) was supplied by Pu-238 metal encapsulated in a heat source of six fuel capsules maintained in a segmented graphite heat-accumulator block. As shown in Fig. 8, the main body was a sealed cylindrical magnesium-thorium shell containing six heat-dissipating magnesium fins. The unit was 26.7 cm tall and had a fin-to-fin diameter (fin span) of 50.8 cm. The 70 pairs of series-connected Pb-Te thermoelectric couples were assembled in 35 modules of two couples each. Hot junction temperature was calculated at about 790 K at beginning of life. Some waste heat from the RTG was used to maintain electronic instruments in the satellite at a temperature near 293 K.

The SNAP-9A missions in 1963 also marked the beginning of a formal launch safety review process. Although the launches were for DOD systems, NASA was invited to participate in the reviews, which were made a responsibility of the joint AEC/NASA Space Nuclear Power Office. It was during these early launches that efficient and comprehensive review and approval procedures were developed. As early as January 1963, a model charter had been developed for an ad-hoc interagency review committee. Eventually this became known as the INSRP (Interagency Nuclear Safety Review Panel).

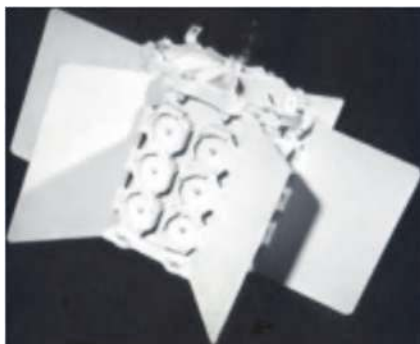

Fig. 8. SNAP-9A RTG.

After a period of program delays, Transit 5BN-1 (Fig. 9) was launched successfully on September 28, 1963, followed by Transit 5BN-2 on December 5, 1963. The third and last launch of the Transit 5BN-3 on April 21, 1964 was not as successful. A mission abort occurred after the payload had reached an altitude of 1,000 miles over the South Pole. Preliminary data indicated that the payload reentered the atmosphere over the Mozambique Channel at a steep angle. The Pu-238 fuel was designed to burn up into particles of about one millionth of an inch in diameter and disperse widely so as not to constitute a health hazard. Balloon samples taken over the next few years confirmed that the generator's fuel had indeed burned up as expected after the spacecraft failed to achieve orbit.



Fig. 9. Transit 5BN-1.

Although there was a commitment to fly higher power NASA missions, the loss of Transit 5BN-3 led to concerns that the dispersion approach would be unsafe with larger inventories of fuel. Thus, the basic safety concept changed from designing for burn-up and dispersion to designing for intact reentry. By the time that new approach was integrated into an RTG-powered space mission, however, the mechanisms for interagency review and meticulous safety analysis were well established. Another change was the mobilization and

decentralization of technical and administrative support so as to directly involve more of the laboratories and facilities of both AEC and NASA.

4.3 SNAP-19 – Nimbus

Noting the success of the SNAP-3A, NASA requested the AEC to evaluate the feasibility of a 50-We RTG for an upcoming Nimbus weather satellite. Nimbus was the first U.S. weather satellite system to make day and night global temperature measurements at varying levels in the atmosphere, and all earlier satellites had been powered exclusively by solar cells. The request led to design and integration studies by the AEC and establishment of the SNAP-19 technology improvement program. With Nimbus, the SNAP program received its first opportunity to test and demonstrate an RTG on a NASA spacecraft.

The unit that eventually flew on Nimbus, SNAP-19B, was used as an auxiliary system. As shown in Fig. 10, each Nimbus satellite carried two SNAP-19B RTGs, which provided about 20% of the total power delivered to the spacecraft bus. This extra continuous power enabled full-time operation of a number of extremely important atmospheric-sounder experiments. Without the RTGs, the total delivered power would have fallen below the load line about two weeks into the mission.



Fig. 10. Nimbus III. First NASA application of Radioisotope power.

SNAP-19B was very similar to the SNAP-9A in terms of configuration and performance. It had a height of 26.7 cm and a fin span of 53.8 cm. Its mass of 13.4-kg and BOM power level of 23.5 We yielded a specific power of 2.1 We/kg, the same as SNAP-9A.

The SNAP-19B was unique in its use of a new 645 Wt heat source, called the Intact Impact Heat Source (IIHS), in conjunction with an array of 90 Pb-Te thermocouples. The IIHS was designed to contain the fuel under normal operating conditions and to limit probability of contaminating the environment in the event of a launch abort or accident. In contrast to the SNAP-9A fuel design, the fuel form for SNAP-19B was changed from Plutonium metal to small Plutonium oxide (PuO₂) microspheres carried in capsules. Even in a worst-case

scenario involving release and dispersal of the microspheres, the particles would be too big for inhalation. Additional safety design requirements included survival upon reentry and containment/immobilization of the fuel upon impact.

Launch of the Nimbus-B-1 took place on May 18, 1968. Unfortunately an error in setting a guidance gyro caused Nimbus-B-1 to veer off course. The Range Safety Officer sent the destruct signal 120 seconds into flight, thus blowing up the Agena stage at an altitude of 100,000 feet. The upper portion of the stage, including the satellite, fell into water depths of 300 to 600 feet about two to four miles to the north of San Miguel Island in the Santa Barbara Channel. The unit was found in September 1968, and was sent back to the Mound Laboratory for reuse. A second Nimbus satellite (Nimbus III or Nimbus-B-2) was launched and successfully placed into orbit on April 14, 1969. The SNAP-19B RTGs used here had slightly more fuel than their predecessors due to the use of less efficient but more stable thermoelectrics. The units operated fine for approximately 20,000 hours (2.5 years) until they experienced a sharp degradation in performance. This decline was attributed to the sublimation of thermoelectric material and loss of the hot junction bond due to internal cover gas depletion.

Nimbus was the first and last time RTGs were used in Earth orbit by NASA. At that time, solar photovoltaics were still relatively new. With advancement in this area, NASA did not feel that RTGs were warranted for applications where solar cells could work. In addition with the more structured launch safety review process, it was much more cost effective to use solar cells whenever possible.

4.4 SNAP-19 – Pioneer and Viking

The successful demonstration of Nimbus III encouraged NASA to commit to use of SNAP-19 on the Pioneer and Viking missions, arguably NASA's most exciting science missions of the 1970's. The SNAP-19 design for these applications (Fig. 11), however, had to be modified. For Pioneer, this was driven by the need for a mission life of up to six years. Other modifications were required to deliver a higher power, and to withstand the unique environments of Mars and deep space. For Pioneer, the most significant modification was incorporation of TAGS/Sn-Te thermoelectric elements (thermocouple legs consisting of Tellurium, Antimony, Germanium, Silver and Tin), which increased efficiency, lifetime and power performance. The generator height was also increased to 28.2 cm, and the fin span was reduced to 50.8 cm. This yielded a power output of 40.3 We. The resultant specific power of 3.0 We/kg was nearly 50% higher than the Nimbus design.

Pioneers 10 and 11 were launched on 2 March 1972 and 6 April 1973, respectively. Pioneer 10 was the first spacecraft to travel through the asteroid belt and to make direct observations of Jupiter, which it encountered on 3 December 1973. According to some definitions, Pioneer 10 became the first artificial object to leave the solar system, on 13 June 1983. Pioneer 11 also encountered Jupiter, and in addition to conducting measurements, the spacecraft used a Jupiter gravity assist maneuver to alter its trajectory toward Saturn. After nearly five years, Pioneer 11 encountered Saturn in September 1979, and provided the first local measurements of this planet and its rings before it followed an escape trajectory out of the solar system.

The most noteworthy aspect of the SNAP-19s used for these missions (Fig. 12) was the extremely long time the units continued to operate past their primary tasks and baseline mission lifetimes. Both of these spacecraft continued to transmit data far beyond the orbit of Pluto, and more than fulfilled the original expectations for their operation.

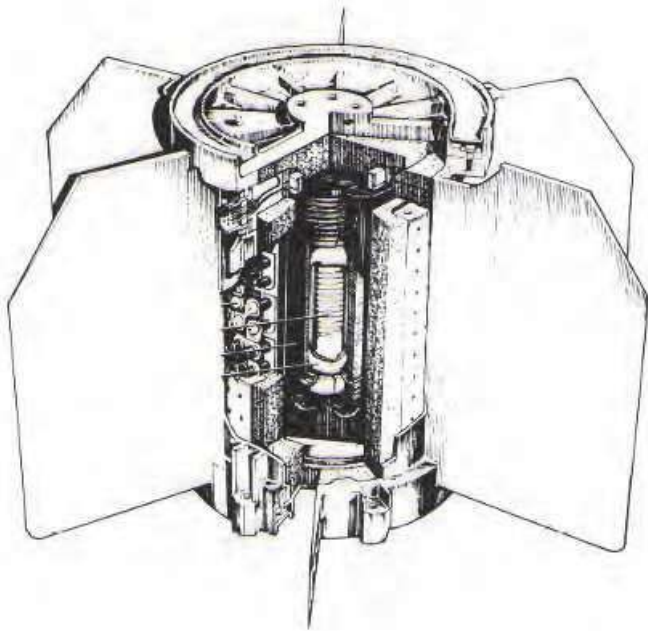

Fig. 11. Pioneer SNAP-19.



Fig. 12. SNAP-19s installed on Pioneer.

The modifications for Viking went further to ensure the RTG, which is shown in Fig. 13, could withstand high temperature sterilization procedures in support of the planetary quarantine protocol, storage during the flight to Mars, and the severe temperature extremes of the Martian surface.

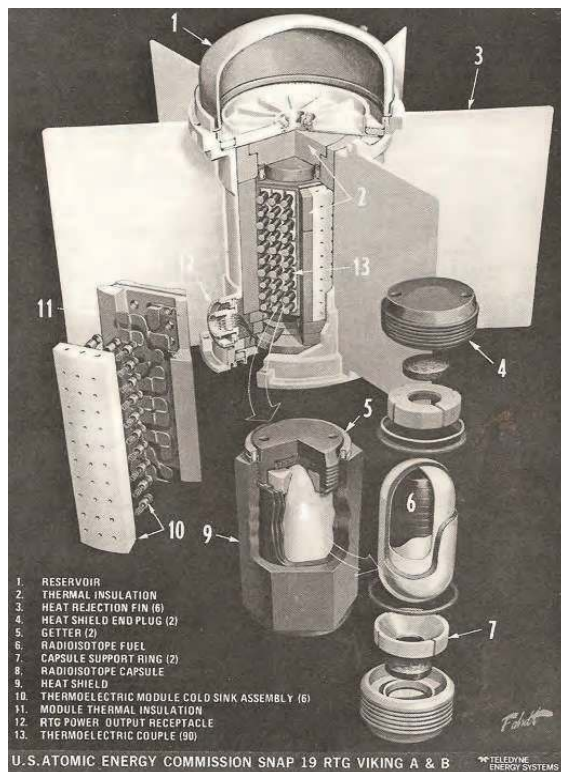

Fig. 13. Viking SNAP-19.

The landers were sterilized before launch to prevent contamination of Mars by terrestrial microorganisms. Among the modifications to the Pioneer SNAP-19 design was the addition of a dome reservoir to allow a controlled interchange of gases. This minimized heat source operating temperatures prior to launch, while maximizing electrical power output at the end of mission. This resulted in the Viking SNAP-19 being slightly larger and more massive than the version used on Pioneer (40.4 cm tall, 58.7 cm fin span, 15.2 kg mass, and 2.8 We/kg specific power).

Vikings 1 and 2 were identical spacecraft (Fig. 14), each of which consisted of a Lander, with a robot laboratory to study the nature of the surface, and an Orbiter, designed to serve as a communications relay to Earth. Each Lander carried two SNAP-19s. Viking 1 was launched on 20 August 1975 from Cape Canaveral. It reached Mars orbit on 19 June 1976, and reached the surface on 20 July 1976 on the western slope of Chryse Planitia. Viking 2 was launched on 9 September 1975, and it touched down on the surface on 3 September 1976 at Utopia Planitia.



Fig. 14. Viking Lander.

The Viking missions were a complete success. In addition to characterization of the Mars environment, the Landers provided over 4,500 high quality images of the Martian landscape. All four SNAP-19 RTGs easily met their original 90-day requirement, thus allowing the Viking Landers to operate for years until other system failures led to a loss of data. When the last data were received from Viking 1 in November 1982, it had been estimated that the RTGs were capable of providing sufficient power for operation until 1994, 18 years beyond the original mission requirement.

4.5 Transit-RTG (TRIAD)

Interest in RTGs for Navy navigation satellites continued after the earlier Transit missions. The next DOD application of RTGs took place with TRIAD, the first in a series of three experimental spacecraft designed to test and demonstrate improvements to the NNS. These were all developed under the Transit Improvement Program (TIP), which was established in 1969 to provide a radiation-hardened satellite that could maintain its correct position for over five days without an update from the ground.

The Transit-RTG was designed to serve as the primary power source for the satellite, with auxiliary power provided by four solar-cell panels and a 6 Amp-hr Nickel Cadmium battery. The 13.6-kg Transit RTG was modular in design, and was 36.3 cm tall and approximately 61 cm across its lower attachment (Fig. 15). The RTG delivered 35.6 We at BOM, and used a SNAP-19 heat source. The Transit RTG was the first to employ radiative heat coupling between its heat source and thermocouples, although this was accomplished at some loss in efficiency.

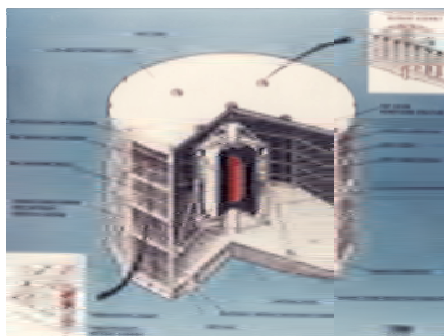

Fig. 15. Cutaway of TRANSIT RTG.

The 12-sided converter used Pb-Te thermoelectric “Isotec” panels operated at a low hot-side temperature of 673 K in a vacuum, thus eliminating the need for hermetic sealing and a cover gas to inhibit thermoelectric material sublimation. Each of the 12 Isotec panels contained 36 Pb-Te thermocouples arranged in a series-parallel matrix with four couples in a row in webbed, magnesium-thorium corner posts with Teflon insulators.

The TRIAD satellite (Fig. 16) was launched on September 2, 1972 from Vandenberg Air Force Base into a 700 to 800 km orbit. The short-term objectives of the TRIAD satellite were successfully demonstrated, including a checkout of RTG performance. However, a telemetry-converter failure onboard the spacecraft caused a loss of telemetry data about a month into the mission. This, in turn, precluded measuring the Transit-RTG power level versus time. However, the TRIAD satellite continued to operate normally for some time and provided magnetometer data using power from the RTG.



Fig. 16. Transit TRIAD Satellite.

4.6 SNAP-27

During the 1960's, scientists involved with the Apollo program envisioned placing scientific stations on the lunar surface that could transmit data long after the astronauts returned to Earth. They were interested in many measurements, including fluctuations in solar and terrestrial magnetic fields, changes in the low concentrations of gas in the lunar atmosphere, and internal structure and composition of the Moon. These ideas culminated in the Apollo Lunar Surface Experiment Package (ALSEP), led by Bendix Aerospace Systems Division. The requirement for multi-year operation and survival over many 14-day lunar day/night cycles favored use of RPS as the primary power source for ALSEP. Although NASA looked at using the new SNAP-19 for this application, ALSEP power requirements would have necessitated multiple SNAP-19s per mission and considerable effort in deployment by the Apollo crew. Instead, the AEC was requested to develop a new RTG, called the SNAP-27 (Fig. 17).

Special features were added to the SNAP-27 to ensure safety and facilitate its deployment by the astronauts on the lunar surface (Fig. 18). Chief of these was the separate storage of the heat source in a graphite lunar module fuel cask (GLFC) carried on the Lunar Excursion Module (LEM). The GLFC enclosed the fuel module during the trip to the Moon, and provided thermal and blast protection in the event of a launch pad explosion, launch abort, or reentry into the Earth's atmosphere and ground impact.

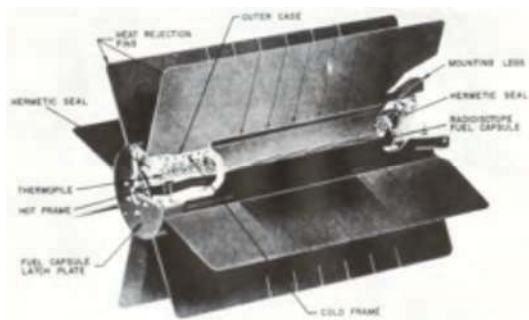

Fig. 17. SNAP-27.



Fig. 18. Use of SNAP-27 on the Moon. Alan Bean deploying SNAP-27 on Apollo 12.

Thermal energy from the fuel capsule was transferred to the generator hot frame by radiative coupling. When deployed on the lunar surface, the fuel capsule operated at 1005 K, while the Inconel 102 alloy hot frame was 880 K. The hot junction temperature ranged between 855 K and 865 K, reflecting an overall temperature drop of 15 to 25 K. On the Moon's surface, where temperatures can vary from 350 K during the lunar day to a frigid 100 K during the lunar night, the generator's cold side temperature operated at 545 K. Pb-Te served as the TE material and the couples were assembled in a series-parallel electrical arrangement to prevent string loss. The power capability for the 19.6 kg RTG was at least 63.5 We at 16 Vdc for one year after lunar emplacement. The converter was 46 cm tall and 40 cm wide across the fins. The specific power was greater than 3.2 We/kg, which represented a 10% increase over the Pioneer SNAP-19.

The five units deployed on the lunar surface from 1969 to 1972 operated flawlessly. Telemetry data from their operation stopped in 1977 when the ALSEPs were intentionally shutdown. Until then, their degradation in performance matched all predictions.

The only potential problem with SNAP-27 occurred with the Apollo-13 mission, when there was concern over the SNAP-27 onboard the LEM reentering the Earth's atmosphere. Normal reentry trajectory and velocity were achieved as had been assumed in the pre-launch review accounting for this type of event. The detached LEM broke up on reentry, as

anticipated, while the graphite-encased Pu-238 fuel cask survived the breakup and went down intact in the 20,000 foot deep Tonga Trench, as had been projected for an aborted mission in a lifeboat mode situation.

4.7 Multihundred Watt (MHW) RTG

In anticipation that NASA would require higher power RTGs for increasingly ambitious robotic science missions in the future, the AEC contracted with GE to conduct a technology readiness effort for an RTG with a power capability in the range of several hundred We. Development of this unit, which later became known as the MHW-RTG, was initiated in anticipation that NASA would conduct a Grand Tour mission of the planets. This was realized with the Voyager missions launched in 1977. At the same time, the DOD also had a requirement for a hundred watt-class RTG, and requested the AEC to develop such a unit for two communication satellite technology demonstrators built by MIT's Lincoln Laboratory. These Lincoln Experimental Satellites (LES) 8 and 9 were launched together in 1976.

The MHW-RTG represented a dramatic advancement in RTG technology with its use of Silicon-Germanium (Si-Ge) thermoelectric materials and a much higher temperature heat source. The higher hot-side temperature translated to greater power conversion efficiency, and, most importantly, enabled radiation of waste heat at higher temperatures. This allowed a substantial reduction in radiator size and a significant increase in specific power over its Pb-Te/TAGS predecessors. Thermocouples made of Si-Ge can operate over a broad temperature range, up to 1,000 C, much higher than telluride-based thermocouples. Plus with a Silicon Nitride coating, Si-Ge does not sublime significantly, and allows operation without a cover gas in the vacuum of space.

The MHW-RTG had a length of 58.3 cm and fin span of 39.7 cm (Fig. 19). The converter housing consisted of a beryllium outer shell and pressure domes, with unicouples attached directly to the outer shell. Like SNAP-19, the heat source was designed to immobilize and contain the fuel in the event of a launch abort. It was shaped as a right circular cylinder, and contained twenty-four 3.7-cm diameter fuel containers of PuO₂ (Fig. 20). Each fuel container produced 100 Wt, and had a metallic iridium shell containing the PuO₂ fuel and a graphite impact shell, which provided the primary resistance to mechanical impact loads.



Fig. 19. MHW-RTG. Cutaway view on left. Installation in test fixture on right.

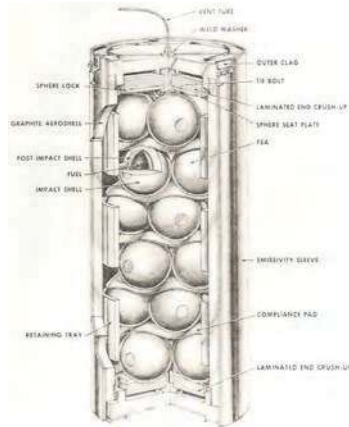

Fig. 20. MWH-RTG heat source.

The power converter contained 312 Si-Ge unicouples arranged in 24 circumferential rows with each row containing 13 couples. The MHW-RTGs flown on LES 8 and 9 had an average mass of 39.7 kg, BOM power of 154 We, and specific power of 3.9 We/kg. The six RTGs for Voyager were modified to yield a higher specific power of 4.2 We/kg, based on an average mass of 37.7 kg and BOM power of 158 We.

LES 8 and 9 were launched together aboard a Titan IIIC launch vehicle on 15 March 1976, and were deployed to a geosynchronous orbit altitude of approximately 36,000 km (Fig. 21). Each LES used two MHW generators (Fig. 19), which provided primary power for all spacecraft systems. The MHW-RTGs more than met the mission goals for lifetime. They also enabled the demonstration of improved methods for maintaining voice or digital data circuits among widely separated mobile communications terminals. Although its RTGs were still providing usable electric power, LES-8 was turned off on 2 June 2004 due to control difficulties. LES-9, however, continues to operate over 30 years after launch.



Fig. 21. LES-8 and 9 in orbit.

The Voyager 2 spacecraft launched on 20 August 1977 aboard a Titan-Centaur launch vehicle (Fig. 22). Each Voyager probe carried three MHW generators. Voyager 1 followed on 5 September 5, also aboard a Titan-Centaur rocket.

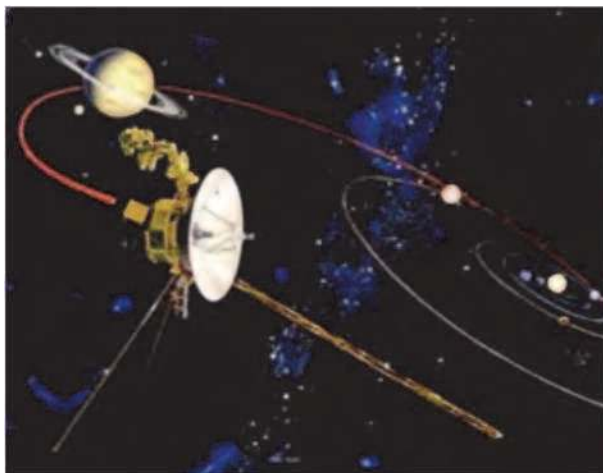

Fig. 22. Voyager spacecraft.

The Voyager spacecraft explored the most territory of any mission in history, including all the giant planets of the outer solar system, 48 of their moons, and the unique system of rings and magnetic fields those planets possess. The final planetary encounter was conducted by Voyager 2, which had its closest approach with Neptune on 25 August 1989. Although Pioneers 10 and 11 were the first spacecraft to fly beyond all the planets, Voyager 1 passed Pioneer 10 to become the most distant human-made object in space. As of 11 August 2007, the power generated by the spacecraft had dropped to about 60% of the power at launch. This is better than the pre-launch predictions based on a conservative thermocouple degradation model. As the electrical power decreases, spacecraft loads must be turned off, eliminating some spacecraft capabilities.

4.8 General Purpose Heat Source (GPHS) RTG

Following the successful launches of the Voyager spacecraft, DOE turned its focus on developing a new selenide-based RTG for NASA's planned International Solar Polar Mission (ISPM) and the Jupiter Orbiter Probe, which later became the Ulysses and Galileo missions, respectively. Nuclear power was required for these missions, since they would both operate in the vicinity of Jupiter with its low solar energy flux, cold temperatures and intense radiation environment. Both missions were to be launched in the mid-1980s aboard the then under development U.S. Space Shuttle.

Upon determining that selenide thermoelectrics would not be suitable for long-duration missions, DOE went back to Si-Ge technology and considered modifying flight spares of the MHW-RTG for use on Galileo. However, the joint NASA-ESA ISPM team requested a new, larger, more powerful RTG for their spacecraft. When the Galileo project saw the benefits of the planned ISPM RTG they requested two for the Galileo spacecraft. As a result the ISPM RTG was renamed the GPHS-RTG.

The GPHS-RTG used the same Si-Ge alloy unicouples used in the MHW-RTG. Because production of the unicouples had been stopped after the Voyager program there was a need to restart production. However, the rest of the design was very different. For one, the converter housing was made of a less expensive and more manufacturable Aluminum 2219-T6 alloy, instead of the beryllium used in the MHW-RTG. Another big difference was the heat source, which employed an assembly of newly developed General Purpose Heat Source (GPHS) modules. This modular approach to heat source design opened the door for developing RTGs of different sizes and powers in the future, but it required an extensive development and qualification program to replace the fuel sphere assemblies used in the MHW-RTG. Finally, DOE had decided to move the RTG assembly and testing work from its RTG contractors to DOE's Mound Laboratory, which necessitated a rapid buildup of the infrastructure at a new location.

The GPHS-RTG, shown in Fig. 2, was composed of two main elements: a linear stack of 18 GPHS modules and the converter. The converter surrounds the heat source stack, and consists of 572 radiatively-coupled Si-Ge unicouples, which operate at a hot side temperature of 1,275 K and a cold side/heat rejection temperature of 575 K. The outer case of the RTG provides the main support for the converter and heat source assembly, which is axially preloaded to withstand the mechanical stress environments of launch and to avoid separation of GPHS modules. The converter also provides axial and mid-span heat source supports, a multifoil insulation packet and a gas management system. The latter provides an inert gas environment for partial power operation on the launch pad, and also protects the multifoil and refractory materials during storage and ground operations.

The complete GPHS-RTG has an overall length of 114 cm and a fin span of 42.2 cm. Its mass of 55.9 kg and BOM power level of up to 300 We provides a specific power of 5.1 to 5.3 We/kg, far greater than any of its predecessors.

The Galileo spacecraft (Fig. 23) was launched on 18 October 1989 on the Space Shuttle, after a 3.5-year delay caused by the Challenger accident. Forced to take a long, circuitous trajectory involving Earth and Venus gravity assists, Galileo arrived at Jupiter in December 1995. The Orbiter spacecraft investigated the Jupiter and its Galilean satellites from space, while the Galileo Probe, which was battery-powered but kept warm via a number of small radioisotope heater units, entered Jupiter's atmosphere on 7 December 1995. Both GPHS-RTGs met their end of mission (EOM) power requirements, thus allowing NASA to extend the Galileo mission three times. However on 21 September 2003, after eight years of service in orbit about Jupiter, the mission was terminated by intentionally forcing the orbiter to burn up in Jupiter's atmosphere. This was done to avoid any chance of contaminating local moons, especially Europa, with micro-organisms from Earth.

The Ulysses (Fig. 24) was launched nearly a year later by the Space Shuttle on 6 October 1990. The mission included a Jupiter gravity assist performed on 8 February 1992 in order to place the spacecraft in a trajectory over the polar regions of the Sun. The single GPHS-RTG performed flawlessly and exceeded its design requirement. As a result, the Ulysses mission was extended beyond its original planned lifetime goal, thus allowing it to take measurements over the Sun's poles for the third time in 2007 and 2008. However after it became clear that the power output from the RTG would be insufficient to operate science

instruments and keep onboard hydrazine propellant from freezing, the decision was made to end the mission on 1 July 2008.

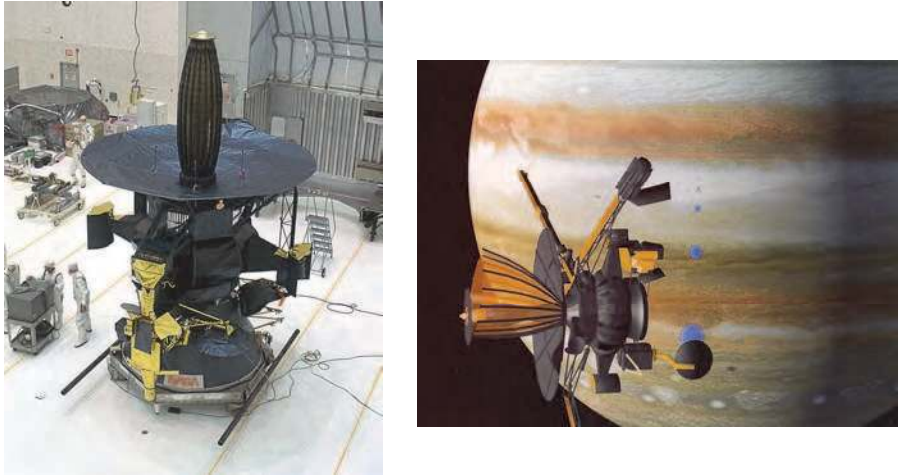

Fig. 23. Galileo spacecraft. Pre-launch assembly on left. Artist concept of spacecraft in orbit around Jupiter on right.

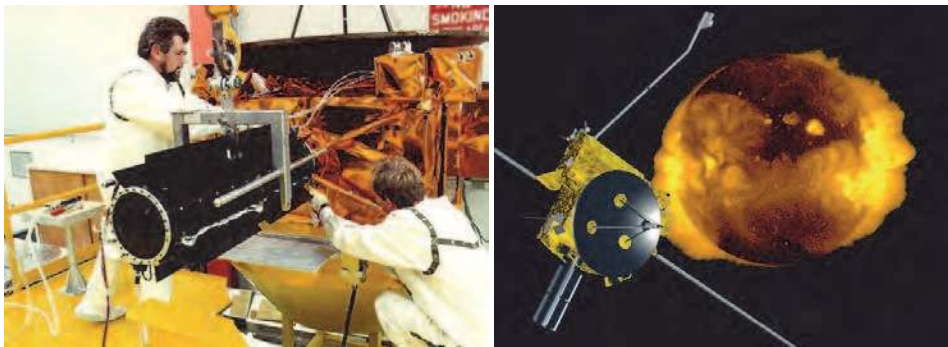

Fig. 24. Ulysses spacecraft. Installation and checkout of RTG on left. Artist concept of vehicle on right.

The third mission to use the GPHS-RTG was Cassini (Fig. 25), which was launched, along with the ESA-built Huygens Titan Probe, on 15 October 1997 aboard a Titan IV/Centaur launch vehicle. Cassini achieved Saturn orbit insertion on 1 July 2004 after a 6.7-year transit involving gravity assists about Venus and Earth. The Huygens probe, which carried the same radioisotope heater units as Galileo, successfully landed on Titan and provided the first close-up views of that enigmatic world. Because of mission complexity, Cassini needed more power than used on previous flagship-class missions. The three GPHS-RTGs that were used have so far operated flawlessly and have exceeded their expected power output. The mission has now been approved for an extension to 2017.



Fig. 25. Cassini spacecraft. Pre-launch checkout of RTG on left. Artist concept of vehicle on right.

The most recent mission to use a GPHS-RTG is the New Horizons mission to Pluto (Fig. 26), which was launched on 19 January 2006 aboard an Atlas V 551. The spacecraft is currently on a 9.5-year transit to Pluto and Charon. At encounter, which is expected in July 2015, New Horizons will characterize and map the surfaces of Pluto and Charon and their atmospheres. From 2016 to 2020, the spacecraft will continue to conduct encounters with one or two Kuiper Belt Objects. So far, it is anticipated that the RTG will exceed its power and lifetime requirements.

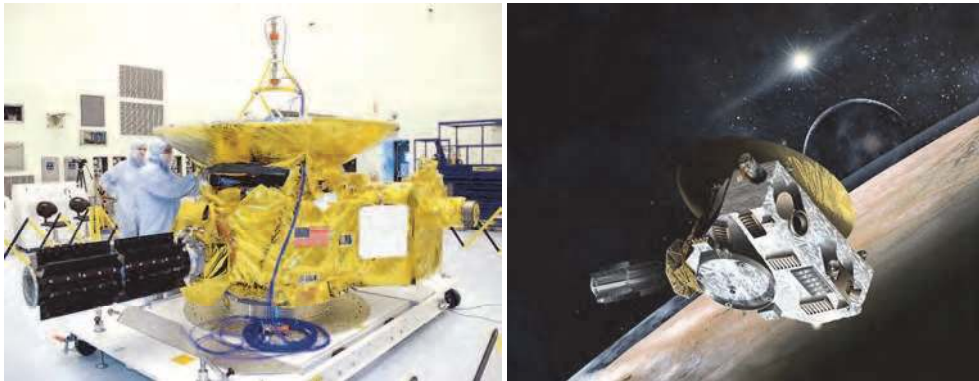

Fig. 26. New Horizons spacecraft. Pre-launch integration with spacecraft on left. Artist concept of New Horizons flyby of Pluto and Charon on right.

4.9 Multi-mission RTG (MMRTG)

Although the GPHS-RTG served well on Ulysses and Galileo and continues to meet requirements for Cassini and New Horizons, it is not suitable for future missions on Mars and other planetary bodies with atmospheres. The GPHS-RTG was only designed to function effectively in a vacuum environment. Furthermore, its relatively large size and power level limit its modularity and ease of integration on future small to mid-size spacecraft.

DOE and NASA are currently developing a new generation of RPS generators that could be used for a variety of space missions. One is the Multi-Mission RTG (MMRTG), which has

MSL is considerably larger than the Mars Exploration Rovers that landed on the planet in 2004. It will carry more advanced scientific instruments than any other Mars mission to date, including analysis of samples scooped up from the soil and drilled powders from rocks. It will also investigate the past and present ability of Mars to support life. The MSL rover will use power from an MMRTG to supply heat and electricity for its components and science instruments. A coolant loop and heat exchanger coupled with the MMRTG radiators will transport waste heat to the electronics, thus extending operation of the rover into the Martian night and winter season. The goal is to operate for at least one Martian year (i.e., two Earth years) over a wide range of possible landing sites.

The MMRTG could be used on a number of other potential missions in the future. One exciting prospect is to use the MMRTG as the principal electrical power and heat source for a Titan aerobot/balloon mission (Fig. 29). In this scenario, the considerable waste heat produced by the MMRTG would be used to heat a gas and generate buoyancy for a balloon carrying a long-lived payload, in addition to providing electrical power to onboard instruments.



Fig. 29. Titan Aerobot.

4.10 Advanced Stirling Radioisotope Generator (ASRG)

When the potential of radioisotope power became apparent in the 1950s, the original focus was on development of dynamic power conversion systems. Most of these activities concentrated on applying the high efficiencies achievable with Brayton and Rankine cycles, in expectation that systems would evolve to larger power levels in the future.

Although thermoelectric technology supplanted this approach and became the dominant power conversion option for every RPS flown in space, work on Dynamic Isotope Power Systems (DIPS) continued at various times throughout the intervening decades. The principal focus of these efforts was on eventual development of power systems capable of producing up to tens of kilowatts of power. These higher power technologies would be used in conjunction with the ambitious crewed missions anticipated in the future. The studies of DIPS pointed to its excellent suitability for lunar and planetary surface

exploration, particularly surface rovers, remote science stations and backup power supplies to central base power.

Interest in DIPS was particularly high during the Space Exploration Initiative (SEI) of the early-1990s. However with the demise of that effort in 1992, the focus shifted to determine how dynamic power conversion could benefit radioisotope power systems in the multi-hundred watt range. During the 1990s, several advanced dynamic and static conversion technologies were researched and evaluated. Several technologies that had appeared promising initially proved to be ill-suited for the unique demands of deep space missions. In the end, it became apparent that the free-piston Stirling engine offered the best hope of advancing the efficiency of future generators, while offering lifetimes up to a decade or two. Unlike previous DIPS designs, which featured turbomachinery-based conversion technologies (e.g. Brayton), small Stirling DIPS could be advantageously scaled down to multihundred-watt unit size while preserving size and mass competitiveness with RTGs.

In 2002, NASA and DOE began a Stirling Radioisotope Generator (SRG) project focused on evaluating and demonstrating a unit for flight development. The work was initiated to provide a back-up RPS for the MSL mission. The unit used Stirling convertors built and tested under a technology development effort funded by DOE. Although the SRG could achieve a four-fold reduction in fuel requirements for the same power, the final system specific power of the unit was only slightly better than the MMRTG.

In less than two years, it became apparent that the MMRTG would be selected by NASA's Mars program, so that the rover could make use of the significant waste heat produced by that unit. Finally, a small business technology project initiated in the early 2000s with Sunpower Technologies in Athens, Ohio, indicated that convertors with much better mass performance could be developed and substituted into an SRG-based design. Such a unit could potentially achieve specific powers of about 7 We/kg. With the advancement in Stirling generator heater head materials and with improved temperature margin and higher temperature operation, units with specific powers greater than 8 We/kg may be possible..

In 2005, the decision was made to redirect efforts toward development of an Advanced SRG (ASRG) technology demonstration Engineering Unit (EU). The effort drew upon the work that had gone on previously with the controller, housing and insulation systems for the SRG, but incorporated use of the higher specific power Sunpower generators. In addition to high specific power, the ASRG would likely achieve an efficiency over 30%. This is four to five times higher than that from a GPHS-RTG, and is particularly important for conserving the very limited worldwide supply of Pu-238 fuel.

The ASRG, which is shown in Fig. 30, is being developed under the joint sponsorship of the U.S. Department of Energy (DOE) And NASA. The eventual flight units are expected to produce over 130 We in a space environment and to have a mass of 32 kg or less. The prime contractor is Lockheed-Martin Corporation of Valley Forge, PA, with Sunpower, Inc. of Athens, Ohio as the main subcontractor. NASA Glenn Research Center (GRC) is supporting the technology development, along with evaluation and testing of the Stirling convertors used in the device. In addition to improving fuel utilization efficiency over previous RPS, the ASRG is being designed for multi-mission use in deep space, and within the atmosphere of Mars and possibly Titan.

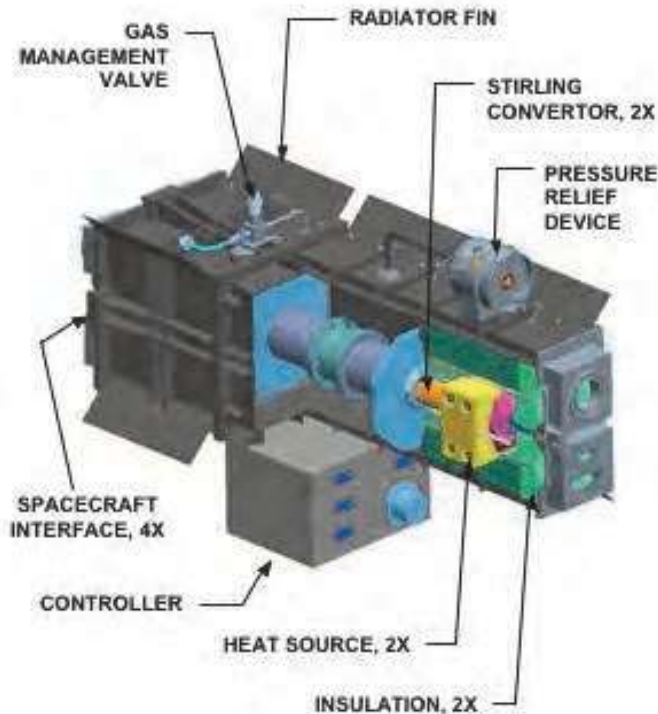

Fig. 30. Advanced Stirling Radioisotope Generator (ASRG).

Activities are focused on developing and testing the ASRG-EU in thermal and vibrational environments that closely approximate qualification-level tests (Fig. 31).

The ASRG-EU uses two axially-opposed Advanced Stirling Convertors (ASCs), operating at a hot-end temperature of 650 deg C, producing about 140 We. Sunpower is developing the ASC under a 2002 NASA Research Announcement (NRA) with GRC. The low mass of the ASC is key to the ASRG's high overall system specific power.

The ASRG has achieved a TRL 6 (system demonstration in a relevant environment) with operation at qualification level thermal and dynamic environments. Tests on the ASRG-EU were completed in June 2008 at the Lockheed-Martin Space System Company in King of Prussia, PA. These evaluations included thermal balance, thermal performance, mechanical disturbance, sine transient, random vibration, simulated pyrotechnic shock and electromagnetic interference and magnetic field emission tests. Over 1,000 hours of successful EU operating time with numerous startup and shutdown cycles were accumulated during the testing at Lockheed-Martin. The ASRG-EU is now undergoing extended/multi-year duration testing at NASA GRC. It has achieved over 11,000 hours of successful operation as of April 2011, and is expected to exceed 14,000 hours of operation by the end of 2011.

Ongoing ASRG-EU tests use electrical resistance heaters that simulate the heating characteristics of the actual GPHS module. Avoiding use of nuclear materials during early phases of development greatly facilitates testing and evaluation of the ASRG subsystems.



Fig. 31. ASRG Engineering Unit.

5. Other potential applications

MMRTG and ASRG should satisfy most RPS mission requirements well beyond 2010, particularly for those applications involving several hundred watts of power. However, there will likely be a demand for additional types of units in the future. One potential need identified by the space science community is for small RPS units ranging in power from ~10 milliwatts (mW_e) to ~20 W_e . These so-called 'milliwatt' and 'multiwatt-class' power supplies could extend the capability of small, low cost missions supported through NASA's small to mid-size programs, and augment human missions involving deployment of monitoring stations and autonomous devices. They would likely utilize the GPHS or other existing heat sources. Although flight-qualified systems in this size range do not presently exist, the promise of RPS has led NASA and DOE to evaluate the possible development of a small RPS unit in the future.

Nuclear Electric Propulsion (NEP) has been studied since the early 1960's because of its potential for future high-energy space missions. Almost all NEP assessments to date have assumed fission as the nuclear energy source. Unlike solar-powered electric propulsion (SEP) systems, NEP operation is generally independent of distance and orientation with respect to the Sun. Over the last decade, several studies have pointed to Radioisotope Power Systems (RPS), instead of reactor power sources, as the best way of implementing NEP. Radioisotope-based NEP, also known as Radioisotope Electric Propulsion (REP), has been evaluated before, but has not been seriously considered for flight due to the low specific power range of traditional RPS (e.g., 3 to 5 We/kg). However, the prospects for REP have improved substantially with the advent of the ASRG and its likely improvement in specific power.

In this capacity, REP would principally be used as an interplanetary stage for long-duration deceleration and acceleration in deep space. At remote destinations, REP would perform deceleration, orbit insertion and maneuvers around outer planets and other planetary bodies. REP-based spacecraft could also provide ample power at destination for sophisticated science instruments and communications, but it would fit better within the relatively modest kilowatt-scale power requirements of the space science community.

6. Conclusion

Radioisotope power systems will continue to play an important role in NASA's exploration efforts. These systems also have the potential for use in a variety of new applications, which would benefit from the technology's versatility in a broad range of space and planetary environments. In the near-term, the MMRTG will expand the capability for conducting science on the surface of Mars. The ASRG will enable even higher performance missions. These units will also enable more ambitious exploration of other planetary surfaces and provide a reliable means of powering spacecraft in deep space. Current activities would also allow the potential development of new systems that could expand application of RPS to smaller science missions. The key to successful implementation of RPS is to maintain close ties with potential users and the science community at large. With these advancements, radioisotope power systems and technology will offer tremendous benefits for future exploration endeavors.

7. References

- Angelo, J.A. and Buden, D., *Space Nuclear Power*, Orbit Book Co., Malabar, FL, 1985, pp. 133-157.
- Bennett, G.L., "Space Nuclear Power: Opening the Final Frontier," AIAA-2006-4191, 4th International Energy Conversion Engineering Conference, June 2006.
- Bennett, G.L., and Skrabek, E.A., "Power Performance of U.S. Space Radioisotope Thermoelectric Generators," in proceedings of *15th International Conference on Thermoelectrics*, June 1996, pp. 357-372.
- Chan, J., Hill, D., Hoyer, T., and Leland, D., "Development of Advanced Stirling Radioisotope Generator for Planetary Surface and Deep Space Missions," AIAA-2009-5768, 6th International Energy Conversion Engineering Conference, July 28-30, 2009.

- Engler, R.E., "Atomic Power in Space – A History," U.S. Department of Energy Report DE-AC01-NE32117, March 1987.
- Furlong, R.R. and Wahlquist, E.J., "U.S. Space Missions Using Radioisotope Power Systems," *Nuclear News*, April 1999, pp. 26-34.
- Hammel, T.E., and Osmeyer, W.E., "The Selendie Isotope Generators," AIAA-1997-498, Conference on the Future of Aerospace Power Systems, March 1977.
- Hammel, T.E., Bennett, R., Otting, W., and Fanale, S., "Multi-Mission Radioisotope Thermoelectric Generator (MMRTG) and Performance Prediction Model," AIAA-2009-4576, 7th International Energy Conversion Engineering Conference, August 2-5, 2009.
- Lange, R.G. and Mastal, E.F., "A Tutorial Review of Radioisotope Power Systems," in *A Critical Review of Space Nuclear Power and Propulsion*, edited by M.S. El-Genk, American Institute of Physics, Melville, New York, 1994, pp. 1-20.
- National Research Council, *New Frontiers in the Solar System – An Integrated Exploration Strategy*, National Academies Press, Washington, DC, 2003a.
- National Research Council, *The Sun to the Earth – and Beyond: Panel Reports*, National Academies Press, Washington, DC, 2003b.
- Schmidt, G., Wiley, R., Richardson, R. and Furlong, R., "NASA's Program for Radioisotope Power System Research and Development," in proceedings of *Space Technology and Applications International Forum (STAIF-2005)*, edited by M.S. El-Genk, American Institute of Physics, Melville, New York, 2005.
- Schmidt, G., Abelson, R., and Wiley, R., "Benefit of Small Radioisotope Power Systems for NASA Exploration Missions," in proceedings of *Space Technology and Applications International Forum (STAIF-2005)*, edited by M.S. El-Genk, American Institute of Physics, Melville, New York, 2005.
- Surampudi, R., Carpenter, R., El-Genk, M., Herrera, L., Mason, L., Mondt, J., Nesmith, B., Rapp, D. and Wiley, R., *Advanced Radioisotope Power Systems Report*, Jet Propulsion Laboratory, Pasadena, CA, March 2001.
- Wiley, R. and Carpenter, R., "Small Radioisotope Power Source Concepts," in proceedings of *Space Technology and Applications International Forum (STAIF-2004)*, edited by M.S. El-Genk, American Institute of Physics, Melville, New York, 2004.
- U.S. Department of Energy, *Atomic Power in Space*, Prepared by Planning & Human Systems, Inc. under Contract DE-AC01-NE32117, 2nd ed., Springer-Verlag, New York, 1983, Chaps. 7, 14.

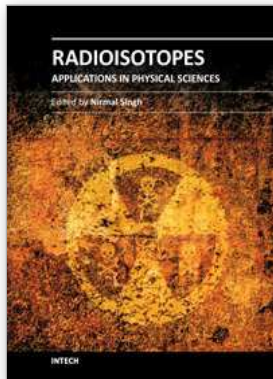

Radioisotopes - Applications in Physical Sciences

Edited by Prof. Nirmal Singh

ISBN 978-953-307-510-5

Hard cover, 496 pages

Publisher InTech

Published online 19, October, 2011

Published in print edition October, 2011

The book Radioisotopes - Applications in Physical Sciences is divided into three sections namely: Radioisotopes and Some Physical Aspects, Radioisotopes in Environment and Radioisotopes in Power System Space Applications. Section I contains nine chapters on radioisotopes and production and their various applications in some physical and chemical processes. In Section II, ten chapters on the applications of radioisotopes in environment have been added. The interesting articles related to soil, water, environmental dosimetry/tracer and composition analyzer etc. are worth reading. Section III has three chapters on the use of radioisotopes in power systems which generate electrical power by converting heat released from the nuclear decay of radioactive isotopes. The system has to be flown in space for space exploration and radioisotopes can be a good alternative for heat-to-electrical energy conversion. The reader will very much benefit from the chapters presented in this section.

How to reference

In order to correctly reference this scholarly work, feel free to copy and paste the following:

George R. Schmidt, Thomas J. Sutliff and Leonard A. Dudzinski (2011). Radioisotope Power: A Key Technology for Deep Space Exploration, Radioisotopes - Applications in Physical Sciences, Prof. Nirmal Singh (Ed.), ISBN: 978-953-307-510-5, InTech, Available from: <http://www.intechopen.com/books/radioisotopes-applications-in-physical-sciences/radioisotope-power-a-key-technology-for-deep-space-exploration>

INTECH

open science | open minds

InTech Europe

University Campus STeP Ri
Slavka Krautzeka 83/A
51000 Rijeka, Croatia
Phone: +385 (51) 770 447
Fax: +385 (51) 686 166
www.intechopen.com

InTech China

Unit 405, Office Block, Hotel Equatorial Shanghai
No.65, Yan An Road (West), Shanghai, 200040, China
中国上海市延安西路65号上海国际贵都大饭店办公楼405单元
Phone: +86-21-62489820
Fax: +86-21-62489821

© 2011 The Author(s). Licensee IntechOpen. This is an open access article distributed under the terms of the [Creative Commons Attribution 3.0 License](#), which permits unrestricted use, distribution, and reproduction in any medium, provided the original work is properly cited.