

Real-time Implementation of a Class of Optimised Multirate Quadrature Mirror Filter Bank Using Genetic Algorithms

Gurvinder Singh Baicher

(University of Wales Newport, City Campus, Usk Way
Newport, Gwent, NP20 2BP, South Wales, UK
g.singh-baicher@newport.ac.uk)

Abstract: This paper considers theoretical issues concerning reconstruction errors and conditions for perfect reconstruction (PR) of the input signal for a 2-channel multirate quadrature mirror filter (QMF) bank. The main emphasis is on the optimisation of a new design of a perfect reconstruction QMF bank using infinite impulse response (IIR) filters based on transformation of variables technique. The genetic algorithm (GA) optimisation is used for the initial design of the QMF bank and for the IIR filters using finite word length coefficients. The optimised results are then applied to a real time digital signal processing kit. Finally, some test results for data compression achievable using different values of encoded bits are included.

Keywords: Optimization, quadrature mirror filter bank, genetic algorithms, IIR filters, multirate filter bank, real-time implementation, pulse code modulation, polyphase decomposition

Categories: J.2, I.6.3, I.6.6

1 Introduction

Multirate processing of digital signals is involved with variable rate sampling at different stages of a system often resulting in efficient processing of signals. The main areas of application of multirate signal processing include digital audio systems, speech and image processing, transmultiplexers, sub-band coding and signal data compression. Multirate filter banks are of a specific structure with applications in spectrum analysis and sub-band coding of speech and image signals [Vaidyanathan, 90]. An example of a specific form of a two-channel multirate structure shown in Figure 1 is commonly referred to as a quadrature mirror filter (QMF) bank. This is so called due to the power complementary frequency response of the low pass and high pass filters used.

A requirement for perfect reconstruction (PR) of the input signal through a 2-channel filter bank as shown in Figure 1 is the cancellation of amplitude, phase and aliasing distortions of the output signal. Theoretical methods of achieving PR are well established [Vaidyanathan, 93]. However, obtaining good sub-band filters of high order and minimising reconstruction errors are key elements for the specified design and implementation of real systems. For real-time implementation, it becomes important to use efficient sub-band filters of high order and also minimising reconstruction errors for the specified design and implementation. Generally, methods for designing a QMF bank are based on using finite impulse response (FIR)

analysis filters (at transmitting end) and synthesis filters (at the receiving end) [Ramakrishna, 06]. Due to the implicit linear phase characteristic of FIR filters, then the phase distortion is easily eliminated and with appropriate choice of the synthesis filters, aliasing error is also eliminated. Finally, some form of optimisation technique is used to eliminate the amplitude distortion that then leads to a near-perfect reconstruction of the input signal. The major problem for using FIR filters in real-time applications is their larger computational overhead due to a large number of coefficients required for a given filter frequency response specification. Such a specification is achievable with far fewer coefficients using IIR filters although stability checks are required and in general, non-linear phase response of IIR filters can cause undesirable effects for specific applications such as image processing.

The real-time applications of multirate banks, such as sub-band coding of telephony speech signals and data compression, is based on using finite word length form of the input signal, digital filter coefficients and arithmetic operations on fixed-point digital signal processing devices. The work previously developed and reported in [Baicher, 10], [Baicher, 00], [Baicher, 99] is extended to the case of real-time realisation of multirate filter banks that is considered in this paper.

Often in digital signal processing applications, there is a need for splitting a band limited signal into an upper and a lower band of frequencies at the transmitting end and then recombining these at the receiving end. Such a split of frequency bands can be usefully used for improving the coding efficiency of the transmitted signal, thereby improving the available bandwidth. The problem, however, is to be able to reconstruct the received signal as close as possible to the original input signal. Where this can be achieved exactly then we say that the filter bank has a 'perfect reconstruction' (PR) property. In practice, there are several approximations used, such as; the filters are not ideal so approximations of their coefficients due to finite word length (FWL) affects must be optimised, there may be signal quantisation that may affect the overall performance of the system and in the case of filter banks, design aspects may lead to further optimisation requirements. In this respect, a simple genetic algorithm has been used to optimise the overall performance of the filter bank.

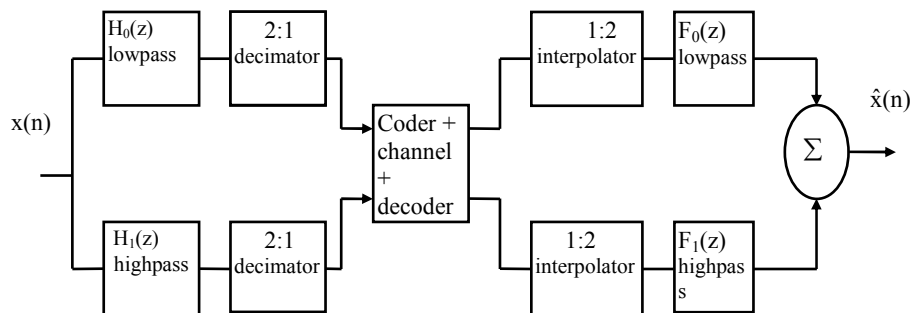

Figure 1: A two channel quadrature mirror filter bank

Most types of IIR filter banks proposed in literature either generate non-causal filters or they do not achieve perfect reconstruction [Vaidyanathan, 93], [Vetterli, 95]. A broad class of IIR QMF banks have been extensively studied that result in efficient all-pass based realisations [Lollmann, 08], [Lollman et al, 09]. Phase distortion in these forms of structures is a problem fundamentally due to the intrinsic non-linear phase response of IIR filters. All-pass equalisation is therefore required in such structures to overcome the phase distortion. For real-time applications the equalisation process can be complex and not efficient.

Other methods reported in literature include mixed mode FIR/IIR implementation. The H_∞ optimisation method pre-specifies the analysis filter (FIR or IIR) for efficient coding of the transmitted signal and the IIR synthesis filter bank is designed based on H_∞ optimisation [Chen, 95]. A minimax design approach of IIR QMF banks has been also reported [Lee, 01]. In this work, the frequency response is optimised in the L_∞ minimax sense; however, the design of an IIR low pass prototype filter is based on heuristic initial assumption of coefficient values that cannot always assure optimal minimisation of the error function.

A distinct class of IIR QMF bank design is based on the application of transformations. This form of strategy uses the McClellan transformation that was originally developed for transforming zero-phase 1-D FIR filter to 2-D FIR filter [McClellan, 73]. An equivalent form of generalised transformation of McClellan has been used for designing causal IIR analysis and synthesis filters and is shown to be flexible in being able to use a large class of transformation functions [Tay, 96].

The multirate filter bank investigated in this paper is based on a method of designing a 2-channel perfect reconstruction IIR filter bank using the transformation of variables technique. This technique was originally developed for designing multidimensional FIR filter banks [Tay, 93] but was later extended to the case of IIR filter banks [Tay, 96], [Tay, 98]. The 'transformation of variables' technique involves the use of small prototype filters and transformation of their variables by applying a transformation function. The transformation function uses a number of parameters that must be determined and optimised for appropriate frequency response of sub-band filter transfer functions. Although such a design method is simple and flexible, some heuristic assessment, based on trial-and-error procedure for the variables is used in order to obtain desirable results. Even so, there is no assurance that a near-optimal result has been obtained. It is this feature that inspired the use of genetic algorithms for locating quasi-optimal values, both in the design stage of the 2-channel filter bank and further optimisation using finite word length constraints for real time implementation. The major attraction for using the 'transformation of variables' technique is the design of causal stable IIR filters generating good frequency band separation and satisfying the perfect reconstruction condition. Furthermore, this technique is flexible in being able to use a large class of transformation functions thus leading to a number of options for the design implementation in real time.

2 Design of QMF bank using transformation of variables method

The design method considered here is the transformation of variables technique proposed by Tay [98]. This technique generates IIR filters with good frequency band separation that are casual and stable and can achieve perfect reconstruction. The basis of this method of design lies in the use of a set of small prototype filters and the transformation of their variables using a transformation function. A large range of transformation functions can be used each of which consist of a set of parameters that can be optimised to give the desired filter characteristics. This affords flexibility to the designer for 'fine-tuning' the characteristics and the final outcome, with relative ease.

The low pass filters $H_0(z)$ and $F_0(z)$ (see Figure 1) are derived from prototype filters $H_T(Z)$ and $F_T(Z)$ respectively that are both functions of a polynomial in Z . The transformation applied is given by $Z=M(z)$ that satisfies the condition $M(z) = -M(-z)$.

The low pass filters are thus given by

$$H_0(z) = H_T(M(z)) \quad \text{and} \quad F_0(z) = F_T(M(z)) \quad 1$$

and the high pass filters are given by

$$H_1(z) = z^{-K}F_0(-z) \quad \text{and} \quad F_1(z) = z^KH_0(-z) \quad 2$$

where K is an odd integer.

The design of the prototype filters is subject to the constraint that

$$H_T(Z) F_T(Z) + H_T(-Z) F_T(-Z) = 2 \quad 3$$

The condition of eqn. 2 reduces the input/output relationship of the QMF bank to an alias-free form, thus

$$\hat{X}(z) = \frac{1}{2}X(z)[F_0(z)H_0(z) + F_1(z)H_1(z)] \quad 4$$

Using eqns. 1, 2 and 3 the eqn. 4 reduces to $\hat{X}(z) = X(z)$ i.e. perfect reconstruction.

A number of prototype filters have been considered by Tay and Kingsbury [93] and their properties analysed. The most promising for sub-band filter banks is the pair obtained for the modified Lagrange half band filter given by

$$\left. \begin{aligned} H_T(Z) &= -\frac{1}{4}(Z+1)(Z-3) \\ F_T(Z) &= -\frac{1}{12}[(Z+1)(Z^2+Z-8)] \end{aligned} \right\} \quad 5$$

Furthermore, only rational transformations are considered in this work that generate IIR filters. The design of the prototype filters is based on the value of $Z=M(e^{j\omega})$ moving on a complex contour 'C' given by

$$C = \{ Z: Z = M(e^{j\omega}); -\pi \leq \omega \leq \pi \} \quad 6$$

The contour that gives most flexibility and thus offers a range of possible design options is an elliptical contour given by

$$C_e(b) = \{ Z: Z = \cos(\theta) + j b \sin(\theta); -\pi \leq \theta \leq \pi \} \quad 7$$

where $0 \leq b \leq 1$

A set of contours can be generated that lie between the two extreme cases by changing the value of 'b'. These contours can be approximated by a transformation function for Z , of the form

$$Z = M(z) = kz^p \prod_{i=1}^{Pr} \frac{c_i z^2 + 1}{z^2 + d_i} \prod_{i=1}^{Pc} \frac{z^4 r_i^2 - 2r_i \cos \varphi_i z^2 + 1}{z^4 - 2p_i \cos \psi_i z^2 + p_i^2} \quad 8$$

where $P = 2P_r + 4P_c - 1$ and

$$k = \prod_{i=1}^{P_r} \frac{1 + d_i}{1 + c_i} \prod_{i=1}^{P_c} \frac{p_i^2 - 2p_i \cos \psi_i + 1}{r_i^2 - 2r_i \cos \phi_i + 1} \tag{9}$$

the normalisation factor k assures that $Z = 1$ when θ is zero.

As mentioned above, the sub-band filters obtained by using this method are casual and stable (see Tay [98] for proof). There are several parameters to be designed for the higher order transformations and a trial and error method is not practical, hence some form of optimisation method is more suitable. The objective function to be minimised is a function of the parameters $\mathbf{c}, \mathbf{d}, \mathbf{r}, \boldsymbol{\phi}, \mathbf{p}, \boldsymbol{\psi}$ of the transformation function $M(z)$ and is given by

$$\text{Obj_fn} = \sum_{m=1}^L |M(e^{j\omega_m}) - M_i(\omega_m)|^2 W(\omega_m) \tag{10}$$

note that $\mathbf{c}, \mathbf{d}, \mathbf{r}, \boldsymbol{\phi}, \mathbf{p}, \boldsymbol{\psi}$ are the design parameter vectors e.g. $\mathbf{c} = [c_1, \dots, c_{P_r}]$. Also, $M(e^{j\omega_m})$ is the frequency response of $M(z)$ at ω_m and $M_i(\omega_m)$ is the desired frequency response of $M(z)$ at ω_m . $M_i(\omega)$ represents the desired complex contour $C_c(b)$. Only the passband frequencies need to be considered in the objective function as $M(e^{j\omega})$ is conjugate anti-symmetric about the frequency $\pi/2$ (refer to [Tay, 98] for proof).

The summation is over a set of frequencies $\omega_1, \omega_2, \dots, \omega_L$ where $\omega_1 = 0$ and $\omega_L = \pi/2$ representing the passband edge. The idealised function M_i is given by

$$M_i(\omega) = \cos \theta(\omega) - j \sin \theta(\omega) \tag{11}$$

where $\theta(\omega) = K\omega^n$ for $0 \leq \omega \leq \pi/2$ and K is a normalisation factor $= (\pi/2)^{1-n}$.

The value of 'n' defines the roll-off requirement to be achieved by the optimisation process. A high value of 'n' will result in a filter with sharper roll-off. $W(\omega_m)$ in eqn. 10 is the weighting function and can have values of

$W(\omega_m) = m$, for a slow roll-off requirement i.e. positive linear weighting; or

$W(\omega_m) = L+1-m$, for a sharp roll-off requirement i.e. negative linear weighting.

It must be mentioned that a sharp roll-off tends to increase the ripple, whilst a slow roll-off tends to reduce it. For large values of n i.e. when $n \rightarrow \infty$, then

$$M_i(\omega) \rightarrow \begin{cases} 1 & \text{for } 0 \leq \omega \leq \pi/2 \text{ (passband)} \\ -1 & \text{for } \pi/2 \leq \omega \leq \pi \text{ (stopband)} \end{cases} \tag{12}$$

this is a typical idealised 'brick-wall' type frequency response.

The design problem of the prototype filters is thus reduced to minimising the objective function eqn. 10 subject to the constraints

$$-1 \leq d_i < 1 \text{ and } 0 < p_i < 1 \text{ for stability; and} \tag{13}$$

$$M(z=e^{j\pi/2}) = -jb \tag{14}$$

to ensure that the complex contour passes through the point $(0, -jb)$.

From the transformation function of eqn. 8, it can be seen that the simplest function is obtained when $P_r = 1$ and $P_c = 0$. This leads to essentially only one parameter to design for the required response. A trial-and-error approach is then easily applied to arrive at the desired response. However, for higher order

transformations, there are several parameters involved and a simple trial-and-error method is not practical. For this, a more comprehensive optimisation technique is required. Note that for the two cases of the transformation function used in the design examples considered in this work, the number of parameters required to be optimised can be reduced [Tay, 98]. For example for $P_r=2$ and $P_c=0$, then

$$c_1 = \frac{(1+d_1)(1+d_2)(1-c_2) - b(1-d_1)(1-d_2)(1+c_2)}{(1+d_1)(1+d_2)(1-c_2) + b(1-d_1)(1-d_2)(1+c_2)} \quad 15$$

and for $P_r=P_c=1$, then

$$c = \frac{F(1+d) - b(1-d)}{F(1+d) + b(1-d)} \quad 16$$

where

$$F = \left(\frac{p^2 - 2p\cos\psi + 1}{r^2 - 2r\cos\phi + 1} \right) \left(\frac{r^2 + 2r\cos\phi + 1}{p^2 + 2p\cos\psi + 1} \right)$$

The work reported in Tay [98] uses a trial set of 'seed' parameter values for the constrained optimisation algorithm function `constr.m` of Matlab to obtain a converged solution. A global optimal solution is not assured with such gradient-based methods so a number of trial 'seed' parameters must be used to obtain desirable results. This is a major limitation of the 'transformation of variables' technique especially for higher order transforms and has led to the motivation for the work that is covered in this paper. A genetic algorithm approach is developed to search for global minima. Furthermore, this work is extended towards obtaining finite word length, causal stable IIR filters through a second stage GA optimisation procedure for real-time applications.

3 Genetic algorithm implementation procedure and methodology

The major limitation of the optimisation process of the parameters of the transformation function covered by Tay [98] is the use of the Matlab function 'constr.m' that is based on the constrained non-linear i.e. sequential quadratic programming (SQP) method. This process works well but is highly susceptible in converging to a local minima point. A global optimal solution is not assured so a number of starting seed values must be tried. This is clearly restrictive and the problem is further compounded for higher order transformation functions that consist of larger number of parameters. GA optimisation is thus a good option in such applications due to its intrinsic search capability over a much wider landscape of the objective function.

In order to obtain the final optimised design based on the transformation of variables technique of the QMF bank for the FWL constrained real-time realisation, a number of steps must be followed. In brief these are:

1. Select the order of the transformation function $Z=M(z)$ (see eqn. 8) to be optimised and define the parameters of the idealised function given by eqn. 11 i.e. $M_i(\omega) = \cos\theta(\omega) - j\sin\theta(\omega)$, where $\theta(\omega)=K\omega^n$ for $0 \leq \omega \leq \pi/2$ and K is a normalisation factor $= (\pi/2)^{1-n}$. Note that for $n \rightarrow \infty$ then $M_i(\omega)$ generates the standard ideal brick-wall frequency response.
2. The transformation function design parameters given by $c_i, d_i, r_i, \phi_i, p_i, \varphi_i$ are optimised using the objective function given by eqn. 10 that is minimised i.e.

$$\text{Obj_fn} = \sum_{m=1}^L |M(e^{j\omega_m}) - M_i(\omega_m)|^2 W(\omega_m)$$
 where $W(\omega_m)$ is a weighting factor.
3. Use the prototype filters of eqn. 5 and the optimised transformation function from step 2 to derive the transfer function coefficients of the digital filters using eqns. 1 and 2. This step generates the IIR analysis and synthesis filters with high precision coefficients and the design stage of the QMF bank is completed.
4. This step is the second stage of the process where the high precision coefficients of the analysis and synthesis filters are converted to the finite word length form and then optimised using the GA technique.
5. The final step is the real-time implementation of the optimised QMF bank on a digital signal processing hardware kit.

An important observation in the above steps for final realisation of the QMF bank is that the optimisation of design is entirely independent of the FWL coefficient optimisation of the IIR filters. The two stages are thus considered separately since entirely different constraints and issues are involved with their optimisation processes. A combined code for the two stages for which the entire process is linked in a sequential form, however, is trivial. Figure 2 shows a complete flow chart procedure for obtaining a filter realisation for real-time implementation of the 2-channel sub-band filter banks.

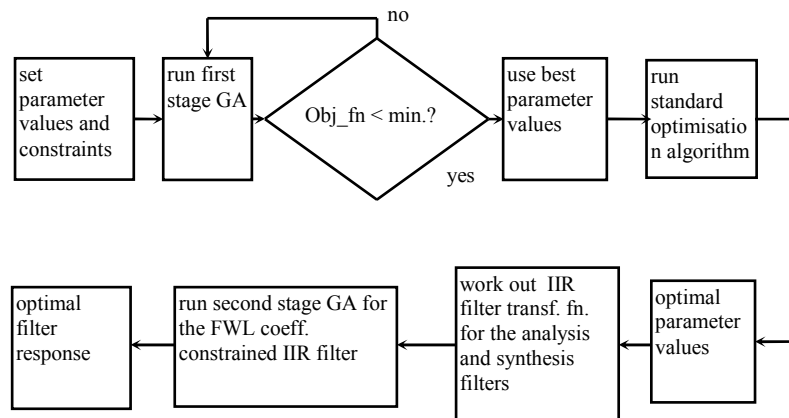

Figure 2: Flowchart for realisation of causal IIR filter using a two stage GA

4 Design examples and Results

4.1 Design Example 1

The transformation function for this design is obtained using $P_r=1$, $P_c=1$ and $b=0.5$. The pass-band edge is $\omega_L = 3\pi/8$ and negative linear weighting is applied. The frequency response roll-off value used is $n=10$. Optimised parameter values and the corresponding objective function values are shown in Table 1. This design example is of a higher order transformation function involving six variables. The last column of Table 1 shows the results of the objective function calculated over 100 frequency points. A small improvement of the hybrid GA optimised results is evident for this design example.

	c	d	r	ϕ	p	ψ	Obj_fn
GA	0.7478	0.4965	0.1908	1.0315	0.1045	-0.9866	0.1770
GA+ Constr.m	0.7491	0.5001	0.1918	1.0318	0.1097	1.0013	0.1764

Table 1: Comparative results for design example 1

4.2 Design Example 2

The transformation function for this design is obtained using $P_r=1$, $P_c=1$ and $b=0.7$. The passband edge is $\omega_L = 0.43\pi$ and positive linear weight is applied. The frequency response roll-off value of $n=25$ is used. Optimised parameter values and the corresponding objective function values are shown in Table 2. Once again, the results of the objective function show improvements of the GA hybrid optimised results when compared with the standard GA method. In general, it is significant to mention that the GA and the hybrid optimised results were derived in a direct manner without the need for trial 'seed' values. The results obtained were consistently good thus giving confidence to the design engineer for a likely optimal outcome. Furthermore, this process can be applied to higher order transformation functions with larger number of parameter values thus giving greater flexibility for a near optimal design implementation.

	c	d	r	ϕ	p	ψ	Obj_fn
GA	0.7784	0.6761	-0.2930	2.0348	0.2446	-1.1164	7.1902
GA+ Constr.m	0.7785	0.6764	0.2938	-1.1086	0.2461	-1.1191	7.1875

Table 2: Comparative results for design example 2

4.3 Design of Filters for the QMF bank

In the previous sections (4.1 and 4.2), a hybrid optimisation process was considered for optimising the parameters of the transformation function Z . The prototype filters can then be generated through eqn. 5. In this section, the low-pass/high-pass analysis/synthesis filters of eqns. 1 and 2 will be derived from the optimised prototype filters. The design example 1 of section 4.1 is considered here. The optimised parameter values obtained using the hybrid GA are taken from Table 1 and listed here in Table 3. The choice of these values gives a minimal objective function value.

c	d	r	ϕ	p	ψ	Obj_fn
0.7491	0.5001	0.1918	1.0318	0.1097	1.0013	0.1764

Table 3: Optimised parameter values for design example 1

4.4 Design and Simulation in Matlab

A Matlab based code was developed for deriving the four filters H_0 , F_0 , H_1 and F_1 based on the values of the parameters in Table 3. Figures 3(a) and 3(b) show the magnitude response of the analysis and synthesis filters respectively. The phase responses of the four filters are shown in Figure 4. It can be seen that the phase response is linear in the pass band region of the filters. This property contributes to the requirement for perfect reconstruction of the output signal.

In order to determine the amplitude distortion of the QMF bank, the overall transfer function of the QMF bank was derived using the transfer function of individual IIR filters. The amplitude distortion and group delay for the QMF bank are shown in Figure 5. These results clearly indicate close proximity to perfect reconstruction of the output signal. Further tests were conducted using the Simulink toolbox of Matlab. The QMF bank implementation in Simulink is shown in Figure 6. The input signal used is a random signal with uniform distribution in the range 1 to -1. The error signal is then obtained from the difference between the output signal and a delayed version of the input signal. The error signal for the optimised design example 1 is shown in Figure 7. Note that this error signal has a maximum error magnitude of approximately 1.5×10^{-15} that is close to the limits of the software mathematical error bounds. The Simulink test results demonstrate the perfect reconstruction property of the QMF bank based on IIR filters designed using the optimised coefficients of the transformation of variable technique.

4.5 Finite word length constraints for real-time implementation

The coefficients for four filters H_0 , F_0 , H_1 and F_1 derived are for direct form IIR filter implementation. These are infinite precision values generated using Matlab. However, for real-time implementation, there are two further issues that must be considered. These are; firstly, finite word length constraints due to either hardware limitations or efficient throughput requirements and secondly, using the IIR filter structure of a second order cascade form. The second order cascade structures are less sensitive to FWL constraints and is thus a preferred option. The coefficient values of the four filters must, therefore, be converted to second order cascade form.

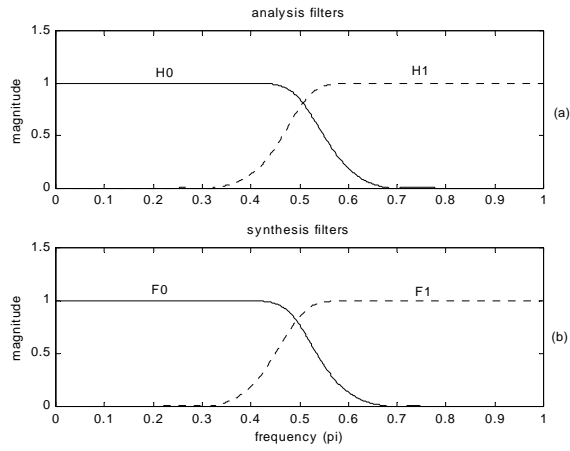

Figure 3: Magnitude response of the analysis filters (a) and synthesis filters (b)

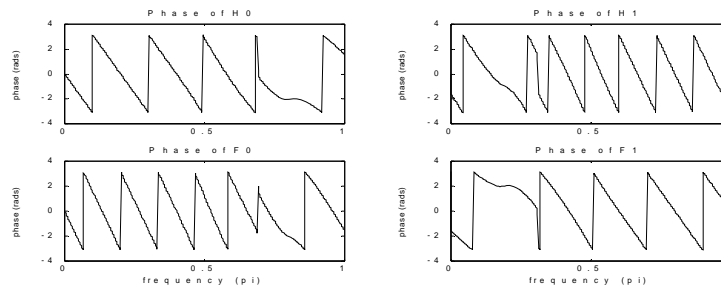

Figure 4: Phase response of the QMF filters

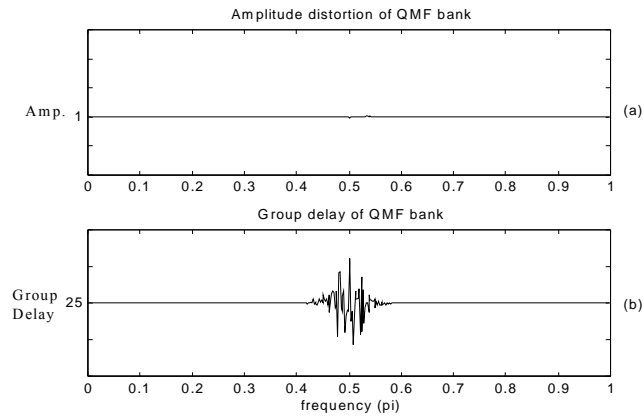

Figure 5: Amplitude distortion (a) and group delay (b) of the overall transfer function

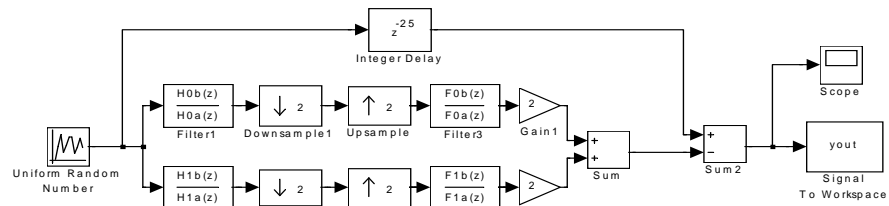

Figure 6: Matlab Simulink model of the QMF bank

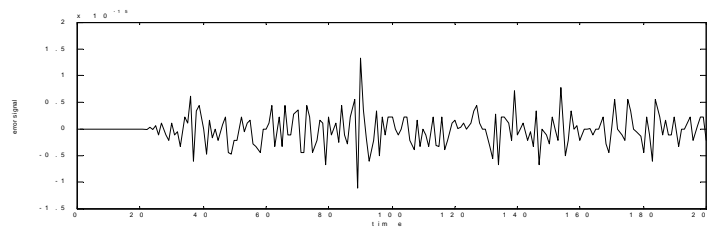

Figure 7: Error signal of the QMF bank for a random input signal (design example 1)

4.6 Finite word length constraints for real-time implementation

The second-stage GA optimisation for finite word length constraint of the filter coefficient values (see Figure 2) was conducted for the low pass filter H_0 , using 5 bits to represent the coefficient values. The magnitude response of the low pass H_0 filter for the design examples 1 and 2 are shown in Figures 8 and 9 respectively. The GA optimised response clearly indicates improvements for smaller number of bits that can be used as implementation for fast processing on dedicated high-speed low-bit hardware for real-time realisation.

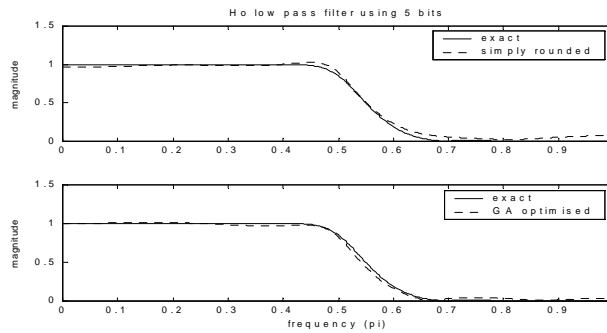

Figure 8: Magnitude response of H_0 low pass filter for design example 1

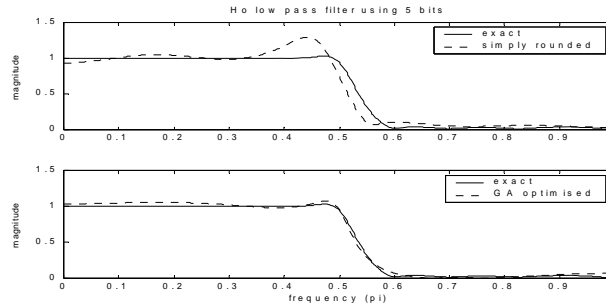

Figure 9: Magnitude response of H_0 low pass filter for design example 2

5 Real time implementation

5.1 Polyphase decomposition – a computationally efficient realisation

It is well established that polyphase decomposition of digital filters in realisations of multirate filter operations can facilitate computational savings in software and hardware implementations [Mitra, 98], [Vaidyanathan, 93]. Such polyphase implementations are useful for linear phase FIR filters and in certain structural forms of IIR filters. In order to derive the 2-branch polyphase decomposition of an IIR filter having a transfer function $H(z) = N(z) / D(z)$, it is necessary to express the filters in the form $N'(z) / D'(z^2)$. The form of transformation function of eqn. 8 ensures that the denominator of $M(z)$ and hence the denominators of $H_T(M(z))$ and $F_T(M(z))$ are functions of z^2 . Therefore, the transfer function $H(z)$ of the resulting filters will be of the form

$$H(z) = \frac{N(z)}{D(z^2)} = \frac{h_0 + h_1 z^{-1} + h_2 z^{-2} + \dots + h_n z^{-n}}{D(z^2)} \quad 17$$

Separating the even and odd-indexed terms of the numerator, the transfer function is of the form

$$H(z) = \frac{h_0 + h_2 z^{-2} + \dots + h_m z^{-m}}{D(z^2)} + z^{-1} \frac{h_1 + h_3 z^{-2} + \dots + h_k z^{-(k-1)}}{D(z^2)} \quad 18$$

where $m = n$ and $k = n-1$ for $n = \text{even}$
or $m = n-1$ and $k = n$ for $n = \text{odd}$.

The polyphase components of $H(z)$ are

$$E_0(z) = \frac{h_0 + h_2 z^{-1} + \dots + h_m z^{-m/2}}{D(z)} \quad 19$$

and

$$E_1(z) = \frac{h_1 + h_3 z^{-1} + \dots + h_k z^{-(k-1)/2}}{D(z)} \quad 20$$

The polyphase components are easily derived from the filter coefficients. The numerator values of the polyphase components are given by taking alternative coefficients of the numerator values and the denominator values are obtained by starting with the first coefficient for the denominator polynomial and taking every other value (i.e. ignoring the zero value coefficients). By expressing the analysis and synthesis filters of the QMF bank of Figure 1 (ignoring the coding block) in polyphase form as shown in Figure 10, the efficiency of the system can be improved without changing its characteristics.

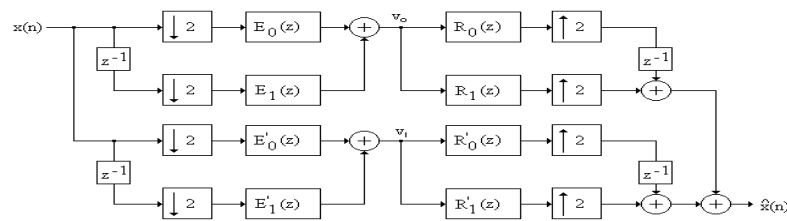

Figure 10: QMF bank in polyphase form

The system of Figure 10 was tested using the Simulink toolbox of Matlab. The results obtained are identical to those shown in Figure 7.

5.2 An 8 bit QMF bank in polyphase form – a case study

The block diagram of Figure 10 can be implemented using 8 bit fixed point arithmetic and has potential application in pulse code modulation (PCM) telephony signals [Crochiere, 81]. The lower and higher frequency sub-bands of the QMF bank can be encoded with 8 and 4 bits respectively to provide a data rate compression of 4/3. Figure 11 shows how the scaled polyphase components are affected by 8-bit coefficient representation, when cascade realisation is used. The solid lines show the desired magnitude response and the dashed lines show the rounded response.

Polyphase components E_0 and E_1 refer to the filter H_0 and R_0 and R_1 refer to the filter F_0 . The effects of 8 bit rounding appear small, with polyphase component E_0 having the largest distortion. This is a relatively simple GA optimisation problem. The GA optimised (dashed line) and the high precision actual responses (solid line) are almost identical (see Figure 12). The phase response was not affected. The polyphase components of H_1 and F_1 are also optimised to produce similar results.

5.3 Sub-band coding of speech signals

It is well recognised that higher frequency band speech signals have lower energy levels and the lower frequency band signals have higher energy levels [Bellamy, 00]. This characteristic of the speech signal can be exploited to improve the coding gain of the digital telephony signals. The bit rate assigned to each sub-band can be optimised to match the hearing perception of the human ear.

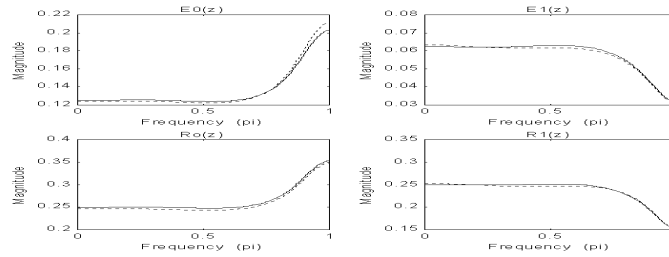

Figure 11: Effect of 8-bit coefficient wordlength on polyphase components. Solid line shows desired response and dashed line is for rounded coefficient response

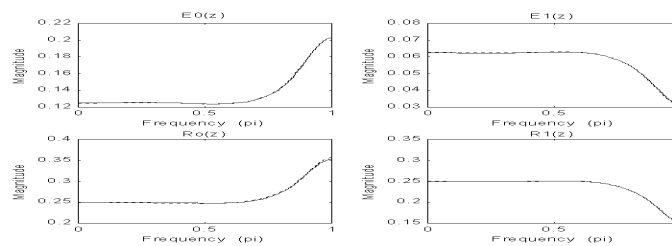

Figure 12: GA optimised 8 bit coefficient polyphase components. Solid line shows desired response and dashed line is for GA optimised coefficient response

In particular, larger number of bits per sample can be assigned to the lower frequency band where it is important to preserve the pitch and structure of human voice sounds. However, fewer numbers of bits per sample can be used for higher frequency band where noise-like segmented sounds have less effect on the reproduction quality. In general, a number of sub-bands can be used to optimise the coding compression. The scheme due to Crochiere [81] splits the signal into four equal bands of 0 to 1 kHz, 1 to 2 kHz, 2 to 3 kHz and 3 to 4 kHz. The first band is further split in to two bands of 0 to 0.5 kHz and 0.5 to 1 kHz. Thus there is a pruned tree effect of five bands. However, for simplicity and ease of real-time implementation, a structure of splitting the speech signal into two equal bands using the QMF bank optimised and developed in this paper will be considered here.

5.4 Companding in a QMF bank structure

In this section, an appropriate method of implementing the PCM companding process in a quadrature mirror filter bank will be considered. The compression procedure will normally distort the spectral properties of speech and therefore it cannot be applied at a point preceding the analysis filter bank. A more appropriate approach would be to compress each sub-band signal according to its characteristics in order to ensure that the useful properties of each sub-band are not altered. This is shown in Figure 13. It is assumed that the lower frequency segment of the speech has a peak magnitude of 1

and the higher frequency segment has a peak magnitude of 0.25. If each sub-band is compressed according to its peak magnitude then an improvement in signal to quantisation noise ratio (SQNR) is achievable while still being able to compress the data rate by encoding $v_1(n)$ with fewer bits. Signals $v_0(n)$ and $v_1(n)$ must be expanded by a matching expander before being processed by the synthesis filters.

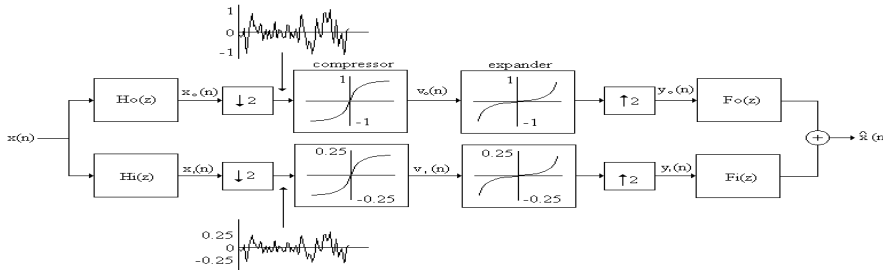

Figure 13: Sub-band compression and expansion of a QMF bank

5.5 Testing and comparison of several QMF banks

A set of four two-channel QMF banks employing uniform encoding i.e. without companding and four two-channel QMF banks using the non-linear A-law companding (with $A=87.56$) were developed and tested on a real-time DSP Texas Instrument kit. Look-up tables provide a mapping between the 12-bit codes and the compressed 8-bit codes [Bellamy, 00]. Both sets use 8-8, 8-5, 8-4 and 7-5 encoding (x-y encoding stands for x bits for the lower frequency channel and y bits for the higher frequency channel). The encoding schemes are based on channel signal level and significance. The data compression achievable for the 8-8, 8-5, 8-4 and 7-5 encoding are 64 kbps, 56 kbps, 48 kbps and 48 kbps respectively; assuming sampling rate of 8 kHz is used. The various QMF bank models were compared based on the Mean Opinion Score (MOS) test [Vaidyanathan, 93], [Porat, 97]. This is a commonly used measure of speech quality and is based on evaluating the average speech quality on a scale of 1 to 5 where 1 is bad and 5 is excellent. A sample of 10 individuals was taken to conduct the tests. The individual scores for each encoding scheme were averaged to give the MOS. Table 4 shows the results of the test including the MOS values calculated

Compand	LP	HP	5	4.5	4	3.5	3	2.5	2	1.5	1	MOS
No	8	8			****	***	***					3.6
No	8	5					*****	***	***			2.8
No	8	4					***	**	**	**	*	2.2
No	7	5						***	*****	**	*	2
Yes	8	8	*	****	**	***						4.2
Yes	8	5				****	**	****				3.5
Yes	8	4			***	***	**	**				3.4
Yes	7	5	*	****	****	*						4.3

Table 4: Mean opinion score (MOS) results for ten individuals. LP=low pass, HP=high pass

The results clearly show that the companding process yielded higher MOS values when compared to simple encoding of sub-band signals for identical encoding schemes.

It must be emphasised that although the sample of ten individuals used in this test is relatively small and thus statistically not significant, however, a trend has clearly emerged that deserves further extensive investigation in the future.

6 Discussion of results and conclusions

A design method based on the transformation of variable technique has been extensively studied and applied in this paper. The major motivational aspects of the work covered here are based on the use of IIR filters for the design of perfect reconstruction 2-channel quadrature mirror filter bank. This design procedure is simple and it offers vast flexibility for fine-tuning of the overall system. Automating the optimisation process of the design of the QMF bank was achieved by using genetic algorithms followed by a standard gradient based optimisation method in a hybrid approach. GAs were also used in the second stage for optimisation of IIR filter coefficients based on finite word length constraints. This second stage GA optimisation is useful in the implementation of the system for real-time applications.

Further contributions are in deriving the IIR filter coefficients of the QMF bank and testing the system using the Simulink toolbox of Matlab. The overall amplitude distortion and the error signal for the optimised QMF bank are shown to have an amplitude distortion that is almost entirely flat and the error signal is of the order of the software mathematical error limits. These outcomes clearly indicate the perfect reconstruction characteristic of the design as embedded in the theoretical considerations.

The final stage of this study was the implementation of the optimised QMF bank using a real time digital signal processor kit. A case study example for PCM companding was applied to the lower and the upper frequency segments of the speech signal. Tests were conducted using a small sample of individuals based on variable number of bits for encoding the input signal and the application or absence of the companding scheme. The results are compared using the mean opinion score (MOS) measure. These results clearly show an improvement of the MOS measure by using the companding technique as proposed. The compression achievable for this form of signal is 4/3.

References

[Baicher, 10], Baicher, G.S.: Towards optimal implementation of a class of quadrature mirror filter using genetic algorithms, In Proc. 5th IEEE International Conference on Bio-Inspired Computing: Theories and Applications, BIC-TA 2010, Liverpool, UK, 8-10 Sept 2010

[Baicher, 00] Baicher, G.S., Turton, B.C.H.: Comparative study for optimisation of causal IIR perfect reconstruction filter banks, In Proc. IEEE Congress on Evolutionary Computation, CEC 2000, San Diego, USA, 974-977, 2000

- [Baicher, 99] Baicher, G.: A two stage genetic algorithm for optimisation of causal IIR perfect reconstruction multirate filter banks, In Proc. IEEE Congress on Evolutionary Computation, CEC 1999, Washington, DC, USA, 897-903, 1999.
- [Bellamy, 00] Bellamy J.: Digital Telephony – 3rd edition, New York: John Wiley, 2000
- [Chen, 95] Chen T., Francis B.A.: Design of Multirate Filter Banks by H^∞ Optimization. IEEE Transactions on Signal Processing, vol. 43(12), Dec 1995
- [Crochiere, 81] Crochiere R.E.: Sub-Band coding, Bell System Journal, vol. 60(7), 1633-1653, 1981
- [Lee, 01] Lee J.-H., Niu I.-C.: Minimax design of two-channel IIR QMF banks with arbitrary group delay, IEE Proceedings on Vision, Image and Signal Process, vol. 148(6), 384-390, 2001
- [Lollmann, 08] Lollmann, H.W., Vary, P.: Design of IIR QMF banks with near-perfect reconstruction and low complexity, In Proc. IEEE International Conference on Acoustics, Speech and Signal Processing, ICASSP-2008, 3521-3524, 2008
- [Lollman, 09] Lollmann, H.W., Hildenbrand, M. Geiser, B.: IIR QMF bank design for speech and audio subband coding, In IEEE Workshop on Applications of Signal Processing to Audio and Acoustics, WASPAA-2009, 2009
- [McClellan, 73] McClellan J.H.: The design of two-dimensional digital filters by transformations, In Proc. 7th Princeton Conf. on Info. Sciences and Systems, 247-251, 1973
- [Mitra, 98] Mitra S.K.: Digital Signal Processing – a computer based approach, New York, McGraw-Hill, 1998
- [Porat, 97] Porat B. A.: Course in Digital Signal Processing, New York, Wiley, 1997
- [Ramakrishna, 06] Ramakrishna, A, Nigam, M.J.: A simple method to design FIR QMF Bank, In Proc. 4th International Conference on intelligent sensing and information processing, ICISIP-2006, pp. 236-239, 2006
- [Tay, 96] Tay D.B.H., Kingsbury N.G.: Design of 2-D perfect reconstruction filter banks using transformations of variables: IIR case, IEEE Transactions on Circuits and Systems -II Analog and Dig. Sig. Proc, vol. 43(3), 274-279, 1996
- [Tay, 93] Tay D.B.H., Kingsbury N.G.: Flexible design of multidimensional perfect reconstruction FIR 2-band filters using transformations of variables, IEEE Transactions on Image Processing, vol. 2(4), 466-480, 1993
- [Tay, 98] Tay D.B.H.: Design of causal stable IIR perfect reconstruction filters banks using transformation of variables, IEE Proceedings on Vision, Image and Signal Process, vol. 145(4), 287-292, 1998
- [Vaidyanathan, 90] Vaidyanathan P.P.: Mutirate digital filters, filter banks, polyphase networks and applications: a tutorial, IEEE Proceedings. vol. 78, 56-93, 1990
- [Vaidyanathan, 93] Vaidyanathan P.P.: Multirate systems and filter banks, Prentice-Hall, 1993
- [Vetterli, 95] Vetterli M., Kovacevic J.: Wavelets and sub-band coding, Prentice Hall, 1995