

Research on a scheme of generating ultra-wideband doublet signal based on the cross-gain modulation in a semiconductor optical amplifier

KAI ZHANG, JING SHAO*

College of Science, Wuhan Institute of Technology, Wuhan, 430205, Hubei, China

*Corresponding author: daisysj@163.com

We propose a novel scheme for generating ultra-wideband doublet signal based on the cross-gain modulation effect in a semiconductor optical amplifier. This scheme requires only a semiconductor optical amplifier and an optical source. By using OptiSystem software, we simulate and analyze the effect of the input signal light power and wavelength, the pulse width and injection current on the generated doublet pulse. In addition, the optimal range of parameters are also given in the simulation process.

Keywords: ultra-wideband (UWB), semiconductor optical amplifier (SOA), cross-gain modulation (XGM).

1. Introduction

Ultra-wideband (UWB) radio frequency (RF) technology is a short-range wireless transmission technology. It is widely studied because of its high speed, low power consumption, high security and bandwidth sharing with existing RF systems [1, 2]. In order to increase the transmission distance of UWB signals, UWB over fiber technology is proposed.

At present, many researches have been proposed to generate UWB pulses. The scheme for UWB signal generation based on cross-gain modulation (XGM) [3–6] or gain saturation effect [7] of the semiconductor optical amplifier (SOA) was presented. In [8], an all-optical UWB generation employed an electrical modulation signal pulse edge change. In [9], an approach to generate UWB doublet pulse by using different linear regions of the reflected spectrum in the fiber Bragg grating (FBG) was proposed. Photonic generation of UWB signals cross-phase modulation (XPM) [10], cross-polarization modulation (CPM) [11] and four-wave mixing (FWM) [12] were also proposed. Besides, phase modulation (PM) and FBG can be combined to generate high order UWB pulse [13].

In this paper, we propose a novel scheme to generate UWB doublet pulses based on the XGM using pump light and probe light which are coupled into SOA in opposite directions. The use of an opposite working mode can improve the output signal extinction

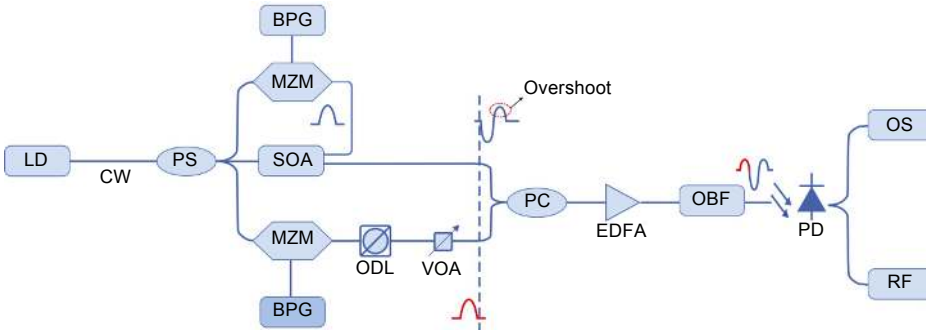

Fig. 1. Doublet signal pulse generation principle structure diagram. LD – laser diode, PS – power splitter, BPG – bit pattern generator, ODL – optical delay line, VOA – variable optical attenuator, PC – power combiner, OBF – optical bandpass filter, PD – photodetector, OS – oscilloscope, RF – spectrum analyzer.

ratio [14]. Compared with the result of Zhao's doublet pulse [5], the center frequency of the resulting signal is more stable and the power spectrum is more in line with FCC's requirements for UWB. We simulate the scheme using OptiSystem software and analyze the effect of the input signal light power and wavelength, the pulse width and injection current on the generated doublet pulse. In addition, the optimal range of parameters are given in the simulation process.

2. Experimental setup and principle

The schematic diagram of experimental setup is shown in Fig. 1, which generates doublet pulse based on XGM in SOA.

The continuous light (CW) generated by laser diode (LD) is splitted into three beams by a power splitter (PS). The continuous light of the upper branch is modulated to pump light by MZM and the middle branch is used as the probe light. The continuous light of the lower branch is modulated to signal light through the MZM.

The power of the probe light and the pump light achieves the maximum at the right and left ends of the SOA, respectively. The pump light is strong at the left side of SOA, so the probe light is modulated into an inverted negative pulse by the XGM. Because of the gain saturation of the SOA and overshoot phenomenon, the probe light generates a monocycle. The monocycle and the signal pulses of the lower branch are coupled together by a delay, attenuator and optical power combiner to generate a doublet pulse. The doublet pulse is amplified and filtered by the EDFA and optical bandpass filter (OBF), and then converted into electrical pulses through the photodetector (PD). Finally, the output is observed by an oscilloscope and a spectrum analyzer.

3. Simulation results and discussions

We use OptiSystem software to simulate the scheme. If there are no specified instructions, the system parameters always used are as follows.

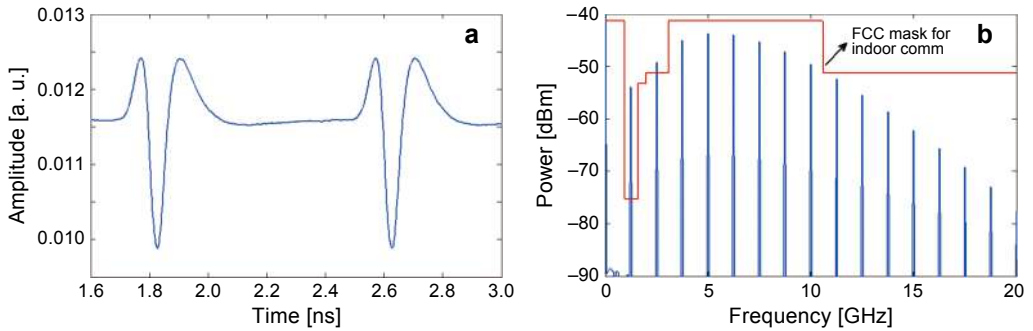

Fig. 2. Output doublet pulse waveforms (a) and radio frequency spectrum (b).

The power and wavelength of the light source are set to 0.237 mW and 1563.5 nm, respectively. The coding is carried out at a duty ratio of 1:16. According to the bit rate of 20 Gbit/s and duty cycle, we can calculate the pump light repetition frequency of 1.25 GHz. The injection current of SOA is 70 mA. The center frequency of the filter is 1563.5 nm and its bandwidth is 0.7 nm.

In this setting, the output of the doublet pulse and its RF spectrum are shown in Fig. 2. The -10 dB bandwidth and relative bandwidth of the output RF signal are 9.9 GHz and 158%, respectively. It meets the FCC UWB definition.

3.1. The effect of light source on doublet signal

To study the effect of the light source on the doublet signal, the optical power of the input signal is set to 0.217, 0.227, 0.237, 0.247 and 0.257 mW, and other parameters are kept unchanged.

The simulation results are shown in Fig. 3. It can be seen from the signal waveforms in Figs. 3a–3e that the average power of the doublet signal is gradually increased with the light source power increasing within a certain range. But the relative amplitude of the left side of the pulse is gradually lower than the right side. This is due to the incident signal power of the lower branch increasing. While the probe light pulse gain gradually

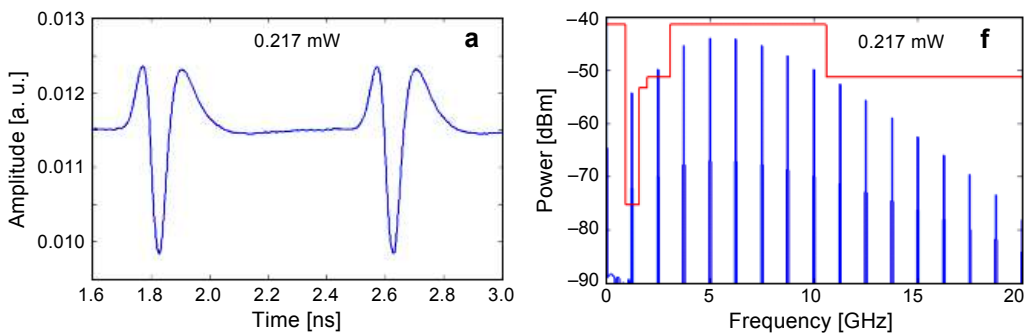

Fig. 3. To be continued on the next page.

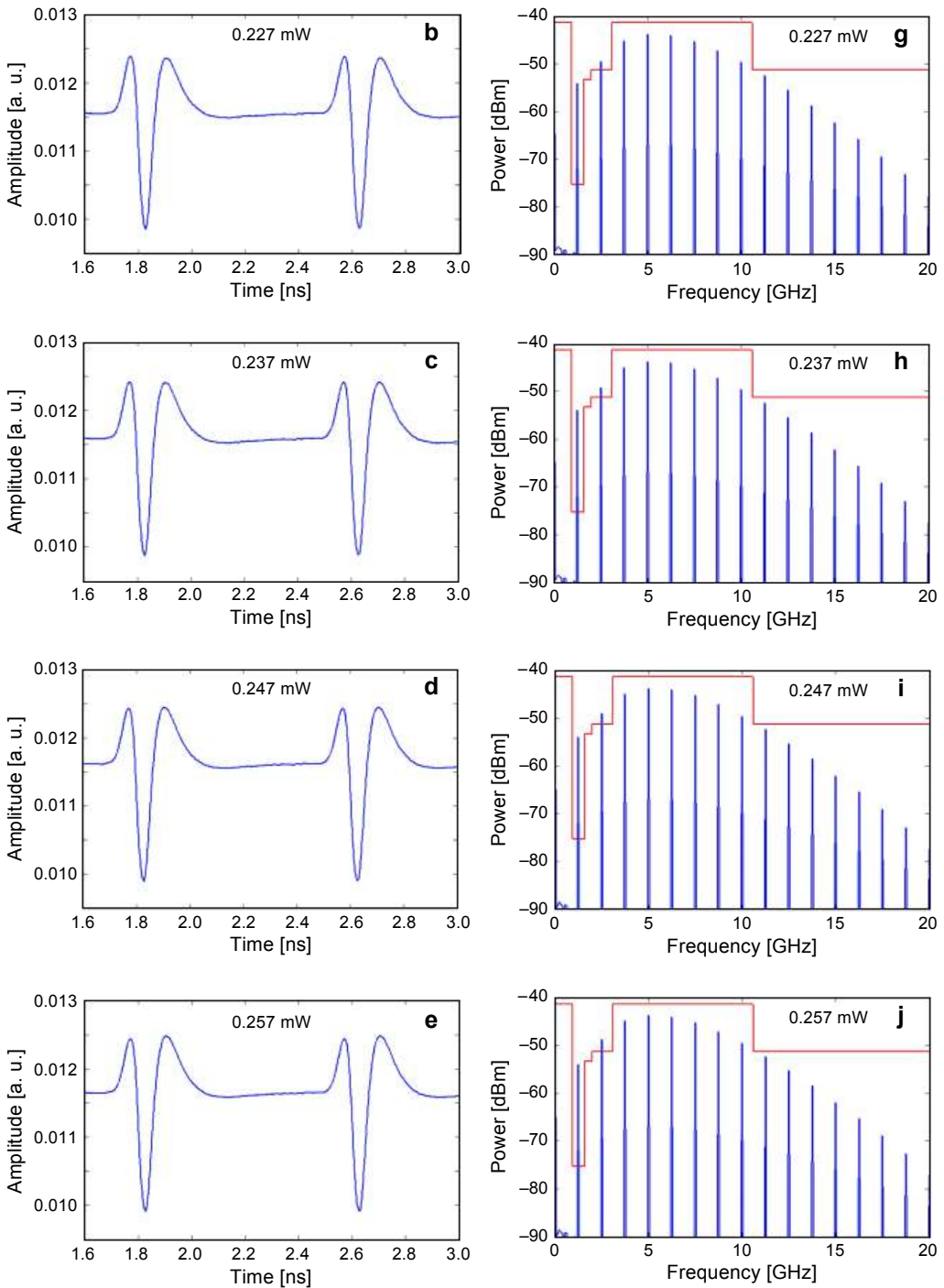

Fig. 3. Doublet pulse waveforms (**a–e**) and radio frequency spectrum (**f–j**) with different input optical powers.

is increased, the resulting overshoot (right positive pulse) gradually becomes larger. It can be seen from Figs. 3g–3i that the power spectral density of the 3.1–10.6 GHz signal is increased to meet the requirements of the FCC for UWB, and bandwidth is greater than 158%. Therefore, in the case where the attenuation is fixed, the output signal is better when the optical power is set between 0.227 and 0.247 mW.

3.2. The effect of the pulse width of the input signal on the doublet pulse

Figures 4a–4c shows the output doublet pulse when the input signal pulse width is 0.3, 0.6 and 0.9 bit, respectively.

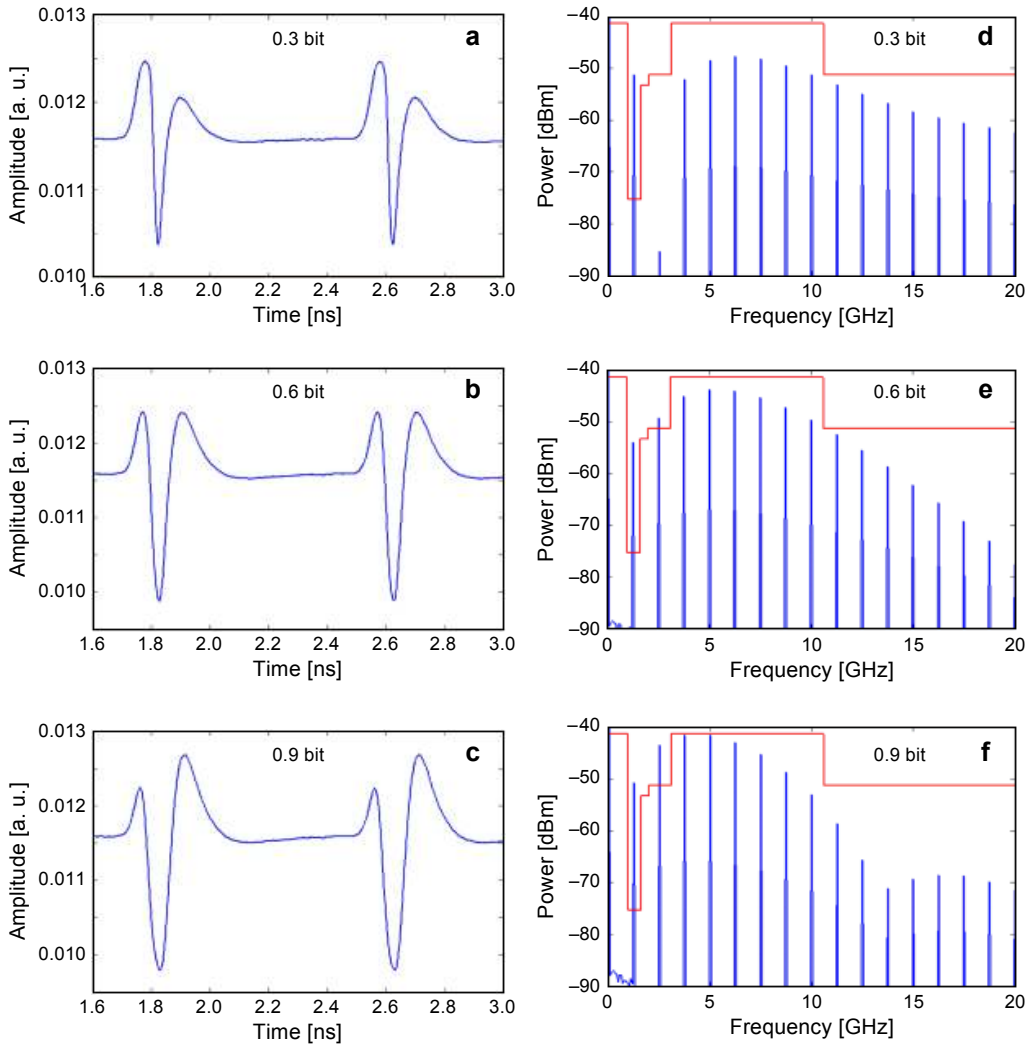

Fig. 4. Doublet pulse waveforms (a–c) and radio frequency spectrum (d–f) with different input signal pulse width.

It can be seen that the average optical power of the output doublet signal is decreased gradually as the pulse width of the input signal increases, and the amplitude of the entire doublet signal pulse is increased. But the relative amplitude of the left side is gradually lower than the right side. This is due to the fact that the signal pulse is widened so that the duration of the probe light at low power gets longer, allowing the carrier to be effectively recovered. Overshoot is increased and the relative amplitude of the left side is gradually lower than the right pulse. As shown in Figs. 4d–4f, when the output signal pulse is 0.3 bit, the corresponding spectrum is so wide that the FCC requirements of UWB are not met. When the output signal pulse is 0.6 bit, the output RF signal -10 dB bandwidth is 9.9 GHz and the relative bandwidth is 158%. It has a good symmetry and meets the FCC requirements of the UWB very well. When the input signal pulse width is 0.9 bit, the low frequency components are increased and the high frequency components are significantly inhibited. It roughly meets the FCC requirements for UWB. Therefore, the doublet signal output in this scheme is better when the input signal pulse width is 0.6 bit.

3.3. The effect of SOA injection current on the doublet signal

To study the effect of SOA injection current on the doublet signal, the input current of SOA is set to 60, 65, 70, 75 and 80 mA, respectively, and other parameters are kept unchanged.

The simulation results are shown in Fig. 5. It can be seen from Figs. 5a–5e that the symmetry of the output signal becomes better and then asymmetrical as the injection current increases. The average power is increased as the injection current increases. A doublet signal on the left side of the pulse amplitude is gradually reduced, and the right side of the pulse is gradually steep. This is due to the fact that the XGM effect is weak at low carrier concentration, so the generated negative pulse amplitude is small. With the increasing of the injection current, the carrier concentration in the SOA is increased, and the carrier recovery speed is accelerated. The negative pulse amplitude generated by the XGM effect is gradually increased and overshoot amplitude becomes larger. So the left side of the pulse amplitude is gradually lower than the right side. It can be seen from Figs. 5f–5j that the low frequency components of the doublet signal

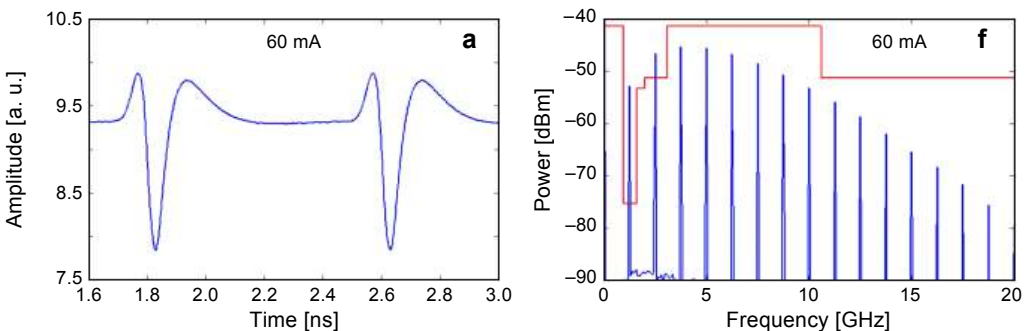

Fig. 5. To be continued on the next page.

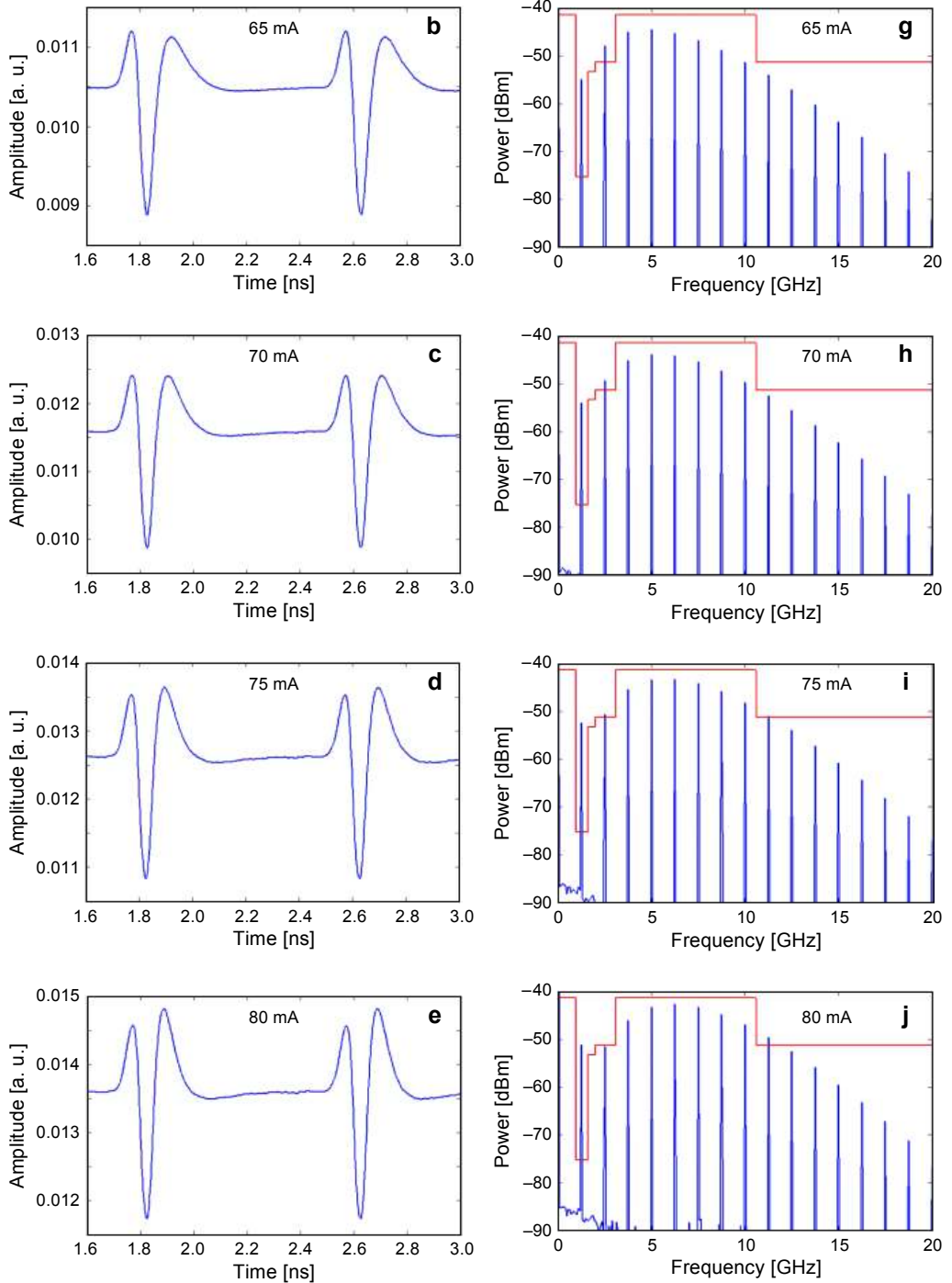

Fig. 5. Doublet pulse waveforms (a–e) and radio frequency spectrum (f–j) with different SOA injection current.

increase as the injection current increases, but there is a significant low frequency rejection at 2.5 GHz when the injection current is 70 mA. The spectrum is roughly in line with FCC requirements. According to the waveform diagram, the output signal is better when the injection current is maintained at about 70 mA.

3.4. The effect of light source wavelength on the doublet signal

When the wavelength is increasing from 1540.5 to 1565.5 nm, the effect of light source wavelength on the doublet signal is studied.

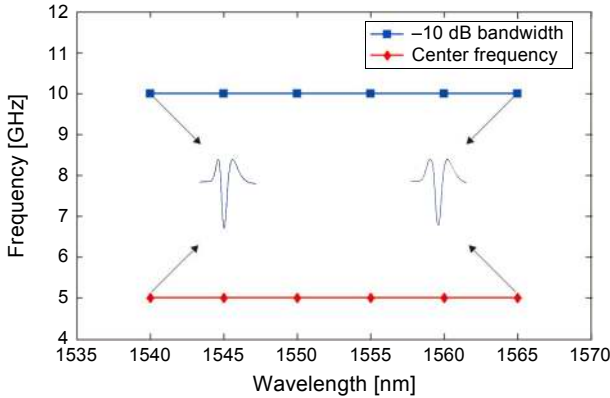

Fig. 6. Doublet signal center frequency and -10 dB bandwidth with the wavelength of the light source curve.

The doublet signal center frequency and -10 dB bandwidth and wavelength of the curve are shown in Fig. 6. As can be seen from Fig. 6, the waveform of the output signal does not change with different wavelengths. The relative bandwidth of the output doublet signal is greater than 158%, which meets FCC requirements. Therefore, this scheme is insensitive to wavelength variations and can generate UWB signals over a wide range.

4. Conclusion

We propose a novel scheme for generating UWB doublet signal based on the XGM in a SOA. The effect of light source power, input signal pulse width, SOA injection current and light source wavelength on the doublet signal is studied by using OptiSystem software. The reference range of parameters is given. The results show that the output signal is better when the power of the light source is between 0.227 and 0.247 mW, and the spectrum has good tolerance to the power of the light source, which shows that the available range is very wide. When the wavelength of the light source is between 1543.5 and 1563.5 nm, the center frequency and -10 dB bandwidth of the doublet signal are almost unchanged, indicating that the scheme is not sensitive to the wavelength. In the process of analysis, the pulse width of the input signal and optimization range

of the SOA injection current are given. It has a significant theoretical guidance for the experiment.

Acknowledgements – This work has been supported by the Natural Science Foundation of Hubei Province (No. ZRMS2016000911) and the President's Foundation of Undergraduate Research of Wuhan Institute of Technology.

References

- [1] AIELLO G.R., ROGERSON G.D., *Ultra-wideband wireless systems*, IEEE Microwave Magazine **4**(2), 2003, pp. 36–47.
- [2] ROY S., FOERSTER J.R., SOMAYAZULU V.S., LEEPER D.G., *Ultrawideband radio design: the promise of high-speed, short-range wireless connectivity*, Proceedings of the IEEE **92**(2), 2004, pp. 295–311.
- [3] QING WANG, FEI ZENG, BLAIS S., JIANPING YAO, *Optical ultrawideband monocycle pulse generation based on cross-gain modulation in a semiconductor optical amplifier*, Optics Letters **31**(21), 2006, pp. 3083–3085.
- [4] WEIWEI ZHANG, JUNQIANG SUN, JIAN WANG, CHENG CHENG, XINLIANG ZHANG, *Ultra-wideband pulse train generation based on turbo-switch structures*, IEEE Photonics Technology Letters **21**(5), 2009, pp. 271–273.
- [5] ZAN-SHAN ZHAO, PEI-LI LI, JIA-JIN ZHENG, TING-TING PAN, SHI-JIE HUANG, YOU-HONG LUO, *All-optical ultra-wideband doublet signal source based on the cross-gain modulation in a semiconductor optical amplifier*, Optoelectronics Letters **8**(2), 2012, pp. 89–92.
- [6] JING SHAO, SUHUI LIU, *Photonic generation of filter-free ultrawideband monocycle and doublet signal using single semiconductor optical amplifier in counter-propagation scheme*, Optical Engineering **55**(2), 2016, article ID 026117.
- [7] SHIJIE HUANG, PEILI LI, *Research of doublet signal source based on gain saturation effect in a semiconductor optical amplifier*, Journal of Nanjing University of Posts and Telecommunications (Natural Science) **33**(1), 2013, pp. 44–50 (in Chinese).
- [8] WANGZHE LI, JIANPING YAO, *Edge-triggered bi-phase modulation for the generation and modulation of UWB pulses*, IEEE Photonics Technology Letters **20**(20), 2008, pp. 1691–1693.
- [9] MEI YIN, AIJUN WEN, YANG CHEN, LEI SHANG, *Photonic generation of high order UWB signals*, Optik – International Journal for Light and Electron Optics **124**(12), 2013, pp. 1079–1082.
- [10] JIANJI DONG, YIN ZHANG, YUAN YU, DEXIU HUANG, XINLIANG ZHANG, *Photonic generation of power-efficient ultra-wideband waveforms using a single semiconductor optical amplifier*, Optoelectronic Materials and Devices **30**(1), 2011, pp. 693–694.
- [11] HONGWEI CHEN, MINGHUA CHEN, TIANLIANG WANG, MO LI, SHIZHONG XIE, *Methods for ultra-wideband pulse generation based on optical cross-polarization modulation*, Journal of Lightwave Technology **26**(15), 2008, pp. 2492–2499.
- [12] FANGZHENG ZHANG, JIAN WU, SONGNIAN FU, KUN XU, YAN LI, XIAOBIN HONG, PING SHUM, JINTONG LIN, *Simultaneous multi-channel CMW-band and MMW-band UWB monocycle pulse generation using FWM effect in a highly nonlinear photonic crystal fiber*, Optics Express **18**(15), 2010, pp. 15870–15875.
- [13] ZENG F., WANG Q., YAO J., *All-optical UWB impulse generation based on cross-phase modulation and frequency discrimination*, Electronics Letters **43**(2), 2007, pp. 121–122.
- [14] FAQIANG WANG, YU ZHAO, ZHUQING ZHU, *Theoretical study of extinction ration of wavelength-converted optical signal based on SOA-XGM*, Chinese Journal of Lasers **31**(12), 2004, pp. 1495–1499.

*Received April 17, 2017
in revised form May 15, 2017*