

RESPONSE SURFACE MODELLING OF THERMO-MECHANICAL FATIGUE IN HOT FORGING

G.A. Berti, S. Bonnini, M. Monti, L. Salmaso

1. INTRODUCTION

Thermo-mechanical fatigue (TMF) is one of the most complex fatigue damage mechanisms, being related to the combination of many factors (both mechanical and thermal) which mutually influence the material's stresses as well as its strength. Moreover, TMF experiments require expensive equipment and are a time-consuming and often they are simplified according to isothermal fatigue (IF) procedures, where the temperature is fixed and kept constant. As pointed out by Fang *et al.* (2001), the fatigue lives obtained in TMF experiments are lower than those obtained in IF experiments.

The aim of this study was to fit a model for the prediction of service life using experimental data. We wanted to design and apply experimental procedures that should be able to reproduce conditions very similar to industrial operating conditions. For this reason we had to take into account that temperature in the specimen is not constant.

To this end a new simulative time-saving laboratory experiment was proposed. For the experimental investigation we used Design of Experiments (DoE) techniques on a typical hot-working steel (DIN X37CrMoV5-1). We fitted a multiple linear regression model with Response Surface Methods. This model, linear in the parameters, is very useful to describe the relationship between response and factors, in this case characterized by a curvature (non linear relation), and to predict TMF lives.

2. EXPERIMENTAL PROCEDURES

2.1. *Objectives of the experimental campaign*

The experimental campaign aims to determine an empirical model to predict the service life of a hot-working steel subjected to thermo-mechanical conditions of real forging cycles.

2.2. Experimental apparatus

A new simulative laboratory experiment was developed in order to generate more controlled thermo-mechanical fatigue failures. The experimental apparatus was able to apply thermo-mechanical conditions deriving from industrial cases. The control system diagram is shown in figure 1 and further details can be found in a previous work (Berti and Monti, 2003).

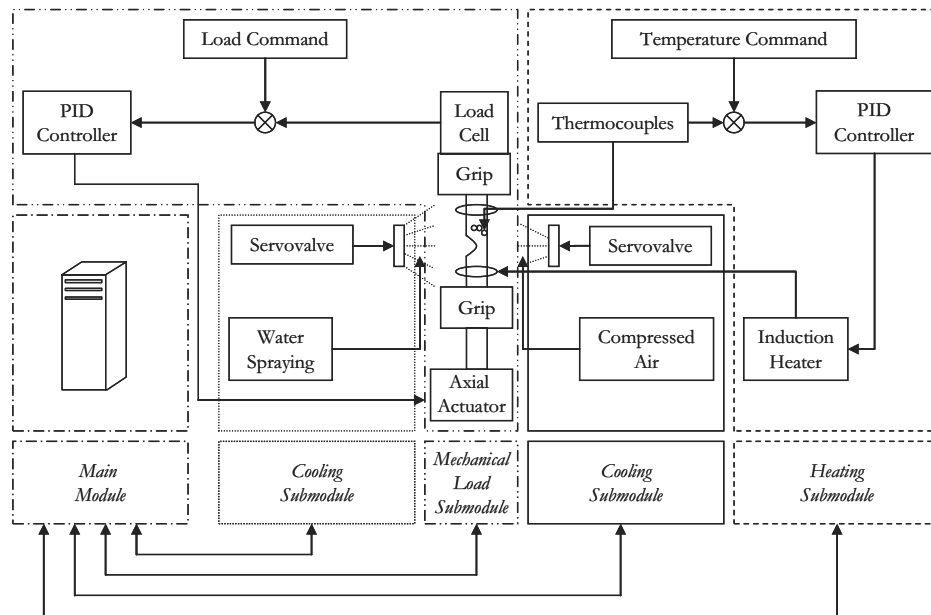

Figure 1 – The control system diagram.

2.3. Specimen geometry

The geometry of the specimen (shown in figure 2) was defined in order to i) replicate the thermal gradient in the cross-section of the specimen, ii) obtain efficient cooling in the central part of the specimen and iii) generate a state of stresses concentrated in this area.

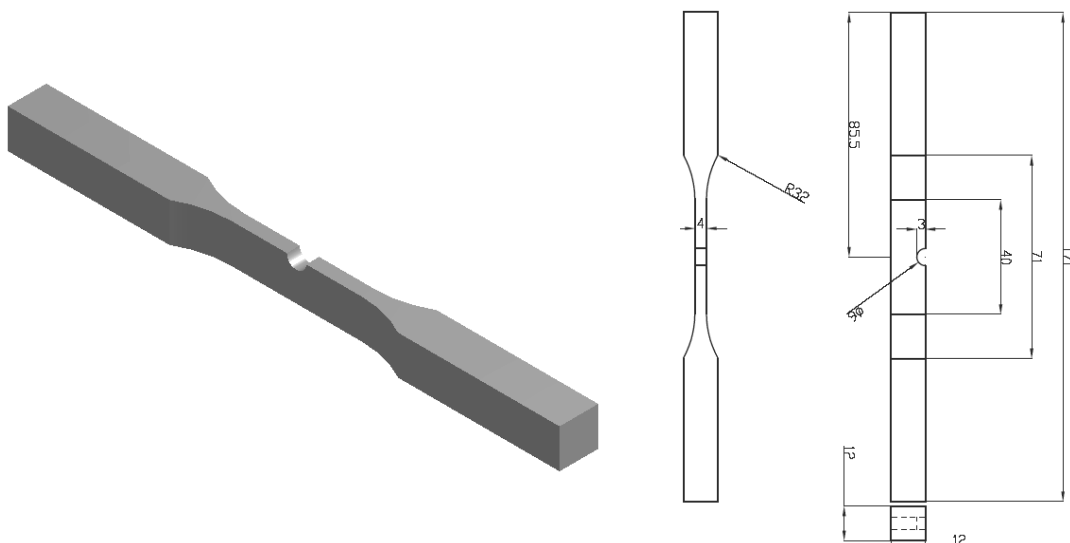

Figure 2 – The specimen.

2.4. Experimentation strategy

The experimentation strategy adopted to study the material's behaviour in conditions of thermo-mechanical fatigue can be represented by the flowchart shown in figure 3.

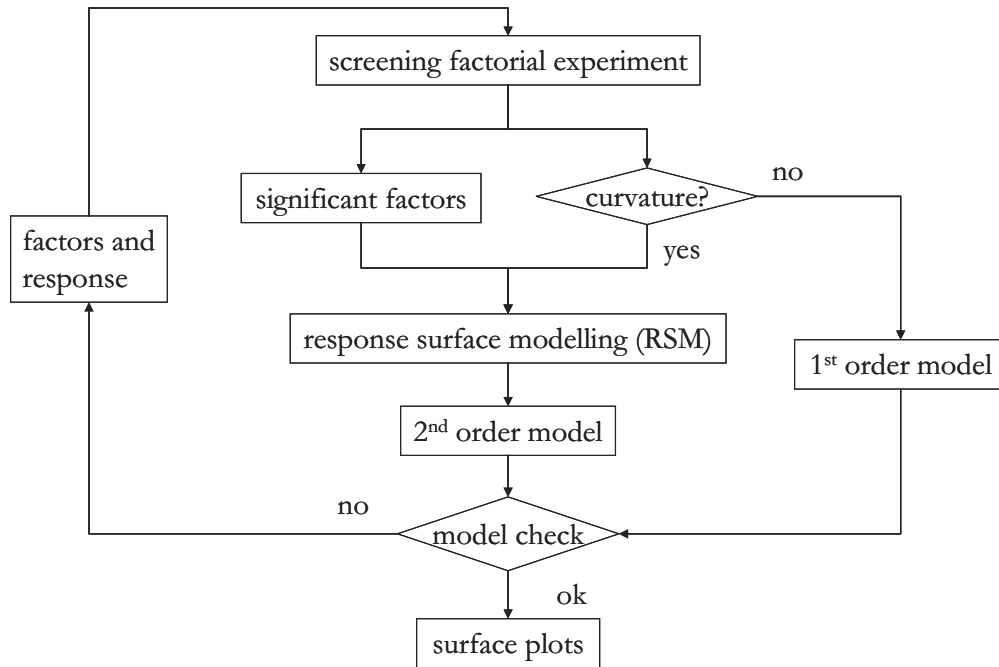

Figure 3 – Experimentation strategy.

On the basis of literature analysis and previous experimentation performed at industrial sites (Lange *et al.*, 1992, Vasquez *et al.*, 1996), we defined which factors had to be included in the investigation and the relevant responses to be investigated.

Subsequently a preliminary *screening factorial experiment* was performed in order to identify the significant factors and detect curvature of response. If curvature is not present, a first order model (containing only linear effects) has to be chosen. Otherwise a *Response Surface Modelling (RSM)* must be adopted to fully characterize the factor effects on responses.

RSM techniques allow us to take curvature into account since a second order model (also containing quadratic effects) can be used to characterize the response.

Relevant surface plots will be traced in order to show the effects of variables towards the response.

2.5. Factors and response

Among factors which may affect the response, some were chosen to be kept constant during the experimentation, such as material, specimen heat treating and cooling fluid. Other factors, specifically related to the forging process, were con-

sidered varying in the experimentation, namely: i) *maximum temperature cycle*, ii) *minimum temperature cycle* and iii) ratio between equivalent stress and yield strength at corresponding temperature ϕ , i.e. a parameter that depends from the level of strain caused to the material. The number of specimen life cycles was observed as response in the model.

Mechanical load-cycle and temperature-cycle are varied in phase, meaning that maximum tensile load coincides with the maximum temperature and minimum load is applied at the minimum temperature.

The investigated material is a tool steel used in hot forging (DIN X37CrMoV5-1 – vacuum remelted). Its chemical composition is given in table 1.

Manufacturing of test specimens consists of *machining*, *heat treating* and *grinding*. The achieved hardness is 48-52 HR_C.

TABLE 1

Material's chemical composition (wt %)

C	Si	Mn	Cr	Mo	V
0,36	0,20	0,25	5,00	1,30	0,45

2.6. Screening factorial experiment

The first step of the experimentation consists of a screening experiment, aimed at identifying the significant factors and detecting curvature in response.

Two levels (*low* and *high*) were assigned to each factor, as shown in table 2, and the number of specimen life cycles was observed as the response.

A 2_{III}^{3-1} fractional factorial design was chosen (Berti *et al.*, 2002), because it requires only 4 runs instead of the original 8, that is a one-half fraction of the 2^3 original design. This is a *resolution III design* because main effects are aliased (confounded) with two-factor interactions: no main effect is aliased with any other main effect.

Three center points were added to the plan in order to detect curvature of response, allowing an independent estimate of experimental error.

In performing the experiment, the observations are run in random order, resulting in a completely randomized design.

All trials were run to *failure* which was defined as *complete fracture of the specimen*.

The corresponding model is:

$$N = \beta_0 + \sum_{i=1}^k \beta_i x_i + \sum_{i=1}^k \beta_{ii} x_i^2 + \varepsilon \quad (1)$$

where N is the number of specimen life cycles, x_i is the i -th factor ($i=1, \dots, k$), k is the number of explanatory variables (factors), β_0 is the overall mean effect, β_i are linear effects, β_{ii} are pure quadratic effects and ε is a random error which is assumed to follow a normal distribution with zero mean and variance σ^2 and with i.i.d components.

These assumptions about error were considered plausible according to previous studies (Berti and Monti, 2004).

The interactions $x_i x_j$ are not included in the model because the design is a 2_{III}^{3-1} fractional factorial, so two-factor interactions are aliased with main effects.

Results of analysis of variance, performed on experimental data, are summarized in table 2: main effects and curvature are significant at α -level 0.05.

TABLE 2

Factor levels and p-values associated with main effects and curvature

Design Factors		Factor Levels		p-values
		Low	High	
T_{\max}	[°C]	600	680	0.0018
T_{\min}	[°C]	300	380	0.0017
ϕ	[%]	55	95	0.0017
Curvature				0.0059

In detail, all three effects and curvature are significant because the p-values are less than 0.05. These considerations suggest the use of RSM and a second-order polynomial in order to obtain a more accurate model of specimen life.

2.7. Response surface modelling

In order to quantify the relationship between the measured response (specimen life) and input factors (*maximum temperature cycle*, *minimum temperature cycle* and ϕ), a response surface model was adopted (Montgomery, 2001, Montgomery *et al.*, 2003).

TABLE 3

Number of cycles to failure

Specimen	T_{\max}	T_{\min}	ϕ	N_E
	[°C]	[°C]	[%]	[cycles]
1	600	340	95	8447
2	640	300	55	11844
3	640	340	75	2372
4	640	300	95	396
5	680	340	95	665
6	680	340	55	2050
7	640	380	55	12242
8	600	300	75	11823
9	600	340	55	23887
10	640	340	75	1211
11	680	300	75	379
12	600	380	75	14250
13	640	340	75	1654
14	680	380	75	1147
15	640	380	95	1519

In this study RSM analysis was carried out by employing a 3-factor Box-Behnken design using the same previous factors, but with 3 levels for each factor

(*low*, *medium* and *high*). We chose this design, formed by combining 2^k factorial with incomplete block design, because it is usually very efficient in terms of the number of required runs. The choice to add a level for each factor is useful to add information about the relation between response and factors. New 8 experimental trials were executed. The experimental plan and results in terms of number of specimen life cycles N_E (as obtained from the experimentation) are reported in table 3.

3. RESULTS AND DISCUSSION

3.1. The empirical model

The relationship between the three factors and the response can be approximated by a second-order polynomial model:

$$N = \beta_0 + \sum_{i=1}^k \beta_i x_i + \sum_{i=1}^k \beta_{ii} x_i^2 + \sum_{i < j} \beta_{ij} x_i x_j + \varepsilon \quad (2)$$

where N is the number of cycles to failure, x_i and x_j are the columns of the experimental design corresponding to factor levels, k is the number of variables, β_i and β_{ij} are the model coefficients and ε is the experimental error that we assume to be $N(0, \sigma^2)$. β_{ij} is the interaction effect between x_i and x_j towards the response. Moreover errors are assumed to be i.i.d. Obviously it is unlikely that a polynomial model like this will be a reasonable approximation of the true functional relationship over the entire space of the independent variables, but for a relatively small region it usually work quite well (Montgomery, 2001).

Based on Analysis of Variance (ANOVA) for the response surface quadratic model (table 4), the following statistical tests were performed:

- i. Test for significance of the regression model.* The p-value ($p = 0.0002$) is less than 0.05 so it indicates that the model is significant at $\alpha = 0.05$.
- ii. Test for significance of model coefficients.* In the ANOVA table it is possible to see significant p-values ($\alpha = 0.05$) for the main effects of maximum temperature (T_{\max}) ($p < 0.0001$) and ϕ ($p = 0.0001$), the quadratic effects of maximum temperature (T_{\max}) ($p = 0.0023$) and ϕ (ϕ^2) ($p = 0.0038$), and the interaction of ϕ and maximum temperature (ϕT_{\max}) ($p = 0.0024$).
- iii. Test for lack-of-fit.* The lack-of-fit test compares residual error (from model error) to pure error (from replicated experiments). By analysing the ANOVA table it is possible to see that for the full quadratic model (2), the p-value for lack of fit is 0.12868, which is greater than $\alpha = 0.05$. We conclude that the model adequately fits the response surface.

TABLE 4
ANOVA table for response surface quadratic model

Source of Variation	Sum of Squares	DF	Mean Square	F value	p-value
Model	6.9787E+008	9	7.7541E+007	49.547	0.00023453
T_{\max}	3.6674E+008	1	3.6674E+008	234.34	< 0.0001
T_{\min}	2.7801E+006	1	2.7801E+006	1.7764	0.24009
ϕ	1.9009E+008	1	1.9009E+008	121.46	0.00010706
T_{\max}^2	5.0768E+007	1	5.0768E+007	32.440	0.0023276
T_{\min}^2	7.7208E+006	1	7.7208E+006	4.9334	0.077019
ϕ^2	4.0418E+007	1	4.0418E+007	25.826	0.0038282
$T_{\max} T_{\min}$	6.8807E+005	1	6.8807E+005	0.43966	0.53663
ϕT_{\max}	4.9386E+007	1	4.9386E+007	31.557	0.0024739
ϕT_{\min}	1.3141E+005	1	1.3141E+005	0.083966	0.78362
Residual	7.8250E+006	5	1.5650E+006		
Lack of Fit	7.1384E+006	3	2.3795E+006	6.9315	0.12868
Pure Error	6.8656E+005	2	3.4328E+005		
Total	7.0569E+008	14			

Regression diagnostic was carried out in order to check the model's adequacy:

- i. *Normal Probability Plot* of residuals is useful to check the assumption that the errors are normally distributed. A check on the plot in figure 4 reveals that the residuals follow a straight line and so the errors seem to be normally distributed. We clarify that in this case too many parameters are estimated to justify this as a test. We can consider it as a descriptive approach.

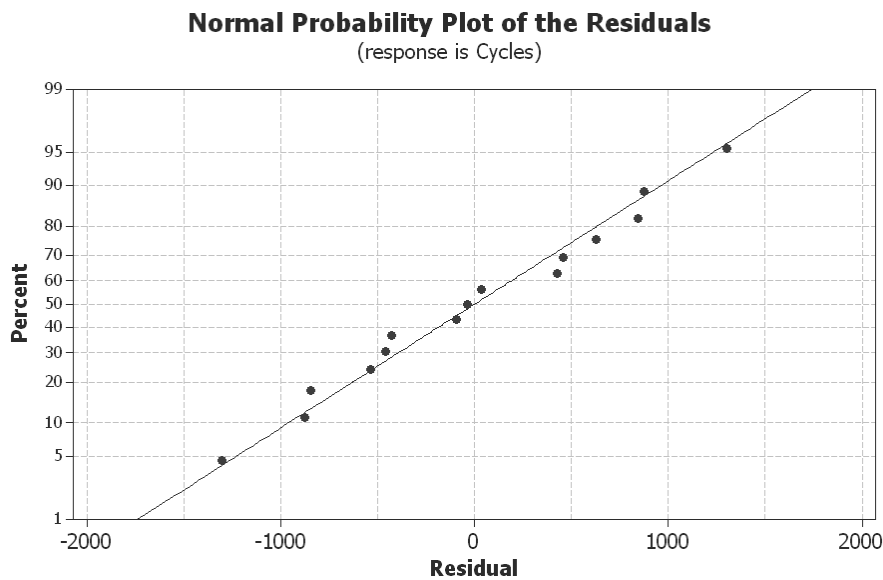

Figure 4 – Normal probability plot of residuals.

- ii. *Coefficient of determination* (R^2) is a measure of the amount of reduction in the variability of response obtained by using all the regressor variables in the model. For the specimen life cycles model $R^2 = 0.98891$ which is a very high value.

The model fitted using the experimental data for the prediction of specimen life is:

$$N = 1.383 \cdot 10^6 - 3377 \cdot T_{\max} - 450.92 \cdot T_{\min} - 4372.5 \cdot \phi + 2.3175 \cdot T_{\max}^2 + 0.90378 \cdot T_{\min}^2 + 8.2714 \cdot \phi^2 - 0.25922 \cdot T_{\max} \cdot T_{\min} + 4.3922 \cdot T_{\max} \cdot \phi + 0.22656 \cdot T_{\min} \cdot \phi \quad (3)$$

3.2. Response surface plots

The surface plots of response surface model as determined above and relevant to the number of cycles are shown in figures 5-7.

The factors that are not on the plot are kept at their average level.

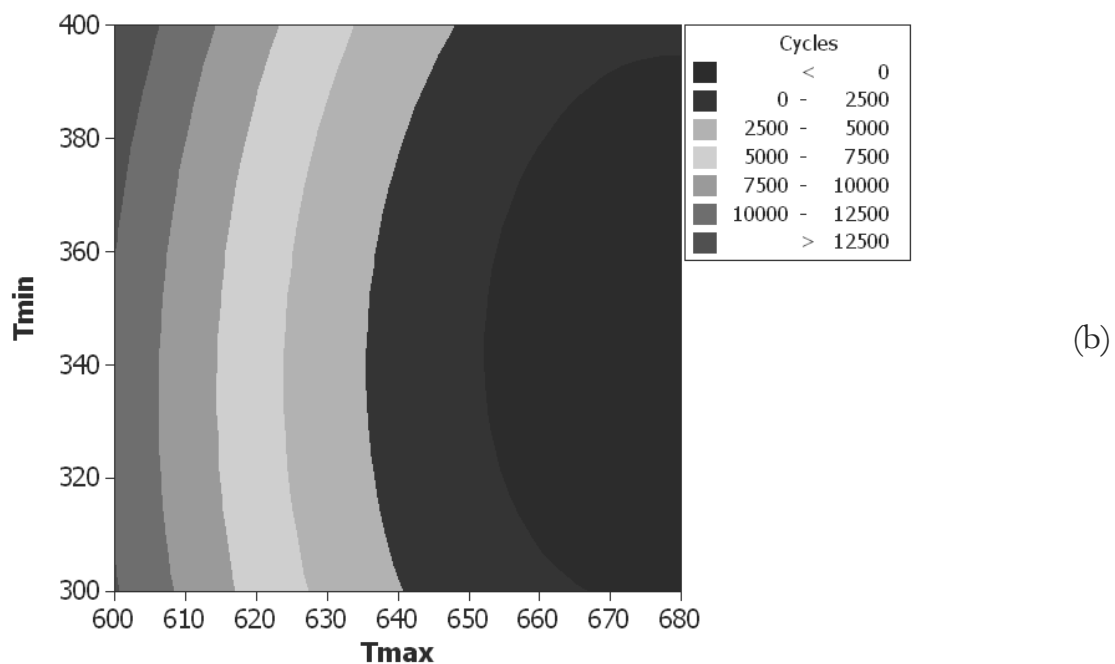
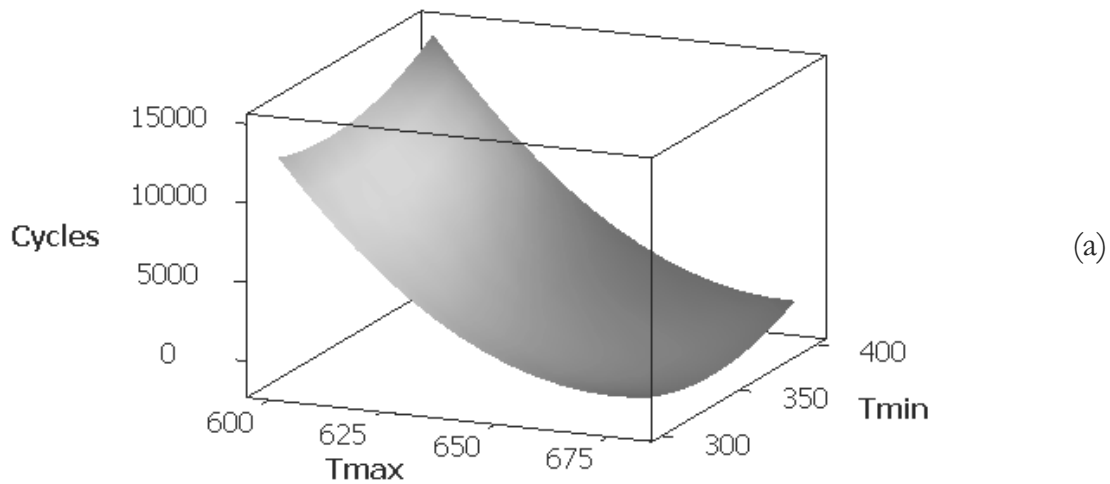

Figure 5 – Response surface (a) and contour plot (b) for the number of cycles to failure as a function of maximum temperature cycle T_{\max} and minimum temperature cycle T_{\min} .

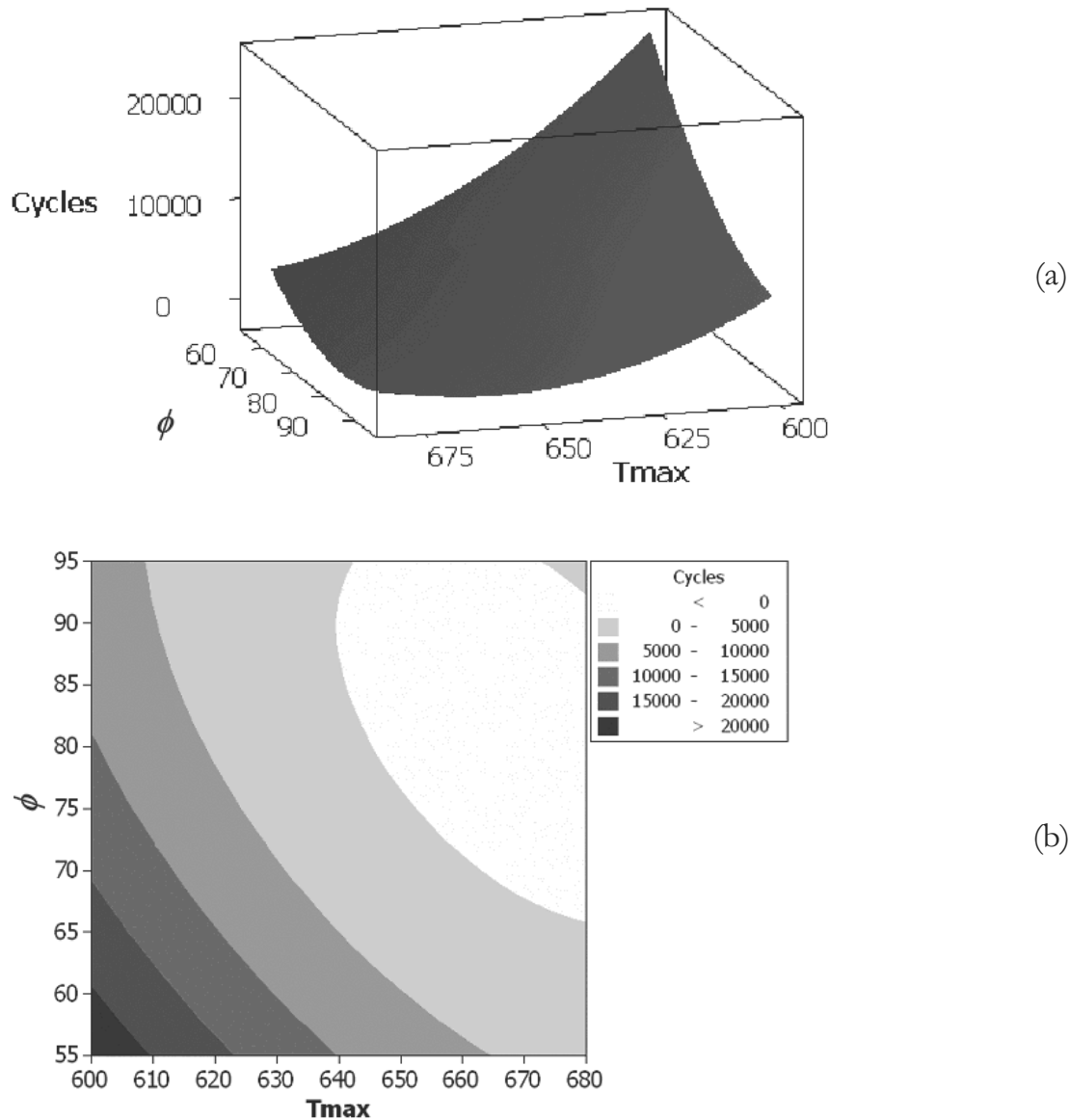

Figure 6 – Response surface (a) and contour plot (b) for the number of cycles to failure as a function of ratio between equivalent stress and yield strength at corresponding temperature ϕ and maximum temperature cycle T_{max} .

It is possible to observe that *i)* all plots present a curvature according to the quadratic model, *ii)* maximum temperature and ϕ equally contribute to reducing the TMF life, and *iii)* increase in minimum temperature from 300 °C to 380 °C contributes to extending lifetime, but changes in response caused by variations in T_{min} are very small.

4. CONCLUSIONS

The thermo-mechanical fatigue behavior of a steel for hot and warm forging die was experimentally investigated. Design of Experiments (DoE) techniques

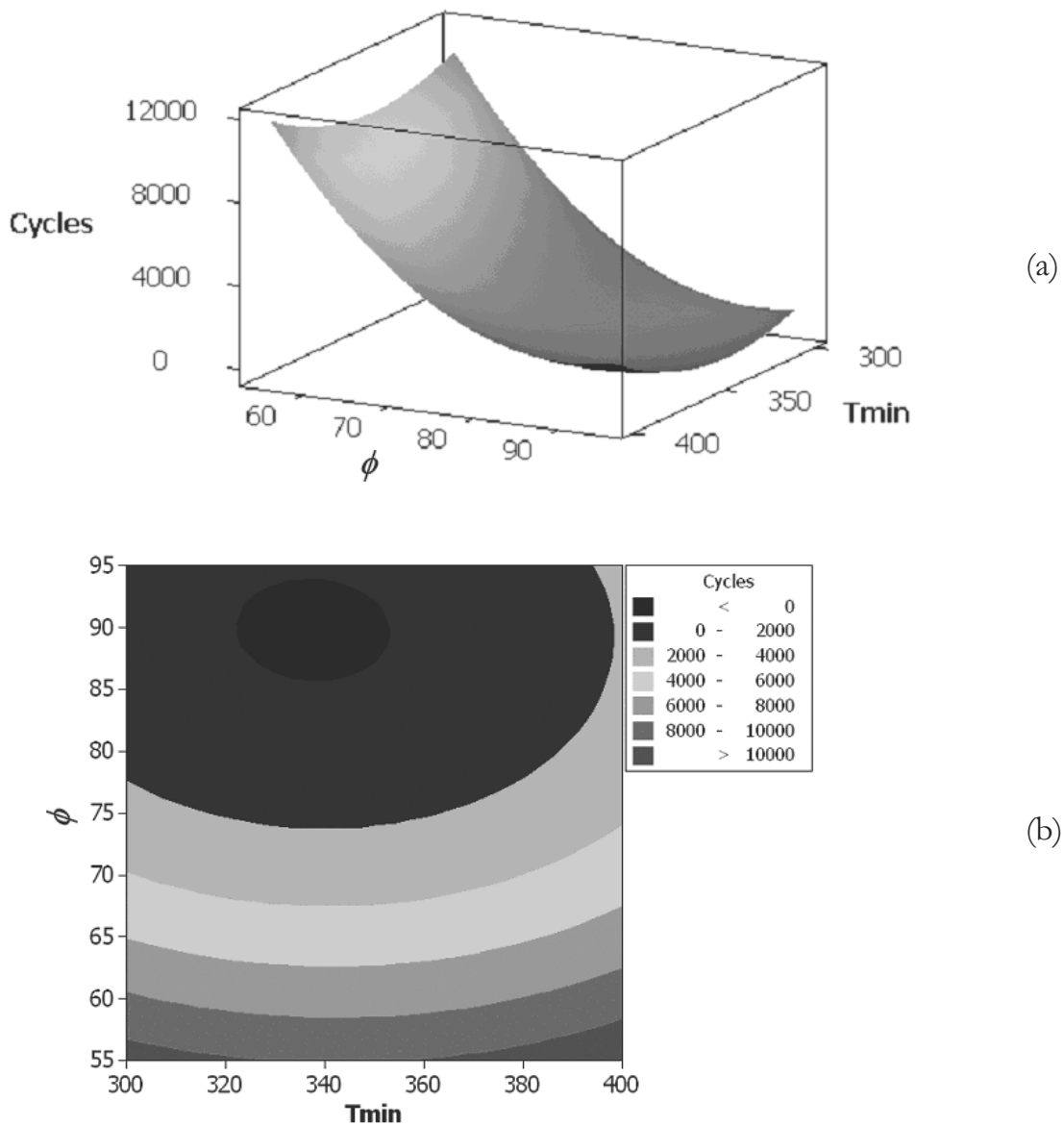

Figure 7 – Response surface (a) and contour plot (b) for the number of cycles to failure as a function of ratio between equivalent stress and yield strength at corresponding temperature ϕ and minimum temperature cycle T_{min} .

were used in designing and analyzing both the screening experiment and the final experimentation based on a Box-Behnken design. Statistical tests were performed to evaluate the adequacy of the regression model obtained by fitting the experimental data, indicating that the proposed model can be used to reasonably predict TMF lives.

A new experimental apparatus was used to generate data to fit a model for TMF lives.

The response surface model detect is an important improvement to knowledge in the field of TMF of forging dies. It is a starting point for use in comparing dif-

ferent forging process alternatives and in defining optimal forging conditions, both of which focus on tool life.

*Dipartimento di Tecnica e Gestione dei Sistemi Industriali
Università di Padova*

GUIDO BERTI
MANUEL MONTI
LUIGI SALMASO

*Dipartimento di Scienze Statistiche
Università di Padova*

STEFANO BONNINI

REFERENCES

- G. BERTI, M. MONTI, L. SALMASO, (2002), *Introduzione alla metodologia DoE nella sperimentazione meccanica*, CLEUP Ed., Padova.
- G. BERTI, M. MONTI, (2003), *A simulative test to investigate the thermo-mechanical fatigue of dies in hot forging*, "Proceedings of VI AITEM", pp. 177-178.
- G. BERTI, M. MONTI, (2004), *Investigation of thermo-mechanical fatigue on a hot forging die steel using a new simulative test*, "Proceedings of 7th ESAFORM CONFERENCE", pp. 679-682.
- J. R. FANG, Q. C. JIANG, Q. F. GUAN, S. Q. WANG, (2001), *The characteristics of fatigue under isothermal and thermo-mechanical load in Cr-Ni-Mo cast hot work die steel*, "Fatigue & Fracture of Engineering Materials & Structures", 25, pp. 481-488.
- K. LANGE, L. CSER, M. GEIGER, J. A. G. KALS, (1992), *Tool life and tool quality in bulk metal forming*, "Annals of the CIRP", 41/2, pp. 667-675.
- D. C. MONTGOMERY, (2001), *Design and analysis of experiments*, 5th Edition, John Wiley & Sons, New York.
- D. C. MONTGOMERY, G. C. RUNGER, (2003), *Applied Statistics and Probability for Engineers*, Third Edition, John Wiley & Sons, New York.
- V. VASQUEZ, M. KHOERR, T. ALTAN, R. SHIVPURI, (1996), *Determination of fatigue properties of dies steels for hot forging*, "Transactions of NAMRI/SME", vol. 24, pp. 155-160.

RIASSUNTO

Modellazione mediante superfici di risposta della fatica termo-meccanica nello stampaggio a caldo

Lo studio dei fenomeni di fatica termo-meccanica (TMF) richiede una complessa sperimentazione, prove molto lunghe e difficoltà nel determinare modelli adeguati. Le tecniche sperimentali solitamente considerano la temperatura nei provini costante e assenza di gradiente termico nella sezione del provino. Queste condizioni sperimentali tuttavia si discostano dalle reali condizioni operative cui sono sottoposti gli stampi durante le operazioni di formatura a caldo e l'obiettivo di replicare le reali condizioni di processo può essere raggiunto solo utilizzando una configurazione sperimentale più complessa.

L'articolo descrive una campagna sperimentale progettata utilizzando tecniche DoE nella quale gli esperimenti sono stati condotti su un nuovo apparato sperimentale in grado di replicare su campioni di materiali per stampi cicli termici e meccanici simili a quelli reali. Lo studio ha consentito di determinare quali fattori influenzano maggiormente la vita a TMF, descrivere la relazione tra vita a TMF e di prevedere la vita a fatica. I dati sperimentali sono stati analizzati utilizzando tecniche RSM al fine di individuare un modello lineare empirico.

SUMMARY

Response surface modelling of thermo-mechanical fatigue in hot forging

Investigation of thermo-mechanical fatigue (TMF) phenomena usually involves complex experimentation and long testing runs, as well as difficulties in specifying and fitting appropriate models. Moreover, the experimental techniques usually consider temperature in the specimen to be constant, or slowly varying, often with a uniform distribution of temperature in the cross section of the specimen but it is not a plausible assumption. Aimed at extending the investigation to hot forging dies, where the variation of some hundreds of °C is operated in a few seconds and thermal gradient (some tens of °C per mm) is present, the experimental configuration become more complex.

The present paper focuses on a recently proposed experiment for a TMF investigation of hot forging dies where Design of Experiments techniques are used to fit a model for TMF lives. This study allows to detect which factors are more important in affecting the TMF, to “describe” the relationship between TMF and these factors and to predict TMF lives. Experimental data are analyzed using Response Surface Modelling (RSM) in order to fit an empirical linear model.