

Refereed Proceedings

Heat Exchanger Fouling and Cleaning:

Fundamentals and Applications

Engineering Conferences International

Year 2003

Retrofitting Crude Oil Refinery Heat
Exchanger Networks to Minimise Fouling
While Maximising Heat Recovery

B. L. Yeap
University of Cambridge

G. T. Polley
Pinchtechnology.com

D. I. Wilson
University of Cambridge

S. J. Pugh
ESDU International Plc

RETROFITTING CRUDE OIL REFINERY HEAT EXCHANGER NETWORKS TO MINIMISE FOULING WHILE MAXIMISING HEAT RECOVERY

B.L. Yeap¹, D.I. Wilson¹, G.T. Polley² and S.J. Pugh³

¹Department of Chemical Engineering, Pembroke Street, Cambridge, CB2 3RA, UK. Email: bly20@cam.ac.uk

²Pinchtechnology.com

³ESDU International Plc, Corsham Street, London N1 6UA, UK.

ABSTRACT

The use of fouling factors in heat exchanger design and the lack of appreciation of fouling in traditional pinch approach has often resulted badly designed crude preheat networks that are expensive to maintain. The development of thermal and pressure drop models for crude oil fouling has allowed its effects to be quantified, so that techno-economic analyses can be performed and various design options compared. Application of these fouling models is carried out on two levels: on the assessment of adding extra area to individual exchangers, and the design of a complete network using the Modified Temperature Field Plot. Application to a refinery case study showed that both at the exchanger and network levels, designing for maximum heat recovery using traditional pinch approach results in the least efficient heat recovery over a time period when fouling occurs.

INTRODUCTION

Fouling in crude oil preheat trains is a major problem that costs the industry billions of dollars per year (ESDU, 2000). The two main impacts of fouling on preheat train operation are reduced heat recovery and increased pressure drop. For a unit processing 100 kbbbl/day, a drop of 1 K due to fouling will result in approximately US\$ 40k of added fuel cost and 750 te of additional carbon dioxide each year (Yeap *et al.*, 2001). On both economic and environmental grounds, there are large incentives to minimise fouling while maximising heat recovery in these systems.

Larger pressure drops impose greater loads on the pumps, and where extra capacity is not available, results in vaporisation of the crude within heat exchangers rather than the furnace and reduced throughput. Subsequent production losses are possibly the most significant cost of fouling for most refineries. For a throughput-limited refinery processing 100,000 bbl/day, a 10% loss of production due to increased pressure drop would cost US\$ 20,000 per day, assuming \$ 2 /bbl for marginal lost production. In many refinery operations, the pressure drop problem can be more severe than reduced heat recovery.

The dynamic behaviour of fouling has hindered the proper application of many energy integration techniques to preheat train design. Conceptual approaches such as pinch analysis assume that the system operates under steady state, and incorporate fouling by oversizing heat exchangers on the basis of fouling factors. Rigorous numerical design methods have usually omitted fouling behaviour considerations. Both techniques treat fouling as an afterthought, something that has to be dealt with when performance decreases and restorative actions are required. Traditional energy integration techniques favour high heat exchanger surface temperatures in order to achieve what is called 'vertical alignment' of the matches in the composite curves. Furthermore, splitting the crude stream is encouraged as it is the only cold stream and needs to be contacted by many hot streams. Where pump-around streams are used as a source of heat, exchanger bypasses on the crude side are necessary to maintain a fixed duty. This results in lower crude flow rates in the heat exchangers.

Chemical reaction fouling, where deposition is caused by species generated through chemical reactions in the bulk fluid, viscous sublayer or tube walls, is the dominant fouling mechanism in crude oil preheat trains (Watkinson and Wilson, 1997). Chronic chemical reaction fouling is very sensitive to high wall temperatures and low flow velocities. The network designs proposed by traditional energy integration approaches are, therefore, likely to suffer severe fouling. Alternative approaches must therefore incorporate models for fouling behaviour, to identify and avoid those conditions which promote significant fouling.

Yeap *et al.* (2001) reported how thermo-hydraulic models, featuring semi-empirical relationships but fitted against available fouling data, can be incorporated into existing design methods to generate designs which are robust towards fouling. This paper summarises work undertaken since the concepts were introduced there.

THERMAL FOULING MODELS

There are several quantitative models for chemical reaction fouling in the literature. Most of these feature a

competition between deposition and removal/hindrance terms. A noteworthy exception is that of Epstein (1994), where the mitigation effect is included in the deposition term: the velocity-maxima trends exhibited by Crittenden *et al.*'s (1987) data for polymerisation fouling from styrene in kerosene have been successfully explained by Epstein's model. Rose *et al.* (2000) and Wilson and Watkinson (1996) have shown that this model can be used to adequately characterise other cases of chemical reaction fouling, namely whey protein and autoxidation fouling, respectively.

A less rigorous modeling concept which has been developed for tubeside crude oil thermal fouling is the threshold fouling approach introduced by Panchal and co-workers (1995, 1997). This has been extended by Yeap and co-workers (Polley *et al.*, 2002, and Yeap *et al.*, 2003). The latter work proposes a model with a removal term and a deposition term based on Epstein's, of the form:

$$\frac{dR_f}{dt} = \frac{A C_f u T_s^{2/3} \rho^{2/3} \mu^{-4/3}}{1 + B u^3 C_f^2 \rho^{-1/3} \mu^{-1/3} T_s^{2/3} \exp\left(\frac{E}{RT_s}\right) - C u^{0.8}} \quad (1)$$

where A , B , C are groups of parameters, E is an activation energy and u is the tubeside mean velocity. This model was compared against several published sets of pilot plant and refinery exchanger operation data for crude oil fouling and was found to describe the observed fouling trends more closely than earlier models. The form of the denominator enables this model to describe data sets where mass transfer dominate and fouling increases with flow rate – which arises in a small number of data sets.

The threshold fouling concept assumes that a fouling model whose parameters are based on observed fouling rates can be extrapolated back to yield operating conditions where the fouling rate will be negligibly small or zero. Equation (1) was applied to the data set for crude oil exhibiting thresholds reported by Knudsen *et al.* (1997) and, like the Polley *et al.* model, predicted the threshold reasonably well. There is therefore some confidence that these models, with parameters generated from fouling rate data, can give reasonable estimates of zero-fouling conditions, or conditions under which deposition will be negligibly small.

The hydraulic effects of fouling have not received much attention in hydrocarbon literature (*cf.* dairy applications, *e.g.* Visser *et al.*, 1997) yet this effect is critical in preheat trains that are throughput-limited. In particular, retrofitting these networks requires a clear understanding of the relationship between thermal and hydraulic effects, since the best retrofits in general tend to maximise the use of available equipment such as pumps (Ahmad and Polley, 1991).

HYDRAULIC (PRESSURE DROP) MODELS

Fouling affects pressure drop by (i) constriction of the flow area due to growth of deposit layers; (ii) increasing roughness of the surface, and (iii) tube blockages, which results in increased flow velocities in other tubes, hence greater pressure drop. To map the relationship between thermal and hydraulic effects of fouling, pressure drop models representing each of the above mechanisms have been developed. It is acknowledged that preheat train pressure drop is most likely caused by a combination of the above factors, but separation of the individual components is likely to contain substantial uncertainty.

It can be shown (Yeap *et al.*, 2003) that the overall heat transfer coefficient, U , for the constant mass flow rate scenario, is given by

$$\frac{1}{U} = R_{ext} + \frac{r_1}{\lambda_f} \ln\left(\frac{r_1}{r_i}\right) + \frac{1}{h_1} \left(\frac{r_i}{r_1}\right) \left(\frac{C_{f,1}}{C_{f,i}}\right) \quad (2)$$

which can be expressed as a dimensionless fouling Biot number $Bi_f \equiv R_f \times h_1$

$$Bi_f = -Y \ln\left(1 - \frac{\delta}{r_1}\right) + \left[\left(\frac{C_{f,1}}{C_{f,i}}\right) \left(1 - \frac{\delta}{r_1}\right) - 1\right] \quad (3)$$

where $Y \equiv r_1 h_1 / \lambda_f$; r_1 is the clean tube radius, h_1 is the clean tubeside heat transfer coefficient and λ_f is the foulant thermal conductivity. Y is the ratio of convective and conductive resistances; hence it varies strongly with the properties of the deposit.

Equation (3) indicates that as the roughness of the fouling layer increases, Bi_f decreases due to enhanced heat transfer. This effect was observed experimentally by Crittenden *et al.* (1987) and Wilson and Watkinson (1996) at the start of their experiments, when the change in roughness from clean surface to fouled layer was significant. Equation (3) implies that R_f cannot be mapped directly to ΔP solely on the basis of roughness alone. In the following models, fouling is assumed to be present on the tube-side alone.

Model A: Duct Reduction Effect

Here, the friction factor is assumed to remain constant, yielding the following relationship between Bi_f and ΔP^* ($\equiv \Delta P / \Delta P_1$):

$$\Delta P^* \equiv \frac{\Delta P}{\Delta P_1} = \left(1 - \frac{Bi_f}{Y}\right)^{-5} \quad (4)$$

Model B: Roughness Effect

One would expect the roughness of the fouling layer to increase initially as deposit accumulates on the tube surface. Hence the foulant layer friction factor $C_{f,i}$ was modeled with a sand roughness, e , value of 0.12 mm, as suggested by Kern (1988) for bitumen coatings, giving

$$\Delta P^* \equiv \frac{\Delta P}{\Delta P_1} = \frac{C_{f,i}}{C_{f,tube}} \left(1 - \frac{Bi_f}{Y}\right)^{-5} \quad (5)$$

Model C: Tube Blockage

Tube blockage causes tubes to be out of service, resulting in loss of heat transfer area. In the constant throughput scenario, the velocity in the remaining tubes would increase, partially compensating for the loss of heat transfer area. A full derivation of the blocked-tube model is presented elsewhere (Yeap *et al.*, 2003). The form of the model for constant throughput is

$$\Delta P^* \approx (1 + Bi_{f,U})^{3.15} \quad (6)$$

where $Bi_{f,U} \equiv R_f \times U_1$

These pressure drop models rely heavily on assumed deposit distributions within exchange tubes. With the exception of studies such as that by Thompson and Bridgwater (1992), deposition distribution is rarely reported. A second major assumption is that of uniform

foulant thermal conductivity, *i.e.* zero or rapid ageing. Atkins (1962) reported that crude deposits tend to experience ageing (coking) with time, which will also depend on temperature.

APPLICATION: REFINERY CASE STUDY

Data were provided by a UK refinery which processes mainly light to medium North Sea crudes. The preheat system for a distillation unit features two separate trains operating in parallel. Data reconciliation was performed on data provided over a four year period, modeling thermal fouling data from individual exchangers after the desalter with equation (1) and overall pressure drop data with all three hydraulic models. It is noteworthy that one train featured consistent injection of caustic into the crude over one period, and the parameters obtained from data reconciliation for this period were found to deviate significantly from the other sets. The layout of the preheat train under consideration is shown in Figure 1 and details of individual exchangers are summarised in Table 1. The train processes on average 105 kg/s (120,000 bbl/day) of crude oil and recovers approximately 55 MW when clean.

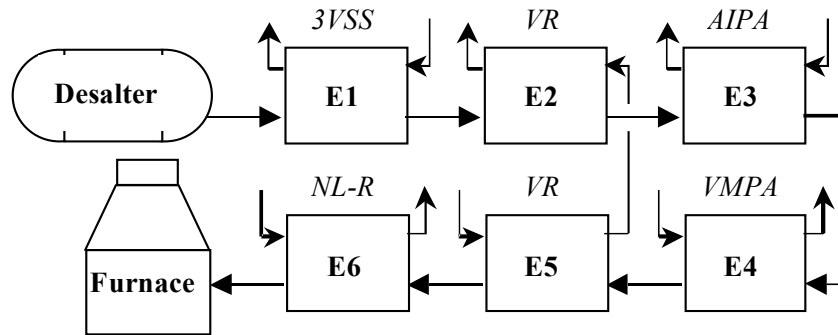

Figure 1: Schematic of refinery preheat train. VSS - vacuum side-stream; VR - vacuum residue; AIPA - atmospheric pumparound; VMPA; vacuum mid-pumparound; NL-R - non-lube residue

Table 1: Preheat train data and performance when clean

Stream	E1		E2		E3		E4		E5		E6	
	Crude	3VSS	Crude	VR	Crude	AIPA	Crude	VMPA	Crude	VR	Crude	NL-R
<i>M</i> (kg/s)	105	13	105	18	105	70	105	106	105	18	105	52
<i>T_{in}</i> (°C)	120	215	127	240	147	267	203	284	222	301	232	304
<i>T_{out}</i> (°C)	127	150	147	163	203	189	222	253	232	240	253	248
<i>u</i> (m/s)	2.0		1.0		1.4		1.5		1.2		1.1	
<i>Q</i> (MW):	1.8		5.4		16.2		5.6		3.1		7.2	
Passes:	2		2		2		2		2		2	

Regression analysis yielded the following parameters

$$\begin{aligned} A &= 9.0 \times 10^{-7} \text{ kg}^{2/3} \text{ K}^{1/3} \text{ m}^{5/3} / (\text{kW}) \text{ s}^{1/3} \text{ h} \\ B &= 3.5 \times 10^{-4} \text{ m}^{13/3} \text{ s}^{8/3} \text{ kg}^{2/3} / \text{K}^{2/3} \\ C &= 2.0 \times 10^{-9} \text{ m}^{6/5} \text{ K} \text{ s}^{4/5} / \text{kW h} \\ E &= 86 \text{ kJ/mol} \end{aligned}$$

which indicated that fouling was reaction, not mass transfer, controlled. Agreement with the model was not evenly distributed, and the average percentage deviation was 121 %. This degree of mismatch was not unexpected, given the scatter in the fouling data and the uncertainty in input data. Crude physical parameters were estimated from averages for a medium crude, as the refinery crude slate varied regularly and physical properties were not available. These factors illustrates the degree of uncertainty found in refinery fouling modelling, and the consequent need to use simpler models and perform uncertainty analyses. The flow rate of crude is another source of uncertainty as it varies and the accuracy of measurement is limited.

Model A was found to give the best agreement for the overall network pressure drop, indicating that duct reduction is the dominant effect in this instance. Regression indicated e values in the range 0.05 mm to 0.25 mm and deposit thermal conductivity values of 0.29 – 0.88 W/m K, which are consistent with Watkinson (1988).

Economic Evaluation Criteria

The main goal of this study is to determine the most profitable structure of the crude oil preheat train and its operating conditions. This includes identifying stream matches that yield the greatest heat recovery without incurring excessive performance deterioration due to fouling. In order to evaluate and compare alternative retrofit options, an economic criterion has to be defined. The total cost of the preheat train, C_{PHT} , is the sum of investment cost including annual depreciation, C_{INV} , and annual operating costs, C_{OP} , viz.

$$C_{\text{PHT}} = C_{\text{INV}} + C_{\text{OP}} \quad (7)$$

Costs are expressed in US\$ p.a. The annual investment cost of the network is determined by straight-line depreciation applied to the installed exchanger cost (Gerrard, 2000) with $\$1 = \$\text{US } 1.6$, from

$$C_{\text{INV}} = f_D \cdot 1120 \cdot \sum_{i \in \text{HEN}} A_i^{0.83} \quad (8)$$

where A_i is the area of exchanger i and f_D is the annual depreciation rate (taken as the standard fraction, of 0.33 per year, Gerrard, 2000).

The annual operating cost is based on energy and lost throughput. Furnace heating costs around \$k 50 per 1 K drop in furnace inlet temperature, FIT , over one year for a train processing 120 kbbbl/day, given a fuel cost of \$13 /GJ. Cooling water is charged at \$2.5 /GJ. Loss of production is

levied at \$2 /bbl of marginal lost production, costing \$k 24 per day for a 10% loss on a 120 kbbbl/day refinery.

Assessing Adding Extra Area

Before network retrofit is considered, it is interesting to investigate the effect of a marginal increase in heat recovery on fouling and network pressure drop for the original configuration. Chemical reaction fouling, which is the dominant fouling mechanism in the hottest exchangers, is sensitive to temperature and somewhat less sensitive to flow velocity. This creates a quandary for the designer: the aim of the preheat train is to maximise heat recovery, yet the more heat that is recovered, the higher the crude stream temperature and hence greater fouling, which deteriorates network performance over time. Hence the aim of this exercise is to determine whether an optimum furnace inlet temperature exists, in which heat recovery and throughput can be maximised over time.

The hottest heat exchanger in the train, here is E6, is simulated over a 2 year period, taken to be representative of periods between cleaning. All units are assumed to be clean initially. Increasing heat transfer is achieved by increasing the number of transfer units, NTU , whilst keeping the flow velocity constant. Figure 2(a) shows the relationship between furnace inlet temperature, pressure drop and NTU under clean conditions, while Figure 2(b) shows the performance after 2 years of operation. Fouling rates were calculated at the arithmetic mean of the surface temperatures at the inlet and outlet of the exchanger. The plots show that the increase in heat transfer decreases as the exchanger size exceeds twice its original value, while the pressure drop increases linearly. After 2 years, FIT has fallen about 10 K across the range, while the increase in pressure drop is significantly larger for the smaller units. The large decrease in FIT indicates that several of these exchangers are operating at conditions far from their respective threshold values.

The associated *net cost savings* plotted in Figure 3 have been estimated by subtracting the annualised investment cost for the extra heat exchanger area from the operating cost savings calculated from shown in Figure 2. Network performance over time was simulated using lumped parameter models written in Mathematica™. The net cost savings exhibit a weak maximum and almost asymptotic limit with increase in exchanger size for the constant throughput scenario. The optimum value of k\$ 752 p.a. is attained for an NTU value of E6 is 4.5, which gives a clean FIT of ~258 °C and a 2-year value 248.5 °C (cf. base case $NTU = 2.0$; clean $FIT = 253$ °C and after 2 years = 243 °C). Further investment on additional area in E6 would prove counter-productive, as the increased heat recovery would promote more severe fouling, rendering the extra area useless within 2 years, as well as higher pressure drop.

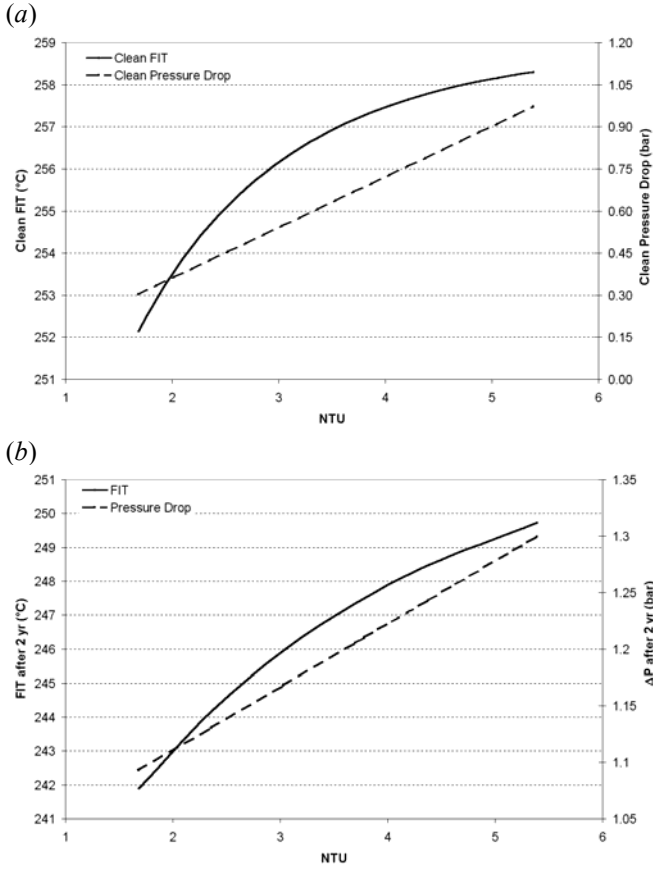

Figure 2 Performance of E6 with enhanced surface area. Constant throughput scenario: (a) Initial, clean, conditions; (b) after 2 years.

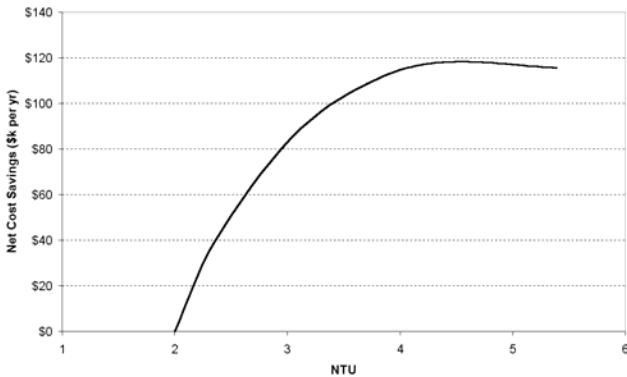

Figure 3 Effect of added area on net cost savings, constant throughput scenario

The alternative scenario, where throughput is allowed to vary, is considered by assuming that the network operates at constant pumping power W . The throughput, M , is linked to the network pressure drop, ΔP , by

$$W = \Delta P \cdot (M/\rho) \quad (9)$$

Figure 4 shows how FIT and M vary with NTU in this scenario. The maximum pump capacity was chosen to be just large enough to provide the clean pressure drop for the largest exchanger ($NTU = 5.5$) at the initial flow rate of 105 kg/s. After 2 years the FIT is noticeably higher than in the constant throughput scenario. This is because as M decreases, the overall rate of heat transfer decreases but the low flow rate responds by reaching a higher temperature. In calculating the *net cost savings*, production losses are included and were found to be an order of magnitude larger than the fuel cost savings. The results are plotted in Figure 5 and indicate a stark penalty due to fouling.

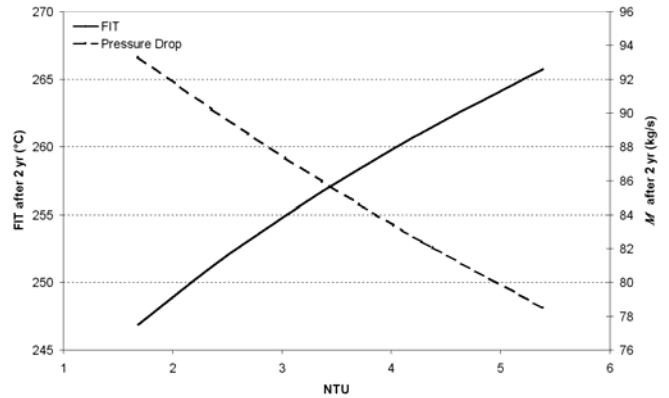

Figure 4 Performance of E6 with enhanced surface area after 2 years operation, constant W scenario.

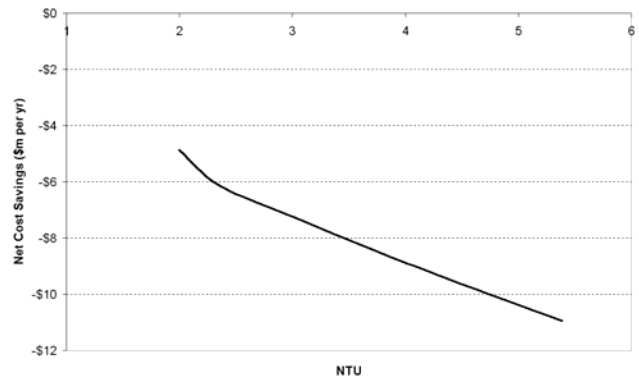

Figure 5 Effect of added area on net cost savings, constant W scenario.

CASE STUDY: RETROFIT DESIGN

The previous section has shown that the optimum clean FIT value for the preheat train operating at constant throughput is around 258 °C. At this condition, the capital investment in extra heat exchanger area gives extra energy recovery without incurring excessive fouling. The weakness of the optimum is very important for the designer, as it indicates that there is leeway to take other design factors into consideration. In retrofit design, this flexibility is even more vital than in green-field design.

Retrofit Method A

The base case FIT is 253 °C. A standard pinch technology approach for increasing this value is to first design the system as a new minimum energy requirement network. The next stage is to reuse any of the current exchangers in the new network. Since the target FIT is only 5 °C higher than the present one, many of the heat exchangers in the current network will be able to perform their new roles without modification. Any new exchangers can be designed to minimise fouling by exploiting pump capacities and network idiosyncrasies (Wilson and Polley, 2001).

This retrofit technique, labeled Retrofit A, can be viewed as a macro-to-micro design approach, as the process design is considered before the equipment design. This approach is reminiscent of traditional pinch analysis. The key steps are:

(i) Design for minimum energy requirement (MER);

(ii) Attempt to reuse current exchangers in the new network;

(iii) Exploit the current network so as to design new exchangers that suppress fouling.

Figure 6 shows the network obtained by applying this approach to the case study. The capital investment is quite substantial as 4 new exchangers are introduced to increase heat recovery from the vacuum residue and non-lube residue streams. The clean FIT value is higher, at 278 °C, which corresponds to the minimum utility requirement target for the system. However, severe fouling is now anticipated since the downstream exchangers are now operating at a higher temperature region. Information from the fouling models has not been utilised before this point. The models could be used to specify operating conditions for individual exchangers which would mitigate fouling, but these are likely to specify very high pressure drops (large u) as the temperature conditions are effectively fixed.

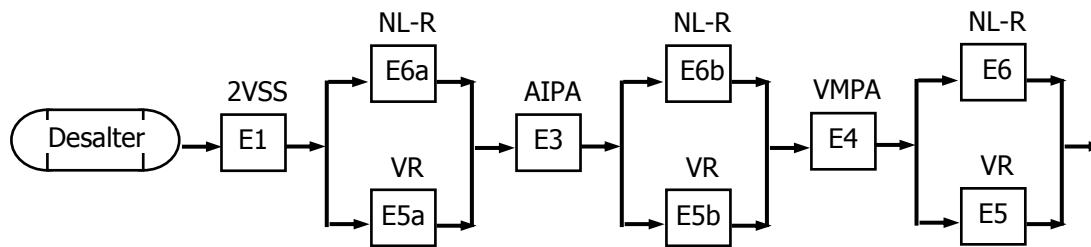

Figure 6 Retrofit design for case study network obtained using Method A

Retrofit Method B

An alternative approach to retrofitting fouling preheat trains is to use the Modified Temperature Field Plot, introduced and described by Yeap *et al.* (2001). This graphical construction allows the designer to consider the effect of a set of temperature and velocity conditions on thermal fouling and pressure drop behaviour. Figure 7 shows the Plot for the case study. It is evident that most of the exchangers operate in the region above the threshold line corresponding to their flow velocity, so fouling cannot be eliminated completely. The resulting methodology, labeled Retrofit B, can be summarised as follows:

- (i) Use the Field Plot to determine operating temperatures and velocities that will suppress fouling;
- (ii) Attempt to revamp the fouling exchangers to the desired operating conditions; doing so will most likely result in an overly large network pressure drop;
- (iii) Relax the velocity criteria on some exchangers to tolerate some fouling in order to satisfy the pump constraint.

For the case study, the layout of the preheat train remains the same, but the flow velocities in the hotter exchangers are increased. The FIT of the network has increased slightly, but we do not anticipate much fouling since the higher velocities will suppress deposition in the heat exchangers.

Figure 8 shows the results from network simulations after 2 years of operation. Retrofit A initially gives the highest FIT because it is an MER design but it is subject to severe fouling and gives the lowest heat recovery after 2 years. Retrofit B features a higher initial network pressure drop as most of the heat exchangers are operating at higher velocities to suppress fouling. FIT for this network remains high after two years, and the *change* in network pressure drop is the smallest since fouling is under control. Retrofit B is therefore more robust towards fouling.

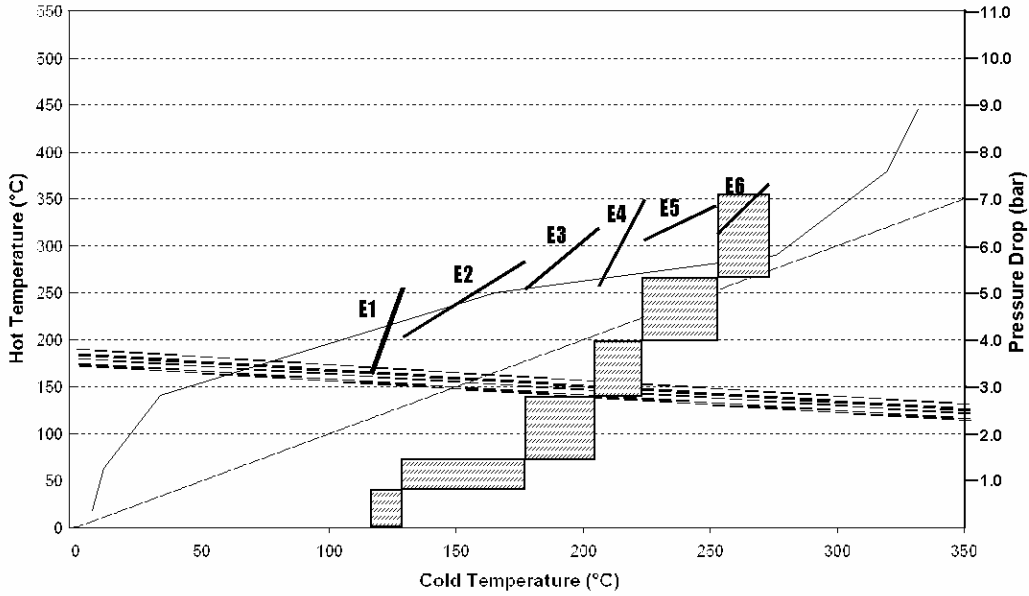

Figure 7: Modified temperature field plot for the case study network *before modification*

Dashed lines show threshold temperature conditions for velocities ranging from 1.0 m/s to 2.0 m/s. Bold lines show the temperature matches in individual exchangers, plotted here in terms of hot tube surface and cold bulk temperatures. Solid line indicates hot composite curve. Boxes indicate the pressure drop across individual exchangers in clean condition; the boxes sum to give the overall pressure drop across the network.

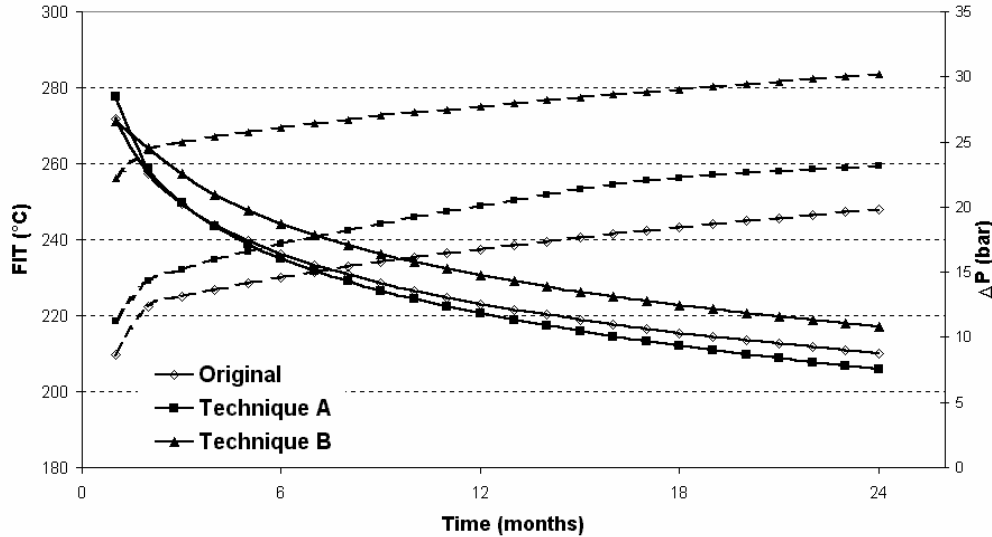

Figure 8 Performance of network designs over two years of operation.

Solid lines - FIT; dashed lines - pressure drop

CONCLUSIONS

Assessment of incremental modifications to individual heat exchangers has shown that there exists an optimum crude outlet temperature that corresponds to maximum heat recovery while minimising fouling in the unit. This optimum crude outlet temperature, however, is a plateau rather than a sharp peak, indicating a wide design space for exchanger configurations at conditions typically found in a preheat train. When throughput reduction occurs due to

fouling in a hydraulic-limited network, no optimum is observed, and for each incremental increase in area, fouling is more severe and throughput reduction reduces the cost benefits of extra heat transfer area. In network retrofit, application of the fouling models using the Modified Temperature Field Plot indicated that designing a network for maximum heat recovery (traditional pinch approach) does not give rise to a network that is robust against fouling, and the subsequent deposition results in a less efficient network over the time period when fouling occurs.

ACKNOWLEDGEMENTS

Funding and support from ESDU International plc, Cambridge Commonwealth Trust and Trinity College, Cambridge is gratefully acknowledged, as are support and discussions with DM and colleagues at the refinery.

NOMENCLATURE

A	coefficient in (1), $\text{kg}^{2/3}\text{K}^{1/3}\text{m}^{5/3}/(\text{kW})\text{s}^{1/3}\text{h}$
B	coefficient in (1), $\text{m}^{13/3}\text{s}^{8/3}\text{kg}^{2/3}/\text{K}^{2/3}$
Bi_f	fouling Biot number based on h_i
$Bi_{f,U}$	fouling Biot number based on U
C	coefficient in (1), $\text{m}^{6/5}\text{K}\text{s}^{4/5}/\text{kW}\text{h}$
C_f	Fanning friction factor, -
C_{INV}	annual investment cost, US\$ p.a.
C_{OP}	annual operating cost, US\$ p.a.
C_{PHT}	total cost of preheat train, US\$ p.a.
E	activation energy in (1), kJ/mol
h_i, h_1	tubeside h.t.c.; fouled, clean, $\text{kW}/\text{m}^2\text{K}$
M	mass flowrate, kg/s
NTU	number of transfer units, -
$\Delta P, \Delta P_1$	pressure drop; fouled and clean conditions, Pa
ΔP^*	pressure drop ratio, -
Q	heat exchanger duty, MW
R_{ext}	sum of external fouling resistance, $\text{m}^2\text{K}/\text{kW}$
r_i, r_1	inner tube diameter; fouled and clean, m
R_f	fouling resistance, $\text{m}^2\text{K}/\text{kW}$
t	time, h
T_{in}, T_{out}	inlet/outlet bulk stream temperature, $^{\circ}\text{C}$
T_s	surface temperature, K
u	mean tubeside velocity, m/s
U	overall heat transfer coefficient, $\text{W}/\text{m}^2\text{K}$
W	pumping power, kW
Y	dimensionless group, -
δ	thickness of foulant layer, m
λ_f	foulant thermal conductivity, $\text{W}/\text{m}\text{K}$
μ	dynamic viscosity, $\text{kg}/\text{m}\text{s}$
ρ	density, kg/m^3

REFERENCES

- Ahmad, S. and Polley, G.T., 1990, Debottlenecking of heat exchanger networks, *J. Heat Recovery & CHP*, 10(4), pp 369-385.
- Atkins, G.T., 1962, What to do about high coking rates, *Petro/Chem Engineer*, Vol. 34, pp 20-25.
- Crittenden, B.D., Hout, S.A. and Alderman, N.J. 1987, Model experiments of chemical reaction fouling, *Chem. Eng. Res. Des.*, 65, pp 171-179.
- Ebert, W.A. and Panchal, C.B., 1995, Analysis of Exxon crude-oil slip stream coking data, in *Fouling Mitigation of Industrial Heat Exchange Equipment*, Panchal, C.B., Bott, T.R., Somerscales, E.F.C. and Toyama, S. (eds.), Begell House, NY, pp 451-460.
- Epstein, N., 1994, A model of the initial chemical reaction fouling rate for flow within a heated tube, and its verification., *Proc. 10th Int. Heat Trans. Conf.*, Brighton, IChemE, Vol. 4, pp 225-229.
- ESDU, 2000, Heat exchanger fouling in the preheat train of a crude oil distillation unit, ESDU Data Item No. 00016, ESDU International plc, London.

Gerrard, A.M., 2000, *Guide to capital cost estimating*, 4th Edition, publ. IChemE, Rugby.

Kern, D.Q., 1988, *Process Heat Transfer*, McGraw-Hill, NY.

Knudsen, J.G., Lin, D. and Ebert, W.A., 1997, The determination of the threshold fouling curve for a crude oil, in: Bott, T.R., Melo, L.F., Panchal, C.B. and Somerscales, E.F.C. (eds.), *Understanding Heat Exchanger Fouling and its Mitigation*, Begell House, NY, pp 265-272.

Panchal, C.B., Kuru, W.C., Liao, C.F., Ebert, W.A. and Palen, J.W., (1997) 'Threshold conditions for crude oil fouling', in: eds. Bott, T.R. et al. (eds.), *Understanding Heat Exchanger Fouling and its Mitigation*, Begell House, pp 273-281.

Polley, G.T., Wilson, D.I., Yeap, B.L. and Pugh, S.J. 2002, Evaluation of laboratory crude oil fouling data for application to refinery pre-heat trains, *Applied Thermal Engineering*, Vol. 22, pp 777-788.

Rose, I.C., Watkinson, A.P. and Epstein, N., 2000, Testing a mathematical model for initial chemical reaction fouling using a dilute protein solution, *Can J. Chem Eng.*, Vol. 78(1), pp 5-11.

Thompson, D.C. and Bridgwater, J., 1992, Plant demonstration of a technique to measure local thermal resistance, *Proc. Heat Transfer Conf.*, IChemE Symposium Series No. 129, IChemE, Rugby, pp 979-985.

Visser, H., Jeurnink, Th.J.M., Schraml, J.E., Fryer, P.J. and Delplace, F., 1997, *Fouling and cleaning of heat transfer equipment*, (ed.) Visser, H., IDF Bulletin 328, publ. IDF, Brussels, pp 10-18.

Watkinson, A.P., 1988, Critical review of organic fluid fouling, *Final report AWL/CNSV-TM-208*, Argonne National Laboratory, Argonne.

Watkinson, A.P. and Wilson, D.I., 1997, Chemical reaction fouling - a review', *Engineering and Thermal Sciences*, Vol. 14, pp 361-374.

Wilson, D.I. and Polley, G.T. (2001) "Mitigation of refinery preheat train fouling by nested optimisation", *Advances in Refinery Fouling Mitigation Session #46*, AIChE, Houston, pp 287-294.

Wilson, D.I. and Watkinson, A.P., 1996, A study of autoxidation fouling in heat exchangers, *Can. J. Chem. Eng.*, Vol. 74, pp 236-246.

Yeap, B.L., Wilson, D.I., Polley, G.T. and Pugh, S.J. 2001, Incorporation of fouling models into the design of heat transfer networks, in: Müller-Steinhagen, H. (eds.), *Heat Exchanger Fouling: Fundamental Approaches and Technical Solutions*, Davos, Jul 2001, Publico Publications, Germany, pp 243-248.

Yeap, B.L., Wilson, D.I., Polley, G.T. and Pugh, S.J. 2003, Mitigation of crude oil refinery heat exchanger fouling through retrofits based on thermo-hydraulic models, *Chem. Eng. Res. Des.*, in press.