

RF QUADRUPOLE BEAM DYNAMICS DESIGN STUDIES\*  
 K. R. Crandall, R. H. Stokes, and T. P. Wangler  
 Los Alamos Scientific Laboratory  
 Los Alamos, New Mexico 87545

Summary

The radio-frequency quadrupole (RFQ) linear accelerator structure is expected to permit considerable flexibility in achieving linac design objectives at low velocities. Computational studies show that the RFQ can accept a high-current, low-velocity, dc beam, bunch it with high efficiency, and accelerate it to a velocity suitable for injection into a drift-tube linac. Although it is relatively easy to generate a satisfactory design for an RFQ linac for low beam currents, the space-charge effects produced by high currents dominate the design criteria. Methods have been developed to generate solutions that make suitable compromises between the effects of emittance growth, transmission efficiency, and overall structure length. Results are given for a test RFQ linac operating at 425 MHz.

Introduction

Soon after the linear accelerator was invented, searches began for methods to circumvent the incompatibility between longitudinal and radial stability. The use of drift-tube foils or grids, externally applied fields, and alternating phase focusing have met with success in specific areas of application. However, each of these solutions has serious disadvantages, particularly in the acceleration of low-velocity ions. Since 1956, there have been suggestions that linear accelerator electric fields could be used for radial focusing as well as for acceleration.<sup>1-4</sup> These proposals were based on non-cylindrically symmetric electrode shapes that would generate transverse quadrupole fields. This rf self-focusing is an important new idea especially at low velocities because the electric force is velocity independent.

In 1970, Kapchinskii and Teplyakov<sup>5,6</sup> (K-T) proposed a particularly attractive form of these new ideas. The previous proposals to generate quadrupole fields used specially shaped gaps between drift tubes or waveguides to generate localized focusing forces. However, the scheme proposed by K-T was a more basic and flexible idea in which the quadrupole focusing field was spatially continuous along the z-axis. This structure is called the RFQ. Figure 1 shows a schematic view of a four-vane resonator that is the form of the RFQ being developed at the Los Alamos Scientific Laboratory (LASL).

The RFQ may have important applications in the low-velocity part of many types of ion accelerators. It can provide several necessary functions in a continuous manner to produce a final beam suitable for injection into a conventional accelerator. Briefly these functions are the following: (1) acceptance of a dc beam (50-keV protons, for example) and radially matching it into the following sections of the RFQ; (2) bunching this beam adiabatically with high capture efficiency (>90%); and (3) accelerating the beam to an energy (1-MeV protons, for example) that is convenient for injection into the next acceleration stage. In this paper we will consider the next stage to be a drift-tube linac. Through proper design it is possible to control the particle distribution in the phase-stable bucket so that nonadiabatic acceleration effects are minimized. Also, the final synchronous phase can be brought to a value (say  $-30^\circ$ ) that is suitable for capture by a drift-tube linac. Because the radial focusing forces are electric and retain their full strength at low velocity, and also because the forces are spatially continuous, the above functions can be accomplished at low velocities with minimal effects from space charge. Also, as suggested by K-T, space-charge effects can be further minimized through proper control of the bunching process. This idea is an important contribution that is compatible with possible choices of RFQ design parameters.

There are several possible applications of the RFQ now under consideration at LASL. These include: (1) a high-intensity deuteron accelerator for the Hanford Fusion Materials Irradia-

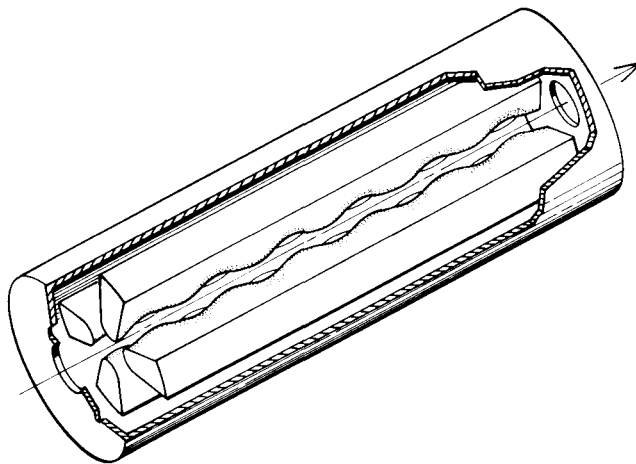

Fig. 1. Four-vane resonator.

\*Work performed under the auspices of the U. S. Department of Energy.

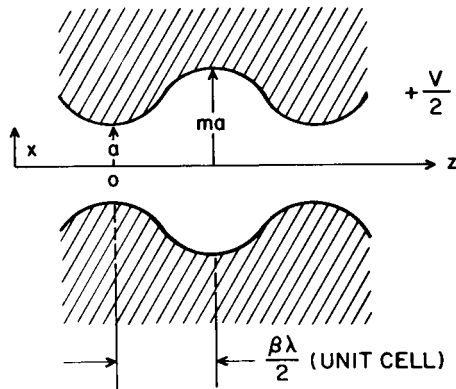

Fig. 2. RFQ pole-tip geometry.

tion Test (FMIT) Facility, (2) the Pion Generator for Medical Irradiation (PIGMI), a high-intensity proton accelerator for use in pion and neutron radiotherapy, (3) a heavy-ion accelerator for inertial fusion, and (4) a high-energy accelerator for ions such as neon. Methods which have been found useful in choosing beam-dynamics parameters for RFQ systems are presented. As a specific example, the results of these methods are applied to a proton linac designed to test the RFQ principle.

RFQ Electric Fields and Pole-Tip Geometry

In the RFQ the electric field distribution is generated by four poles arranged symmetrically around a central z-axis. The poles are excited with rf power so that at a given time, adjacent pole tips have equal voltages of opposite signs. If the pole tips have constant radius as z is varied, then only a transverse field (mainly quadrupole) is present. In the x-z plane for example, this quadrupole field is focusing for one-half of the rf period and defocusing the other half. The structure has the properties of an alternating-gradient focusing system with a strength independent of particle velocity. To generate a longitudinal accelerating field the pole tips are periodically varied in radius. The variation is such that, at a value of z where the pole tips in the x-z plane have minimum radius, the pole tips in the y-z plane have maximum radius. This is shown in Fig. 1. Figure 2 shows a cut through the x-z plane, and shows the mirror symmetry of the opposite poles. In Fig. 2 the radius parameter a, the radius modulation parameter m, and the cell length are defined. The longitudinal field is generated between the x pole tip that has minimum radius at z = 0, and the y pole tip that has minimum radius at z = beta lambda / 2. The unit cell is beta lambda / 2 in length and corresponds to one acceleration gap. Adjacent unit cells have oppositely direct E\_z fields, so that in

practice only every other cell contains a particle bunch.

In the coordinate system of Fig. 2, the lowest-order potential given by K-T is written in cylindrical coordinates (r, psi, z) as follows:

$$U = \frac{V}{2} \left[ X \left( \frac{r}{a} \right)^2 \cos 2\psi + AI_0(kr) \cos kz \right] \cdot \sin(\omega t + \phi) \quad (1)$$

where V is the potential difference between adjacent pole tips, and k = 2pi/beta lambda.

From this the following electric field components are obtained:

$$E_r = - \frac{XV}{a} r \cos 2\psi - \frac{kAV}{2} I_1(kr) \cos kz \quad (2)$$

$$E_\psi = \frac{XV}{a} r \sin 2\psi \quad (3)$$

$$E_z = \frac{kAV}{2} I_0(kr) \sin kz \quad (4)$$

each multiplied by sin(omega t + phi). Our method of calculating RFQ beam dynamics is based on these fields and is described in Ref. 7. The quantities A and X are given by:

$$A = \frac{m^2 - 1}{m^2 I_0(ka) + I_0(mka)} \quad (5)$$

$$X = 1 - AI_0(ka) \quad (6)$$

The quantity VA is the potential difference that exists on the axis between the beginning and the end of the unit cell. This means that the space-average longitudinal field is given by E\_0 = 2AV/beta lambda. The energy gain of a particle with charge q and synchronous velocity beta c traversing a unit cell is approximately:

$$\Delta W = qE_0 \ell T \cos \phi_s \quad (7)$$

where ell = beta lambda / 2, and T = pi/4 is the value of the transit-time factor for a longitudinal field with space variation sin kz. This notation is similar to K-T except that A equals their theta divided by T = pi/4.

A radial stability diagram for the RF is given in Fig. 3. The abscissa is given by:

$$\Delta = \frac{\pi^2 qVA \sin \phi}{2Mc^2 \beta^2} \quad (8)$$

This is proportional to the usual "rf defocus" force that gives radial defocusing when a linac

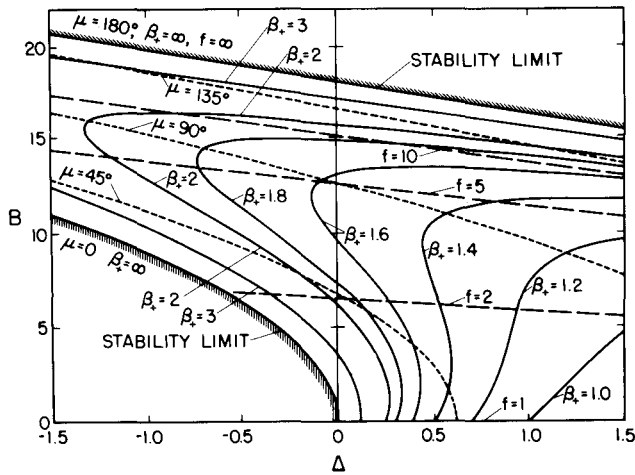

Fig. 3. RFQ radial stability diagram.

is operated with a negative phase angle in the range -90 to 0 degrees. The ordinate in Fig. 3 is:

$$B = \frac{q\lambda^2}{Mc^2} \cdot \frac{XV}{a^2} \quad (9)$$

This is proportional to the radial focusing force, and depends on the magnitude of the electric quadrupole strength  $XV/a^2$ . The electric quadrupole strength does not explicitly depend on  $z$ . This means that for given values of  $a$ ,  $m$ , and  $\beta$ , the focusing strength is constant through a unit cell. It also means that one can maintain the same focusing strength in every unit cell by varying the parameters such that  $XV/a^2$  is held fixed. Except for the short, initial radial matching section, the linac discussed in the section "Design of the 425-MHz RFQ Test", has been designed to have a constant radial-focusing strength. Later it will be shown that this has a geometrical consequence that may be beneficial in the design of RFQ resonators.

The pole-tip shape required to produce the above electric fields is given by:

$$x^2 - y^2 = r^2 \cos 2\psi = \frac{a^2}{X} [1 - AI_0(kr) \cos kz] \quad (10)$$

To obtain the shape of one pole tip in the  $x$ - $z$  plane, let  $\psi = 0$ . This gives:

$$\frac{x^2}{a^2} = \frac{1 - AI_0(kx) \cos kz}{1 - AI_0(ka)} \quad (11)$$

This equation was solved numerically to find values of  $x$  as a function of  $z$ . Call these values of  $x$ , which are solutions,  $\alpha(z)$ . To describe the geometry in the transverse plane

an equation was derived for the transverse radius of curvature of the pole tip. This curvature is:

$$R(z) = \alpha(z) \frac{P + Q}{P - Q} \quad (12)$$

where

$$P = I_0(ka) + I_0(mka)$$

and

$$Q = \frac{ka^2}{2\alpha} (m^2 - 1) I_1(k\alpha) \cos kz$$

In the pole-tip geometrical design, the radius of the pole tips have been made equal to  $\alpha(z)$ . The pole-tip shape in the transverse plane was approximated by requiring the pole tips to have the radius of curvature  $R(z)$ . The pole tips are constructed by repeated cuts in the transverse plane by a tape-controlled milling machine. This procedure is discussed more fully in Ref. 8.

At  $z = \beta\lambda/4$ , half way through the unit cell, the RFQ has quadrupolar symmetry. At this point both the  $x$  and  $y$  pole tips have a radius equal to  $r_0 = aX^{-1/2}$ . Also, at this point the radius of curvature  $R = r_0$ . The quantity  $r_0$  can be regarded as a characteristic average radius of the RFQ pole tips. As has been stated, if  $V$  is constant, keeping the focusing strength at a fixed value requires  $X/a^2$  to be constant, and also this is equivalent to keeping  $r_0$  fixed. In general, a fixed value of  $r_0$  can be expected to minimize variations in the vane-to-vane capacitance, and should facilitate the design of an RFQ resonator in which the pole-tip voltage distribution is required to be flat over its entire length.

#### RFQ Design Procedures

If the ion species and the initial and final energies are given, and if the frequency and intervane potential are specified, the RFQ design is determined when the three independent functions  $a(z)$ ,  $m(z)$ , and  $\phi_s(z)$  are given, where  $z$  is the axial distance along the accelerator. Although it may be more convenient to explicitly use other related functions such as  $A$ ,  $X$ , or  $B$ , the designer must determine three independent functions that produce the desired objectives in terms of adequate radial focusing, capture efficiency, radial emittance growth overall length, or other stated criteria. Simple linear forms for the above functions can achieve these objectives for low beam currents as long as the rate of change of the variables is slow enough to approximate an adiabatic condition. However, as the magnitude of the space-charge force increases, more complex forms for these functions appear to become necessary to minimize both particle loss and radial emittance growth.

One possible solution to this problem has been proposed by K-T. In this method  $\Omega_o$ , the longitudinal small oscillation angular frequency at zero current, and  $Z_b$ , the spatial length of the separatrix, are held constant. If the functional form of B is specified, then the three independent functions a, m and  $\phi_s$  are determined. Expressions for  $\Omega_o$  and  $Z_b$  are:

$$\Omega_o^2 = \frac{qVA\omega^2 |\sin \phi_s|}{4Mc^2 \beta^2} \quad (13)$$

$$Z_b = \frac{\beta\lambda\Phi}{2\pi} \quad (14)$$

where  $\phi$  is the angular length of the separatrix, which is related to the synchronous phase  $\phi_s$  by:

$$\tan \phi_s = \frac{\sin \phi - \phi}{1 - \cos \phi} \quad (15)$$

In the region of small longitudinal oscillations and for adiabatic changes, constant  $\Omega_o$  implies a beam envelope of constant length. For a longitudinally matched beam this also implies an invariant longitudinal charge density distribution and fixed beam length. This result holds for zero current and is also true in the presence of space-charge forces, if one assumes the beam bunch to be uniformly distributed in a three-dimensional ellipsoid of constant dimensions. Constant  $Z_b$  together with constant  $\Omega_o$ , can be shown to make the charge-density distribution approximately constant for large longitudinal oscillations at zero current. As can be seen from Eqs. (14) and (15), the invariance of  $Z_b$  determines  $\phi_s(\beta)$ ; Then equation (13) determines  $A(\beta)$ .

This method of attempting to keep the charge density distribution approximately constant, while accelerating and bunching in phase, is expected to reduce those space-charge effects, such as radial emittance growth, that appear to be correlated with longitudinal compression of the beam bunch. However, after the resulting velocity profile  $\beta(z)$  is determined, the function  $A(z)$  takes on small values, especially for large synchronous phases, and increases very slowly except near the end. This can result in an excessively long structure, particularly as the input synchronous phase approaches  $\phi_s = -90^\circ$ . To reduce the length, the initial value of  $\phi_s$  must depart appreciably from  $-90^\circ$ , but this reduces the initial value of  $\phi$ , and results in reduced capture efficiency.

A generalization of the above method has been studied, in which the two constants  $\Omega_o$  and  $Z_b$  are replaced by the new invariants  $\epsilon$  and  $\alpha$ , given as:

$$\epsilon = \frac{-2\pi\dot{\Omega}_o}{\Omega_o^2} \quad (16)$$

and

$$\alpha = \Omega_o Z_b^2 \quad (17)$$

When  $\epsilon = 0$  this reduces to the K-T method. For positive  $\epsilon$ , the small oscillation frequency  $\Omega_o$  decreases at a constant percentage rate, and the separatrix length  $Z_b$  gradually increases. This approach is expected to yield a charge distribution that can slowly compress or expand in size depending upon the value of  $\epsilon$ . In addition, for fixed final values of A and  $\phi_s$ , the overall length decreases as  $\epsilon$  increases. Generally acceptable solutions have been found with  $\epsilon$  in the range  $0 \leq \epsilon \leq 0.2$ .

The use of either the K-T approach or the generalized approach has been found to be effective in reducing radial emittance growth, while the beam is being bunched. This section of the RFQ is referred to as the Gentle Bunching Section. To obtain high capture efficiency, it is necessary to introduce a section before the Gentle Buncher in which the input variables are specified as a function of z rather than  $\beta$ , so that the input synchronous phase can start at  $\phi_s = -90^\circ$  and the initial value of A can be  $A = 0$ . In order to reduce the overall length following the Gentle Buncher, a section was added that maintains a high value of A at the final synchronous phase. The remaining problem of radially matching the beam into the time-varying acceptance of the RFQ requires an initial section for matching. This leads to four stages in the overall design as shown schematically in Fig. 4.

The first stage, The Radial Matching Section, will be described. The matched ellipse parameters in the RFQ depend on the rf phase and are relatively independent of position along the linac. Therefore, the orientation of the acceptance ellipse depends on time. For proper matching into the RFQ, one must provide a transition from a beam having time-independent characteristics to one that has the proper variations with time. This means that at the input, a time-independent set of ellipse parameters is required, which will depend on the beam current. The present solution is to taper the vanes at the input of the RFQ so that the focusing strength changes from almost zero, to its full value over a distance of several (5-10) focusing periods. This procedure allows the time-independent beam to adapt itself to the time structure of the focusing system. Quadrupole symmetry is maintained throughout this section (no vane modulation).

This procedure is illustrated in Fig. 5. A display generated by the program TRACE,<sup>9</sup> has been modified to include rf quadrupoles,

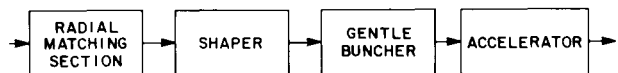

Fig. 4. Functional block diagram.

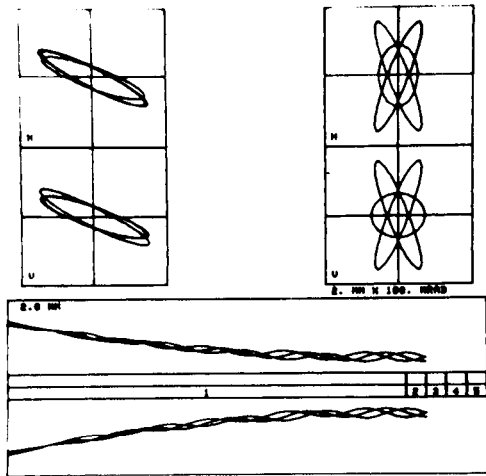

Fig. 5. Radial Matching Section.

either of constant or tapered strengths. The matched ellipse parameters are first found for various phases in the constant-strength section. Three such matched ellipses, corresponding to phases  $90^\circ$  apart, are shown in the upper right side of the figure for both the  $x-x'$  and  $y-y'$  planes. This graphically demonstrates how different the matched ellipses can be as a function of phase, and also shows the relatively small area of overlap that is common to all of these ellipses. The phase-space plots at the upper left are the result of following these same three ellipses backward through a tapered section of the RFQ, 5-periods long (10 cells). One can see that these ellipses are very similar and have a high degree of overlap. The bottom graph in the figure shows the horizontal and vertical profiles that result from following these three ellipses through the tapered rf quadrupole. Space-charge effects were included in this calculation, which assumed a beam current of 30 mA.

An unexpected benefit of the Radial Matching Section is that the increase in aperture at the input results in weak fringe fields and negligible fringe effects for both longitudinal and radial motions. The longitudinal field generated within the matching section is also negligible because of the fact that the change in  $B$  occurs over many rf cycles.

The second stage, called the Shaper Section, can begin at  $\phi_s = -90^\circ$ . The accelerating field is increased steadily from zero, while  $\phi_s$  is maintained at a large value, to obtain a high capture efficiency. Under the influence of the rising axial field, an input dc beam with small energy spread will rotate through many cycles of longitudinal oscillation. The filament in phase space wraps around itself to approximate a matched beam in longitudinal phase space. Some compression of the beam

within the phase stable area is desirable to anticipate subsequent non-adiabatic behavior, which could lead to particle loss. At high beam currents, such compression should be limited, however, because of the large radial emittance growth that can result when the beam is tightly bunched. Even so, dramatic effects of space-charge repulsion will be especially apparent at the first phase foci for an input dc beam with small energy spread.

For the third stage, the Gentle Buncher, the generalized method is used, where Eqs. (16) and (17) are satisfied, and hold  $B$  constant. The Gentle Buncher Section completes the bunching begun in the Shaper Section and accelerates the quasi-matched beam from the Shaper until the final synchronous phase is reached. The bunch length and the charge density undergo no large change in the process.

When the final synchronous phase is reached, the Acceleration Section begins. In this section  $\phi_s$ ,  $m$ , and  $a$  are held at constant final values to apply a relatively large fraction of the intervane voltage on axis, and to bring the beam to its final energy within a short distance.

An important step in the design procedure is a choice of operating intervane potential, which normally should be as large as possible, consistent with the sparking limit. The results from program SUPERFISH<sup>10</sup> show that for the RFQ vanes constructed at LASL, the highest surface fields,  $E_s$ , occur in the middle of each cell at the point of pure quadrupole symmetry. The maximum field does not occur at the pole tip, but occurs at the point where the vanes have minimum separation. The field at the pole tip is  $V/r_0$  and the peak field  $E_s = \kappa V/r_0$  where for this geometry  $\kappa = 1.36$ . Once the choice of maximum allowable surface field is made, the ratio  $V/r_0$  is determined.

After a choice of  $B$  is made, which provides a good compromise between radial stability and adequate aperture size, the quantities  $V$  and  $r_0$  can be obtained from the relations:

$$r_0 = \frac{q\lambda^2 E_s}{Mc^2 B \kappa} \quad (18)$$

$$V = \frac{q\lambda^2 E_s^2}{Mc^2 B \kappa^2} \quad (19)$$

It is seen that higher surface field  $E_s$  and smaller  $B$  will increase both  $r_0$  and  $V$ . The average axial field then becomes:

$$E_0 = \frac{2q\lambda A E_s^2}{Mc^2 B \beta \kappa^2} \quad (20)$$

Choose an initial value of  $m = 1$ . A final value of  $m = 2$  produces a good compromise between acceleration efficiency,  $A$ , and focusing efficiency,  $X$ , at the end. If  $X$  is too small, the constraint that  $B$  is constant may make the final radius parameter too small.

Error Tolerances

After a linac has been designed, one must try to determine how sensitive the design is to all probable sources of error. The quantity and quality of the output beam can be degraded by a variety of things, such as a mismatch and a mis-steering of the input beam, and alignment errors and excitation errors in the linac. Tolerances can be specified for some of these errors only by running a large number of numerical simulations. For other types of errors, it is possible to make more general statements, and it is these types that we will be concerned with in this section.

The results can be specified in terms of the magnitudes of the multipoles of the focusing field relative to the quadrupole strength at the bore radius. The radial component of the  $n$ th multipole at radius,  $r$ , and angle,  $\psi$ , is defined to be:

$$E_{r,n} = A_n \left( \frac{r}{r_0} \right)^{n-1} \cos(n\psi - \delta_n) \quad (21)$$

where  $A_n$  is the amplitude and  $\delta_n$  is the phase of the  $n$ th multipole, and  $r_0$  is the bore radius.

The values given below, as well as those given for image charge effects, (see Appendix) were obtained using a computer program that calculates the charge density induced on equipotential surfaces.<sup>11</sup> The unperturbed calculations were made with the vanes approximated by four circular cylinders symmetrically placed about the  $z$ -axis. The cylinder walls were a distance  $r_0$  from the  $z$ -axis and the diameter of each cylinder was  $2r_0$ .

Alignment errors

The vanes are displaced slightly from their proper positions. Symmetric displacements of opposite poles, inward or outward, have no significant effect other than changing the quadrupole strength slightly, which is equivalent to changing the operating voltage. Non-symmetric displacements introduce odd-order multipoles. An example of a nonsymmetric displacement is a horizontal displacement of the vertical vanes. A small displacement,  $d$ , has been calculated to produce multipoles of order 1, 3, and 5 having fractions of the quadrupole term of  $0.16 d/r_0$ ,  $0.64 d/r_0$ , and  $0.024 d/r_0$ , respectively. The dominant term appears to be the sextupole ( $n = 3$ ), and by placing an acceptable limit on it one can specify a tolerance on  $d/r_0$ . If it is desirable to keep the sextupole

term below 1%, then the tolerance on  $d/r_0$  is approximately 1.5%.

Excitation errors

The ideal excitation for the potential on each of the four vanes to oscillate between  $+V/2$  at all points along the linac. Variations in the potential in the longitudinal direction will probably be gradual and small. Information about the longitudinal field can be obtained from beadpull measurements.

Errors in the transverse fields can be represented most generally by assuming that each vane is oscillating at a different potential. The potential on the  $i$ th-vane would oscillate between  $+(V + \Delta V_i)/2$ , and the excitation level could be adjusted so that the average potential is correct, which would make

$$\sum_{i=1}^4 \Delta V_i = 0 \quad (22)$$

The voltage errors,  $\Delta V_i$ , can be divided into symmetric and antisymmetric parts. The symmetric components correspond to errors on opposite poles having the same magnitude and the same sign; the antisymmetric components correspond to errors on opposite poles having the same magnitude and opposite signs. The symmetric components have no effect on the multipole spectrum, but the antisymmetric components will generate odd-order multipoles. Let  $v_x$  and  $v_y$  be the fractional antisymmetric components in the horizontal and vertical vanes, respectively. That is, the potential on the opposing horizontal vanes would oscillate with the magnitudes  $(1 \pm v_x)V/2$ . The magnitudes of the odd multipoles are found to be proportional to  $v = (v_x^2 + v_y^2)^{1/2}$ , and the ratio of the first four to the quadrupole strengths are given below:

$$A_1/A_2 = 0.397 v \quad ; \quad (23)$$

$$A_3/A_2 = 0.308 v \quad ; \quad (24)$$

$$A_5/A_2 = 0.029 v \quad ; \quad (25)$$

$$A_7/A_2 = 0.041 v \quad . \quad (26)$$

That is, a 10% antisymmetric component ( $v = 0.1$ ) would cause a 4% dipole field and a 3% sextupole field. If it is necessary to keep the sextupole

field below 1%, then one must keep  $v < 0.032$ . The dipole field would simply cause a displacement of the electrical axis of the quadrupole by the same percentage.

Design of the 425-MHz RFQ Test

One of the applications of the RFQ under consideration at LASL is for the high-intensity 35-MeV deuteron accelerator being designed for the Hanford Fusion Materials Irradiation Test (FMIT) Facility to be installed at the Hanford Engineering Development Laboratory (HEDL) at Richland, Washington. An important step in evaluation of the RFQ for this linac is a full power test, which uses an existing proton injector and an existing source of rf power. As an example of the design method discussed above, the RFQ design for this test is presented, which will be called the 425-MHz Test Design. Table I shows a list of parameters. Because of limitations imposed by the existing hardware, the frequency was chosen at  $f = 425$  MHz and the length was constrained to be equal to  $L = 110.8$  cm.

The surface gradient,  $E_s$ , was chosen to have the conservative value 27 MV/m. After the Radial Matching Section, a constant value  $B = 5.85$  provides a compromise between radial stability and tolerance requirements arising from the small aperture. The resulting characteristic average radius is  $r_o = 0.2$  cm and the resulting intervane voltage is  $V = 44$  kV. The objective of the test is to capture a dc beam of energy  $W_i = 0.1$  MeV, bunch and accelerate it to some energy greater than about 0.5 MeV, and to study the performance as a function of input current. The exact value of the final synchronous phase is not important, as long as good bunching can be demonstrated. Two computer programs have been written to help generate parameters for the beam-dynamics program PARMTEQ (see Appendix). The first program generates the Gentle Buncher parameters as a function of axial distance  $z$ , given initial and final energies for this section and given the  $\epsilon$  parameter. The second program takes the initial Gentle Buncher parameters as final values for the Shaper Section, generates Shaper parameters as a function of  $z$ , then traces particles through the Shaper in longitudinal

phase space, thus giving an estimate of expected capture efficiency. In addition, both programs calculate several quantities as a function of  $z$ , such as the ratio of space-charge to focusing force (see Appendix), and longitudinal and radial oscillation frequencies. These results are useful as a guide to predict and interpret subsequent PARMTEQ results.

The chosen design is one with a Gentle Buncher parameter  $\epsilon = 0$ , which corresponds to the K-T approach. Several designs made with  $\epsilon = 0.2$  gave comparable results. Figure 6 shows the resulting profiles from PARMTEQ for several variables. The four basic sections of the structure are indicated. The final energy after 110.8 cm and 165 cells is  $W_f = 0.640$  MeV. The radial matching is done in the first ten cells or 5.2 cm, where  $B$  is linearly varied from an initial value of  $B = 0.20$  to a final value  $B = 5.85$ , and is kept constant throughout the rest of the structure. The slow increase of  $m$  during the first half of the structure appears to be necessary in order to reduce radial space-charge effects as was discussed previously. As  $m$  increases and the acceleration efficiency  $A$  (not shown) also increases, the focusing efficiency,  $X$ , decreases. The constant value of  $B$  then implies a decrease in the radius parameter  $a$ . The transverse acceptance is determined by the final aperture and has a normalized value  $A_n = 0.09\pi$  cm-mr at the nominal current of  $I = 15$  mA. This can be compared with an expected input beam from the ion source having a normalized emittance of  $E_n = 0.05\pi$  cm-mr. The input particle distribution used in the PARMTEQ calculation gave 100% of the beam within this phase-space area, and 90% within a normalized area of  $0.034\pi$  cm-mr.

Table II lists the PARMTEQ results for the beam transmission efficiency, the output beam current, and the radial emittance growth. The emittance growth is the normalized emittance of the transmitted beam divided by the normalized emittance of the input beam. Both emittances are obtained from ellipses which

TABLE I  
425-MHz TEST DESIGN PARAMETERS

Ion	H <sup>+</sup>
Frequency	425 MHz
Input Energy	0.100 MeV
Output Energy	0.640 MeV
Intervane Voltage	44 kV
Minimum Radius Parameter	0.126 cm
Overall Vane Length	110.8 cm
Number of Cells	165
Nominal Current	15 mA

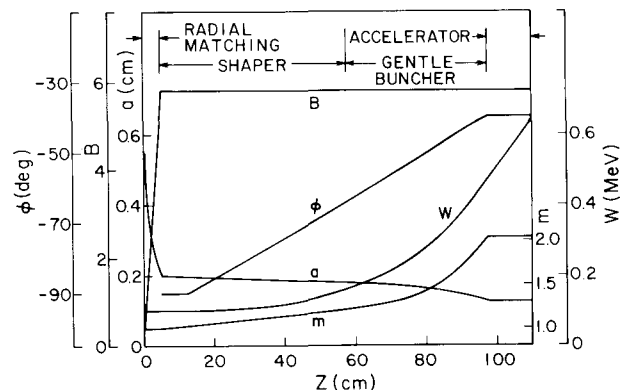

Fig. 6. Parameters for the 425-MHz test design.





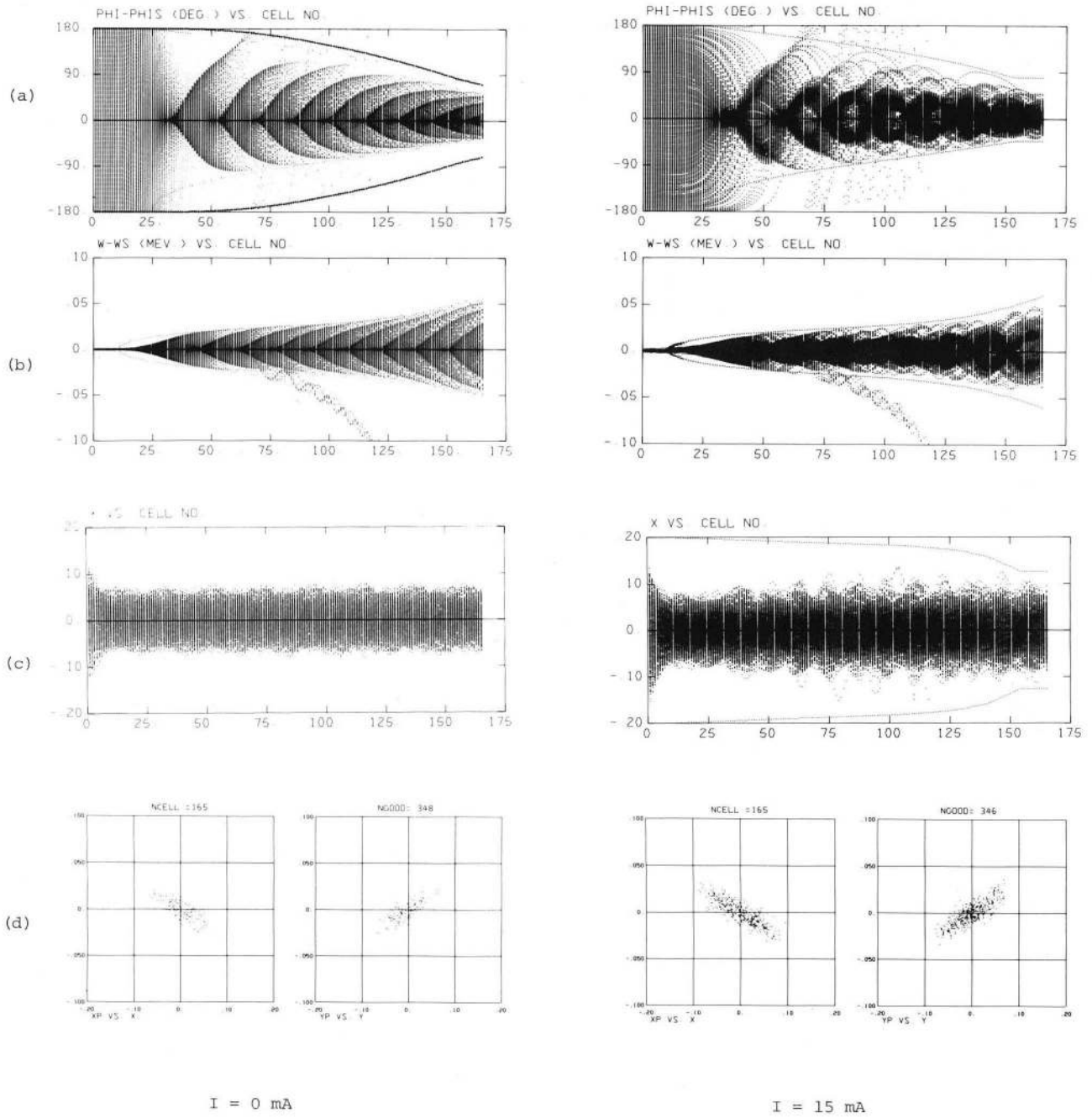

Figure 7  
 Results from the 425-MHz Test Design:  
 (a) phase profile,  
 (b) energy profile,  
 (c) x profile,  
 (d) final radial phase space.

If we compare the results in Table III with those presented in Table II, it is seen that the simple linear ramp approach gives good transmission efficiency when space-charge can be neglected. But, as expected, the 425-MHz Test Design is clearly superior in terms of transmission efficiency at the non-zero beam currents shown. The radial emittance-growth numbers are significantly perturbed by particle loss at the larger beam currents in both designs.

Acknowledgments

We thank E. A. Knapp, R. A. Jameson, and D. A. Swenson for advice and encouragement. We acknowledge valuable discussions with R. L. Gluckstern, LASL consultant, concerning the Shaper design, and we thank G. W. Rodenz for assistance with the computer calculations.

Appendix

Image Charge Effects

We have tried to estimate the magnitude of the effects on the beam caused by the image charges induced on the vanes by the beam itself. The simplifying assumptions made in this analysis overestimate the image-charge effects.

In the high-energy end of the linac, where the beam is bunched and the vanes have a relatively large modulation, it appears that the image charges actually produce an alternating focusing and defocusing effect for both the longitudinal and radial motions. At present we have no quantitative estimate of the image forces at the high-energy end but we have calculated the effects at the low-energy end, where the main effect is radially defocusing.

The image charges produced by a continuous beam with a circular cross-section, centered on axis, will cause multipole fields of order 4, 8, . . . , proportional to the beam current. For a beam with radius  $r_b$ , the ratio of the magnitudes of the image force to the space-charge force at the edge of the beam was calculated to be:

$$\frac{\text{image force}}{\text{space-charge force}} = 0.422 \left(\frac{r_b}{r_o}\right)^4 + 0.118 \left(\frac{r_b}{r_o}\right)^8 + \dots, \tag{A-1}$$

where  $r_o$  is the bore radius. If  $r_b = 0.5 r_o$ , then this ratio is less than 3%.

A displacement of the beam center from the axis produces image charges that cause other multipole components, the main ones being the  $n = 1, 3,$  and  $5$  terms. The magnitudes of the  $n = 4, 8, \dots$  multipoles are relatively unchanged by small displacements of the beam. The strength of the dipole field is approximately  $0.78 E r_c/r_o$ , where  $r_c$  is the dis-

placement of the beam center from the axis, and  $E$  is the space-charge field produced by the beam at a distance  $r_o$  from its center. The magnitudes of the  $n = 3$  and  $n = 5$  multipole fields are each approximately half of the magnitude of the dipole field.

Based on these results, the following conclusion can be made: as long as the beam is well centered ( $r_c < 0.2 r_o$ ) and the beam does not fill a large fraction of the aperture ( $r_b < 0.6 r_o$ ) then the image forces are at least an order of magnitude lower than the space-charge forces and can be neglected without seriously affecting the results. If these conditions are violated, then the image forces might become comparable to the space-charge forces and could cause an increase in the beam loss and in the emittance growth.

Outline of PARMTEQ

The computer program used to study the beam dynamics of the RFQ linac is called PARMTEQ, (Phase and Radial Motion in Transverse Electric Quadrupoles). It is a modified version of PARMILA, and performs four basic functions. It generates an RFQ linac, generates a variety of input particle distributions, performs beam dynamics calculations, and generates a variety of outputs.

The information required for generating an RFQ linac consists of the following: the vane voltage; the linac frequency; the mass of the particles; the initial and final energies; and a table of values specifying the radial focusing strength  $B$ , the vane modulation parameter  $m$ , and the synchronous phase, all at specified distances along the structure. The linac is generated cell-by-cell, in an iterative procedure.

The beam dynamics calculations are performed as follows: each cell is divided into a number of segments (typically four, with a maximum of eight). Initial values of the dynamical quantities  $x, x', y, y', \phi,$  and  $W$  are transformed to final values through each segment. The phase and energy coordinates are the first to be transformed. In the radial transformations, the quadrupole and the rf defocusing terms are treated separately. The quadrupole transformation is that of a standard quadrupole having a length equal to the segment length, and a strength that depends on the rf phase as the particle passes through the segment. Consequently, each particle will experience a different quadrupole force depending on its own phase. The rf defocusing term is treated as an impulse or thin lens, whose strength depends on the rf phase as well as on the location of the particle in the cell.

At the middle of each cell, the particles are given an impulse to simulate the space-charge forces. This is the most difficult transformation to make satisfactorily. In order to calculate properly the space-charge forces, one needs to know the positions of all the particles at a given instant in time. Instead,

one knows the particle coordinates as they arrive at a particular location along the linac. There is a big difference between these two situations when there is a large phase spread in the beam, as there is in the low energy portion of the RFQ. Consequently, before calculating the space-charge forces it is important to estimate the particle positions at a given instant in time, which was chosen to be the time when the rf field is zero. At this particular time, the cross-section of the beam should be very nearly circular. A series of transformation matrices is generated, considering only the quadrupole term, that transforms the radial coordinates from their values at all other phases within  $\pm 180^\circ$  in  $5^\circ$  increments. For each particle the transformation matrix is found that most nearly agrees with the particle phase, and the inverse of the transformation is applied, giving an estimate of the particle's radial coordinate at the desired phase. The longitudinal position is estimated from the particle's velocity and phase. After doing this for all of the particles, the space-charge forces are calculated and the impulses are applied by changing  $x'$ ,  $y'$ , and  $W$  for each particle. The radial coordinates are then similarly transformed back to their modified values at their original phases, and this completes the space-charge transformation for one cell.

After the space-charge transformation, the coordinates are transformed through the remainder of the segments in the cell. A variety of output subroutines can be called at the end of any cell, or at the middle of any cell, either before or after the space-charge impulse is applied.

Some RFQ Scaling Methods

Some RFQ applications may require a method of scaling an existing design to some new frequency. At fixed  $\beta$  a change in frequency will cause a change in the operating point on the radial stability chart, which changes the transverse beam dynamics. An exactly equivalent structure may not be obtainable when the frequency is changed. A useful guide for generating solutions at new frequencies is to impose a direct geometric scaling of dimensions in proportion to wavelength. Thus at each cell the radius parameter,  $a$ , is proportional to  $\lambda$ , and  $m$  is unchanged. The frequency dependence of  $a$  and  $E_s$  tends to make  $B$ ,  $\Delta$ , and  $V$  decrease as frequency increases and makes  $E_0$  increase somewhat with increasing frequency.

For high-current applications of the RFQ it is useful to have some means of evaluating the expected importance of space-charge effects. It is useful to compute the ratio  $\mu$  of the space charge force to the average or smoothed restoring force. Assume a model where the beam bunch is represented by a uniform distri-

bution of charge within a three-dimensional ellipsoid. For longitudinal motion it is found that:

$$\mu_\lambda = \frac{90 I(\text{amps}) \lambda^3 \beta^2 f(b/r_b)}{\pi^2 V(\text{volts}) b r_b^2 A |\sin \phi_s|} \quad (\text{A-2})$$

where  $r_b^2 = r_x r_y$  and  $b$  is the half length of the bunch. The function  $f(b/r_b)$  has the approximate value  $f(b/r_b) = r_b/3b$  in the range  $0.8 < b/r_b < 5$ .

For radial motion we use

$$\mu_r = \frac{45qI(\text{amps})\lambda[1 - f(b/r_b)]}{Mc^2(\text{eV})\beta^2 r_b^2 b k_r^2} \quad (\text{A-3})$$

$$\text{where } k_r^2 = \frac{1}{8\pi^2 \beta^2 \lambda^2} [B^2 + 8\pi^2 \Delta^2]$$

Generally  $\mu_\lambda$  and  $\mu_r$  are kept less than about 0.5 in order to control beam losses due to a reduced stable phase space area. Since  $\mu_\lambda$  and  $\mu_r$  affect the frequencies of longitudinal and radial motion, the additional condition must be met, that resonance must be avoided.

Limiting current expressions can be obtained if the limits are assumed to occur when  $\mu_\lambda = 1$  and  $\mu_r = 1$ . Assume that the bunch half-length is related to the synchronous phase by:

$$b = \frac{\beta \lambda |\phi_s|}{2\pi} \quad (\text{A-4})$$

The approximate form for  $f(b/r_b)$  is assumed and  $\sin \phi_s$  is replaced by  $\phi_s$ . For the longitudinal limit:

$$I_\lambda = \frac{AV |\phi_s|^3 r_b^3}{120\lambda} \quad (\text{A-5})$$

where  $r_b$  is the beam radius. The radial limit is:

$$I_r = \frac{\beta |\phi_s| r_b^2 Mc^2 [B^2 + 8\pi^2 \Delta^2]}{720\pi^3 \lambda^2 q [1 - f]} \quad (\text{A-6})$$

The longitudinal limit decreases rapidly as the beam is bunched in phase. The radial limit increases with  $\beta$ , but also decreases while the beam is bunched in phase.

At the front end of the RFQ, where the beam is in transition between a dc and a bunched

beam, these formulas will not apply. The lack of separation of bunches will be expected to reduce the longitudinal space-charge repulsion, but the conditions arising at each phase focus can create localized unstable regions, where space-charge forces may exceed the focusing forces.

#### References

1. V. V. Vladimirkii, Prib. Tekh. Eksp. No. 3, 35 (1956).
2. G. M. Anisimov and V. A. Tepliyakov, Prib. Tekh. Eksp. No. 1, 21 (1963).
3. V. A. Tepliyakov, Prib. Tekh. Eksp. No. 6, 24 (1964).
4. F. Fer, P. Lapostolle, C. Beith, and A. Cabrespine, Proc. Int. Conf. on Linear Accelerators, Dubna (Aug. 1963), ed. A. A. Kolomesky, A. B. Kusnetsov, and A. N. Lebedev.
5. I. M. Kapchinskii and V. A. Tepliyakov, Prib. Tekh. Eksp. No. 2, 19 (1970).
6. I. M. Kapchinskii and V. A. Tepliyakov, Prib. Tekh. Eksp. No. 4, 17 (1970).
7. R. H. Stokes, K. R. Crandall, J. E. Stovall, and D. A. Swenson, IEEE Trans. on Nucl. Sci. NS-26, 3469 (1979).
8. J. M. Potter, S. W. Williams, F. J. Humphry, and G. W. Rodenz, IEEE Trans. on Nucl. Sci. NS-26, 3745 (1979).
9. K. R. Crandall, "TRACE"; An Interactive Beam-Transport Program, LA-5332, (October 1973).
10. K. Halbach, R. F. Holsinger, W. E. Jule and D. A. Swenson, "Properties of the Cylindrical Rf Cavity Evaluation Code SUPERFISH," Proc. of 1976 Proton Linac Conf., Atomic Energy of Canada Ltd. Report No. AECL-5677, 122 (1976).
11. K. R. Crandall, "Computation of Charge Distribution on or Near Equipotential Surfaces," LA-3512, (December 1966).

#### Discussion

(Editor's Note: The first comment refers back to Discussion following the paper by D. Swenson, "Low beta Structures".)

Teng, Fermi Lab: I think the misunderstanding of this radial matching is just a matter of semantics. It is usually called adiabatic capture, not matching. Matching is something in which you catch the phase ellipse on-the-fly, when the shape is exactly right. In your case, you are just turning it on gently.

Wrangler: Yes, I guess we've been thinking of adiabatic capture as a longitudinal effect primarily, but this would be the transverse version.

Miller, SLAC: Could I see your first slide again with the equations of the fields. I think that I see that the quadrupole fields are indeed spatially constant but you have a solenoidal field that has a z-dependence.  $E_r$  has a z-dependence, but  $E_\psi$  does not. (Crandall: That's what we interpret as an rf de-focus term.)

Miller: You probably shouldn't call it "de-focus" because its alternating gradient and the net effect is focusing.

Wrangler: This is the rf de-focus term associated with the accelerating field.

Miller: But it has a  $k_z$ -dependence, so it's alternating and it gives a net focusing.

Wrangler: The dominant term is the quadrupole term which arises when we turn on the accelerating field. It gives us a transverse force which depends on the particle phase. When particles are being accelerated there is going to be a de-focusing force in the transverse plane. These terms are dominating in the focusing.

Miller: Oh yes, I see.