

**DEVELOPMENT OF AN EXTREMELY ROBUST AUTOMOTIVE
SUSPENSION SYSTEM USING INTELLIGENT ACTIVE FORCE
CONTROL**

**(PEMBANGUNAN SISTEM SUSPENSI KENDERAAN LASAK
MENGUNAKAN KAWALAN DAYA AKTIF PINTAR)**

**MUSA MAILAH
HISHAMUDDIN JAMALUDDIN
MOHD ZARHAMDY MOHD ZAIN
GIGIH PRIYANDOKO
MOHAMAD AKMAL BAHRAIN ABDUL RAHIM**

**RESEARCH VOTE NO:
74221**

**RESEARCH MANAGEMENT CENTRE
UNIVERSITI TEKNOLOGI MALAYSIA**

2007

UNIVERSITI TEKNOLOGI MALAYSIA

**BORANG PENGESAHAN
LAPORAN AKHIR PENYELIDIKAN**

TAJUK PROJEK : **DEVELOPMENT OF AN EXTREMELY ROBUST AUTOMOTIVE
SUSPENSION SYSTEM USING INTELLIGENT ACTIVE FORCE
CONTROL**

Saya **MUSA BIN MAILAH**
(HURUF BESAR)

Mengaku membenarkan **Laporan Akhir Penyelidikan** ini disimpan di Perpustakaan Universiti Teknologi Malaysia dengan syarat-syarat kegunaan seperti berikut :

1. Laporan Akhir Penyelidikan ini adalah hakmilik Universiti Teknologi Malaysia.
2. Perpustakaan Universiti Teknologi Malaysia dibenarkan membuat salinan untuk tujuan rujukan sahaja.
3. Perpustakaan dibenarkan membuat penjualan salinan Laporan Akhir Penyelidikan ini bagi kategori TIDAK TERHAD.
4. * Sila tandakan (/)

SULIT

(Mengandungi maklumat yang berdarjah keselamatan atau Kepentingan Malaysia seperti yang termaktub di dalam AKTA RAHSIA RASMI 1972).

TERHAD

(Mengandungi maklumat TERHAD yang telah ditentukan oleh Organisasi/badan di mana penyelidikan dijalankan).

TIDAK
TERHAD

TANDATANGAN KETUA PENYELIDIK

PROFESOR MADYA DR. MUSA MAILAH

Nama & Cop Ketua Penyelidik

Tarikh : **10 APRIL 2007**

CATATAN : *Jika Laporan Akhir Penyelidikan ini SULIT atau TERHAD, sila lampirkan surat daripada pihak berkuasa/organisasi berkenaan dengan menyatakan sekali sebab dan tempoh laporan ini perlu dikelaskan sebagai SULIT dan TERHAD.

DEDICATIONS

To all *Intelligent Active Force Control Research Group* (IAFCRG) members - a **big thank you** for all your contributions and participation.....

ACKNOWLEDGEMENTS

We would like to express our sincere gratitude and appreciation to the Ministry of Science Technology and Innovation (MOSTI), Malaysia, for providing the project research grant (Project No.: 03-02-06-0123EA001) and the Universiti Teknologi Malaysia (UTM) for their full support in terms of accommodating the research infrastructures and facilities. Special thanks go to Abdul Rahim Mohamad, Ahmad Faisal and Ahmad Shahrizam from the Systems & Control Laboratory for their meaningful contribution in assisting some of the works related to this project. Last but not least to everyone who has in one way or another contributed to the success of this project.

ABSTRACT

This report describes both theoretical and experimental studies of a quarter-car vehicle suspension system that incorporates a number of control schemes in which a number of responses or characteristics were rigorously investigated. Particular focus is on the application of a very practical robust control scheme known as active force control (AFC) that is expected to render any forms of disturbances on the system to be effectively compensated. These disturbances are mostly in the form of various modelled road profiles (terrains) that the unsprung mass (tyre or wheel) comes in direct contact with and which in turn are transmitted to the sprung mass (body) of the system causing undesirable vibration or shaking that may cause discomfort to the 'passenger'. Thus, it is the main aim of this study to come up with solution/s that can minimise this discomfort condition (thereby improved the riding comfort) in such a way that the body of the vehicle shall remain almost indifferent to the introduced disturbances. In other words, the sprung mass (body) of the vehicle is extremely robust to the vibration or other external forces. A direct measure would be the significant reduction in the body acceleration and displacement. Intelligent techniques employing neural network (NN), adaptive fuzzy logic (AFCL) and their hybrids were value-added contributions that were deliberately and primarily introduced into the AFC schemes to approximate the virtual estimated mass of the system that is vital to trigger the AFC mechanism. Indeed, simulation results have shown the extreme robust nature of the AFC-based schemes embedded with a number of intelligent methods in countering and nullifying the induced vibration effects and other adverse conditions. The simulation results were then consequently validated by experiments conducted on a working prototype which is mechatronically designed and developed in a laboratory. The body acceleration and displacement of the system were considerably reduced to more than 70% compared to a passive control system and about 50% to a closed-loop proportional-integral-derivative (PID) control, thereby exhibiting the robust performance of the proposed AFC-based methods.

ABSTRAK

Laporan ini menerangkan secara teori dan juga ujikaji terhadap suatu sistem suspensi kenderaan suku-kereta yang memuatkan beberapa skema kawalan di mana sambutan atau ciri sistem dikaji secara mendalam. Tumpuan lebih menjurus kepada aplikasi suatu teknik praktikal yang lasak serta dikenali sebagai kawalan daya aktif (AFC) yang boleh mengakibatkan sebarang gangguan terhadap sistem dipampas atau dihindarkan dengan amat baik. Gangguan ini sebahagian besarnya berpunca dari keadaan permukaan jalan di mana ia bersentuhan dengan jisim tak berspring (tayar atau roda) menyebabkan berlakunya getaran tak diingini pada jisim berspring (badan) kenderaan dan seterusnya boleh mendatangkan kesan tidak selesa terhadap pengguna. Maka, adalah menjadi tujuan utama projek ini dirangkakan untuk mencari jalan penyelesaian terhadap keadaan ketidakselesaian (dengan demikian, meningkatkan keselesaan pemanduan) begitu rupa sehingga badan sistem kenderaan masih tidak terkesan dengan sebarang gangguan yang dikenakan pada sistem. Dengan perkataan lain, badan kenderaan adalah sangat lasak terhadap sebarang kesan getaran atau tindakan daya luaran. Suatu ukuran yang menunjukkan keberkesanan ini ialah kadar penurunan pecutan dan anjakan badan. Beberapa teknik pintar menggunakan rangkaian neural (NN), logik kabur boleh suai (AFL) serta hibridnya merupakan sumbangan yang dapat menambah-nilai kajian di mana ia digunakan terutama sekali untuk mendapatkan nilai jisim maya anggaran yang diperlukan untuk menjalankan mekanisme AFC. Hasil kajian simulasi menunjukkan ciri amat lasak skema berasaskan AFC yang dimuatkan dengan teknik kawalan pintar di mana ia dapat mengatasi dan mengurangkan kesan getaran dan beberapa keadaan yang 'memudaratkan'. Hasil kajian simulasi juga dapat ditentusahkan melalui ujikaji sebenar terhadap prototaip yang telah direka bentuk dan dibangunkan menggunakan pendekatan mekatronik di dalam makmal. Pecutan dan anjakan badan yang diperoleh menunjukkan pengurangan sehingga sebanyak 70% berbanding dengan sistem pasif manakala ianya adalah kira-kira 50% jika dibandingkan dengan sistem kawalan berkadaran-kamiran-terbitan (PID), seterusnya mengesahkan keberkesanan teknik berasaskan AFC.

CONTENTS

CHAPTER	SUBJECTS	PAGE
	TITLE PAGE	i
	DEDICATION	iii
	ACKNOWLEDGEMENTS	iv
	ABSTRACT	v
	ABSTRAK	vi
	CONTENTS	vii
	LIST OF TABLES	xii
	LIST OF FIGURES	xiii
	LIST OF SYMBOLS / ABBREVIATIONS	xvi
	LIST OF APPENDICES	xix
CHAPTER 1	INTRODUCTION	1
	1.1 General Introduction	
	1.2 Outline of Research	
	1.3 Objective of Research	
	1.4 Scope of Research	
	1.5 Research Methodology	
	1.6 Organization of Report	

CHAPTER 2	CONTROL DESIGN OF A QUARTER CAR SUSPENSION SYSTEM USING FUZZY LOGIC ACTIVE FORCE CONTROL	8
2.1	Abstract	
2.2	Introduction	
2.2	Dynamics of An Active Suspension System	
2.3	Dynamics of A Double Acting Hydraulic Strut	
2.4	Active Force Control	
2.5	Knowledge Based System	
2.6	Fuzzy Logic Controller	
2.7	Simulation, Results and Discussion	
2.8	Conclusion	
CHAPTER 3	FUZZY LOGIC ARTIFICIAL NEURAL NETWORK ACTIVE FORCE CONTROL FOR AN ACTIVE SUSPENSION OF A QUARTER CAR	17
3.1	Abstract	
3.2	Introduction	
3.3	Dynamics Equations of An Active Suspension System	
3.4	Dynamics Equations of A Hydraulic Actuator	
3.5	Active Force Control	
3.6	Neural Network	
3.7	Fuzzy Logic Controller	
3.8	Simulation, Results and Discussion	
3.9	Conclusion	

CHAPTER 4	PARTICLE SWARM OPTIMIZATION NEURAL NETWORK BASED MODELLING OF VEHICLE SUSPENSION SYSTEM	23
4.1	Abstract	
4.2	Introduction	
4.2	Quarter Car Vehicle Suspension	
4.3	Neural Network	
4.4	Particle Swarm Optimization	
4.7	Results and Discussion	
4.8	Conclusion	
CHAPTER 5	SIMULATION OF A SUSPENSION SYSTEM WITH ADAPTIVE FUZZY ACTIVE FORCE CONTROL	30
5.1	Abstract	
5.2	Introduction	
5.2	Active Suspension Model	
5.3	Hydraulic Actuator Model	
5.4	Adaptive Fuzzy Control	
5.5	Active Force Control	
5.6	Design of Proposed AF-AFC Scheme	
5.7	Simulation	
5.8	Results and Discussion	
5.9	Conclusion	
CHAPTER 6	HYBRID CONTROL SCHEME INCORPORATING AFC AND INPUT SHAPING TECHNIQUE FOR A SUSPENSION SYSTEM	44

- 6.1 Abstract
- 6.2 Introduction
- 6.3 Dynamics Equation of An Active Suspension
- 6.4 Dynamics Equations of A Hydraulic System
- 6.5 Control Schemes
- 6.6 Results and Discussion
- 6.9 Conclusion

**CHAPTER 7 VEHICLE ACTIVE SUSPENSION SYSTEM
USING SKYHOOK ADAPTIVE NEURO ACTIVE
FORCE CONTROL 51**

- 7.1 Abstract
- 7.2 Introduction
- 7.3 Dynamic Model of An Active Suspension
- 7.4 Dynamic Model of A Pneumatic Actuator
- 7.5 Implementation of Control Methods and Neural Network
- 7.6 Experimental System
- 7.7 Results and Discussion
- 7.8 Conclusion

CHAPTER 8 CONCLUSIONS AND RECOMMENDATIONS 75

- 8.1 Conclusions
- 8.2 Recommendations for Future Works

REFERENCES 77

APPENDICES

APPENDIX A:	Results	83
APPENDIX B:	Photographs of Rig	92
APPENDIX C:	List of Publications	96
APPENDIX D:	Achievements / Outputs	98

LIST OF TABLES

TABLE. NO	TITLE	PAGE
7.1	Vehicle suspension and pneumatic parameters	67

LIST OF FIGURES

FIGURE. NO	TITLE	PAGE
2.1	A quarter car active suspension	10
2.2	A double acting hydraulic strut	11
2.3	The schematic diagram of an AFC scheme	12
2.4	Fuzzy logic controller	13
2.5	A Simulink diagram of the FLAFC scheme	14
2.6	Road surface represented by a single bump with 4 cm height	14
2.7	Step response of FLAFC scheme, fuzzy logic and passive suspensions (a) sprung mass displacement (b) suspension deflection (c) sprung mass acceleration (d) tyre deflection	15
3.1	A Quarter Car Active Suspension	18
3.2	Double Acting Hydraulic Actuator	19
3.3	A Schematic Diagram of AFC Strategy	20
3.4	Neural Network Structure	20
3.5	Fuzzy Logic Controller	20
3.6	A Schematic Diagram of FNAFC Strategy	21
3.7	Road Profile Used in the Study	21
3.8	Estimated Mass	21
3.9	Sprung Mass Displacement	21
3.10	Suspension Deflection	21
3.11	Sprung Mass Acceleration	22
3.12	Tyre Deflection	22
4.1	Quarter Car Vehicle Suspension	28

4.2	Quarter car test rig	28
4.3	The architecture of the suspension dynamics identification	28
4.4	Sinus wave road profile	28
4.5	Square wave road profile	28
4.6	Sprung mass acceleration of sinusoidal wave road profile	29
4.7	Suspension deflection of sinusoidal wave road profile	29
4.8	Sprung mass acceleration of square wave road profile	29
4.9	Suspension deflection of square wave road profile	29
5.1	A quarter car active suspension model	32
5.2	Double acting hydraulic actuator	33
5.3	An adaptive fuzzy scheme	35
5.4	A schematic diagram of an AFC strategy	36
5.5	A block diagram of the proposed AF-AFC scheme	37
5.6	Road profile representing the input disturbance	38
5.7	Membership functions for the input/output parameters of AF1	38
5.8	Simulink diagram of an AF-AFC strategy	39
5.9	Force tracking of hydraulic actuator using (a) sinusoidal (b) saw-tooth and (c) square inputs	40
5.10	Estimated mass for the AFC loop	40
5.11	On-line force tracking error	40
5.12	Sprung mass displacement	40
5.13	Suspension deflection	40
5.14	Sprung mass acceleration	41
5.15	Tyre deflection	41
6.1	A quarter car active suspension	46
6.2	Double acting hydraulic actuator	46
6.3	A schematic diagram of AFC strategy	49
6.4	Road profile	49
6.5	System responses with AFC and input shaping control scheme	50
7.1	A quarter car vehicle active suspension	56
7.2	The pneumatic system	57
7.3	Force tracking PI control	59
7.4	AFC scheme applied to vehicle suspension	61
7.5	Structure of NN (a) Estimates mass (b) Inverse dynamic actuator	65

7.6	Proposed SANAF C control scheme	65
7.7	Experimental set-up and a photograph of the suspension system	66
7.8	Simulink model of the suspension system	66
7.9	Road profile	68
7.10	Force tracking control of the actuator	68
7.11	Active suspensions with a sinusoidal 3.5 cm height, frequency = 1.5 Hz (a) simulation (b) experiment	69
7.12	Active suspensions with a sinusoidal 1.25 cm height, frequency = 0.8 Hz (a) simulation (b) experiment	70

LIST OF SYMBOLS / ABBREVIATIONS

SYMBOL	SUBJECT
A	Actuator ram area
a	Measured acceleration of the body
b_s	Damping coefficient
C_d	Discharge coefficient
C_{tm}	Coefficient of total leakage due to pressure
d_k	Teach data or desired output
e_k	Partial network error
F^*	Compensated or estimated force
F_a	Measured force of the actuator
f_a	Actuator force
k_s	Spring stiffness
k_t	Tyre stiffness
M	Estimated mass of the body
m_s	Sprung mass
m_u	Unsprung mass
O_k	Output of neural networks
p	Number of available patterns
Q_L	Total flow
V_t	Total actuator volume
w	Spool valve area gradient
w_k	Current step weight
w_{k+1}	Next step weight
x_i	Input to the fuzzy networks
y_a	Actual output

y_d	Desired output
z_r	Displacement of road
z_s	Displacement of the car body
z_u	Displacement of wheel (unsprung)
\dot{z}_s	Velocity of car body
\dot{z}_u	Velocity of wheel
$z_s - z_u$	Suspension deflection
$z_u - z_r$	Tyre deflection
α	Set constant
β	Effective bulk modulus
ξ	Damping ratio of the system
ω	Natural frequency
A/D	Analogue-to-Digital
AFAFC	Adaptive Fuzzy Active Force Control
AFC	Active Force Control
AFCIS	Active Force Control with Input Shaping
AFL	Adaptive Fuzzy Logic
BP	Backpropagation
D/A	Digital-to-Analogue
DAS	Data Acquisition System
FL	Fuzzy Logic
FLAFC	Fuzzy Logic Active Force Control
FNAFC	Fuzzy Neuro Active Force Control
I/O	Input/Output
IS	Input Shaping
LM	Levenberg-Marquardt
LVDT	Linear Variable Differential Transformer
NN	Neural Network
PC	Personal Computer
PI	Proportional-Integral
PID	Proportional-Integral-Derivative
PIDAFRC	Proportional-Integral-Derivative and Active Force Control

PLC	Programmable Logic Controller
PSO	Particle Swarm Optimisation
RTW	Real-Time Workshop
SANAFc	Skyhook Adaptive Neuro Active Force Control

CHAPTER 1

INTRODUCTION

1.1 General Introduction

Suspension system is indeed an integral component of a vehicle. The main requirements of a vehicle suspension are that it should be able to minimize the vertical displacement and the acceleration of the body in order to increase the passenger comfort, minimize the dynamic tyre load to provide maximum road handling and react to the changes of mass payload. It is generally thought that in order to achieve a good ride comfort, the suspension should be soft enough, whereas for good road handling capability, it requires stiff suspension. Because of these conflicting demands, suspension design has had to be something of a compromise, which is largely determined by the type of vehicle usage. In the conventional or passive suspension system, the mass-spring-damper parameters are generally fixed, and they are chosen based on the design requirements of the vehicles. The suspension has the ability to store energy in the spring and dissipate it through the damper. When a spring supports a load, it will compress until the force produced by the compression is equal to that of the load on it. If some other force then disturbs the load, then the load will oscillate up and down or fluctuate around its original position for a period of time. Passive suspension system utilizing mechanical springs and dampers is known to have the limitations of vibration isolation and lack of altitude control of the vehicle body. To overcome these problems, many researchers have studied various active and semi-active suspensions both theoretically and experimentally.

In semi active suspension systems, it still employs springs as the main form of support, however the dampers can usually be controlled. A semi active suspension has the ability to change the damping characteristics of the shock absorbers without any use of actuators. Recently, electrorheological (ER) and magnetorheological (MR) fluids are used in order to control the dampers. Active suspension differs from the conventional passive suspension in their ability to inject energy into the system. In an active suspension system, an actuator is connected in parallel with a spring and a shock absorber in between the sprung and unsprung masses. The actuator is used to generate the desired force in any direction, regardless of the relative velocity across it to achieve the desired performance. The ability to control the energy from external source according to the environment provides the flexibility in control and better performance of suspension system. For this reason, the active suspension is widely investigated and studied.

1.2 Outline of Research

The active force control (AFC) strategy applied to dynamical system has been first introduced by Hewit (Hewit and Burdess, 1981). AFC has been shown to be very robust and practical in compensating disturbances and changes in the parameters when applied to a dynamic system. The method involves the measurements of two physical quantities (acceleration of the main physical system and the applied force) and the appropriate estimation of the mass matrix of the system. This involves the use of precision sensors and appropriate approximation technique (via intelligent method). Excellent results obtained from the previous simulation studies imply the effectiveness of both the intelligent mechanisms. In the proposed research, intelligent AFC technique featuring the extreme robustness characteristic is exploited to the control of an automotive suspension system by introducing an active element in the form of disturbance rejector mechanism which will considerably improve system performance particularly related to human riding comfort aspect in the event the system encounters a number of adverse conditions due to vibration, uneven road surfaces, 'bumps' and 'holes'. The research

emphasizes the full development of the system to be investigated both theoretically as well as experimentally. The use of intelligent AFC applied to the system might include iterative learning (IL) algorithm, neural network (NN), fuzzy logic (FL) or their combination (hybrid).

1.3 Objective of Research

The specific objectives of research are:

- To develop a very robust active suspension system using intelligent active force control strategy
- To simulate and study the performance of the proposed system
- To design and develop a prototype of the experimental automotive suspension system.

1.4 Scope of Research

The scope of research shall encompass the followings:

- Literature review on vehicle suspension modelling, active control and intelligent systems.
- Only a quarter car model is considered and a vertical displacement of the sprung mass (body) is assumed.
- Theoretical design and simulation of a number of advanced robust control schemes based on Active Force Control (AFC) with intelligent elements, namely fuzzy logic (FL), neural network (NN) or combination (hybrid). The main software design tool is MATLAB/Simulink.

- Design and development of an experimental suspension system including mechatronics design of the suspension, PC-based interfacing, sensors and actuators interfacing and a robot controller programming using C language. A hardware-in-the-loop system based on MATLAB/Simulink and Real-Time Workshop (RTW) shall be rigorously experimented.

1.5 Research Methodology

The project will be divided into five main stages. These are modelling and simulation, incorporation of intelligent controller, design and development of the prototype, experimentation and performance analysis. Initially these areas will be investigated separately by groups of researchers under the supervision of a project leader. Ideas and findings by all the groups will be presented to other group members for transfer of knowledge and experience. *Mechatronic* approach involving the synergy of mechanical, electrical/electronics and computer (software) control would be the main feature of the research methodology. The more detailed description of the research methodology is as follows:

i. Modelling and simulation

The modelling and simulation phase involves rigorous manipulation of mathematical equations representing the system's dynamics and kinematics. Computer programming and software utilisation at this juncture are of prime importance and indispensable. A suitable and practical quarter-car or half-car model based on real physical system will be identified and scrutinized for the above-mentioned purpose. Realistic and valid assumptions based on the proposed system will be made in the process. A number of intelligent methods such as NN, FL, *EC* and IL or their combination (hybrid) will be studied and later implemented with the parent AFC strategy to control the system. Their algorithms and techniques will be thoroughly investigated and studied. Comprehensive simulation works will include the evaluation of the system's performance and robustness against various forms of

disturbances, vibration and other different operating and loading conditions. Changes in the parameters such as those related to the physical values of the mechanical spring-damper system, simulation and learning algorithms will also be taken into account. Expected results to be analysed are the frequency and time responses, body acceleration, and the effects of the introduced disturbances and other given conditions. A comparative study between a number of control strategies will also be considered to provide a useful platform in determining the 'optimum' and best control method. The modelling and simulation work would serve as a basis for designing and developing the prototype (experimental rig) in later stages.

ii. Incorporation of intelligent controller

A suitable intelligent controller will be identified based on the outcome of the simulation study. The controller is chosen in the form of control algorithm such that its practical implementation in real time is feasible and readily applied. Relevant parameters of the controller will be refined and related computer program will be written for this purpose. Development of a possible hardware for the controller will be fully investigated and looked into. This will largely involve aspects of computer programming, interfacing, electrical/electronics and sensory feedbacks. Digital control based on the PC system is employed and the application of microcontroller is a possibility and will be relevantly explored.

iii. Design and development of the prototype

Mechatronics approach is emphasized here encompassing the aspects of mechanical, electrical/electronics and computer control. A complete integration of the mentioned disciplines is very essential.

Mechanical: Mechanical design initially involves the conceptual design of the physical suspension system and related mechanisms. A number of factors and suitable design criteria should be carefully considered in the design process. A finalized design is subsequently chosen with the detailed production drawings ensued for fabrication purposes. Some of the mechanical aspects of the system such as the computation of the parameters for the hydraulic servo mechanism, the

length of actuator's stroke, dimensions of the system structure or parts can be obtained and/or manipulated from the simulation study.

Electrical/electronics: Electrical and electronics will include proper selection of sensor, motor, driver, controller or amplifier. Instrumentation is also involved and a number of selected electronic circuitries would be exploited and utilised in the research. A good knowledge and skill in electronics assembly is highly desirable at this stage. Again, the outcome from the simulation works help in determining for example the size (power, force, torque etc.) of the electric actuator to be used.

Computer control: The next stage will involve rigorous computer interfacing and control involving data acquisition process through the use of *analogue-to-digital-digital-to-analogue* (ADDA) card and a PC for software control. Computer programming at this stage is of paramount importance since it serves as the link between the mechanical and electrical/electronics components. Again, digital control is applied here to also include item (ii).

iv. Experimentation

When the mechatronic system prototype is ready, experimental procedures will be drafted and testing will be done to validate the effectiveness and the robustness of the control strategy. Possible modification of the system can be carried out at this stage to enhance the system's performance. Experimentation will be rigorously carried out to test the effectiveness of the proposed system. The tests will take into account various operating and loading conditions.

v. Performance evaluation and analysis

Finally, the system's performance will be critically evaluated and analysed. This includes the results obtained from both the simulated and prototype developmental activities. The research outcomes should provide insights and information which would be useful for future development, improvement and expansion of the system. In addition to that, suggestion for further research works will also be outlined.

1.6 Organization of Report

The report is organized into eight chapters. Chapter 1 deals with the description of research background, objectives, scope and methodology. Chapters 2 to 7 are actually technical papers that are either published in or submitted to conference proceedings and journals at both national and international levels.

Chapter 2: Control Design of A Quarter Car Suspension System using Fuzzy Logic Active Force Control.

Chapter 3: Fuzzy Logic Artificial Neural Network Active Force Control for an Active Suspension of a Quarter Car.

Chapter 4: Particle Swarm Optimization Neural Network Based Modelling of Vehicle Suspension System.

Chapter 5: Simulation of A Suspension System With Adaptive Fuzzy Active Force Control.

Chapter 6: Hybrid Control Scheme Incorporating AFC and Input Shaping Technique For A Suspension System.

Chapter 7: Vehicle Active Suspension System Using Skyhook Adaptive Neuro Active Force Control.

Finally, Chapter 8 concludes the research project. The directions and recommendations for future research works are also outlined in this chapter. Some of the additional materials pertaining to relevant results of the study, photographs of rig, publications and achievements related to the research are enclosed in the appendices.

Controller Design for an Active Suspension of a Quarter Car Model Using Fuzzy Logic Active Force Control

Gigih Priyandoko and Musa Mailah

Intelligent Active Force Control Research Group
Department of Applied Mechanics, Faculty of Mechanical Engineering
Universiti Teknologi Malaysia
81310 Skudai, Johor
MALAYSIA

gigih@mech.fkm.utm.my and musa@fkm.utm.my

ABSTRACT

This paper discusses the design of a novel control technique for an active vehicle suspension system using fuzzy logic (FL) controller with an active force control (AFC) element. The control strategy is implemented to control a nonlinear actuator attached between the sprung mass and the unsprung mass of the quarter car model that provides the energy into the system based on the control signal through feedback information from the sensors placed at strategic location in the system. The performance of the proposed control scheme is then evaluated and compared with other methods to examine the effectiveness of the scheme in suppressing the vibration and other disturbances presence in the passenger car suspension system. Results show that an active suspension system with fuzzy logic active force control (FLAFC) produced a much improved desirable performance compared to the pure FL controller and the passive suspension systems.

1. INTRODUCTION

In designing suspension system, there should be a compromise between the passenger comfort and good handling of the vehicle. The main requirements of a vehicle suspension are that it should be able to minimize the vertical displacement and the acceleration of the body in order to increase the passenger comfort, minimize the dynamic tyre load to provide maximum road handling and react to the changes of mass payload. It is generally thought that in order to achieve a good ride comfort, the suspension should be soft enough, whereas for good road handling capability, it requires stiff suspension. Because of these conflicting demands, suspension design has had to be something of a compromise, which is largely determined by the type of vehicle usage. In the conventional or passive suspension system, the mass-spring-damper parameters are generally fixed, and they are chosen based on the design requirements of the vehicles. The suspension has the ability to store energy in the spring and dissipate it through the damper. When a spring supports a load, it will compress until the force produced by the compression is equal to that of the load on it. If some other force then disturbs the load, then the load will oscillate up and down or fluctuate around its original position for a period of time. Passive suspension system utilizing mechanical springs and dampers is known to have the limitations of vibration isolation and lack of altitude control of the vehicle body. To overcome these problems, many researchers have studied various active and semi-active suspensions both theoretically and experimentally.

In semi active suspension systems, it still employs springs as the main form of support, however the dampers can usually be controlled. A semi active suspension has the ability to change the damping characteristics of the shock absorbers without any use of actuators. Recently, electrorheological (ER) and magnetorheological (MR) fluids are used in order to control the dampers [1]. Active suspension differs from the conventional passive suspension in their ability to inject energy into the system. In an active suspension system, an actuator is connected in parallel with a spring and a shock absorber in between the sprung and unsprung masses. The actuator is used to generate the desired force in any direction, regardless

of the relative velocity across it to achieve the desired performance. The ability to control the energy from external source according to the environment provides the flexibility in control and better performance of suspension system. For this reason, the active suspension is widely investigated and studied.

A number of techniques and design methodologies have been proposed. *Linear Quadratic Regulator* control, *Linear Quadratic Gaussian* control, adaptive control, nonlinear control, among other techniques, have been used to reduce the parameters of close loop suspension system [2,3]. However, an accurate system model must be available before the controller can be developed and applied.

Fuzzy logic (FL) control methods have been used extensively in recent years in a number of applications such as automatic transmission, Sendai subway operation, cold rolling mills, self-parking model car, image stabilizer for video camera and fully automated washing machine [4]. Fuzzy logic controller has also been successfully implemented in an active suspension systems [5-7]. Unlike conventional controllers, a fuzzy logic control law does not require a mathematical modelling and it can be easily realized on a single integrated circuit (IC) chip .

The objective of this research is to design a controller of active suspension system to minimize vertical body displacement, suspension deflection, tyre deflection and body acceleration using fuzzy logic AFC strategy, thereby improving the system's overall performance. The paper is organized as follows. The dynamics of a quarter car model is introduced in section 2 while that of a double acting hydraulic strut in section 3. AFC strategy and fuzzy logic controller are described in section 4 and 5 respectively. The results of the simulation are discussed in section 6. Finally, this paper is concluded in section 7.

2. DYNAMICS OF AN ACTIVE SUSPENSION SYSTEM

The model of the quarter car active suspension system used in the study is shown in Figure 1. It is presented by a two-degrees-of-freedom model.

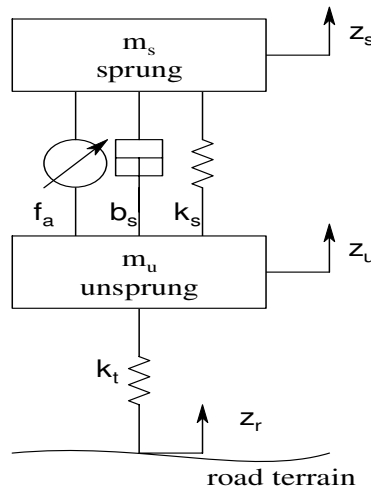

Figure 1. A quarter car active suspension.

The equations of motion for this system are given as follows [8]:

$$\begin{aligned} m_s \ddot{z}_s &= -k_s(z_s - z_u) - b_s(\dot{z}_s - \dot{z}_u) + f_a \\ m_u \ddot{z}_u &= k_s(z_s - z_u) + b_s(\dot{z}_s - \dot{z}_u) - k_t(z_u - z_r) - f_a \end{aligned} \quad (1)$$

where

- m_s = sprung mass
- m_u = unsprung mass
- b_s = damping coefficient

k_s	= spring stiffness
k_t	= tyre stiffness
f_a	= actuator force
z_s	= displacement of the car body
z_u	= displacement of wheel (unsprung)
z_r	= displacement of road
$z_s - z_u$	= suspension deflection
$z_u - z_r$	= tyre deflection
\dot{z}_s	= velocity of car body
\dot{z}_u	= velocity of wheel

It is assumed that the suspension spring and tyre stiffnesses are linear in their operation range, the tyre does not leave the ground and that the displacement of body and wheel are measured from the static equilibrium point.

3. DYNAMICS OF A DOUBLE ACTING HYDRAULIC STRUT

Figure 2 depicts a schematic diagram of a translational double acting hydraulic actuator driven by a three-land four-way spool valve. An actuator is assumed to be placed between the sprung and unsprung masses and can exert a force f_a in between m_s and m_u .

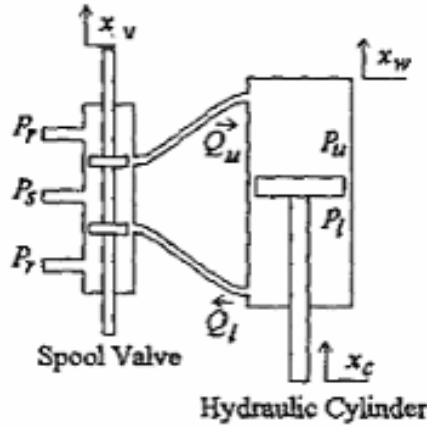

Figure 2. A double acting hydraulic strut

The hydraulic actuator consists of a spool valve (servo valve) and a hydraulic cylinder as shown in the figure. P_s and P_r are the supply and return pressure going into and out of the spool valve respectively. x_v is the spool valve position. P_u and P_l are the oil pressure in the upper and lower cylinder chambers respectively. $x_w - x_c$ is the hydraulic piston displacement. The differential equation governing the dynamics of the actuator is given as follows [8]:

$$\frac{V_t}{4\beta} \dot{P}_L = Q_L - C_{tm} P_L - A(\dot{z}_s - \dot{z}_u) \quad (2)$$

where

V_t	= total actuator volume
β	= effective bulk modulus
A	= actuator ram area
C_{tm}	= coefficient of total leakage due to pressure
Q_L	= total flow given by

$$Q_L = C_d w x_v \sqrt{\frac{P_s - \text{sgn}(x_v) P_L}{\rho}} \quad (3)$$

where

- C_d = discharge coefficient
 w = spool valve area gradient

It should be noted that a proportional-integral-derivative (PID) control is assumed to be associated with the hydraulic actuator to ensure optimal performance of the actuator during its implementation in the proposed control scheme [8].

4. ACTIVE FORCE CONTROL

Active force control (AFC) strategy was first proposed by *Hewit* and co-worker to control a dynamic system in order to ensure the system remains stable and robust in the presence of known and unknown disturbances [9,10]. AFC has demonstrated to be superior compared to conventional methods in controlling a robot arm [9-11]. The concept of AFC can be traced back from the classic *Newton's* second law of motion. Its main underlying principle is to use some measured and estimated values of the identified system parameters namely the actuated force and acceleration of the body (both measured) and the estimated mass of the moving body (estimated). Thus, for a translational system, the main control law of AFC can be described as follows:

$$F^* = F_a - M a \quad (4)$$

where, F^* is the compensated or estimated force, F_a is the measured force of the actuator, M is the estimated mass of the body and a is the measured acceleration of the body. The effective computation of F^* shall bring about robust performance of the system in encountering various forms of disturbances. The main drawback of AFC is to appropriately estimate the mass needed in the AFC loop. Figure 3 illustrates the application of AFC scheme to a translational dynamic system. In the figure, it is clear that the overall control system comprises two degrees-of-freedom controller having two control loops, namely the outer loop governed by the classic controller (or other types such as fuzzy logic controller used in the study) and the inner loop which contains the AFC element. Note that the computed estimated force, F^* should be fed back into the main AFC the loop through a transfer function (typically $1/F_a$). Practically, the variables to be measured, i.e F_a and a can be easily acquired using physical sensing devices (force sensor and accelerometer) while M can be obtained through heuristic means or intelligent mechanisms. In the study, the latter method was used to appropriately estimate the variable.

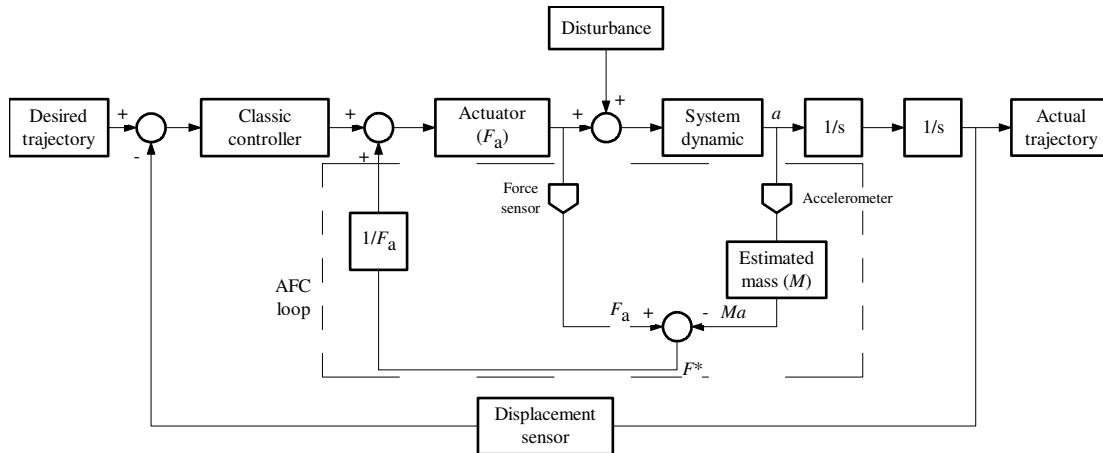

Figure 3. The schematic diagram of an AFC scheme

5. FUZZY LOGIC CONTROLLER

A fuzzy logic control component employed in the study is designed in such a way that it replaces the classic PID controller that is typically used in a control system. Its main objective is to provide the force control signal that shall complement the AFC signal to actuate the non-linear hydraulic actuator. The overall fuzzy logic control procedure typically composed of a number of processes, namely the fuzzification process, establishment of fuzzy rule base and defuzzification process. The first step is fuzzification in which crisp input values are transformed into fuzzy input involving the construction of suitable membership functions representing the fuzzy set. Some of the information for the design and construction of membership functions are obtained through human expert's judgement and others through results of previous study. This is followed by the process of rules evaluation normally in the form of linguistic statements to determine the dynamics of the controller as a response to the given fuzzy input. It is then passed through a defuzzification process using an averaging technique to produce crisp output values [12]. The structure of the fuzzy logic controller used in the study is shown in Figure 4. *Gaussian* membership functions is used in the fuzzification procedure and produce favourable outcome. *Mamdani's* minimum operation rule (which is a popularly used method) is employed as the fuzzy implication function (inference mechanism), and centre of gravity technique is applied to the defuzzification procedure. The two inputs of the fuzzy logic controller are the suspension deflection and suspension velocity while the output is represented by the force vector which shall become the input to the hydraulic actuator [7] and serves as the initial control signal of the outer control loop. MATLAB with Fuzzy Logic Toolbox and Simulink softwares are used in the simulation study.

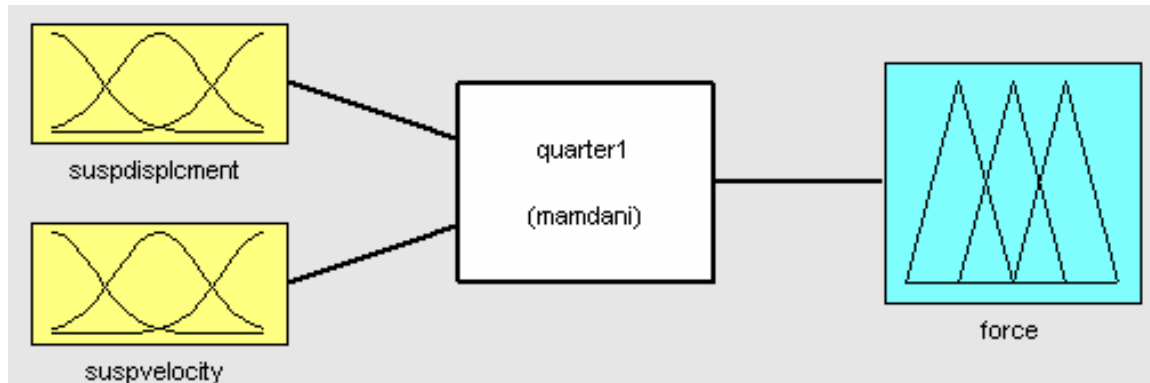

Figure 4. Fuzzy logic controller

6. SIMULATION, RESULTS AND DISCUSSION

The Simulink diagram of the FLAFC scheme applied to active suspension system is shown schematically in Figure 5. It consists of the PID controller for the hydraulic double acting actuator model, AFC element, vehicle system dynamic model, fuzzy logic controller, disturbances and reference input of the system. Vehicle system dynamic has two inputs which are the road disturbance and actuated force from the hydraulic actuator. This system dynamic meanwhile has four outputs related to the body displacement, suspension deflection, tyre deflection and body acceleration. Road profile as shown in Figure 6, is represented by a step function as a single bump on the road with 4 cm bump height. It is considered as the introduced disturbance for the experimentation of the developed model to verify the system's robustness. Vehicle system dynamic model is represented by the specific dynamics of the quarter car active suspension system as described by equation (1).

The PID controller parameters are first selected by performing a number of trial runs until satisfactory results are obtained. The output of hydraulic actuator then becomes the input to the quarter car active suspension systems and the AFC component. AFC scheme has two inputs which are related to the actuated force of the hydraulic actuator and body acceleration signals. The estimation of mass needed by

AFC loop is the main factor which contribute to the effectiveness of the control scheme. In this simulation, the estimated mass was acquired using a crude approximation method.

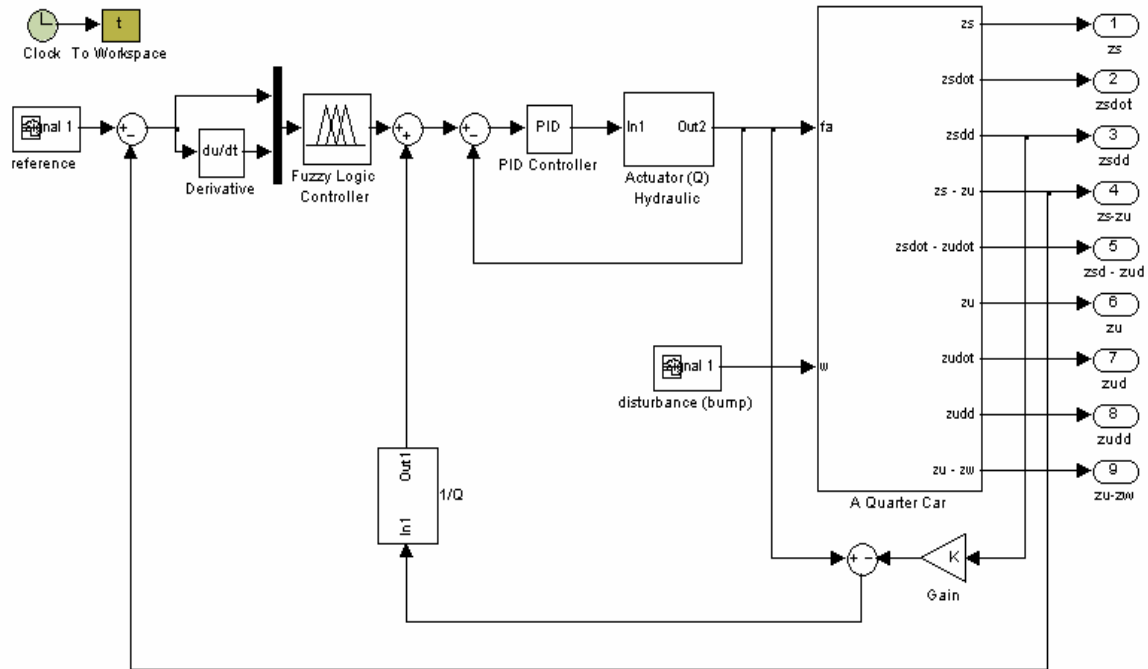

Figure 5.A Simulink diagram of the FLAFC scheme.

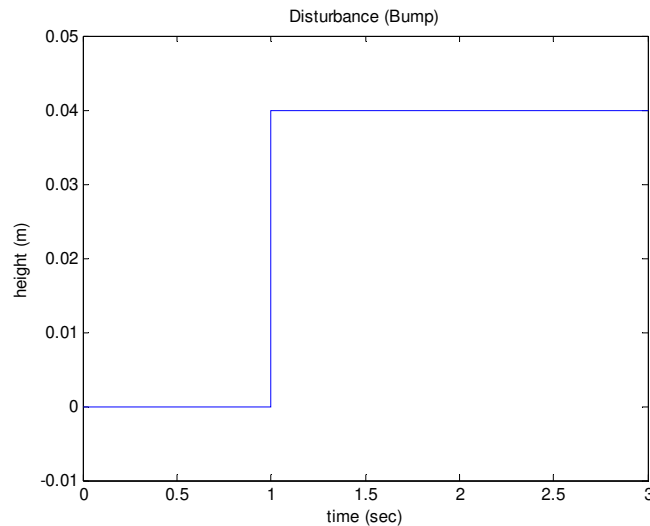

Figure 6. Road surface represented by a single bump with 4 cm height.

The simulation works have been performed considering the parameters and conditions explained in [5,8] to demonstrate the mass sprung displacement, suspension deflection, tyre deflection when the car hitting the bump when the system is executed. The results of the simulations are graphically shown in Figures 7 (a) to (d). In each case, the solid line shows the response of the proposed FLAFC method, the dotted line shows the response of the fuzzy logic (FL) strategy while the dashed line is for passive suspension. It is very obvious that the FLAFC produces the best performance compared to its counterparts in compensating the introduced disturbance. This shows that the system is more robust and effective.

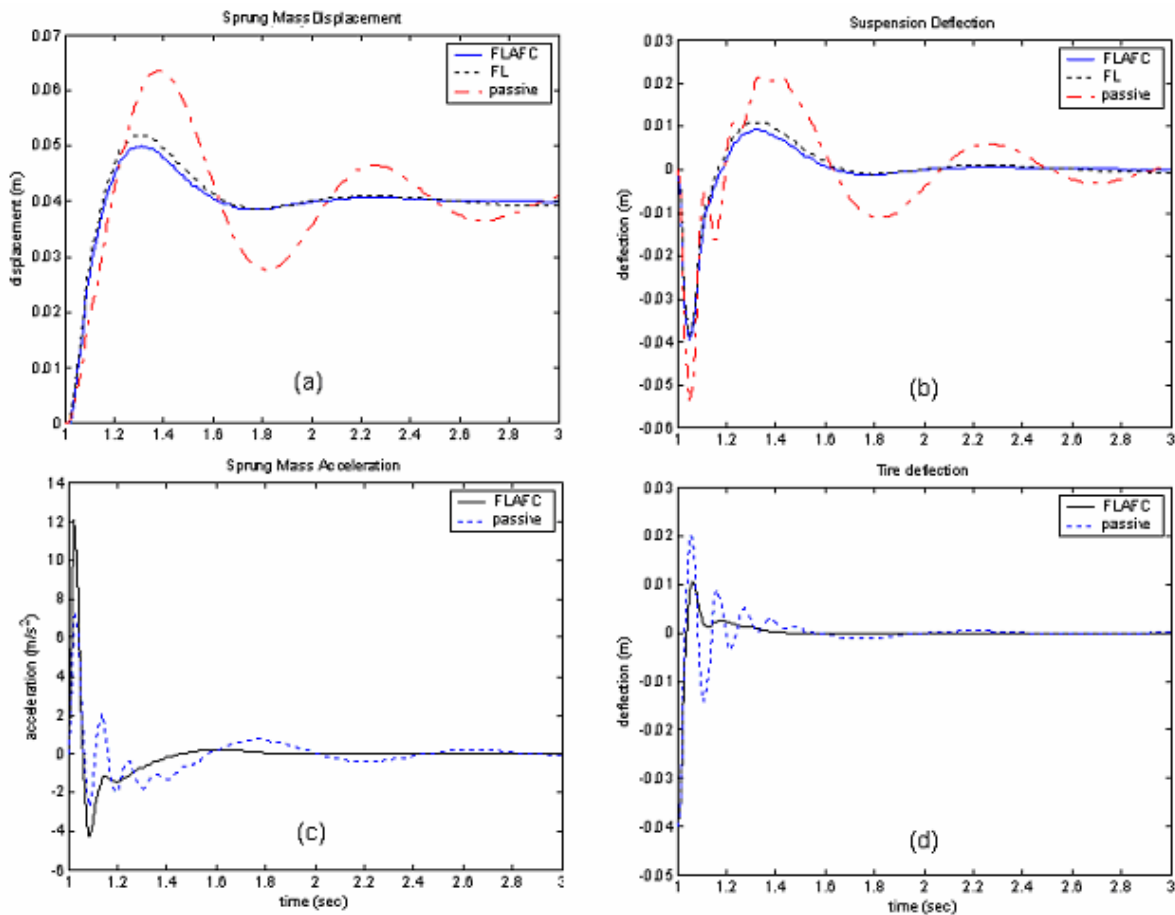

Figure 7. Step response of FLAFC scheme, fuzzy logic and passive suspensions
 (a) sprung mass displacement (b) suspension deflection
 (c) sprung mass acceleration (d) tyre deflection

7. CONCLUSION

A new type of control method in the form of fuzzy logic iterative learning active force control (FLAFC) for an active suspension system has been designed and applied. Result show that for given condition and parameters, the proposed system FLAFC yields improved performance compared to the rest of the systems considered in the study. However, further investigation should be carried out to study the effects of other road conditions (disturbances), different loading conditions, uncertainties and parametric changes.

ACKNOWLEDGEMENTS

The authors would like to thank the *Malaysian Ministry of Science and Technology and the Innovation* (MOSTI) and *Universiti Teknologi Malaysia* (UTM) for their continuous support in the research work. This research was fully supported by an IRPA grant (No. 03-02-06-0123EA001).

REFERENCES

- [1] K. Hudha, H. Jamaluddin, P.M. Samin, R.A. Rahman, "Active Roll Control Suspension System (ARCS) Using Active Force Control Strategy on A New Modified Half Car Model", SAE, 2003.

- [2] Z. Omar, Modelling and Simulation of an Active Suspension System Using Active Force Control Strategy, MSc Report, Universiti Teknologi Malaysia, 2002.
- [3] Y.M. Sam, Modelling and Control of Hydraulically Actuated Active Suspension Systems, PhD Thesis, Universiti Teknologi Malaysia, 2004.
- [4] Barr, A.J.; Ray, J.I, Control of an active suspension using fuzzy logic, Proceedings of the Fifth IEEE International Conference on Fuzzy Systems, Vol. 1, Pages:42 - 48 vol.1, 8-11 Sept. 1996.
- [5] M.V.C. Rao, V. Prahlad, "A Tunable Fuzzy Logic Controller for Vehicle Active Suspension Systems", Fuzzy Set and System, 1997.
- [6] F.J. D'Amato, D.E. Viassolo, "Fuzzy Control for Active Suspensions", Mechatronics, 2000.
- [7] J. Campos, F.L. Lewis, L. Davis, S. Ikenaga, "Backstepping Based Fuzzy Control of Active Vehicle Suspension Systems", American Control Conference, 2000. Proceedings of the 2000, Volume: 6, 28-30 June 2000.
- [8] A. Alleyne, R. Liu, H. Wright, "On the Limitations of Force Tracking Control for Hydraulic Active Suspensions", Proc. Of the American Control Conference, Philadelphia, Pennsylvania, June, 1998.
- [9] S.B. Hussein, H. Jamaluddin, M. Mailah and A. Zalzal, "A Hybrid Intelligent Active Force Controller For Robot Arm Using Evolutionary Neural Networks", Proc. Int'l Conference on Evolutionary Computation (CEC 2000), San Diego, USA, July 2000.
- [10] M. Mailah, Intelligent Active Force Control of a Rigid Robot Arm Using Neural Network and Iterative Learning Algorithms, PhD Theses, University of Dundee, 1998.
- [11] M. Mailah, N.I.A. Rahim, "Intelligent Active Force Control of a Robot Arm Using Fuzzy Logic", IEEE International Conference on Intelligent Systems and technologies TENCON 2000, Kuala Lumpur, September 2000.
- [12] M. Negnevitsky, Artificial Intelligence: A Guide to Intelligent Systems, Addison Wesley, 2002.

CHAPTER 2

CONTROL DESIGN OF A QUARTER CAR SUSPENSION SYSTEM USING FUZZY LOGIC ACTIVE FORCE CONTROL

Gigih Priyandoko & Musa Mailah

*Presented at International Conference on Mechatronics 2005 (ICOM05), Kuala
Lumpur, May 2005*

Fuzzy-Neuro Active Force Control of a Quarter Car Suspension System

Gigih Priyandoko, Musa Mailah

Intelligent Active Force Control Research Group,
Department of Applied Mechanics, Faculty of Mechanical Engineering, Universiti Teknologi Malaysia, 81310 Skudai, Johor
Tel: +6075535942, E-mail: gigih@mech.fkm.utm.my, musa@fkm.utm.my

Abstract

This paper presents the design of a control technique applied to an active suspension system of a quarter car model using fuzzy logic controller with artificial neural network embedded in the active force control component. The overall control system is decomposed into two loops. In the main loop, the desired force signal is calculated using an active force control strategy with a neural network element being employed to estimate the mass needed to feed the forward control loop. A fuzzy logic controller is implemented in the outer loop to design a force controller such that the desired force signal is achieved in a robust manner. The resulting control strategy known as fuzzy-neuro active force controller (FNAFC), is then used to control a nonlinear actuator attached between the sprung mass and the unsprung mass of the quarter car model. The performances of the proposed control method were then evaluated and later compared to examine the effectiveness in suppressing the vibration effect of the suspension system. It was found that the active suspension system with fuzzy-neuro active force control gives better performance compared to the fuzzy logic and the passive suspension system.

Keywords

Active suspension, quarter car, fuzzy logic control, artificial neural network, active force control.

Introduction

For many years, automobile suspension primarily consists of a coil or leaf spring in parallel with viscous damper. The control of automobile suspensions is currently of great interest in both the academic and industrial fields. Suspension design requires a compromise between the passenger comfort and good handling vehicle. To provide a good ride comfort, the suspension should be soft enough, but whereas good road holding requires stiff suspension. A good vehicle suspension should be able to minimize the vertical displacement and the acceleration of the body, however, in order to increase the passenger comfort, the sprung mass displacement need to be minimized. In the conventional passive suspension system, the mass-spring-damper parameters are generally fixed, and they are chosen based on the design requirements of the vehicles. The suspension has the ability to store energy in the spring and to dissipate it through the damper. When a spring supports a load, it will compress until the force produced by the compression is equal to the load force. If some other forces then disturb the

load, then the load will oscillate up and down around its original position for some time. Passive suspension utilizing mechanical springs and dampers is known to have the limitations of vibration isolation and lack of attitude control of the vehicle body. To solve these problems, many researchers have studied various active and semi-active suspensions both theoretically and experimentally. In semi active suspension systems, it still uses springs as the main form of support, however the dampers can be controlled. A semi active suspension has the ability to change the damping characteristics of the shock absorbers without using any actuators. Active suspension differs from the conventional passive suspension in its ability to inject energy into the system. In an active suspension system, an actuator is attached in parallel with both a spring and a shock absorber. To achieve the desired performance, actuator should generate the desired force in any direction, regardless of the relative velocity across it. The ability to control the energy from external source according to the environment provides better performance of suspension system. For this reason, the active suspension has been widely investigated [1-5].

The objective of this study is to design a controller of active suspension system that can reduce the vertical body displacement, suspension deflection, tyre deflection and body acceleration using fuzzy logic neural network active force control (FNAFC) strategy.

Dynamics Equations of an Active Suspension

The model of the quarter car active suspension system used is shown in Figure 1.

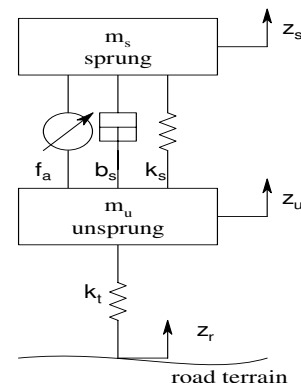

Figure 1 - A Quarter Car Active Suspension

The quarter car model is presented by a two degrees-of-freedom model. The equations of motion for this system are given as [3]:

$$\begin{aligned} m_s \ddot{z}_s &= -k_s(z_s - z_u) - b_s(\dot{z}_s - \dot{z}_u) + f_a \\ m_u \ddot{z}_u &= k_s(z_s - z_u) + b_s(\dot{z}_s - \dot{z}_u) - k_t(z_u - z_r) - f_a \end{aligned} \quad (1)$$

where

- m_s is the sprung mass (body)
- m_u is the unsprung mass (wheel)
- b_s is the damping coefficient
- k_s is the spring stiffness
- k_t is the tyre stiffness
- f_a is the actuator force
- z_s is the displacement of the car body
- z_u is the displacement of wheel
- z_r is the displacement of road
- $z_s - z_u$ is the suspension deflection
- $z_u - z_r$ is the tyre deflection
- \dot{z}_s is the velocity of the car body
- \dot{z}_u is the velocity of wheel

By assuming that the suspension spring and tyre stiffnesses are linear in their operating ranges, the tyre does not leave the ground. The displacements of both the body and wheel can be measured from the static equilibrium point.

Dynamic Equations of A Hydraulic Actuator

Figure 2 depicts a schematic diagram of a translational double acting hydraulic actuator driven by a three-land four-way spool valve. An actuator is assumed to be placed between the sprung and unsprung masses and can exert a force f_a in between m_s and m_u .

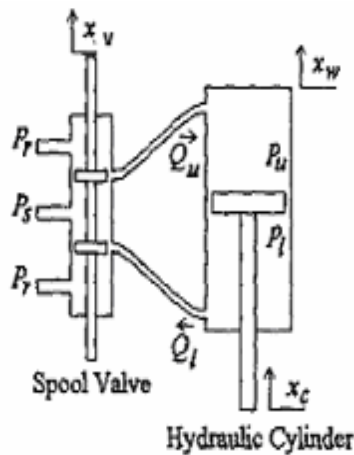

Figure 2 - Double Acting Hydraulic Actuator

The hydraulic actuator is assumed to consist of a spool valve (servo valve) and a hydraulic cylinder. P_s and P_r are the

supply and return pressures going into and out of the spool valve, respectively. x_{sp} is spool valve position. P_u and P_l are the oil pressure in the upper and lower cylinder chambers. $x_w - x_c$ is the hydraulic piston displacement.

The differential equation governing the dynamics of the actuator is given in [3] as follows:

$$\frac{V_t}{4\beta} \dot{P}_L = Q_L - C_{lm} P_L - A(\dot{z}_s - \dot{z}_u) \quad (2)$$

where V_t , β_e , A and C_{lm} are the total actuator volume, effective bulk modulus, actuator ram area and coefficient of total leakage due to pressure respectively.

Using the equation for hydraulic fluid flow through an orifice, the relationship between spool valve displacement x_v and the total flow Q_L is given as [3]:

$$Q_L = C_d w x_v \sqrt{\frac{P_s - \text{sgn}(x_v) P_L}{\rho}} \quad (3)$$

where C_d and w are discharge coefficient and spool valve gradient respectively.

Active Force Control

Active force control (AFC) strategy was first proposed by Hewit and co-workers to control a dynamic system in order to ensure the system remain stable and robust in the presence of known and unknown disturbances [6]. AFC has been demonstrated to be superior compared to conventional methods in controlling a robot arm [7,8,6]. AFC can be shown to complement the basic Newton's second law of motion, i.e. for a translational system, $\sum F = ma$, where F is the sum of all forces acting on the body, m is the mass of the body and a is the acceleration. The concept of AFC is to use some measured and estimated values of the identified system parameters namely the actuated forces, acceleration of the body and the estimated mass of the body. The basic AFC equation can then be written as follows:

$$F' = F - m'a' \quad (4)$$

where the superscript ($'$) denotes the measured or estimated values of the parameters. Figure 3 illustrates the principle of AFC applied to a translational system. The measurable physical quantities of the system are the actuating force (F) and the acceleration (a'). These can be measured using force sensor and acceleration sensor, respectively. The estimated mass (m') of the system with the presence of disturbances that contributes to the acceleration should be estimated appropriately. If all the parameters are successfully acquired, then the resulting estimated force (F') from equation (4) should result in a very robust and stable performance of the control system once this signal is fed back to the AFC control loop.

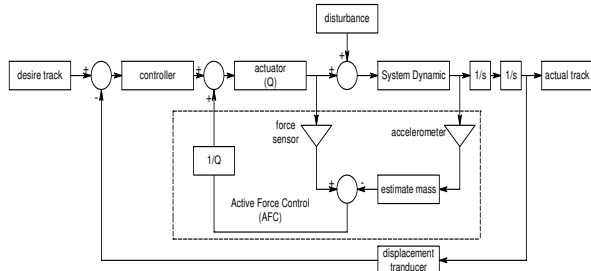

Figure 3 –A Schematic Diagram of AFC Strategy

Neural Network

A neural network is an information processing paradigm that is inspired by the way biological nervous systems, such as the brain, process information. The key element of this paradigm is the novel structure of the information processing system. It is composed of a large number of highly interconnected processing elements (neurons) working in unison to solve specific problems. A trained neural network can be thought of as an expert in the category of information it has been given to analyze. An ability to learn how to do tasks based on the data given for training or initial experience. The structure of neural network in this research is shown in Figure 4. Neural network has three layers, input layer, hidden layer and output layer, respectively. Input layer has two inputs, sprung mass displacement and error system. Hidden layer has three neurons and output layer has one neuron. In order to train the weights of neural network the back propagation method is used using the following adaptation algorithm based on a gradient descent method.

$$w_{k+1} = w_k + \eta \frac{\partial(y_d - y_a)}{\partial w_k} \quad (5)$$

where w_{k+1} is the next step weight, w_k is the current step weight, η is the learning constant, y_d is the desired output and y_a is the actual output. The neural network is used for the approximation of the estimated mass needed by the AFC loop. Neural network training shall be accomplished in an off-line manner until satisfied tracking performance is achieved. Later, the fully trained neural network is implemented on-line as it is embedded into the overall control scheme.

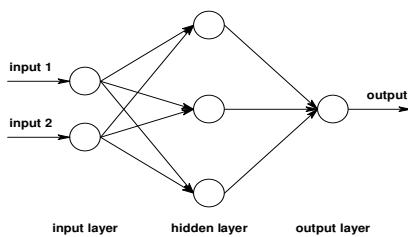

Figure 4 - Neural Network Structure

Fuzzy Logic Controller

The fuzzy logic controller employed in the study is composed of fuzzification, establishment of fuzzy rule base and defuzzification [9]. The first step is fuzzification in which crisp input values are transformed into fuzzy input involving the construction of suitable membership functions representing the fuzzy set. This is followed by the process of rules evaluation normally in the form of linguistic statements to determine the dynamics of the controller as a response to the given fuzzy input. It is then passed through a defuzzification process using an averaging technique to produce crisp output values.

The structure of a fuzzy logic controller is shown in Figure 5. The seven Gaussian membership functions are used in fuzzification. *Mamdani's* minimum operation rule is used as a fuzzy implication function, and centre of gravity method is used for defuzzification. The two inputs of the fuzzy logic controller are suspension deflection and suspension velocity while the output is represented by the force vector which shall become the input to the hydraulic actuator [1,4].

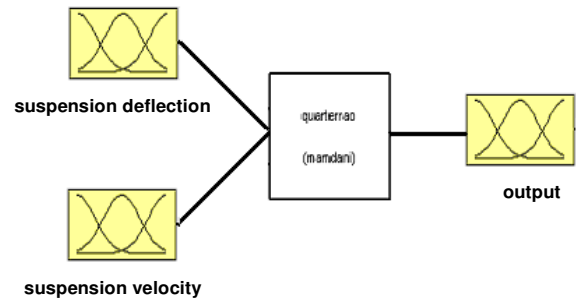

Figure 5 - Fuzzy Logic Controller

Simulation, Results and Discussion

The Simulink diagram of the FNAFC strategy for active suspension system is shown in Figure 6. It consists of the hydraulic double acting actuator model, suspension system dynamic model, neural network, fuzzy logic control, disturbances and reference input of the system.

The system dynamic has two inputs which are road disturbance and active force from hydraulic actuator. This block has four outputs which are the body (sprung mass) displacement, suspension deflection, tyre deflection and body acceleration.

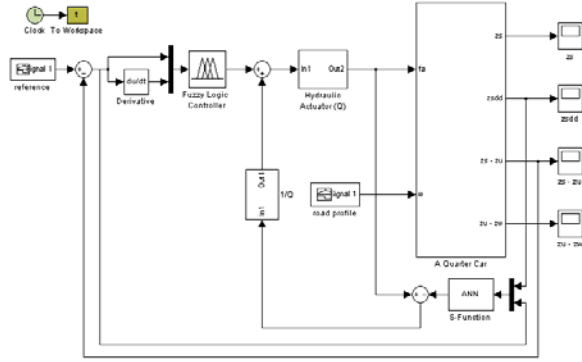

Figure 6 - A Schematic Diagram of FNAFC Strategy

The road profile is shown in Figure 7 which is represented by three bumps on the road with 2 cm, 3 cm and 1 cm bump heights respectively. It is considered as a form of ‘disturbance’ to the system. The output of the hydraulic actuator then becomes the inputs of system dynamics within the AFC control loop. The AFC scheme has two inputs, namely the active force hydraulic actuator and body acceleration components. The estimation of mass needed by AFC loop is the main factor which contribute to the effectiveness of the control scheme. In this simulation, in order to estimate the mass needed to feed the forward AFC loop, neural network strategy is used.

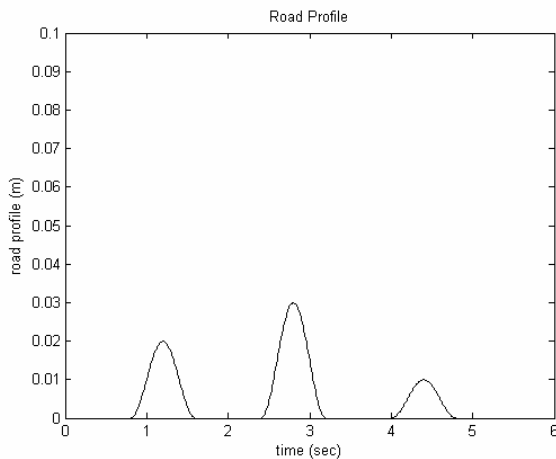

Figure 7 - Road Profile Used in the Study

The simulation works have been done with the parameters and condition explained in [1,3,4] and demonstrate that mass sprung displacement, suspension deflection, tyre deflection when the car hitting the bump. Limit suspension deflection is ± 4 cm. The results for simulations described are given in Figures 8 to 12. In each case, the solid line shows the response of the FNAFC strategy, the dotted line shows the response of the fuzzy logic control strategy and the dashed line shows the response of the passive suspension system. It is obvious that the FNAFC produces the best performance than its counterparts in compensating the introduced

disturbance. This shows that the system is more robust and effective.

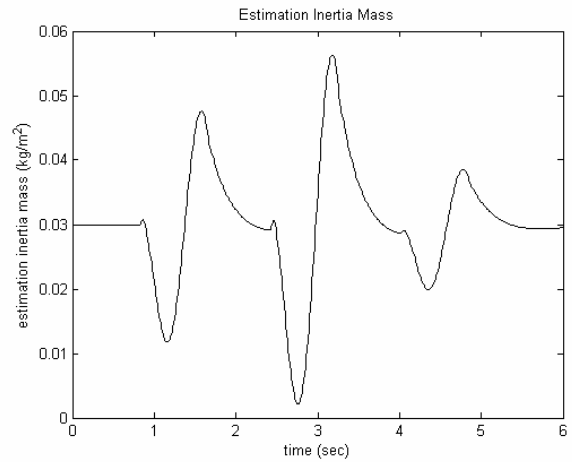

Figure 8 - Estimated Mass

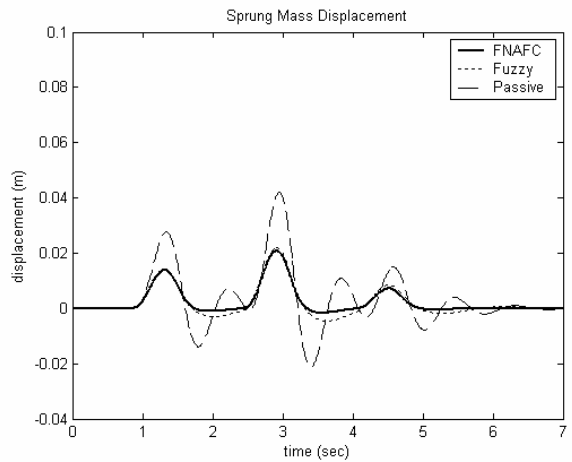

Figure 9 - Sprung Mass Displacement

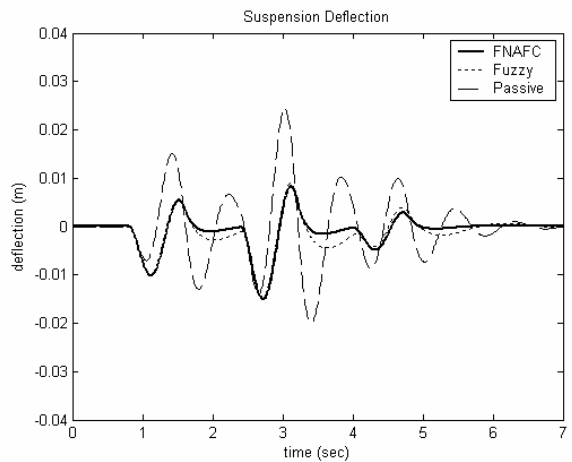

Figure 10 – Suspension Deflection

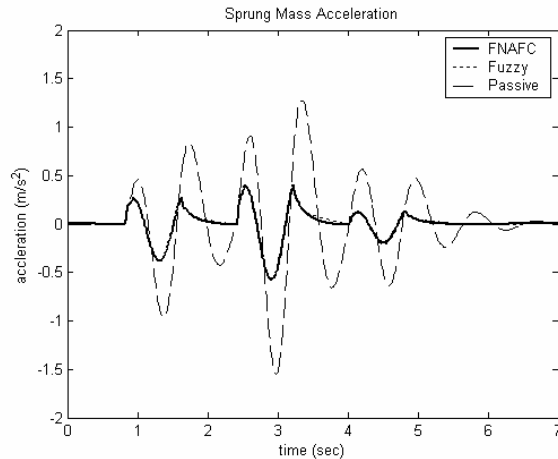

Figure 11 – Sprung Mass Acceleration

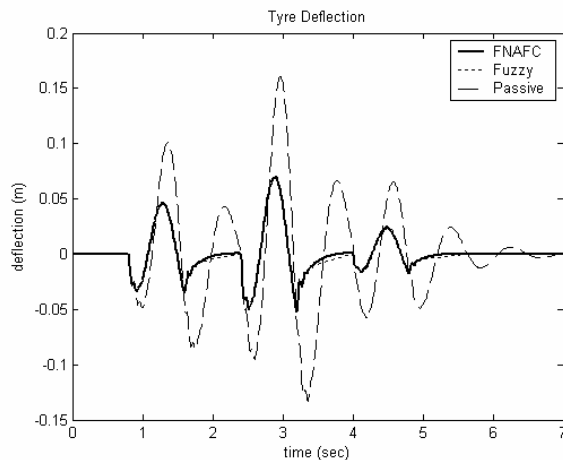

Figure 12 – Tyre Deflection

Conclusion

The resulting control strategy known as fuzzy-neuro active force controller (FNAFC) has been shown to be robust and effective in controlling the suspension system. It was found that the active suspension system with fuzzy-neuro active force control gives better performance compared to the fuzzy logic and the passive suspension systems. All the four main parameters related to body displacement, suspension deflection, body mass acceleration, and tyre deflection have been desirably reduced through the control strategy. This may contribute to improved road handling and riding comfort of the automotive system.

Acknowledgments

The authors would like to thank the *Malaysian Ministry of Science and Technology and the Innovation* (MOSTI) and *Universiti Teknologi Malaysia* (UTM) for their continuous support in the research work. This research was fully supported by an IRPA grant (No. 03-02-06-0123EA001).

References

- [1] Rao, M.V.C., Prahlad, V. 1997. A Tunable Fuzzy Logic Controller for Vehicle Active Suspension Systems, *Fuzzy Sest and System*, 11-21.
- [2] D'Amato, F.J., Viassolo, D.E. 2000. Fuzzy Control for Active Suspensions, *Mechatronics*, (24):897-920.
- [3] Alleyne, A., Liu, R., Wright, H. 1998. On the Limitations of Force Tracking Control for Hydraulic Active Suspensions. In the Proceedings of the American Control Conference, 43-47. Philadelphia, Pennsylvania.
- [4] Barr, A.J.; Ray, J.I. 1996, Control of An Active Suspension Using Fuzzy Logic. In Proceedings of the Fifth IEEE International Conference on Fuzzy Systems, Vol. 1, 42 - 48.
- [5] Campos, J., Lewis, F.L., Davis, L., Ikenaga, S. 2000. Backstepping Based Fuzzy Control of Active Vehicle Suspension Systems. In Proceedings of the American Control Conference, Vol. 6: 28-30.
- [6] Hewit, J. R. and Burdess, J.R. 1981. Fast Dynamic Decoupled Control for Robotics Using Active Force Control, *Transaction on Mechanism and Machine Theory*, 16(5): 535-542.
- [7] Mailah, M., Rahim, N.I.A. 2000. Intelligent Active Force Control of a Robot Arm Using Fuzzy Logic. In Proceedings of IEEE International Conference on Intelligent Systems and Technologies TENCON 2000, Vol. II: 291-297. Kuala Lumpur.
- [8] Hussein, S.B, Jamaluddin, H., Mailah M. and Zalzal, A. 2000, A Hybrid Intelligent Active Force Controller For Robot Arm Using Evolutionary Neural Networks, In Proceedings of the International Conference on Evolutionary Computation (CEC 2000), 117-124. San Diego, USA.
- [9] Negnevitsky, M. 2005, *Artificial Intelligence: A Guide to Intelligent Systems*, 2nd Edition, Addison Wesley.

CHAPTER 3

FUZZY-NEURO ACTIVE FORCE CONTROL OF A QUARTER CAR SUSPENSION SYSTEM

Gigih Priyandoko & Musa Mailah

*Presented at International Conference on Robotics, Vision and Signal Processing
2005 (ROVISP05), Penang, May 2005*

Particle Swarm Optimization Neural Network Based Modelling of Vehicle Suspension System

Gigih Priyandoko Musa Mailah Hishamuddin Jamaluddin

*Department of Applied Mechanics,
Faculty of Mechanical Engineering, Universiti Teknologi Malaysia, 81310 Skudai, Johor Bahru, Malaysia
e-mail: gigihp@gmail.com musa@fkm.utm.my hishamj@fkm.utm.my*

Abstract

This paper presents a novel method for the modelling of a quarter car vehicle suspension system using a Neural Network (NN) technique incorporating Particle Swarm Optimization (PSO) method. The proposed neural network model is shown to be simple in topology and accurate in identification. The PSO element is able to speed up the convergence rate compared to the traditionally slow back-propagation (BP) learning algorithm that is typically employed as one of the most common supervised training methods in a multilayer NN configuration. The design and structure of the scheme based on this approach are adequately described and discussed with the input and output data acquired from a running quarter car test rig. Simulation results from the study show that the NN with PSO as learning method performs better than the BP learning algorithm in executing the proposed task.

Keywords:

Vehicle suspension, modelling, neural network, back-propagation, particle swarm optimization.

1. Introduction

Modelling of a vehicle has been studied for a long time in order to design a high-performance vehicle controller. In the past, most vehicle models have been constructed analytically in the form of dynamic equations. A conventional vehicle model, however, suffers from structural complexity, long development time, and the difficulty of modelling the highly nonlinear terms and the measurement noise. In order to control a real vehicle beyond mere simulation, it is indispensable to model the vehicle quickly, easily, and accurately [1]. In paper [2], the authors develop a comprehensive nonlinear model of a vehicle suspension system. This model is derived using the standard kinematics and kinetics and takes into consideration a number of factors that are neglected in most existing models. Typical control strategies rely on linear and time-invariant models. Buckner *et al.* [3] use neural network that continually learns and estimates the nonlinear parameter variations of a quarter-car suspension model. This estimation algorithm becomes the foundation for an Intelligent Feedback Linearization controller for active vehicle suspensions. Billings *et al.* [4] demonstrated that NNs could be used successfully for the identification and control of non-linear dynamical systems. The most advantageous and distinguishing feature of NNs is their ability to learn. The network in the adaptive mode abstracts and generalizes the function character in the process of learning from

training patterns. The learning algorithm is an optimization method capable of finding weight coefficients and thresholds (learning rates) for a given neural network and a training set. The learning algorithm that is used most frequently is the backpropagation (BP) method. Although BP training has proved to be efficient in many applications, its convergence tends to be slow, and yields to suboptimal solutions [7]. To counter this problem, a particle swarm optimization (PSO) technique is proposed and used in the study. Generally, the PSO is characterized as a simple heuristic of a well balanced mechanism with flexibility to enhance and adapt to both global and local exploration abilities. It is a stochastic search technique with reduced memory requirement, computationally effective and easier to implement [9].

The paper is organized as follows: Section II describes the dynamics of the vehicle suspension system while section III presents the structure of the NNs using BP learning algorithm. Section IV describes the Particle Swarm Optimization technique. The results of the simulation study are discussed and presented in section V. Finally, the paper is concluded in section VI.

2. Quarter Car Vehicle Suspension

A standard assumption in the design and analysis of controllers for vehicle suspension system is that the vertical vehicle dynamics can be

modelled using four independent quarter car suspension models. Quarter car models are simple but yet capture many important characteristics of the full model. Figure 1 depicts a typical two degree-of-freedom quarter car model of a passive suspension system, in which the single wheel and axle are connected to the car body through a passive spring-damper combination, while the tyre is modelled as a simple spring. Figure 2 shows the quarter car test rig. The parameters shown in Figure 1 are defined as follows:

- m_s : sprung mass
- m_u : unsprung mass
- b_s : damping coefficient
- k_s : spring stiffness coefficient
- k_t : tyre stiffness coefficient
- z_s : displacement of the car body (sprung mass)
- z_u : displacement of wheel (unsprung mass)
- z_r : displacement of road
- $z_s - z_u$: suspension deflection
- $z_u - z_r$: tyre deflection
- \dot{z}_s : velocity of sprung mass
- \dot{z}_u : velocity of unsprung mass
- \ddot{z}_s : acceleration of sprung mass
- \ddot{z}_u : acceleration of unsprung mass

3. Neural Network

NN is basically a model structure and contains an algorithm for fitting the model to some given data. The network approach to modelling a plant uses a generic nonlinearity and allows all the parameters to be adjusted. In this way it can deal with a wide range of nonlinearities. Learning is the procedure of training the NN to represent the dynamics of a plant. The NN is placed in parallel with the plant and the error between the output of the system and the network output, the prediction error, is used as the training signal. NNs have a potential for intelligent control systems because they can learn and adapt, approximate nonlinear functions, suited for parallel and distributed processing, and they naturally model multivariable systems.

The advantageous and distinguishing feature of NNs is their ability to learn. The learning algorithm is an optimization method capable of finding weight coefficients and learning rate for a given NNs and a training set.

This algorithm is based on minimizing the error of the NNs output compared to the required output. The required function is specified by the training set. The error of network E relative to the training set is defined as the sum of the partial errors of network E_k relative to the individual

training patterns and depends on network configuration w :

$$e = \sum_{k=1}^p e_k = \frac{1}{2} \sum_{k=1}^p (O_k - d_k)^2 \quad (1)$$

where p is number of available patterns, e_k is partial network error, O_k is output of neural networks, d_k is teach data or desired output.

Updating the weights of each layer using BP method in time $t > 0$ is calculated in order to minimize error as follows [8]:

$$w_{jk}(t) = w_{jk}(t-1) + \Delta w_{jk}(t-1)$$

$$\Delta w_{jk}(t-1) = \alpha \frac{\partial E(t-1)}{\partial w_{jk}} + \beta (w_{jk}(t-1) - w_{jk}(t-2)) \quad (2)$$

where $0 < \alpha < 1$ is the learning rate, β is the momentum. The speed of training is dependent on the set constant α . If a low value is set, the network weights react very slowly. On the contrary, a high value is set the algorithm fails. Therefore, the parameter α is set experimentally.

The structure of the multilayer NN used in the study consists of the input, output and hidden layers. The input layer has three inputs represented by the road profile, sprung mass acceleration and suspension deflection. Output layer has two outputs, namely the sprung mass acceleration and suspension deflection. Every output neuron uses a linear activation function. Hidden layer have three neurons and each neuron uses sigmoid bipolar activation.

4. Particle Swarm Optimization

The PSO idea was originally introduced by Kennedy et al. in 1995 as a technique through individual improvement plus population cooperation and competition, which is based on the simulation of simplified social model, such as bird flocking, fish schooling and the swarm theory. Nowadays PSO has gained much attention and wide applications in various fields [10-12].

The basic PSO algorithm consists of three steps, namely, generating particles' positions and velocities, velocity update, and position update. Here, a particle refers to a point in the design space that changes its position from one move (iteration) to another based on velocity updates.

First, the positions, x_k^i , and velocities, v_k^i , of the initial swarm of particles are randomly generated using upper and lower bounds on the design variables values, x_{min} and x_{max} , as expressed in Equations (3) and (4). The positions and velocities

are given in a vector format with the superscript and subscript denoting the i^{th} particle at time k . In Equations 10 and 11, $rand$ is a uniformly distributed random variable that can take any value between 0 and 1.

$$x_0^i = x_{min} + rand(x_{max} - x_{min}) \quad (3)$$

$$v_0^i = \frac{position}{time} = \frac{x_{min} + rand(x_{max} - x_{min})}{\Delta t} \quad (4)$$

The second step is to update the velocities of all particles at time $k+1$ using the particles objective or fitness values which are functions of the particles current positions in the design space at time k . The fitness function value of a particle determines which particle has the best global value in the current swarm, p_k^g , and also determines the best position p_{best}^i of each particle over time, p^i , i.e. in current and all previous group moves g_{best} . The velocity update formula uses these two pieces of information for each particle in the swarm along with the effect of current motion, v_k^i , to provide a search direction, v_{k+1}^i , for the next iteration. The velocity update formula includes some random parameters, represented by the uniformly distributed variables, $rand$, to ensure good coverage of the design space and avoid entrapment in local optima. The three values that effect the new search direction, namely, current motion, particle own memory, and swarm influence, are incorporated via a summation approach as expressed in Equation (5) with three weight factors, namely, inertia factor, w , self confidence factor, c_1 , and swarm confidence factor, c_2 .

$$v_{k+1}^i = wv_k^i + c_1 rand \frac{(p^i - x_k^i)}{\Delta t} + c_2 rand \frac{(p_k^g - x_k^i)}{\Delta t} \quad (5)$$

The position of each particle is updated using its velocity vector given by

$$x_{k+1}^i = x_k^i + v_{k+1}^i \Delta t \quad (6)$$

5. Results and Discussion

The architecture of the suspension dynamics identification using NN technique is illustrated in Figure 3. Data for identification were extracted from the physical experimental rig with sprung mass weighing approximately 150 kg, unsprung mass 35 kg and tyre pressure equals to 20 psi. Sprung mass (vertical body) acceleration, suspension deflection and tyre deflection were considered as the output variables. The input variable comes in the form of the road profile. Physical sensors were incorporated to obtain the

required input/output signals for identification purpose and they were connected to a PC-based data acquisition system. Accelerometer was installed at the sprung mass of the vehicle suspension, a position sensor was attached at the tyre, two linear variable differential transformers (LVDTs) were placed in between the sprung mass and unsprung mass and road profile. Two types of road profiles were used in the form of sinusoidal and square waves as depicted in Figures 4 and 5 respectively.

The training algorithm for the proposed NN in this paper is BP with PSO. It is usual that the weights, biases and learning rates (thresholds) of the BP algorithm are randomly initialized. The pseudo code of the training procedure is as follows:

```

Begin PSO
For each particle
    Initialize particle (v0 and p0)
End

Do For each particle
    Calculate fitness value
    If fitness better than pbest update pbest
End
Determine gbest from all particles
For each particle
    Update velocity to formula (5)
    Update position to formula (6)
End
While maximum iterations or minimum error criteria is
not attained

Begin Neural Network
Initialize weights (wi) and learning rate θ
Do
    Input xi(t) with desired output d(t)
    Calculate error to formula (1)
    Adapt weights to formula (2)
While not done

```

Moreover, the parameters of the NN were determined by using PSO method in an off-line manner. After a number of trial runs, appropriate values of these NN parameters were obtained. Subsequently, the setting parameters of the PSO algorithm are determined as follows: number of particles = 50, dimensions = 20, $c_1 = 1.25$, $c_2 = 1.25$ and $w = 0.35$. Results obtained from the simulation were shown in Figures 6 and 7 related to the identification of sprung mass acceleration and suspension deflection respectively for a sinusoidal wave road profile. Figures 8 to 9 are the identification of the sprung mass acceleration and suspension deflection respectively for a given square wave road profile. **In all figures, the identification curve is the actual speed curves of the quarter car, the blue solid line represent; the NNs identification curves using the back-**

propagation learning algorithm, the black dotted line represent; the NNs identification curve using the PSO method, the red solid line represent. From all figure which it can be seen that the NNs identification using PSO learning algorithm method is perform better than NNs identification without PSO learning algorithm.

6. Conclusions

An alternative approach to identify/model vehicle suspension system using PSO training neural network technique has been presented and successfully applied. The proposed neural network is simple in topology and accurate in identification. By using experimentally quarter car test rig data, the nonlinear characteristics of the vehicle suspension system can be taken into consideration. The model responses and the actual test rig output are almost identical which means that the models have captured the real vehicle dynamic characteristics. The advanced and application this results for suspension control design is under research.

Acknowledgements

The authors would like to thank the *Malaysian Ministry of Science and Technology and the Environment (MOSTE)* and *Universiti Teknologi Malaysia (UTM)* for their continuous support in the research work. This research was fully supported by an IRPA grant (No. 03-02-06-0123EA001).

References

- [1] Yim, Y.U., Oh, S.Y., Modelling of Vehicle Dynamics From Real Vehicle Measurements Using a Neural Network With Two-Stage Hybrid Learning for Accurate Long-Term Prediction, *IEEE Trans. on Vehicular Technology*, Vol. 53, No. 4, July, 2004.
- [2] Joo, Dae-Sung, Al-Holou, N., Weaver, J.M., Lahdhiri, T., Al-Abbas, F., Nonlinear modelling of vehicle suspension system, *Proc. of the 2000 American Control Conference*, Vol. 1, Issue 6, 28-30 June 2000.
- [3] Buckner, G.D., Schuetze, K.T., Beno, J.H., Active Vehicle Suspension Control Using Intelligent Feedback Linearization, *Proc. of the American Control Conference*, Chicago, Illinois June 2000.
- [4] Billings, S.A., Jamaluddin, H.B., Chen, S., Properties of neural network with applications to modelling non-linear dynamic systems, *Int. Journal of Control*, vol. 55, no. 1, 193-224, 1992.
- [5] Narendra, K.S., Neural networks for control: theory and practice, *Proc. IEEE* 84, 1385-406, 1996.
- [6] Jha, R., Rower, J., Experimental investigation of active vibration control using neural networks and piezoelectric actuators, *Smart Materials and Structures*, 11, 115-121, 2002.
- [7] Baladi, P. Hornik K., Neural networks and principal component analysis: learning from examples and local minima, *Neural Networks*, 2, 53-58.1989.
- [8] Wilamowski, B.M., Neural network architectures and learning, *IEEE International Conference on Industrial Technology*, Vol. 1, 10-12 December 2003.
- [9] Guo, Q.J., Yu, H.B., Xu, A.D., A hybrid PSO-GD based intelligent method for machine diagnosis, *Digital Signal Processing*, vol. 5, p. 1-17, 2006.
- [10] Kennedy, J., Eberhart, R.C., Particle Swarm Optimisation, *Proc. IEEE International Conference on Neural Networks*, IV, 1942-1948, 1995.
- [11] Parsopoulos, K.E., Vrahatis, M.N, Recent approaches to global optimization problems through Particle Swarm Optimization, *Natural Computing*, 1, 235-306, 2002.
- [12] Van den Bergh, F., Particle Swarm weight initialization in multi-layer perceptron artificial neural networks, *ICAI*, Durban, South Africa, 1999.
- [13] Lu, W.Z., Fan, H.Y., Leung, A.Y. T., Wong, J.C.K., Analysis of pollutant levels in central Hong Kong applying neural network method with particle swarm optimization, *Environmental Monitoring and Assessment*, 79, 217-230, 2002.
- [14] Hereford, J.M., Kuyucu, T., Robust neural networks using motes, *Proceedings of the 2005 NASA/DoD Conference of Evolution Hardware (EH'05)*, 2005.

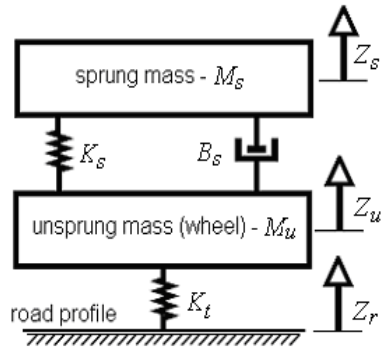

Figure 1. Quarter Car Vehicle Suspension



Figure 2. Quarter car test rig

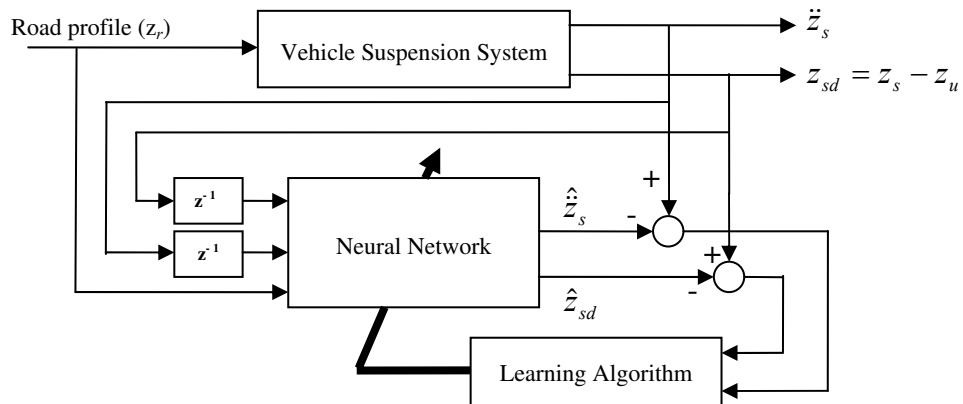

Figure 3. The architecture of the suspension dynamics identification.

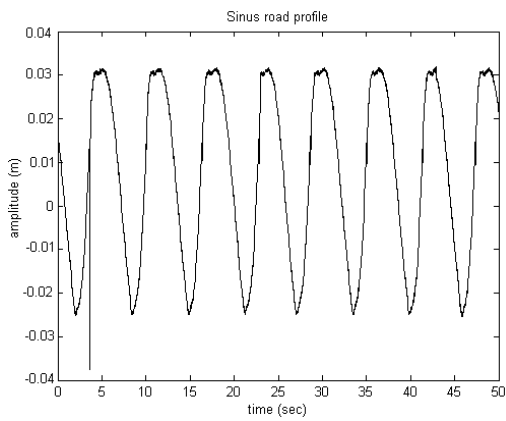

Figure 4. Sinus wave road profile

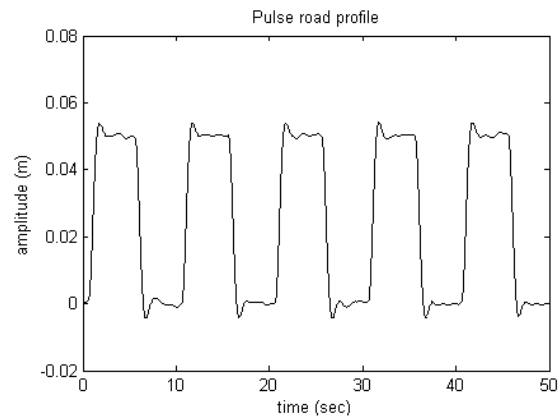

Figure 5. Square wave road profile

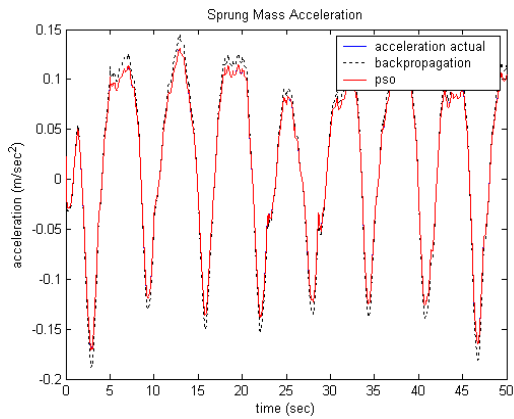

Figure 6. Sprung mass acceleration of sinusoidal wave road profile

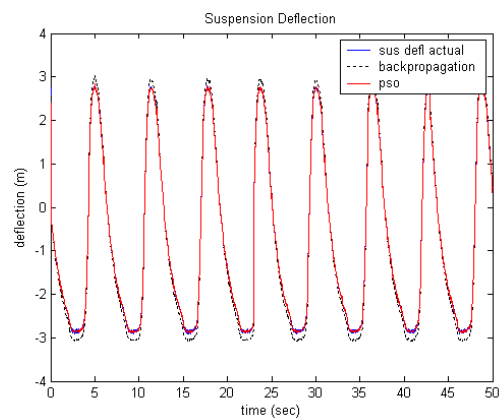

Figure 7. Suspension deflection of sinusoidal wave road profile

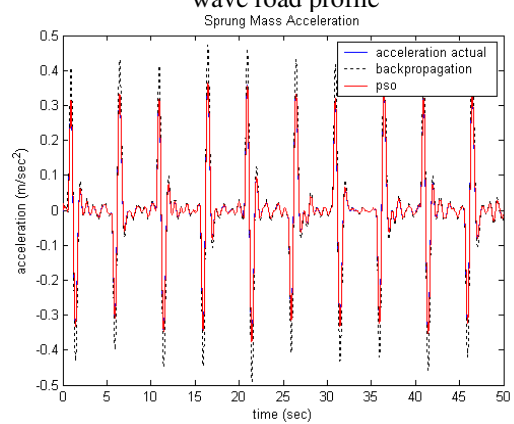

Figure 8. Sprung mass acceleration of square wave road profile

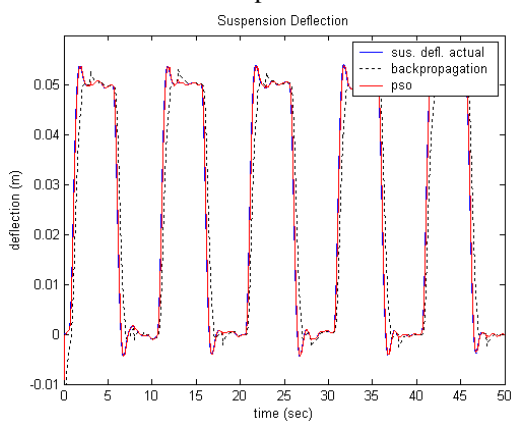

Figure 9. Suspension deflection of square wave road profile

CHAPTER 4

PARTICLE SWARM OPTIMIZATION NEURAL NETWORK BASED MODELLING OF VEHICLE SUSPENSION SYSTEM

Gigih Priyandoko, Musa Mailah & Hishamuddin Jamaluddin

*Presented at Regional Conference on Engineering and Science 2006 (RCPES06),
UTM Skudai, Jun 2006*

SIMULATION OF SUSPENSION SYSTEM WITH ADAPTIVE FUZZY ACTIVE FORCE CONTROL

Priyandoko G. & Mailah M.
 Department of Applied Mechanics, Faculty of Mechanical Engineering,
 Universiti Teknologi Malaysia, 81310 Skudai, Johor, Malaysia
 E-mail: gigihp@gmail.com and musa@fkm.utm.my

Abstract

This paper presents the design of a control technique applied to an active suspension system of a quarter car model using adaptive fuzzy (AF) logic and active force control (AFC) technique. The overall control system comprises three loops: the inner actuator control loop employing a classic proportional-plus-integral (PI) controller for force tracking control of the hydraulic actuator, AFC loop using an AF element to estimate the mass needed to compensate for the disturbances and the outer positional control loop utilising a second AF controller to compute the optimum target force. The performance of the proposed control method was then simulated, evaluated and later compared to examine the effectiveness of the system in suppressing the undesirable effects of the suspension system. It was found that the active suspension system with Adaptive Fuzzy Active Force Control (AF-AFC) yields superior performance compared to the AF system without AFC and the passive counterpart.

Keywords:

Active suspension, quarter car model, adaptive fuzzy, active force control.

1. INTRODUCTION

There are many mechanical systems in which it is necessary to provide isolation of one part from disturbance at another part. For example, the passenger of a car must be isolated from the car body vibrations when a car hitting a bump or hole.

In the conventional passive suspension system, the mass-spring-damper parameters are generally fixed, and they are chosen based on the design requirements of the vehicles. The suspension has the ability to store energy in the spring and to dissipate it through the damper. When a spring supports a load, it will compress until the force produced by the compression is equal to the load force. If some other forces then disturb the load, then it the load will oscillate up and down around its original position for some time. Passive suspension utilizing mechanical springs and dampers is known to have the limitations of vibration isolation and lack of attitude control of the vehicle body. To solve these problems, many researchers have studied various semi-active and active suspensions both theoretically and experimentally [1,2].

Active suspension differs from the conventional passive suspension in its ability to inject energy into the system. In an active suspension system, an actuator is attached in parallel with both a spring and a shock absorber. The main advantage of employing an active suspension is the associated adaptation potential where the suspension characteristic can be adjusted while driving to match the profile of the road being traversed. The active suspension system should be able to provide different behavioural characteristics depending upon various road conditions. The basic idea in active control of suspensions is to use an active element (the actuator) to apply a desired force between the car body and the wheel axle. This desired force is computed by the car's control unit to achieve certain performance objectives under external disturbances, e.g., passenger comfort under road imperfections [3].

Modern control and nonlinear control theory has been employed to design the controller for the active suspension system, for examples LQR [4], H_∞ [5], nonlinear controller [6] and adaptive control [7]. However, an accurate system model must be provided before the controller can be developed. The other hand, the model-free fuzzy logic control strategy has attracted the attention of the designers [8-9]. Fuzzy

logic control methods have been used extensively in recent years. In addition, an appropriate fuzzy logic controller can take care of the environmental variation during operation processes. Therefore, they have been employed in the field of the active suspension system. However, the design of a traditional fuzzy controller depends fully on an expert or the experience of an operator to establish the fuzzy rule bank. Generally, this knowledge is difficult to obtain. A time-consuming adjustment process is required to achieve the specified control performance.

A hybrid intelligent system is one that combines at least two intelligent technologies, for example fuzzy logic and neural network. Then, merger of a neural network with a fuzzy logic control into one integrated system therefore offers a promising approach to building intelligent systems. The combination approach is to building hybrid intelligent system capable of reasoning and learning in an uncertain and imprecise environment. As a result fuzzy systems become capable learning to a new environment.

The objective of this paper is to design a control technique applied to an active suspension system of a quarter car model using adaptive fuzzy and intelligent active force control (AF-AFC). Performance of the suspension system is evaluated in terms of the following criteria namely sprung mass acceleration, sprung mass displacement, suspension deflection and tyre acceleration.

This paper is organized as follows. A quarter-car model is introduced in section 2. The model of a hydraulic actuator is presented in section 3. Adaptive fuzzy control is described in section 4 and AFC in section 5. The results of the simulation study are discussed and presented in section 6. Finally, this paper is concluded in section 7.

2. ACTIVE SUSPENSION MODEL

The model of the quarter car active suspension system used in the study is shown in Fig. 1. The quarter car is represented by two a degree of freedom (DOF) model and comprises a sprung mass (body of car) fully supported by a spring, damper and hydraulic actuator which are all attached to unsprung mass (tyre or wheel) at the other end. The unsprung mass is assumed to have only the spring feature and is in contact with the road terrain at the other end. The road terrain serves as an external disturbance input to the system.

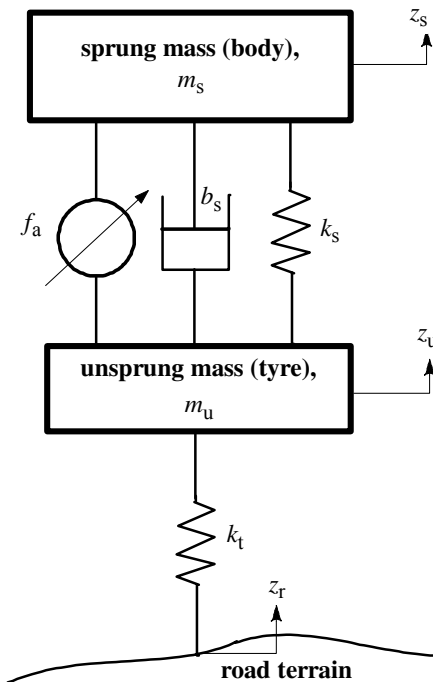

Figure 1: A quarter car active suspension model.

The equations of motion derived for this system are based on Newtonian mechanics and given as [5]:

$$\begin{aligned} m_s \ddot{z}_s &= -k_s(z_s - z_u) - b_s(\dot{z}_s - \dot{z}_u) + f_a \\ m_u \ddot{z}_u &= k_s(z_s - z_u) + b_s(\dot{z}_s - \dot{z}_u) - k_t(z_u - z_r) - f_a \end{aligned} \quad (1)$$

where

m_s	:	sprung mass
m_u	:	unsprung mass
b_s	:	damping coefficient
k_s	:	spring stiffness
k_t	:	tyre stiffness
z_s	:	displacement of the car body (sprung mass)
z_u	:	displacement of tyre (unsprung mass)
z_r	:	displacement of road
$z_s - z_u$:	suspension deflection
$z_u - z_r$:	tyre deflection
\dot{z}_s	:	velocity of sprung mass
\dot{z}_u	:	velocity of unsprung mass
\ddot{z}_s	:	acceleration of sprung mass
\ddot{z}_u	:	acceleration of unsprung mass
f_a	:	actuator force

It is assumed that the suspension spring stiffness and tyre stiffness are linear in their operation ranges and the tyre does not leave the ground. The displacements of both the body and tyre can be measured from the static equilibrium point.

3. HYDRAULIC ACTUATOR MODEL

A schematic diagram of a translational double acting hydraulic actuator driven by a three-land four-way spool valve is depicted in Fig. 2. An actuator is placed between the sprung and unsprung masses and can exert a force f_a in between m_s and m_u . The hydraulic actuator consists of a spool valve (servo valve) and a hydraulic cylinder. P_s and P_r are the supply and return pressures going into and out of the spool valve, respectively, x_v is the spool valve position, P_u and P_L are the oil pressures in the upper and lower cylinder chambers respectively and $x_w - x_c$ is the hydraulic piston displacement.

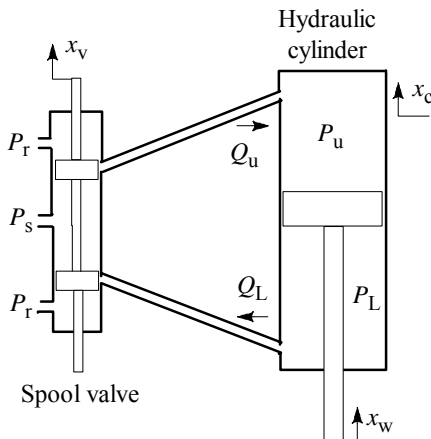

Figure 2: Double acting hydraulic actuator.

The actuator works as follows. As the spool valve move upward (positive x_{sp}), the cylinder upper chamber is connected to the supply line P_s and its pressure increases. At the same time, the lower chamber is connected to the return line P_r and its pressure decreases. The pressure difference then make the hydraulic cylinder extend or compress.

The differential equation governing the dynamics of the actuator is given in [10,11] as follows:

$$\frac{V_t}{4\beta} \dot{P}_L = Q_L - C_{tm}P_L - A(\dot{z}_s - \dot{z}_u) \quad (2)$$

where V_t , β , A , C_{tm} are total actuator volume, effective bulk modulus, actuator ram area and coefficient of total leakage due to pressure, respectively.

Using the equation for hydraulic fluid flow through an orifice, the relationship between spool valve displacement x_v and the total flow Q_L is given by:

$$Q_L = C_d w x_v \sqrt{\frac{P_s - \text{sgn}(x_v)P_L}{\rho}} \quad (3)$$

where C_d and w are the discharge coefficient and spool valve area gradient respectively.

The spool valve displacement x_v can be related to the input current i_v through the following linear dynamic equation:

$$\dot{x}_v = \frac{1}{\tau} (-x_v + k_v i_v) \quad (4)$$

where k_v is the valve gain and τ is the time constant of the servo valve.

4. ADAPTIVE FUZZY CONTROL

Most fuzzy logic controllers developed till now have been of the rule-based type, where the rules in the controller attempt to model the operator's response to particular process situations. Thus, to form the fuzzy logic control, will consider the following four components or operations method for fuzzification, membership function, method for fuzzy inference and method for defuzzification.

Fuzzy systems lack the ability to learn and cannot adjust themselves to a new environment. On the other hand, neural networks can learn. The merger of a neural network with a fuzzy system into one integrated system therefore offers a promising approach to building intelligent systems. A hybrid intelligent system is one that combines at least two intelligent technologies, for example fuzzy logic and neural network. The combination approach is to building hybrid intelligent system capable of reasoning and learning in an uncertain and imprecise environment. As a result fuzzy systems become capable learning to a new environment.

Learning ability is one of the essential attributes of an intelligent controller, which means that the controller can improve its future performance, based on experiential information it has gained in the past, through closed-loop interaction with the plant and its environment. Some learning control systems have been addressed using neural networks [12].

Following Wang [13], here introduced briefly the Takagi-Sugeno adaptive fuzzy network model $f(x)$ and its back-propagation learning method. The adaptive fuzzy system is shown in Fig. 3. In this network, the structure will be determined during the initialization stage and all fuzzy membership functions are connected to form completed rules. The network uses a product inference engine, singleton fuzzifier, centre average defuzzifier, and Gaussian membership function:

$$f(x) = \frac{\sum_{l=1}^M \bar{y}^l \left[\prod_{i=1}^N a_i^l \exp \left(- \left(\frac{x_i - \bar{x}_i^l}{\sigma_i^l} \right)^2 \right) \right]}{\sum_{l=1}^M \left[\prod_{i=1}^N a_i^l \exp \left(- \left(\frac{x_i - \bar{x}_i^l}{\sigma_i^l} \right)^2 \right) \right]} \quad (5)$$

where x_i is input to the fuzzy networks, $i=1, \dots, n$, n is number of input, $l=1, \dots, M$. M is the number of rule, it will be determined during the initialization stage and will be fixed during learning stage. The parameters $\bar{y}^l, \bar{x}_i^l, \sigma_i^l$ are center of l -th of consequence fuzzy set, centre and width of Gaussian antecedent membership function at rule l and input i , respectively.

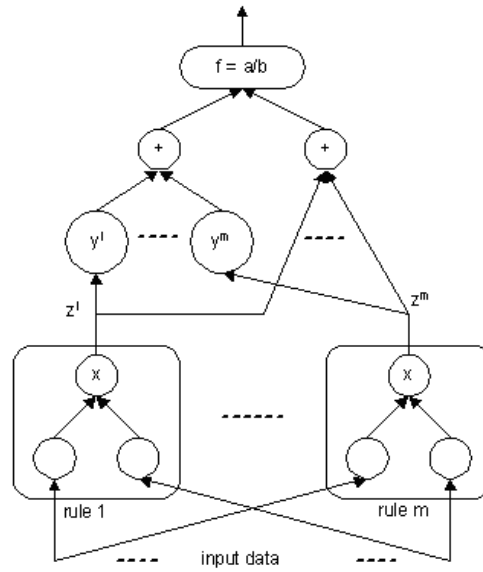

Figure 3: An adaptive fuzzy scheme.

By assuming $a_i^l=1$, such that error system:

$$e^P = v(x) = \frac{1}{2} \left\{ f_{desired}(x^P) - f_{actual}(x^P) \right\}^2 \quad (6)$$

is minimized. Hence using chain rule, the problem back-propagation learning the parameters $\bar{y}^l, \bar{x}_i^l, \sigma_i^l$ such that $v(x)$ in equation 6 is to be minimized with respect to the parameter vector x . The update of x is defined:

$$x(k+1) = x(k) + \Delta x$$

$$\Delta x = -\alpha \left. \frac{\partial e^P}{\partial x} \right|_k \quad (7)$$

where α is learning rate such that, to train $\bar{y}^l, \bar{x}_i^l, \sigma_i^l$ is used:

$$\bar{y}^l(k+1) = \bar{y}^l(k) - \alpha \frac{(f-d)}{b} z^l \quad (8)$$

$$\bar{x}_i^l(k+1) = \bar{x}_i^l(k) - \alpha \frac{(f-d)}{b} (\bar{y}^l(k) - f) z^l \frac{2(x_i - \bar{x}_i^l(k))}{\bar{x}_i^l(k)^2} \quad (9)$$

$$\bar{\sigma}_i^l(k+1) = \bar{\sigma}_i^l(k) - \alpha \frac{(f-d)}{b} (\bar{y}^l(k) - f) z^l \frac{2(x_i - \bar{x}_i^l(k))^2}{\bar{x}_i^l(k)^3} \quad (10)$$

and:

$$f = f_{actual}(x)^P, d = f_{desired}(x)^P, z^l = \prod_{i=1}^N \exp\left(-\left(\frac{x_i - \bar{x}_i^l}{\sigma_i^l}\right)^2\right),$$

$$a = \sum_{l=1}^M (\bar{y}^l z^l)$$

$$b = \sum_{l=1}^M (z^l)$$

5. ACTIVE FORCE CONTROL

Active force control (AFC) strategy was first proposed by Hewit and co-workers to control a dynamic system in order to ensure the system remain stable and robust in the presence of known and unknown disturbances [14-15]. AFC has been demonstrated to be superior compared to conventional methods in controlling a robot arm [16-17]. Fig. 4 illustrates the principle of AFC concept applied to a translational system.

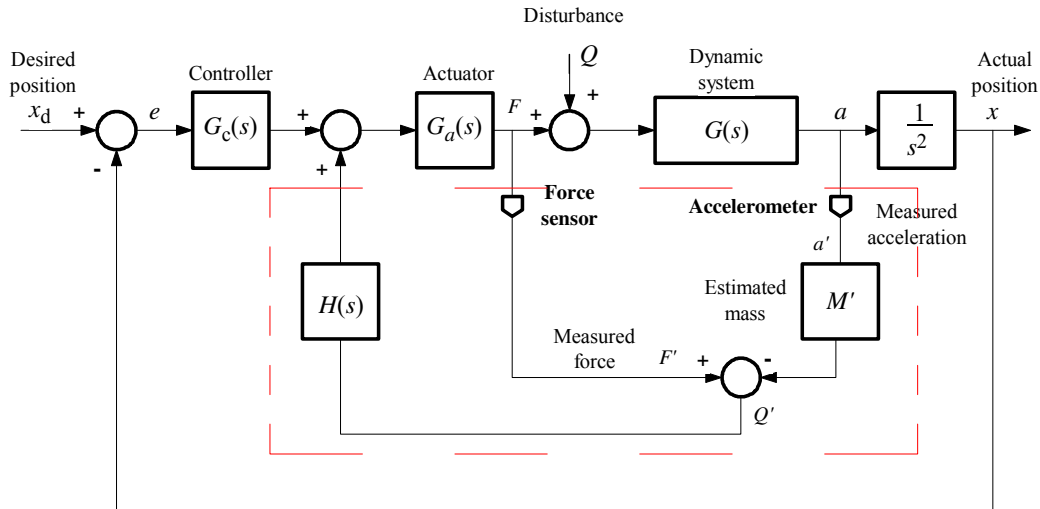

Figure 4: A schematic diagram of an AFC strategy

From Fig. 4, the estimated variable Q' is passed through a function $H(s)$, before subtraction from a command vector at the summing junction. A suitable choice of $H(s)$ can cause the output x to be made invariant with respect to the disturbance Q . A suitable set of control loop is applied to the above open loop system, by first generating the world coordinate error vector, $e = (x_d - x)$ which would then be processed through a controller function, $G_c(s)$ (typically a classic PD controller). Thus, the system is reduced to a set of non-interacting loops. An outer positional loop is formed through the world coordinate error vector, e . The main computational burden in AFC is the multiplication of the estimated inertia matrix with the acceleration of the translational dynamic system before being fed into the AFC feedforward loop. The fundamental

principle of AFC is to use some measured and estimated values of the identified system parameters, namely the measured force and acceleration of the dynamic system and the estimated mass of the system. The basic AFC equation can then be written as follows [15]:

$$Q' = F' - m'a' \quad (11)$$

where the superscript (') denotes the measured or estimated values of the parameters. The measurable physical quantities of the system are the actuating force (F') and the acceleration (a'). These can be measured using force and acceleration sensors, respectively. The estimated mass (m') of the system (with the presence of disturbances that contributes to the acceleration) should be estimated appropriately using suitable method such as crude approximation or intelligent techniques. If all parameters are successfully acquired, then the resulting estimated force (Q') from equation (11) should result in a very robust and stable performance of the control system once this signal is fed back to the AFC control loop.

6. DESIGN OF PROPOSED AF-AFC SCHEME

The complete AF-AFC scheme is shown in Fig.5. Note the three loops that are contained in the overall proposed control system and that two adaptive fuzzy (AF) systems were used, namely AF1 for the outer loop positional control and AF2 for computing the estimated mass necessary in the AFC section.

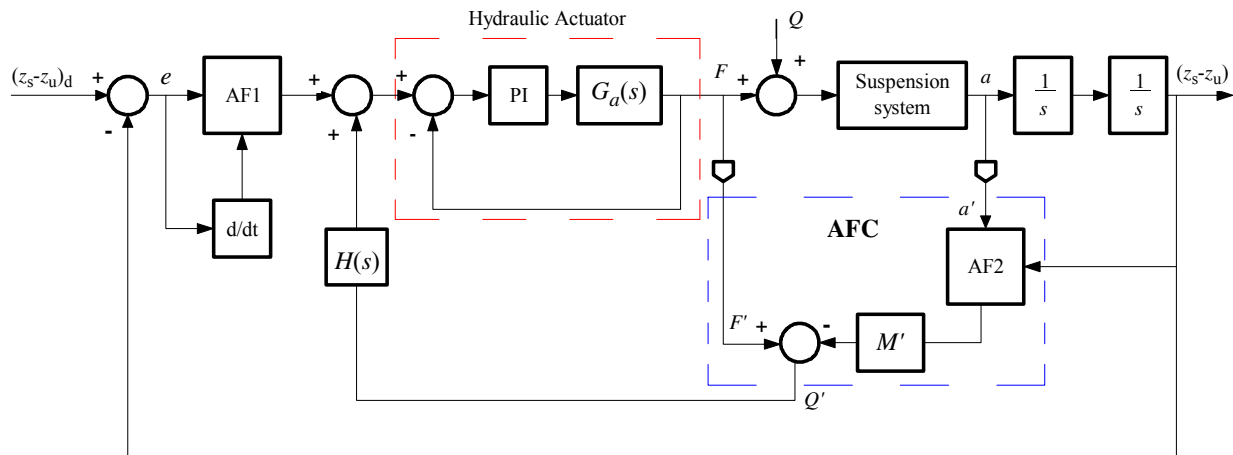

Figure 5: A block diagram of the proposed AF-AFC scheme.

Note that the disturbance (Q) used in the study is in the form of a step function with a constant height of 6 cm as shown in Fig. 6. This is deliberately introduced to test the system robustness or capability to produce acceptable results even in the presence of such disturbance.

The design of the control problem was carried out according to the following three-steps procedure given as follows:

1. The inner loop controller for force tracking hydraulic actuator commands was first designed. The majority of the existing literature assumes that the commanded force can be achieved accurately and frequently done without considering actuator dynamics. However, they are highly nonlinear and their force generation capability is closely coupled with the vehicle body motion. When a less capable actuator is used, the sub-loop design first needs to be carried out [10-11]. Force tracking of the hydraulic actuator commands in this simulation is accomplished using a PI controller, with $K_p = 1$ and $K_i = 0.5$ that are derived using the Ziegler-Nichols formulation for the purpose of simulation. The validation of the force tracking capability is based on sinusoidal, square wave and saw tooth input forcing functions.

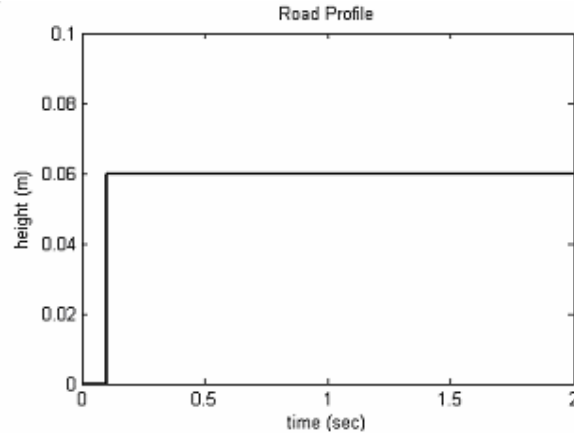

Figure 6: Road profile representing the input disturbance

2. The outer loop controller (AF1) was designed to satisfy performance requirements using Takagi-Sugeno adaptive fuzzy model. Training algorithm for adaptive fuzzy uses a back-propagation real time learning method (equation 2). The input and output universes of discourse of the fuzzy controller are normalized in the range of $[-1, 1]$. Two input adaptive fuzzy controller are the error, e and change of error, de . These two inputs are scaled by two gain coefficients K_e and K_{de} respectively, in order to normalize these inputs in the range of $[-1, 1]$. One output is force in the range -2000 to 2000 N and is singleton value scaled by K_{01} in order to normalize in the range of $[-1, 1]$. Note that the numerical scale K_e , K_{de} and K_{01} were acquired prior to simulation based on human experience and also results from previous studies that uses conventional methods (an example can be found in [12]). Fig. 7 shows the representation of the membership functions for respective parameters.
3. The AFC loop was specifically designed to compensate for the disturbances. The AFC scheme has two inputs, namely the active force hydraulic actuator and body acceleration components. The estimation of mass needed by AFC loop is the main factor which contribute to the effectiveness of the control scheme. In this simulation, to estimate the mass needed to feed the forward control loops adaptive fuzzy strategy was used. Training algorithm for the AF2 uses a back-propagation real time learning method as defined by equation (2). Two input adaptive fuzzy controller are sprung mass acceleration and suspension deflection. These two inputs are scaled by two coefficients K_{sa} and K_{sd} respectively, in order to normalize these inputs in the range of $[-1, 1]$. One output is singleton value of estimated mass in the range 0 to 100 kg and is scaled by K_{02} to normalize in the range of $[-1, 1]$. Fig. 7 shows examples of the membership functions designed for the AF1 controller noting N, Z and P as negative, zero and positive respectively.

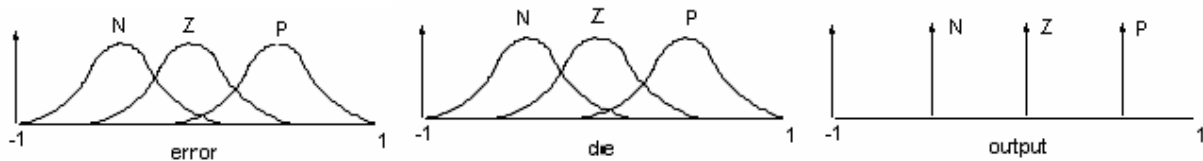

Figure 7: Membership functions for the input/output parameters of AF1.

6. SIMULATION

The parameters of the quarter car model and the hydraulic actuator are obtained from [10-11] and listed as follows:

$$\begin{array}{lll}
 m_s = 290 \text{ kg} & \beta = 1.00 & k_v = 0.0157 \text{ m/A} \\
 m_u = 59 \text{ kg} & \alpha = 4.515e^{12} \text{ N/m}^5 & \tau = 0.0046 \text{ sec} \\
 k_s = 16,812 \text{ N/m} & \gamma = 1.545e^9 \text{ N/(m}^{5/2} \text{ kg}^{1/2}) & \\
 b_s = 1,000 \text{ N/m/sec} & P_s = 1500 \text{ Psi (10342500 Pa)} & \\
 k_u = 190,000 \text{ N/m} & A = 3.35e^{-4} \text{ m}^2 &
 \end{array}$$

Simulation was performed using MATLAB and Simulink. The Simulink diagram of the *AF-AFC* strategy for the active suspension system is shown in Fig. 8. It consists of the hydraulic double acting actuator model and its controller, suspension system dynamic model, adaptive fuzzy controller, disturbances and reference input of the system. The system dynamic has two inputs which are road disturbance and active force from hydraulic actuator. This system has four outputs which are body displacement, suspension deflection, tyre deflection and body acceleration to analyses performance of the suspension system.

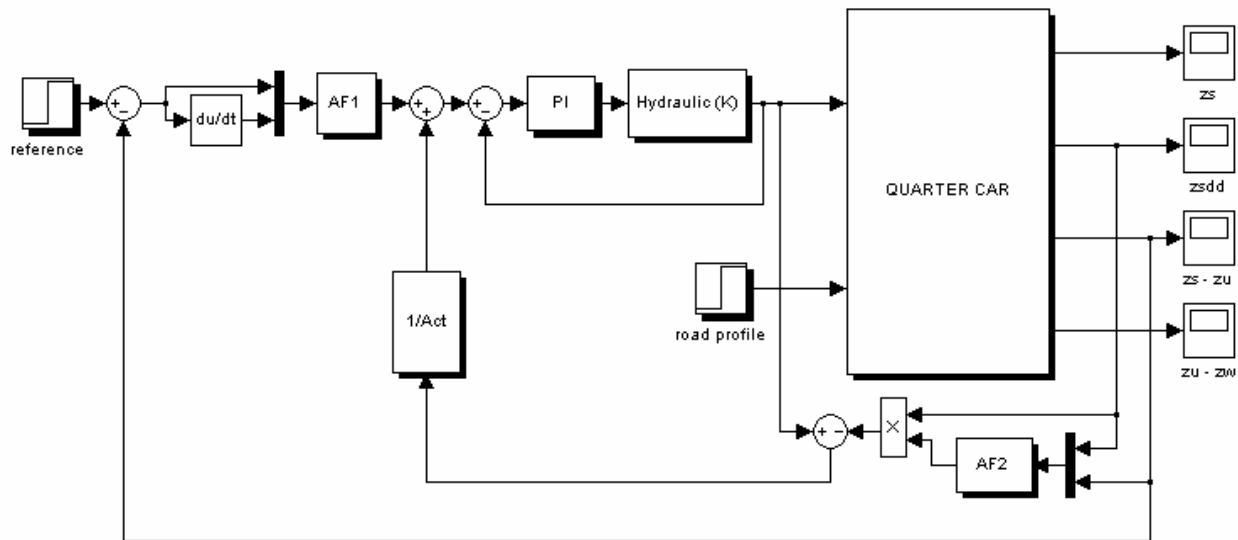

Figure 8: Simulink diagram of an AF-AFC strategy.

The road profile in Fig. 8 is represented by a step function ('step' block). It is considered as a form of input "disturbance" to the system. Simulation is performed using the parameters and conditions as described in the earlier part of this section. The responses which are of considerable importance are the sprung mass acceleration and displacement, suspension deflection and tyre deflection when the car hits the 'bump'. Three types of control systems are compared and evaluated, namely the open loop passive, AF and AF-AFC scheme. All the relevant parameters and conditions are maintained the same for all the schemes to ensure a realistic and fair one-to-one comparison.

7. RESULTS AND DISCUSSION

The results of the force tracking capability of the hydraulic actuator employing PI controller are shown in Fig. 9. It is very obvious that the actual forces from the actuator represented by a series of dotted lines for all the input functions can readily track the desired forces (solid lines). The actuator is thus deemed suitable to be implemented into the overall proposed control scheme.

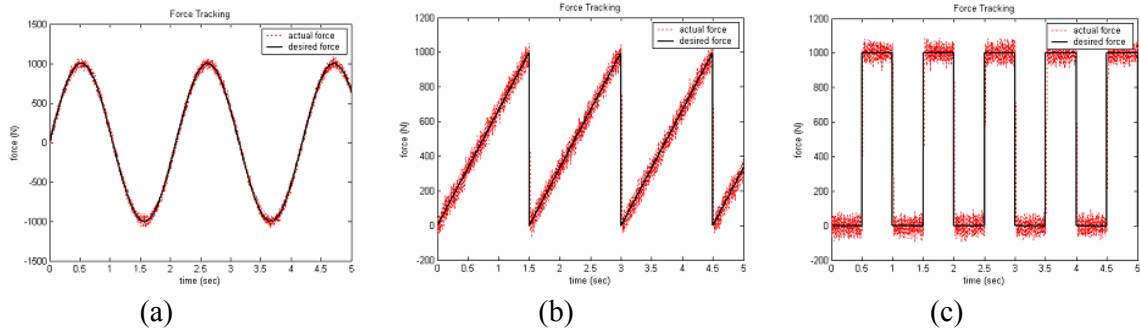

Figure 9: Force tracking of hydraulic actuator using (a) sinusoidal, (b) saw-tooth and (c) square inputs.

Fig. 10 shows the variation of the estimated mass computed by the AF2 component in the AFC loop upon simulation. The inertial parameter shows high initial value and later stabilises to almost a constant value towards the end of the simulation period. The on-line force tracking control capability of the inner loop is illustrated in Fig. 11 where actual force (dotted line) is shown to track the desired force (solid line) with small error margins. This is an indication that the force produced by the hydraulic actuator conforms to the desired force, i.e the force signal generated at the output of adaptive fuzzy controller.

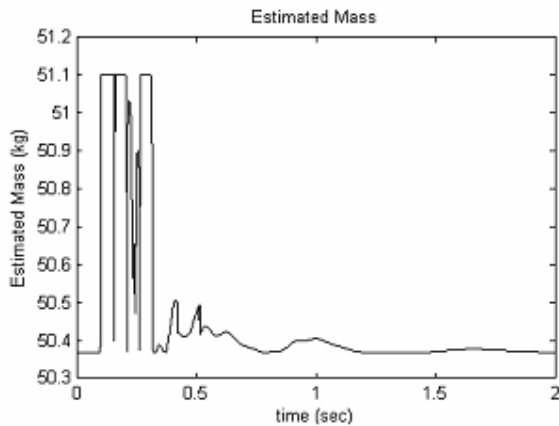

Figure 10: Estimated mass for the AFC loop

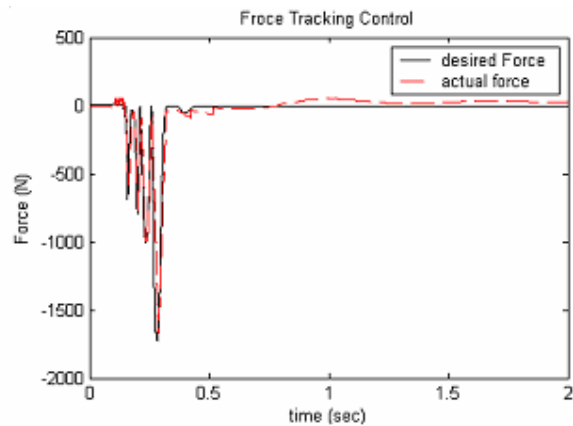

Figure 11: On-line force tracking error

Fig. 12 shows the sprung mass displacement for all the three schemes. Fig. 13 illustrates suspension deflection. The AF-AFC did an excellent job in reducing sprung mass displacement and suspension deflection than adaptive fuzzy controller and passive suspension system.

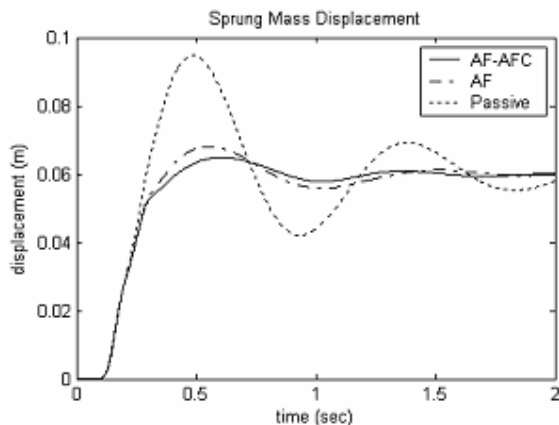

Figure 12: Sprung mass displacement.

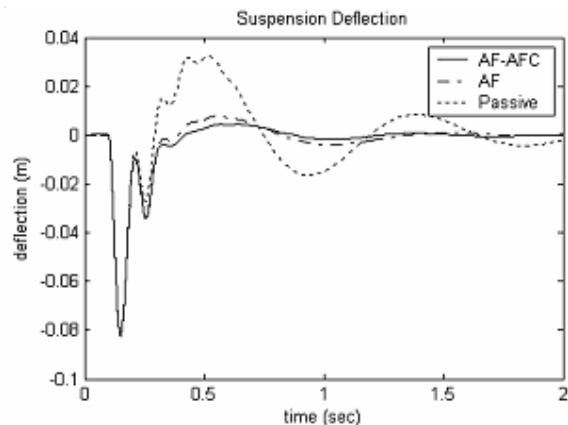

Figure 13: Suspension deflection.

Fig. 14 depicts the sprung mass acceleration while Fig. 15 exhibits the tyre deflection. The AF-AFC shows an improvement in reducing the unsprung mass acceleration and tyre deflection over the adaptive fuzzy controller and passive suspension system. It is obvious that the AF-AFC produces the best performance than its counterparts in compensating the introduced disturbances.

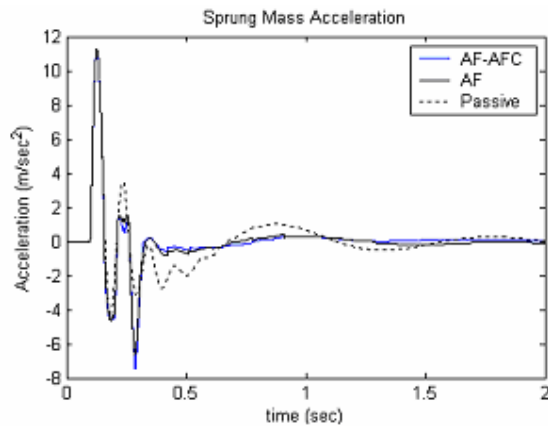

Figure 14: Sprung mass acceleration.

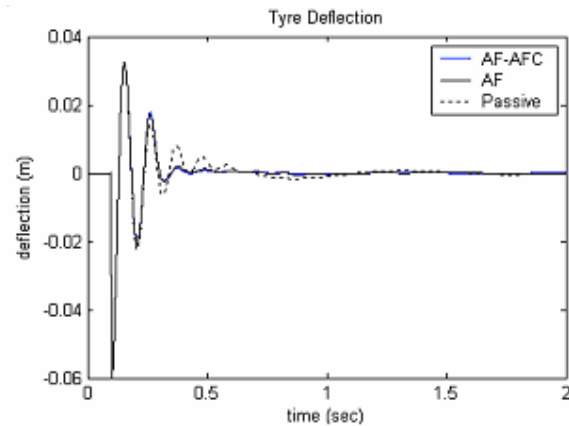

Figure 15: Tyre deflection.

7. CONCLUSION

The resulting control strategy known as adaptive fuzzy active force control (*AF-AFC*) is then used to control an active suspension with a nonlinear actuator attached between the sprung mass and the unsprung mass of the quarter car model. The performances of the proposed control method were then evaluated and later compared to examine the effectiveness in suppressing the vibration effect of the suspension system. It was found that the active suspension system with adaptive fuzzy active force control gives better performance compared to the adaptive fuzzy logic and the passive suspension system.

ACKNOWLEDGEMENTS

The authors would like to thank the *Malaysian Ministry of Science and Technology and the Innovation (MOSTI)* and *Universiti Teknologi Malaysia (UTM)* for their continuous support in the research work. This research was fully supported by an IRPA grant (No. 03-02-06-0123EA001).

REFERENCES

- [1] Cherry, A.S.; Jones, R.P. (1995). Fuzzy logic control of an automotive suspension system, *IEE Proceedings of Control Theory Application*, vol. 142, no. 2, 149-160
- [2] Appleyard, M.; Wellstead, P.E. (1995). Active suspension: some background, *IEE Proceedings of Control Theory Application*, vol. 142, no. 2, 123-128
- [3] D'Amato, F.J.; Viassolo, D.E. (2000). Fuzzy control for active suspensions, *Mechatronics*, Vol.10, 897-920
- [4] Taghirad, H.D.; Esmailzadeh, E. (1998). Automobile passenger comfort assured through LQG/LQR active suspension, *Journal of Vibration and Control, Incorporating Modal Analysis*, 4(5), 603 - 618
- [5] Nguyen, T.T.; Bui, T.H.; Tran, T.P.; Kim, S.B. (2001). A hybrid control of active suspension system using H_{∞} and nonlinear adaptive controls, *Proceedings of ISEI 2001*, Volume 2, 12-16 June 2001, 839 - 844
- [6] Joo, D.S.; Al-Holou, N.; Weaver, J.M.; Lahdhiri, T.; Al-Abbas, F. (2000). Nonlinear modeling of vehicle suspension system, *Proceedings of the American Control Conference*, Volume 1, Issue 6, 28-30 June, 115 -119
- [7] Chen, H.Y.; Huang, H.J. (2005). Adaptive sliding controller for active suspension system, *International Conference on Control and Automation*, Volume 1, 26-29 June, 282 - 287
- [8] Sun, J.; Yang, Q. (2005). Self-adjustment fuzzy control of automobile active suspension, *Proceedings IEEE Intelligent Vehicles Symposium*, 6-8 June 2005, 354 - 357

- [9] Mock, J. R.; Weeks, D. A.; Beno, J. H.; Nichols, S. P.; Bresie D. A.; Guenin, A. M. (2002). Dual Purpose Fuzzy Logic Controller for an Active Suspension System, *SAE 2002 World Congress*, Detroit, Michigan, March 4-7, 2002
- [10] Alleyne, A.; Liu, R.; Wright, H. (1998). On the limitations of force tracking control for hydraulic active suspensions, *Proceedings of the American Control Conference*, Volume 1, 24-26 June, 43 – 47.
- [11] Chantranuwathana, S.; Peng, H. (2004). Adaptive Robust Force Control for Vehicle Active Suspensions, *International Journal of Adaptive Control and Signal Processing*, 2004, 18:83-102
- [12] Babuška, R. (2002). Neuro-fuzzy methods for modelling and identification, Abraham, A.; Jain, L.C.; Kacprzyk, J. (Editors), *Recent Advances in Intelligent Paradigms and Applications*, Springer-Verlag, Heidelberg, 161–186
- [13] Wang, L-X. (1994). *Adaptive Fuzzy Systems and Control*, Prentice Hall, Englewood Cliffs, NJ
- [14] Hewit, J.R.; Moris, J.R. (1999). Disturbance observer control with estimation of the inertia matrix, *Proceedings of IEEE/ASME International Conference on Advanced Intelligent Mechatronics*, 753-757
- [15] Mailah, M. (1998). *Intelligent Active Force Control of A Rigid Robot Arm Using Neural Network and Iterative Learning Algorithms*, Ph.D Thesis, University of Dundee, UK
- [16] Hussein, S.B.; Zalzal, A.M.S.; Jamaluddin, H.; Mailah, M. (2000). An evolutionary neural network controller for intelligent active force control, *Evolutionary Design and Manufacture*, Parmee, I.C. (Editor), Springer Verlag, London, 352-362
- [17] Mailah, M.; Rahim, N.I.A. (2000). Intelligent active force control of a robot arm using fuzzy logic, *Proceedings of IEEE International Conference on Intelligent Systems and Technologies TENCON 2000*, 291-296

CHAPTER 5

SIMULATION OF SUSPENSION SYSTEM WITH ADAPTIVE FUZZY ACTIVE FORCE CONTROL

Musa Mailah & Gigih Priyandoko

*Published in International Journal on Simulation Modelling, Vol. 6, No. 1, March
2007, pp 25-36*

Hybrid Control Scheme Incorporating AFC and Input Shaping Technique for A Suspension System

M. Z. Md Zain, G. Priyandoko, M. Mailah

Department of Applied Mechanics, Faculty of Mechanical Engineering, Universiti Teknologi Malaysia, MALAYSIA, email: zarhamdy@fkm.utm.my gigihp@gmail.com musa@fkm.utm.my

Abstract - This paper describes an approach to investigate and develop a hybrid control scheme for vibration suppression of a suspension system. Initially, an active force control (AFC) scheme is developed for control of motion of the system. This is then extended to incorporate a feed-forward controller based on an input shaping (IS) technique for control of vibration suspension system of the system. Simulation results of the response of the suspension system with the control schemes are presented in time and frequency domains. The performance of the hybrid control scheme with AFC and IS control are assessed in terms of level of vibration reduction.

Keywords - Active force control (AFC), input shaping (IS), suspension system.

1. INTRODUCTION

For many years, automotive suspension has been designed using a coil or leaf spring in parallel with a viscous damper. The control of automotive suspensions is currently of great interest to both the academia and those in industries. Suspension design requires a compromise between the passenger comfort and good vehicle handling. To provide a good ride comfort, the suspension should be soft enough, but whereas good road holding requires stiff suspension. A good vehicle suspension should be able to minimize the vertical displacement and the acceleration of the body, however, in order to increase the passenger comfort, the sprung mass displacement need to be minimized.

In the conventional passive suspension system, the mass-spring-damper parameters are generally fixed, and they are chosen based on the design requirements of the vehicles. The suspension has the ability to store energy in the spring and to dissipate it through the damper. When a spring supports a load, it will compress until the force produced by the compression is equal to the load force. If some other forces disturb the load, then the load will oscillate up and down around its original position for some time.

Passive suspension utilizing mechanical springs and dampers is known to have the limitations of vibration isolation and lack of attitude control of the vehicle body. To solve these problems, many researchers have studied various active and semi-active suspensions both theoretically and experimentally.

In semi active suspension systems, it still uses springs as the main form of support, however the dampers can be controlled. A semi active suspension

has the ability to change the damping characteristics of the shock absorbers without using any actuators.

Active suspension differs from the conventional passive suspension in its ability to inject energy into the system. In an active suspension system, an actuator is attached in parallel with both a spring and a shock absorber. To achieve the desired performance, actuator should generate the desired force in any direction, regardless of the relative velocity across it. The ability to control the energy from external source according to the environment provides better performance of suspension system. For this reason, the active suspension is widely investigated [2,3,6,7,8].

The objective of this research is to design a controller of active suspension system for reducing vertical body displacement, suspension deflection, tyre deflection and body acceleration using a hybrid control scheme (AFCIS) strategy.

This paper is organized as follows. A quarter car model is introduced in section 2. The model of a hydraulic actuator is presented in section 3. The relevant control schemes are then described in section 4 and the results of the simulation study discussed and presented in section 5. Finally, this paper is concluded in section 6.

2. DYNAMIC EQUATION OF AN ACTIVE SUSPENSION

The model of the quarter car active suspension system used is shown in Fig. 1. The quarter car is presented by a two degree-of-freedom model. The equations of motion for this system are given as [6]:

$$\begin{aligned} m_s \ddot{z}_s &= -k_s(z_s - z_u) - b_s(\dot{z}_s - \dot{z}_u) + f_a \\ m_u \ddot{z}_u &= k_s(z_s - z_u) + b_s(\dot{z}_s - \dot{z}_u) - k_t(z_u - z_r) - f_a \end{aligned} \quad (1)$$

where m_s , m_u , b_s , k_s , k_t , f_a , z_s , z_u , z_r , $z_s - z_u$, $z_u - z_r$, \dot{z}_s , \dot{z}_u are the sprung mass (body), unsprung mass (wheel), damping coefficient, spring stiffness, tyre stiffness, actuator force, displacement of the car body, displacement of wheel (unsprung), displacement of road, suspension deflection, tyre deflection, velocity of car body and velocity of wheel respectively.

By assuming that the suspension spring stiffness and tyre stiffness are linear in their operating ranges, the tyre does not leave the ground. The displacements of both the body and wheel can be measured from the static equilibrium point.

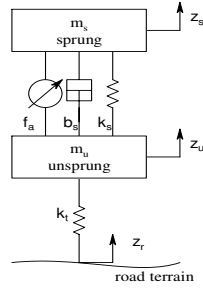

Fig. 1: A quarter car active suspension

3. DYNAMIC EQUATION OF A HYDRAULIC SYSTEM

Fig. 2 depicts a schematic diagram of a translational double acting hydraulic actuator driven by a three-land four-way spool valve. An actuator is assumed to be placed between the sprung and unsprung masses and can exert a force f_a in between m_s and m_u .

The hydraulic actuator consists of a spool valve (servo valve) and a hydraulic cylinder. P_s and P_r are the supply and return pressure going into and out of the spool valve respectively, x_{sp} is the spool valve position, P_u and P_l are the oil pressure in the upper and lower cylinder chambers respectively and x_w-x_c is the hydraulic piston displacement. The differential equation governing the dynamics of the actuator is given in [6] as follows:

$$\frac{V_t}{4\beta} \dot{P}_L = Q_L - C_{lm} P_L - A(\dot{z}_s - \dot{z}_u) \quad (2)$$

where V_t , β_e , A , C_{lm} is total actuator volume, effective bulk modulus, actuator ram area and coefficient of total leakage due to pressure respectively. Using the equation for hydraulic fluid flow through an orifice, the relationship between spool valve displacement x_v and the total flow Q_L is given as [6]:

$$Q_L = C_d w x_v \sqrt{\frac{P_s - \text{sgn}(x_v) P_L}{\rho}} \quad (3)$$

where C_d , w and C_{lm} are the discharge coefficient, spool valve area gradient and total leakage coefficient respectively.

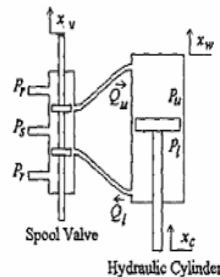

Fig. 2: Double acting hydraulic actuator

4. CONTROL SCHEMES

In this section, control schemes for the vibration suppression of the suspension system are proposed. Initially, an active force control (AFC) is designed. This is then extended to incorporate an input shaping (IS) scheme for the control of vibration of the system.

4.1 Active Force Control

Active force control (AFC) strategy was first proposed by Hewit and co-workers to control a dynamic system in order to ensure the system remains stable and robust in the presence of known and unknown disturbances [5]. AFC has been demonstrated to be superior compared to conventional methods in controlling a robot arm [1,4,5]. AFC can be shown to complement the basic Newton's second law of motion, i.e. for a translational system, $\sum F = ma$, where F is the sum of all forces acting on the body, m is the mass of the body and a is the acceleration. The concept of AFC is to use some measured and estimated values of the identified system parameters namely the actuated forces, acceleration of the body and the estimated mass of the body. The basic AFC equation can then be written as follows:

$$F' = F - m'a' \quad (4)$$

where the superscript ($'$) denotes the measured or estimated values of the parameters. Figure 3 illustrates the principle of AFC applied to a translational system. The measurable physical quantities of the system are the actuating force (F) and the acceleration (a'). These can be measured using force and acceleration sensors, respectively. The estimated mass (m') of the system with the presence of disturbances that contributes to the acceleration should be estimated appropriately. If all parameters are successfully acquired, then the resulting estimated force (F') from equation (4) should result in a very robust and stable performance of the control system once this signal is fed back to the AFC control loop.

4.2 Input Shaping

The method of input shaping involves convolving a desired command with a sequence of impulses. The design objectives are to determine the amplitude and time location of the impulses. A brief derivation is given in this section. Further details can be found in [9]. A vibratory system of any order can be modelled as a superposition of second order systems with transfer function:

$$G(s) = \frac{\omega^2}{s^2 + 2\xi\omega s + \omega^2}$$

where ω is the natural frequency and ξ is the damping ratio of the system. Thus, the impulse response of the system can be obtained as:

$$y(t) = \frac{A\omega}{\sqrt{1-\xi^2}} e^{-\xi\omega(t-t_0)} \sin(\omega\sqrt{1-\xi^2}(t-t_0))$$

$$K = e^{-\frac{\xi\pi}{\sqrt{1-\xi^2}}}$$

where A and t_0 are the amplitude and time of the impulse respectively. Further, the response to a sequence of impulses can be obtained by superposition of the impulse responses. Thus, for N impulses, with $\omega_d = \omega(\sqrt{1-\xi^2})$, the impulse response can be expressed as:

$$y(t) = M \sin(\omega_d t + \beta)$$

where

$$M = \sqrt{\left(\sum_{i=1}^N B_i \cos \phi_i\right)^2 + \left(\sum_{i=1}^N B_i \sin \phi_i\right)^2},$$

$$B_i = \frac{A_i \omega}{\sqrt{1-\xi^2}} e^{-\xi\omega(t-t_0)} \text{ and } \phi_i = \omega_d t_i.$$

A_i and t_i are the magnitudes and times at which the impulses occur.

The residual vibration amplitude of the impulse response can be obtained by evaluating the response at the time of the last impulse, t_N as:

$$V = \frac{\omega}{\sqrt{1-\xi^2}} e^{-\xi\omega(t_N)} \sqrt{(C(\omega, \xi))^2 + (S(\omega, \xi))^2} \quad (5)$$

where

$$C(\omega, \xi) = \sum_{i=1}^N A_i e^{-\xi\omega t_i} \cos(\omega_d t_i)$$

and

$$S(\omega, \xi) = \sum_{i=1}^N A_i e^{-\xi\omega t_i} \sin(\omega_d t_i)$$

In order to achieve zero vibration after the input has ended, it is required that $C(\omega, \xi)$ and $S(\omega, \xi)$ in equation (5) are independently zero. Furthermore, to ensure that the shaped command input produces the same rigid body motions as the unshaped command, it is required that the sum of impulse amplitudes $\sum_{i=1}^N A_i = 1$. To avoid delay, the first impulse is selected at time 0. The simplest constraint is zero vibration at expected frequency and damping of vibration using a two-impulse sequence. Hence by setting Equation (5) to zero, and solving yields a two-impulse sequence with parameters as:

$$t_1 = 0, \quad t_2 = \frac{\pi}{\omega_d},$$

$$A_1 = \frac{1}{1+K}, \quad A_2 = \frac{K}{1+K} \quad (6)$$

where

The robustness of the input shaper to error in natural frequencies of the system can be increased by setting $\frac{dV}{d\omega} = 0$, where $\frac{dV}{d\omega}$ is the rate of change of V with respect to ω . Setting the derivative to zero is equivalent to setting small changes in vibration for changes in the natural frequency. Thus, additional constraints are added into the equation, which after solving yields a three-impulse sequence with parameters as:

$$t_1 = 0, \quad t_2 = \frac{\pi}{\omega_d}, \quad t_3 = 2t_2,$$

$$A_1 = \frac{1}{1+2K+K^2}, \quad A_2 = \frac{2K}{1+2K+K^2}, \quad (7)$$

$$A_3 = \frac{K^2}{1+2K+K^2}$$

where K is as in Equation (6). The robustness of the input shaper can further be increased by taking and solving the second derivative of the vibration in Equation (6). Similarly, this yields a four-impulse sequence with parameters as:

$$t_1 = 0, \quad t_2 = \frac{\pi}{\omega_d}, \quad t_3 = 2t_2, \quad t_4 = 3t_2,$$

$$A_1 = \frac{1}{1+3K+3K^2+K^3}, \quad A_2 = \frac{3K}{1+3K+3K^2+K^3},$$

$$A_3 = \frac{3K^2}{1+3K+3K^2+K^3}, \quad A_4 = \frac{K^3}{1+3K+3K^2+K^3}. \quad (8)$$

where K is as in equation (6).

To handle higher vibration modes, an impulse sequence for each vibration mode can be designed independently. Then the impulse sequences can be convoluted together to form a sequence of impulses that attenuates vibration at higher modes. For any vibratory system, the vibration reduction can be accomplished by convolving any desired system input with the impulse sequence. This yields a shaped input that drives the system to a desired location without vibration. Incorporating the input shaping into AFC structure results in the combined AFC and input shaping control structure shown in Fig. 3.

5. RESULTS AND DISCUSSION

In this section, the proposed control schemes are implemented and tested within simulation environment of the suspension system and the corresponding results are presented. The suspension system is required to follow a bang-bang profile at +8 and -8 cm as shown in Fig. 4. It is considered as a form of 'disturbance' to the system. The output of the

hydraulic actuator then becomes the inputs of system dynamics within the AFC control loop. The AFC scheme has two inputs, namely the active force hydraulic actuator and body acceleration components. The estimation of mass needed by AFC loop is the main factor which contribute to the effectiveness of the control scheme. In this simulation, in order to estimate the mass needed to feed the forward control loops, neural network strategy is used.

The simulation works have been done with the parameters and conditions explained in [2,6,7] and demonstrate that sprung mass displacement, suspension deflection, tyre deflection when the car hitting the bump. Limit suspension deflection is ± 8 cm. The results for simulations described are given in Fig. 5. In each case, the solid line shows the response of the hybrid control strategy, the dotted line shows the response of passive response and the dashed line shows the response of the AFC control suspension system. It is obvious that the hybrid control produces the best performance compared to its counterparts in compensating the introduced disturbances. This shows that the system is more robust and effective.

To assess the vibration reduction in the system in the frequency domain, power spectral density (SD) of response at suspension is obtained. Thus, the first modes of vibration of the system are considered since these dominantly characterise the behaviour of the suspension system. Fig. 5 shows the simulation responses of the suspension system. Note that the vibration frequency of the system was obtained as 13 Hz. These results were considered as the system response in passive and subsequently used to evaluate the control techniques.

6. CONCLUSIONS

The development of a hybrid control scheme for vibration suppression of a suspension system has been presented. The control scheme has been developed based on AFC and input shaping methods. It has been implemented and tested within simulation environment of a suspension system considering the loading and operating conditions. The performances of the control scheme have been evaluated in terms of vibration suppression at the resonance modes of the suspension. Acceptable vibration suppression has been achieved with both control strategies. A comparative assessment of the control techniques has shown that the hybrid scheme results in better performance than the AFC control with respect to vibration suppression of the suspension.

REFERENCES

- [1] S.B. Hussein, H. Jamaluddin, M. Mailah, A. Zalzal, 2000, A Hybrid Intelligent Active Force Controller For Robot Arm Using Evolutionary Neural Networks', *Proc. Int'l Conference on Evolutionary Computation (CEC 2000)*, San Diego, USA.
- [2] M.V.C. Rao, V. Prahlad, , 1997, A Tunable Fuzzy Logic Controller for Vehicle Active Suspension Systems, *Fuzzy Set and System*.
- [3] F.J. D'Amato, D.E. Viassolo, , 2000, Fuzzy Control for Active Suspensions, *Mechatronics*.
- [4] M. Mailah, N.I.A. Rahim, 2000, Intelligent Active Force Control of a Robot Arm Using Fuzzy Logic, *IEEE International Conference on Intelligent Systems and Technologies TENCON 2000*, Kuala Lumpur.
- [5] M. Mailah, 1998, *Intelligent Active Force Control of a Rigid Robot Arm Using Neural Network and Iterative Learning Algorithms*, PhD Thesis, University of Dundee.
- [6] A. Alleyne, R. Liu, H. Wright, 1998, On the Limitations of Force Tracking Control for Hydraulic Active Suspensions", *Proc. Of the American Control Conference*, Philadelphia, Pennsylvania, June.
- [7] A.J. Barr and J.I Ray, 1996, Control of an active suspension using fuzzy logic, *Proceedings of the Fifth IEEE International Conference on Fuzzy Systems*, Vol. 1, Pages:42 - 48 vol.1, 8-11 Sept.
- [8] M. Negnevitsky, 2005, *Artificial Intelligence: A Guide to Intelligent Systems*, 2nd, Addison Wesley.
- [9] N. C. Singer and W. P. Seering Preshaping command inputs to reduce system vibration. *Transactions of ASME: Journal of Dynamic Systems, Measurement and Control* 1990; 112(1):76-82.

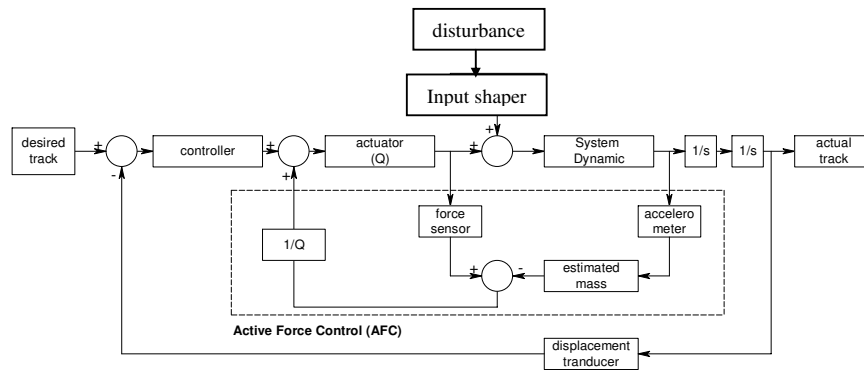

Fig. 3: A schematic diagram of AFC strategy

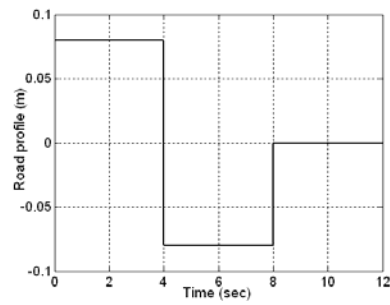
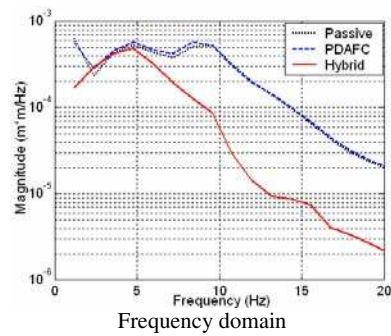
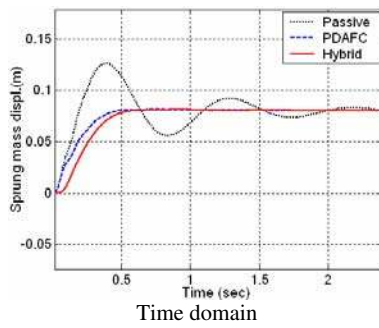
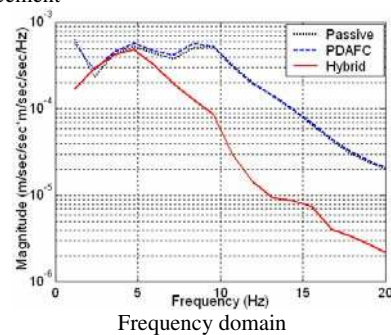
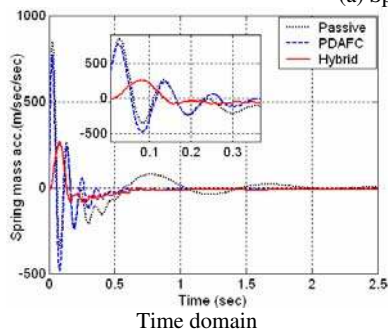

Fig. 4: Road profile



(a) Sprung mass displacement



(b) Sprung mass acceleration

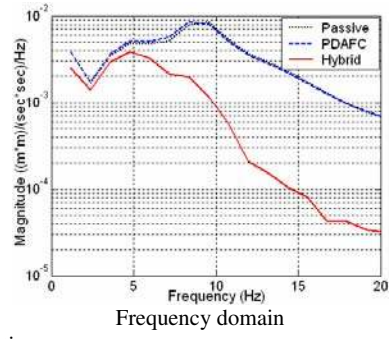
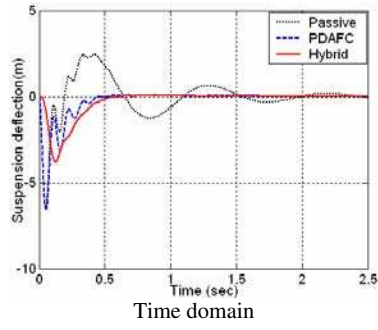

(c) Suspension deflection

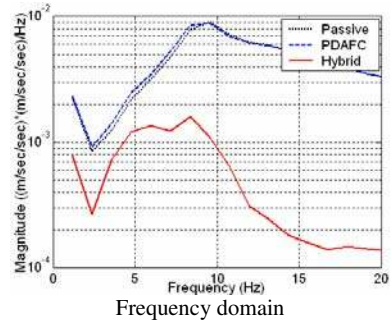
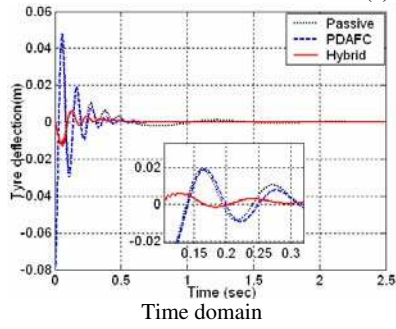

(d) Tyre deflection

Fig. 5: System responses with AFC and input shaping control scheme

CHAPTER 6

HYBRID CONTROL SCHEME INCORPORATING AFC AND INPUT SHAPING TECHNIQUE FOR A SUSPENSION SYSTEM

Md Zarhamdy M Zain, Gigih Priyandoko & Musa Mailah

Accepted for presentation at SITIA07, Indonesia, 12-15 May 2007

Vehicle Active Suspension System Using Skyhook Adaptive Neuro Active Force Control

G. Priyandoko*, M. Mailah and H. Jamaluddin

Intelligent Active Force Control Research Group
 Department of Applied Mechanics, Faculty of Mechanical Engineering,
 Universiti Teknologi Malaysia, Skudai, Johor, 81310 Malaysia
 Tel: +6075534562, Fax: +6075566159
 E-mail: gigihp@gmail.com
 E-mail: musa@fkm.utm.my
 E-mail: hishamj@fkm.utm.my

Abstract: This paper presents the practical design of a control technique applied to a vehicle active suspension system of a quarter car model using skyhook and adaptive neuro active force control (SAN AFC). The overall control system essentially comprises four feedback control loops, namely the innermost PI control loop for the force tracking of the pneumatic actuator, intermediate skyhook and AFC control loops for the compensation of the disturbances and outermost PID control loop for the computation of the optimum target/commanded force. Neural networks (NN) with modified adaptive Levenberg-Marquardt learning algorithms were used to approximate the estimated mass and inverse dynamics of the pneumatic actuator in the AFC loop. A number of experiments were carried out on a physical test rig with hardware-in-the-loop configuration that fully incorporates the theoretical elements. The performances of the proposed control method were evaluated and compared to examine the effectiveness of the system in suppressing the vibration effect of the suspension system. It was found that both simulation and experimental results of the active suspension system with SAN AFC scheme give better performance compared to the PID and passive counterparts.

Keywords: Active suspension; quarter car model; pneumatic actuator; active force control; skyhook; neural network.

Reference to this paper should be made as follows: Priyandoko, G., Mailah, M. and Jamaluddin, H. (2006) 'Vehicle Active Suspension System Using Skyhook Neuro Active Force Control', *Int. J. Intelligent Systems Technologies and Applications*, Vol. X, No. Y, pp.000–000.

Biographical notes: Gigih Priyandoko received his B.Eng. of Electrical Engineering from Brawijaya University of Indonesia and M.Sc. of Electrical Engineering from Bandung Institute of Technology (ITB), Indonesia. His current Ph.D. research is on intelligent vehicle active suspension using skyhook adaptive neuro active force control carried out at the Faculty of Mechanical Engineering, Universiti Teknologi Malaysia. His research interests include modelling, identification and design of controller using intelligent control methods. He is currently a lecturer in the Electrical Engineering, Faculty of Engineering, Universitas Widyagama, Malang, Indonesia.

Musa Mailah acquired his B.Eng. (Hons.) in Mechanical Engineering in 1988 from the Universiti Teknologi Malaysia (UTM) and later M.Sc. (Mechatronics) and Ph.D. (Mechatronics and Control) degrees in 1992 and 1998 respectively from the University of Dundee, UK. He is currently an Associate Professor in the Department of Applied Mechanics, Faculty of Mechanical Engineering, Universiti Teknologi Malaysia. His research interests are applied mechatronics and intelligent active force control.

Hishamuddin Jamaluddin received his B.Sc., M.Sc. and Ph.D. in the Department of Control Engineering, Sheffield University, UK. He is currently an Associate Professor in

the Department of Applied Mechanics, Faculty of Mechanical Engineering, Universiti Teknologi Malaysia (UTM), Johor, Malaysia. His research interests include non-linear system modeling, system identification, neural networks, adaptive fuzzy models, genetic algorithm, neuro-fuzzy and active force control.

1 Introduction

In many mechanical systems, it is often necessary and beneficial to isolate disturbance forces. A clear example can be seen in an automotive system in which the passenger/s of a car should ideally be isolated from vibration or shaking effects of the car's body when the car hits a bump or hole. In the conventional passive suspension system, the mass-spring-damper elements are generally fixed, and are chosen based on the design requirements of the vehicles. Passive suspension utilizing mechanical springs and dampers is known to have the limitations of vibration isolation and lack of attitude control of the vehicle body.

Active suspension differs from the conventional passive suspension in which an actuator is attached in parallel with both spring and shock absorber to inject energy into the system. The main advantage of employing an active suspension system is the associated adaptation potential where the suspension characteristics can be adjusted while driving to accommodate the profile of the road being traversed.

In any vehicle suspension system, there are a number of performance parameters that need to be optimized. Four important parameters of considerable interest are: (i) ride comfort which is related to acceleration sensed by passengers in the vehicle when traversing a rough road surface, (ii) body motion which is associated with the pitch and roll of the sprung mass created primarily by cornering and braking maneuvers, (iii) road handling which can be related to the contact force between the tyres and road surface,

and (iv) suspension deflection which refers to the relative displacement between the sprung and unsprung masses (Miller, 1988).

To tackle the problems in suspension systems, many researchers have studied numerous active vehicle suspension strategies both theoretically and experimentally (Alleyne and Hedrick, 1995; Lin and Kenellakopoulos, 1997; Ikenaga *et al.*, 1999; Yoshimura *et al.*, 2001; Huang and Lin, 2003). Many of these approaches are proposed for complicated models with non-linearity and uncertainty. Numerical and experimental results showed that such active suspension systems give relatively more satisfactory performance, but need more increasing loads to achieve active control, compared with the linear active suspension systems as reported in Yoshimura and Takagi (2004). Intelligent control of suspension system was also proposed using fuzzy logic (D'Amato and Viassolo, 2000) and neural network (Fu *et al.*, 2005). Both methods use the intelligent mechanisms as direct or main controllers and are found to be rather time consuming to design and implement, particularly in acquiring the appropriate membership functions plus inference mechanism (for fuzzy logic control) and training parameters plus optimum network structure (for neural network control).

On the other hand, active force control (AFC) has been recognized to be simple, robust and effective compared with conventional methods in controlling dynamical systems, both in theory as well as practice (Hewit and Burdess, 1986; Hewit and Marouf, 1996; Mailah, 1998). The concept of AFC is to use some measured and estimated values of the identified system parameters namely the actuated force, acceleration of the body and estimated mass of the body. In practice, the estimated mass of the system (with the presence of disturbances that contributes to the acceleration) should be appropriately

estimated using suitable methods such as the ones identified in Mailah (1998). In the proposed study, an intelligent mechanism using neural network is incorporated into the AFC loop serving not as the direct controller but merely as a means to approximate the essential parameters necessary to trigger the control action.

The objective of this paper is to design a practical hardware-in-the-loop control technique to reduce the sprung mass motion of a quarter car vehicle active suspension system almost similar to the one proposed by Ikenaga (2000) but significantly complemented with the proposed control and intelligent methods. The overall control system comprises four loops: the innermost force tracking control loop employing a classic PI controller for force tracking control of the pneumatic actuator; two intermediate control loops with skyhook and AFC to compensate for the disturbances containing the adaptive neural networks to compute on-line the estimated mass needed and the inverse dynamics of the actuator; and the outer positional control loop utilizing a PID controller to generate the target or commanded force. Performance of the vehicle suspension system is evaluated in terms of its ability to significantly reduce the sprung mass acceleration, sprung mass displacement, suspension deflection and tyre deflection in the presence of road disturbances and given operating conditions.

This paper is organized as follows. A quarter-car model is introduced in section 2 followed by the pneumatic actuator model in section 3. The implementation of control and intelligent methods is described in section 4. The experimental system is presented in section 5 while the results are analysed and discussed in section 6. Finally, the paper is concluded in section 7.

2 Dynamic Model of Active Suspension

The model of a quarter car active suspension system used is shown in Figure 1. The quarter car is represented by a two degree-of-freedom model.

Figure 1 A quarter car vehicle active suspension

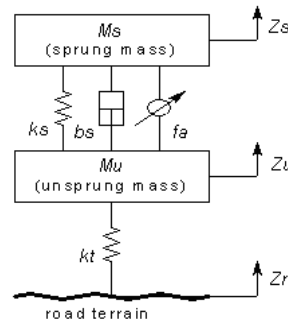

The equations of motion for this system are given as:

$$\begin{aligned} m_s \ddot{z}_s &= -k_s(z_s - z_u) - b_s(\dot{z}_s - \dot{z}_u) + f_a \\ m_u \ddot{z}_u &= k_s(z_s - z_u) + b_s(\dot{z}_s - \dot{z}_u) - k_t(z_u - z_r) - f_a \end{aligned} \quad (1)$$

where m_s , m_u , b_s , k_s , k_t , f_a , z_s , z_u , z_r , $z_s - z_u$, $z_u - z_r$, \dot{z}_s , \dot{z}_u are sprung mass, unsprung mass, damping coefficient, spring stiffness, tyre stiffness, actuator force, displacement of the sprung mass, displacement of unsprung mass, road profile, suspension deflection (suspension travel), tyre deflection, velocity of sprung mass and velocity of unsprung mass respectively.

3 Dynamic Model of a Pneumatic Actuator

Pneumatic actuators have the advantages of low cost, high power to weight ratio, ease of maintenance, having a readily available and cheap power source (Hamiti *et al.*, 1996).

But, pneumatic drives exhibit highly nonlinear characteristics due to the compressibility

of air, the complexity of friction presence and nonlinearity of valves. A mathematical model of a pneumatic actuator has been well described in Richer and Hurmuzlu (2000). The pneumatic cylinder consists of three subsystems: the valve, the cylinder contains piston and chambers, and the load. Every subsystem will be presented in the following paragraphs with reference to the coordinate system illustrated in Figure 2.

Figure 2 The pneumatic system

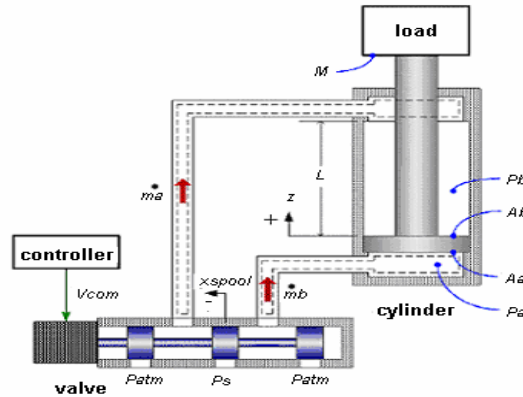

The equation of motion for the piston-rod-load assembly can be expressed as (Gross and Rattan, 1998):

$$\ddot{z} = \frac{\sum F_{applied}}{mass_{load}} = \frac{P_b A_b - P_a A_a - F_f}{M} \quad (2)$$

where M is the load mass, z is the piston position, β is the viscous friction coefficient, F_f is the Coulomb friction force, P_a and P_b are the absolute pressures in actuator's chambers, A_a and A_b are the piston effective areas. The right-hand side of equation (2) contains the actuator force produced by pressure differential acting across the piston. In order to control the actuator force output, one has to finely tune the pressure levels in the

cylinder chambers using the command element. The time rate of change of differential pressure can be written as:

$$\Delta\dot{P} = \dot{P}_a - \dot{P}_b = \frac{\gamma\dot{m}_a RT}{V_a} + \frac{\gamma P_a \dot{V}_a}{V_a} - \frac{\gamma\dot{m}_b RT}{V_b} - \frac{\gamma P_b \dot{V}_b}{V_b} \quad (3)$$

where P , V , R , T , γ and m are pressure, volume, ideal gas constant, temperature, the ratio of specific heat (air = 1.4) and mass of the air in the cylinder. P_a and P_b is pressure in chamber a and b respectively. The chamber volumes V_a and V_b are defined as:

$$V_a = A_a \left(\frac{L}{2} - x \right) \text{ and } V_b = A_b \left(\frac{L}{2} + x \right) \quad (4)$$

where L and x are stroke length and load position respectively.

The compressible flow through a fixed orifice can be represented by the following equations:

$$\dot{m}_a = AC_q C_m \frac{P_a}{\sqrt{T}} \text{ and } \dot{m}_b = AC_q C_m \frac{P_b}{\sqrt{T}} \quad (5)$$

where A is the orifice area, C_q is a non-dimensional flow coefficient, and C_m is the flow parameter having the following expression:

$$C_m = \sqrt{\frac{2\gamma}{R(\gamma-1)}} \sqrt{\left(\frac{P_{a,b}}{P_s}\right)^{(2/\gamma)} - \left(\frac{P_{a,b}}{P_s}\right)^{(\gamma+1/\gamma)}}, \text{ if } \frac{P_{a,b}}{P_s} > P_{cr} (= 0.528) \quad (6)$$

$$C_m = 0.0404, \text{ if } \frac{P_{a,b}}{P_s} \leq P_{cr} (= 0.528)$$

where P_s is supply pressure, P_{cr} is critical pressure ratio (= 0.528).

4 Implementation of Control Methods and Neural Network

In this section, all the major elements constituting the design and implementation of the overall control system are described and presented.

4.1 Force Tracking Control Loop

The force tracking control for actuator commands was first designed. The majority of the existing literatures assume that the command force can be achieved accurately and frequently done without considering the actuator dynamics which are highly nonlinear. When a less ability actuator is used, the design of the sub-loop needs to be carried out first in order to ensure force tracking ability of the actuator using a conventional PI controller (Chantranuwathana and Peng, 1999) as depicted in Figure 3. The validation of the force tracking capability is done by considering sinusoidal, square wave, chirp signal and saw tooth as input forcing functions.

Figure 3 Force tracking PI control

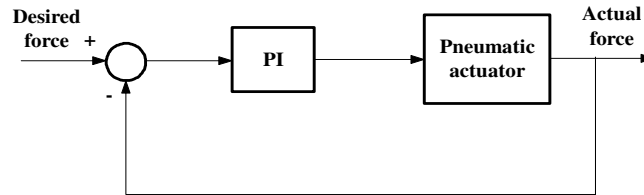

In order to get appropriate values of P and I controller is used PID relay auto-tuner of Astrom–Hagglund (1984) rules. The transfer function of a PID controller is given as follows:

$$G_{PID} = K_p \left(1 + \frac{1}{T_i s} + T_d s \right) \quad (7)$$

where $T_i = K_p/K_i$, $T_d = K_d/K_p$, and K_p , K_i , K_d are proportional, integral, derivative gains, respectively. The PID relay auto-tuner of Astrom–Hagglund (1984) is one of the simplest and most robust auto-tuning techniques. In order to obtain the initial parameters of PID controller, a relay experiment is used to generate a sustained oscillation of the controlled

variable and obtain the critical gain (K_u) and the critical period of waveform oscillation (P_u). The ultimate gain (K_u) is calculated as:

$$K_u = \frac{4d}{\pi a} \quad (8)$$

where d is the amplitude of the relay auto tuner output, a is the amplitude of the waveform oscillation. Based on these two values, the PI parameters (K_p and K_i) to force tracking control can be derived using Ziegler-Nichols formulation.

4.2 Active Force Control

The compensation action of AFC involves direct measurement or estimation of a number of identified parameters. Hence, a large portion of mathematical and computational burden can be reduced significantly. AFC can be shown to complement the basic Newton's second law of motion, i.e. for a translational and rotational system. For an active vehicle suspension the equation of motion can be written as follows (Hewit and Marouf, 1996):

$$F + Q = m_s a \quad (9)$$

where F is the applied force, Q is disturbance force, m_s is sprung mass and a is acceleration of the sprung mass, respectively. The AFC scheme applied to a suspension system is shown in Figure 4.

The estimated value of the disturbance force, Q' , can be formulated as:

$$Q' = F' - (m_s' a') \quad (10)$$

where the superscript (') denotes the measured or estimated values of the parameters. The measurable physical quantities of the system are the actuating force (F') and the

acceleration (a'). These can be conveniently measured using force (or pressure) sensor and acceleration sensor respectively. The estimated mass (m') of the system with the presence of disturbances that contributes to the acceleration should be estimated appropriately. If all parameters are successfully acquired, then the resulting estimated force (F') from equation (10) should result in a very robust and stable performance of the control system once this signal is fed back to the AFC control loop (Mailah, 1998). A number of approximation techniques have been investigated to acquire the appropriate estimated mass such as iterative learning control (Kwek *et al.*, 2003), PI-AFC (Mailah *et al.*, 2005), fuzzy logic (Mailah and Rahim, 2000) and hybrid intelligent method (Hussein *et al.*, 2000). It is a well-known fact that the effectiveness of the AFC strategy largely depends on the appropriate acquisition of the estimated mass. Often, the estimated mass of the system varies nonlinearly. This is normally caused by the effect of noise, friction, vibration and other unknown disturbances.

Figure 4 AFC scheme applied to vehicle suspension.

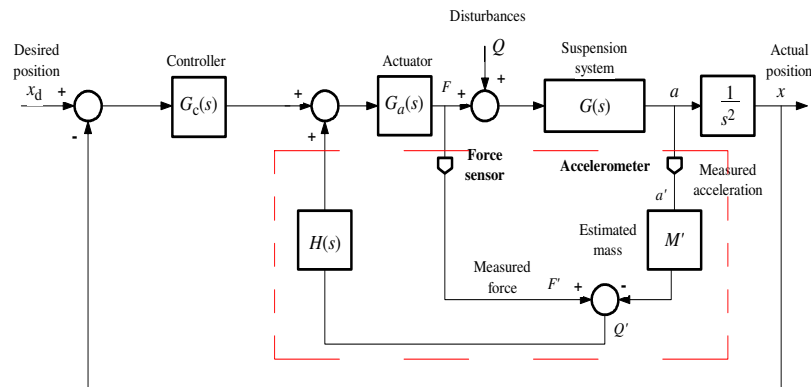

From Figure 4, the transfer function $H(s)$ needs to be determined by obtaining the inverse of $G_a(s)$ (Hewit and Burdess, 1986). If $G_a(s)$ is a simple gain (as assumed in most cases previously studied), then $H(s)$ is just a reciprocal of the scalar quantity of the $G_a(s)$.

However, if the expression of $G_a(s)$ is complex and non-linear, then other suitable methods to get appropriate value of $H(s)$ should be applied. In this study, the inverse dynamics of the actuator is determined using neural network as explained in section 4.5.

4.3 Skyhook Control

The skyhook control introduced by Karnopp in 1995 is known most effective in terms of the simplicity of the control algorithm. Their original work uses only one inertia damper between the sprung mass and the inertia frame. The damper is connected to an inertial reference in the sky. This arrangement is fictitious, since to implement this configuration, the damper would have to be connected to a reference point which is fixed with respect to the vehicle. The fictitious force computed from the added skyhook damper is called as the actuator force (F_{sky}). The force F_{sky} of this element according to the skyhook control law is (Valásek and Kortüm, 2006):

$$F_{sky} = -B_{sky}\dot{z}_s \quad (11)$$

where B_{sky} is a constant value, is determined to be approximately 3000 Newton/m/s in the experimental system.

Thus, the total desired force (F_d) applied to the pneumatic actuator is as follows:

$$\begin{aligned} F_d &= F_{sky} + F_{AFC} \\ &= -B_{sky}\dot{z}_s + \left[(F' - m_s' \ddot{z}_s') G_a^{-1} \right] \end{aligned} \quad (12)$$

where G_a is the dynamic actuator in Figure 4.

4.4 Outermost PID Control Loop

The description of the PID controller is exactly similar to that described in section 4.1, and the resulting controller gains were computed as $K_p = 35$, $K_i = 1.9$ and $K_d = 360$.

4.5 Implementation of Neural Network

NN has potentials to be applied for intelligent control system because it can learn, adapt, and approximate nonlinear functions very well. The feed-forward NN structure in this work employed a one hidden layer network with three hidden neurons network that resembles the one described in Wilamowski *et al.* (1999). Sigmoid bipolar is chosen for hidden layer and linear function for output layer. All parameters of the model were normalized in the range of [-1,1] representing the minimum and maximum range of the parameter values.

Error between the outputs of the plant and network is used as the learning signal for NN to get appropriate weights and biases. The learning algorithm which is based on minimizing the error (mean square error) can be given as follows:

$$e^2(k) = (y_d(k) - y_a(k))^T (y_d(k) - y_a(k)) \quad (13)$$

where e is current error, y_d is desired output, y_a is current output at iteration-k.

There are a number of learning algorithms reported in the literature; the two most frequently used are the error backpropagation (BP) and Levenberg-Marquardt (LM) algorithms. The LM algorithm is currently considered as the more efficient second order algorithm for training the feedforward NN (Wilamowski *et al.*, 2001).

To minimize error with respect to the weights, updating the weights of each layer using LM method in time $t > 0$ can be represented as follows (Hagan and Menhaj, 1994):

$$w_{ij}(k+1) = w_{ij}(k) + \Delta w_{ij}(k) \quad (14)$$

$$\Delta w_{ij}(k) = \left[J^T(w_{ij}(k)) J(w_{ij}(k)) + \mu I \right]^{-1} J(w_{ij}(k)) e(w_{ij}(k)) \quad (15)$$

where $w_{i,j}$ is weight, J is Jacobian matrix, μ is learning rate and I is identity matrix.

The LM algorithm requires computation of the J matrix at each iteration step and inversion of $J^T J$ square matrix. This is the reason why for large size neural networks the LM algorithm is not practical for on-line training algorithm. Based on Sherman-Morrison-Woodbury matrix identity, equation (15) can be modified as follows (Wilamowski *et al.*, 1999):

$$\begin{aligned} \Delta w_{ij}(k) &= \left[\frac{1}{\mu} I - \frac{1}{\mu^2} \Omega \right] J(w_{ij}(k))^T e(w_{ij}(k)) \\ \Omega &= J^T(w_{ij}(k)) \left(I + \frac{1}{\mu} J(w_{ij}(k)) J^T(w_{ij}(k)) \right)^{-1} J(w_{ij}(k)) \end{aligned} \quad (16)$$

For a single output network, equation (16) becomes:

$$\Delta w_{ij}(k) = \frac{1}{\mu} \left[I - \frac{J^T(w_{ij}(k)) J(w_{ij}(k))}{\mu + J^T(w_{ij}(k)) J(w_{ij}(k))} \right] J(w_{ij}(k))^T e(w_{ij}(k)) \quad (17)$$

There are two identical neural networks with LM algorithms used in the AFC loop. Each neural network has one hidden layer with three associative neurons and every neuron using sigmoid bipolar function. The first network, NN1 computes the estimated mass, while the second one, NN2 calculates the inverse dynamics of the pneumatic actuator. Both the estimated mass and inverse dynamics of the actuator have to be ascertained to effect the compensation of disturbances. Figure 5 shows the structures of NN1 and NN2 used in the proposed scheme. The input of NN1 is the sprung mass acceleration while the output is the estimated mass. The input of NN2 is the output of pneumatic actuator, while the output signal of NN2 is continuously compared with the desired force. Minimization of NN1 and NN2 errors is applied for updating the weights and biases using the adaptive LM learning algorithm.

Figure 5 Structure of NN (a) Estimates mass (b) Inverse dynamic actuator

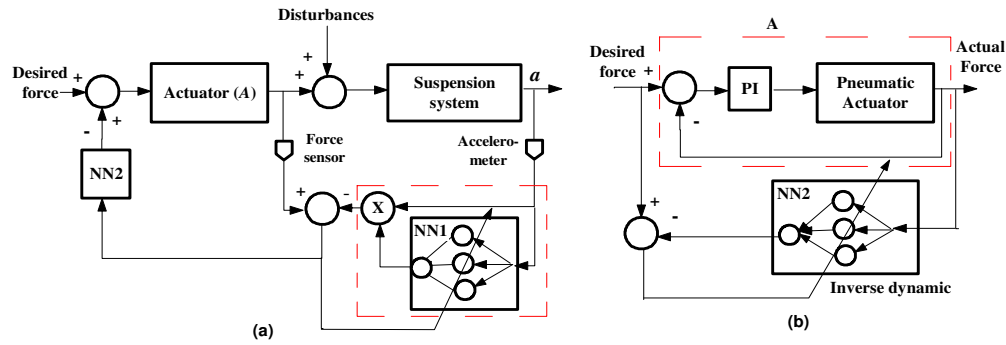

4.6 Proposed SAN AFC scheme

Having shown all the individual elements of the control and intelligent techniques, the complete SAN AFC scheme can be seen in Figure 6. Although the system looks complex, the actual implementation can be easily realized through simulation and experimental study with the aid of MATLAB and its related products, i.e. Simulink, Control System Toolbox, Neural Network Toolbox and Real-Time Workshop (RTW).

Figure 6 Proposed SAN AFC control scheme

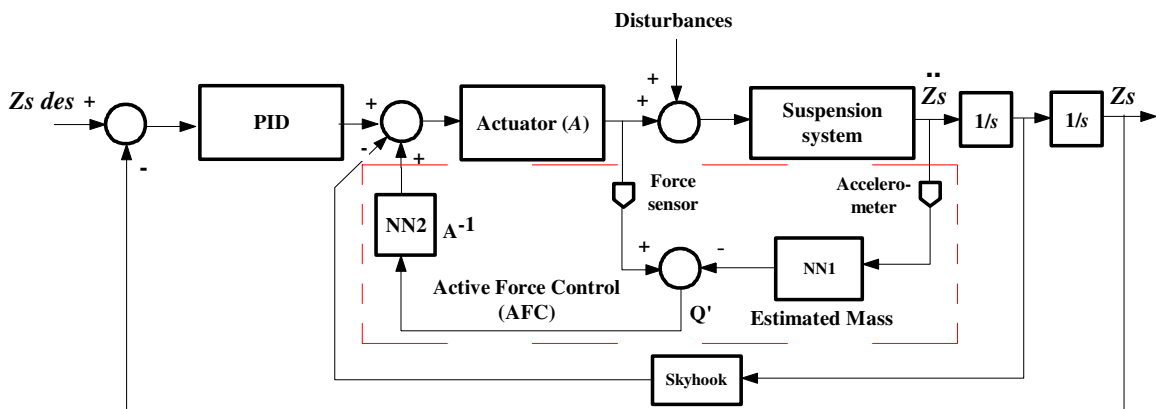

5 Experimental System

This section presents the practical aspect of the suspension system that employs the proposed control technique. A schematic of the experimental set-up and a photograph of the actual rig are given in Figure 7. The relevant parameters of the vehicle active suspension system are presented in Table 1. Figure 8 shows the Simulink model of the suspension rig utilizing the hardware-in-the-loop configuration.

Figure 7 Experimental set-up and a photograph of the suspension system

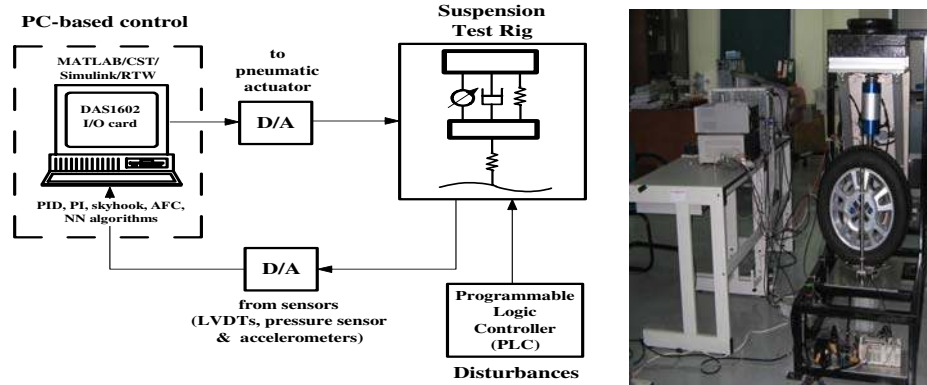

Figure 8 Simulink model of the suspension system

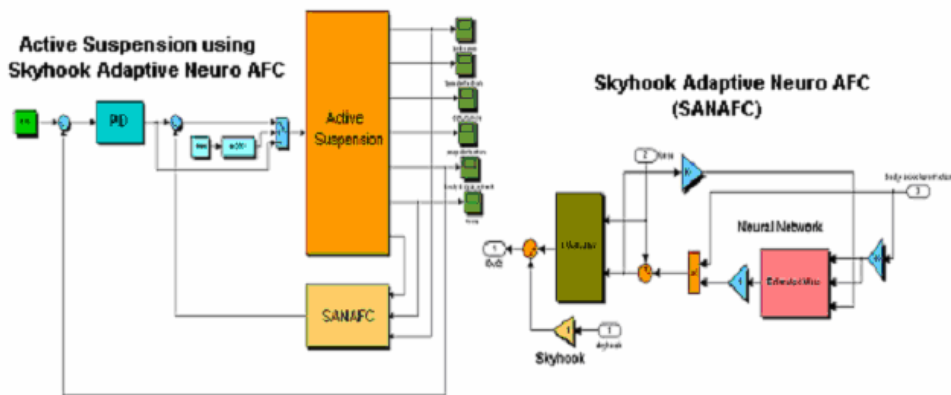
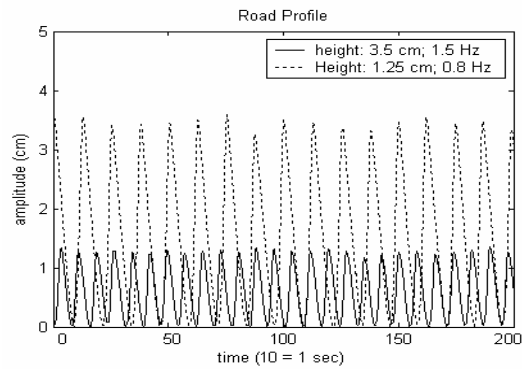

Table 1 Vehicle suspension and pneumatic parameters

Description	Value	Description	Value
sprung mass (kg)	170	tyre stiffness (N/m)	86240
unsprung mass (kg)	25	stroke length (mm)	116
suspension damping (N/m/sec)	1130	diameter bore (mm)	40
suspension stiffness (N/m)	10520	ram area (mm ²)	0.0076

Physical sensors required for input/output (I/O) signals were connected to a PC-based data acquisition and control system using MATLAB, Simulink and Real-Time Workshop (RTW) that essentially constitute a hardware-in-the-loop configuration, implying that the simulation can be effectively converted to the equivalent practical scheme without much fuss. A 100 Hz sampling frequency was used in conjunction with a data acquisition card (Keithley Metrabyte DAS 1602) that is fitted into one of the expansion slots of the PC. Appropriate signals are processed using the analogue-to-digital (A/D) and digital-to-analogue converters (D/A) channels which are already embedded in the DAS card. Accelerometers were installed at the sprung and unsprung masses of the vehicle suspension to measure body acceleration and tyre deflection, respectively. A linear variable differential transformer (LVDT) was placed in between the sprung and unsprung masses to measure suspension deflection. Another LVDT was used to measure the vertical displacement of road profile. Two types of road profiles (as disturbances) were used in the form of approximate sinusoidal signals generated by a specially designed pneumatic system controlled by a programmable logic controller (PLC). The generated signals are depicted in Figure 9. The pneumatic actuator is connected with a proportional pneumatic valve, Koganei ETR600-2.

Figure 9 Road profile

6 Results and Discussion

6.1 Force tracking control

The experimental results of the force tracking control are shown in Figure 10 which clearly shows that the actual trajectories are able to track or conform to the desired ones. This signifies that the appropriate controller setting enables the pneumatic actuator to operate satisfactorily.

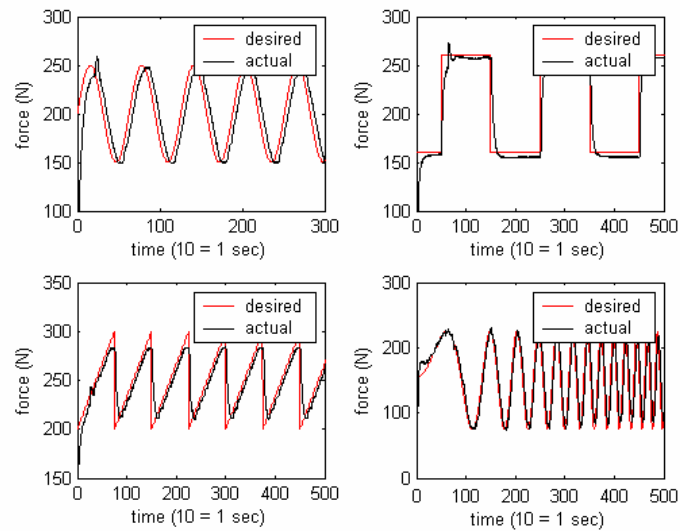
Figure 10 Force tracking control of the actuator

6.2 Experimental results

In this section, the benefits of active suspension using skyhook adaptive neuro AFC (SANAFc) over passive suspension and active suspension using PID controller for a sinusoidal road input frequency 0.8 Hz, 1.25 cm height, and frequency 1.5 Hz, 3.5 cm height are investigated both through simulation as well as experimental studies. The results can be seen in Figures 11 and 12. These frequencies are used because they are close to the frequency of the body of the suspension system, which is approximately 1 Hz and thus the active suspension should be designed so as to produce improvement in ride quality at this frequency.

Figure 11 Active suspensions with a sinusoidal 3.5 cm height, frequency = 1.5 Hz
(a) simulation (b) experiment

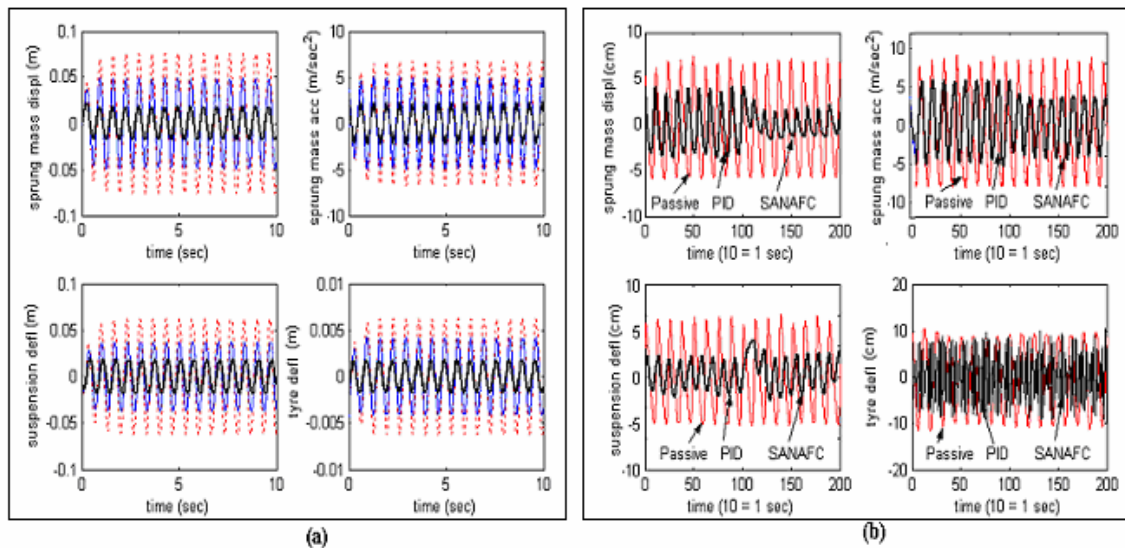

From Figure 10a, the simulation results indicate that the SANAFc scheme (solid black line) has shown significant improvement over the PID controller (solid blue line) and passive suspension (dotted red line) for all parameters throughout the simulation period. Figure 10b depicts the experiment results in which the passive suspension is

implemented to run from 0 to 20 seconds (red line); PID controller is implemented to operate from 0 to 10 seconds (solid black line), while the SANAFc continues from 10 to 20 seconds (solid black line). The disturbance induced for all the methods is in the form of sinusoidal road profile with amplitude 3.5 cm and frequency 1.5 Hz which is synonymous to a low frequency vibration effect. The amplitudes of sprung mass acceleration, sprung mass displacement and suspension deflection for SANAFc show significant reduction that implies improvement in riding performance. However, the tyre deflection in the SANAFc scheme shows only marginal improvement almost similar to that of the PID controller and passive suspension. This is chiefly due to trading-off and ‘sacrificing’ of the tyre deflection in order to obtain significant improvement on both sprung mass acceleration and sprung mass displacement. The other reason may be contributed by the wheel-hopping phenomenon during the experiment which makes it difficult to improve tyre deflection performance.

Figure 12 Active suspensions with a sinusoidal 1.25 cm height, frequency = 0.8 Hz
(a) simulation (b) experiment

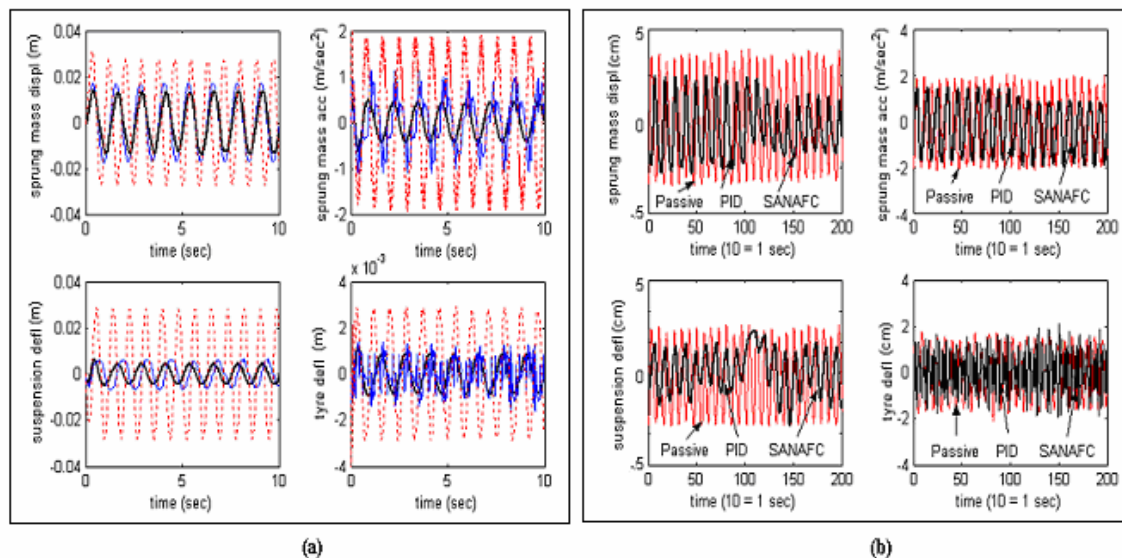

From Figures 12a and 12b, the amplitudes of sprung mass acceleration, sprung mass displacement and suspension deflection for active suspension based on SANAFc still show improvement compared to both PID controller and passive suspension, although these amplitudes are smaller than those in Figure 11. Again, for the experimental part, the amplitude of the tyre deflection for the SANAFc scheme shows almost indifferent results with the PID controller and passive suspension counterparts.

8 Conclusion

A novel controller employing the skyhook adaptive neuro active force control (SANAFc) has been designed and implemented for the control of a vehicle quarter car active suspension. The simulation of the scheme readily produces results which illustrate the superiority of the scheme over its counterparts in all aspects related to its riding performance. From the experimental results, it can be also deduced that the active suspension based on SANAFc controller outperforms the PID controller and passive suspension in all selected performance criteria. Thus, it can be concluded that the SANAFc controller is very effective in isolating the vibration effect on the sprung mass which in turn considerably improve the overall system performance. Future works may include more effort in improving the tyre deflection performance and consider other operating and loading conditions.

Acknowledgements

The authors would like to thank the *Malaysian Ministry of Science and Technology and Innovation* (MOSTI) and *Universiti Teknologi Malaysia* (UTM) for their continuous support in the research work. This research was fully supported by an IRPA grant (No. 03-02-06-0123EA001).

References

- Alleyne, A. and Hedrick, J.K. (1995) 'Nonlinear adaptive control of active suspension', *IEEE Trans. on Control System Technology*, vol. 3(1): 94-101.
- Astrom, K.J. and Hagglund, T. (1984) 'Automatic tuning of simple regulators with specification on phase and amplitude margin', *Automatica*, vol. 20, 645-651.
- Chantranuwathana, S. and Peng, H. (1999) 'Force tracking control for active suspensions - theory and experiments', *Proceedings of the IEEE International Conference on Control Applications*, 22-27 August, Hawaii, USA, vol. 1: 442-447.
- D'Amato, F.J. and Viassolo, D.E. (2000) 'Fuzzy Control for Active Suspensions', *Mechatronics*, vol. 10: 897-920.
- Fu, L.J., Cao, J.G., Liao, C.R. and Chen, B. (2005) 'Study on Neural Networks Control Algorithms for Automotive Adaptive Suspension Systems', *International Conference on Neural Networks and Brain 2005*, vol. 3: 1795-1799.
- Gross, D.C. and Rattan, K.S. (1998) 'An adaptive multilayer neural network for trajectory tracking control of a pneumatic cylinder', *IEEE International Conference on Systems, Man, and Cybernetics 1998*, 11-14 October, vol. 2: 1662 - 1667.
- Hagan, M.T. and Menhaj, M.B. (1994) 'Training feedforward networks with the Marquardt algorithm', *IEEE Transactions on Neural Network*, vol. 5(6): 989-993.
- Hamiti, K., Voda-Besanqon, A. and Roux-Buisson, H. (1996) 'Position control of a pneumatic actuator under the influence of stiction', *Control Engineering Practice*, vol. 4(8): 1079-1088.
- Hewit, J.R. and Burdess, J.R. (1986) 'An active method for the control of mechanical systems in the presence of unmeasurable forcing', *Trans. Mechanism and machine Theory*, 21(3): 393-400.
- Hewit, J.R. and Marouf, K.B. (1996) 'Practical control enhancement via mechatronics design', *IEEE Transactions on Industrial Electronics*, vol. 43(1): 16-22.
- Huang, S.J. and Lin, W.C. (2003) 'A self organizing fuzzy controller for an active suspension system', *Journal of Vibration and Control*, vol. 9(9): 1023-1040.
- Hussein, S.B., Jamaluddin, H., Mailah M. and Zalzal, A. (2000) 'A hybrid intelligent active force controller for robot arm using evolutionary neural networks', *Proc. Int. Conf. on Evolutionary Computation (CEC 2000)*, San Diego, USA, 117-124.
- Ikenaga, S.A., Lewis, F.L., Davis, L., Kampos, J., Evans, M. and Scully, S. (1999) 'Active suspension control using a novel strut and active filtered feedback: design and implementation', *Proc. of IEEE International Conference on Control Applications*, Hawaii, USA: 1502-1508.
- Ikenaga, S.A. (2000) 'Development of a real time digital controller: application to active suspension control of ground vehicle', University of Texas at Arlington, *Ph.D. Thesis*.
- Kwek, L.C., Wong, E.K., Loo, C.K. and Rao, M.V.C. (2003) 'Application of Active Force Control and Iterative Learning in a 5-Link Biped Robot', *Journal of Intelligent and Robotic Systems*, vol. 37: 143-162.
- Lin, J.S. and Kenellakopoulos, I. (1997) 'Nonlinear design of active suspensions', *Control Systems Magazine*, vol. 17(3): 45-59.
- Mailah, M. (1998) 'Intelligent active force control of a rigid robot arm using neural network and iterative learning algorithms', University of Dundee, *Ph.D. Thesis*.
- Mailah, M. and Rahim, N.I.A. (2000) 'Intelligent active force control of a robot arm using fuzzy logic', *IEEE Int. Conf. on Intelligent Systems and Technologies TENCON 2000*, Kuala Lumpur, 291-296.
- Mailah, M., Pitowarno, E. and Jamaluddin, H. (2005) 'Robust motion control for mobile manipulator using resolved acceleration and proportional-integral active force control', *International Journal of Advanced Robotic Systems*, vol. 2(2): 125-134.

- Miller, L.R. (1988) 'Tuning passive, semi active, and fully active suspension', *Proceedings of the 27th Conference on Decision and Control*, Austin, Texas, 7-9 December, vol. 3: 2047-2053.
- Richer, E. and Hurmuzlu, Y. (2000) 'A High Performance Pneumatic Force Actuator System: Part I - Nonlinear Mathematical Model', *Transactions of the ASME*, vol. 122: 416-425.
- Valásek, M. and Kortüm, W. (2006) *Mechanical Systems Design Handbook: Modeling, Measurement, and Control*, Taylor and Francis Group, LLC.
- Wilamowski, B.M., Chen, Y. and Malinowski, A. (1999) 'Efficient algorithm for training neural networks with one hidden layer', *Proceedings of International Joint Conference on Neural Networks*, vol. 3: 1725-1728.
- Wilamowski, B.M., Iplikci, S., Kaynak, O. and Efe, M.O. (2001) 'An Algorithm for Fast Convergence in Training Neural Networks', *Proceedings International Joint Conference on Neural Networks*, vol. 3: 1778-1782.
- Yoshimura, T., Kume, A., Kurimoto, M. and Hino, J. (2001) 'Construction of an active suspension system of a quarter car model using the concept of sliding mode control', *Journal of Sound and Vibration*, 239(2): 187-199.
- Yoshimura T. and Takagi A. (2004) 'Pneumatic active suspension system for a one-wheel car model using fuzzy reasoning and a disturbance observer', *Journal of Zhejiang University SCIENCE*, vol. 5(9): 1060-1068.

CHAPTER 7

VEHICLE ACTIVE SUSPENSION SYSTEM USING SKYHOOK ADAPTIVE NEURO ACTIVE FORCE CONTROL

Gigih Priyandoko, Musa Mailah & Hishamuddin Jamaluddin

To be submitted to Mechatronics (an International Journal), May 2007

CHAPTER 8

CONCLUSIONS AND RECOMMENDATIONS

8.1 Conclusions

Specific objectives of the project have been met. A very robust active suspension system using intelligent active force control (AFC) strategy has been designed and developed both through simulation and experimental studies. The performance of the proposed system has been tested and evaluated based on numerous loading and operating conditions.

The simulation work suggests that the riding comfort of the active suspension system with AFC-based scheme is considerably improved through the suppression of the body acceleration and displacement in the event of different road profiles and vibration excitation. Both the linear and non-linear modelled actuators incorporated into the schemes as the main active elements of the proposed system were effective in generating the necessary torques to cancel out the disturbances in the AFC loop. Intelligent methods to compute the estimated virtual mass using neural network (NN), adaptive fuzzy logic (AFL) and their hybrid seems to indicate that the estimated parameter has been appropriately identified and used. The results clearly show the robust performance of the systems that almost render the body (sprung mass) of the quarter car model unaffected by the changes in the applied external forces and variation in parameters. This demonstrates the improved riding comfort of the vehicle having the abovesaid control elements.

The practical system was successfully realized in the form of a working prototype active suspension system employing a number of control schemes that are theoretically defined in the report. The AFC schemes were designed and implemented into the prototype by way of rigorous programming, interfacing and control taking into account the hardware-in-the-loop configuration using MATLAB, Simulink and Real-Time Workshop (RTW) with various inputs (sensory devices) and outputs (actuators). The results obtained from the experiments do complement and ‘tally’ with those of the theoretical (simulation) counterparts implying that the schemes were successfully validated even though it was found that the experimental findings were rather crude and much lower in accuracy, obviously due to a number of physical constraints. Indeed, a complete mechatronic approach and design was fully exploited in the research.

8.2 Recommendations for Future Works

A number of recommendations for future works is listed as follows:

- Perform a rigorous stability analysis of the suspension system with various AFC-based schemes.
- Simulate system using other forms of operating and loading conditions to further investigate the system robustness and accuracy in performing its tasks. This may include different road profiles, excitations, payloads and other forms of external disturbances and considering responses at higher frequencies.
- Add more intelligence to the system be it through software program (incorporating other artificial intelligence (AI) techniques) or hardware by way of using intelligent (or smart) sensors and electronics.
- Solve some of the current problems related to physical hardware constraints such as appropriate mounting of sensors and actuators and also using more accurate sensors.

- Further practical experiments need to be carried out to obtain other useful characteristics or behaviours of the active suspension.
- The suspension system can be further tested taking into account half-car or full-car models.
- A fast active hydraulic actuator system can be considered in place of the penumatic counterpart.

REFERENCES

- Alleyne, A. and Hedrick, J.K. (1995). Nonlinear adaptive control of active suspension, *IEEE Trans. on Control System Technology*, vol. 3(1): 94-101.
- Alleyne, A.; Liu, R.; Wright, H. (1998). On the limitations of force tracking control for hydraulic active suspensions, *Proceedings of the American Control Conference*, Volume 1, 24-26 June, 43 – 47.
- Appleyard, M.; Wellstead, P.E. (1995). Active suspension: some background, *IEE Proceedings of Control Theory Application*, vol. 142, no. 2, 123-128
- Astrom, K.J. and Haggglund, T. (1984). Automatic tuning of simple regulators with specification on phase and amplitude margin, *Automatica*, vol. 20, 645–651.
- Babuška, R. (2002). Neuro-fuzzy methods for modelling and identification, Abraham, A.; Jain, L.C.; Kacprzyk, J. (Editors), *Recent Advances in Intelligent Paradigms and Applications*, Springer-Verlag, Heidelberg, 161–186.
- Baladi, P. Hornik K. (1989). Neural networks and principal component analysis: learning from examples and local minima, *Neural Networks*, 2, 53-58.
- Barr, A.J.; Ray, J.I (1996). Control of an active suspension using fuzzy logic, *Proceedings of the Fifth IEEE International Conference on Fuzzy Systems*, Vol. 1, Pages:42 - 48 vol.1, 8-11.
- Billings, S.A., Jamaluddin, H.B., Chen, S. (1992). Properties of neural network with applications to modelling non-linear dynamic systems, *Int. Journal of Control*, vol. 55, no. 1, 193-224.
- Buckner, G.D., Schuetze, K.T., Beno, J.H. (2000). Active Vehicle Suspension Control Using Intelligent Feedback Linearization, *Proc. of the American Control Conference*, Chicago, Illinois.

- Campos, J., Lewis, F.L., Davis, L., Ikenaga, S. (2000). Backstepping Based Fuzzy Control of Active Vehicle Suspension Systems, *American Control Conference, 2000*. Proceedings of the 2000, Volume: 6, 28-30.
- Chantranuwathana, S. and Peng, H. (1999). Force tracking control for active suspensions - theory and experiments, *Proceedings of the IEEE International Conference on Control Applications, 22-27 August, Hawaii, USA*, vol. 1: 442-447.
- Chantranuwathana, S.; Peng, H. (2004). Adaptive Robust Force Control for Vehicle Active Suspensions, *International Journal of Adaptive Control and Signal Processing*, 2004, 18:83-102.
- Chen, H.Y.; Huang, H.J. (2005). Adaptive sliding controller for active suspension system, *International Conference on Control and Automation*, Volume 1, 26-29 June, 282 – 287.
- Cherry, A.S.; Jones, R.P. (1995). Fuzzy logic control of an automotive suspension system, *IEE Proceedings of Control Theory Application*, vol. 142, no. 2, 149-160
- D'Amato, F.J.; Viassolo, D.E. (2000). Fuzzy control for active suspensions, *Mechatronics*, Vol.10, 897-920.
- Fu, L.J., Cao, J.G., Liao, C.R. and Chen, B. (2005) 'Study on Neural Networks Control Algorithms for Automotive Adaptive Suspension Systems', *International Conference on Neural Networks and Brain 2005*, vol. 3: 1795-1799.
- Gross, D.C. and Rattan, K.S. (1998). An adaptive multilayer neural network for trajectory tracking control of a pneumatic cylinder, *IEEE International Conference on Systems, Man, and Cybernetics 1998*, 11-14 October, vol. 2: 1662 – 1667.
- Guo, Q.J., Yu, H.B., Xu, A.D. (2006). A hybrid PSO-GD based intelligent method for machine diagnosis, *Digital Signal Processing*, vol. 5, p. 1-17.
- Hagan, M.T. and Menhaj, M.B. (1994). Training feedforward networks with the Marquardt algorithm, *IEEE Transactions on Neural Network*, vol. 5(6): 989-993.
- Hamiti, K., Voda-Besanqon, A. and Roux-Buisson, H. (1996). Position control of a pneumatic actuator under the influence of stiction, *Control Engineering Practice*, vol. 4(8): 1079-1088.

- Hewit, J.R. and Burdess, J.R. (1986). An active method for the control of mechanical systems in the presence of unmeasurable forcing, *Trans. Mechanism and machine Theory*, 21(3): 393-400.
- Hewit, J.R. and Marouf, K.B. (1996). Practical control enhancement via mechatronics design, *IEEE Transactions on Industrial Electronics*, vol. 43(1): 16-22.
- Hewit, J.R.; Moris, J.R. (1999). Disturbance observer control with estimation of the inertia matrix, *Proceedings of IEEE/ASME International Conference on Advanced Intelligent Mechatronics*, 753-757.
- Huang, S.J. and Lin, W.C. (2003). A self organizing fuzzy controller for an active suspension system, *Journal of Vibration and Control*, vol. 9(9): 1023-1040.
- Hudha, K., Jamaluddin, H., Samin, P.M., Rahman, R.A. (2003). Active Roll Control Suspension System (ARCS) Using Active Force Control Strategy on A New Modified Half Car Model. *Procs. of SAE*.
- Hussein, S.B., Jamaluddin, H., Mailah M. and Zalzal, A. (2000). A hybrid intelligent active force controller for robot arm using evolutionary neural networks, *Proc. Int. Conf. on Evolutionary Computation (CEC 2000)*, San Diego, USA, 117-124.
- Hussein, S.B., Zalzal, A.M.S.; Jamaluddin, H.; Mailah, M. (2000). An evolutionary neural network controller for intelligent active force control, *Evolutionary Design and Manufacture*, Parmee, I.C. (Editor), Springer Verlag, London, 352-362.
- Ikenaga, S.A. (2000). Development of a real time digital controller: application to active suspension control of ground vehicle, University of Texas at Arlington, *Ph.D. Thesis*.
- Ikenaga, S.A., Lewis, F.L., Davis, L., Kampos, J., Evans, M. and Scully, S. (1999). Active suspension control using a novel strut and active filtered feedback: design and implementation, *Proc. of IEEE International Conference on Control Applications*, Hawaii, USA: 1502-1508.
- Jha, R., Rower, J. (2002). Experimental investigation of active vibration control using neural networks and piezoelectric actuators, *Smart Materials and Structures*, 11, 115-121.

- Joo, D.S.; Al-Holou, N.; Weaver, J.M.; Lahdhiri, T.; Al-Abbas, F. (2000). Nonlinear modeling of vehicle suspension system, *Proceedings of the American Control Conference*, Volume 1, Issue 6, 28-30 June, 115 -119.
- Joo, Dae-Sung, Al-Holou, N., Weaver, J.M., Lahdhiri, T., Al-Abbas, F. (2000). Nonlinear modelling of vehicle suspension system, *Proc. of the 2000 American Control Conference*, Vol. 1, Issue 6, 28-30.
- Kennedy, J., Eberhart, R.C. (1995). Particle Swarm Optimisation, *Proc. IEEE International Conference on Neural Networks*, IV, 1942-1948.
- Kwek, L.C., Wong, E.K., Loo, C.K. and Rao, M.V.C. (2003). Application of Active Force Control and Iterative Learning in a 5-Link Biped Robot, *Journal of Intelligent and Robotic Systems*, vol. 37: 143–162.
- Lin, J.S. and Kenellakopoulos, I. (1997). Nonlinear design of active suspensions, *Control Systems Magazine*, vol. 17(3): 45-59.
- Lu, W.Z., Fan, H.Y., Leung, A.Y. T., Wong, J.C.K. (2002). Analysis of pollutant levels in central Hong Kong applying neural network method with particle swarm optimization, *Environmental Monitoring and Assessment*, 79, 217–230.
- Mailah, M. (1998). *Intelligent Active Force Control of A Rigid Robot Arm Using Neural Network and Iterative Learning Algorithms*, Ph.D Thesis, University of Dundee, UK.
- Mailah, M., Pitowarno, E. and Jamaluddin, H. (2005). Robust motion control for mobile manipulator using resolved acceleration and proportional-integral active force control, *International Journal of Advanced Robotic Systems*, vol. 2(2): 125-134.
- Mailah, M., Rahim, N.I.A. (2000). Intelligent active force control of a robot arm using fuzzy logic, *Proceedings of IEEE International Conference on Intelligent Systems and Technologies TENCON 2000*, 291-296.
- Miller, L.R. (1988) ‘Tuning passive, semi active, and fully active suspension’, *Proceedings of the 27th Conference on Decision and Control*, Austin, Texas, 7-9 December, vol. 3: 2047-2053.
- Mock, J. R.; Weeks, D. A.; Beno, J. H.; Nichols, S. P.; Bresie D. A.; Guenin, A. M. (2002). Dual Purpose Fuzzy Logic Controller for an Active Suspension System, *SAE 2002 World Congress*, Detroit, Michigan, March 4-7, 2002.

- Narendra, K.S. (1996). Neural networks for control: theory and practice, *Proc. IEEE* 84, 1385–406.
- Negnevitsky, M. (2005). *Artificial Intelligence: A Guide to Intelligent Systems*, 2nd, Addison Wesley.
- Nguyen, T.T.; Bui, T.H.; Tran, T.P.; Kim, S.B. (2001). A hybrid control of active suspension system using H^∞ and nonlinear adaptive controls, *Proceedings of ISEI 2001*, Volume 2, 12-16 June 2001, 839 – 844.
- Omar, Z. (2002). Modelling and Simulation of an Active Suspension System Using Active Force Control Strategy, MSc Report, Universiti Teknologi Malaysia.
- Parsopoulos, K.E., Vrahatis, M.N. (2002). Recent approaches to global optimization problems through Particle Swarm Optimization, *Natural Computing*, 1, 235–306.
- Rao, M.V.C., Prahlad, V. (1997). A Tunable Fuzzy Logic Controller for Vehicle Active Suspension Systems, *Fuzzy Set and System*.
- Richer, E. and Hurmuzlu, Y. (2000). A High Performance Pneumatic Force Actuator System: Part I - Nonlinear Mathematical Model, *Transactions of the ASME*, vol. 122: 416-425.
- Sam, Y.M. (2004). *Modelling and Control of Hydraulically Actuated Active Suspension Systems*, PhD Thesis, Universiti Teknologi Malaysia.
- Sun, J.; Yang, Q. (2005). Self-adjustment fuzzy control of automobile active suspension, *Proceedings IEEE Intelligent Vehicles Symposium*, 6-8 June 2005, 354 – 357.
- Taghirad, H.D.; Esmailzadeh, E. (1998). Automobile passenger comfort assured through LQG/LQR active suspension, *Journal of Vibration and Control*, Incorporating Modal Analysis, 4(5), 603 – 618.
- Valásek, M. and Kortüm, W. (2006). *Mechanical Systems Design Handbook: Modeling, Measurement, and Control*, Taylor and Francis Group, LLC.
- Van den Bergh, F. (1999). Particle Swarm weight initialization in multi-layer perceptron artificial neural networks, *ICAI*, Durban, South Africa.
- Wang, L-X. (1994). *Adaptive Fuzzy Systems and Control*, Prentice Hall, Englewood Cliffs, NJ.
- Wilamowski, B.M. (2003). Neural network architectures and learning, *IEEE International Conference on Industrial Technology*, Vol. 1, 10-12.

- Wilamowski, B.M., Chen, Y. and Malinowski, A. (1999). Efficient algorithm for training neural networks with one hidden layer, *Proceedings of International Joint Conference on Neural Networks*, vol. 3: 1725-1728.
- Wilamowski, B.M., Iplikci, S., Kaynak, O. and Efe, M.O. (2001). An Algorithm for Fast Convergence in Training Neural Networks, *Proceedings International Joint Conference on Neural Networks*, vol. 3: 1778-1782.
- Yim, Y.U, Oh, S.Y. (2004). Modelling of Vehicle Dynamics From Real Vehicle Measurements Using a Neural Network With Two-Stage Hybrid Learning for Accurate Long-Term Prediction, *IEEE Trans. on Vehicular Technology*, Vol. 53, No. 4.
- Yoshimura T. and Takagi A. (2004). Pneumatic active suspension system for a one-wheel car model using fuzzy reasoning and a disturbance observer, *Journal of Zhejiang University SCIENCE*, vol. 5(9): 1060-1068.
- Yoshimura, T., Kume, A., Kurimoto, M. and Hino, J. (2001). Construction of an active suspension system of a quarter car model using the concept of sliding mode control, *Journal of Sound and Vibration*, 239(2): 187-199.

LIST OF APPENDICES

APPENDIX	TITLE	PAGE
A	Results	83
B	Photographs of Rig	92
C	List of Publications	96
D	Achievements / Outputs	98

APPENDIX A

RESULTS

A. Results of of PID-AFC Scheme (Simulation)

Set point = 5 P=35

I=1.299

D=250

IN=50

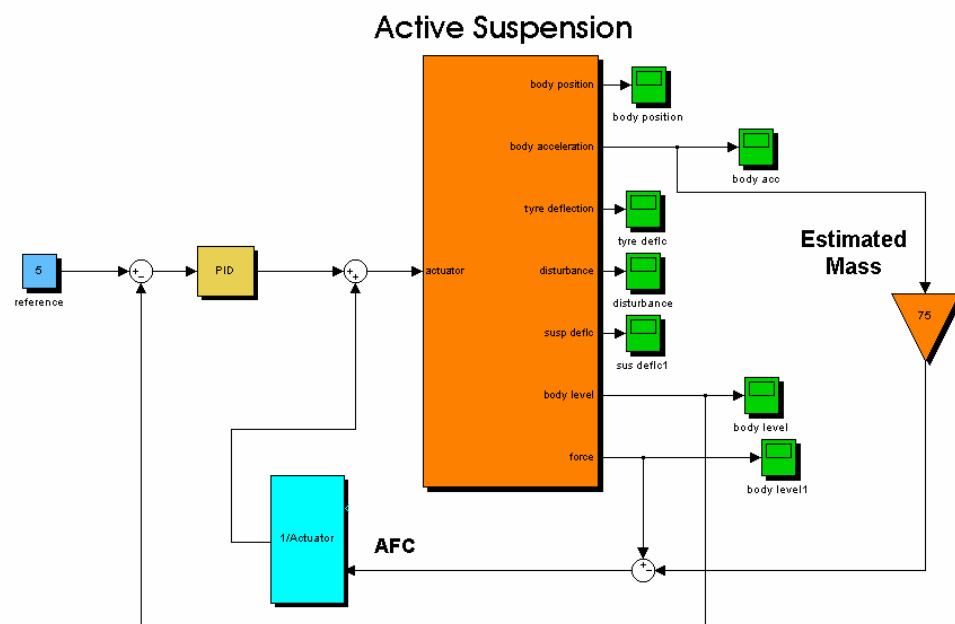

Simulink block diagram of the proposed PID-AFC scheme

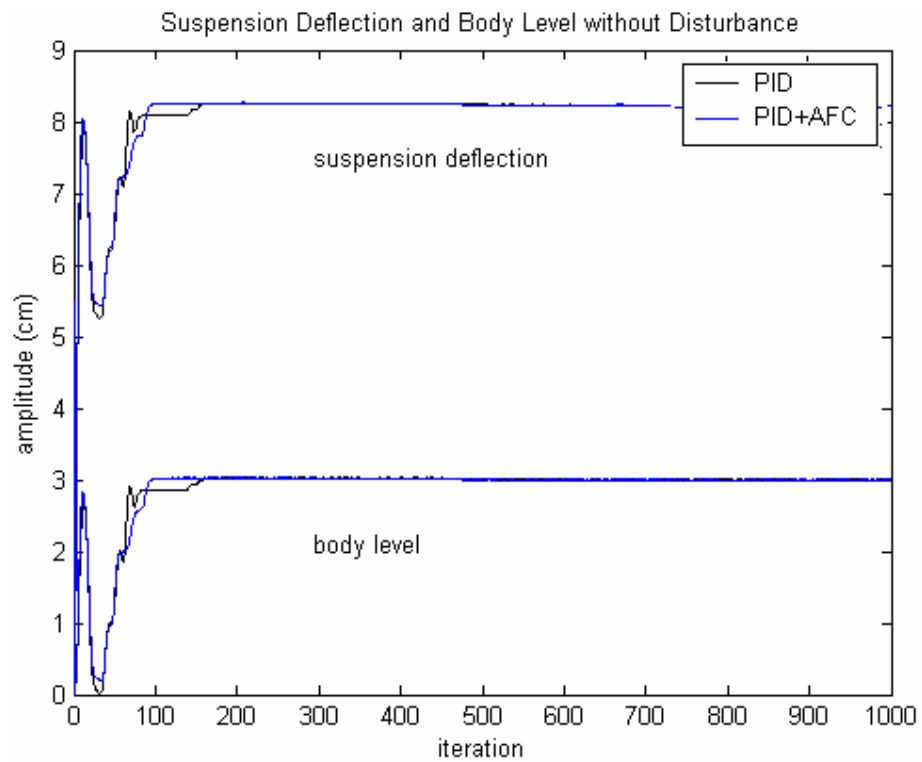

Suspension deflection without disturbance

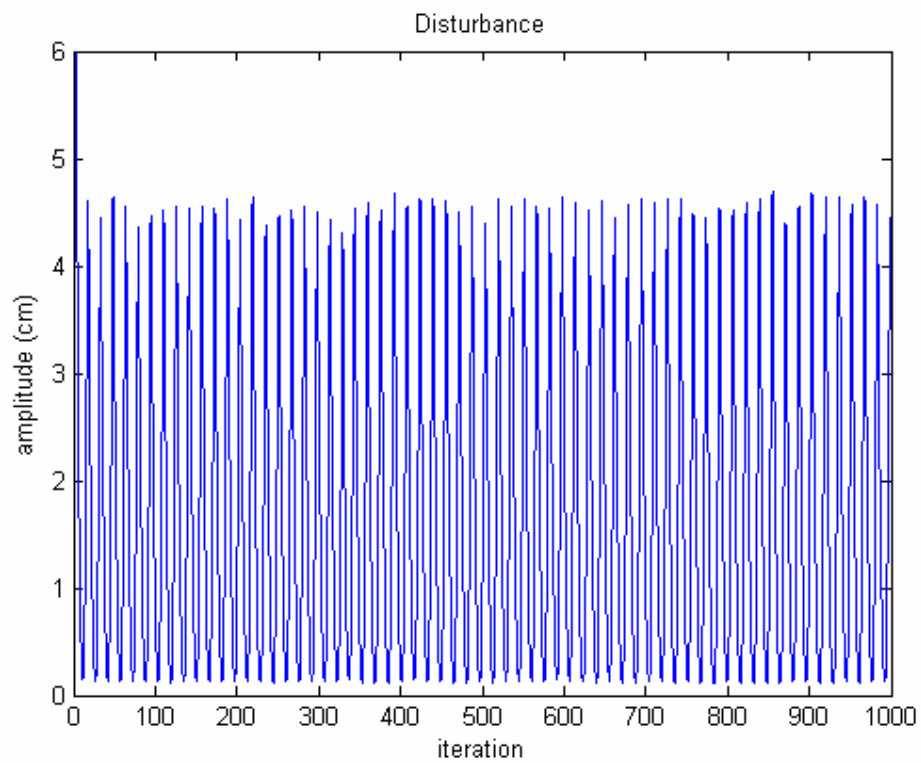

Graph of amplitude versus iteration

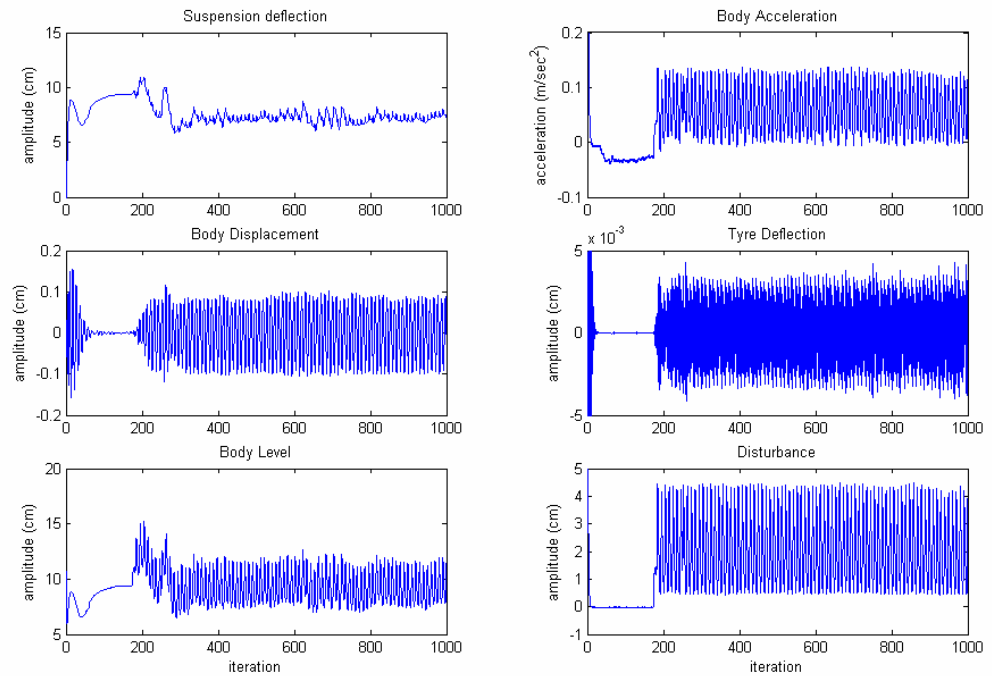

Results for PID only scheme

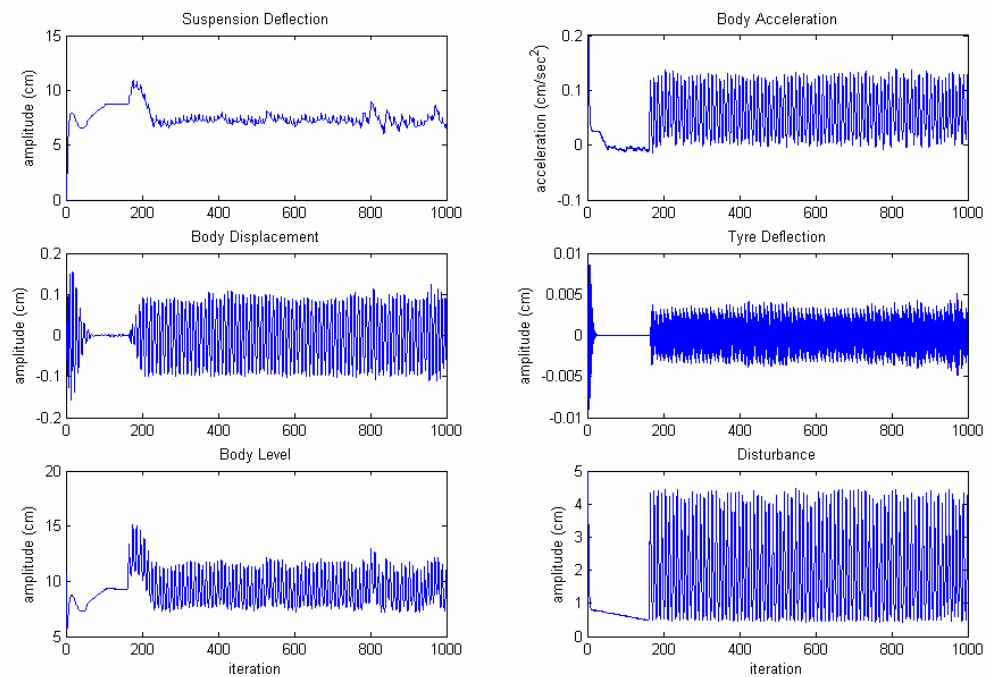

Results for PID-AFC Scheme

B. Results of the Experimental Study (Preliminary)

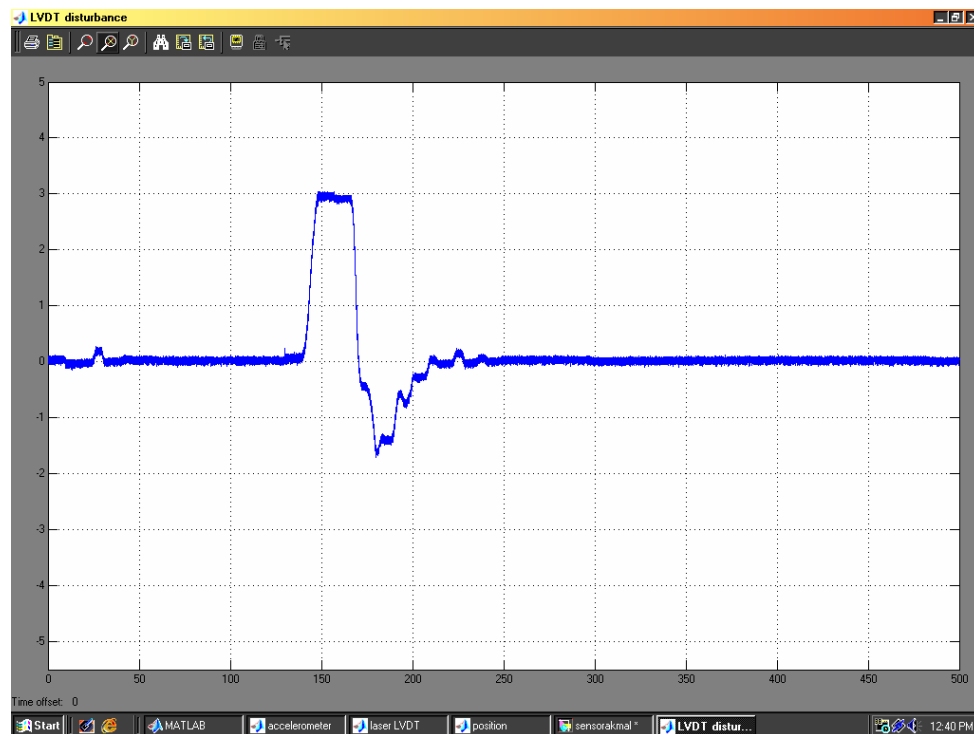

PID scheme (P=7 I=13 D=50)



PID scheme (P=7 I=13 D=55)

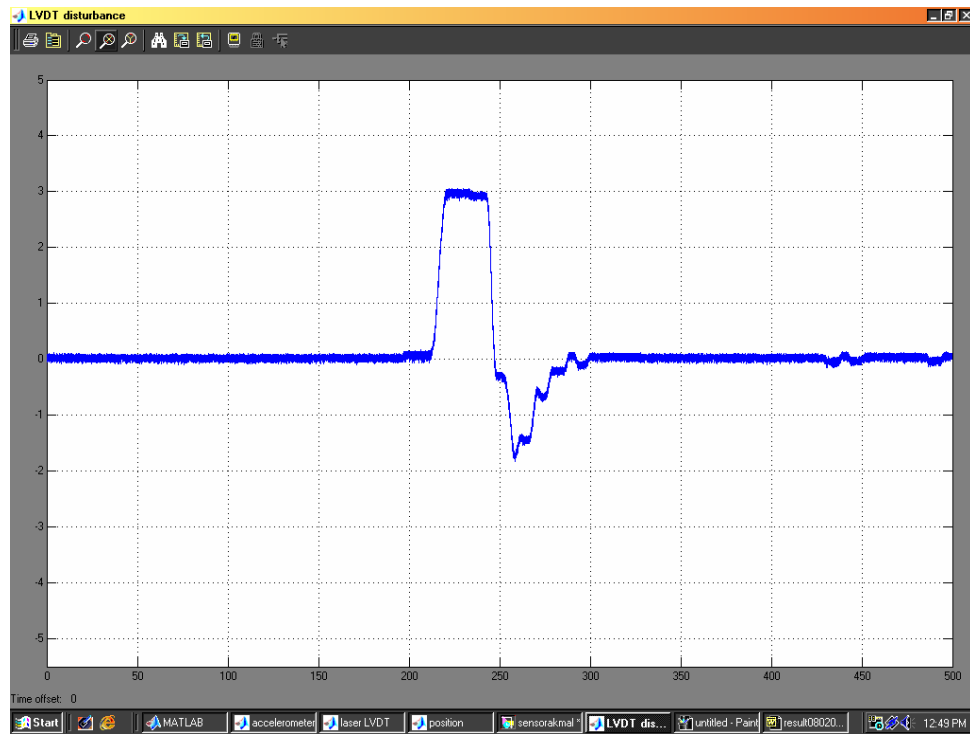

PID scheme (P=7 I=13 D=48)

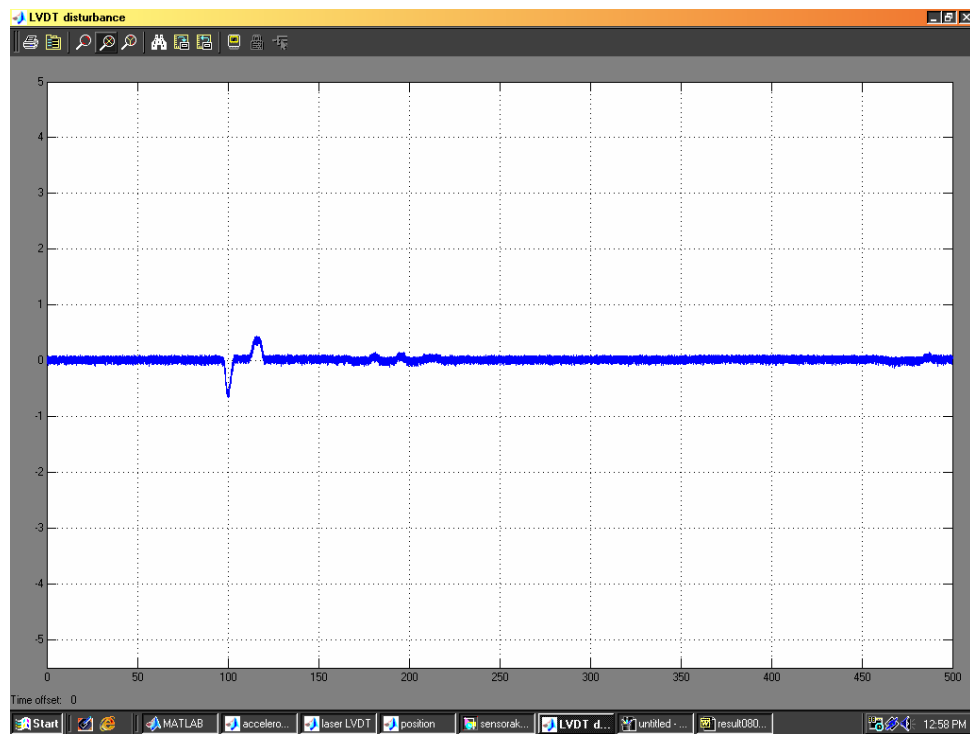

PID scheme (P=7 I=13 D=48) with disturbance

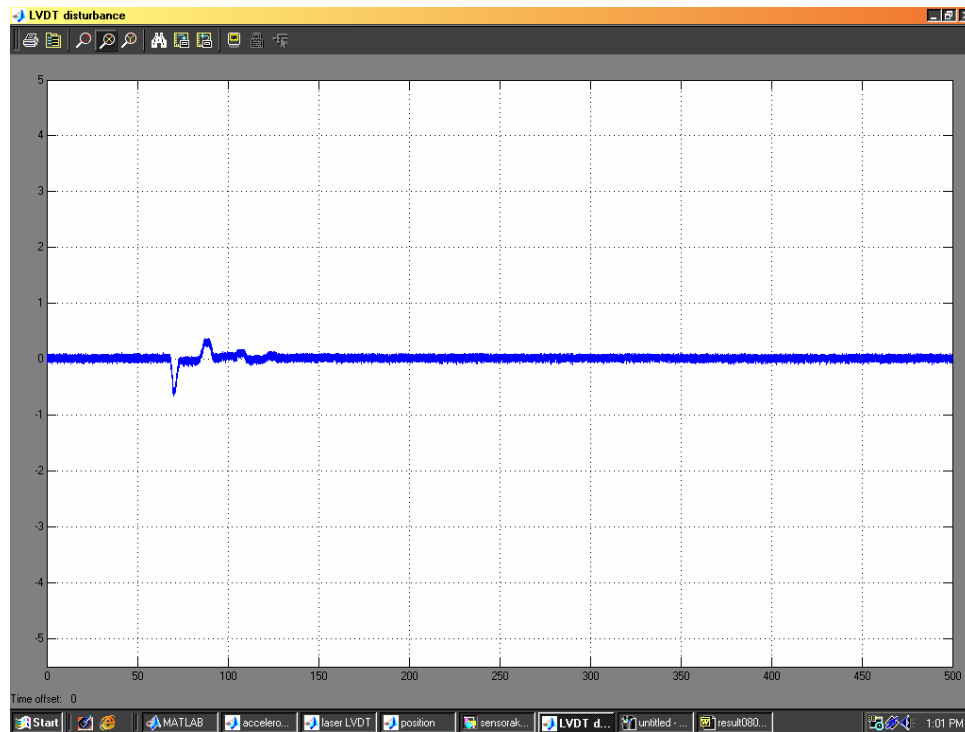

PID scheme ($P=7$ $I=13$ $D=50$) with disturbance



PID scheme ($P=7$ $I=13$ $D=48$) with changed *set value* from 0 to -1

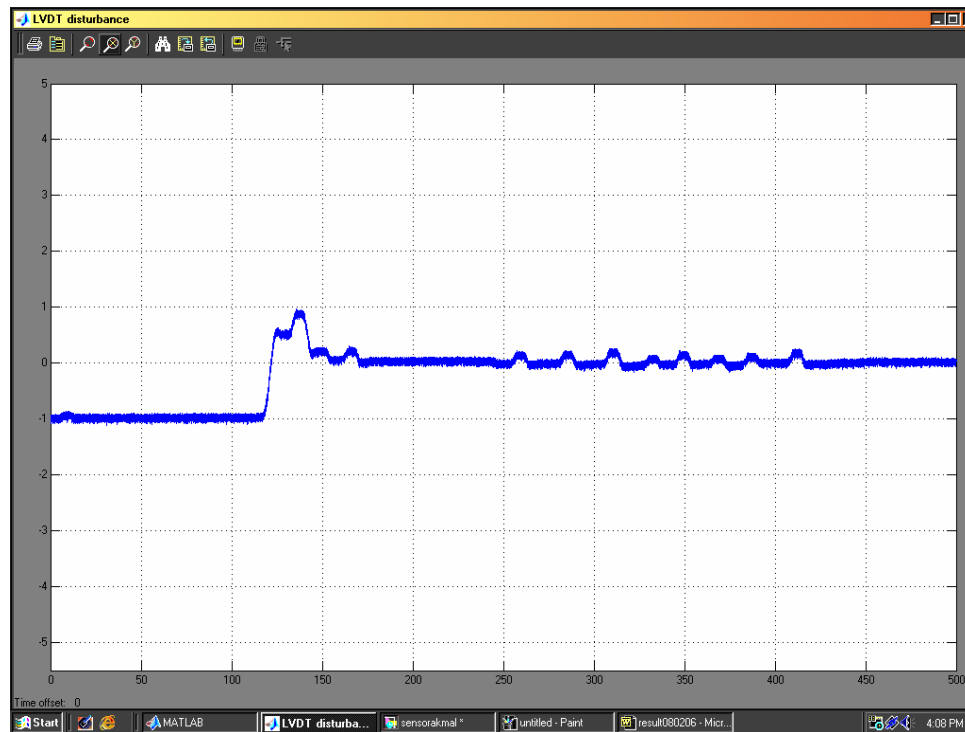

PID scheme ($P=7$ $I=13$ $D=48$) with changed *set value* from -1 to 0

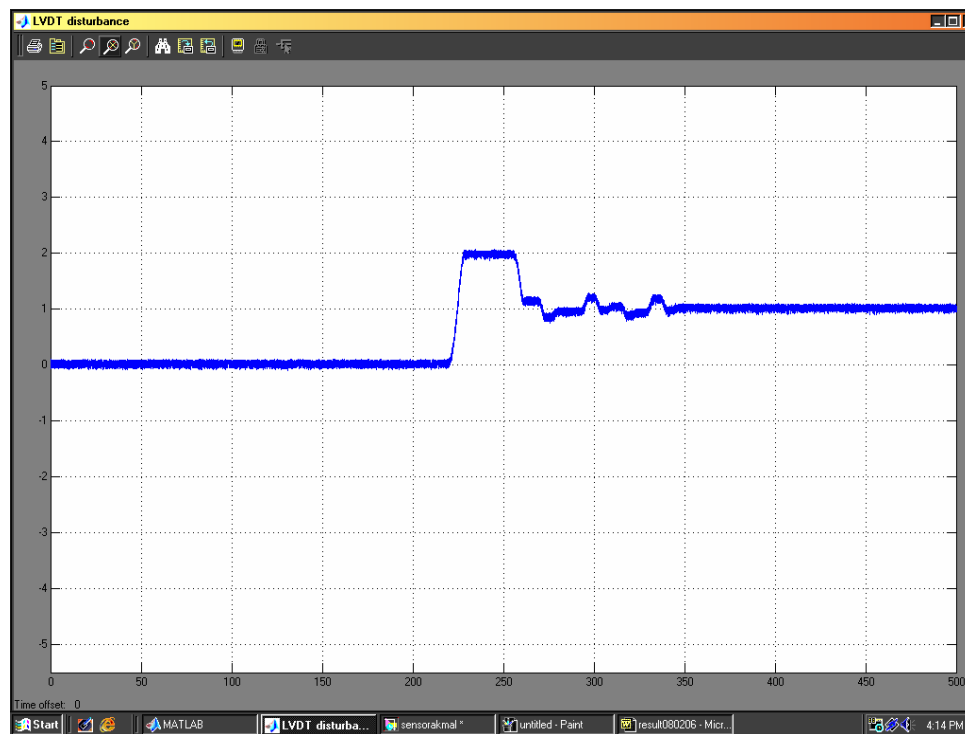

PID scheme ($P=7$ $I=13$ $D=48$) with changed *set value* from 0 to 1

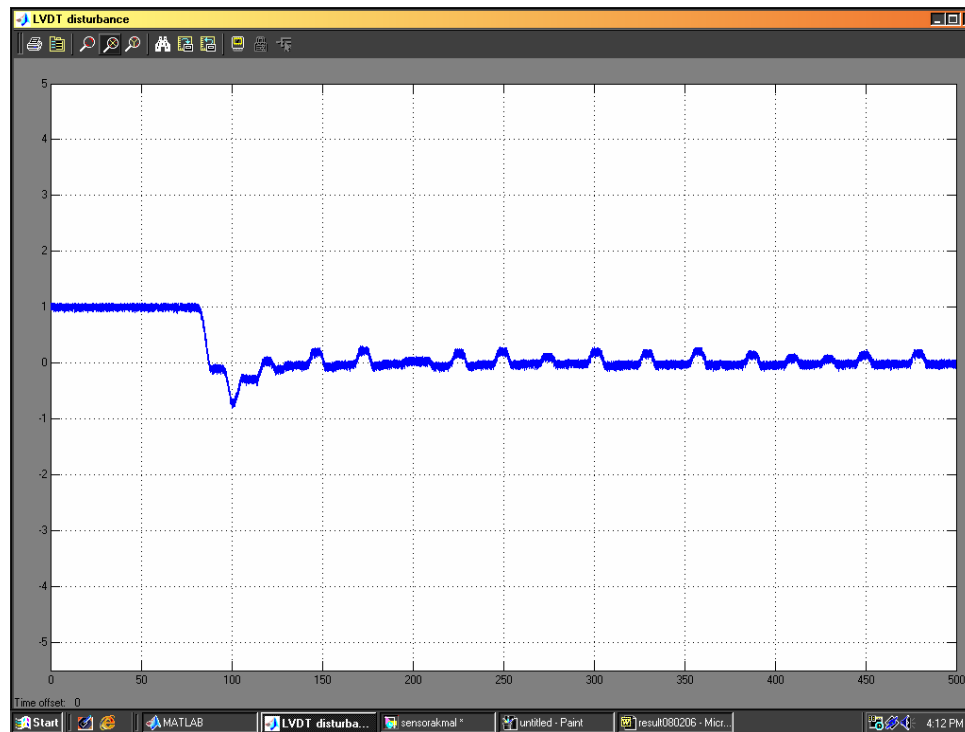

PID scheme ($P=7$ $I=13$ $D=48$) with changed *set value* from 1 to 0

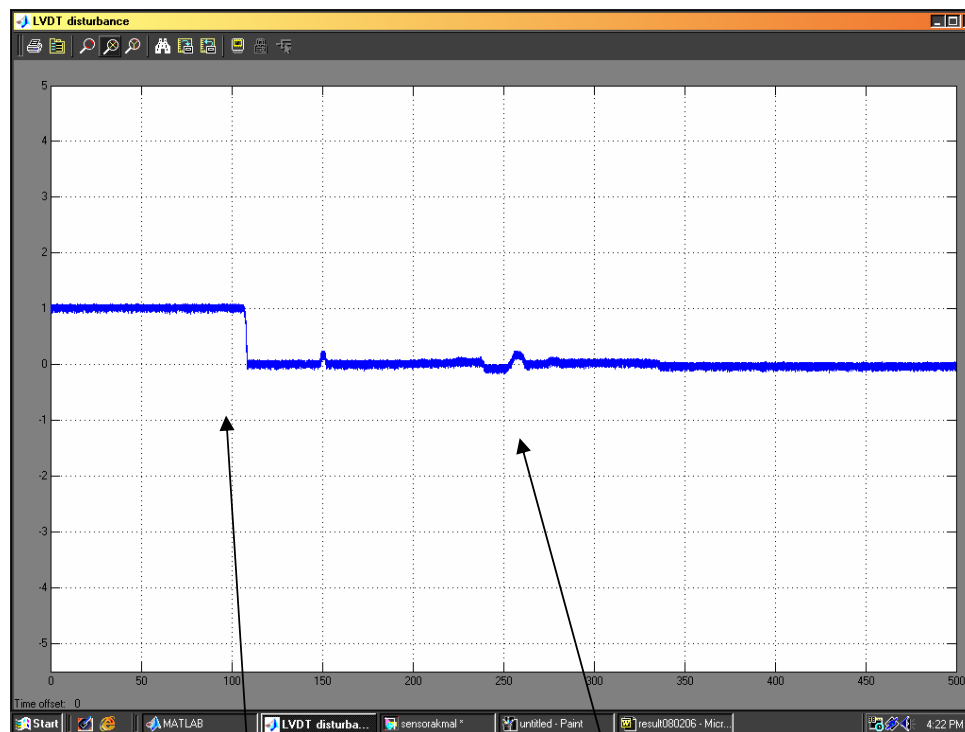

Change *set value* from 1 to 0

Apply 20kg additional mass

PID scheme ($P=7$ $I=13$ $D=48$)

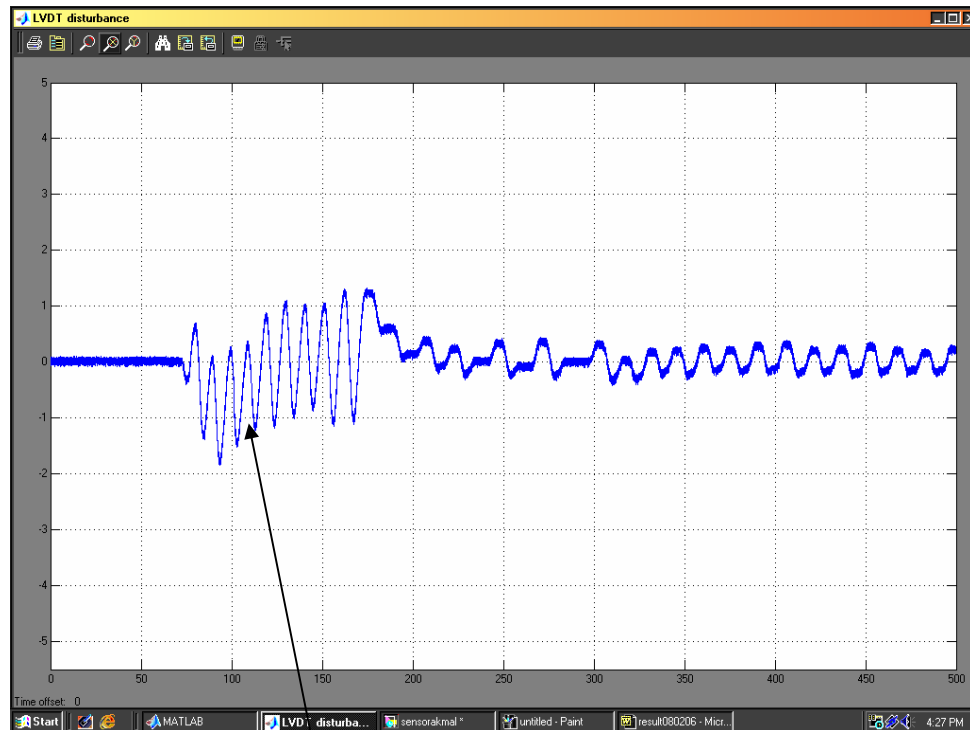

Apply continous disturbance

PID scheme (P=7 I=13 D=48)

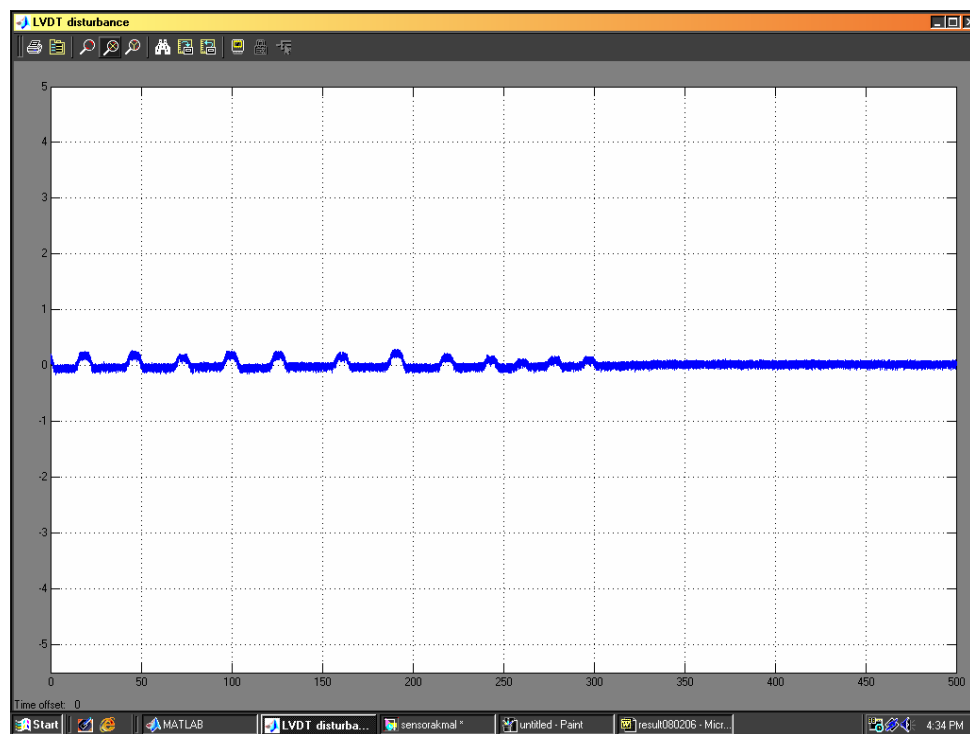

*continue from previous graph

APPENDIX B

PHOTOGRAPHS OF RIG

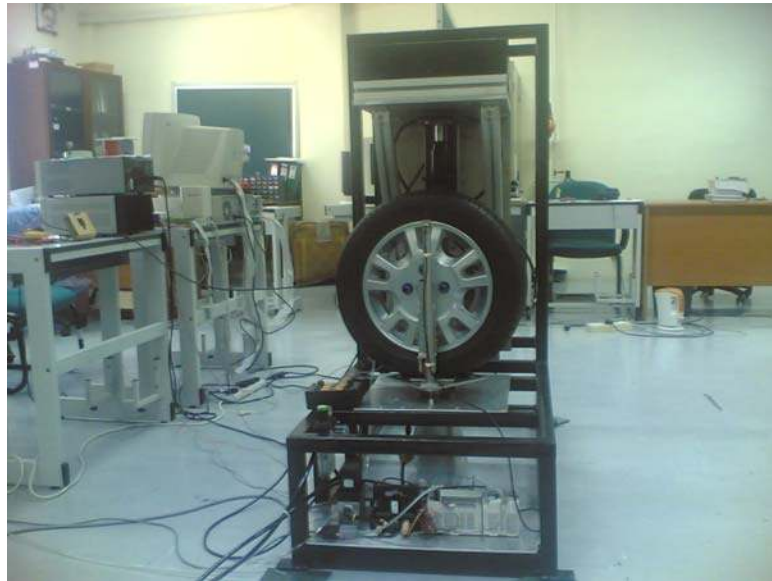

Frontal view



Side view



Top part of rig

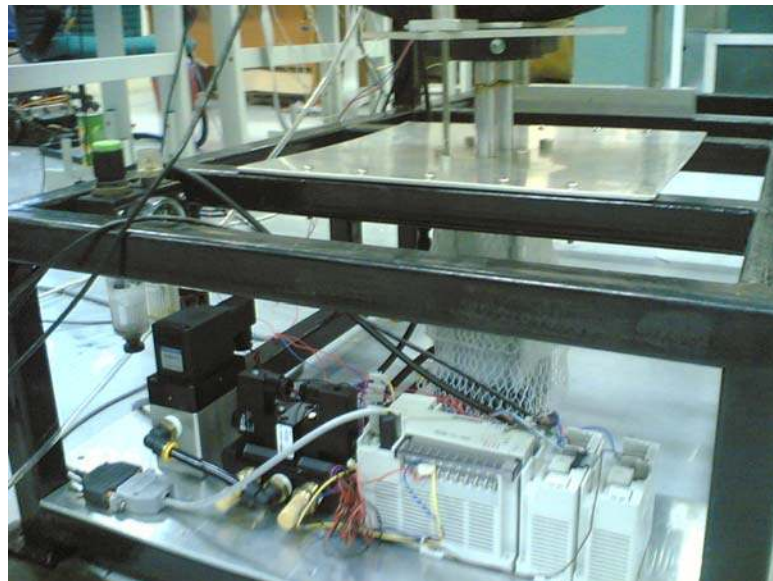

Disturbance model (road profile generator)



Sensors installation (laser sensor and LVDT)

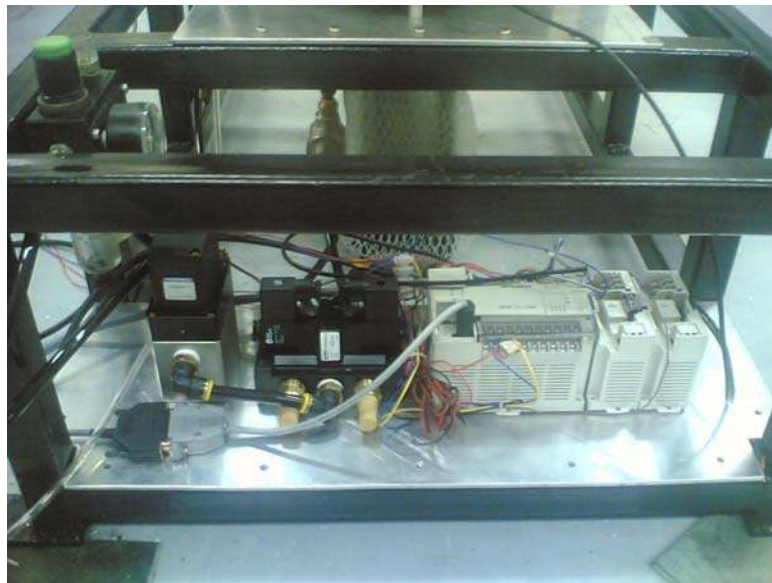

Front view of the PLC-based road profile generator (disturbance)



Pneumatic control valve



Accelerometer used in the rig

APPENDIX C

LIST OF PUBLICATIONS

1. Gigih Priyandoko, Musa Mailah, '*Control Design of A Quarter Car Suspension System using Fuzzy Logic Active Force Control*', Procs. of ICOM05, KL, May 2005.
2. Gigih Priyandoko, Musa Mailah, '*Control Design of A Quarter Car Suspension System Using Iterative Fuzzy Logic Active Force Control*', Procs of SITIA05, Surabaya, May 2005.
3. Gigih Priyandoko, Musa Mailah, '*Fuzzy Logic Artificial Neural Network Active Force Control for an Active Suspension of a Quarter Car*', Procs. of ROVISP05, USM Penang, July 2005.
4. Md Zarhamdy M Zain, Gigih Priyandoko, Musa Mailah, '*Hybrid Control Scheme Incorporating AFC and Input Shaping Technique For A Suspension System*', Procs. of SITIA07, Surabaya, May 2007.
5. Gigih Priyandoko, Musa Mailah, Hishamuddin Jamaluddin, '*Particle Swarm Optimization Neural Network Based Modelling of Vehicle Suspension System*', Procs. of Regional Postgraduate Conference on Engineering and Science 2006 (RPCES 2006), June 2006.
6. Gigih Priyandoko, Musa Mailah, '*Adaptive Fuzzy Active Force Control Applied to A Quarter Car Suspension System*', International Journal of Simulation Modelling, Vol. 6, No. 1, March 2007, pp 25-36.
7. Gigih Priyandoko, Musa Mailah & Hishamuddin Jamaluddin, Vehicle Active Suspension System Using Skyhook Adaptive Neuro Active Force Control, to be submitted to *Mechatronics* (an International Journal), April 2007.
8. Md Zarhamdy M Zain, Gigih Priyandoko, Musa Mailah, S.Z. Hashim, M.O. Tokhi and M.S. Alam, '*Estimation Parameters of Hybrid Control Schemes*

For Suspension System: A MOGA Approach', accepted for presentation at CIM07, 28-29 May 2007.

9. Gigih Priyandoko, **Musa Mailah**, Hishamuddin Jamaluddin, '*Skyhook Adaptive Neuro Active Force Control for An Active Suspension System*', accepted for presentation at CIM07, May 2007.

APPENDIX D

ACHIEVEMENTS / OUTPUTS

A. INTERNATIONAL JOURNAL:

1. Gigih Priyandoko, Musa Mailah, '*Adaptive Fuzzy Active Force Control Applied to A Quarter Car Suspension System*', International Journal of Simulation Modelling, Vol. 6, No. 1, March 2007, pp 25-36
2. Gigih Priyandoko, Musa Mailah & Hishamuddin Jamaluddin, Vehicle Active Suspension System Using Skyhook Adaptive Neuro Active Force Control, to be submitted to *Mechatronics* (an International Journal), April 2007.

B. INTERNATIONAL CONFERENCE:

1. Gigih Priyandoko, Musa Mailah, '*Control Design of A Quarter Car Suspension System using Fuzzy Logic Active Force Control*', Procs. of ICOM05, KL, May 2005.
2. Gigih Priyandoko, Musa Mailah, '*Control Design of A Quarter Car Suspension System Using Iterative Fuzzy Logic Active Force Control*', Procs of SITIA05, Surabaya, May 2005.
3. Gigih Priyandoko, Musa Mailah, '*Fuzzy Logic Artificial Neural Network Active Force Control for an Active Suspension of a Quarter Car*', Procs. of ROVISP05, USM Penang, July 2005.
4. Md Zarhamdy M Zain, Gigih Priyandoko, Musa Mailah, '*Hybrid Control Scheme Incorporating AFC and Input Shaping Technique For A Suspension System*', Procs. of SITIA07, Surabaya, May 2007.
5. Gigih Priyandoko, Musa Mailah, Hishamuddin Jamaluddin, '*Particle Swarm Optimization Neural Network Based Modelling of Vehicle Suspension*

System', Procs. of Regional Postgraduate Conference on Engineering and Science 2006 (RPCES 2006), June 2006.

6. Md Zarhamdy M Zain, Gigih Priyandoko, Musa Mailah, S.Z. Hashim, M.O. Tokhi and M.S. Alam, '*Estimation Parameters of Hybrid Control Schemes For Suspension System: A MOGA Approach*', accepted for presentation at CIM07, 28-29 May 2007.
7. Gigih Priyandoko, Musa Mailah, Hishamuddin Jamaluddin, '*Skyhook Adaptive Neuro Active Force Control for An Active Suspension System*', accepted for presentation at CIM07, May 2007.

C. PHD STUDENT:

1. Gigih Priyandoko, '*Intelligent Active Force Control of A Vehicle Suspension System*', June 2003-present.

D MENG STUDENT:

1. Mohd Rizal Ahmad @ Manap, '*Simulation and Experimental Analysis of An Active Vehicle Suspension System*', December 2006-present.