

Search for heavy neutrinos and third-generation leptoquarks in hadronic states of two τ leptons and two jets in proton-proton collisions at $\sqrt{s} = 13$ TeV



The CMS collaboration

E-mail: cms-publication-committee-chair@cern.ch

ABSTRACT: A search for new particles has been conducted using events with two high transverse momentum τ leptons that decay hadronically and at least two energetic jets. The analysis is performed using data from proton-proton collisions at $\sqrt{s} = 13$ TeV, collected by the CMS experiment at the LHC in 2016 and corresponding to an integrated luminosity of 35.9 fb^{-1} . The observed data are consistent with standard model expectations. The results are interpreted in the context of two physics models. The first model involves right-handed charged bosons, W_R , that decay to heavy right-handed Majorana neutrinos, N_ℓ ($\ell = e, \mu, \tau$), arising in a left-right symmetric extension of the standard model. The model considers that N_e and N_μ are too heavy to be detected at the LHC. Assuming that the N_τ mass is half of the W_R mass, masses of the W_R boson below 3.50 TeV are excluded at 95% confidence level. Exclusion limits are also presented considering different scenarios for the mass ratio between N_τ and W_R , as a function of W_R mass. In the second model, pair production of third-generation scalar leptoquarks that decay into $\tau\tau b\bar{b}$ is considered, resulting in an observed exclusion region with leptoquark masses below 1.02 TeV, assuming a 100% branching fraction for the leptoquark decay to a τ lepton and a bottom quark. These results represent the most stringent limits to date on these models.

KEYWORDS: Beyond Standard Model, Dark matter, Hadron-Hadron scattering (experiments)

ARXIV EPRINT: [1811.00806](https://arxiv.org/abs/1811.00806)

Contents

1	Introduction	1
2	The CMS detector	4
3	Event reconstruction and particle identification	4
4	Signal and background samples	6
5	Event selection	7
6	Background estimation	8
7	Systematic uncertainties	10
8	Results	12
9	Summary	13
	The CMS collaboration	22

1 Introduction

Despite its undeniable success, the standard model (SM) fails to answer some of the most fundamental questions in particle physics. Among these are the source of matter-antimatter asymmetry, the particle nature of dark matter, the origin of dark energy, and the acquisition of neutrino mass. The aim of this paper is to present a search for physics beyond the standard model in final states containing two hadronically decaying τ leptons (τ_h) and two high transverse momentum (p_T) jets. The analysis is performed using data from proton-proton (pp) collisions at $\sqrt{s} = 13$ TeV, collected by the CMS experiment at the CERN LHC and corresponding to an integrated luminosity of 35.9 fb^{-1} . To illustrate the sensitivity of this search for processes not included in the SM, two benchmark physics scenarios are considered for the interpretation of the results: the production of heavy, right-handed Majorana neutrinos and the production of third-generation leptoquarks (LQs). A description of the two models is given below.

The observation of neutrino oscillations implies nonzero neutrino masses, prompting a corresponding extension of the SM. Results from neutrino oscillation experiments together with cosmological constraints imply very small values for these masses [1–4]. The most popular explanation for very small neutrino masses is the “seesaw” mechanism [5–7] in which the observed left-handed chiral states are paired with very heavy right-handed partners. This mechanism can be realized in the left-right symmetric model (LRSM) [2–4],

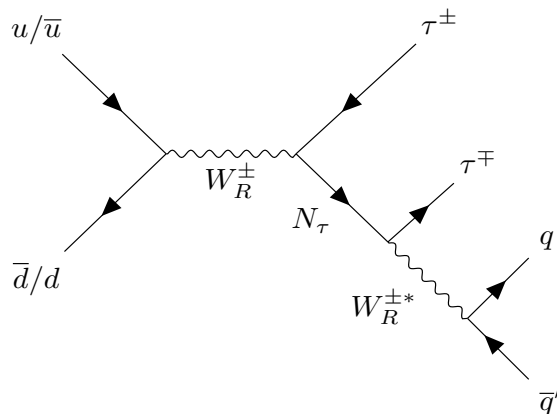

Figure 1. Leading order Feynman diagram for the production of a right-handed W_R that decays to a heavy neutrino N_τ , with a final state of two τ leptons and two jets.

in which the SM group $SU(2)_L$ has a right-handed counterpart, originally introduced to explain the nonconservation of parity in weak interactions. The $SU(2)_R$ group, similarly to $SU(2)_L$, predicts the existence of three new gauge bosons, W_R^\pm and Z' , and three heavy right-handed Majorana neutrino states N_ℓ ($\ell = e, \mu, \tau$), partners of the light neutrinos ν_ℓ . A reference process allowed by this model is the production of a right-handed W_R boson that decays to a heavy neutrino and a lepton of the same generation ($W_R \rightarrow \ell + N_\ell \rightarrow \ell + (\ell q \bar{q}')$) and gives rise to two jets and two leptons of the same flavor in the final state. Of particular interest for this analysis is the scenario in which the W_R decay chain results in a pair of high- p_T τ leptons, $W_R \rightarrow \tau + N_\tau \rightarrow \tau + (\tau q \bar{q}')$. Figure 1 shows the leading order (LO) Feynman diagram for the production of a N_τ .

A similar $\tau\tau jj$ final state can be realized in other extensions of the SM, such as grand unified theories [8–11], technicolor models [12–15], compositeness scenarios [16, 17], and R parity [18] violating supersymmetry [19–27]. These theories predict a new scalar or vector boson, referred to as a leptoquark in the literature, which carries nonzero lepton and baryon numbers, as well as color and fractional electric charge [9, 17]. In order to comply with experimental constraints on flavor changing neutral currents and other rare processes [28, 29], three types of LQs are generally considered, each coupled to the leptons and quarks of its generation. The LQs recently gained notable theoretical attention as one of the most suitable candidates to explain the $\bar{B} \rightarrow D^* \tau \nu$ and $b \rightarrow s \ell \ell$ anomalies reported by the BaBar [30, 31], Belle [32–35], and LHCb [36–40] Collaborations. In particular, models containing enhanced couplings to the third-generation SM particles are favored to interpret these results [41–44]. In this search, we consider pair-produced scalar LQs, each decaying to a τ lepton and a bottom quark (b). Figure 2 shows the LO Feynman diagrams for the pair-production of LQs.

The most recent heavy neutrino and LQ searches in $\ell\ell jj$ final states have been carried out by the ATLAS [45–47] and CMS [48–52] Collaborations. The most stringent limits in the $\tau\tau jj$ final states are set in ref. [50] and exclude W_R masses below 2.9 TeV, assuming that the mass of the right-handed neutrino is half of the mass of the W_R boson, and scalar

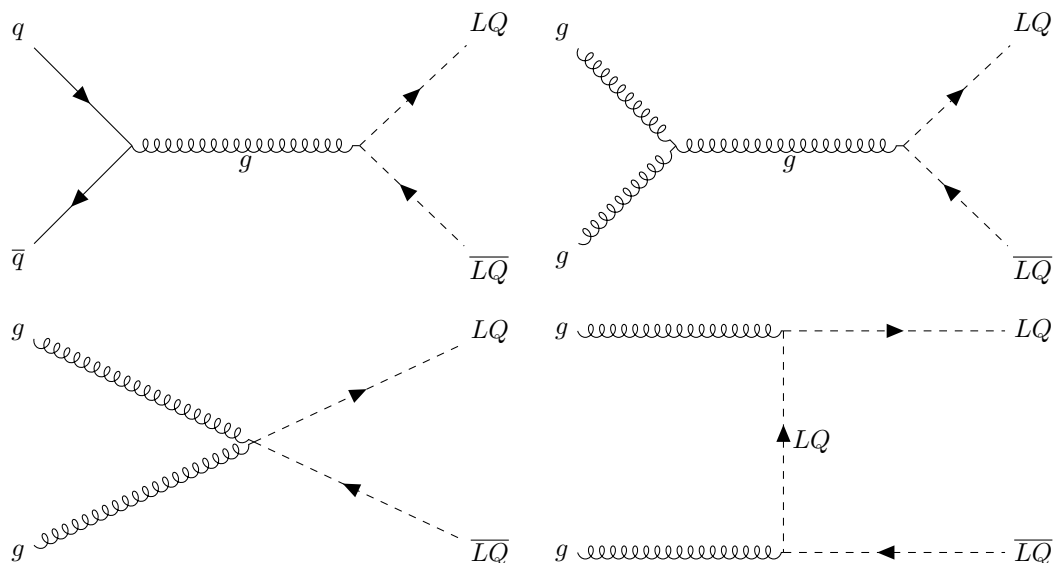

Figure 2. Leading order Feynman diagrams for the pair-production of LQs, leading to final states with two τ leptons and two b quarks.

LQ masses below 850 GeV, assuming that the LQ decays to a τ lepton and a bottom quark with 100% branching fraction. Moreover, searches for third-generation LQs have been performed in other final states: pairs of scalar LQs each of which decays to a τ lepton and a top quark [53], pairs of scalar and vector LQs each of which decays to a quark (top, bottom, or light-flavor) and a neutrino [54], and singly produced scalar LQs in association with a τ lepton with the LQ decaying to a τ lepton and a bottom quark [55]. In this analysis we focus on the $\tau\tau jj$ search channel in which both of the τ leptons decay hadronically. Hadronic τ lepton decays account for approximately 65% of all possible τ lepton final states, so that the pair branching fraction is 42%.

The paper is organized as follows. Section 2 gives a brief description of the CMS detector. The event reconstruction is described in section 3, followed by the description of the simulation of the signal and background samples in section 4. The selection criteria defining the signal region (SR), described in section 5, reduce the background contributions to achieve maximum discovery potential. A main challenge of this analysis is to achieve high and well-understood signal selection and trigger efficiencies, with small systematic uncertainty, with SM signatures containing genuine τ_h candidates. The strategy is described in section 6 and relies on the selection of $Z(\rightarrow \ell\ell)+\text{jets}$ events. A number of additional background-enriched regions are described in section 6. These regions are defined to minimize the systematic uncertainty of the background contributions as well as to cross-check the accuracy of the efficiency measurements. Relevant systematic uncertainties are described in section 7. The results are presented in section 8. The paper concludes with a summary in section 9.

2 The CMS detector

A detailed description of the CMS detector, together with a definition of the coordinate system used and the relevant kinematic variables, can be found in [56]. The central feature of the CMS apparatus is a superconducting solenoid of 6 m inner diameter, providing a field of 3.8 T. Within the field volume are the silicon pixel and strip tracker, the crystal electromagnetic calorimeter (ECAL), which includes a silicon sensor preshower detector in front of the ECAL endcaps, and the brass and scintillator hadron calorimeter. Muons are measured in gas-ionization detectors embedded in the steel return yoke. In addition to the barrel and endcap detectors, CMS has extensive forward calorimetry. The inner tracker measures charged particles within pseudorapidity range $|\eta| < 2.5$ and provides an impact parameter resolution of $\sim 15 \mu\text{m}$ and a transverse momentum resolution of about 1.5% for 100 GeV particles. Collision events of interest are selected using a two-tiered trigger system. The first level, composed of custom hardware processors, selects events at a rate of around 100 kHz. The second level, based on an array of microprocessors running a version of the full event reconstruction software optimized for fast processing, reduces the event rate to around 1 kHz before data storage.

3 Event reconstruction and particle identification

Jets are reconstructed using the particle-flow (PF) algorithm [57]. In the PF approach, information from all detectors is combined to reconstruct and identify final-state particles (muons, electrons, photons, and charged and neutral hadrons) produced in the pp collision. PF particles are clustered into jets using the anti- k_T clustering algorithm [58] with a distance parameter of 0.4. Jets are required to pass identification criteria designed to reject anomalous behavior from the calorimeters. The identification efficiency is $>99\%$ for jets with $p_T > 30 \text{ GeV}$ and $|\eta| < 2.4$ that are within the tracking acceptance [59]. The jet energy scale and resolution in simulation are corrected to match their measured values in data using factors that depend on the p_T and η of the jet [60, 61]. Jets originating from the hadronization of bottom quarks are identified using the combined secondary vertex algorithm [62] which exploits observables related to the long lifetime of b hadrons. For b quark jets with $p_T > 30 \text{ GeV}$ and $|\eta| < 2.4$, the algorithm's identification efficiency at the loose working point used in this analysis is about 80%, while misidentification rate for light-quark and gluon jets is about 10% [62]. Although a b-tagged jet requirement is not used to define the LQ SR, b quark jets are used to obtain $t\bar{t}$ -enriched control samples for estimation of the background rate in the SR.

Although muons and electrons are not used to define the SR, they are utilized to obtain control samples for the background estimations. Electron candidates are reconstructed by first matching clusters of energy deposited in the ECAL to reconstructed tracks. Selection criteria based on the distribution of the shower shape, track-cluster geometric matching, and consistency between the cluster energy and track momentum are then used in the identification of electron candidates [63]. Muons are reconstructed using the tracker and muon chambers. Quality requirements based on the minimum number of measurements in

the silicon tracker, pixel detector, and muon chambers are applied to suppress backgrounds from decays in flight and hadron shower remnants that reach the muon system [64]. The muon and electron identification efficiencies for the quality requirements and kinematic range used in this analysis are larger than 98%.

The electron and muon candidates are required to satisfy isolation criteria in order to reject nonprompt leptons that originate from the hadronization process. Isolation is defined as the scalar sum of the p_T values of reconstructed charged and neutral particles within a cone of radius $\Delta R = \sqrt{(\Delta\eta)^2 + (\Delta\phi)^2} = 0.4$ around the lepton-candidate track, excluding the lepton candidate, divided by the p_T of the lepton candidate. A correction is applied to the isolation variable to account for the effects of additional pp interactions (pileup) [65]. For charged particles, only tracks associated with the primary vertex are included in the isolation sums. The reconstructed vertex with the largest value of summed physics-object p_T^2 is taken to be the primary pp interaction vertex. The corresponding physics-objects are the leptons, jets, and the missing transverse momentum (p_T^{miss}) reconstructed from those objects. The jets are clustered using the anti- k_T jet finding algorithm [58, 66] with the tracks assigned to the vertex as inputs.

Hadronic decays of the τ lepton are reconstructed and identified using the hadrons-plus-strips algorithm [67], designed to optimize the performance of τ_h reconstruction by considering specific τ_h decay modes. This algorithm starts from anti- k_T jets and reconstructs τ_h candidates from tracks (also referred to as “prongs”) and energy deposits in strips of the ECAL, in the 1-prong, 1-prong + π^0 , 2-prong, and 3-prong decay modes. The 2-prong decay mode allows τ_h candidates to be reconstructed even if one track has not been reconstructed. However, given the large rate for jets to be misidentified in this decay mode, the 2-prong decay mode is not used to reconstruct τ_h candidates in the signal region of this analysis. To suppress backgrounds from light-quark or gluon jets, identification and isolation conditions are enforced by requiring the τ_h candidates to pass a threshold value of a multivariate (MVA) discriminator [67] that takes isolation variables and variables related to the τ lepton lifetime as input. The isolation variables are calculated using a cone of radius $\Delta R = 0.5$ in the vicinity of the identified τ_h candidate and considering the energy deposits of particles not included in the reconstruction of the τ_h decay mode. The “tight” MVA isolation working point [67] is used to define the SR, which results in a τ_h identification efficiency of typically 55% for the kinematic range used in this analysis. Additionally, τ_h candidates are required to be distinguishable from electrons and muons. The algorithm to discriminate a τ_h from an electron utilizes observables that quantify the compactness and shape of energy deposits in the ECAL, to distinguish electromagnetic from hadronic showers, in combination with observables that are sensitive to the amount of bremsstrahlung emitted along the leading track and to the overall particle multiplicity. The discriminator against muons is based on the presence of measurements in the muon system associated with the track of the τ_h candidate.

The presence of neutrinos from the $\tau\tau$ decays must be inferred from the imbalance of total momentum in the detector. The magnitude of the negative vector sum of the transverse momenta of visible PF objects is the missing transverse momentum. Information from the forward calorimeter is included in the calculation of p_T^{miss} , and the jet corrections

described above are propagated as corrections to p_T^{miss} [68]. Missing transverse momentum is one of the most important observables for differentiating the signal events from background events that do not contain neutrinos, such as quantum chromodynamics (QCD) multijet events.

4 Signal and background samples

The production of top quark pairs ($t\bar{t}$), the production of a Z boson decaying to a τ_h pair plus associated jets from initial-state radiation (Z+jets), and QCD multijet processes are the prevailing backgrounds for this search. Background from $t\bar{t}$ events is characterized by two b quark jets in addition to genuine isolated τ_h leptons. The contribution of Z+jets events constitutes an irreducible background since it has the same final state containing genuine, well-isolated τ_h candidates, associated energetic jets, and true p_T^{miss} from neutrinos present in the τ lepton decays. The QCD multijet events are characterized by jets with a high-multiplicity of particles, which can be misidentified as τ_h .

To estimate the main backgrounds, a combination of Monte Carlo (MC) simulated samples and techniques based on data are employed. The dominant backgrounds are estimated from data, using control regions (CRs) enriched in the contributions of targeted background processes and with negligible contamination from signal events. Samples of events produced by MC simulation are used to extrapolate background yields from a CR to the SR and to model the shape of the distributions of observables defined in section 5 aiming to estimate the mass of the W_R ($m(\tau_{h,1}, \tau_{h,2}, j_1, j_2, p_T^{\text{miss}})$) and that of the LQ (S_T^{MET}). Subdominant background contributions are estimated using MC simulations. The MADGRAPH5_aMC@NLO 2.6.0 program [69] is used for Z+jets, W+jets, $t\bar{t}$ +jets, and single-top quark production. The MADGRAPH5_aMC@NLO generator is interfaced with PYTHIA 8.212 [70], using the CUETP8M1 tune [71], for parton shower and fragmentation. The LO PYTHIA generator is used to model the diboson (VV) processes. The MC background and signal yields are normalized to the integrated luminosity using next-to-next-to-leading order or next-to-leading order (NLO) cross sections [72].

The N_τ signal samples are generated at the leading order using PYTHIA 8.212 with W_R masses ranging from 1 to 4 TeV, in steps of 0.25 TeV. It is assumed that the gauge couplings associated with the left- and right-handed SU(2) groups are equal and the N_τ decays are prompt. It is also assumed that the N_e and N_μ are too heavy to play a role in the decay of W_R , and thus $W_R \rightarrow \tau N_\tau$ and $W_R \rightarrow q\bar{q}'$ are the dominant decay modes. The branching fraction for the $W_R \rightarrow \tau N_\tau$ decay is approximately 10–15%, depending on the W_R and N_τ masses. For the W_R mass range of interest for this analysis, the $N_\tau \rightarrow \tau q\bar{q}'$ branching fraction is close to 100%. The signal cross sections are calculated at the NLO accuracy. The ratios of the NLO and the LO results provide factors of 1.3, known as K factors, for the W_R mass range relevant to this analysis [73].

Simulated samples for the scalar LQ signal processes are generated for a range of masses between 250 and 1500 GeV in steps of 50 GeV. The signal MC generation uses PYTHIA 8.212 and CTEQ6L1 parton distribution functions (PDF) [74]. Signal cross sections are calculated at NLO accuracy using the CTEQ6.6M PDF set [72]. The NLO-to-LO K factors

range from 1.3 to 2.0 in the mass range 200–1500 GeV [72]. The branching fraction of the LQ to a τ lepton and a b quark is assumed to be 100%.

The mean number of interactions in a single bunch crossing in the analysed dataset is 23. In MC events, multiple interactions are superimposed on the primary collision, and each MC event is re-weighted such that the distribution of the number of true interactions matches that in data.

5 Event selection

Events are selected with a trigger requiring at least two τ_h candidates with $p_T > 32$ GeV and $|\eta| < 2.1$ [67]. Additional kinematic criteria on p_T and η are applied to achieve a trigger efficiency greater than 90% per τ_h candidate. Preselected events are required to have at least two τ_h candidates, each with $p_T > 70$ GeV and $|\eta| < 2.1$. The $|\eta| < 2.1$ requirement ensures that the τ_h candidates are fully reconstructed within the tracking acceptance. In addition, the two τ_h candidates must be separated by $\Delta R > 0.4$, to avoid overlaps. Selected τ_h candidates must also pass the reconstruction and identification criteria described in section 3. In the LRSM, $\tau\tau$ pairs can be of the opposite or same-sign charge.

The associated jet selection criteria include at least two jets with $p_T > 50$ GeV and $|\eta| < 2.4$. To avoid overlaps, only jet candidates separated from the selected τ_h candidates by $\Delta R > 0.4$ are considered. The background contribution from QCD multijet events is larger in this analysis than in channels with one or both τ leptons decaying leptonically. To suppress the contribution from QCD multijet events, p_T^{miss} is required to be larger than 50 GeV. Finally, the visible invariant mass of the $\tau_h\tau_h$ pair, $m(\tau_{h,1}, \tau_{h,2})$, is chosen to be greater than 100 GeV, to reduce the Z+jets contribution.

The visible τ lepton decay products, the two highest p_T jets, and the missing transverse momentum vector \vec{p}_T^{miss} are used to define an observable for each benchmark scenario considered in the analysis. The heavy neutrino search strategy consists in looking for a broad enhancement of events above the expected background in the distribution of the partial mass indicative of new physics, defined as:

$$m(\tau_{h,1}, \tau_{h,2}, j_1, j_2, p_T^{\text{miss}}) = \sqrt{(E_{\tau_{h,1}} + E_{\tau_{h,2}} + E_{j_1} + E_{j_2} + p_T^{\text{miss}})^2 - (\vec{p}_{\tau_{h,1}} + \vec{p}_{\tau_{h,2}} + \vec{p}_{j_1} + \vec{p}_{j_2} + \vec{p}_T^{\text{miss}})^2}.$$

On average the partial mass is large in the heavy-neutrino case, $\langle m(\tau_{h,1}, \tau_{h,2}, j_1, j_2, p_T^{\text{miss}}) \rangle \approx m(W_R)$. For the pair production of LQs, the scalar sum of the transverse momenta of the decay products and the p_T^{miss} , $S_T^{\text{MET}} = p_T^{\tau_{h,1}} + p_T^{\tau_{h,2}} + p_T^{j_1} + p_T^{j_2} + p_T^{\text{miss}}$, is expected to be large ($\langle S_T^{\text{MET}} \rangle \approx m(\text{LQ})$). The analysis explores the possibility of an excess of events with respect to the background prediction in the upper range of the S_T^{MET} distribution. The S_T^{MET} variable provides better significance in comparison to the $S_T = p_T^{\tau_{h,1}} + p_T^{\tau_{h,2}} + p_T^{j_1} + p_T^{j_2}$ variable used in the prior LQ search in the $\tau_h\tau_h jj$ channel [51].

The set of events satisfying the preselection together with the associated jet selection define the SR. The total expected background yield in the SR, estimated from simulation, is

126 events, with $t\bar{t}$, QCD multijet, Z+jets, W+jets, single-top quark, and diboson production composing 38.0, 27.0, 18.4, 11.0, 4.0 and, 1.6% of the rate, respectively. The analysis strategy is similar to that of previous heavy neutrino and leptoquark searches [50, 51]. However, unlike heavy neutrino searches in the $eejj$ or $\mu\mu jj$ final states [45, 52], the W_R resonance mass in the $\tau_h\tau_h jj$ channel cannot be fully reconstructed because of the presence of neutrinos from the τ lepton decays.

The signal selection efficiency for the W_R process, assuming that the N_τ mass is half of the W_R mass, is 2.0% for $m(W_R) = 1.0$ TeV and 6.6% for $m(W_R) = 4.0$ TeV. The corresponding efficiency for $LQ \rightarrow \tau b$ events is 5.1% for $m(LQ) = 0.6$ TeV and 8.2% for $m(LQ) = 1.0$ TeV. These efficiencies include the 42% branching fraction of $\tau\tau$ to $\tau_h\tau_h$.

6 Background estimation

The $t\bar{t}$, QCD multijet, and Z+jets processes are expected to account for 84% of the total background. Dedicated CRs are used to check the modeling of $t\bar{t}$ and Z+jets events in simulation and to determine if any corrections need be applied. The estimation of the QCD multijet background is performed using a method fully based on data. The remaining contributions arising from W+jets, single-top quark, and diboson events are obtained from simulation.

A $t\bar{t}$ -enriched control sample is obtained with similar selections to the SR, except selecting two well-identified muons instead of two τ_h candidates, requiring at least one b-tagged jet, and vetoing dimuon candidates around the Z boson mass peak ($80 < m_{\mu\mu} < 110$ GeV). Since the dijet and p_T^{miss} selection criteria are the same as in the SR, the data-to-simulation scale factor $SF_{\mu\mu}^{t\bar{t}} = 0.93 \pm 0.01$ measured in this CR represents a correction for the modeling of the dijet and p_T^{miss} selection efficiencies by simulation.

Figure 3 (right) shows the S_T^{MET} distribution in this CR, after correcting the $t\bar{t}$ normalization from simulation using the measured scale factor $SF_{\mu\mu}^{t\bar{t}}$. The agreement gives confidence that the S_T^{MET} shape for the $t\bar{t}$ background can be taken from simulation. An alternate estimate of the scale factor is obtained from a CR defined with the same dijet and p_T^{miss} requirements as for the SR but selecting events with one muon and one electron (instead of a $\tau_h\tau_h$ pair). The resulting estimate, $SF_{e\mu}^{t\bar{t}} = 0.90 \pm 0.01$, is combined with the measurement from the dimuon CR; the average of the two scale factors ($SF^{t\bar{t}}$) is used to estimate the $t\bar{t}$ prediction in the SR, and the absolute difference between the two scale factors, 3%, is considered a systematic uncertainty in the estimated $t\bar{t}$ yield. Therefore, the $t\bar{t}$ contribution in the SR, $N_{\text{SR}}^{t\bar{t}}$, is given by $N_{\text{SR}}^{t\bar{t}} = N_{\text{SR}}^{t\bar{t}}(\text{MC})SF^{t\bar{t}}$.

The measurement of the Z+jets background component is based on both simulation and data. Ideally the Z+jets contribution to the SR would be obtained using a CR obtained with similar $\tau_h\tau_h jj$ criteria to the SR, but with minimal modifications to the selection to achieve negligible signal contamination. However, such a CR has too few events, resulting in large systematic uncertainty. Instead, since the efficiency of the requirement of two high quality τ_h candidates is known to be well modeled by simulation [67], we use a Z+jets-enriched control sample obtained by requiring two well-identified muons with an invariant mass compatible with the Z-mass peak, instead of two τ_h candidates, and all of the other

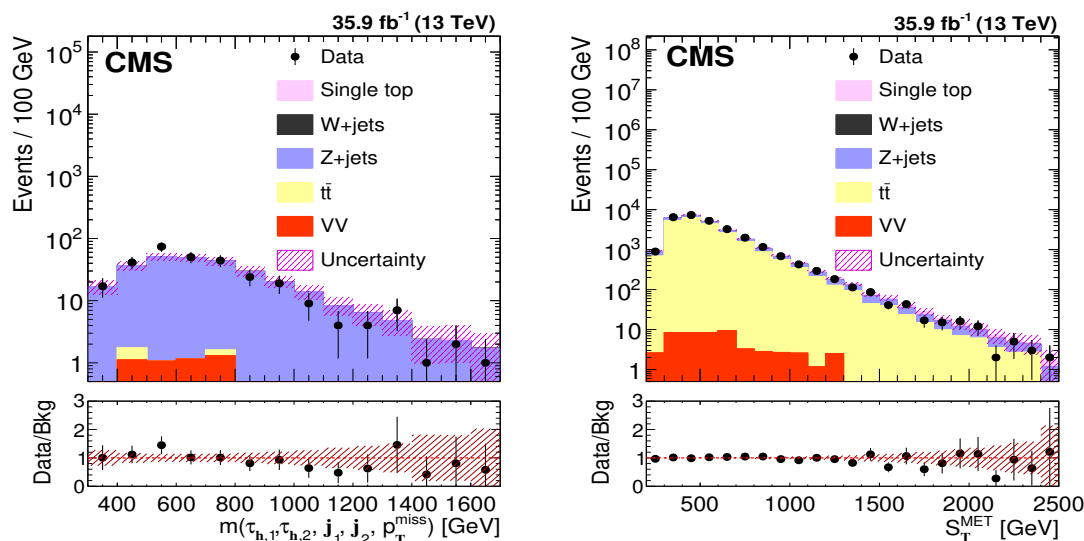

Figure 3. Distributions in $m(\tau_{h,1}, \tau_{h,2}, j_1, j_2, p_T^{\text{miss}})$ (left), for the $Z(\tau\tau)$ control sample with relaxed τ_h candidate p_T thresholds and $m(\tau_{h,1}, \tau_{h,2}) < 100$ GeV, and S_T^{MET} (right), for the $t\bar{t}(\mu\mu jj)$ control sample. The bottom frames show the ratio between the observed data in the control samples and the total background (Bkg) predictions. The bands correspond to the statistical uncertainty for the background.

event selection criteria used in the SR. Since muons are produced in Z -decays as often as τ leptons, a $\mu\mu jj$ control sample can be used to measure a correction factor $S_{\text{dijet}}^{Z \rightarrow \mu\mu}$ for the modeling of two additional jets, independently from the $\tau_h \tau_h$ requirement, and with reduced systematic uncertainty. Candidate events for the $Z(\rightarrow \mu\mu)+\text{jets}$ control sample were collected using a trigger that requires at least one isolated muon with $p_T(\mu) > 24$ GeV per event. The measured correction factor is $S_{\text{dijet}}^{Z \rightarrow \mu\mu} = 1.02 \pm 0.02$. Therefore, the $Z(\rightarrow \tau\tau)$ contribution in the SR can be calculated as $N_{\text{SR}}^{Z \rightarrow \tau\tau} = N_{\text{SR}}^{Z \rightarrow \tau\tau}(\text{MC}) S_{\text{dijet}}^{Z \rightarrow \mu\mu}$. The modeling of the shapes of the $m(\tau_{h,1}, \tau_{h,2}, j_1, j_2, p_T^{\text{miss}})$ and S_T^{MET} distributions is checked in $Z(\rightarrow \tau\tau)+\text{jets}$ events that pass relaxed conditions on the $\tau_h p_T$ threshold ($p_T > 60$ GeV) and an inverted requirement on the mass of the $\tau_h \tau_h$ pair ($m(\tau_{h,1}, \tau_{h,2}) < 100$ GeV). Figure 3 (left) shows the $m(\tau_{h,1}, \tau_{h,2}, j_1, j_2, p_T^{\text{miss}})$ distribution in this CR. The simulated and observed distributions of $m(\tau_{h,1}, \tau_{h,2}, j_1, j_2, p_T^{\text{miss}})$ and S_T^{MET} are found to be in agreement.

Events from QCD multijet processes become a background when two jets are misidentified as τ_h candidates. To avoid reliance on simulation, which may not be trustworthy at the high values of p_T , $m(\tau_{h,1}, \tau_{h,2}, j_1, j_2, p_T^{\text{miss}})$, and S_T^{MET} of the search region, the QCD multijet background is estimated from data using the matrix (“ $ABCD$ ”) method. Since p_T^{miss} and τ_h isolation are the main discriminating variables against QCD multijet events, the estimation methodology for this background utilizes CRs obtained by inverting the requirements on these observables. It has been checked that the p_T^{miss} and the τ_h isolation variables are uncorrelated. In the remainder of this section, events obtained by inverting the isolation requirement on both τ_h candidates will be referred to as nonisolated $\tau_h \tau_h$ samples. The regions used to perform the QCD multijet estimation, referred to as $ABCD$,

are defined as follows:

- A: $p_T^{\text{miss}} < 50$ GeV; fail the tight but pass the loose τ_h isolation
- B: $p_T^{\text{miss}} < 50$ GeV; pass the tight τ_h isolation
- C: $p_T^{\text{miss}} > 50$ GeV; fail the tight but pass the loose τ_h isolation
- D: $p_T^{\text{miss}} > 50$ GeV; pass the tight τ_h isolation

Note that region D corresponds to the SR. The regions A , B and C are enriched in QCD multijet events (78–96% depending on the region). We estimate the QCD multijet component in the SR as $N_{\text{QCD}}^D = N_{\text{QCD}}^C (N_{\text{QCD}}^B / N_{\text{QCD}}^A)$, where contributions from non-QCD backgrounds ($N_{\neq\text{QCD}}$) are subtracted from data in each region $i = A, B, C$ using the MC prediction ($N_{\text{QCD}}^i = N_{\text{Data}}^i - N_{\neq\text{QCD}}^i$). Here $N_{\text{QCD}}^B / N_{\text{QCD}}^A$ is referred to as the isolation “tight-to-loose” (TL) ratio. The shapes of QCD multijet events in data containing two nonisolated τ_h candidates are normalized using the TL ratio. This procedure yields a QCD multijet estimate of $N_{\text{QCD}}^{\text{SR}} = 33.8 \pm 6.0$. The uncertainty is based on the event counts in the data and MC samples.

To check that the shapes of the $m(\tau_{h,1}, \tau_{h,2}, j_1, j_2, p_T^{\text{miss}})$ and S_T^{MET} distributions obtained from the nonisolated CR are the same as the ones in the isolated region, we use events from QCD-enriched CRs A and B . Figure 4 shows the $m(\tau_{h,1}, \tau_{h,2}, j_1, j_2, p_T^{\text{miss}})$ and S_T^{MET} distributions in CR B . The shape of QCD multijet events is obtained from data in CR A , after subtracting non-QCD contributions using the simulation. The expected QCD multijet yield is calculated as $N_{\text{QCD}}^B = N_{\text{Data}}^B - N_{\neq\text{QCD}}^B$, such that the total background yield matches the observed number of events in data. Therefore, the focus of this test is the overall agreement of the QCD multijet shapes extracted from the nonisolated τ_h region, as applied to the isolated region. The agreement between the data and the predicted background distributions in figure 4 gives confidence that the $m(\tau_{h,1}, \tau_{h,2}, j_1, j_2, p_T^{\text{miss}})$ and S_T^{MET} shapes for the QCD multijet background can be extracted from the nonisolated side-band and helps reduce the uncertainty in the final QCD multijet background estimate.

7 Systematic uncertainties

The imperfect MC modeling of the background processes considered in this analysis can affect the normalizations and shapes of the $m(\tau_{h,1}, \tau_{h,2}, j_1, j_2, p_T^{\text{miss}})$ and S_T^{MET} distributions used for the final result. Therefore, these effects are included as systematic uncertainties. The following systematic uncertainties are considered. A p_T -dependent uncertainty per τ_h candidate in the measured trigger efficiency results in a 6% uncertainty in the signal and background predictions that rely on simulation. The trigger efficiency is measured per τ_h candidate by calculating the fraction of $Z(\rightarrow \tau\tau \rightarrow \mu\tau_h)$ events (selected with a single- μ trigger), that also pass a $\mu\text{-}\tau_h$ trigger that has the same τ_h trigger requirements as the $\tau_h\tau_h$ trigger used to define the SR. Systematic effects related to the correct τ_h identification are measured to be 5% per τ_h candidate [75]. This effect is estimated from a fit to the $Z(\rightarrow \tau\tau)$ visible mass distribution, using the production cross section measured in the

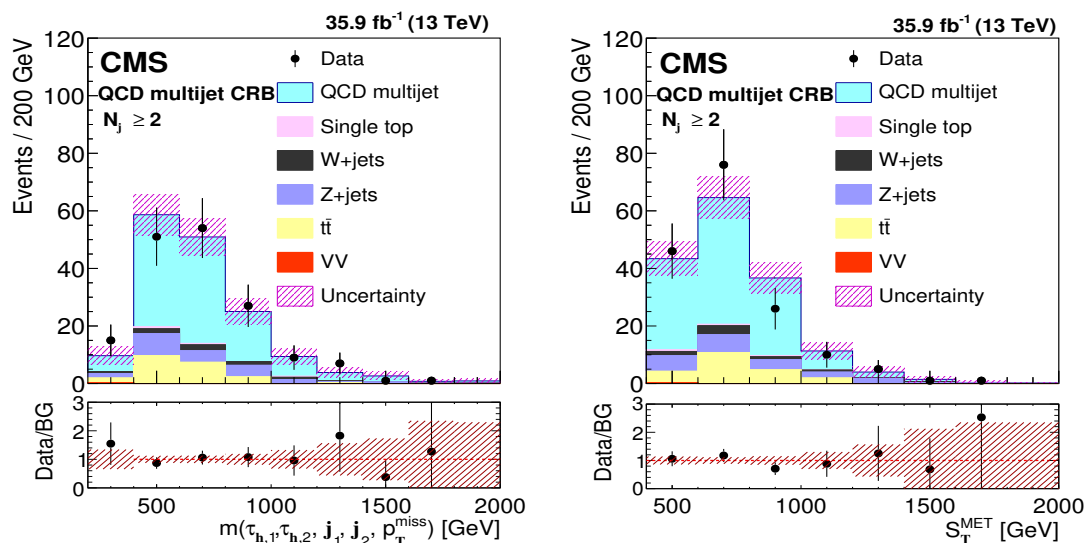

Figure 4. QCD multijet background validation test, using the distributions in CR B $m(\tau_{h,1}, \tau_{h,2}, j_1, j_2, p_T^{\text{miss}})$ (left) and S_T^{MET} (right). The shape of the QCD background is found from data in the loose τ_h region, CR A and then applied to CR B , defined by $p_T^{\text{miss}} < 50$ GeV and tight τ_h isolation. For both samples, the non-QCD contributions are estimated from simulation. Note that the normalizations match by construction. The bottom frame shows the ratio between the observed data in CR B and the total background estimation.

$Z(\rightarrow ee)$ and $Z(\rightarrow \mu\mu)$ final states. An additional asymmetric systematic uncertainty of +5% and -35% at $p_T = 1$ TeV [67] that increases linearly with p_T is included to account for the extrapolation in the τ_h identification efficiency estimate, which is mostly determined by low- p_T hadronic τ lepton decays close to the Z boson peak, to the higher- p_T regimes relevant to this analysis. A 3% uncertainty in the reconstructed τ_h energy scale (TES) is used to assign a systematic uncertainty in both the predicted yields and the mass and S_T^{MET} shapes for signal and background with total or partial MC estimation [67]. This effect ranges from 3 to 9% depending on the sample. Systematic effects on normalization and shapes due to the uncertainty in the jet energy scale (JES) (2–5% depending on p_T and η) are also included, resulting in 5 to 9% uncertainty in the normalization, depending on the sample. Systematic uncertainties in the shapes, based on the level of agreement between the data and MC distributions in the control samples, are also assigned. The data-to-simulation ratios of the mass and S_T^{MET} distributions are fit with a first-order polynomial. The deviation of the fit from unity, as a function of mass or S_T^{MET} , is assigned as a systematic uncertainty in the shape. This results in up to 20% systematic uncertainty in a given bin. We have checked that the choice of a first-order polynomial for the fit function adequately describes potential differences between data and MC simulation. A 2.5% uncertainty comes from the measurement of the total integrated luminosity [76], and affects signal and all backgrounds that are determined (in part or entirely) by simulation.

Other contributions to the total systematic uncertainty in the predicted background yields arise from the validation tests and from the statistical uncertainties associated with

Source	QCD	W+jets	Z+jets	$t\bar{t}$	VV	Signal
Integrated luminosity	—	2.5	2.5	2.5	2.5	2.5
$\tau_h\tau_h$ trigger	—	6	6	6	6	6
τ_h identification	—	33	10	10	12	10
JES	—	9	8	6	9	5
TES	—	9	9	9	8	3
PDF	—	6	6	6	6	6
Scales	—	1	1	3.5	—	2.5
Background est.: closure+norm.	21	—	7	3	—	—

Table 1. Summary of systematic uncertainties, given in percent. The τ_h identification, JES, and TES uncertainties are also considered as uncertainties in the shapes of the $m(\tau_{h,1}, \tau_{h,2}, j_1, j_2, p_T^{\text{miss}})$ and S_T^{MET} distributions. Not included in the table are the bin-by-bin statistical uncertainties, which increase with larger values of mass and S_T^{MET} .

the data control regions used to determine the $SF^{t\bar{t}}$, $SF_{\text{dijet}}^{Z\rightarrow\mu\mu}$, and TL factors. The relative systematic uncertainties in $SF^{t\bar{t}}$ and $SF_{\text{dijet}}^{Z\rightarrow\mu\mu}$ related to the statistical precision in the CRs range between 1 and 2%, depending on the background component. For the QCD multijet background, the systematic uncertainty is dominated by the statistical uncertainty in the TL factor (18%). The systematic uncertainties in the $SF^{t\bar{t}}$, $SF_{\text{dijet}}^{Z\rightarrow\mu\mu}$, and TL factors, evaluated from the validation tests with data and from the subtraction of nontargeted backgrounds, range from 3% for $SF^{t\bar{t}}$ to 10% for TL.

The uncertainty in the signal acceptance (6%) associated with the choice of the PDF set included in the simulated samples is evaluated in accordance to the PDF4LHC recommendation [77–79]. The absence of higher-order contributions to the cross sections affect the signal acceptance calculation. This effect is estimated by varying the renormalization and factorization scales a factor of two with respect to their nominal values, and by considering the full change in the yields. They are estimated from simulation and found to be small for both signal (2.5%) and background (1% for diboson and 3.5% for $t\bar{t}$). Table 1 summarizes the systematic uncertainties considered in the analysis. The total systematic uncertainties in the background normalizations range from 18 to 37%, depending on the background, while the total systematic uncertainty in the signal normalization is approximately 15%.

8 Results

The observed yield is 117 events, while the total predicted background yield is 127.0 ± 11.8 events (see table 2). Table 2 illustrates the relative importance of the different backgrounds. Note, however, that the relative yields of different background processes do not directly reflect the effect on the sensitivity of the analysis, as a binned maximum likelihood fit, in which shape information enters besides the yields, is used to set limits on the signal rate. Figure 5 shows the background predictions, the observed data, and the expected signal in the $m(\tau_{h,1}, \tau_{h,2}, j_1, j_2, p_T^{\text{miss}})$ and S_T^{MET} distributions. The heavy neutrino model with $m(W_R) = 3.0$ TeV and $m(N_\tau) = 1.5$ TeV is used as a benchmark in figure 5 (left), while the leptoquark model with $m(\text{LQ}) = 1.0$ TeV is used as a benchmark in figure 5 (right). The

observed data event rate and shapes are consistent with the SM background expectation. Therefore, exclusion limits for the two signal benchmark scenarios are set, using the distribution in $m(\tau_{h,1}, \tau_{h,2}, j_1, j_2, p_T^{\text{miss}})$ for the N_τ case and in S_T^{MET} for the LQ interpretation. The results are presented as 95% confidence level (CL) upper limits on the signal production cross sections, estimated with the modified frequentist construction CL_s method [80–82]. Maximum likelihood fits are performed using the final $m(\tau_{h,1}, \tau_{h,2}, j_1, j_2, p_T^{\text{miss}})$ and S_T^{MET} discrimination variables to derive the expected and observed limits. Systematic uncertainties are represented by nuisance parameters, assuming a gamma function prior for the uncertainties in the data-driven background estimations, log-normal prior for MC-driven normalization parameters, and Gaussian priors for the shape uncertainties. Statistical uncertainties in the shape templates are accounted for by the technique described in ref. [83].

Figure 6 shows the expected and observed limits on the cross section, as well as the theoretical prediction [72, 73], as functions of $m(W_R)$ and $m(\text{LQ})$. For heavy neutrino models with strict left-right symmetry, with the assumptions that only the N_τ flavor contributes significantly to the W_R decay width and that the N_τ mass is $0.5 \times m(W_R)$, W_R masses below 3.50 TeV are excluded at 95% CL (expected exclusion 3.35 TeV). For the LQ interpretation using S_T^{MET} as the final fit variable, the observed (expected) 95% CL exclusion is 1.02 (1.00) TeV. These results are the most stringent limits to date.

Figure 7 shows 95% CL upper limits on the product of the production cross section and branching fraction, as a function of $m(W_R)$ and $x = m(N_\tau)/m(W_R)$. The signal acceptance and mass shape are evaluated for each $\{m(W_R), x\}$ combination and used in the limit calculation procedure described above. The W_R limits depend on the N_τ mass. For example, a scenario with $x = 0.1$ (0.25) yields significantly lower average jet and subleading τ_h p_T than the $x = 0.5$ mass assumption, and the acceptance is lower by a factor of about 16 (3) for $m(W_R) = 1.0$ TeV and about 5.8 (1.8) for $m(W_R) = 3.0$ TeV. On the other hand, the $x = 0.75$ scenario produces similar or larger average p_T for the jet and the τ_h than the $x = 0.5$ mass assumption, yielding an event acceptance that is about 10% larger. Masses below $m(W_R) = 3.52$ (2.75) TeV are excluded at 95% CL, assuming that the N_τ mass is 0.8 (0.2) times the mass of the W_R boson.

9 Summary

A search is performed for physics beyond the standard model in events with two energetic τ leptons and two energetic jets, using data corresponding to an integrated luminosity of 35.9 fb^{-1} collected in 2016 with the CMS detector in proton-proton collisions at $\sqrt{s} = 13$ TeV. The search focuses on two benchmark scenarios: (1) the production of heavy right-handed Majorana neutrinos, N_ℓ , and right-handed W_R bosons, which arise in the left-right symmetric extensions of the standard model and where the W_R and N_ℓ decay chains result in a pair of high transverse momentum τ leptons; and (2) the pair production of third-generation scalar leptoquarks that decay to $\tau\tau b\bar{b}$. The observed $m(\tau_{h,1}, \tau_{h,2}, j_1, j_2, p_T^{\text{miss}})$ and S_T^{MET} distributions do not reveal any evidence for physics beyond the standard model. Assuming that only the N_τ flavor contributes significantly to the W_R decay width, W_R masses below 3.52 (2.75) TeV are excluded at 95% confidence level, assuming the N_τ mass

Process	Yield
$t\bar{t}$	49.8 ± 11.8
QCD	33.8 ± 9.3
Z+jets	23.4 ± 6.5
W+jets	13.4 ± 6.2
Single top	4.6 ± 2.2
VV	2.0 ± 1.5
Total	127.0 ± 17.7
Observed	117
$m(W_R) = 3.0 \text{ TeV}$	17.3 ± 2.5
$m(LQ) = 1.0 \text{ TeV}$	14.2 ± 2.1

Table 2. Estimated background and signal yields in the SR and their total uncertainties. The expected number of events for the W_R signal sample assumes $m(N_\tau) = m(W_R)/2$.

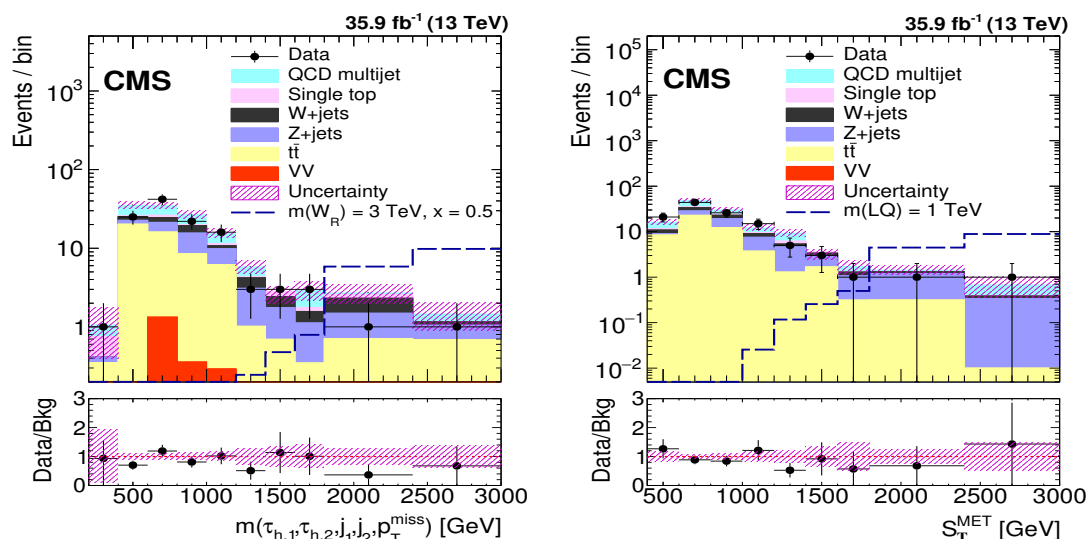

Figure 5. Distributions in $m(\tau_{h,1}, \tau_{h,2}, j_1, j_2, p_T^{\text{miss}})$ (left) and S_T^{MET} (right) for the estimated background in the signal region. The heavy neutrino model with $m(W_R) = 3 \text{ TeV}$ and $m(N_\tau) = 1.5 \text{ TeV}$ is used as a benchmark in the $m(\tau_{h,1}, \tau_{h,2}, j_1, j_2, p_T^{\text{miss}})$ distribution, while the leptoquark model with $m(LQ) = 1 \text{ TeV}$ is used as a benchmark in the S_T^{MET} distribution. The bottom frame shows the ratio between the observed data and the background estimation; the band corresponds to the statistical uncertainty in the background. The $t\bar{t}$, QCD multijet, and Z+jets contributions are estimated employing control regions in data and simulation, while the other contributions are obtained fully from the simulation.

is 0.8(0.2) times the mass of the W_R boson. In the second beyond the standard model scenario, leptoquarks with a mass less than 1.02 TeV are excluded at 95% confidence level, to be compared with an expected mass limit of 1.00 TeV. Both of these results represent the most stringent limits to date for $\tau\tau jj$ final states.

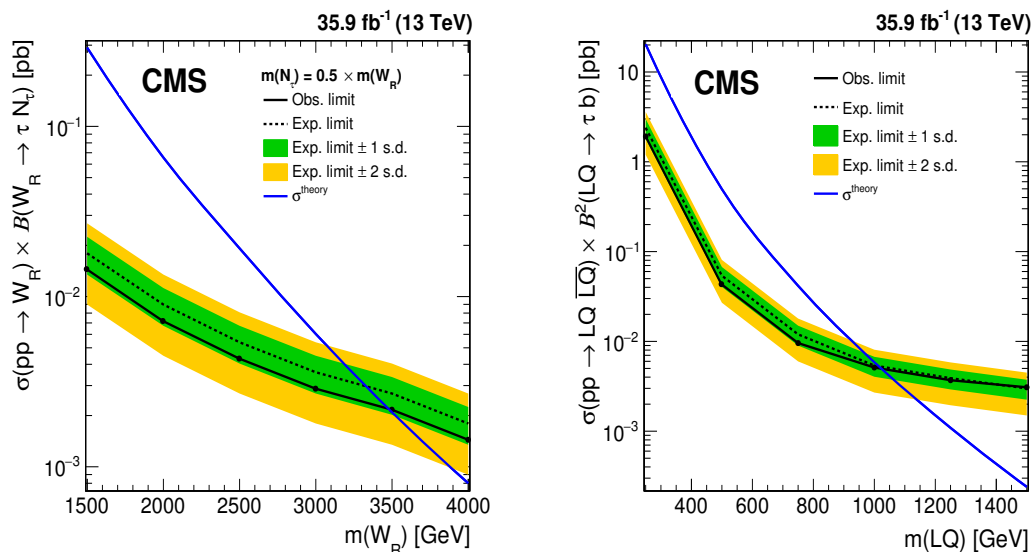

Figure 6. Upper limits at 95% CL on the product of the cross section and the branching fraction for the production of W_R (left) decaying to N_τ and for a pair of leptoquarks each decaying to τb (right), as functions of the produced particle mass. The observed limits are shown as solid black lines. Expected limits and their one- (two-) standard deviation limits are shown by dashed lines with green (yellow) bands. The theoretical cross sections are indicated by the solid blue lines.

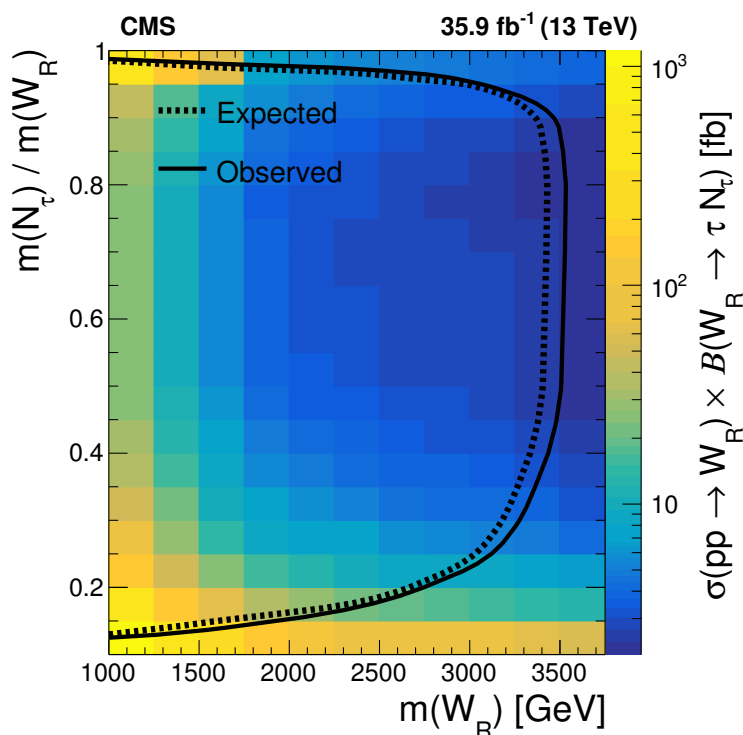

Figure 7. Expected and observed limits at 95% CL on the product of the cross section and the branching fraction ($W_R \rightarrow \tau N_\tau$) as a function of $m(W_R)$ and $m(N_\tau)/m(W_R)$.

Acknowledgments

We congratulate our colleagues in the CERN accelerator departments for the excellent performance of the LHC and thank the technical and administrative staffs at CERN and at other CMS institutes for their contributions to the success of the CMS effort. In addition, we gratefully acknowledge the computing centres and personnel of the Worldwide LHC Computing Grid for delivering so effectively the computing infrastructure essential to our analyses. Finally, we acknowledge the enduring support for the construction and operation of the LHC and the CMS detector provided by the following funding agencies: BMBWF and FWF (Austria); FNRS and FWO (Belgium); CNPq, CAPES, FAPERJ, FAPERGS, and FAPESP (Brazil); MES (Bulgaria); CERN; CAS, MoST, and NSFC (China); COLCIENCIAS (Colombia); MSES and CSF (Croatia); RPF (Cyprus); SENESCYT (Ecuador); MoER, ERC IUT, and ERDF (Estonia); Academy of Finland, MEC, and HIP (Finland); CEA and CNRS/IN2P3 (France); BMBF, DFG, and HGF (Germany); GSRT (Greece); NKFI (Hungary); DAE and DST (India); IPM (Iran); SFI (Ireland); INFN (Italy); MSIP and NRF (Republic of Korea); MES (Latvia); LAS (Lithuania); MOE and UM (Malaysia); BUAP, CINVESTAV, CONACYT, LNS, SEP, and UASLP-FAI (Mexico); MOS (Montenegro); MBIE (New Zealand); PAEC (Pakistan); MSHE and NSC (Poland); FCT (Portugal); JINR (Dubna); MON, RosAtom, RAS, RFBR, and NRC KI (Russia); MESTD (Serbia); SEIDI, CPAN, PCTI, and FEDER (Spain); MOSTR (Sri Lanka); Swiss Funding Agencies (Switzerland); MST (Taipei); ThEPCenter, IPST, STAR, and NSTDA (Thailand); TUBITAK and TAEK (Turkey); NASU and SFFR (Ukraine); STFC (United Kingdom); DOE and NSF (U.S.A.).

Individuals have received support from the Marie-Curie programme and the European Research Council and Horizon 2020 Grant, contract No. 675440 (European Union); the Leventis Foundation; the A. P. Sloan Foundation; the Alexander von Humboldt Foundation; the Belgian Federal Science Policy Office; the Fonds pour la Formation à la Recherche dans l'Industrie et dans l'Agriculture (FRIA-Belgium); the Agentschap voor Innovatie door Wetenschap en Technologie (IWT-Belgium); the F.R.S.-FNRS and FWO (Belgium) under the “Excellence of Science — EOS” — be.h project n. 30820817; the Ministry of Education, Youth and Sports (MEYS) of the Czech Republic; the Lendület (“Momentum”) Programme and the János Bolyai Research Scholarship of the Hungarian Academy of Sciences, the New National Excellence Program ÚNKP, the NKFI research grants 123842, 123959, 124845, 124850 and 125105 (Hungary); the Council of Science and Industrial Research, India; the HOMING PLUS programme of the Foundation for Polish Science, cofinanced from European Union, Regional Development Fund, the Mobility Plus programme of the Ministry of Science and Higher Education, the National Science Center (Poland), contracts Harmonia 2014/14/M/ST2/00428, Opus 2014/13/B/ST2/02543, 2014/15/B/ST2/03998, and 2015/19/B/ST2/02861, Sonata-bis 2012/07/E/ST2/01406; the National Priorities Research Program by Qatar National Research Fund; the Programa Estatal de Fomento de la Investigación Científica y Técnica de Excelencia María de Maeztu, grant MDM-2015-0509 and the Programa Severo Ochoa del Principado de Asturias; the Thalís and Aristeia programmes cofinanced by EU-ESF and the Greek NSRF; the Rachadapisek Sompot Fund for

Postdoctoral Fellowship, Chulalongkorn University and the Chulalongkorn Academic into Its 2nd Century Project Advancement Project (Thailand); the Welch Foundation, contract C-1845; and the Weston Havens Foundation (U.S.A.).

Open Access. This article is distributed under the terms of the Creative Commons Attribution License ([CC-BY 4.0](https://creativecommons.org/licenses/by/4.0/)), which permits any use, distribution and reproduction in any medium, provided the original author(s) and source are credited.

References

- [1] PARTICLE DATA GROUP collaboration, *Review of particle physics*, *Chin. Phys. C* **40** (2016) 100001 [[INSPIRE](#)].
- [2] M. Lindner, T. Ohlsson and G. Seidl, *Seesaw mechanisms for Dirac and Majorana neutrino masses*, *Phys. Rev. D* **65** (2002) 053014 [[hep-ph/0109264](#)] [[INSPIRE](#)].
- [3] P. Minkowski, $\mu \rightarrow e\gamma$ at a rate of one out of 10^9 muon decays?, *Phys. Lett.* **67B** (1977) 421 [[INSPIRE](#)].
- [4] R.N. Mohapatra and G. Senjanović, *Neutrino mass and spontaneous parity nonconservation*, *Phys. Rev. Lett.* **44** (1980) 912 [[INSPIRE](#)].
- [5] M. Gell-Mann, P. Ramond and R. Slansky, *Complex spinors and unified theories*, in *Supergravity*, P. van Nieuwenhuizen and D.Z. Freedman eds., Elsevier Science Ltd, New York (1979), [[arXiv:1306.4669](#)] [[INSPIRE](#)].
- [6] T. Yanagida, *Horizontal symmetry and masses of neutrinos*, *Prog. Theor. Phys.* **64** (1980) 1103 [[INSPIRE](#)].
- [7] R.N. Mohapatra and R.E. Marshak, *Local B-L symmetry of electroweak interactions, Majorana neutrinos and neutron oscillations*, *Phys. Rev. Lett.* **44** (1980) 1316 [*Erratum ibid.* **44** (1980) 1643] [[INSPIRE](#)].
- [8] J.C. Pati and A. Salam, *Unified lepton-hadron symmetry and a gauge theory of the basic interactions*, *Phys. Rev. D* **8** (1973) 1240 [[INSPIRE](#)].
- [9] J.C. Pati and A. Salam, *Lepton number as the fourth color*, *Phys. Rev. D* **10** (1974) 275 [*Erratum ibid.* **D 11** (1975) 703] [[INSPIRE](#)].
- [10] H. Georgi and S.L. Glashow, *Unity of all elementary particle forces*, *Phys. Rev. Lett.* **32** (1974) 438 [[INSPIRE](#)].
- [11] H. Fritzsch and P. Minkowski, *Unified interactions of leptons and hadrons*, *Annals Phys.* **93** (1975) 193 [[INSPIRE](#)].
- [12] S. Dimopoulos and L. Susskind, *Mass without scalars*, *Nucl. Phys. B* **155** (1979) 237 [[INSPIRE](#)].
- [13] S. Dimopoulos, *Technicolored signatures*, *Nucl. Phys. B* **168** (1980) 69 [[INSPIRE](#)].
- [14] E. Farhi and L. Susskind, *Technicolor*, *Phys. Rept.* **74** (1981) 277 [[INSPIRE](#)].
- [15] K.D. Lane and M.V. Ramana, *Walking technicolor signatures at hadron colliders*, *Phys. Rev. D* **44** (1991) 2678 [[INSPIRE](#)].
- [16] B. Schrempp and F. Schrempp, *Light leptoquarks*, *Phys. Lett.* **153B** (1985) 101 [[INSPIRE](#)].

- [17] B. Gripaios, *Composite Leptoquarks at the LHC*, *JHEP* **02** (2010) 045 [[arXiv:0910.1789](#)] [[INSPIRE](#)].
- [18] G.R. Farrar and P. Fayet, *Phenomenology of the production, decay and detection of new hadronic states associated with supersymmetry*, *Phys. Lett.* **76B** (1978) 575 [[INSPIRE](#)].
- [19] P. Ramond, *Dual theory for free fermions*, *Phys. Rev.* **D 3** (1971) 2415 [[INSPIRE](#)].
- [20] Yu.A. Golfand and E.P. Likhtman, *Extension of the algebra of Poincaré group generators and violation of p invariance*, *JETP Lett.* **13** (1971) 323 [[INSPIRE](#)].
- [21] A. Neveu and J.H. Schwarz, *Factorizable dual model of pions*, *Nucl. Phys.* **B 31** (1971) 86 [[INSPIRE](#)].
- [22] D.V. Volkov and V.P. Akulov, *Possible universal neutrino interaction*, *JETP Lett.* **16** (1972) 438 [[INSPIRE](#)].
- [23] J. Wess and B. Zumino, *A lagrangian model invariant under supergauge transformations*, *Phys. Lett.* **49B** (1974) 52 [[INSPIRE](#)].
- [24] J. Wess and B. Zumino, *Supergauge transformations in four-dimensions*, *Nucl. Phys.* **B 70** (1974) 39 [[INSPIRE](#)].
- [25] P. Fayet, *Supergauge invariant extension of the Higgs mechanism and a model for the electron and its neutrino*, *Nucl. Phys.* **B 90** (1975) 104 [[INSPIRE](#)].
- [26] H.P. Nilles, *Supersymmetry, supergravity and particle physics*, *Phys. Rept.* **110** (1984) 1 [[INSPIRE](#)].
- [27] R. Barbier et al., *R -parity violating supersymmetry*, *Phys. Rept.* **420** (2005) 1 [[hep-ph/0406039](#)] [[INSPIRE](#)].
- [28] W. Buchmüller and D. Wyler, *Constraints on SU(5) type leptoquarks*, *Phys. Lett.* **B 177** (1986) 377 [[INSPIRE](#)].
- [29] O.U. Shanker, *$\pi\ell 2$, $K\ell 3$ and K^0 - \bar{K}^0 constraints on leptoquarks and supersymmetric particles*, *Nucl. Phys.* **B 204** (1982) 375 [[INSPIRE](#)].
- [30] BABAR collaboration, *Evidence for an excess of $\bar{B} \rightarrow D^{(*)}\tau^-\bar{\nu}_\tau$ decays*, *Phys. Rev. Lett.* **109** (2012) 101802 [[arXiv:1205.5442](#)] [[INSPIRE](#)].
- [31] BABAR collaboration, *Measurement of an excess of $\bar{B} \rightarrow D^{(*)}\tau^-\bar{\nu}_\tau$ decays and implications for charged Higgs bosons*, *Phys. Rev.* **D 88** (2013) 072012 [[arXiv:1303.0571](#)] [[INSPIRE](#)].
- [32] BELLE collaboration, *Observation of $B^0 \rightarrow D^{*-}\tau^+\nu_\tau$ decay at Belle*, *Phys. Rev. Lett.* **99** (2007) 191807 [[arXiv:0706.4429](#)] [[INSPIRE](#)].
- [33] BELLE collaboration, *Observation of $B^+ \rightarrow \bar{D}^{*0}\tau^+\nu_\tau$ and evidence for $B^+ \rightarrow \bar{D}^0\tau^+\nu_\tau$ at Belle*, *Phys. Rev.* **D 82** (2010) 072005 [[arXiv:1005.2302](#)] [[INSPIRE](#)].
- [34] BELLE collaboration, *Measurement of the branching ratio of $\bar{B} \rightarrow D^{(*)}\tau^-\bar{\nu}_\tau$ relative to $\bar{B} \rightarrow D^{(*)}\ell^-\bar{\nu}_\ell$ decays with hadronic tagging at Belle*, *Phys. Rev.* **D 92** (2015) 072014 [[arXiv:1507.03233](#)] [[INSPIRE](#)].
- [35] BELLE collaboration, *Measurement of the τ lepton polarization and $R(D^*)$ in the decay $\bar{B} \rightarrow D^{*}\tau^-\bar{\nu}_\tau$* , *Phys. Rev. Lett.* **118** (2017) 211801 [[arXiv:1612.00529](#)] [[INSPIRE](#)].
- [36] LHCb collaboration, *Measurement of form-factor-independent observables in the decay $B^0 \rightarrow K^{*0}\mu^+\mu^-$* , *Phys. Rev. Lett.* **111** (2013) 191801 [[arXiv:1308.1707](#)] [[INSPIRE](#)].
- [37] LHCb collaboration, *Test of lepton universality using $B^+ \rightarrow K^+\ell^+\ell^-$ decays*, *Phys. Rev. Lett.* **113** (2014) 151601 [[arXiv:1406.6482](#)] [[INSPIRE](#)].

- [38] LHCb collaboration, *Measurement of the ratio of branching fractions $\mathcal{B}(\bar{B}^0 \rightarrow D^{*+}\tau^-\bar{\nu}_\tau)/\mathcal{B}(\bar{B}^0 \rightarrow D^{*+}\mu^-\bar{\nu}_\mu)$* , *Phys. Rev. Lett.* **115** (2015) 111803 [Erratum *ibid.* **115** (2015) 159901] [[arXiv:1506.08614](#)] [[INSPIRE](#)].
- [39] LHCb collaboration, *Angular analysis of the $B^0 \rightarrow K^{*0}\mu^+\mu^-$ decay using 3 fb^{-1} of integrated luminosity*, *JHEP* **02** (2016) 104 [[arXiv:1512.04442](#)] [[INSPIRE](#)].
- [40] LHCb collaboration, *Test of lepton universality with $B^0 \rightarrow K^{*0}\ell^+\ell^-$ decays*, *JHEP* **08** (2017) 055 [[arXiv:1705.05802](#)] [[INSPIRE](#)].
- [41] M. Tanaka and R. Watanabe, *New physics in the weak interaction of $\bar{B} \rightarrow D^{(*)}\tau\bar{\nu}$* , *Phys. Rev. D* **87** (2013) 034028 [[arXiv:1212.1878](#)] [[INSPIRE](#)].
- [42] Y. Sakaki, M. Tanaka, A. Tayduganov and R. Watanabe, *Testing leptoquark models in $\bar{B} \rightarrow D^{(*)}\tau\bar{\nu}$* , *Phys. Rev. D* **88** (2013) 094012 [[arXiv:1309.0301](#)] [[INSPIRE](#)].
- [43] I. Doršner, S. Fajfer, N. Košnik and I. Nišandžić, *Minimally flavored colored scalar in $\bar{B} \rightarrow D^{(*)}\tau\bar{\nu}$ and the mass matrices constraints*, *JHEP* **11** (2013) 084 [[arXiv:1306.6493](#)] [[INSPIRE](#)].
- [44] B. Gripaios, M. Nardecchia and S.A. Renner, *Composite leptoquarks and anomalies in B -meson decays*, *JHEP* **05** (2015) 006 [[arXiv:1412.1791](#)] [[INSPIRE](#)].
- [45] ATLAS collaboration, *Search for heavy neutrinos and right-handed W bosons in events with two leptons and jets in pp collisions at $\sqrt{s} = 7\text{ TeV}$ with the ATLAS detector*, *Eur. Phys. J. C* **72** (2012) 2056 [[arXiv:1203.5420](#)] [[INSPIRE](#)].
- [46] ATLAS collaboration, *Search for heavy Majorana neutrinos with the ATLAS detector in pp collisions at $\sqrt{s} = 8\text{ TeV}$* , *JHEP* **07** (2015) 162 [[arXiv:1506.06020](#)] [[INSPIRE](#)].
- [47] ATLAS collaboration, *Search for third generation scalar leptoquarks in pp collisions at $\sqrt{s} = 7\text{ TeV}$ with the ATLAS detector*, *JHEP* **06** (2013) 033 [[arXiv:1303.0526](#)] [[INSPIRE](#)].
- [48] CMS collaboration, *Search for a heavy right-handed W boson and a heavy neutrino in events with two same-flavor leptons and two jets at $\sqrt{s} = 13\text{ TeV}$* , *JHEP* **05** (2018) 148 [[arXiv:1803.11116](#)] [[INSPIRE](#)].
- [49] CMS collaboration, *Search for a heavy composite Majorana neutrino in the final state with two leptons and two quarks at $\sqrt{s} = 13\text{ TeV}$* , *Phys. Lett. B* **775** (2017) 315 [[arXiv:1706.08578](#)] [[INSPIRE](#)].
- [50] CMS collaboration, *Search for third-generation scalar leptoquarks and heavy right-handed neutrinos in final states with two τ leptons and two jets in proton-proton collisions at $\sqrt{s} = 13\text{ TeV}$* , *JHEP* **07** (2017) 121 [[arXiv:1703.03995](#)] [[INSPIRE](#)].
- [51] CMS collaboration, *Search for heavy neutrinos or third-generation leptoquarks in final states with two hadronically decaying τ leptons and two jets in proton-proton collisions at $\sqrt{s} = 13\text{ TeV}$* , *JHEP* **03** (2017) 077 [[arXiv:1612.01190](#)] [[INSPIRE](#)].
- [52] CMS collaboration, *Search for heavy neutrinos and W bosons with right-handed couplings in proton-proton collisions at $\sqrt{s} = 8\text{ TeV}$* , *Eur. Phys. J. C* **74** (2014) 3149 [[arXiv:1407.3683](#)] [[INSPIRE](#)].
- [53] CMS collaboration, *Search for third-generation scalar leptoquarks decaying to a top quark and a τ lepton at $\sqrt{s} = 13\text{ TeV}$* , *Eur. Phys. J. C* **78** (2018) 707 [[arXiv:1803.02864](#)] [[INSPIRE](#)].
- [54] CMS collaboration, *Constraints on models of scalar and vector leptoquarks decaying to a quark and a neutrino at $\sqrt{s} = 13\text{ TeV}$* , *Phys. Rev. D* **98** (2018) 032005 [[arXiv:1805.10228](#)] [[INSPIRE](#)].

- [55] CMS collaboration, *Search for a singly produced third-generation scalar leptoquark decaying to a τ lepton and a bottom quark in proton-proton collisions at $\sqrt{s} = 13$ TeV*, *JHEP* **07** (2018) 115 [[arXiv:1806.03472](#)] [[INSPIRE](#)].
- [56] CMS collaboration, *The CMS experiment at the CERN LHC*, *2008 JINST* **03** S08004.
- [57] CMS collaboration, *Particle-flow reconstruction and global event description with the CMS detector*, *2017 JINST* **12** P10003 [[arXiv:1706.04965](#)] [[INSPIRE](#)].
- [58] M. Cacciari, G.P. Salam and G. Soyez, *The anti- k_t jet clustering algorithm*, *JHEP* **04** (2008) 063 [[arXiv:0802.1189](#)] [[INSPIRE](#)].
- [59] CMS collaboration, *Jet algorithms performance in 13 TeV data*, *CMS-PAS-JME-16-003* (2016).
- [60] CMS collaboration, *Determination of jet energy calibration and transverse momentum resolution in CMS*, *2011 JINST* **6** P11002 [[arXiv:1107.4277](#)] [[INSPIRE](#)].
- [61] CMS collaboration, *Study of pileup removal algorithms for jets*, *CMS-PAS-JME-16-001* (2016).
- [62] CMS collaboration, *Identification of heavy-flavour jets with the CMS detector in pp collisions at 13 TeV*, *2018 JINST* **13** P05011 [[arXiv:1712.07158](#)] [[INSPIRE](#)].
- [63] CMS collaboration, *Performance of electron reconstruction and selection with the CMS detector in proton-proton collisions at $\sqrt{s} = 8$ TeV*, *2015 JINST* **10** P06005 [[arXiv:1502.02701](#)] [[INSPIRE](#)].
- [64] CMS collaboration, *Performance of the CMS muon detector and muon reconstruction with proton-proton collisions at $\sqrt{s} = 13$ TeV*, *2018 JINST* **13** P06015 [[arXiv:1804.04528](#)] [[INSPIRE](#)].
- [65] M. Cacciari and G.P. Salam, *Pileup subtraction using jet areas*, *Phys. Lett. B* **659** (2008) 119 [[arXiv:0707.1378](#)] [[INSPIRE](#)].
- [66] M. Cacciari, G.P. Salam and G. Soyez, *FastJet user manual*, *Eur. Phys. J. C* **72** (2012) 1896 [[arXiv:1111.6097](#)] [[INSPIRE](#)].
- [67] CMS collaboration, *Performance of reconstruction and identification of τ leptons decaying to hadrons and ν_τ in pp collisions at $\sqrt{s} = 13$ TeV*, *2018 JINST* **13** P10005 [[arXiv:1809.02816](#)] [[INSPIRE](#)].
- [68] CMS collaboration, *Performance of missing transverse momentum in pp collisions at $\sqrt{s} = 13$ TeV using the CMS detector*, *CMS-PAS-JME-17-001* (2017).
- [69] J. Alwall et al., *The automated computation of tree-level and next-to-leading order differential cross sections and their matching to parton shower simulations*, *JHEP* **07** (2014) 079 [[arXiv:1405.0301](#)] [[INSPIRE](#)].
- [70] T. Sjöstrand et al., *An introduction to PYTHIA 8.2*, *Comput. Phys. Commun.* **191** (2015) 159 [[arXiv:1410.3012](#)] [[INSPIRE](#)].
- [71] CMS collaboration, *Event generator tunes obtained from underlying event and multiparton scattering measurements*, *Eur. Phys. J. C* **76** (2016) 155 [[arXiv:1512.00815](#)] [[INSPIRE](#)].
- [72] M. Krämer, T. Plehn, M. Spira and P.M. Zerwas, *Pair production of scalar leptoquarks at the CERN LHC*, *Phys. Rev. D* **71** (2005) 057503 [[hep-ph/0411038](#)] [[INSPIRE](#)].
- [73] F. del Aguila, J.A. Aguilar-Saavedra and R. Pittau, *Heavy neutrino signals at large hadron colliders*, *JHEP* **10** (2007) 047 [[hep-ph/0703261](#)] [[INSPIRE](#)].

- [74] J. Pumplin, et al. *New generation of parton distributions with uncertainties from global QCD analysis*, *JHEP* **07** (2002) 012 [[hep-ph/0201195](#)] [[INSPIRE](#)].
- [75] CMS collaboration, *Measurement of the Inclusive Z Cross Section via Decays to Tau Pairs in pp Collisions at $\sqrt{s} = 7$ TeV*, *JHEP* **08** (2011) 117 [[arXiv:1104.1617](#)] [[INSPIRE](#)].
- [76] CMS collaboration, *CMS luminosity measurements for the 2016 data taking period*, [CMS-PAS-LUM-17-001](#) (2017).
- [77] J. Butterworth et al., *PDF4LHC recommendations for LHC Run II*, *J. Phys.* **G** **43** (2016) 023001 [[arXiv:1510.03865](#)] [[INSPIRE](#)].
- [78] S. Alekhin et al., *The PDF4LHC working group interim report*, [arXiv:1101.0536](#) [[INSPIRE](#)].
- [79] M. Botje et al., *The PDF4LHC working group interim recommendations*, [arXiv:1101.0538](#) [[INSPIRE](#)].
- [80] T. Junk, *Confidence level computation for combining searches with small statistics*, *Nucl. Instrum. Meth.* **A** **434** (1999) 435 [[hep-ex/9902006](#)] [[INSPIRE](#)].
- [81] A.L. Read, *Presentation of search results: the CL_s technique*, *J. Phys.* **G** **28** (2002) 2693 [[INSPIRE](#)].
- [82] ATLAS and CMS collaborations and The LHC Higgs Combination Group, *Procedure for the LHC Higgs boson search combination in Summer 2011*, [CMS-NOTE-2011-005](#) (2011).
- [83] R.J. Barlow and C. Beeston, *Fitting using finite Monte Carlo samples*, *Comput. Phys. Commun.* **77** (1993) 219 [[INSPIRE](#)].

The CMS collaboration

Yerevan Physics Institute, Yerevan, Armenia

A.M. Sirunyan, A. Tumasyan

Institut für Hochenergiephysik, Wien, Austria

W. Adam, F. Ambrogio, E. Asilar, T. Bergauer, J. Brandstetter, M. Dragicevic, J. Erö, A. Escalante Del Valle, M. Flechl, R. Frühwirth¹, V.M. Ghete, J. Hrubec, M. Jeitler¹, N. Krammer, I. Krätschmer, D. Liko, T. Madlener, I. Mikulec, N. Rad, H. Rohringer, J. Schieck¹, R. Schöffbeck, M. Spanring, D. Spitzbart, A. Taurok, W. Waltenberger, J. Wittmann, C.-E. Wulz¹, M. Zarucki

Institute for Nuclear Problems, Minsk, Belarus

V. Chekhovsky, V. Mossolov, J. Suarez Gonzalez

Universiteit Antwerpen, Antwerpen, Belgium

E.A. De Wolf, D. Di Croce, X. Janssen, J. Lauwers, M. Pieters, H. Van Haevermaet, P. Van Mechelen, N. Van Remortel

Vrije Universiteit Brussel, Brussel, Belgium

S. Abu Zeid, F. Blekman, J. D'Hondt, J. De Clercq, K. Deroover, G. Flouris, D. Lonkowskyi, S. Lowette, I. Marchesini, S. Moortgat, L. Moreels, Q. Python, K. Skovpen, S. Tavernier, W. Van Doninck, P. Van Mulders, I. Van Parijs

Université Libre de Bruxelles, Bruxelles, Belgium

D. Beghin, B. Bilin, H. Brun, B. Clerbaux, G. De Lentdecker, H. Delannoy, B. Dorney, G. Fasanella, L. Favart, R. Goldouzian, A. Grebenyuk, A.K. Kalsi, T. Lenzi, J. Luetic, N. Postiau, E. Starling, L. Thomas, C. Vander Velde, P. Vanlaer, D. Vannerom, Q. Wang

Ghent University, Ghent, Belgium

T. Cornelis, D. Dobur, A. Fagot, M. Gul, I. Khvastunov², D. Poyraz, C. Roskas, D. Trocino, M. Tytgat, W. Verbeke, B. Vermassen, M. Vit, N. Zaganidis

Université Catholique de Louvain, Louvain-la-Neuve, Belgium

H. Bakhshiansohi, O. Bondu, S. Brochet, G. Bruno, C. Caputo, P. David, C. Delaere, M. Delcourt, A. Giammanco, G. Krintiras, V. Lemaitre, A. Magitteri, K. Piotrkowski, A. Saggio, M. Vidal Marono, S. Wertz, J. Zobec

Centro Brasileiro de Pesquisas Fisicas, Rio de Janeiro, Brazil

F.L. Alves, G.A. Alves, M. Correa Martins Junior, G. Correia Silva, C. Hensel, A. Moraes, M.E. Pol, P. Rebello Teles

Universidade do Estado do Rio de Janeiro, Rio de Janeiro, Brazil

E. Belchior Batista Das Chagas, W. Carvalho, J. Chinellato³, E. Coelho, E.M. Da Costa, G.G. Da Silveira⁴, D. De Jesus Damiao, C. De Oliveira Martins, S. Fonseca De Souza, H. Malbouisson, D. Matos Figueiredo, M. Melo De Almeida, C. Mora Herrera, L. Mundim, H. Nogima, W.L. Prado Da Silva, L.J. Sanchez Rosas, A. Santoro, A. Sznajder, M. Thiel, E.J. Tonelli Manganote³, F. Torres Da Silva De Araujo, A. Vilela Pereira

Universidade Estadual Paulista^a, Universidade Federal do ABC^b, São Paulo, Brazil

S. Ahuja^a, C.A. Bernardes^a, L. Calligaris^a, T.R. Fernandez Perez Tomei^a, E.M. Gregores^b, P.G. Mercadante^b, S.F. Novaes^a, SandraS. Padula^a

Institute for Nuclear Research and Nuclear Energy, Bulgarian Academy of Sciences, Sofia, Bulgaria

A. Aleksandrov, R. Hadjiiska, P. Iaydjiev, A. Marinov, M. Misheva, M. Rodozov, M. Shopova, G. Sultanov

University of Sofia, Sofia, Bulgaria

A. Dimitrov, L. Litov, B. Pavlov, P. Petkov

Beihang University, Beijing, China

W. Fang⁵, X. Gao⁵, L. Yuan

Institute of High Energy Physics, Beijing, China

M. Ahmad, J.G. Bian, G.M. Chen, H.S. Chen, M. Chen, Y. Chen, C.H. Jiang, D. Leggat, H. Liao, Z. Liu, F. Romeo, S.M. Shaheen⁶, A. Spiezia, J. Tao, Z. Wang, E. Yazgan, H. Zhang, S. Zhang⁶, J. Zhao

State Key Laboratory of Nuclear Physics and Technology, Peking University, Beijing, China

Y. Ban, G. Chen, A. Levin, J. Li, L. Li, Q. Li, Y. Mao, S.J. Qian, D. Wang

Tsinghua University, Beijing, China

Y. Wang

Universidad de Los Andes, Bogota, Colombia

C. Avila, A. Cabrera, C.A. Carrillo Montoya, L.F. Chaparro Sierra, C. Florez, C.F. González Hernández, M.A. Segura Delgado

University of Split, Faculty of Electrical Engineering, Mechanical Engineering and Naval Architecture, Split, Croatia

B. Courbon, N. Godinovic, D. Lelas, I. Puljak, T. Sculac

University of Split, Faculty of Science, Split, Croatia

Z. Antunovic, M. Kovac

Institute Rudjer Boskovic, Zagreb, Croatia

V. Brigljevic, D. Ferencek, K. Kadija, B. Mesic, A. Starodumov⁷, T. Susa

University of Cyprus, Nicosia, Cyprus

M.W. Ather, A. Attikis, M. Kolosova, G. Mavromanolakis, J. Mousa, C. Nicolaou, F. Ptochos, P.A. Razis, H. Rykaczewski

Charles University, Prague, Czech Republic

M. Finger⁸, M. Finger Jr.⁸

Escuela Politecnica Nacional, Quito, Ecuador

E. Ayala

Universidad San Francisco de Quito, Quito, Ecuador

E. Carrera Jarrin

**Academy of Scientific Research and Technology of the Arab Republic of Egypt,
Egyptian Network of High Energy Physics, Cairo, Egypt**

Y. Assran^{9,10}, S. Elgammal¹⁰, A. Ellithi Kamel¹¹

National Institute of Chemical Physics and Biophysics, Tallinn, Estonia

S. Bhowmik, A. Carvalho Antunes De Oliveira, R.K. Dewanjee, K. Ehataht, M. Kadastik,
M. Raidal, C. Veelken

Department of Physics, University of Helsinki, Helsinki, Finland

P. Eerola, H. Kirschenmann, J. Pekkanen, M. Voutilainen

Helsinki Institute of Physics, Helsinki, Finland

J. Havukainen, J.K. Heikkilä, T. Järvinen, V. Karimäki, R. Kinnunen, T. Lampén,
K. Lassila-Perini, S. Laurila, S. Lehti, T. Lindén, P. Luukka, T. Mäenpää, H. Siikonen,
E. Tuominen, J. Tuominiemi

Lappeenranta University of Technology, Lappeenranta, Finland

T. Tuuva

IRFU, CEA, Université Paris-Saclay, Gif-sur-Yvette, France

M. Besancon, F. Couderc, M. Dejardin, D. Denegri, J.L. Faure, F. Ferri, S. Ganjour,
A. Givernaud, P. Gras, G. Hamel de Monchenault, P. Jarry, C. Leloup, E. Locci, J. Malcles,
G. Negro, J. Rander, A. Rosowsky, M.Ö. Sahin, M. Titov

**Laboratoire Leprince-Ringuet, Ecole polytechnique, CNRS/IN2P3, Université
Paris-Saclay, Palaiseau, France**

A. Abdulsalam¹², C. Amendola, I. Antropov, F. Beaudette, P. Busson, C. Charlot,
R. Granier de Cassagnac, I. Kucher, A. Lobanov, J. Martin Blanco, C. Martin Perez,
M. Nguyen, C. Ochando, G. Ortona, P. Paganini, P. Pigard, J. Rembser, R. Salerno,
J.B. Sauvan, Y. Sirois, A.G. Stahl Leiton, A. Zabi, A. Zghiche

Université de Strasbourg, CNRS, IPHC UMR 7178, Strasbourg, France

J.-L. Agram¹³, J. Andrea, D. Bloch, J.-M. Brom, E.C. Chabert, V. Cherepanov, C. Collard,
E. Conte¹³, J.-C. Fontaine¹³, D. Gelé, U. Goerlach, M. Jansová, A.-C. Le Bihan, N. Tonon,
P. Van Hove

**Centre de Calcul de l'Institut National de Physique Nucleaire et de Physique
des Particules, CNRS/IN2P3, Villeurbanne, France**

S. Gadrat

Université de Lyon, Université Claude Bernard Lyon 1, CNRS-IN2P3, Institut de Physique Nucléaire de Lyon, Villeurbanne, France

S. Beauceron, C. Bernet, G. Boudoul, N. Chanon, R. Chierici, D. Contardo, P. Depasse, H. El Mamouni, J. Fay, L. Finco, S. Gascon, M. Gouzevitch, G. Grenier, B. Ille, F. Lagarde, I.B. Laktineh, H. Lattaud, M. Lethuillier, L. Mirabito, S. Perries, A. Popov¹⁴, V. Sordini, G. Touquet, M. Vander Donckt, S. Viret

Georgian Technical University, Tbilisi, Georgia

T. Toriashvili¹⁵

Tbilisi State University, Tbilisi, Georgia

I. Bagaturia¹⁶

RWTH Aachen University, I. Physikalisches Institut, Aachen, Germany

C. Autermann, L. Feld, M.K. Kiesel, K. Klein, M. Lipinski, M. Preuten, M.P. Rauch, C. Schomakers, J. Schulz, M. Teroerde, B. Wittmer

RWTH Aachen University, III. Physikalisches Institut A, Aachen, Germany

A. Albert, D. Duchardt, M. Erdmann, S. Erdweg, T. Esch, R. Fischer, S. Ghosh, A. Güth, T. Hebbeker, C. Heidemann, K. Hoepfner, H. Keller, L. Mastrolorenzo, M. Merschmeyer, A. Meyer, P. Millet, S. Mukherjee, T. Pook, M. Radziej, H. Reithler, M. Rieger, A. Schmidt, D. Teyssier, S. Thüer

RWTH Aachen University, III. Physikalisches Institut B, Aachen, Germany

G. Flügge, O. Hlushchenko, T. Kress, T. Müller, A. Nehr Korn, A. Nowack, C. Pistone, O. Pooth, D. Roy, H. Sert, A. Stahl¹⁷

Deutsches Elektronen-Synchrotron, Hamburg, Germany

M. Aldaya Martin, T. Arndt, C. Asawatangtrakuldee, I. Babounikau, K. Beernaert, O. Behnke, U. Behrens, A. Bermúdez Martínez, D. Bertsche, A.A. Bin Anuar, K. Borras¹⁸, V. Botta, A. Campbell, P. Connor, C. Contreras-Campana, V. Danilov, A. De Wit, M.M. Defranchis, C. Diez Pardos, D. Domínguez Damiani, G. Eckerlin, T. Eichhorn, A. Elwood, E. Eren, E. Gallo¹⁹, A. Geiser, J.M. Grados Luyando, A. Grohsjean, M. Guthoff, M. Haranko, A. Harb, J. Hauk, H. Jung, M. Kasemann, J. Keaveney, C. Kleinwort, J. Knolle, D. Krücker, W. Lange, A. Lelek, T. Lenz, J. Leonard, K. Lipka, W. Lohmann²⁰, R. Mankel, I.-A. Melzer-Pellmann, A.B. Meyer, M. Meyer, M. Missiroli, G. Mittag, J. Mnich, V. Myronenko, S.K. Pfitsch, D. Pitzl, A. Raspereza, M. Savitskyi, P. Saxena, P. Schütze, C. Schwanenberger, R. Shevchenko, A. Singh, H. Tholen, O. Turkot, A. Vagnerini, G.P. Van Onsem, R. Walsh, Y. Wen, K. Wichmann, C. Wissing, O. Zenaiev

University of Hamburg, Hamburg, Germany

R. Aggleton, S. Bein, L. Benato, A. Benecke, V. Blobel, T. Dreyer, A. Ebrahimi, E. Garutti, D. Gonzalez, P. Gunnellini, J. Haller, A. Hinzmann, A. Karavdina, G. Kasieczka, R. Klaner, R. Kogler, N. Kovalchuk, S. Kurz, V. Kutzner, J. Lange, D. Marconi, J. Multhaup, M. Niedziela, C.E.N. Niemeyer, D. Nowatschin, A. Perieanu, A. Reimers, O. Rieger, C. Scharf, P. Schleper, S. Schumann, J. Schwandt, J. Sonneveld, H. Stadie, G. Steinbrück, F.M. Stober, M. Stöver, A. Vanhoefer, B. Vormwald, I. Zoi

Karlsruher Institut fuer Technologie, Karlsruhe, Germany

M. Akbiyik, C. Barth, M. Baselga, S. Baur, E. Butz, R. Caspart, T. Chwalek, F. Colombo, W. De Boer, A. Dierlamm, K. El Morabit, N. Faltermann, B. Freund, M. Giffels, M.A. Harrendorf, F. Hartmann¹⁷, S.M. Heindl, U. Husemann, I. Katkov¹⁴, S. Kudella, S. Mitra, M.U. Mozer, Th. Müller, M. Musich, M. Plagge, G. Quast, K. Rabbertz, M. Schröder, I. Shvetsov, H.J. Simonis, R. Ulrich, S. Wayand, M. Weber, T. Weiler, C. Wöhrmann, R. Wolf

Institute of Nuclear and Particle Physics (INPP), NCSR Demokritos, Aghia Paraskevi, Greece

G. Anagnostou, G. Daskalakis, T. Gerasis, A. Kyriakis, D. Loukas, G. Paspalaki

National and Kapodistrian University of Athens, Athens, Greece

G. Karathanasis, P. Kontaxakis, A. Panagiotou, I. Papavergou, N. Saoulidou, E. Tziaferi, K. Vellidis

National Technical University of Athens, Athens, Greece

K. Kousouris, I. Papakrivopoulos, G. Tsipolitis

University of Ioánnina, Ioánnina, Greece

I. Evangelou, C. Foudas, P. Gianneios, P. Katsoulis, P. Kokkas, S. Mallios, N. Manthos, I. Papadopoulos, E. Paradass, J. Strologas, F.A. Triantis, D. Tsitsonis

MTA-ELTE Lendület CMS Particle and Nuclear Physics Group, Eötvös Loránd University, Budapest, Hungary

M. Bartók²¹, M. Csanad, N. Filipovic, P. Major, M.I. Nagy, G. Pasztor, O. Surányi, G.I. Veres

Wigner Research Centre for Physics, Budapest, Hungary

G. Bencze, C. Hajdu, D. Horvath²², Á. Hunyadi, F. Sikler, T.Á. Vámi, V. Veszpremi, G. Vesztergombi[†]

Institute of Nuclear Research ATOMKI, Debrecen, Hungary

N. Beni, S. Czellar, J. Karancsi²¹, A. Makovec, J. Molnar, Z. Szillasi

Institute of Physics, University of Debrecen, Debrecen, Hungary

P. Raics, Z.L. Trocsanyi, B. Ujvari

Indian Institute of Science (IISc), Bangalore, India

S. Choudhury, J.R. Komaragiri, P.C. Tiwari

National Institute of Science Education and Research, HBNI, Bhubaneswar, India

S. Bahinipati²⁴, C. Kar, P. Mal, K. Mandal, A. Nayak²⁵, D.K. Sahoo²⁴, S.K. Swain

Panjab University, Chandigarh, India

S. Bansal, S.B. Beri, V. Bhatnagar, S. Chauhan, R. Chawla, N. Dhingra, R. Gupta, A. Kaur, M. Kaur, S. Kaur, P. Kumari, M. Lohan, A. Mehta, K. Sandeep, S. Sharma, J.B. Singh, A.K. Viridi, G. Walia

University of Delhi, Delhi, India

A. Bhardwaj, B.C. Choudhary, R.B. Garg, M. Gola, S. Keshri, Ashok Kumar, S. Malhotra, M. Naimuddin, P. Priyanka, K. Ranjan, Aashaq Shah, R. Sharma

Saha Institute of Nuclear Physics, HBNI, Kolkata, India

R. Bhardwaj²⁶, M. Bharti²⁶, R. Bhattacharya, S. Bhattacharya, U. Bhawandeep²⁶, D. Bhowmik, S. Dey, S. Dutt²⁶, S. Dutta, S. Ghosh, K. Mondal, S. Nandan, A. Purohit, P.K. Rout, A. Roy, S. Roy Chowdhury, G. Saha, S. Sarkar, M. Sharan, B. Singh²⁶, S. Thakur²⁶

Indian Institute of Technology Madras, Madras, India

P.K. Behera

Bhabha Atomic Research Centre, Mumbai, India

R. Chudasama, D. Dutta, V. Jha, V. Kumar, P.K. Netrakanti, L.M. Pant, P. Shukla

Tata Institute of Fundamental Research-A, Mumbai, India

T. Aziz, M.A. Bhat, S. Dugad, G.B. Mohanty, N. Sur, B. Sutar, RavindraKumar Verma

Tata Institute of Fundamental Research-B, Mumbai, India

S. Banerjee, S. Bhattacharya, S. Chatterjee, P. Das, M. Guchait, Sa. Jain, S. Karmakar, S. Kumar, M. Maity²⁷, G. Majumder, K. Mazumdar, N. Sahoo, T. Sarkar²⁷

Indian Institute of Science Education and Research (IISER), Pune, India

S. Chauhan, S. Dube, V. Hegde, A. Kapoor, K. Kotheekar, S. Pandey, A. Rane, A. Rastogi, S. Sharma

Institute for Research in Fundamental Sciences (IPM), Tehran, Iran

S. Chenarani²⁸, E. Eskandari Tadavani, S.M. Etesami²⁸, M. Khakzad, M. Mohammadi Najafabadi, M. Naseri, F. Rezaei Hosseinabadi, B. Safarzadeh²⁹, M. Zeinali

University College Dublin, Dublin, Ireland

M. Felcini, M. Grunewald

INFN Sezione di Bari^a, Università di Bari^b, Politecnico di Bari^c, Bari, Italy

M. Abbrescia^{a,b}, C. Calabria^{a,b}, A. Colaleo^a, D. Creanza^{a,c}, L. Cristella^{a,b}, N. De Filippis^{a,c}, M. De Palma^{a,b}, A. Di Florio^{a,b}, F. Errico^{a,b}, L. Fiore^a, A. Gelmi^{a,b}, G. Iaselli^{a,c}, M. Ince^{a,b}, S. Lezki^{a,b}, G. Maggi^{a,c}, M. Maggi^a, G. Miniello^{a,b}, S. My^{a,b}, S. Nuzzo^{a,b}, A. Pompili^{a,b}, G. Pugliese^{a,c}, R. Radogna^a, A. Ranieri^a, G. Selvaggi^{a,b}, A. Sharma^a, L. Silvestris^a, R. Venditti^a, P. Verwilligen^a, G. Zito^a

INFN Sezione di Bologna^a, Università di Bologna^b, Bologna, Italy

G. Abbiendi^a, C. Battilana^{a,b}, D. Bonacorsi^{a,b}, L. Borgonovi^{a,b}, S. Braibant-Giacomelli^{a,b}, R. Campanini^{a,b}, P. Capiluppi^{a,b}, A. Castro^{a,b}, F.R. Cavallo^a, S.S. Chhibra^{a,b}, C. Ciocca^a, G. Codispoti^{a,b}, M. Cuffiani^{a,b}, G.M. Dallavalle^a, F. Fabbri^a, A. Fanfani^{a,b}, E. Fontanesi, P. Giacomelli^a, C. Grandi^a, L. Guiducci^{a,b}, S. Lo Meo^a, S. Marcellini^a, G. Masetti^a, A. Montanari^a, F.L. Navarria^{a,b}, A. Perrotta^a, F. Primavera^{a,b,17}, A.M. Rossi^{a,b}, T. Rovelli^{a,b}, G.P. Siroli^{a,b}, N. Tosi^a

INFN Sezione di Catania^a, Università di Catania^b, Catania, ItalyS. Albergo^{a,b}, A. Di Mattia^a, R. Potenza^{a,b}, A. Tricoli^{a,b}, C. Tuve^{a,b}**INFN Sezione di Firenze^a, Università di Firenze^b, Firenze, Italy**G. Barbagli^a, K. Chatterjee^{a,b}, V. Ciulli^{a,b}, C. Civinini^a, R. D'Alessandro^{a,b}, E. Focardi^{a,b}, G. Latino, P. Lenzi^{a,b}, M. Meschini^a, S. Paoletti^a, L. Russo^{a,30}, G. Sguazzoni^a, D. Strom^a, L. Viliani^a**INFN Laboratori Nazionali di Frascati, Frascati, Italy**

L. Benussi, S. Bianco, F. Fabbri, D. Piccolo

INFN Sezione di Genova^a, Università di Genova^b, Genova, ItalyF. Ferro^a, R. Mulargia^{a,b}, F. Ravera^{a,b}, E. Robutti^a, S. Tosi^{a,b}**INFN Sezione di Milano-Bicocca^a, Università di Milano-Bicocca^b, Milano, Italy**A. Benaglia^a, A. Beschi^b, F. Brivio^{a,b}, V. Ciriolo^{a,b,17}, S. Di Guida^{a,d,17}, M.E. Dinardo^{a,b}, S. Fiorendi^{a,b}, S. Gennai^a, A. Ghezzi^{a,b}, P. Govoni^{a,b}, M. Malberti^{a,b}, S. Malvezzi^a, A. Massironi^{a,b}, D. Menasce^a, F. Monti, L. Moroni^a, M. Paganoni^{a,b}, D. Pedrini^a, S. Ragazzi^{a,b}, T. Tabarelli de Fatis^{a,b}, D. Zuolo^{a,b}**INFN Sezione di Napoli^a, Università di Napoli 'Federico II'^b, Napoli, Italy, Università della Basilicata^c, Potenza, Italy, Università G. Marconi^d, Roma, Italy**S. Buontempo^a, N. Cavallo^{a,c}, A. De Iorio^{a,b}, A. Di Crescenzo^{a,b}, F. Fabozzi^{a,c}, F. Fienga^a, G. Galati^a, A.O.M. Iorio^{a,b}, W.A. Khan^a, L. Lista^a, S. Meola^{a,d,17}, P. Paolucci^{a,17}, C. Sciacca^{a,b}, E. Voevodina^{a,b}**INFN Sezione di Padova^a, Università di Padova^b, Padova, Italy, Università di Trento^c, Trento, Italy**P. Azzi^a, N. Bacchetta^a, D. Bisello^{a,b}, A. Boletti^{a,b}, A. Bragagnolo, R. Carlin^{a,b}, P. Checchia^a, M. Dall'Osso^{a,b}, P. De Castro Manzano^a, T. Dorigo^a, U. Dosselli^a, F. Gasparini^{a,b}, U. Gasparini^{a,b}, A. Gozzelino^a, S.Y. Hoh, S. Lacaprara^a, P. Lujan, M. Margoni^{a,b}, A.T. Meneguzzo^{a,b}, J. Pazzini^{a,b}, P. Ronchese^{a,b}, R. Rossin^{a,b}, F. Simonetto^{a,b}, A. Tiko, E. Torassa^a, M. Tosi^{a,b}, M. Zanetti^{a,b}, P. Zotto^{a,b}, G. Zumerle^{a,b}**INFN Sezione di Pavia^a, Università di Pavia^b, Pavia, Italy**A. Braghieri^a, A. Magnani^a, P. Montagna^{a,b}, S.P. Ratti^{a,b}, V. Re^a, M. Ressegotti^{a,b}, C. Riccardi^{a,b}, P. Salvini^a, I. Vai^{a,b}, P. Vitulo^{a,b}**INFN Sezione di Perugia^a, Università di Perugia^b, Perugia, Italy**M. Biasini^{a,b}, G.M. Bilei^a, C. Cecchi^{a,b}, D. Ciangottini^{a,b}, L. Fanò^{a,b}, P. Lariccia^{a,b}, R. Leonardi^{a,b}, E. Manoni^a, G. Mantovani^{a,b}, V. Mariani^{a,b}, M. Menichelli^a, A. Rossi^{a,b}, A. Santocchia^{a,b}, D. Spiga^a**INFN Sezione di Pisa^a, Università di Pisa^b, Scuola Normale Superiore di Pisa^c, Pisa, Italy**K. Androsov^a, P. Azzurri^a, G. Bagliesi^a, L. Bianchini^a, T. Boccali^a, L. Borrello, R. Castaldi^a, M.A. Ciocci^{a,b}, R. Dell'Orso^a, G. Fedi^a, F. Fiori^{a,c}, L. Giannini^{a,c}, A. Giassi^a,

M.T. Grippo^a, F. Ligabue^{a,c}, E. Manca^{a,c}, G. Mandorli^{a,c}, A. Messineo^{a,b}, F. Palla^a, A. Rizzi^{a,b}, G. Rolandi³¹, P. Spagnolo^a, R. Tenchini^a, G. Tonelli^{a,b}, A. Venturi^a, P.G. Verdini^a

INFN Sezione di Roma^a, Sapienza Università di Roma^b, Rome, Italy

L. Barone^{a,b}, F. Cavallari^a, M. Cipriani^{a,b}, D. Del Re^{a,b}, E. Di Marco^{a,b}, M. Diemoz^a, S. Gelli^{a,b}, E. Longo^{a,b}, B. Marzocchi^{a,b}, P. Meridiani^a, G. Organtini^{a,b}, F. Pandolfi^a, R. Paramatti^{a,b}, F. Preiato^{a,b}, S. Rahatlou^{a,b}, C. Rovelli^a, F. Santanastasio^{a,b}

INFN Sezione di Torino^a, Università di Torino^b, Torino, Italy, Università del Piemonte Orientale^c, Novara, Italy

N. Amapane^{a,b}, R. Arcidiacono^{a,c}, S. Argiro^{a,b}, M. Arneodo^{a,c}, N. Bartosik^a, R. Bellan^{a,b}, C. Biino^a, A. Cappati^{a,b}, N. Cartiglia^a, F. Cenna^{a,b}, S. Cometti^a, M. Costa^{a,b}, R. Covarelli^{a,b}, N. Demaria^a, B. Kiani^{a,b}, C. Mariotti^a, S. Maselli^a, E. Migliore^{a,b}, V. Monaco^{a,b}, E. Monteil^{a,b}, M. Monteno^a, M.M. Obertino^{a,b}, L. Pacher^{a,b}, N. Pastrone^a, M. Pelliccioni^a, G.L. Pinna Angioni^{a,b}, A. Romero^{a,b}, M. Ruspà^{a,c}, R. Sacchi^{a,b}, R. Salvatico^{a,b}, K. Shchelina^{a,b}, V. Sola^a, A. Solano^{a,b}, D. Soldi^{a,b}, A. Staiano^a

INFN Sezione di Trieste^a, Università di Trieste^b, Trieste, Italy

S. Belforte^a, V. Candelise^{a,b}, M. Casarsa^a, F. Cossutti^a, A. Da Rold^{a,b}, G. Della Ricca^{a,b}, F. Vazzoler^{a,b}, A. Zanetti^a

Kyungpook National University, Daegu, Korea

D.H. Kim, G.N. Kim, M.S. Kim, J. Lee, S. Lee, S.W. Lee, C.S. Moon, Y.D. Oh, S.I. Pak, S. Sekmen, D.C. Son, Y.C. Yang

Chonnam National University, Institute for Universe and Elementary Particles, Kwangju, Korea

H. Kim, D.H. Moon, G. Oh

Hanyang University, Seoul, Korea

B. Francois, J. Goh³², T.J. Kim

Korea University, Seoul, Korea

S. Cho, S. Choi, Y. Go, D. Gyun, S. Ha, B. Hong, Y. Jo, K. Lee, K.S. Lee, S. Lee, J. Lim, S.K. Park, Y. Roh

Sejong University, Seoul, Korea

H.S. Kim

Seoul National University, Seoul, Korea

J. Almond, J. Kim, J.S. Kim, H. Lee, K. Lee, K. Nam, S.B. Oh, B.C. Radburn-Smith, S.h. Seo, U.K. Yang, H.D. Yoo, G.B. Yu

University of Seoul, Seoul, Korea

D. Jeon, H. Kim, J.H. Kim, J.S.H. Lee, I.C. Park

Sungkyunkwan University, Suwon, Korea

Y. Choi, C. Hwang, J. Lee, I. Yu

Vilnius University, Vilnius, Lithuania

V. Dudenas, A. Juodagalvis, J. Vaitkus

National Centre for Particle Physics, Universiti Malaya, Kuala Lumpur, MalaysiaI. Ahmed, Z.A. Ibrahim, M.A.B. Md Ali³³, F. Mohamad Idris³⁴, W.A.T. Wan Abdullah, M.N. Yusli, Z. Zolkapli**Universidad de Sonora (UNISON), Hermosillo, Mexico**

J.F. Benitez, A. Castaneda Hernandez, J.A. Murillo Quijada

Centro de Investigacion y de Estudios Avanzados del IPN, Mexico City, MexicoH. Castilla-Valdez, E. De La Cruz-Burelo, M.C. Duran-Osuna, I. Heredia-De La Cruz³⁵, R. Lopez-Fernandez, J. Mejia Guisao, R.I. Rabadan-Trejo, M. Ramirez-Garcia, G. Ramirez-Sanchez, R. Reyes-Almanza, A. Sanchez-Hernandez**Universidad Iberoamericana, Mexico City, Mexico**

S. Carrillo Moreno, C. Oropeza Barrera, F. Vazquez Valencia

Benemerita Universidad Autonoma de Puebla, Puebla, Mexico

J. Eysermans, I. Pedraza, H.A. Salazar Ibarquen, C. Uribe Estrada

Universidad Autónoma de San Luis Potosí, San Luis Potosí, Mexico

A. Morelos Pineda

University of Auckland, Auckland, New Zealand

D. Krofcheck

University of Canterbury, Christchurch, New Zealand

S. Bheesette, P.H. Butler

National Centre for Physics, Quaid-I-Azam University, Islamabad, Pakistan

A. Ahmad, M. Ahmad, M.I. Asghar, Q. Hassan, H.R. Hoorani, A. Saddique, M.A. Shah, M. Shoaib, M. Waqas

National Centre for Nuclear Research, Swierk, Poland

H. Bialkowska, M. Bluj, B. Boimska, T. Frueboes, M. Górski, M. Kazana, M. Szeleper, P. Traczyk, P. Zalewski

Institute of Experimental Physics, Faculty of Physics, University of Warsaw, Warsaw, PolandK. Bunkowski, A. Byszuk³⁶, K. Doroba, A. Kalinowski, M. Konecki, J. Krolikowski, M. Misiura, M. Olszewski, A. Pyskir, M. Walczak**Laboratório de Instrumentação e Física Experimental de Partículas, Lisboa, Portugal**

M. Araujo, P. Bargassa, C. Beirão Da Cruz E Silva, A. Di Francesco, P. Faccioli, B. Galinhas, M. Gallinaro, J. Hollar, N. Leonardo, J. Seixas, G. Strong, O. Toldaiev, J. Varela

Joint Institute for Nuclear Research, Dubna, Russia

S. Afanasiev, P. Bunin, M. Gavrilenko, I. Golutvin, I. Gorbunov, A. Kamenev, V. Karjavine, A. Lanev, A. Malakhov, V. Matveev^{37,38}, P. Moisezenz, V. Palichik, V. Perelygin, S. Shmatov, S. Shulha, N. Skatchkov, V. Smirnov, N. Voytishin, A. Zarubin

Petersburg Nuclear Physics Institute, Gatchina (St. Petersburg), Russia

V. Golovtsov, Y. Ivanov, V. Kim³⁹, E. Kuznetsova⁴⁰, P. Levchenko, V. Murzin, V. Oreshkin, I. Smirnov, D. Sosnov, V. Sulimov, L. Uvarov, S. Vavilov, A. Vorobyev

Institute for Nuclear Research, Moscow, Russia

Yu. Andreev, A. Dermenev, S. Gninenko, N. Golubev, A. Karneyeu, M. Kirsanov, N. Krasnikov, A. Pashenkov, D. Tlisov, A. Toropin

Institute for Theoretical and Experimental Physics, Moscow, Russia

V. Epshteyn, V. Gavrilov, N. Lychkovskaya, V. Popov, I. Pozdnyakov, G. Safronov, A. Spiridonov, A. Steppenov, V. Stolin, M. Toms, E. Vlasov, A. Zhokin

Moscow Institute of Physics and Technology, Moscow, Russia

T. Aushev

National Research Nuclear University ‘Moscow Engineering Physics Institute’ (MEPhI), Moscow, Russia

R. Chistov⁴¹, M. Danilov⁴¹, P. Parygin, D. Philippov, S. Polikarpov⁴¹, E. Tarkovskii

P.N. Lebedev Physical Institute, Moscow, Russia

V. Andreev, M. Azarkin, I. Dremin³⁸, M. Kirakosyan, A. Terkulov

Skobeltsyn Institute of Nuclear Physics, Lomonosov Moscow State University, Moscow, Russia

A. Baskakov, A. Belyaev, E. Boos, V. Bunichev, M. Dubinin⁴², L. Dudko, A. Ershov, A. Gribushin, V. Klyukhin, O. Kodolova, I. Lokhtin, I. Miagkov, S. Obraztsov, M. Perfilov, V. Savrin

Novosibirsk State University (NSU), Novosibirsk, Russia

A. Barnyakov⁴³, V. Blinov⁴³, T. Dimova⁴³, L. Kardapoltsev⁴³, Y. Skovpen⁴³

Institute for High Energy Physics of National Research Centre ‘Kurchatov Institute’, Protvino, Russia

I. Azhgirey, I. Bayshev, S. Bitioukov, D. Elumakhov, A. Godizov, V. Kachanov, A. Kalinin, D. Konstantinov, P. Mandrik, V. Petrov, R. Ryutin, S. Slabospitskii, A. Sobol, S. Troshin, N. Tyurin, A. Uzunian, A. Volkov

National Research Tomsk Polytechnic University, Tomsk, Russia

A. Babaev, S. Baidali, V. Okhotnikov

University of Belgrade, Faculty of Physics and Vinca Institute of Nuclear Sciences, Belgrade, Serbia

P. Adzic⁴⁴, P. Cirkovic, D. Devetak, M. Dordevic, J. Milosevic

Centro de Investigaciones Energéticas Medioambientales y Tecnológicas (CIEMAT), Madrid, Spain

J. Alcaraz Maestre, A. Álvarez Fernández, I. Bachiller, M. Barrio Luna, J.A. Brochero Cifuentes, M. Cerrada, N. Colino, B. De La Cruz, A. Delgado Peris, C. Fernandez Bedoya, J.P. Fernández Ramos, J. Flix, M.C. Fouz, O. Gonzalez Lopez, S. Goy Lopez, J.M. Hernandez, M.I. Josa, D. Moran, A. Pérez-Calero Yzquierdo, J. Puerta Pelayo, I. Redondo, L. Romero, M.S. Soares, A. Triossi

Universidad Autónoma de Madrid, Madrid, Spain

C. Albajar, J.F. de Trocóniz

Universidad de Oviedo, Oviedo, Spain

J. Cuevas, C. Erice, J. Fernandez Menendez, S. Folgueras, I. Gonzalez Caballero, J.R. González Fernández, E. Palencia Cortezon, V. Rodríguez Bouza, S. Sanchez Cruz, P. Vischia, J.M. Vizán García

Instituto de Física de Cantabria (IFCA), CSIC-Universidad de Cantabria, Santander, Spain

I.J. Cabrillo, A. Calderon, B. Chazin Quero, J. Duarte Campderros, M. Fernandez, P.J. Fernández Manteca, A. García Alonso, J. Garcia-Ferrero, G. Gomez, A. Lopez Virto, J. Marco, C. Martinez Rivero, P. Martinez Ruiz del Arbol, F. Matorras, J. Piedra Gomez, C. Prieels, T. Rodrigo, A. Ruiz-Jimeno, L. Scodellaro, N. Trevisani, I. Vila, R. Villar Cortabitarte

University of Ruhuna, Department of Physics, Matara, Sri Lanka

N. Wickramage

CERN, European Organization for Nuclear Research, Geneva, Switzerland

D. Abbaneo, B. Akgun, E. Auffray, G. Auzinger, P. Baillon, A.H. Ball, D. Barney, J. Bendavid, M. Bianco, A. Bocci, C. Botta, E. Brondolin, T. Camporesi, M. Cepeda, G. Cerminara, E. Chapon, Y. Chen, G. Cucciati, D. d’Enterria, A. Dabrowski, N. Daci, V. Daponte, A. David, A. De Roeck, N. Deelen, M. Dobson, M. Dünser, N. Dupont, A. Elliott-Peisert, P. Everaerts, F. Fallavollita⁴⁵, D. Fasanella, G. Franzoni, J. Fulcher, W. Funk, D. Gigi, A. Gilbert, K. Gill, F. Glege, M. Gruchala, M. Guilbaud, D. Gulhan, J. Hegeman, C. Heidegger, V. Innocente, A. Jafari, P. Janot, O. Karacheban²⁰, J. Kieseler, A. Kornmayer, M. Krammer¹, C. Lange, P. Lecoq, C. Lourenço, L. Malgeri, M. Mannelli, F. Meijers, J.A. Merlin, S. Mersi, E. Meschi, P. Milenov⁴⁶, F. Moortgat, M. Mulders, J. Ngadiuba, S. Nourbakhsh, S. Orfanelli, L. Orsini, F. Pantaleo¹⁷, L. Pape, E. Perez, M. Peruzzi, A. Petrilli, G. Petrucciani, A. Pfeiffer, M. Pierini, F.M. Pitters, D. Rabaday, A. Racz, T. Reis, M. Rovere, H. Sakulin, C. Schäfer, C. Schwick, M. Seidel, M. Selvaggi, A. Sharma, P. Silva, P. Sphicas⁴⁷, A. Stakia, J. Steggemann, D. Treille, A. Tsirou, V. Veckalns⁴⁸, M. Verzetti, W.D. Zeuner

Paul Scherrer Institut, Villigen, Switzerland

L. Caminada⁴⁹, K. Deiters, W. Erdmann, R. Horisberger, Q. Ingram, H.C. Kaestli, D. Kotlinski, U. Langenegger, T. Rohe, S.A. Wiederkehr

ETH Zurich — Institute for Particle Physics and Astrophysics (IPA), Zurich, Switzerland

M. Backhaus, L. Bäni, P. Berger, N. Chernyavskaya, G. Dissertori, M. Dittmar, M. Donegà, C. Dorfer, T.A. Gómez Espinosa, C. Grab, D. Hits, T. Klijsma, W. Lustermann, R.A. Manzoni, M. Marionneau, M.T. Meinhard, F. Micheli, P. Musella, F. Nessi-Tedaldi, J. Pata, F. Pauss, G. Perrin, L. Perrozzi, S. Pigazzini, M. Quittnat, C. Reissel, D. Ruini, D.A. Sanz Becerra, M. Schönenberger, L. Shchutska, V.R. Tavolaro, K. Theofilatos, M.L. Vesterbacka Olsson, R. Wallny, D.H. Zhu

Universität Zürich, Zurich, Switzerland

T.K. Aarrestad, C. Amsler⁵⁰, D. Brzhechko, M.F. Canelli, A. De Cosa, R. Del Burgo, S. Donato, C. Galloni, T. Hreus, B. Kilminster, S. Leontsinis, I. Neutelings, G. Rauco, P. Robmann, D. Salerno, K. Schweiger, C. Seitz, Y. Takahashi, A. Zucchetta

National Central University, Chung-Li, Taiwan

T.H. Doan, R. Khurana, C.M. Kuo, W. Lin, A. Pozdnyakov, S.S. Yu

National Taiwan University (NTU), Taipei, Taiwan

P. Chang, Y. Chao, K.F. Chen, P.H. Chen, W.-S. Hou, Arun Kumar, Y.F. Liu, R.-S. Lu, E. Paganis, A. Psallidas, A. Steen

Chulalongkorn University, Faculty of Science, Department of Physics, Bangkok, Thailand

B. Asavapibhop, N. Srimanobhas, N. Suwonjandee

Çukurova University, Physics Department, Science and Art Faculty, Adana, Turkey

M.N. Bakirci⁵¹, A. Bat, F. Boran, S. Cerci⁵², S. Damarseekin, Z.S. Demiroglu, F. Dolek, C. Dozen, I. Dumanoglu, E. Eskut, S. Girgis, G. Gokbulut, Y. Guler, E. Gurpinar, I. Hos⁵³, C. Isik, E.E. Kangal⁵⁴, O. Kara, U. Kiminsu, M. Oglakci, G. Onengut, K. Ozdemir⁵⁵, A. Polatoz, D. Sunar Cerci⁵², U.G. Tok, S. Turkcapar, I.S. Zorbakir, C. Zorbilmez

Middle East Technical University, Physics Department, Ankara, Turkey

B. Isildak⁵⁶, G. Karapinar⁵⁷, M. Yalvac, M. Zeyrek

Bogazici University, Istanbul, Turkey

I.O. Atakisi, E. Gülmez, M. Kaya⁵⁸, O. Kaya⁵⁹, S. Ozkorucuklu⁶⁰, S. Tekten, E.A. Yetkin⁶¹

Istanbul Technical University, Istanbul, Turkey

M.N. Agaras, A. Cakir, K. Cankocak, Y. Komurcu, S. Sen⁶²

Institute for Scintillation Materials of National Academy of Science of Ukraine, Kharkov, Ukraine

B. Grynyov

National Scientific Center, Kharkov Institute of Physics and Technology, Kharkov, Ukraine

L. Levchuk

University of Bristol, Bristol, United Kingdom

F. Ball, J.J. Brooke, D. Burns, E. Clement, D. Cussans, O. Davignon, H. Flacher, J. Goldstein, G.P. Heath, H.F. Heath, L. Kreczko, D.M. Newbold⁶³, S. Paramesvaran, B. Penning, T. Sakuma, D. Smith, V.J. Smith, J. Taylor, A. Titterton

Rutherford Appleton Laboratory, Didcot, United Kingdom

K.W. Bell, A. Belyaev⁶⁴, C. Brew, R.M. Brown, D. Cieri, D.J.A. Cockerill, J.A. Coughlan, K. Harder, S. Harper, J. Linacre, E. Olaiya, D. Petyt, C.H. Shepherd-Themistocleous, A. Thea, I.R. Tomalin, T. Williams, W.J. Womersley

Imperial College, London, United Kingdom

R. Bainbridge, P. Bloch, J. Borg, S. Breeze, O. Buchmuller, A. Bundock, D. Colling, P. Dauncey, G. Davies, M. Della Negra, R. Di Maria, G. Hall, G. Iles, T. James, M. Komm, C. Laner, L. Lyons, A.-M. Magnan, S. Malik, A. Martelli, J. Nash⁶⁵, A. Nikitenko⁷, V. Palladino, M. Pesaresi, D.M. Raymond, A. Richards, A. Rose, E. Scott, C. Seez, A. Shtipliyski, G. Singh, M. Stoye, T. Strebler, S. Summers, A. Tapper, K. Uchida, T. Virdee¹⁷, N. Wardle, D. Winterbottom, J. Wright, S.C. Zenz

Brunel University, Uxbridge, United Kingdom

J.E. Cole, P.R. Hobson, A. Khan, P. Kyberd, C.K. Mackay, A. Morton, I.D. Reid, L. Teodorescu, S. Zahid

Baylor University, Waco, U.S.A.

K. Call, J. Dittmann, K. Hatakeyama, H. Liu, C. Madrid, B. McMaster, N. Pastika, C. Smith

Catholic University of America, Washington DC, U.S.A.

R. Bartek, A. Dominguez

The University of Alabama, Tuscaloosa, U.S.A.

A. Buccilli, S.I. Cooper, C. Henderson, P. Rumerio, C. West

Boston University, Boston, U.S.A.

D. Arcaro, T. Bose, D. Gastler, D. Pinna, D. Rankin, C. Richardson, J. Rohlf, L. Sulak, D. Zou

Brown University, Providence, U.S.A.

G. Benelli, X. Coubez, D. Cutts, M. Hadley, J. Hakala, U. Heintz, J.M. Hogan⁶⁶, K.H.M. Kwok, E. Laird, G. Landsberg, J. Lee, Z. Mao, M. Narain, S. Sagir⁶⁷, R. Syarif, E. Usai, D. Yu

University of California, Davis, Davis, U.S.A.

R. Band, C. Brainerd, R. Breedon, D. Burns, M. Calderon De La Barca Sanchez, M. Chertok, J. Conway, R. Conway, P.T. Cox, R. Erbacher, C. Flores, G. Funk, W. Ko, O. Kukral, R. Lander, M. Mulhearn, D. Pellett, J. Pilot, S. Shalhout, M. Shi, D. Stolp, D. Taylor, K. Tos, M. Tripathi, Z. Wang, F. Zhang

University of California, Los Angeles, U.S.A.

M. Bachtis, C. Bravo, R. Cousins, A. Dasgupta, A. Florent, J. Hauser, M. Ignatenko, N. Mccoll, S. Regnard, D. Saltzberg, C. Schnaible, V. Valuev

University of California, Riverside, Riverside, U.S.A.

E. Bouvier, K. Burt, R. Clare, J.W. Gary, S.M.A. Ghiasi Shirazi, G. Hanson, G. Karapostoli, E. Kennedy, F. Lacroix, O.R. Long, M. Olmedo Negrete, M.I. Paneva, W. Si, L. Wang, H. Wei, S. Wimpenny, B.R. Yates

University of California, San Diego, La Jolla, U.S.A.

J.G. Branson, P. Chang, S. Cittolin, M. Derdzinski, R. Gerosa, D. Gilbert, B. Hashemi, A. Holzner, D. Klein, G. Kole, V. Krutelyov, J. Letts, M. Masciovecchio, D. Olivito, S. Padhi, M. Pieri, M. Sani, V. Sharma, S. Simon, M. Tadel, A. Vartak, S. Wasserbaech⁶⁸, J. Wood, F. Würthwein, A. Yagil, G. Zevi Della Porta

University of California, Santa Barbara — Department of Physics, Santa Barbara, U.S.A.

N. Amin, R. Bhandari, C. Campagnari, M. Citron, V. Dutta, M. Franco Sevilla, L. Gouskos, R. Heller, J. Incandela, A. Ovcharova, H. Qu, J. Richman, D. Stuart, I. Suarez, S. Wang, J. Yoo

California Institute of Technology, Pasadena, U.S.A.

D. Anderson, A. Bornheim, J.M. Lawhorn, N. Lu, H.B. Newman, T.Q. Nguyen, M. Spiropulu, J.R. Vlimant, R. Wilkinson, S. Xie, Z. Zhang, R.Y. Zhu

Carnegie Mellon University, Pittsburgh, U.S.A.

M.B. Andrews, T. Ferguson, T. Mudholkar, M. Paulini, M. Sun, I. Vorobiev, M. Weinberg

University of Colorado Boulder, Boulder, U.S.A.

J.P. Cumalat, W.T. Ford, F. Jensen, A. Johnson, E. MacDonald, T. Mulholland, R. Patel, A. Perloff, K. Stenson, K.A. Ulmer, S.R. Wagner

Cornell University, Ithaca, U.S.A.

J. Alexander, J. Chaves, Y. Cheng, J. Chu, A. Datta, K. McDermott, N. Mirman, J.R. Patterson, D. Quach, A. Rinkevicius, A. Ryd, L. Skinnari, L. Soffi, S.M. Tan, Z. Tao, J. Thom, J. Tucker, P. Wittich, M. Zientek

Fermi National Accelerator Laboratory, Batavia, U.S.A.

S. Abdullin, M. Albrow, M. Alyari, G. Apollinari, A. Apresyan, A. Apyan, S. Banerjee, L.A.T. Bauerdick, A. Beretvas, J. Berryhill, P.C. Bhat, K. Burkett, J.N. Butler, A. Canepa, G.B. Cerati, H.W.K. Cheung, F. Chlebana, M. Cremonesi, J. Duarte, V.D. Elvira, J. Freeman, Z. Gecse, E. Gottschalk, L. Gray, D. Green, S. Grünendahl, O. Gutsche, J. Hanlon, R.M. Harris, S. Hasegawa, J. Hirschauer, Z. Hu, B. Jayatilaka, S. Jindariani, M. Johnson, U. Joshi, B. Klima, M.J. Kortelainen, B. Kreis, S. Lammel, D. Lincoln, R. Lipton, M. Liu, T. Liu, J. Lykken, K. Maeshima, J.M. Marraffino, D. Mason, P. McBride, P. Merkel, S. Mrenna, S. Nahn, V. O'Dell, K. Pedro, C. Pena, O. Prokofyev, G. Rakness, L. Ristori, A. Savoy-Navarro⁶⁹, B. Schneider, E. Sexton-Kennedy, A. Soha, W.J. Spalding,

L. Spiegel, S. Stoynev, J. Strait, N. Strobbe, L. Taylor, S. Tkaczyk, N.V. Tran, L. Uplegger, E.W. Vaandering, C. Vernieri, M. Verzocchi, R. Vidal, M. Wang, H.A. Weber, A. Whitbeck

University of Florida, Gainesville, U.S.A.

D. Acosta, P. Avery, P. Bortignon, D. Bourilkov, A. Brinkerhoff, L. Cadamuro, A. Carnes, D. Curry, R.D. Field, S.V. Gleyzer, B.M. Joshi, J. Konigsberg, A. Korytov, K.H. Lo, P. Ma, K. Matchev, H. Mei, G. Mitselmakher, D. Rosenzweig, K. Shi, D. Sperka, J. Wang, S. Wang, X. Zuo

Florida International University, Miami, U.S.A.

Y.R. Joshi, S. Linn

Florida State University, Tallahassee, U.S.A.

A. Ackert, T. Adams, A. Askew, S. Hagopian, V. Hagopian, K.F. Johnson, T. Kolberg, G. Martinez, T. Perry, H. Prosper, A. Saha, C. Schiber, R. Yohay

Florida Institute of Technology, Melbourne, U.S.A.

M.M. Baarmand, V. Bhopatkar, S. Colafranceschi, M. Hohlmann, D. Noonan, M. Rahmani, T. Roy, F. Yumiceva

University of Illinois at Chicago (UIC), Chicago, U.S.A.

M.R. Adams, L. Apanasevich, D. Berry, R.R. Betts, R. Cavanaugh, X. Chen, S. Dittmer, O. Evdokimov, C.E. Gerber, D.A. Hangal, D.J. Hofman, K. Jung, J. Kamin, C. Mills, I.D. Sandoval Gonzalez, M.B. Tonjes, H. Trauger, N. Varelas, H. Wang, X. Wang, Z. Wu, J. Zhang

The University of Iowa, Iowa City, U.S.A.

M. Alhusseini, B. Bilki⁷⁰, W. Clarida, K. Dilsiz⁷¹, S. Durgut, R.P. Gandrajula, M. Haytmyradov, V. Khristenko, J.-P. Merlo, A. Mestvirishvili, A. Moeller, J. Nachtman, H. Ogul⁷², Y. Onel, F. Ozok⁷³, A. Penzo, C. Snyder, E. Tiras, J. Wetzel

Johns Hopkins University, Baltimore, U.S.A.

B. Blumenfeld, A. Cocoros, N. Eminizer, D. Fehling, L. Feng, A.V. Gritsan, W.T. Hung, P. Maksimovic, J. Roskes, U. Sarica, M. Swartz, M. Xiao, C. You

The University of Kansas, Lawrence, U.S.A.

A. Al-bataineh, P. Baringer, A. Bean, S. Boren, J. Bowen, A. Bylinkin, J. Castle, S. Khalil, A. Kropivnitskaya, D. Majumder, W. Mcbrayer, M. Murray, C. Rogan, S. Sanders, E. Schmitz, J.D. Tapia Takaki, Q. Wang

Kansas State University, Manhattan, U.S.A.

S. Duric, A. Ivanov, K. Kaadze, D. Kim, Y. Maravin, D.R. Mendis, T. Mitchell, A. Modak, A. Mohammadi, L.K. Saini

Lawrence Livermore National Laboratory, Livermore, U.S.A.

F. Rebassoo, D. Wright

University of Maryland, College Park, U.S.A.

A. Baden, O. Baron, A. Belloni, S.C. Eno, Y. Feng, C. Ferraioli, N.J. Hadley, S. Jabeen, G.Y. Jeng, R.G. Kellogg, J. Kunkle, A.C. Mignerey, S. Nabili, F. Ricci-Tam, Y.H. Shin, A. Skuja, S.C. Tonwar, K. Wong

Massachusetts Institute of Technology, Cambridge, U.S.A.

D. Abercrombie, B. Allen, V. Azzolini, A. Baty, G. Bauer, R. Bi, S. Brandt, W. Busza, I.A. Cali, M. D'Alfonso, Z. Demiragli, G. Gomez Ceballos, M. Goncharov, P. Harris, D. Hsu, M. Hu, Y. Iiyama, G.M. Innocenti, M. Klute, D. Kovalskyi, Y.-J. Lee, P.D. Luckey, B. Maier, A.C. Marini, C. McGinn, C. Mironov, S. Narayanan, X. Niu, C. Paus, C. Roland, G. Roland, Z. Shi, G.S.F. Stephans, K. Sumorok, K. Tatar, D. Velicanu, J. Wang, T.W. Wang, B. Wyslouch

University of Minnesota, Minneapolis, U.S.A.

A.C. Benvenuti[†], R.M. Chatterjee, A. Evans, P. Hansen, J. Hiltbrand, Sh. Jain, S. Kalafut, M. Krohn, Y. Kubota, Z. Lesko, J. Mans, N. Ruckstuhl, R. Rusack, M.A. Wadud

University of Mississippi, Oxford, U.S.A.

J.G. Acosta, S. Oliveros

University of Nebraska-Lincoln, Lincoln, U.S.A.

E. Avdeeva, K. Bloom, D.R. Claes, C. Fangmeier, F. Golf, R. Gonzalez Suarez, R. Kamalieddin, I. Kravchenko, J. Monroy, J.E. Siado, G.R. Snow, B. Stieger

State University of New York at Buffalo, Buffalo, U.S.A.

A. Godshalk, C. Harrington, I. Iashvili, A. Kharchilava, C. Mclean, D. Nguyen, A. Parker, S. Rappoccio, B. Roozbahani

Northeastern University, Boston, U.S.A.

G. Alverson, E. Barberis, C. Freer, Y. Haddad, A. Hortiangtham, D.M. Morse, T. Orimoto, R. Teixeira De Lima, T. Wamorkar, B. Wang, A. Wisecarver, D. Wood

Northwestern University, Evanston, U.S.A.

S. Bhattacharya, J. Bueghly, O. Charaf, K.A. Hahn, N. Mucia, N. Odell, M.H. Schmitt, K. Sung, M. Trovato, M. Velasco

University of Notre Dame, Notre Dame, U.S.A.

R. Bucci, N. Dev, M. Hildreth, K. Hurtado Anampa, C. Jessop, D.J. Karmgard, N. Kellams, K. Lannon, W. Li, N. Loukas, N. Marinelli, F. Meng, C. Mueller, Y. Musienko³⁷, M. Planer, A. Reinsvold, R. Ruchti, P. Siddireddy, G. Smith, S. Taroni, M. Wayne, A. Wightman, M. Wolf, A. Woodard

The Ohio State University, Columbus, U.S.A.

J. Alimena, L. Antonelli, B. Bylsma, L.S. Durkin, S. Flowers, B. Francis, C. Hill, W. Ji, T.Y. Ling, W. Luo, B.L. Winer

Princeton University, Princeton, U.S.A.

S. Cooperstein, P. Elmer, J. Hardenbrook, S. Higginbotham, A. Kalogeropoulos, D. Lange, M.T. Lucchini, J. Luo, D. Marlow, K. Mei, I. Ojalvo, J. Olsen, C. Palmer, P. Piroué, J. Salfeld-Nebgen, D. Stickland, C. Tully, Z. Wang

University of Puerto Rico, Mayaguez, U.S.A.

S. Malik, S. Norberg

Purdue University, West Lafayette, U.S.A.

A. Barker, V.E. Barnes, S. Das, L. Gutay, M. Jones, A.W. Jung, A. Khatiwada, B. Mahakud, D.H. Miller, N. Neumeister, C.C. Peng, S. Piperov, H. Qiu, J.F. Schulte, J. Sun, F. Wang, R. Xiao, W. Xie

Purdue University Northwest, Hammond, U.S.A.

T. Cheng, J. Dolen, N. Parashar

Rice University, Houston, U.S.A.

Z. Chen, K.M. Ecklund, S. Freed, F.J.M. Geurts, M. Kilpatrick, W. Li, B.P. Padley, R. Redjimi, J. Roberts, J. Rorie, W. Shi, Z. Tu, A. Zhang

University of Rochester, Rochester, U.S.A.

A. Bodek, P. de Barbaro, R. Demina, Y.t. Duh, J.L. Dulemba, C. Fallon, T. Ferbel, M. Galanti, A. Garcia-Bellido, J. Han, O. Hindrichs, A. Khukhunaishvili, E. Ranken, P. Tan, R. Taus

Rutgers, The State University of New Jersey, Piscataway, U.S.A.

A. Agapitos, J.P. Chou, Y. Gershtein, E. Halkiadakis, A. Hart, M. Heindl, E. Hughes, S. Kaplan, R. Kunnawalkam Elayavalli, S. Kyriacou, A. Lath, R. Montalvo, K. Nash, M. Osherson, H. Saka, S. Salur, S. Schnetzer, D. Sheffield, S. Somalwar, R. Stone, S. Thomas, P. Thomassen, M. Walker

University of Tennessee, Knoxville, U.S.A.

A.G. Delannoy, J. Heideman, G. Riley, S. Spanier

Texas A&M University, College Station, U.S.A.

O. Bouhali⁷⁴, A. Celik, M. Dalchenko, M. De Mattia, A. Delgado, S. Dildick, R. Eusebi, J. Gilmore, T. Huang, T. Kamon⁷⁵, S. Luo, R. Mueller, D. Overton, L. Perniè, D. Rathjens, A. Safonov

Texas Tech University, Lubbock, U.S.A.

N. Akchurin, J. Damgov, F. De Guio, P.R. Duderov, S. Kunori, K. Lamichhane, S.W. Lee, T. Mengke, S. Muthumuni, T. Peltola, S. Undleeb, I. Volobouev, Z. Wang

Vanderbilt University, Nashville, U.S.A.

S. Greene, A. Gurrola, R. Janjam, W. Johns, C. Maguire, A. Melo, H. Ni, K. Padeken, J.D. Ruiz Alvarez, P. Sheldon, S. Tuo, J. Velkovska, M. Verweij, Q. Xu

University of Virginia, Charlottesville, U.S.A.

M.W. Arenton, P. Barria, B. Cox, R. Hirosky, M. Joyce, A. Ledovsky, H. Li, C. Neu, T. Sinthuprasith, Y. Wang, E. Wolfe, F. Xia

Wayne State University, Detroit, U.S.A.

R. Harr, P.E. Karchin, N. Poudyal, J. Sturdy, P. Thapa, S. Zaleski

University of Wisconsin — Madison, Madison, WI, U.S.A.

M. Brodski, J. Buchanan, C. Caillol, D. Carlsmith, S. Dasu, I. De Bruyn, L. Dodd, B. Gomber, M. Grothe, M. Herndon, A. Hervé, U. Hussain, P. Klabbers, A. Lanaro, K. Long, R. Loveless, T. Ruggles, A. Savin, V. Sharma, N. Smith, W.H. Smith, N. Woods

†: Deceased

- 1: Also at Vienna University of Technology, Vienna, Austria
- 2: Also at IRFU, CEA, Université Paris-Saclay, Gif-sur-Yvette, France
- 3: Also at Universidade Estadual de Campinas, Campinas, Brazil
- 4: Also at Federal University of Rio Grande do Sul, Porto Alegre, Brazil
- 5: Also at Université Libre de Bruxelles, Bruxelles, Belgium
- 6: Also at University of Chinese Academy of Sciences, Beijing, China
- 7: Also at Institute for Theoretical and Experimental Physics, Moscow, Russia
- 8: Also at Joint Institute for Nuclear Research, Dubna, Russia
- 9: Also at Suez University, Suez, Egypt
- 10: Now at British University in Egypt, Cairo, Egypt
- 11: Now at Cairo University, Cairo, Egypt
- 12: Also at Department of Physics, King Abdulaziz University, Jeddah, Saudi Arabia
- 13: Also at Université de Haute Alsace, Mulhouse, France
- 14: Also at Skobeltsyn Institute of Nuclear Physics, Lomonosov Moscow State University, Moscow, Russia
- 15: Also at Tbilisi State University, Tbilisi, Georgia
- 16: Also at Ilia State University, Tbilisi, Georgia
- 17: Also at CERN, European Organization for Nuclear Research, Geneva, Switzerland
- 18: Also at RWTH Aachen University, III. Physikalisches Institut A, Aachen, Germany
- 19: Also at University of Hamburg, Hamburg, Germany
- 20: Also at Brandenburg University of Technology, Cottbus, Germany
- 21: Also at Institute of Physics, University of Debrecen, Debrecen, Hungary
- 22: Also at Institute of Nuclear Research ATOMKI, Debrecen, Hungary
- 23: Also at MTA-ELTE Lendület CMS Particle and Nuclear Physics Group, Eötvös Loránd University, Budapest, Hungary
- 24: Also at Indian Institute of Technology Bhubaneswar, Bhubaneswar, India
- 25: Also at Institute of Physics, Bhubaneswar, India
- 26: Also at Shoolini University, Solan, India
- 27: Also at University of Visva-Bharati, Santiniketan, India
- 28: Also at Isfahan University of Technology, Isfahan, Iran
- 29: Also at Plasma Physics Research Center, Science and Research Branch, Islamic Azad University, Tehran, Iran
- 30: Also at Università degli Studi di Siena, Siena, Italy
- 31: Also at Scuola Normale e Sezione dell'INFN, Pisa, Italy
- 32: Also at Kyunghee University, Seoul, Korea

- 33: Also at International Islamic University of Malaysia, Kuala Lumpur, Malaysia
- 34: Also at Malaysian Nuclear Agency, MOSTI, Kajang, Malaysia
- 35: Also at Consejo Nacional de Ciencia y Tecnología, Mexico city, Mexico
- 36: Also at Warsaw University of Technology, Institute of Electronic Systems, Warsaw, Poland
- 37: Also at Institute for Nuclear Research, Moscow, Russia
- 38: Now at National Research Nuclear University ‘Moscow Engineering Physics Institute’ (MEPhI), Moscow, Russia
- 39: Also at St. Petersburg State Polytechnical University, St. Petersburg, Russia
- 40: Also at University of Florida, Gainesville, U.S.A.
- 41: Also at P.N. Lebedev Physical Institute, Moscow, Russia
- 42: Also at California Institute of Technology, Pasadena, U.S.A.
- 43: Also at Budker Institute of Nuclear Physics, Novosibirsk, Russia
- 44: Also at Faculty of Physics, University of Belgrade, Belgrade, Serbia
- 45: Also at INFN Sezione di Pavia^a, Università di Pavia^b, Pavia, Italy
- 46: Also at University of Belgrade, Faculty of Physics and Vinca Institute of Nuclear Sciences, Belgrade, Serbia
- 47: Also at National and Kapodistrian University of Athens, Athens, Greece
- 48: Also at Riga Technical University, Riga, Latvia
- 49: Also at Universität Zürich, Zurich, Switzerland
- 50: Also at Stefan Meyer Institute for Subatomic Physics (SMI), Vienna, Austria
- 51: Also at Gaziosmanpasa University, Tokat, Turkey
- 52: Also at Adiyaman University, Adiyaman, Turkey
- 53: Also at Istanbul Aydin University, Istanbul, Turkey
- 54: Also at Mersin University, Mersin, Turkey
- 55: Also at Piri Reis University, Istanbul, Turkey
- 56: Also at Ozyegin University, Istanbul, Turkey
- 57: Also at Izmir Institute of Technology, Izmir, Turkey
- 58: Also at Marmara University, Istanbul, Turkey
- 59: Also at Kafkas University, Kars, Turkey
- 60: Also at Istanbul University, Faculty of Science, Istanbul, Turkey
- 61: Also at Istanbul Bilgi University, Istanbul, Turkey
- 62: Also at Hacettepe University, Ankara, Turkey
- 63: Also at Rutherford Appleton Laboratory, Didcot, United Kingdom
- 64: Also at School of Physics and Astronomy, University of Southampton, Southampton, United Kingdom
- 65: Also at Monash University, Faculty of Science, Clayton, Australia
- 66: Also at Bethel University, St. Paul, U.S.A.
- 67: Also at Karamanoğlu Mehmetbey University, Karaman, Turkey
- 68: Also at Utah Valley University, Orem, U.S.A.
- 69: Also at Purdue University, West Lafayette, U.S.A.
- 70: Also at Beykent University, Istanbul, Turkey
- 71: Also at Bingol University, Bingol, Turkey
- 72: Also at Sinop University, Sinop, Turkey
- 73: Also at Mimar Sinan University, Istanbul, Istanbul, Turkey
- 74: Also at Texas A&M University at Qatar, Doha, Qatar
- 75: Also at Kyungpook National University, Daegu, Korea