

# SECRETION OF ACID HYDROLASES AND ITS INTRACELLULAR SOURCE IN *TETRAHYMENA PYRIFORMIS*

MIKLÓS MÜLLER

From The Rockefeller University, New York 10021

## ABSTRACT

Axenic *Tetrahymena pyriformis*, syngen 1, mating type II cells were grown in Cox's defined medium. When washed and transferred into nonnutrient dilute salt solution or resuspended in the defined medium, the intact cells secrete acid hydrolases into the medium. Cells starving in the salt solution release in 5 hr about two-thirds of their  $\beta$ -glucosidase,  $\beta$ -*N*-acetylglucosaminidase,  $\alpha$ -glucosidase, and amylase activities, about one-third of their deoxyribonuclease and phosphatase activities, smaller amounts of ribonuclease, and only a negligible fraction of their proteinase activity and protein content. During this period there is practically no change in the enzyme activities (except for a sudden increase of ribonuclease activity) and protein content of cells and medium together. Cells resuspended in the nutrient medium secrete enzymes as do the starved cells, but replace this loss, so that there is a continuous increase of the activities in the total system. According to isopycnic centrifugation experiments performed in sucrose gradients, the source of the hydrolases is a special population of lysosomes which disappear from the cells during starvation. This population equilibrates in the high density region of the gradients and contains the various acid hydrolases in about the proportion in which these enzymes appear in the medium.

## INTRODUCTION

It has been reported that certain hydrolases appear in the medium of cultures of *Tetrahymena pyriformis*, a phagotrophic ciliated protozoan (see reference 14). The nature and significance of this phenomenon is not understood. In the present paper we report quantitative data on the process of acid hydrolase secretion by *Tetrahymena* cells kept in nonnutritive or nutritive medium, and we show that it is a normal process not due to cell destruction. Furthermore, we present isopycnic centrifugation data showing that the source of the released enzymes is one of the two distinct populations of lysosomes that have been identified in this organism (16). An abstract of this work has been published (15).

## MATERIALS AND METHODS

### *Organism and Culture*

*Tetrahymena pyriformis*, syngen 1, mating type II (WH 14 strain) was cultured in the defined medium of Cox et al. (3) supplemented with glycine (35 mg/100 ml), L-proline (20 mg/100 ml), L-serine (20 mg/100 ml), and Na- $\beta$ -glycerophosphate (200 mg/100 ml). The pH of this medium is about 5.4.

Mass cultures were grown in flat cylindrical flasks, 7 inches in diameter, (Jobling No. 1420 culture flasks, Laboratory Glassblowers Company, Sands, High Wycomb, Buckinghamshire, England), containing 500 ml of medium. These flasks were inoculated with 50 ml of a 2 day old culture, and grown unshaken at  $30^\circ \pm 0.5^\circ\text{C}$  for 2 days. By this time, the cultures

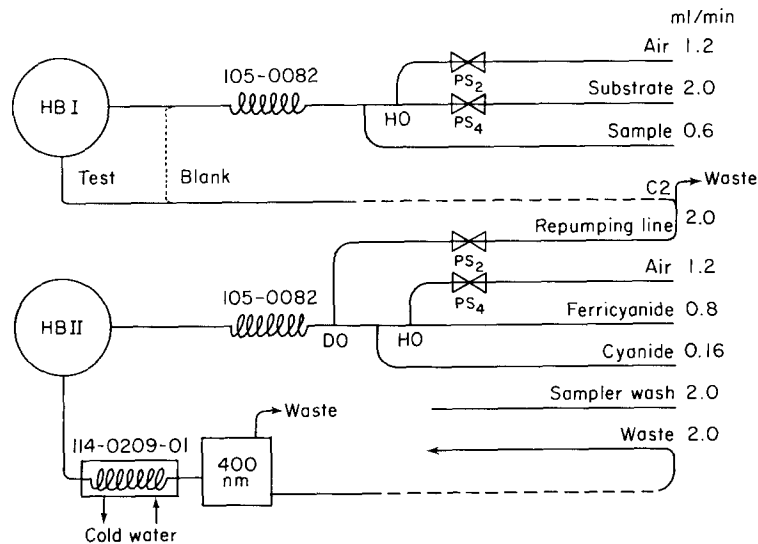

FIGURE 1 Automated amylase assay. *HB I*, heating bath, 37°C, 80 ft. coil, 2.4 mm inner diameter (I.D.); *HB II*, heating bath, 95°C, 80 ft. coil, 1.6 mm I.D.; for other symbols refer to Technicon catalogue. Blank values are obtained by short circuiting *HB I*. *Substrate*; 1.5% soluble starch (end-groups reduced) in 0.1 M acetate buffer pH 5.0 + 0.2% Brij 35 (Technicon Corporation). Prepared from a stock solution (kept in refrigerator), containing 5% soluble starch (Mallinckrodt Chemical Works, St. Louis, Mo.) to which sodium borohydride has been added at room temperature under stirring to a final concentration of 44 mM. Before dilution with buffer, excess borohydride in this solution is destroyed at room temperature by addition of 2 ml of acetone per 100 ml stock solution. *Alkaline ferricyanide*: Mixture containing 24 mM potassium ferricyanide, 250 mM sodium carbonate, and 0.2% Brij 35 (added before use). *Potassium cyanide*: Mixture containing 75 mM KCN and 200 mM sodium carbonate. *Washing fluid*: 0.05% Brij 35 in water. *Standard*: 150  $\mu$ M glucose in saturated benzoic acid. Sampling rate 20 samples per hour (2/1). Colorimetry at 400 nm with tubular-flow cell of 15 mm light path. *Recording*: Absorbance on linear paper.

were in late logarithmic phase, and contained about 0.5 to  $1 \times 10^8$  cells/ml.

### Secretion Experiments

In the secretion experiments, the cells were collected with a modified plankton centrifuge (2), washed once in Prescott (19) solution, brought back to their initial concentration either with Prescott solution or with Cox's medium, and reincubated at 30°C in unshaken flat culture flasks. Less than 0.01% of the original medium remained after this operation, at the end of which the starting culture conditions were essentially restored, except for the eventual change of medium.

These manipulations did not damage the cells, which remained viable for at least 12 hr. The number of cells did not decrease, as will be shown in the results. Pattern formation in the suspensions was normal, indicating that most cells had normal motility (9).

The suspensions were sampled at different times. Part of each sample was centrifuged for 2-3 min at 2000 rpm at room temperature in an International

TABLE I  
*Specific Activities of Acid Hydrolases  
in Tetrahymena pyriformis  
Homogenates*

Values give mean specific activity, in milliunits per milligram of protein,  $\pm$ SD. The number of determinations is indicated in parentheses. All assays performed at 37°C.

Enzyme	E.C.	Specific activity	
Proteinase	3.4.4.-	52.5 $\pm$ 17.8	(6)
Ribonuclease	2.7.7.16	66.7 $\pm$ 36.0	(5)
Deoxyribonuclease	3.1.4.5	79.4 $\pm$ 3.5	(8)
Phosphatase	3.1.3.2	205 $\pm$ 59	(15)
$\beta$ -Glucosidase	3.2.1.21	12.7 $\pm$ 3.4	(3)
$\beta$ -N-acetylglucosaminidase	3.2.1.30	62.6 $\pm$ 24.8	(19)
$\alpha$ -Glucosidase	3.2.1.20	7.3 $\pm$ 1.6	(9)
Amylase	3.2.1.1	53.9 $\pm$ 4.9	(4)

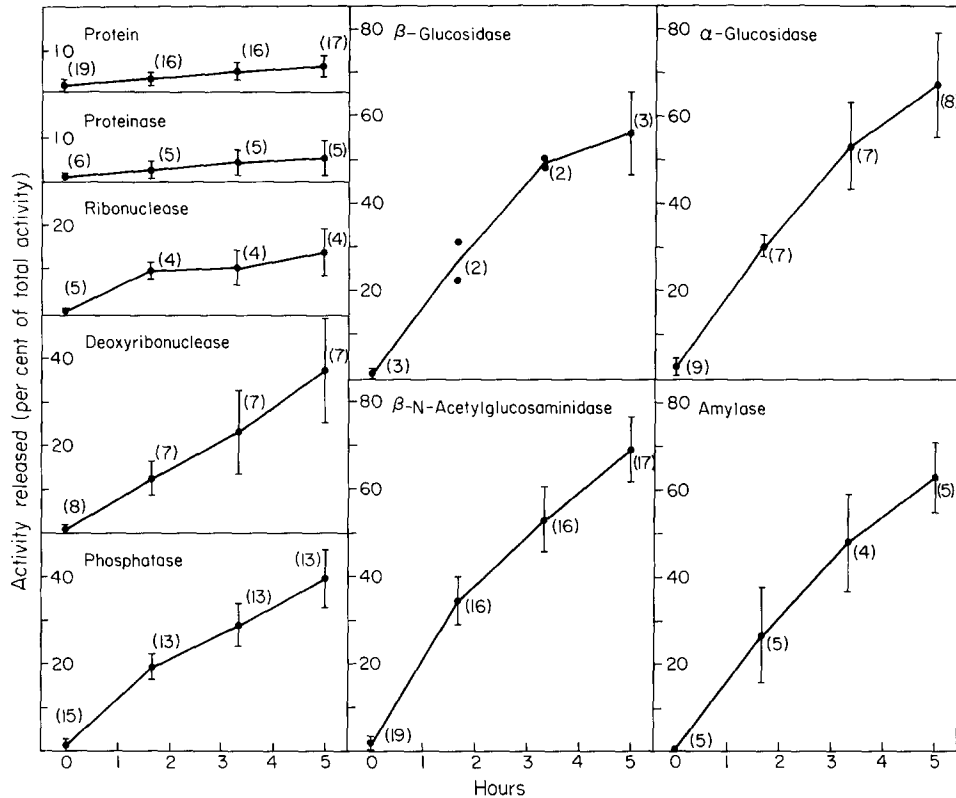

FIGURE 2 Amount of protein and enzyme activities appearing in the medium during starvation of *Tetrahymena pyriformis*. Vertical line through experimental points represents standard deviation. Numbers of experiments in parentheses. Over-all per cent recoveries for all experimental points (mean  $\pm$  SD) were  $102.1 \pm 8.3$  for protein,  $100.6 \pm 8.6$  for proteinase,  $95.4 \pm 10.3$  for ribonuclease,  $88.1 \pm 12.6$  for deoxyribonuclease,  $99.2 \pm 6.4$  for phosphatase,  $98.8 \pm 5.2$  for  $\beta$ -glucosidase,  $102.3 \pm 4.7$  for  $\beta$ -N-acetylglucosaminidase,  $100.4 \pm 7.4$  for  $\alpha$ -glucosidase,  $94.5 \pm 8.6$  for amylase.

laboratory centrifuge. Cells and medium, as well as the original samples, were analyzed separately. The cells were resuspended in either Prescott solution or Cox's medium, depending on the medium from which they were taken. Another part of each sample was diluted with 0.15 M sodium chloride solution containing 2% formaldehyde, and the fixed cells were counted with a Coulter counter, model B.

### Isopycnic Centrifugation

Homogenates used in cell fractionation experiments were prepared as follows. Cells were recovered from the medium and washed as described above. The concentrated cell suspension was chilled and diluted 5- to 10-fold by addition of ice-cold 0.25 M sucrose. All subsequent steps were performed at  $0^{\circ}$ - $4^{\circ}$ C. The cells were resedimented by centrifugation for 1 min at approximately 1500 rpm in an International Laboratory centrifuge and resuspended with 0.25 M sucrose. The cell suspension was passed through a fritted glass

filter (Corning No. 36060, Grade M, pore size 10-15  $\mu$ m) under suction (8). Phase-contrast microscope examination showed the cell disruption to be complete (16, 18).

Fractionation by isopycnic density-gradient centrifugation was performed with the Beaufay automatic zonal rotor (11) as described earlier (16, 18). The density limits of the continuous sucrose gradients were 1.08 and 1.28. The gradients were resting on cushions of density 1.32.

### Enzyme Assays

All assay methods used in this work, except that for amylase, were described earlier (16, 17, 18). Amylase was assayed by a modification of the automated method of Strumeyer and Romano (21). The manifold used on a Technicon Auto Analyzer (Technicon Corporation, Tarrytown, N. Y.) and the conditions of the assay are given in Fig. 1.

Since some of the samples consisted of frozen and

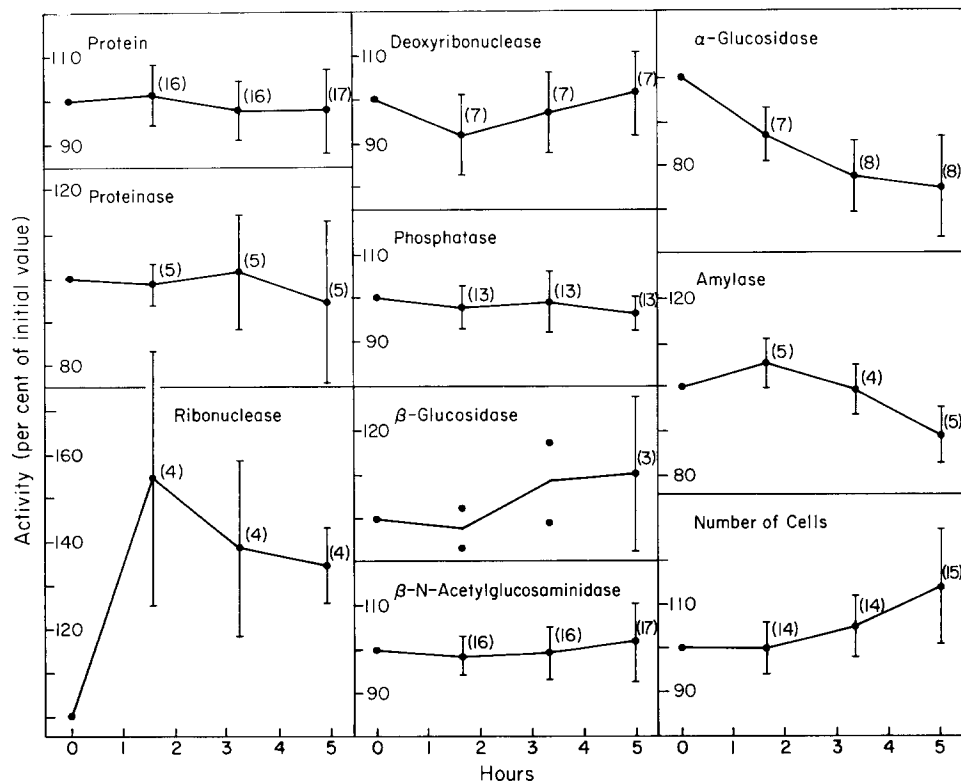

FIGURE 3 Changes in cell number, protein content, and enzyme activities in the total system (consisting of cells and medium) during starvation. Same experiments as in Fig. 2. Vertical line through experimental points represents standard deviation. Number of experiments in parentheses.

thawed suspensions in which the cells sediment rather quickly, they had to be kept mixed by stirring in the automated assays for protein and amylase. The paddle-type stirrer of the Sampler II (Technicon Corporation) caused too much splashing, therefore we resorted to magnetic stirring. Two miniature magnets geared to a small motor were inserted through an opening in the cover of the sampler, so as to sit underneath the cup that was being sampled and underneath that to be sampled next. Flat-bottomed cups and small Teflon-coated stirring bars were used.

Enzyme units are defined as the amount of enzyme necessary to release 1  $\mu$ mole of product per min under the assay conditions. The products are estimated in mononucleotide equivalents for the nucleases. The proteinase activity is expressed as chromogenic equivalents of 1  $\mu$ g of albumin released per min.

#### Calculation of Results

The results of the fractionation experiments were calculated and plotted with the help of a PDP 15 computer, following the procedures described by Beaufay et al. (1) and by Leighton et al. (11).

## RESULTS

### Enzyme Activities

In Table I are listed the initial specific activities of acid hydrolases in cells collected from the cultures. The values are in good agreement with our previous data (16).

### Release of Protein and Enzymes during Starvation

Separation of each sample into cells and surrounding medium shows that during starvation protein and acid hydrolases appear in the organic medium (Fig. 2) and that they disappear from the cells in roughly the same or a somewhat larger proportion, so that the total amounts present in cells and medium together change relatively little (Fig. 3). An exception is ribonuclease which actually increases in the cells (Fig. 3), despite a certain amount of release into the medium (Fig. 2).

During these experiments, the cell number remains constant or increases somewhat (Fig. 3) and protein is discharged in much lower proportion than are most enzymes, with the consequence that

the specific activity of the enzymes is generally much greater in the medium than it is in the cells. Quite obviously, the enzyme release is a specific process, not due to the disintegration of the cells.

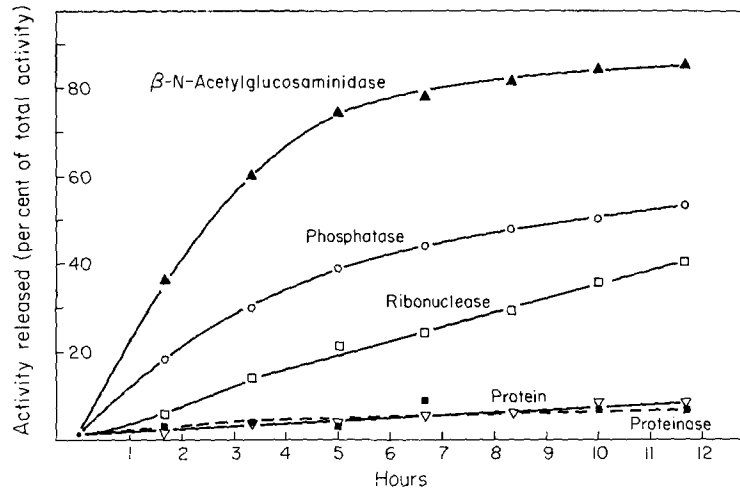

FIGURE 4 Amount of protein and enzyme activities appearing in the medium during starvation. Results of a single experiment. Per cent recoveries (mean  $\pm$  SD) were  $98.3 \pm 1.7$  for protein,  $96.2 \pm 7.0$  for proteinase,  $93.8 \pm 6.9$  for ribonuclease,  $100.4 \pm 3.9$  for phosphatase, and  $108.5 \pm 5.0$  for  $\beta$ -N-acetylglucosaminidase.

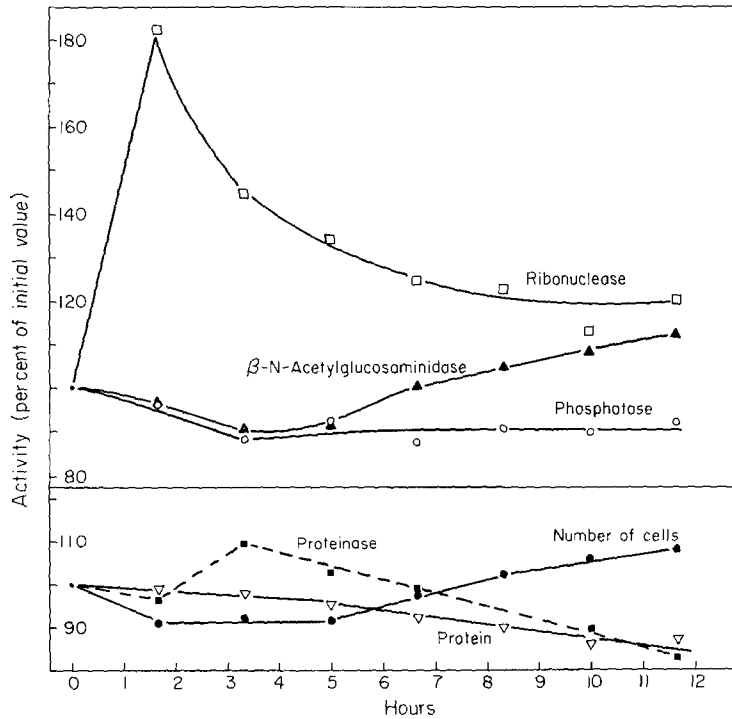

FIGURE 5 Changes in cell number, protein content, and enzyme activities during starvation. Same experiment as in Fig. 4.

The speed and extent of release vary considerably from one enzyme to another. They are greatest, reaching 60–70% of the total cell content in 5 hr, for amylase and the glycosidases, somewhat less pronounced, on the order of 40% in 5 hr, for phosphatase and deoxyribonuclease, still smaller for ribonuclease, and hardly detectable for proteinase.

In one experiment (Figs. 4 and 5), we followed the process of secretion over a longer period. For the first 5 hr, the pattern corresponds to that of

Fig. 2. After this period, the release of  $\beta$ -N-acetylglucosaminidase and of phosphatase continues at a reduced rate, but with little indication that the process would come to a standstill, and with no appreciable change in total enzymatic activities. In contrast, the rate of release of ribonuclease, though slow from the beginning, appears to remain unchanged throughout the experimental period. The total activity of this enzyme shows the initial jump already noted, and then declines progressively. This behavior is partly responsible for the

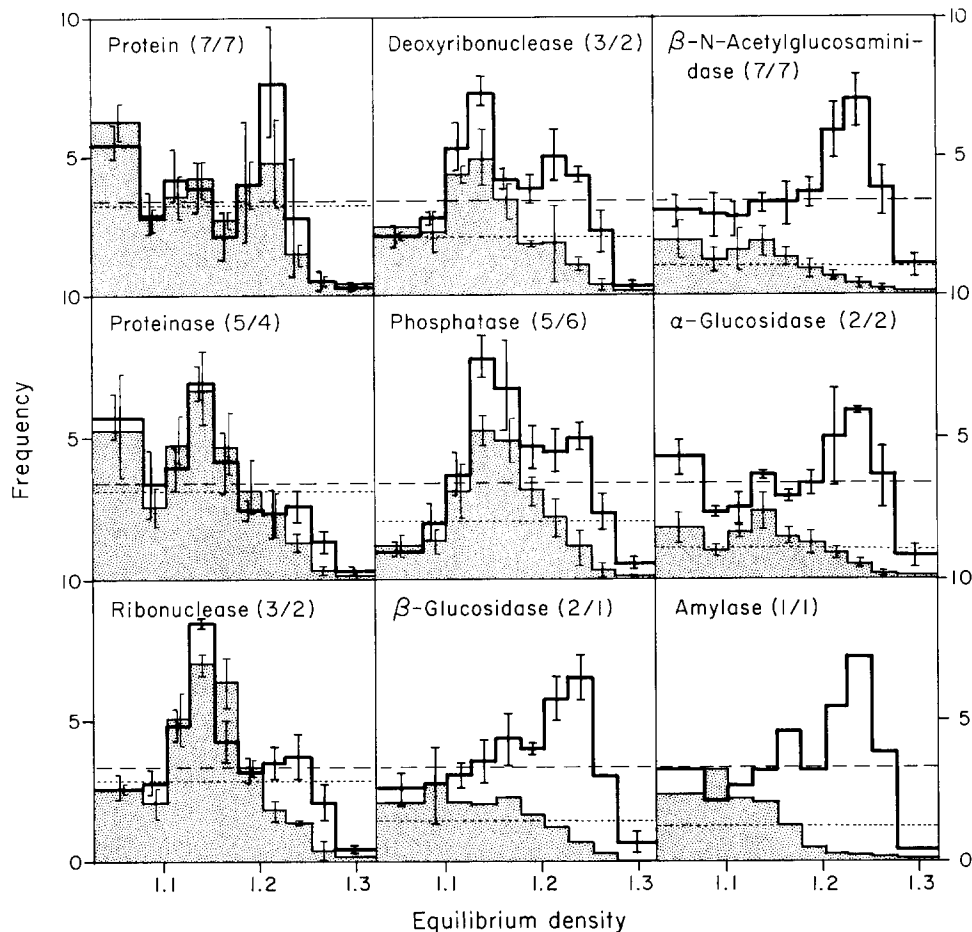

FIGURE 6 Distribution of acid hydrolases and protein after isopycnic gradient centrifugation of homogenates of *Tetrahymena pyriformis*. Histograms with thick outline give results for untreated animals, shaded histograms with thin outline for animals starved 5 hr. Averaged density-frequency histograms. Vertical line through histogram bars represents standard deviation. Number of experiments in parentheses (untreated/starved). For untreated cells, averaging includes also experiments reported earlier (16). First block with density below 1.08 represents over arbitrary density interval activities remaining in sample layer. The ordinates in the histograms for starved cells have been reduced by a factor equal to the proportion of the total enzyme activities remaining in the cells. These values, as well as the per cent recoveries, are listed in Table II.

apparent kinetic peculiarity of ribonuclease release. Were the results of Fig. 4 expressed in absolute value rather than in per cent of the total activity present, a distinct slowing down with time of ribonuclease secretion would be noticeable. As to protein and proteinase, their release remains very slow over the longer time period.

### Subcellular Distribution of Enzymes

In order to study the origin of the released enzymes, we compared the intracellular distribution of acid hydrolases in cells taken directly from the cultures and in cells that were starved for 5 hr, at which time enzyme release is well advanced.

In Fig. 6 are shown the distributions of protein and enzymes after isopycnic density-gradient centrifugation of homogenates. Complementary data are given in Table II. In order to make the changes brought about by starvation more evident, the ordinates of distribution histograms of the starved animals have been reduced by a factor equal to the loss of enzyme activity from the cells, and superimposed on the corresponding histograms of the untreated animals.

The distributions observed in the untreated animals are essentially those observed previously (16), to which must be added that of amylase, shown here for the first time. The pattern is bimodal for all acid hydrolases, but the proportion of activity banding in the denser regions varies from one enzyme to the other. It is highest for amylase and the other glycosidases, distinctly lower for the nucleases and phosphatase, and very small for proteinase, paralleling closely the rate of release of the enzymes. After 5 hr of starvation,

the dense lysosomal population is virtually depleted, leaving unimodal distribution patterns around a density of about 1.14. These results clearly point to the dense population as the main source of the enzymes appearing in the medium during starvation. This is true also for ribonuclease, indicating that preexisting enzyme, and not the newly appearing activity, is being secreted.

No changes due to starvation could be observed in the distribution of the mitochondrial marker, malate dehydrogenase, and of the peroxisomal marker, catalase (16, 18). The distribution of protein (Fig. 6) shows only small changes.

### Release of Enzymes during Culture Growth

In a few experiments, we resuspended the washed cells in Cox's medium to see how enzymes are released into the medium when cells do not starve. As shown in Fig. 7, enzyme release takes place essentially as in starved cells. At the same time, however, the total activities of the system increase, as does, after a short lag period, the number of cells (Fig. 8). For this reason, the graphs of Fig. 7, in which the secreted activities are expressed as per cent of the total activities present in the system at the same time, are somewhat misleading. When multiplied by the total activities shown in Fig. 8, the values of Fig. 7 indicate an extensive secretion of enzymes. For the glycosidases, an amount equal to that present initially in the cells is secreted within one generation time.

### DISCUSSION

The data presented above show that intact *Tetrahymena pyriformis* cells, whether kept in

TABLE II  
Complementary Data for Fig. 6

Enzyme	Activity remaining in cells after 5 hr of starvation (per cent of total)	Per cent recovery (mean $\pm$ sd) in gradients	
		Untreated	Starved
Protein	94.0	97.3 $\pm$ 5.7	95.6 $\pm$ 11.3
Proteinase	95.1	104.7 $\pm$ 19.2	100.7 $\pm$ 10.8
Ribonuclease	86.5	78.2 $\pm$ 2.1	90.6 $\pm$ 22.0
Deoxyribonuclease	62.8	110.7 $\pm$ 6.6	86.1 $\pm$ 11.9
Phosphatase	60.7	90.3 $\pm$ 10.9	83.0 $\pm$ 11.3
$\beta$ -Glucosidase	43.7	84.2 $\pm$ 2.9	88.9
$\beta$ -N-acetylglucosaminidase	31.0	86.9 $\pm$ 11.8	85.7 $\pm$ 10.9
$\alpha$ -Glucosidase	32.7	96.1 $\pm$ 9.6	90.0 $\pm$ 10.1
Amylase	37.2	70.4	67.9

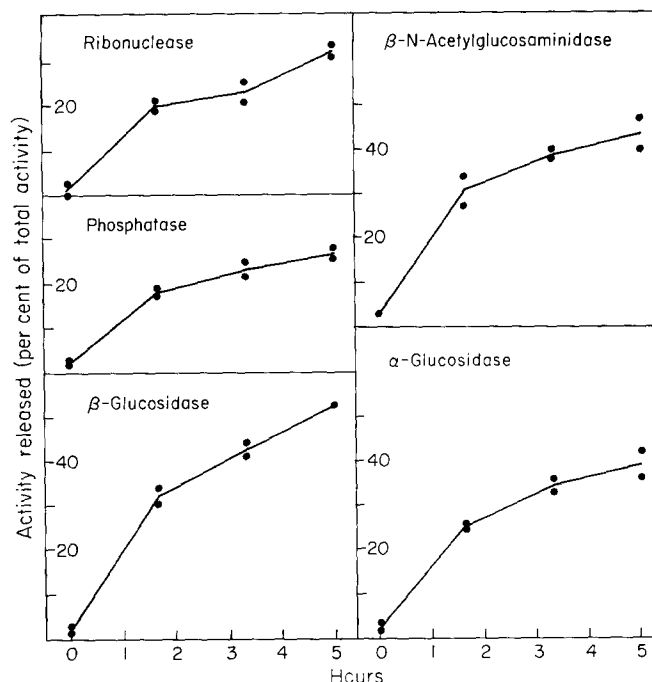

FIGURE 7 Enzyme activities released by *Tetrahymena pyriformis* cells which were resuspended in Cox's nutrient medium. Results of two experiments. Per cent recoveries (mean  $\pm$  sd) were  $110.5 \pm 7.9$  for ribonuclease,  $103.0 \pm 6.2$  for phosphatase,  $102.4 \pm 9.6$  for  $\beta$ -glucosidase,  $106.7 \pm 4.7$  for  $\beta$ -N-acetylglucosaminidase, and  $102.7 \pm 6.8$  for  $\alpha$ -glucosidase.

nutrient medium or starving, continually give off a variety of acid hydrolases. These data confirm earlier reports on the appearance of the acid hydrolases, amylase (20), ribonuclease (6), deoxyribonuclease (7), and phosphatase (20) in the culture medium during growth of this organism. Release of proteinase was also described (4, 5), but the enzyme exhibited properties (pH optimum close to neutrality and a dependence on sulfhydryl groups not observed with our proteinase) that clearly show that we are dealing here with a different enzyme.

Although decreases of hydrolase activities in starving *Tetrahymena* have been reported (10, 12, 13), the fate of the disappearing activities was never ascertained. Our results clearly show that the decrease of the cellular content of the hydrolases is paralleled by the appearance of the enzymes in the medium, and that the source of the enzymes is the previously described high-density lysosomal population, rich in glycosidases (16). The shift toward lower densities in the distribution of phosphatase and  $\beta$ -N-acetylglucosaminidase, noted by Lloyd and coworkers (13) in *Tetrahymena*

after 16 hr of starvation, is in good agreement with our results. The morphological identity of the particles responsible for the release is unknown. Electron microscope studies of the gradient fractions are underway to solve this problem.

The nature of the release process is still an open question. That we are dealing with a normal function seems to be established by the present work. In trying to characterize this phenomenon in more detail, we attempted to influence the release through induction of food-vacuole formation and thereby of defecation and through suppression of the contractile vacuole function. The results, to be published in a subsequent paper, suggest that the process is not dependent on these functions of the *Tetrahymena* cell. Accordingly, at the present time we feel that the release of hydrolases by *Tetrahymena* should be regarded as a secretory process.

*Tetrahymena pyriformis* lives in fresh-water habitats, usually in small numbers. Any enzymes released by these organisms will be diluted to such extent as to render them ineffective. In view of this, the existence of a subcellular particle popula-



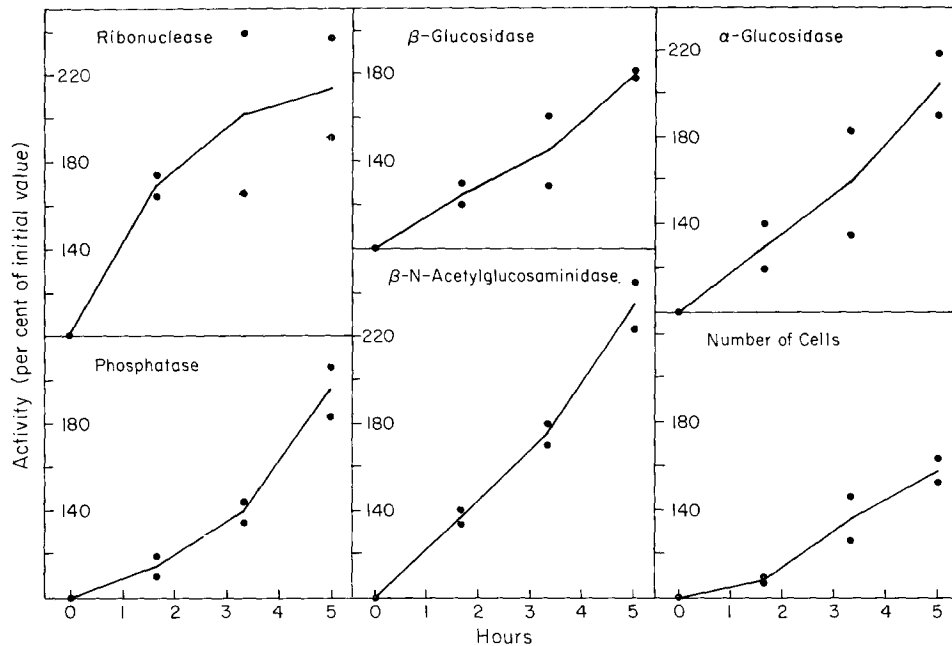

FIGURE 8 Changes in cell number and enzyme activities in the total system (consisting of cells and medium) in the experiments shown on Fig. 7.

tion in *Tetrahymena* with extracellular release of hydrolases as its only known function is an unexpected finding. It is even more remarkable if we consider how large the amounts of enzymes secreted in this rapid process are. It is difficult to assume that such secretion is without significance for the animal. Further work is needed to resolve this question.

The author wishes to thank Dr. Chrisitan de Duve for his unfailing interest in this work and many stimulating discussions, Dr. T. J. Peters for critical reading of the manuscript, Mrs. Cythinia Ward, Mrs. Bogumila Koss, and Mr. Armando Pelaschier for skillful assistance, and Dr. Brian Poole and Mr. Fred Davidson for performing the calculations on the computer.

This work was supported by grant No. GB-5796-X from the National Science Foundation.

Received for publication 16 August 1971, and in revised form 18 October 1971.

#### REFERENCES

1. BEAUFAY, H., D. S. BENDALL, P. BAUDHUIN, R. WATTIAUX, and C. DE DUVE. 1959. Tissue fractionation studies. 13. Analysis of mitochondrial fractions from rat liver by density gradient centrifuging. *Biochem. J.* 73:628.
2. CONNER, R. L., S. G. CLINE, M. J. KOROLY, and B. HAMILTON. 1966. A method for harvesting mass cultures of *Tetrahymena pyriformis*. *J. Protozool.* 13:377.
3. COX, D., O. FRANK, S. H. HUTNER, and H. BAKER. 1968. Growth of *Tetrahymena* in carbohydrate-free high-glutamate media. *J. Protozool.* 15:713.
4. DICKIE, N., and I. E. LIENER. 1962. A study of the proteolytic system of *Tetrahymena pyriformis* W. I. Purification and partial characterization of the constituent proteinases. *Biochim. Biophys. Acta.* 64:41.
5. DICKIE, N., and I. E. LIENER. 1962. A study of the proteolytic system of *Tetrahymena pyriformis* W. II. Substrate specificity of the constituent proteinases. *Biochim. Biophys. Acta.* 64:52.
6. EICHEL, H. J., N. CONGER, and E. FIGUEROA. 1963. Extracellular ribonuclease of *Tetrahymena pyriformis* and comparison of its properties with the intracellular ribonuclease. *J. Protozool.* 10:(Suppl.)6.
7. HAESSLER, H. A., and L. CUNNINGHAM. 1957. A comparison of several deoxyribonucleases of type II. *Exp. Cell Res.* 13:304.
8. HOGG, J. F., and H. L. KORNBERG. 1963. The metabolism of  $C_2$  compounds in micro-organisms. 9. The role of the glyoxylate cycle in protozoal glycogenesis. *Biochem. J.* 86:462.
9. JAHN, T. L., and E. C. BOVEE. 1964. Protoplasmic movements and locomotion in Protozoa. *In*

- Biochemistry and Physiology of Protozoa. S. H. Hutner, editor. Academic Press Inc., New York. 3:61.
10. LANTOS, T., M. MÜLLER, I. TÖRÖ, A. DRUGA, and I. VARGHA. 1964. Activity of acid phosphatase and protease in *Tetrahymena pyriformis* GL of different states of nutrition. *Acta Biol. Acad. Sci. Hung. Suppl.* 6:29.
  11. LEIGHTON, F., B. POOLE, H. BEAUFAY, P. BAUDHUIN, J. W. COFFEY, S. FOWLER, and C. DE DUVE. 1968. The large-scale separation of peroxisomes, mitochondria, and lysosomes from the livers of rats injected with Triton WR-1339. Improved isolation procedures, automated analysis, biochemical and morphological properties of fractions. *J. Cell Biol.* 37:482.
  12. LEVY, M. R., and A. M. ELLIOTT. 1968. Biochemical and ultrastructural changes in *Tetrahymena pyriformis* during starvation. *J. Protozool.* 15:208.
  13. LLOYD, D., R. BRIGHTWELL, S. E. VENABLES, G. I. ROACH, and G. TURNER. 1971. Subcellular fractionation of *Tetrahymena pyriformis* st by zonal centrifugation: changes in activities and distribution of enzymes during the growth cycle and on starvation. *J. Gen. Microbiol.* 65:209.
  14. MÜLLER, M. 1967. Digestion. In *Chemical Zoology*. M. Florin and B. T. Scheer, editors. Academic Press Inc., New York. 1:350.
  15. MÜLLER, M. 1970. Release of hydrolases by *Tetrahymena pyriformis*. *J. Protozool.* 17(Suppl.): 13.
  16. MÜLLER, M. 1971. Lysosomes in *Tetrahymena pyriformis*. II. Intracellular distribution of several acid hydrolases. *Acta Biol. Acad. Sci. Hung.* 22:179.
  17. MÜLLER, M., P. BAUDHUIN, and C. DE DUVE. 1966. Lysosomes in *Tetrahymena pyriformis*. I. Some properties and lysosomal localization of acid hydrolases. *J. Cell. Physiol.* 68:165.
  18. MÜLLER, M., J. F. HOGG, and C. DE DUVE. 1968. Distribution of tricarboxylic acid cycle enzymes and of glyoxylate cycle enzymes between mitochondria and peroxisomes in *Tetrahymena pyriformis*. *J. Biol. Chem.* 143:5385.
  19. PRESCOTT, D. M. 1956. Mass and clone culturing of *Amoeba proteus* and *Chaos chaos*. *C. R. Lab. Carlsberg. Ser. Chim.* 30:1.
  20. SMITH, I. 1961. Extracellular enzyme production in *Tetrahymena pyriformis*. Ph.D. Thesis. Columbia University, New York.
  21. STRUMEYER, D. M., and A. T. ROMANO. 1966. Automated assay of submicrogram levels of amylase by a reducing sugar procedure. *Automat. Anal. Chem. Technicon Symp.* 1:469.