

# Seismic Design of Multi-Storey Buildings using Laminated Veneer Lumber (LVL)

A. Palermo, S. Pampanin, A. Buchanan, & M. Newcombe

*Department of Civil Engineering, University of Canterbury, Christchurch.*



2005 NZSEE  
Conference

**ABSTRACT:** The recent development of laminated veneer lumber (LVL) as an alternative to solid timber or glue-laminated timber has greatly improved the viability of structural timber for the seismic design of certain types of buildings. The low mass, flexibility of design and rapidity of construction all create the potential for increased use of LVL timber in low-rise multi-storey buildings. Based on recent developments in the seismic design of precast concrete for multi-storey buildings, proposals are made for innovative types of jointed ductile connections in LVL timber buildings, based on post-tensioning techniques to assemble structural members for both frame and wall systems. This contribution gives an overview of an ongoing comprehensive research project involving both numerical and experimental investigations. The extremely satisfactory preliminary results of quasi-static cyclic tests of exterior beam-column joint subassemblies are presented as a confirmation of the expected high seismic performance of the proposed solutions for LVL seismic resisting systems.

## 1 INTRODUCTION

Significant advances have been observed in the last decade in the seismic protection of structures with the introduction and further refinements of performance-based seismic design/engineering (PBSE) philosophies, as a rationalization of the well-known and traditionally accepted limit state design approach. Within a typical performance-based design framework, different levels of structural damage and, consequently, repair costs (associated with performance levels related to Operational Conditions, Damage Control, Life Safety and Collapse Prevention) may be expected, depending on the seismic intensity and the importance given to the structural facilities during the design process, typically accepted as unavoidable result of the inelastic behaviour.

Current seismic design philosophies emphasize the importance of designing ductile structural systems to undergo inelastic cycles during earthquake events while sustaining their integrity, recognizing the economic disadvantages of elastic design of buildings to withstand earthquakes with no structural damage. This particularly applies to multi-storey buildings in moderate or high seismic regions.

Independent of the structural material (i.e. concrete, steel, timber), typical solutions to achieve adequate global ductile behaviour rely on the inelastic behaviour of the material, allowing for discrete “sacrificial” plastic deformation in selected regions, designed according to capacity design principles in order to protect the whole system from undesired inelastic mechanisms.

However, given the observed extent of the excessively severe socio-economic losses following recent earthquake events, even in well developed seismic-prone countries, it is becoming accepted that more emphasis should be given to a damage-control design approach.

In line with the aforementioned objectives, revolutionary and emerging solutions have been developed under the U.S. PRESSS (PREcast Structural Seismic Systems) programme coordinated by the University of California, San Diego (Priestley et al. 1999) for the seismic design of multi-storey precast concrete buildings (subsequently applied to steel constructions) with the introduction of “dry” jointed ductile systems, alternative to traditional emulative cast-in-place solutions and based on the use of unbonded post-tensioning techniques. As a result, extremely efficient structural systems are

obtained, which can undergo large inelastic displacements similar to their traditional counterparts (monolithic connections), while limiting the damage to the structural system and assuring full re-centring capability after the seismic event.

This paper proposes innovative solutions for LVL seismic moment-resisting frames or shear wall systems within multi-storey buildings, based on jointed ductile connections.

Deleted: ,

After a brief overview of the conceptual behaviour and design of jointed ductile connections and systems, preliminary results of experimental tests on beam-column joint subassemblies will be presented and critically discussed.

## 2 EVOLUTION TOWARDS JOINTED DUCTILE CONNECTIONS AND HYBRID SYSTEMS

### 2.1 Traditional moment resisting connections in timber buildings

Several alternative solutions to provide moment-resisting connections in timber construction have been studied and developed in literature, for both lateral load resisting wall or frame systems. Feasibility studies of multi-storey timber buildings have been described by (Halliday & Buchanan, 1993) and (Thomas et al., 1993). Depending on the type of connection and structural details, many alternative arrangements are available ranging from mechanically fastened solutions with nailed, bolted or dowel connections to glued or epoxied steel rods. These solutions apply to solid sawn timber in large sizes, glue laminated timber (glulam), or LVL. Significantly different forms of inelastic behaviour can occur, leading to different levels of ductility capacity and hence different overall structural performance. Typical pinching phenomena can be observed in the hysteresis behaviour of nailed or steel rods connections (Fig. 1a) which leads to a reduction of stiffness (both loading and unloading) as well as a reduction of energy dissipation capacity, leading to higher displacement demand (thus damage) than well designed steel or concrete structures. These hysteresis loops are similar to those achieved in structural walls with nailed plywood sheathing (Deam 1997).

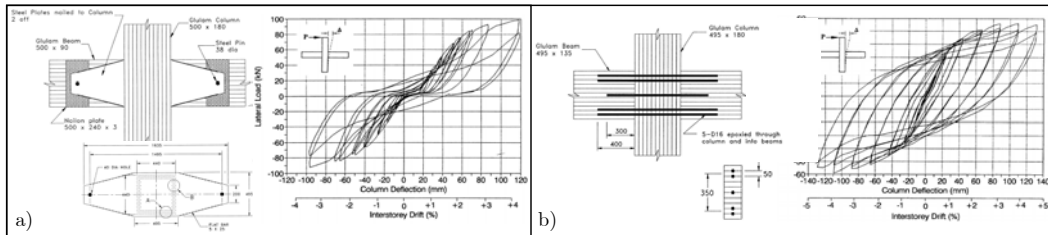

Figure 1. Layout and hysteresis loop for frame systems: a) multiple-nailed connection; b) epoxied rods glulam solution (Buchanan & Fairweather, 1993).

In an overview of seismic resisting solutions for multi-storey glulam timber buildings, (Buchanan & Fairweather, 1993) proposed alternative arrangements for steel epoxied connections with or without additional steel sacrificial brackets to accommodate the inelastic behaviour. In particular the simplest version of the connection (Fig. 1b) showed satisfactory behaviour under cyclic loading, similar to the behaviour of a properly designed plastic hinge in reinforced concrete members, with a stable dissipating hysteresis loop and limited stiffness degradation.

However in the same way as for monolithic concrete or steel solutions, excessive residual (permanent) deformations would be expected after an earthquake event, even if the building has been designed according to current code provisions. These permanent deformations will result in a high cost of repairing, if still possible, with the difficulty of straightening the building to its original position. Recent developments in performance-based seismic design and assessment have emphasised the importance of properly assessing and limiting the residual deformations, considered to be a fundamental complementary indicator of the structural and non-structural damage (Kawashima & MacRae 1997), (Christopoulos et al. 2002), (Pampanin et al. 2002).

## 2.2 The examples of concrete and steel

Recent developments in precast concrete moment resisting frames (MRF) or interconnected shear walls (Priestley et al., 1999) (Fig. 2a), as well as subsequently in steel moment-resisting frames (Christopoulos et al., 2001), (Fig. 2b), have resulted in structural systems which can undergo inelastic displacements similar to their traditional counterparts, while limiting the structural damage and assuring full re-centring capability. In these innovative solutions, typically referred to as jointed ductile connections, alternative to monolithic solutions (i.e. cast-in-place solutions in reinforced or precast concrete; welded or bolted connections in steel), precast elements are connected by using unbonded post-tensioning techniques and the inelastic demand is accommodated within the connection itself through the opening and closing of an existing gap, while the structural elements are kept within the elastic range with a very limited level of damage. These connections can be located at the beam-to-column, column-to-foundation or wall-to-foundation critical interface.

A particularly efficient solution was provided by the “hybrid” system (Fig. 2a) where an adequate combination of self-centring capacity (unbonded tendons plus axial load) and energy dissipation (mild steel or additional dissipation devices) leads to a sort of controlled rocking motion defined by a peculiar “flag-shaped” hysteresis loop (Fig. 2c).

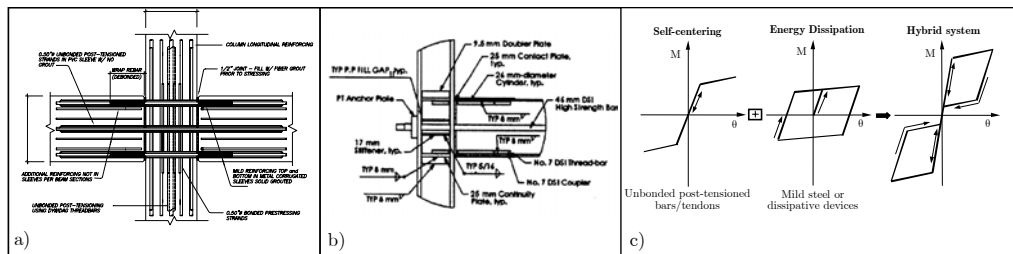

Figure 2. Hybrid solutions: a) for precast concrete frame systems (PRESSS program, Priestley et al., 1999); b) for steel Moment Resisting Frames (Post-Tensioned Energy Dissipation, PTED, Christopoulos et al. 2001); c) idealised flag shape hysteresis loop.

## 2.3 Proposed solution: hybrid LVL systems

In this paper, the concept of hybrid or controlled rocking systems is proposed to be extended to timber structures (frame and walls systems), with particular emphasis on Laminated Veneer Lumber (LVL) solutions for multi-storey frame or shear wall systems.

As a structural material, LVL can be considered as a superior alternative to sawn timber or glulam because the 3 mm thick veneers are specially selected, then staggered during processing so that the selected wood material is thoroughly mixed and the defects, such as knots, are randomised to a point where their influence on the material properties can be assumed negligible. Due to the higher homogeneity, the tension strength of LVL can reach values at least 3 times that of sawn timber from the same population of trees. However it is worth underlining that the hybrid connection (Fig. 3) is not significantly affected by the strength of the material, provided that proper confinement is given to the compression area to avoid crushing of the edge layers, hence this type of connection can be used with different wood-based materials (i.e., sawn timber, glulam etc).

As mentioned, a “controlled rocking” motion occurs in hybrid jointed ductile connections as shown in Figure 3 for a typical hybrid frame beam-column subassembly. A similar conceptual mechanism can be developed in hybrid timber walls. When compared to traditional solutions, i.e. nailed or steel dowel connections where moderate to extensive damage of the connection is expected to occur at code-design ductility level, the inelastic demand in a hybrid solution is accommodated at the column-to-beam interface (wall-to-foundation for wall systems) through the opening and closing of an existing gap and yielding of the mild steel or the dissipation devices (internal or external). If correctly designed and detailed, negligible crushing of the LVL material in the beam-column (or wall) elements is thus expected.

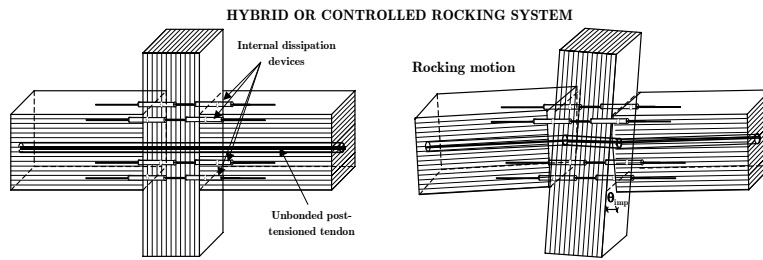

Figure 3. Application of Hybrid Concept to LVL frame systems.

### 3 BRIEF OVERVIEW OF THE RESEARCH PROGRAM

An extensive research programme has been planned in order to investigate the seismic performance of innovative LVL connections relying on the extension of the concepts from reinforced concrete precast hybrid systems. These concepts will be applied to frame, wall and dual systems, in order to evaluate possible applications within the New Zealand construction industry. The programme will involve a comprehensive numerical and experimental investigation of both subassemblies and whole lateral force resisting systems.

In the first phase of the research program, started under a joint agreement between the University of Canterbury and Carter Holt Harvey, particular emphasis is given to the conceptual development, design details, construction and experimental tests under a quasi-static loading regime. The study will include beam-column subassemblies, column-to-foundation connections and shear wall specimens. Current testing includes a series of uni-axial and bi-axial quasi-static tests under lateral loading on various beam-column subassembly specimens in 2-D and 3-D configurations (Fig. 4). Preliminary results are given below.

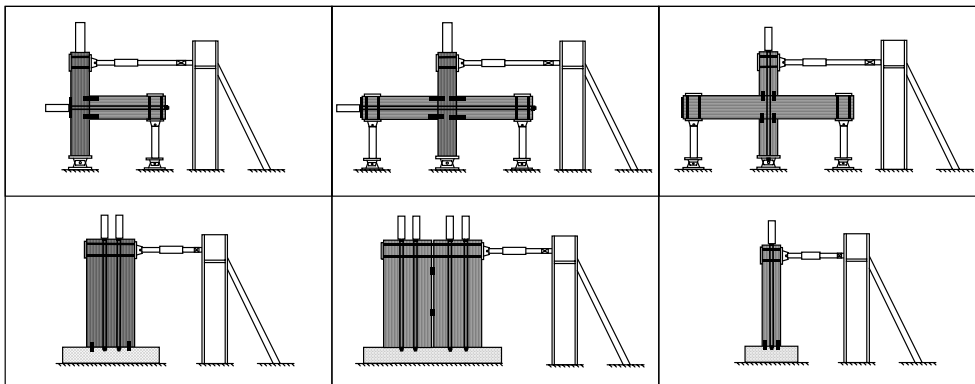

Figure 4. Exterior, interior beam-column subassemblies, single, coupled walls and columns specimens.

In the second phase of the research, particular attention will be given to the global seismic performance of hybrid LVL systems with hybrid solutions. The seismic behaviour of coupled wall systems, multi-storey seismic-resisting frames (with straight or draped profiles of the unbonded tendons, either internal or external) and dual systems will be investigated through quasi-static experimental tests and extensive parametric numerical analyses. Critical comparison with the response of typical “damageable” solutions will be looked at.

In a third and conclusive phase, issues related to displacement incompatibility between the lateral-load resisting systems and the floor diaphragms behaviour will be investigated. Alternative floor solutions, either based on timber or composite timber-concrete solutions with or without prestressing, will be considered with the aim of developing adequate connections between floors and the adjacent lateral load resisting system.

The design, construction and large scale testing of a multi-storey building comprising of frames, walls and floors would represent the ultimate validation of the proposed solutions. Simplified design provisions and guidelines for the next generation of codes will need to be produced. Validation and refinement of the existing analytical models available in literature for hybrid systems developed for precast concrete connections, as presented by (Pampanin & Nishiyama 2002) and (Carr 2004) will need to be adequately modified for LVL connections, and carried out through the whole research programme.

#### 4 EXPERIMENTAL INVESTIGATIONS ON BEAM-COLUMN SUBASSEMBLIES

This paper presents the preliminary results of experimental tests on exterior beam-column subassemblies using both a pure unbonded solution and a hybrid solution.

##### 4.1 Test Set-up and loading history

The adopted test set-up for quasi-static tests on beam-column joint subassemblies is shown in Figure 5. The beam (1.5m long) and column (2.0m long) elements were loaded at the points of contraflexure (assumed to be at mid-span of the beam and at mid-height of the column). The simple support at the beam end is obtained by connecting a pin-ended steel member to the strong-floor. A series of three cycles of inter-storey drift was applied at increasing levels through the horizontal hydraulic actuator, following the testing protocol for acceptance criteria through tests on innovative jointed precast concrete frame systems proposed by ACI T1.1-01, ACI T1.1R-01 document (2001). The column axial load was kept constant during the experiments (120 kN).

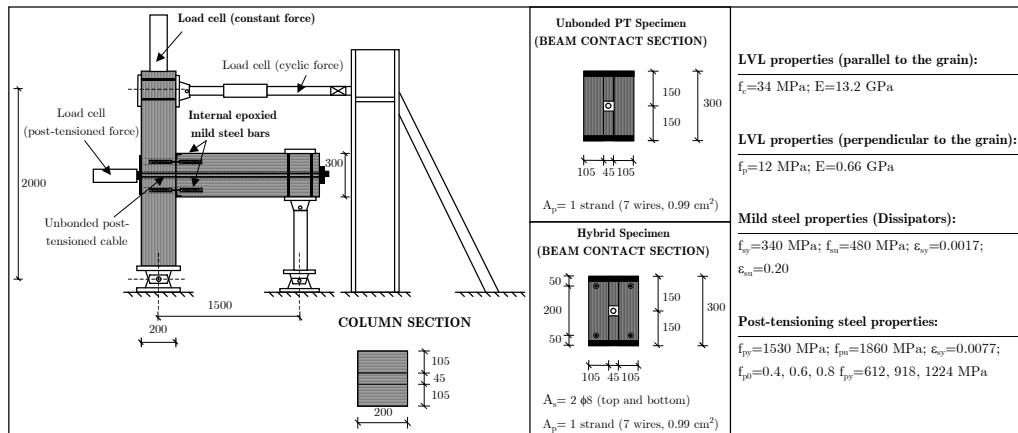

Figure 5. Test set-up, specimen details and material properties of LVL, post-tensioning and mild steel.

##### 4.2 Geometry, reinforcement and material details

Figure 5 shows the geometry of an exterior beam-column subassembly, common for all the three specimens herein considered: two pure unbonded post-tensioned solutions with different initial values of post-tensioning ( $0.4f_{py}$  and  $0.6f_{py}$ ,  $f_{py}$  being the yield stress of the post-tensioning steel) and one hybrid solution with internal energy dissipators. Details of the beam sections at the column interface are shown in the central section of Figure 5. The material properties shown in Figure 5, which are based on specific material testing, highlight the significantly different behaviour of LVL material in the directions parallel and perpendicular to the grain. As a result, a significant reduction in strength (up to three times) and increase in deformability due to the much smaller elastic modulus (in the order of twenty times) has to be expected when loading perpendicular to the grain. This becomes a limiting consideration for the face of the column member where it is in contact with the end of the beam.

Figure 6 shows the details of the internal energy dissipators for the hybrid solutions. Two deformed

bars  $\phi 10$  mm (grade 340), machined down to a reduced diameter ( $\phi 10$  mm) to create a fuse along an unbonded length of 50 mm, were located at the top and bottom of the critical beam-column interface and epoxied to guarantee proper bond. The unbonded length was specifically designed in order to limit the strain demand at the location of the gap opening and prevent a premature failure of the energy dissipators which could compromise the overall performance of the hybrid solution.

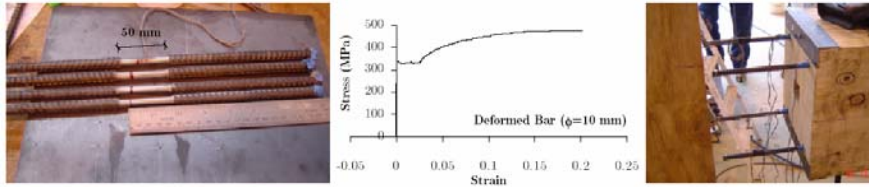

Figure 6. Internal dissipators (deformed bars with necked and taped fuses for unbonded length of 50 mm), stress-strain behaviour and construction details.

### 4.3 Experimental Results

#### 4.3.1 Pure Unbonded Post-Tensioned Solutions

Two specimens using pure unbonded post-tensioned systems (i.e. the extreme case of a hybrid system with no specific energy dissipation devices) were tested with different levels of initial post-tensioning ( $0.4 f_{py}$  and  $0.6 f_{py}$ ) under the aforementioned loading protocol. Figure 7a shows the recorded values of lateral force vs. inter-storey drift (ratio of top-displacement and column height), mainly characterised, as expected, by a non-linear elastic hysteresis with fully re-centring properties.

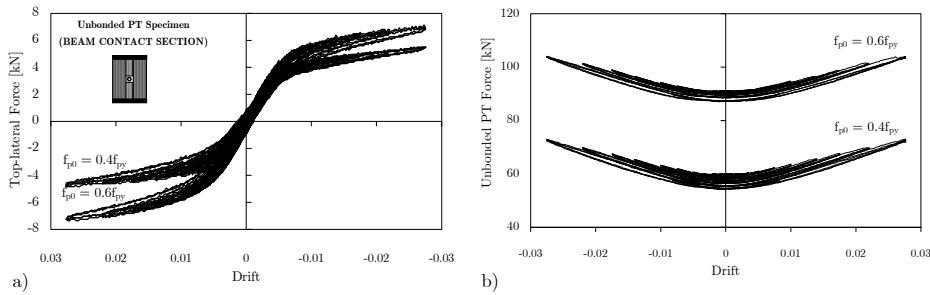

Figure 7. Unbonded post-tensioned solution: a) lateral force-drift; b) force vs. drift for the unbonded prestressing tendon.



Figure 8. Unbonded post-tensioned solution: performance of the specimen ( $0.6 f_{py}$ ) at drift level of 2.75%.

There is a minor amount of hysteretic dissipation given by the local non-linear behaviour of the LVL material at the column contact section, loaded in compression perpendicular to the grain. Similarly to what is observed in precast concrete hybrid solutions, the hysteresis curve shows non linear behaviour with a “knee-point” (equivalent “yielding”), which is due to geometrical non-linearity, not related to

material non-linearity. The geometrical non-linearity results from a reduction of section stiffness due to a sudden relocation of the neutral axis position. The reduced stiffness after the equivalent “yielding” corresponds to an increase in moment capacity primarily due to the elongation of the tendons as confirmed in Figure 7b. As anticipated, and shown in Figure 8, no visible damage could be detected in the structural elements when lateral deformations were increased to 2.75% inter-storey drift. The test was interrupted only to preserve the column test specimen from possible compression crushing damage before modifying it for a hybrid solution.

#### 4.3.2 Hybrid Solution

The specimen which had been tested up to 4.5% drift in the pure unbonded post-tensioned case was provided with additional internal dissipation devices, consisting of epoxied deformed mild steel bars with an original diameter  $\phi$  10 mm reduced to a  $\phi$ 8 mm for an unbonded length of 50 mm. A comprehensive design calculation of the dissipators was carried out in order to guarantee the desired ratio,  $\lambda$ , between the self-centring moment contribution and the energy-dissipating moment contribution, assuming an initial post-tensioning level of  $0.8 f_{py}$ . As a result, a very stable flag-shape hysteresis behaviour was obtained as expected with re-centring capacity (negligible static residual displacements) and adequate energy dissipation capacity, as shown in Figure 9a.

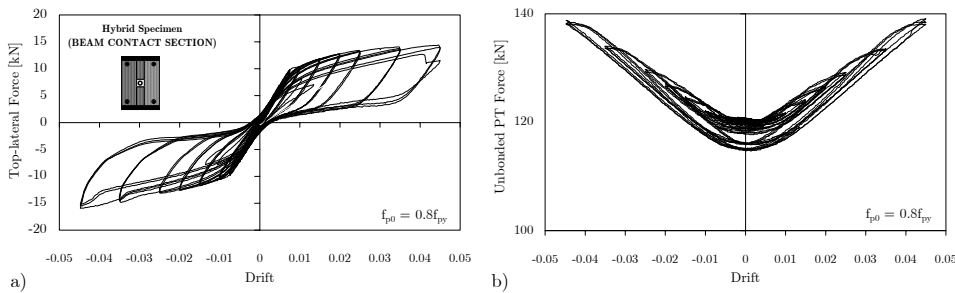

Figure 9. Hybrid solution: a) lateral force-drift; b) force vs. drift for the unbonded prestressing tendon.



Figure 10. Hybrid solution: performance of the specimen at 4.5% drift.

In this case the equivalent yielding point corresponds to actual yielding of the dissipation devices, observed at 0.8% inter-storey drift. During repeated cycles at a medium-high level of drift, some onset of stiffness degradation was observed, probably due to bond deterioration between the deformed mild steel bars and LVL through the epoxy. This reduction of stiffness is negligible when compared to the marked pinching behaviour of typical nailed solutions shown in Figure 1. As confirmed by Figure 9b, the level of tendon force due to initial prestressing plus elongation induced by the opening of the gap can be controlled with a proper design in order to guarantee an elastic contribution (full re-centring) without losses of prestress or undesired rupture of dissipators, up to the target level of drift. In this case an increase of 15% of the initial prestressing force was observed at 4.5% drift.

Figure 10 shows no visible damage in the beam or the column occurred while the failure of one dissipator under repeated cycles after buckling in the unbonded length occurred at the third cycle to 4.5% drift in the positive direction.

## 5 CONCLUSIONS

The preliminary experimental results of quasi-static tests on hybrid beam-column joints in LVL subassemblies provided encouraging confirmation of the enhanced performance of jointed ductile connections.

The lack of damage in the structural elements, combined with appropriate energy dissipation capacity provided by the dissipators, and self-centring properties provided by the unbonded post-tensioned tendons can guarantee improved seismic performance when compared to the traditional solutions for timber construction (e.g. nailed or steel dowel connections). High levels of ductility can be achieved without degradation of stiffness or strength and without residual deformations and structural damage, leading to a significant reduction of the repair costs (including downtime) after a significant seismic event.

The flexibility of design and speed of construction of the LVL components, combined with the enhanced seismic performance of the hybrid solutions, creates unique potential for future development and increased use of this type of construction in low-rise multi-storey buildings in New Zealand.

Based on these strong but preliminary indications, further investigations for the development of hybrid solutions using LVL materials are currently on-going and will be extended to cover alternative lateral resisting systems including frame, wall and dual systems.

## ACKNOWLEDGEMENTS

The financial support provided by Carter Holt Harvey Futurebuild within a joint research program with the University of Canterbury is gratefully acknowledged.

## REFERENCES:

- ACI T1.1-01 & ACI T1.1R-01 2001. Acceptance Criteria for Moment Frames Based on Structural Testing (T1.1-01) and Commentary (T1.1R-01), ACI Innovation Task Group 1 and Collaborators.
- Buchanan, A.H. & Fairweather R.H. 1993. Seismic Design of Glulam Structures, *Bulletin of the New Zealand National Society for Earthquake Engineering*, Vol 26(4) 415-436.
- Carr, A.J. 2004. RUAUMOKO Program for Inelastic Dynamic Analysis – Users Manual”, Department of Civil Engineering, University of Canterbury, Christchurch, New Zealand.
- Christopoulos, C., Pampanin, S. & Priestley M.J.N. 2003. Performance-Based Seismic Response of Frame Structures including Residual Deformations. Part I: Single-Degree-of-Freedom Systems; *Journal of Earthquake Engineering*, Vol 7(1) 97-118.
- Christopoulos, C., Filiatrault, A., Uang, C.M. & Folz, B. 2002. Post-tensioned Energy Dissipating Connections for Moment Resisting Steel Frames, *ASCE Journal of Structural Engineering*, Vol. 128(9) 1111-1120.
- Deam, B. 1997. Seismic Design and Behaviour of Multi-storey Plywood sheathed timber framed Shearwalls, *Research Report No 97/3*, Department of Civil Engineering, University of Canterbury.
- Halliday, M.A. & Buchanan, A.H. 1993. Feasibility of Medium Rise Office Structures in Timber, *IPENZ Transactions*, Vol. 19, No.1/CE. 13-20.
- MacRae, G.A. & Kawashima, K. 1997. Post-earthquake Residual Displacements of Bilinear Oscillators, *Earth. Earthquake Engineering and Structural Dynamics*, Vol 26 701-716.
- Pampanin, S. & Nishiyama, M. 2002. Critical Aspects in Modeling the Seismic Behavior of Precast/Prestressed Concrete Building Connections and Systems. *Proceedings of the 1<sup>st</sup> fib Congress*, Osaka, October 13<sup>th</sup>-19<sup>th</sup>, (computer file).
- Priestley, M.J.N., Sritharan, S., Conley, J. R. & Pampanin, S. 1999. Preliminary Results and Conclusions from the PRESS Five-story Precast Concrete Test-building, *PCI Journal*, Vol 44(6) 42-67.
- Thomas, G.C., Buchanan, A.H. & Dean J.A. 1993. The Structural Design of a Multi-storey Light Timber Frame Residential Building, *IPENZ Transactions*, Vol. 19, No.1/CE. 35-41.