

Settlement Prediction of Stone Column Group

K. S. Ng¹ · S. A. Tan²

Received: 7 August 2015 / Accepted: 12 September 2015 / Published online: 23 October 2015
© Springer International Publishing AG 2015

Abstract Stone columns can be designed to bear on the hard stratum or as a floating system where the toe is embedded in the soft layer. Most of the existing design methods for stone columns adopt unit cell idealization which is not applicable to spread footing. From the view of settlement analyses, current available methods to evaluate the settlement performance of a footing on a limited number of stone columns are more or less rough approximations derived from the elastic theory or using simple empirical approach. None of these methods incorporate the idea of optimum length and the yielding effect in the plastic zone. This paper introduces a new mechanical method to account for these. This method works for homogenous and non-homogenous ground condition. The settlement predictions made by the proposed method are compared with the finite elements results and field measurement. Good agreements are obtained not only for load settlement response but also the displacement profile.

Keywords Stone columns · Settlements · Small foundation · Finite element method

Introduction

Two essential criteria that govern the design of foundation are ultimate bearing capacity and tolerable settlements. In many cases, it is more likely that settlements under operating conditions than bearing capacity is more critical. Stone columns have been proven to reduce the induced settlement by making the composite ground stiffer [1–3]. The load carrying mechanism for small column groups is different from large loaded areas [4]. There exists a complex interaction between column-soil, column-column, column-footing and soil-footing [5, 6]. Moreover, the vertical stress beneath the footings decays rapidly with depth, allowing floating columns (partial depth treatment) to be used. In most applications, the column heads are not in direct contact with the applied load, but normally distributed via a load transfer layer e.g. granular mat. Very few designs are developed for small column groups and all make major simplification, especially for the settlements calculation [7]. McCabe et al. [3] commented on the great number of field data pertaining to large loaded area, but very few data for strip or pad footings on small column groups.

By using the concept of equivalent coefficient of volume compressibility, Rao and Ranjan [8] proposed a simple elasticity theory-based method to predict the settlement of soft clay reinforced with floating stone columns under footing or raft foundation. The calculation methodology is similar to the equivalent raft or pier method [9–11]. The equivalent coefficient of volume compressibility is applied for the improved layer only. The applied stress is assumed to dissipate at $2V:1H$ from the base of the footing depth. The total settlement for the floating system is then calculated from the sum of settlement contributed from the improved layer and the unimproved layer. This simple

✉ K. S. Ng
ngkokshien@ppinang.uitm.edu.my
S. A. Tan
ceetansa@nus.edu.sg

¹ Faculty of Civil Engineering, University Teknologi MARA, Campus Pulau Pinang, 13700 Permatang Pauh, Malaysia

² Department of Civil and Environmental Engineering, University of Singapore, Singapore 119260, Singapore

analytical method does not justify the load sharing mechanism correctly due to the assumptions that the stress concentration ratio is proportional to the respective elastic modulus thus resulting in overestimation of the load that can be carried by the columns. In addition, a few important design factors (e.g. plastic straining, deformation modes, optimum length) are not considered.

Based on elastic and spring theory together with the assumption of the Westergaard stress distribution, Lawton and Fox [12] proposed a settlement analysis method for rammed aggregated piers, RAP. This improvement system is normally of short floating columns so the analysis is separated into two zones. The upper zone thickness includes the column length plus one diameter of the column while the lower zone extends to a depth of twice the footing width (i.e. square footing) measured from the bottom of the footing. Calculation of settlement for upper zone required spring stiffness (coefficient of subgrade reaction) constant which is best obtained through a field load test because it is not a fundamental soil parameter; rather it is dependent on the dimensions of the foundations. Conventional consolidation settlement theory or elastic settlement procedures can be used for the lower zone, as appropriate.

Unlike piles, stone column material is compressible that even at small working loads, nonlinear behavior of the soils and columns could influence the column settlements significantly. The importance of nonlinear stress–strain characteristics in the soil–structure interaction has also been highlighted by Jardine et al. [13]. Due to these reasons, the consistent success in predicting the settlement performance of floating group columns has remained elusive for the methods that are based on the simple elastic theory or Winkler spring concepts [14].

On the other hand, the numerical approach (e.g. finite element and finite difference) is best known as the most rigorous solution to obtain accurate displacement profiles of complex foundations, as in this case the stone column reinforced foundation. However, the approach requires high computational effort and is time consuming especially for full three dimensional models and is often too difficult for practicing engineers. Use of more sophisticated soil models to capture the nonlinear behavior, and realistic soil–column interaction complicates the problem further especially when the soil parameters are difficult to obtain by conventional field and laboratory tests.

From a practical viewpoint, there should be a method which is simple, but based on a sound theoretical basis and able to capture the major features of the problem with important parameters considered. Hence, a method with above attributes was developed to predict the settlements for foundation supported by a group of stone columns. This method is extended from the Tan et al.'s [15] work where

FEM drained (long term with no excess pore pressure built up) analyses was performed on the small floating columns group in soft ground subjected to a typical working loading range of 0–150 kPa. The idea of optimum length is incorporated into this method.

Optimum (critical) Length Determination

The finite element study by Tan et al. [15] and Wood [16] showed the existence of the optimum length, L_{op} for stone columns which is the column length where lengthening it will not significantly contribute to the reduction of settlement. The optimum length, L_{opt} for stone columns are controlled by the dimension of the footing and somewhat influenced by the footprint replacement ratio, A_F . Numerical models and small model tests [16] indicated the failure mechanism occurred in the conical region as shown in Fig. 1. The angle δ is influenced by the footprint replacement ratio and the composite strength, ϕ_{comp} of improved layer, estimated as:

$$\delta = 45^\circ + \frac{\phi_{comp}}{2} \quad (1)$$

$$\tan \phi_{comp} = A_F \tan \phi_c + (1 - A_F) \tan \phi_s \quad (2)$$

The quantity $A_F = A_c/A_f$ is referred as the footprint replacement ratio (A_f is the footing area, and A_c is the total area of stone column). Similar to the area replacement ratio in infinite grid columns, it is a measure of the extent to which the soil area under the footing is replaced by the column material. The symbols of ϕ_c and ϕ_s are the internal friction angle of the column and soil respectively.

Subsequently, the wedge failure depth, l_c can be calculated easily. The value of $\delta = 59^\circ$ – 63° , and $l_c = 0.832D$ – $0.981D$ were estimated for $A_F = 0.2$ – 0.7 if $\phi_c = 40^\circ$ and $\phi_s = 25^\circ$ are used (NOTE: D = diameter of the footing, not the diameter of the column). In this case, intuition tells

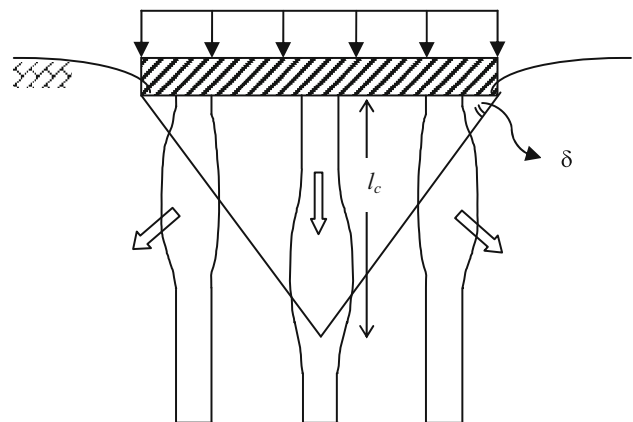

Fig. 1 Failure mechanisms of group columns (adapted from Wood [16])

us that the column length should surpass this failure depth for optimal design of the floating stone column. On one hand, Tan et al. [15] demonstrated that in all the analyzed cases (4, 9, 16, 25, 36, 49, 64, 81 and 100 numbers of columns), the L_{opt} are ranging from $1.20D$ to $2.2D$ (higher than the wedge failure depth l_c obtained above) for footprint replacement ratio from 0.2 to 0.7. In the authors' analysis, spread footings were placed upon a 0.5 m thick transfer layer (granular mat or crust) overlying soft soil. Thus, it was suggested that the optimum length can be assumed as shown in Table 1 based on numerous trial to fit the total settlement and settlement profile. These ranges of values are not exact for all cases because the number of columns in a group, e.g. 9, 16, 25, 36, 49, 64, 81 and 100, also affects the figure slightly taken that the footprint replacement ratio is the same for these numbers of groups. The concept of design with the incorporation of stone column optimum length is the first of its kind. It is useful for the column groups with columns toe resting on a compressible soil layer while the foundation is uniformly loaded.

It is the common belief that there exists no rational relationship between the settlement of single column at a given load and that of column groups due to the different modes of failure, e.g. simple bulging mode in single column and multiple modes (shearing, bending, and bulging) in group columns. It is noteworthy to mention that punching failure can happen to both single and group columns when the columns are short. Besides, the concept of the optimum length described here should not be confused with the optimum length findings by others [17–19] for undrained (rapid) loading where 3 to 6 times the diameter of a column is required to force bulging as the dominant type of failure mechanism in a column. (Note not the diameter of the footing as used in our study here, and the finding was mostly on single column and focus on the load-carrying capacity).

Design Concept

Conceptually, the settlement computation for a pile group foundation based on an equivalent raft method is not significantly different from a column group foundation. It is possible that the design procedure of the equivalent raft method can be extended to stone column group with some modification to account for the inherent differences. Numerical modeling by Tan et al. [15] was adopted as

Table 1 Optimum length for stone columns

A_F	0.2	0.3	0.4	0.5	0.6	0.7
L_{opt}	1.2D	1.4D	1.6D	1.8D	2.0D	2.2D

reference during the development of this design approach. In the study, 2D axisymmetric models were used. The column stiffness and soil stiffness were taken as $E_c = 30000 \text{ kN/m}^2$ and $E_s = 3000 \text{ kN/m}^2$ respectively. This method was developed for homogenous and Gibson soil profile. The prediction of settlement is only valid for columns with optimum length and useful for column groups of 9–100. For the details of model setup and analysis procedure, please refer to Tan et al. [15].

Homogenous Soil

The design concept to compute settlement of homogenous subsoil reinforced with floating stone columns is shown in Fig. 2. The improved layer (i.e. the zone of reinforced subsoil up to optimum length) is divided into two parts: plastic zone and elastic zone. Figure 3a shows the plastic straining of the 36 columns group of $A_F = 0.4$. For all the cases analyzed, the plastic yielding occurred in the range of $0.9D$ to $1.5D$ for $A_F = 0.2$ to $A_F = 0.7$, measured below the transfer layer. Therefore, plastic zone with the thickness of L_1 is taken as 0.6 times the optimum length (after numerous try and error to best fit the settlement over depth profile) with the remaining length, $L_2 = L_{opt} - L_1$ for the elastic zone thickness. If the transfer layer thickness is other than 0.5 m thick, the plastic zone thickness, L_1 has to be calculated as:

$$\text{For } t < 0.5 \text{ m} : L_1 = 0.6L_{opt} + (0.5 - t) \tag{3}$$

$$t > 0.5 \text{ m} : L_1 = 0.6L_{opt} - (t - 0.5) \tag{4}$$

Equations 3 and 4 are only approximations. The larger the difference in the transfer layer thickness to the reference case ($t = 0.5 \text{ m}$), the larger the error will become.

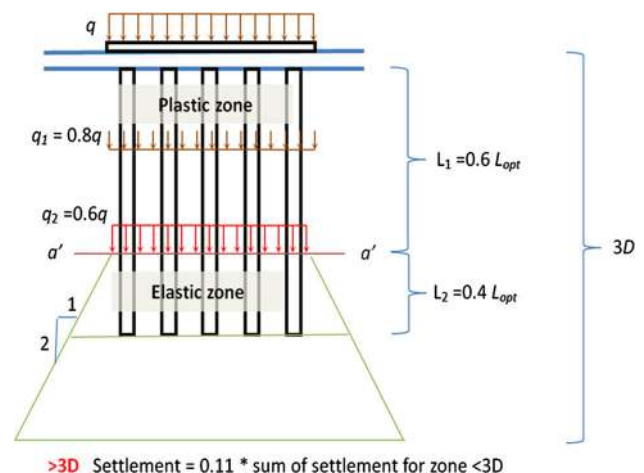
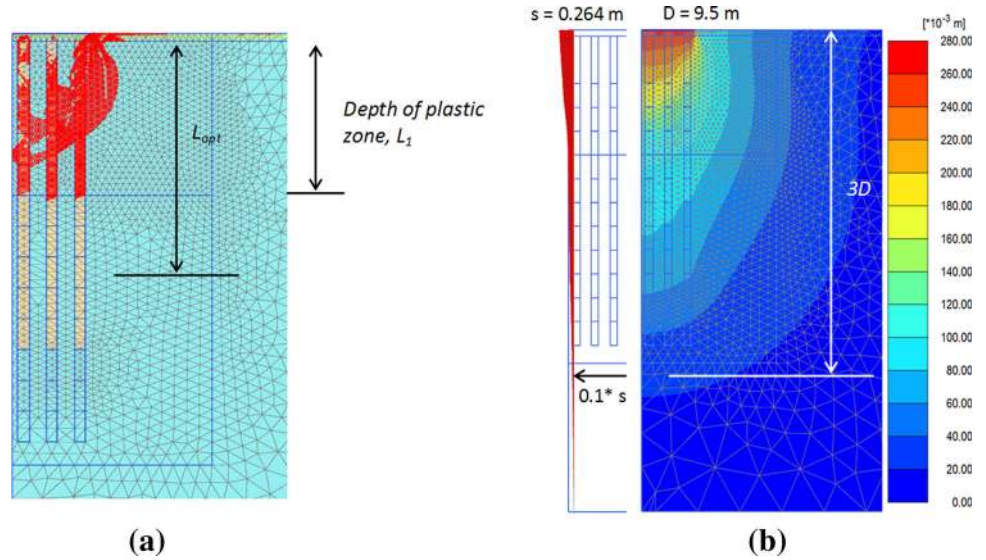

Fig. 2 Settlement of homogenous subsoil stratum reinforced with floating stone columns

Fig. 3 **a** Depth of plastic zone; and **b** displacement shading and profile, for 36 columns group with $A_F = 0.4$



Although this layer normally contributes to very little settlement when compared to the soft layer below.

It is assumed that the applied stress, q , at the footing/raft base is considered to fully act on the transfer layer and then transfer it to the composite ground with 80 % stress remaining ($0.8q$). Plastic zone subjected to this constant stress of $0.8q$ is first assumed to be resisted by the composite stiffness, E_{comp} determined as:

$$E_{comp} = A_F E_c + (1 - A_F) E_s \tag{5}$$

where E_c = stiffness of column, and E_s = stiffness of the surrounding soil. The 80 and 60 % stress transfer mechanism proposed here are the results observed from the series of test for different footprint replacement ratio and different numbers of columns obtained from the previous study to best fit the settlement profiles.

However, the elastic settlement calculation in this plastic zone does not correspond to the actual settlement where the yielding has reduced the composite stiffness substantially (possibly in the excess of 30 % underestimation for very small group columns). To account for this plastic deformation which is due to the effect of different failure mode, a correction factor, f_y was used.

$$E_{eq} = \frac{E_{comp}}{f_y} \tag{6}$$

The correction factors, f_y for different number of columns are shown in Fig. 4. These values are obtained from fitting the gradient of plastic zone for different settlement profiles (more than 40 cases with varying A_F and numbers of columns) obtained from FE analyses as described in Tan et al. [15]. Correction factors are high if the number of columns is low attributed to the lack of confining stress for smaller groups of columns. As the load increases, more

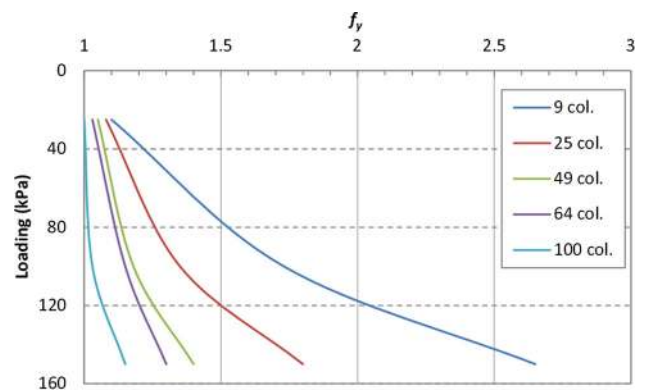

Fig. 4 Correction factors for composite stiffness—homogenous soil

plastic straining developed leading to a reduced stiffness in the plastic zone of the improved layer. Therefore the equivalent stiffness (Eq. 6) should be used instead of composite stiffness. This equivalent stiffness has included non-linear load settlement response due to the changing of correction factors under different loading intensity. Actually, the correction factors are not only influenced by loading and number of columns, they are also influenced by the footprint replacement ratio. However, the influence is small and is therefore ignored in the development of this method.

Then, the 60 % of stress acts as an equivalent footing placed on the plane $a'-a'$. From this depth, the stress is assumed to disperse by 2(V):1(H) until the depth of $3D$. The composite stiffness should be used in the elastic zone of the improved layer. Figure 3b with the settlement profile suggested the remaining settlement at depths beyond $3D$ is about 10 % of the total settlement. In view of that, the settlement contributed from the deeper depth than

3D can be assumed as 11 % of the settlement contributed from the upper layer (<3D). Nevertheless, it is a gross approximation but sufficient to give reasonable estimation for settlements contributed from depth over 3D.

The settlement calculation for the entire layer can be easily carried out in one step without the need to divide the ground into many layers since the virgin ground is homogenous and the simple elastic theory is adopted. The total settlement of column groups can be computed as:

$$s = 1.11 \left[\frac{q}{E_{st}}t + 0.8 \frac{q}{E_{eq}}L_1 + \frac{q_i}{E_{comp}}L_2 + \frac{q_j}{E_s}(3D - L_{opt} - t) \right] \tag{7}$$

where q = applied stress; E_{st} = stiffness of transfer layer; t = thickness of the transfer layer; q_i = the stress at the mid-layer of the elastic zone having a thickness of L_2 ; q_j = the stress at the mid-layer of soil between column toe and 3D.

Design Approach: Gibson Soil

In actual site condition, the virgin subsoil modulus can be constant, increasing with depth or decreasing with depth. However, as been observed in many cases, a close approximation to reality is to consider the soil stiffness as increasing linearly with depth (a Gibson soil). In this section, the soil with Gibson soil profile is assumed where the virgin subsoil soil stiffness is linearly increasing with depth:

$$E(z) = E(0) + E_{incr} z \tag{8}$$

where $E(0)$ is the soil stiffness at the ground surface while E_{incr} is the incremental stiffness expressed in $\text{kN/m}^2/\text{m}$ and z is the soil depth. In order to retain the same column-soil stiffness ratio, the column stiffness has to increase accordingly. The design concept is similar to the homogenous soil condition (i.e. the concept of optimum column length, thickness of plastic zone and the stress distribution mechanism) except that the correction factors, f_y for composite stiffness are different as shown in Fig. 5. These values were obtained from numerous trial to fit the results using the some selected cases but with changing stiffness where $E_{incr} = 300 \text{ kN/m}^2/\text{m}$ and the assumption that f_y is independent of E_{incr} . The value of f_y for the Gibson soil is slightly higher than for the homogenous soils. Thus the use of correction factor for homogenous soil may underestimate the settlements of Gibson soil profile.

Besides, due to the changing stiffness over depth, the calculations should be made in more layers until the depth reaches four times the footing diameters (4D) in order to increase the accuracy. No assumption to the settlement contributed from zone deeper than 3D is required since the

calculation is best carried out until 4D where further settlement is small and can be ignored.

Validation

This method provides quick hand calculations for the complex foundation problem. This part of the study examined the validity of the proposed method for different stiffness of soil by comparing it to finite element method. A total of twelve cases with different number of columns per group and varying the footprint replacement ratio were randomly selected to cater for a wide range of possible circumstances (Table 2). Stone columns in homogenous soil with constant stiffness (in Table 2, $E_s = E(0)$) were tested first followed by that of Gibson soil.

Small foundation improved by stone columns is a three dimensional problem. The interactions of column-soil-footing are complex, so as the deformation modes. However, a well calibrated approximation method can convert the 3D to 2D problem without distorting the deformation mechanism severely; indeed the study by Tan and Ng [20] has shown that the concentric ring model [21] is able to simulate the 3D problem with good agreements. Taking advantages of this 2D axisymmetric model, the 12 validation case were modelled with this approach.

In all cases (both calculation and FEM), the transfer layer is 0.5 m thick with a stiffness of 10000 kN/m^2 , while stone column stiffness is always ten times the stiffness of soil, i.e. effective modular ratio, $E_c/E_s = 10$. Based on field data, Han [22] suggested the modulus ratio (E_c/E_s) should be limited to 20. On the other hand, Ng [23] has discussed on the influence of the soil stiffness and the column stiffness on the settlement performance. Changing the columns stiffness while keeping the same soil stiffness results in negligible influence when the E_c/E_s ratio is higher than 10. In other words, the soil stiffness is a more important factor in settlements calculation. This is intuitively correct since stone column behavior depends directly on the lateral support of the surrounding soil [24]. Hence, the proposed method here suggested the columns stiffness of 10 times higher than the surrounding soil should be used. Using the higher E_c/E_s ratio in the proposed method will result in wrong predictions or over predictions of stone columns improved ground. In view of that, the composite stiffness can be written as:

$$E_{comp} = (1 + 9A_F)E_s \tag{9}$$

In FEM analysis, the initial earth pressure, K of 0.7 was selected to take into account the slight increment in horizontal stress due to installation effects. The effective Pas-sion's ratio, ν' is assumed to be 0.3 for all the soil materials. In addition, the shear strength of the column material and soil are always assumed to be $\phi_c = 40^\circ$ and

Table 2 Validation cases for homogenous soil and Gibson soil type

Cases	No. of col.	A_F	$E(0)$ (kN/m ²)	E_{incr} (kN/m ²)	$i: E(z) = E(0) \times (1 + iz)$
1	9	0.2	2000		
2	16	0.3	1500		
3	100	0.2	10000		
4	49	0.7	30000		
5	25	0.6	500		
6	64	0.4	7500		
7	49	0.4	750	100	0.4
8	81	0.6	15000	1500	0.1
9	9	0.5	5000	1000	0.2
10	64	0.2	1000	300	0.3
11	36	0.7	4000	800	0.2
12	25	0.3	8000	400	0.05

$\phi_s = 25^\circ$ respectively even though the stiffness are varied in the validation cases. The Mohr–Coulomb yield criterion with non-dilatancy was adopted. In all validation cases, the rigid spread footings were loaded to 150 kPa. In the finite element model, no horizontal displacement is allowed on the vertical boundaries of the model placed three times the footing diameter away from the center axis while the bottom boundary is completely fixed in both the vertical and horizontal direction, located at least four times the footing diameter [15].

Homogenous Soil

Validation cases for homogenous soil are represented by Case 1 to Case 6. The stiffness of the homogenous soil in this study is a constant but can be as low as 500 kN/m² to as high as 30,000 kN/m². These two extreme values represent very soft soil and stiff clay type. The results for Case 1 to Case 6 validation cases are presented in Figs. 6 and 7. All cases in Fig. 7 show settlement profiles under maximum load of 150 kPa except Case 1 and 5 were subjected

to 100 kPa of loading. Generally, the prediction of settlements not only gives good matches with FEM results in all the load-settlement curves for footprint replacement ratio of 0.2–0.7 but also be able to provide a close resemblance of the settlement profiles.

Case 1, 2 and 5 are having stiffness less than 3000 kN/m². These cases show slight underestimation of settlement with the maximum difference of 9 % occurred in Case 5. Even so, Case 5 with the lowest stiffness (i.e. 500 kN/m²) gives good predictions up to 100 kPa, beyond which two lines diverged. The settlement profile in this case shows satisfactory settlement calculation for improved layer, but give a lower prediction of settlement for layer beyond 3D. This is due to the approximation where only 10 % settlement contributes by layer beyond 3D is not always accurate especially when the footprint replacement ratio is high.

Cases with modulus higher than 3000 kN/m² are presented by Case 3, 4 and 6. The improvements obtained by prediction and FEM for Case 4 (virgin subsoil with the highest stiffness among all cases and $A_F = 0.7$) are 8 % in differences. In Case 4, the prediction curve for displacement profile matches the curve by FEM fairly well. However, the load settlement curves exhibits larger settlement prediction right from the early stage of loading. Even though the equivalent stiffness for the composite layer is correct (judging from the curve gradient), the use of 0.6 L_{opt} has overestimated the plastic zone thickness slightly.

Gibson Soil

Gibson soil with the changing of stiffness with depth is represented by Cases 7 to 12. The symbol “ i ” in the last column of Table 2 denotes the rate of change in the function of surface stiffness. The values spread between 0.05 and 0.4 to represent a low rate stiffness change to high rate stiffness change over depth, whereas the stiffness

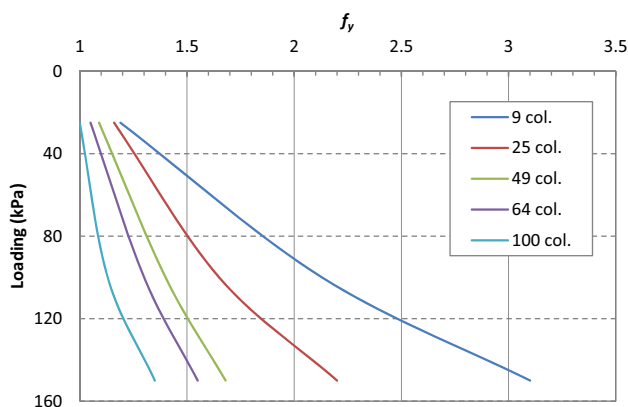
**Fig. 5** Correction factors for composite stiffness—Gibson soil

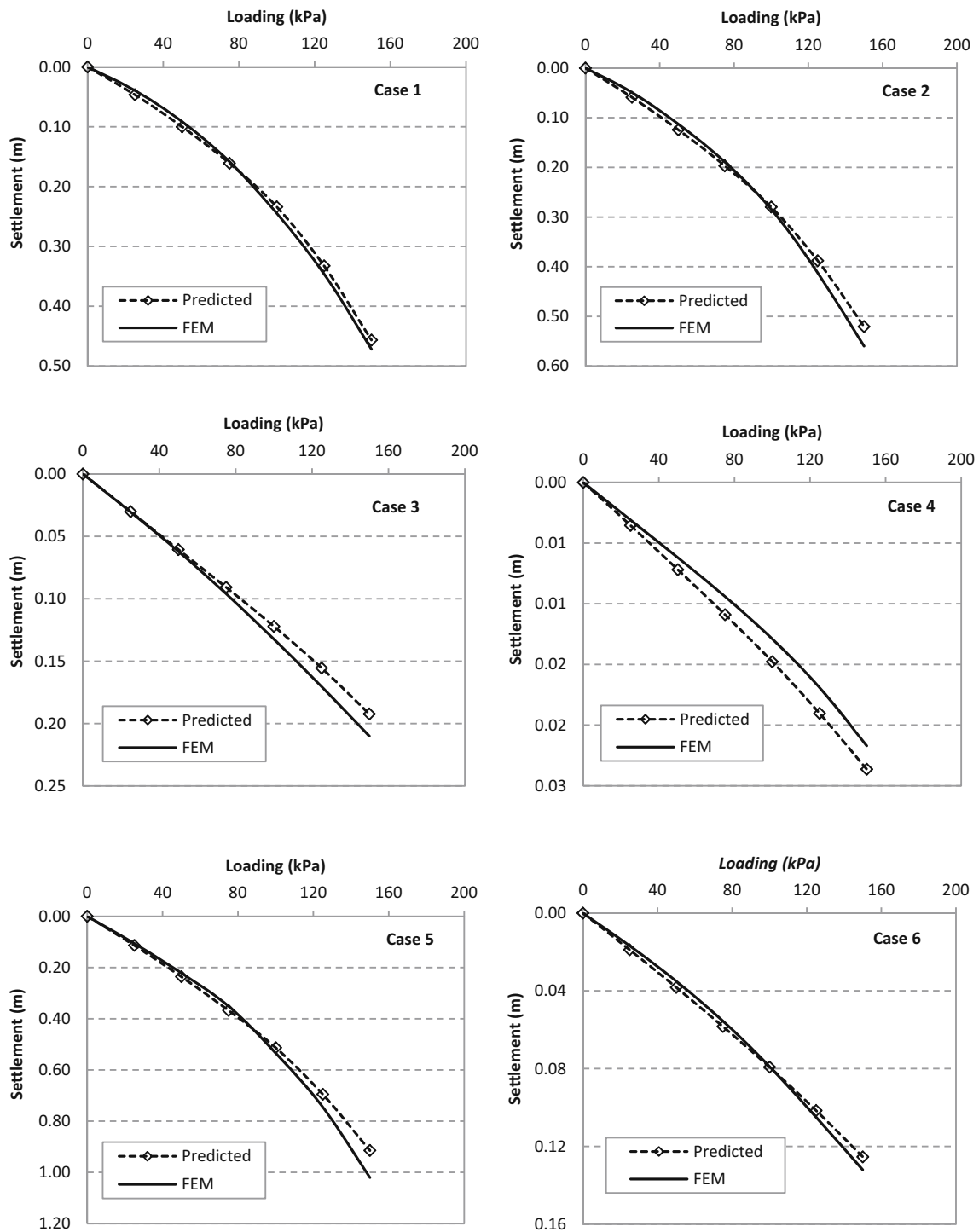

Fig. 6 Load-settlement plots for Case 1 to Case 6

increment ranges as low as 100 kN/m²/m to as high as 1500 kN/m²/m.

In the settlement calculation using the method proposed above, the problems are divided to one layer for transfer layer, three layers in plastic zone and two layers in zones beneath plastic zone. All the stress of each layer is

calculated at the mid-plane of the layers. The settlement predictions for the validation cases are shown in Figs. 8 and 9.

In general, the prediction with the proposed method produced reliable answers except when the footings are reinforced with large spacing of the columns or the

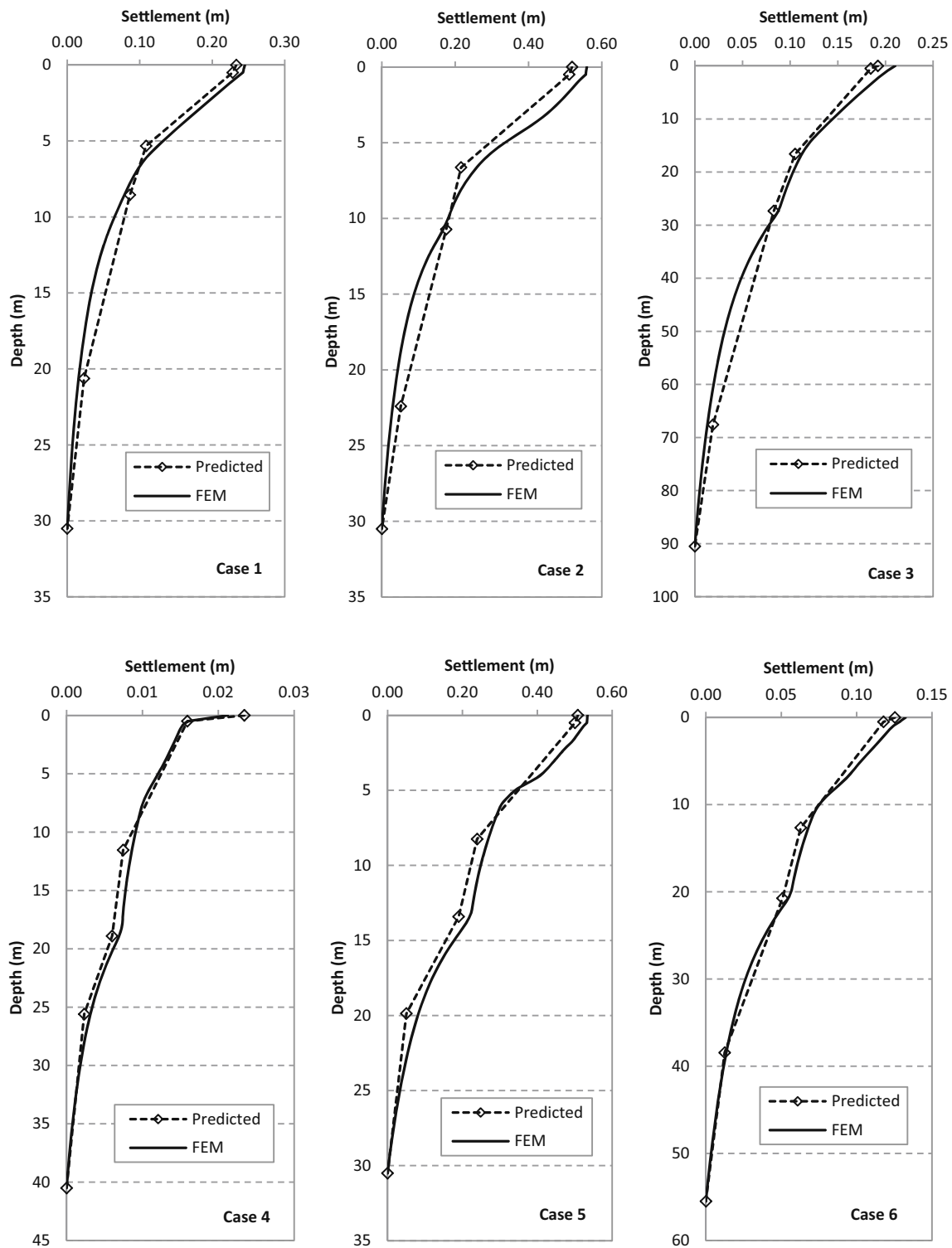

Fig. 7 Settlement profiles for Case 1 to Case 6

stiffness is very low. As in Case 10 when the footprint replacement ratio, A_F is 0.2, the settlements are under-predicted for about 20 % although the settlement profiles are showing a fair agreement. On the other hand, in very low stiffness soil like what happened to Case 7, equivalent

stiffness are over predicted results in less estimated settlement (11 %) compared to the FEM.

For large group column cases with high replacement ratio in stiff soil condition, the proposed method predicts settlements that exceed the FEM results by approximate

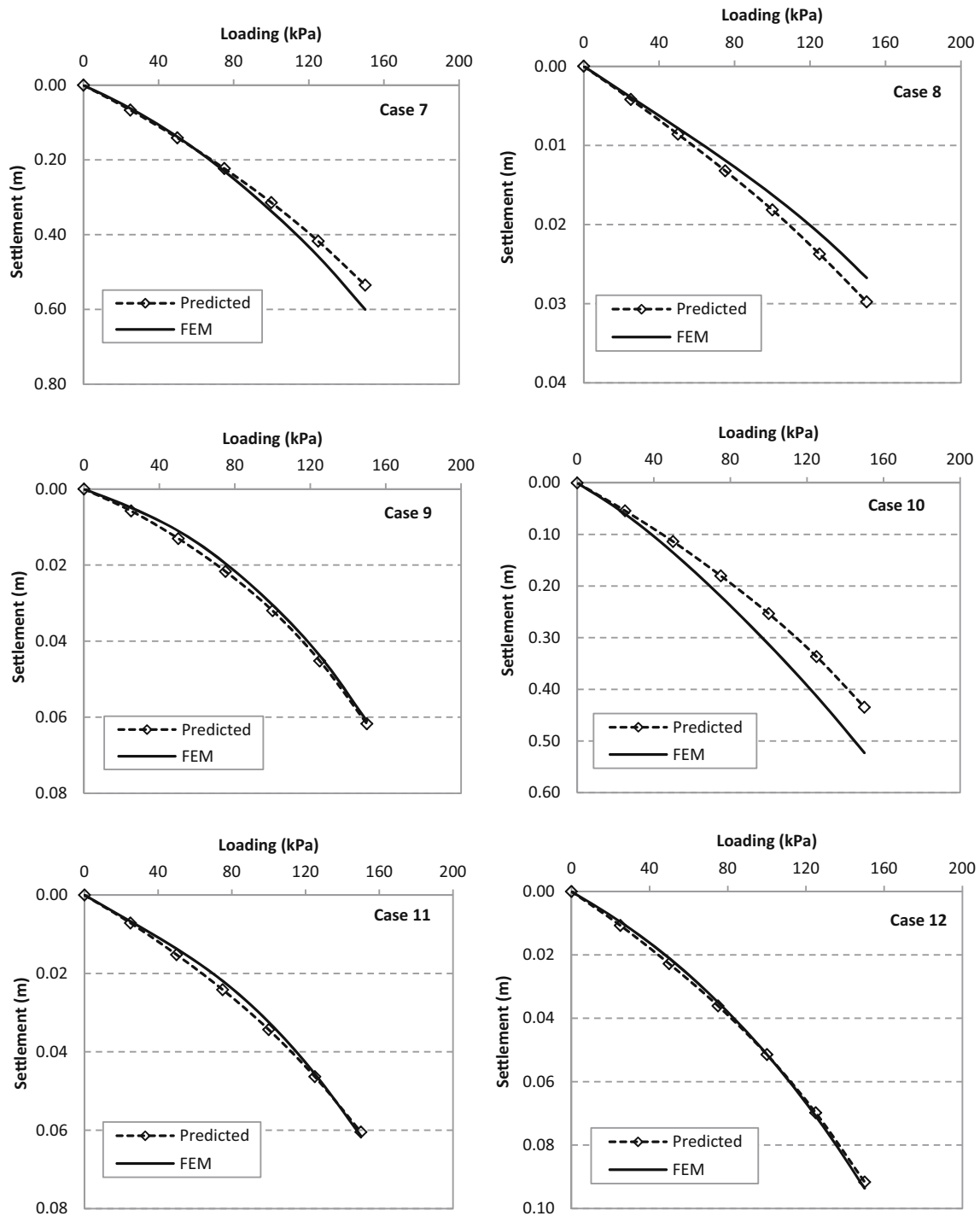

Fig. 8 Load-settlement plots for Case 7 to Case 12

11 % exemplified in Case 8. This is because the assumption of the plastic zone thickness is not always correct and exact in which the current method suggests 14 m thick while FEM approximated its thickness as 10 m.

Discussion

In all the twelve validation cases, the predictions from the current proposed method are good compared to FEM in

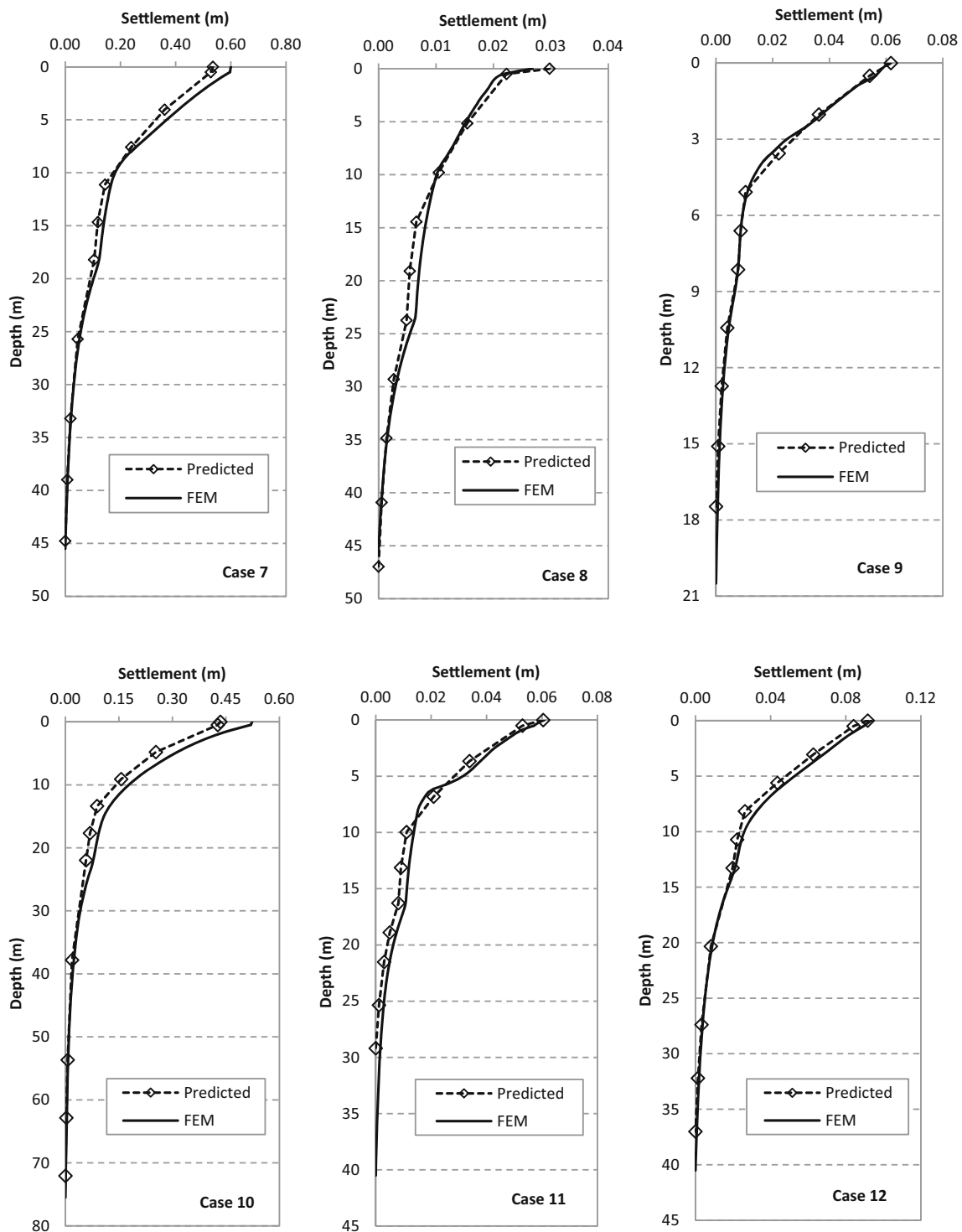

Fig. 9 Settlement profiles for Case 7 to Case 12

terms of total settlement and displacement profile especially for $A_F = 0.3-0.5$ and soil stiffness E_s between 1000 and 8000 kN/m^2 . The discrepancy between the results of proposed method and FEM are kept below 20 % for all the circumstances represented by these 12 cases. It is common

in construction practice to adopt higher replacement ratio for the soft soil while lesser in stiff soils, therefore this method can produce a reliable answer to the settlement value for typical ranges of $A_F = 0.3-0.5$ for footing supported by small groups of columns.

Stiffness of the soil, E_s is the key geotechnical parameter in settlement calculation. Most of the design approaches which adopt elastic theory, their soil stiffness is seldom a constant but depend on many factors (e.g. soil types, initial stress state, stress history, and stress level). Contrary, the proposed approach here is not founded on elastic continuum theory but developed on the basis of elastic–perfectly plastic theory, the Young’s modulus of soil, E_s is therefore a constant and can be easily obtained from the drained triaxial test (the authors would suggest secant modulus correspond to 50 % ultimate load). Hence, it is a much easier design approach than the simple elastic approach where the selection of the soil stiffness is more difficult to be justified as it needs to account for the plastic straining (which only happen at the upper part of a footing system) or the effects of different stress level. A good prediction of settlement is always contingent upon the correct use of soil parameters rather than the method itself [25], so the proposed method is able to reduce the risk of injudicious selection of soil parameters in design.

The concept of optimum length in small columns group analyses has invoked the idea of optimal design. There would be saving in terms of construction time and cost by avoiding unnecessary long columns to be built. In column groups, the failure modes especially the bending and shearing mode that happened to outermost columns are a two dimensional problem that occurs in the plastic zone. The effect of this has been taken into account by presenting a correction factor to the composite stiffness in conjunction with the yielding effect.

The movement of the soil does not vary linearly with depth illustrated in settlement profile. There are actually three distinct gradients in the settlement profiles: plastic zone, elastic zone, and between column toe and depth of $3D$. The accuracy of this prediction lied on the good assumption on the optimum length, thickness of the plastic zone, equivalent stiffness of the composite ground and the stress distribution mechanism; those are the essence of this developed method. None of the current available methods for group columns settlement calculation have provided the comparison in terms of the settlement profile in which the proposed method here has shown.

Even though the proposed method is based on circular footing, but it can be extended to square footings. The study by Tan et al. [15] has shown the square footing and the equivalent circular footing yielded similar results, hence, it will not be discussed here. The proposed method is not only suitable for the floating columns but also for end bearing columns provided the column length is longer than the optimum length suggested for floating columns (Table 1).

At the present, the state of the art reveals that no attempt has been made to design the group columns with the idea of optimum length, subsequently to incorporate the yielding

effect in the reinforced layer. The present work has demonstrated sensible estimation of final settlement as well as settlement profile compared to finite element method for the homogenous and non-homogenous soil layer. Next section the prediction was made against a field load test for a 5 columns group problem.

Comparison with Field Data

There is only one partially suitable field case known to authors that can be used to perform comparison against the proposed design method. Kirsch [26] carried out an extensive instrumented load test in order to investigate the behavior of a group of five stone columns loaded by a rigid square footing of 3×3 m. The 9.0 m long partially penetrating stone columns with a diameter of 0.8 m were installed within 11.0 m thick soft alluvial sediment. The footprint replacement ratio is determined to be $A_F = 0.28$. Undrained shear strength, c_u of the soft soil was determined to be approximately 12–18 kN/m². The load test was conducted as a maintained load test with the kentledge load system. The test was carried out in several stages held over a period of 10 days with one unloading reloading cycle. The details of the load test description can be found in Kirsh [26].

The proposed method adopted constant soft soil modulus of $E_s = 2200$ kN/m², using $E_u = 200 c_u$, and $c_u = 13$ kN/m² as the first approximation. Even though it may not be fully appropriate to use an undrained stiffness parameter to predict drained stiffness parameter, it is actually quite convenient and suitable if this is for design purpose and not for back analysis. The correction factor, f_y for composite stiffness for 5 columns has not been established, therefore the f_y for 9 columns was adopted. Using the proposed method suggested in “Homogenous Soil” section, the results are compared against the field measurements of the load test as shown in Fig. 10. The predicted settlement correlates well with the field measurements, although in the early stage of loading the proposed method is over-predicted. When the loading is larger than 100 kPa, the predicted settlement curve appears to be stiffer. The discrepancy of the result is because the columns tested had almost reached ultimate capacity when the loading is larger than 100 kPa, which can be seen by the plunging shape in the measured curve. The comparison with the FEM analysis by Kirsch [26] was also made and presented in the same figure. In Kirsch model, the material properties of the columns and soil are idealized as being non-linear using an elasto-plastic flow rule with isotopic hardening. The results of the numerical and the current analytical method compared quite well. The total capacity of the reinforced ground is also over-predicted in the FEM simulation compared to the load test results.

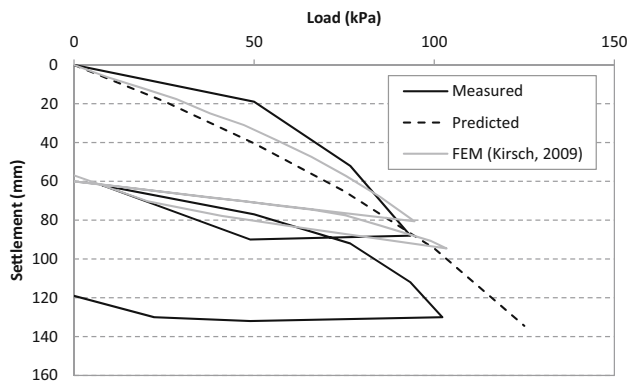

Fig. 10 Load-settlement responses for 5 floating columns group

The settlement profile was not measured in situ and therefore is not shown here. This prediction can be carried out in less than five minutes using a readily developed spreadsheet program. The prediction is considered good albeit simple in the design approach.

Method Limitation

While the proposed method can predict the final settlements performance of the rigid footing supported by a group of columns to an acceptable accuracy as well as the settlement profile, it has inherent limitations as follows:

1. The settlements calculation is valid only to problems where column length has achieved optimum length. If the columns toe reached hard layer in depth shallower than the optimum length, this method is also suitable.
2. The correction factor for composite stiffness has taken into the account the yielding effect and the failure mode but only applicable to the column groups of 9–100.
3. The method was developed based on the loading range of 0–150 kPa. It is understood that if loading are larger, more plastic straining will occur, that results in reduced of composite stiffness in the improved layer. Therefore, it is not advisable to apply this method to a higher stress level since the correction factor given here is limited to the range studied.

Conclusion

In this paper, a novel method of computing vertical settlements of small rigid foundations over weak subsoil deposits reinforced with floating stone columns was proposed. The method is useful due to its versatility to accommodate changing subsoil conditions with depth and based on the soil parameters which can be easily determined. The predicted settlements under the design loads

are compared with the settlements obtained through numerical approach. The comparison has demonstrated the capability of the suggested method to produce reliable results. In addition, the proposed method allows fast estimation of group settlements without recourse to a numerical computer analysis. It is not only that the load-settlement solution that can be obtained through hand calculation but also the variation of settlements over depth. Besides that, the sensitivity studies of the footing dimensions and footprint replacement ratios can be easily carried out which is useful for early design optimization, before resort to detail FEM analysis.

A good design procedure is a procedure must be backed by scientific theory rather than based on fortuitous coincidence as normally happened in the results obtained from most linear elastic based method. Hence, the proposed method in this study is based on sound theory by including the postulation of optimum length and the thickness of the plastic zone, which are the first ever attempted in stone column design approaches. The interactions of column-soil-footing are mooted in this method by introducing the correction factor to the elastic composite stiffness in the plastic zone. The validation cases have proved the feasibility of this approach under various circumstances. However, it is not true to predicate the proposed method works under all conditions due to the limitations discussed above. Besides, it deserved to be corroborated by more comparison with field data, as they become available.

Soil modulus has the most profound influence on the settlements of footing reinforced by stone columns. The proposed method suggested the use of uncorrected secant Young's modulus obtained from the drained triaxial test leaving reducing uncertainties in the selection of soil parameters as the column stiffness is also assumed to be ten times the soil stiffness. In other words, this proposed method is able to minimize the sensitivity to the estimated settlements of a column group, making it another advantage over the current methods that are based on purely elastic theory.

References

1. Barksdale RD, Bachus RC (1983) Design and construction of stone columns. Federal Highway Administration Office of Engineering and Highway Operations
2. Bergado DT, Anderson LR, Miura N, Balasubramaniam AS (1996) Chapter 5: granular piles. In soft ground improvement in lowland and other environments. ASCE Press, New York
3. McCabe BA, Nimmons GJ, Egan D (2009) A review of field performance of stone columns in soft soils. Proc Inst Civ Eng Geotech Eng 162(6):323–334

4. Stuedlein AW, Holtz RD (2012) Analysis of footing load tests on aggregate pier reinforced clay. *J Geotech Geoenviron Eng (ASCE)* 138(9):1091–1103
5. Goughnour RR, Bayuk AA (1979) Analysis of stone column-soil matrix interaction under vertical load. In: *Proceedings of the International Conference on Soil Reinforcement: Reinforced Earth and Other Technologies*, vol. I, Paris, France, pp 271–277
6. Blackburn JT (2009) Discussion support mechanisms of rammed aggregate piers I—experimental results. *J Geotech Geoenviron Eng (ASCE)* 135(3):459–460
7. Najjar SS (2013) A state-of-the-art review of stone/sand-Column reinforced clay systems. *Geotech Geol Eng* 31(2):355–386
8. Rao BG, Ranjan G (1985) Settlement analysis of skirted granular piles. *J Geotech Eng* 111:1264–1283
9. Terzaghi K, Peck RB (1967) *Soil mechanics and foundation engineering practice*. Wiley, New York
10. Fleming K, Weltman A, Randolph M, Elson K (2008) *Piling engineering*. CRC Press, Rotterdam
11. Poulos HG (1993) Settlement prediction for bored pile groups. In: *Proceedings of the 2nd Geotechnical Seminar on Deep Foundations on Bored and Auger Piles*, Ghent, pp 103–117
12. Lawton EC, Fox NS (1994) Settlement of structures supported on marginal or inadequate soils stiffened with short aggregate piers. *Vertical and Horizontal Deformations of Foundations and Embankments (GSP 40)*, pp 962–974
13. Jardine RJ, Potts DM, Fourie AB, Burland JB (1986) Studies of the influence of non-linear stress-strain characteristics in soil-structure interaction. *Geotechnique* 36(3):377–396
14. Stuedlein AW, Holtz RD (2014) Displacement of spread footings on aggregate pier reinforced clay. *J Geotech Geoenviron Eng (ASCE)* 140(1):36–45
15. Tan SA, Ng KS, Sun J (2014) Column groups analyses for stone column reinforced foundation. *Geotechnical Special Publication 233: from Soil Behavior Fundamentals to Innovations in Geotechnical Engineering (ASCE)*, Reston, pp 597–608
16. Wood DM, Hu W, Nash DFT (2000) Group effects in stone column foundations: model tests. *Geotechnique* 50(6):689–698
17. Greenwood DA (1991) Load tests on stone columns. *Deep foundation improvements: design, construction and testing*, ASTM STP 1089, Philadelphia, pp 148–171
18. Hughes JMO, Withers NJ (1974) Reinforcing of soft cohesive soils with stone columns. *Ground Eng* 7:42–49
19. Sivakumar V, McKelvey D, Graham J, Hughes D (2004) Triaxial tests on model sand columns in clay. *Can Geotech J* 41(2):299–312
20. Tan SA, Ng KS (2013). Stone columns foundation analysis with concentric ring approach. In: *Proceedings of the Third International Symposium on Computational Geomechanics (ComGeo III)*, Krakow, pp 495–504
21. Elshazly HA, Hafez DH, Mossaad ME (2008) Reliability of conventional settlement evaluation for circular foundations on stone columns. *Geotech Geol Eng* 26(3):323–334
22. Han J (2012) Recent advances in columns technologies to improve soft foundations. In: *Proceedings of the International Conference on Ground Improvement and Ground Control*, Wollongong, Australia, pp 99–113
23. Ng KS (2014) Numerical study and design criteria of floating stone columns. PhD dissertation, National University of Singapore
24. Priebe HJ (1991). *Vibro-replacement—design criteria and quality control*. *Deep foundation Improvements: design, construction and testing*. ASTM STP 1089, Philadelphia, pp 62–72
25. Poulosm HG (1989) Pile behaviour—theory and application. *Geotechnique* 39(3):365–415
26. Kirsch F (2009). *Evaluation of ground improvement by groups of vibro stone columns using field measurements and numerical analysis*. *Geotechnics of Soft Soils: Focus on Ground Improvement*. Taylor & Francis