

SIMULATION ANALYSIS
OF AN FMS
DURING IMPLEMENTATION

David L. Martin
Pritsker & Associates, Inc.
West Lafayette, Indiana 47906

KEY WORDS: Flexible Manufacturing System,
Implementation, Analysis, MAP/1"

ABSTRACT

Computer simulation is an effective tool for analyzing different aspects of a flexible manufacturing system (FMS) during implementation. Simulation "what-if" analysis can improve productivity, thus resulting in more cost effective systems. A simulation analysis of a totally automated FMS is used to exemplify the types of insights possible. The system is capable of producing 27 different iron and steel cylinder blocks for hydraulic piston pumps which serve a variety of industrial and commercial needs. The system is comprised of 16 work cells, including 10 robots, linked together via 2 non-synchronous carousel conveyor systems. The main objective of the simulation study was to determine the amount of reduction in system operating time possible to produce the required number of pumps, thus reducing the cost per piece. The analysis revealed that approximately 10% of system uptime could be eliminated through a combination of new equipment and modified processing methods.

1. INTRODUCTION

During the implementation phase of an FMS a certain degree of testing and fine tuning the system must be done. Computer simulation is an effective tool for identifying problem areas and testing possible solutions. Simulation "what-if" analysis of productivity improvement ideas, scheduling and sequencing issues, down time frequencies and durations, and pallet or fixture availability can result in a more efficient system. A MAP/1 simulation model and subsequent analysis of a fully computer-integrated, flexible, high-volume manufacturing system is used to illustrate this point.

The objectives of the study are to:

- Determine the number of hours needed to produce the required part volume under current conditions.
- Evaluate various production schedules, i.e., evaluate the effect on system performance of varying the sequence of parts entering the system.

- Evaluate the system performance, in terms of required hours, using productivity improvement ideas, i.e., increasing robot efficiency, adding pallets, performing gaging operations less often.
- Determine the effect of machine failures and repair durations at 90 percent efficiency.
- Determine how long parts are in the system -- from introduction to completion.

The system produces 27 different part types and changeovers between part types reduce efficiency. The best way to determine total hours required to produce all parts would be to simulate a year's production. This was not economically feasible due to the computer time required. An alternative method was developed and is also discussed in this paper.

2. SYSTEM DESCRIPTION

The system was designed as a computer-integrated FMS combining artificial intelligence, robotics, and conveyors to manufacture hydraulic piston pump blocks. The system contains 16 cells and is capable of turning, broaching, boring, heat treating, washing, and assembling 27 different parts in three materials, sintered iron, ductile iron, and steel. A list of the operations performed on parts is contained in Table 1.

Table 1. Operation Descriptions

Operation Number	Oper Description
OP 10	Load Pallets
OP 20/30	Turning Machines
OP 40	Broaching Operations
OP's 50,70,90,100	Boring Machines
OP's 60,80	Part Orientation-Robot
OP's 120,150	Gaging
OP 110/140	Wash Area
OP 130	Heat Treating
OP 160	Bushing Assembly Area

Simulation Analysis of a FMS During Implementation

Parts are moved and oriented by 10 robots, which are monitored and controlled by a vision system, and 2 non-synchronous carousel conveyor systems. The system is designed to operate unmanned (except for loading parts at OP 10) for 20 hours per day. Routine maintenance will be performed during the 4 hour down times.

The system is required to produce approximately 400,000 parts per year. Optimally the system will run batches, or production runs, of each part type to reduce changeovers, since some machines require a setup for a different part type. The projected quantity and the number of production runs for each part type are provided. The estimated number of production runs is 140 per year.

The system, by virtue of the combined application of artificial intelligence, robotics, and conveyors allows for virtual unmanned operation. The layout of the system is shown in Figure 1. The system operates in the following manner. Parts are loaded onto one-part pallets at OP 10. The parts proceed to one of three OP 20/30 cells based upon availability. Each of the cells consists of 2 turning machines serviced by a robot. Upon completion at OP 20/30 the parts are loaded onto four-part pallets on the main conveyor by the robot. The four-part pallet then proceeds through a sequence of operations where four different modes of processing are used:

- Each part is processed at the machine while the pallet waits for processing to be completed (OP's 40, 60, 80, 120, 160).
- The pallet unloads the four parts onto the machine, accepts four finished parts, and proceeds to the next operation (OP's 50, 70A, 70B, 90, 100, 130).
- The pallet and four parts flow continuously through a wash area as one unit (OP 110/140).
- Parts are processed one at a time and upon completion of the fourth part the empty pallet is released to return to OP 20/30 to receive a new batch of four parts. (OP 150).

A setup operation, henceforth termed changeover, is performed at most operations (OP's 20/30, 50, 70A, 70B, 90, 100) when a different part type arrives to the operation.

Steel part flow varies slightly from iron part flow. The processing is identical to that of iron parts through OP 110/140. They then proceed to OP 160, where only steel parts are processed. Upon completion of OP 160, steel parts are moved back across to the lower portion of the main conveyor via a pallet pusher. These parts then proceed through OP 100, OP 110/140, and OP 150. When

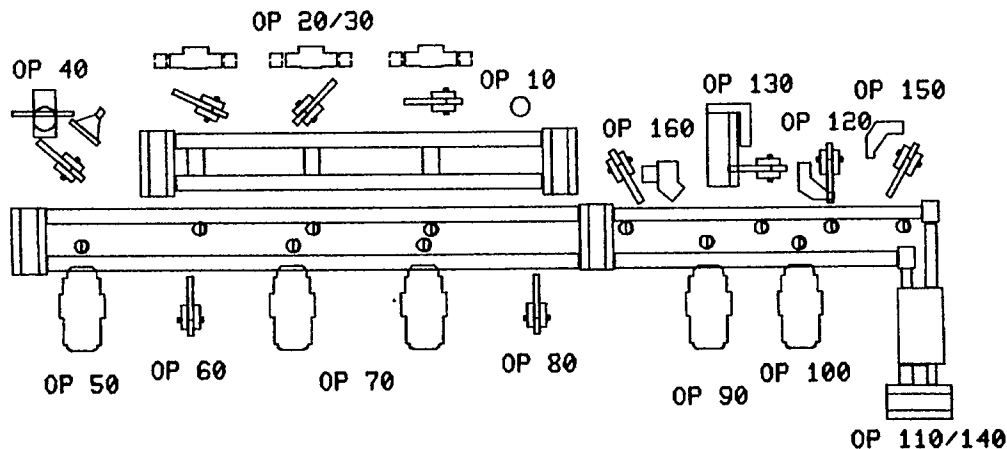

Figure 1. System Layout

changing from steel parts to iron parts, all steel parts are cleared out of the area from OP 90 to OP 160 rather than allowing steel and iron parts to mix in that area. This is due to changeover effects identified by the simulation model.

3. SIMULATION MODELING AND ANALYSIS

3.1 Simulation Software

The simulation model developed for this application was written in the MAP/1 simulation language. MAP/1 is a manufacturing oriented language with special constructs, such as conveyors, robot movements, setups, tool changes, machining

operations and control logic, for building models of manufacturing processes quickly. The model was constructed in a manner which easily allows for evaluation of different scenarios.

3.2 Analysis Approach

The optimal method for determining the hours needed to produce the required number of parts would be to simulate a year's production. This method is not economically feasible since the model requires approximately 2 hours CPU time per 5 days of simulation time or 100+ hours of CPU time per year of simulation time.

The approach employed was to determine each individual part type's steady state hourly production rate including tool changes, but not including changeovers. The result is the total hours required if there were no changeover effects. The changeover effects were then estimated by simulating several combinations of two part types back-to-back to determine lost production time. The total yearly hours required are found by adding the changeover effects to the total hours without changeovers. The method of calculating changeover effects is presented in Figure 2.

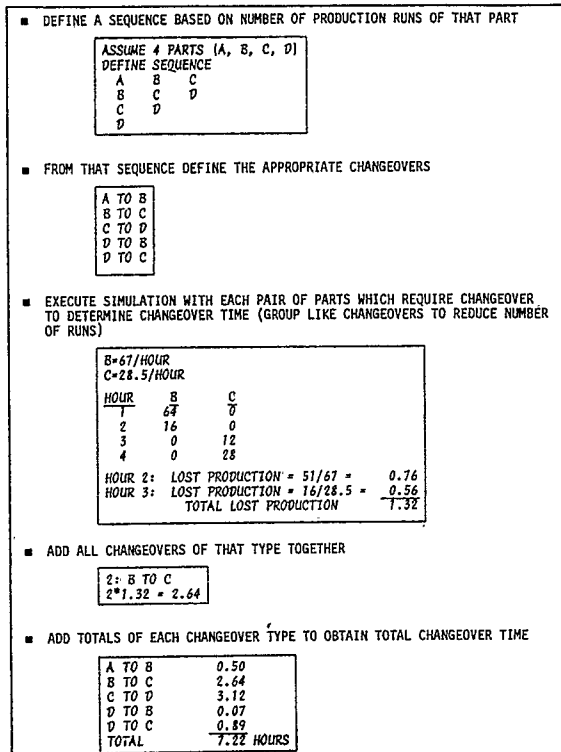

Figure 2. Changeover Calculation

Changeover effects were calculated using a sequence of parts from fastest to slowest which resulted in allowance of 8 hours for changeovers. Some experimentation was done to determine the effects of different

sequences. A total reverse of the order would result in approximately 15 hours of changeover time. Other sequences fall between the two extremes. A changeover time of 8 hours was used throughout the analysis.

3.3 Simulation Results

The five main questions to be answered by the simulation are:

- How many hours are required under current operating procedures?
- How is the total time affected by different sequences of parts?
- How will various new equipment and revised operating policies affect the time required?
- What is the effect of 90% efficiency on the system?
- How long are parts in the system -- from introduction to completion?

The simulation determined that currently the system must operate on a 6 day, 20 hour/day basis to achieve the required yearly production level, assuming the equipment operates at a 100% efficiency level (start). Various productivity improvement ideas were tested using the simulation, including replacing a single gripper with a double gripper on several robots and performing a gaging operation on a less frequent basis (2 grip), transferring operations (pin hole) from one location to another (OP 100 to OP 90), and altering the method of certain operations (freeze bushings) to reduce the operation time. These changes were implemented and resulted in increased efficiency of about 10% above original estimates. A comparison of total yearly hours required for each of these scenarios is shown in Figure 3.

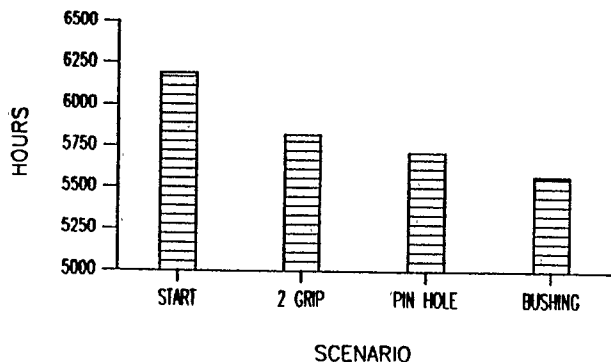

Figure 3. Yearly Production Hours Required

Simulation Analysis of a FMS During Implementation

Part sequences were deemed to have little effect on the system. Total yearly time lost to production for changeovers varied from 8 to 15 hours, or approximately 0.1% of total yearly production time.

Next, the effect of equipment efficiency was measured by the simulation. An estimate of equipment efficiency of 90% was added to the model after all productivity improvement ideas were incorporated. The simulation then calculated a system efficiency percentage:

$$\text{System Efficiency} = \frac{\text{Total hours}}{\text{Total hours required @ 100\%}} * 100$$

It was shown that in order to achieve 90% efficiency 15 four-part pallets for a total of 30, would need to be added. Fifteen pallets resulted in a system efficiency of 82.5%. Figure 4 compares the total hours required for the maximum efficiency scenario (100% efficiency plus all productivity improvement ideas) to 90% efficiency scenarios with two different pallet availability scenarios. Figure 5 compares various pallet availability scenarios based on system efficiency.

In addition to determining the total hours required, the simulation also resolved several operational issues. First, as mentioned in the SYSTEM DESCRIPTION section the best method in which changeovers between steel and iron parts should be accomplished was determined. Specifically, when changing from steel parts to iron parts, all steel parts are cleared out of the area from OP 90 to OP 160 rather than allowing steel and iron parts to mix in that area. Second, the number of parts which could be simultaneously processed in the wash area (OP 110/140) was a question. Initially only two were allowed, but there were concerns that might cause a bottleneck. The simulation proved that any increase would not result in increased throughput and a decrease to capacity one would not decrease throughput. Third, the utilization of equipment, which helps to identify bottlenecks was determined for each part type. Figure 6 contains OP 50 utilization for a production run of one part type. Finally, the number of pallets, both one- and four-part, were determined. Initial estimates of 18 and 15, respectively were adequate until down time was introduced into the system. Pallet requirements were discussed above in the "system efficiency" section of the results.

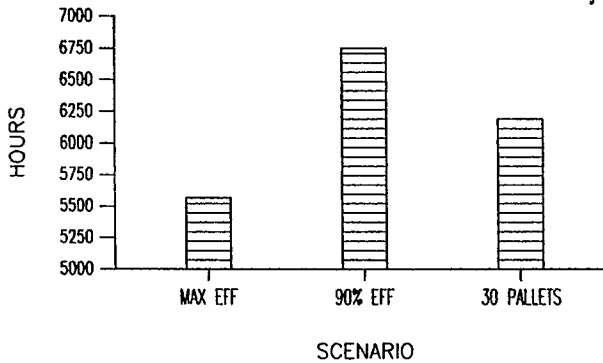

Figure 4. Down Time Effects

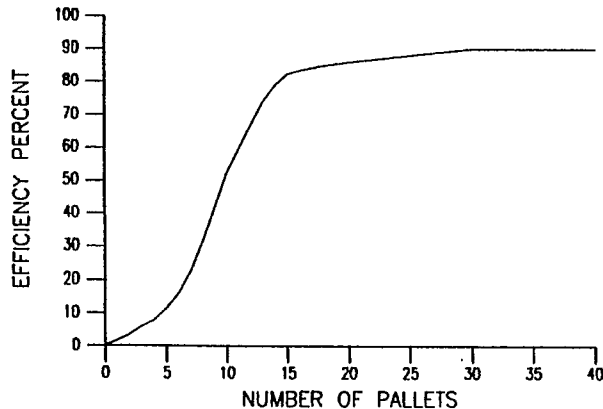

Figure 5. System Efficiency

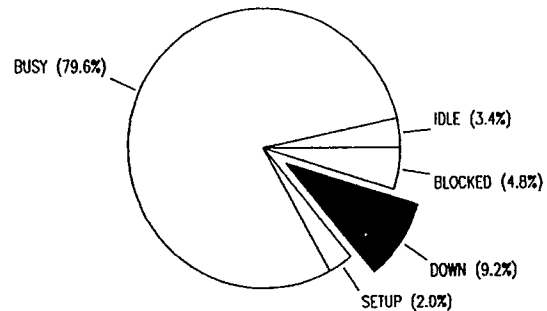

Figure 6. Machine Utilization

The simulator also determined the amount of time parts spent in the system -- from introduction at OP 10 to completion at OP 150. All parts except steel parts were completed under the two hour goal set by the producer. This point is illustrated in Figure 7 which shows time in system variations for several part types.

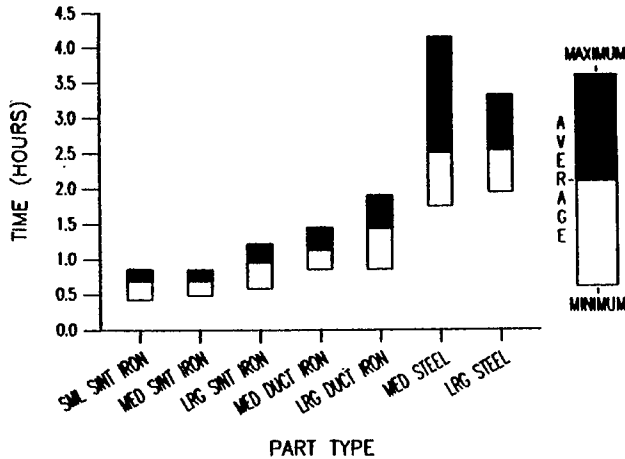

Figure 7. Part Time in System

at Pritsker & Associates, Inc. (P&A). He holds a Bachelor of Arts in mathematics and economics from Hiram College and a Master of Science from the School of Industrial Engineering at Purdue University. Since joining P&A, Mr. Martin has been involved in a variety of projects including development of simulation models of a steel production facility and an offshore oil shuttle tanker system, development of simulation models to design, analyze, and schedule a variety of manufacturing systems, including FMSs, transfer lines, job shops, and AGVSS, and integration of simulation and order scheduling systems to analyze the effects of schedule modifications on manufacturing systems. Mr. Martin has written and presented several technical papers concerning simulation of manufacturing and mining systems. He is a member of Institute of Management Sciences (TIMS), Institute of Industrial Engineers (IIE), Society for Computer Simulation (SCS), and Society of Manufacturing Engineers (SME).

David L. Martin
 Pritsker & Associates, Inc.
 P. O. Box 2413
 West Lafayette, Indiana 47906
 (317) 463-5557

4. SUMMARY

The simulation analysis presented here provided answers to several key questions:

- What are the total number of hours required to manufacture the desired number of parts?
- What is the effect of different sequences of parts on the total number of required hours?
- What effect does 90% efficiency have on the system?
- What effect does varying the number of pallets available have on the system?
- What improvements in total hours can be expected with productivity improvement ideas?

The simulation showed that the system must operate on a 6 day, 20 hour per day basis to achieve the required production level. This result is based upon various productivity improvement ideas, 90% efficiency of the equipment, and an investment in 15 pallets in addition to the initial estimate of 15.

Simulation provides analysis important in the implementation phase of FMS installation. Many "what-if" type questions are possible. Simulation provides the engineer a medium through which he/she can determine the effect of productivity ideas or system modifications immediately and evaluate whether the effort will be beneficial.

AUTHORS' BIOGRAPHY

DAVID L. MARTIN is a Systems Consultant