



Simulation of Partial Discharge in High Voltage Power Equipment

Asima Sabat and S. Karmakar

Department of Electrical Engineering
National Institute of Technology
Rourkela-769008
karmakar.subrata@yahoo.co.in

Abstract: In high voltage (HV) electrical power system, variety of solid, liquid and gaseous materials are used for insulation purpose to protect the incipient failure inside the HV power equipment. Among these the solid insulation is widely used for high voltage power equipment HV electrical power system. Most of insulating materials are not perfect in all respect and contains always some impurities. The presence of air bubble is one of such impurities in insulating materials and highly undesirable for such type of insulation which causes a local weak zone inside the insulator. Insulation of the HV power equipment gradually degrades inside the insulator due to cumulative effect of electrical, chemical and thermal stress. Due to the high voltage stress the weak zone inside the insulator causes the partial discharge (PD) which is known as local electrical breakdown. As a result the insulation properties of such materials are enormously degrades its quality due to the PD. In this work, the simulation of PD activity due to presence of a small cylindrical void inside the solid insulation material of high voltage power equipment is studied with the MATLAB Simulink platform.

Keywords: Electrical insulation, cylindrical void, partial discharge, apparent charge, high voltage equipment

1. Introduction

In most of the high voltage (HV) power equipments are made of with different type of high quality insulation to protect against the high voltage stress. A variety of solid, gaseous, liquid and combination of these materials are used as insulation in high voltage power equipment [1-5]. Among those the solid insulation like epoxy resin is widely used, not only as a component of complex insulating system such as HV rotating machine insulation but also in indoor insulators, in transformers and in many different high voltage power equipments[1-2]. To assess the quality of such insulation is a challenging task to the power engineers while the same power equipment is under operating with high voltage stress for a long period. The quality of such insulation plays an important role on HV power equipment in view of quality assessment. However, the insulation of power equipments are gradually degrades due to the cumulative effects of electrical, chemical and mechanical stresses caused by the partial discharges (PDs). Partial discharge is a localized electrical discharge that only partially bridges the insulation between electrodes [1-2]. It is studied from the several articles that most of insulators are not hundred percent perfect in nature and always contains some impurity [3-5]. During the manufacturing process the presence of air/gas bubble in the insulating material is one of the causes for making the insulation imperfect. The presence of air/gas bubble during the manufacturing process may in the form of different geometrical shape such as rectangular, spherical, elliptical, cylindrical etc. The presence of air bubble in any shape inside the insulation formed an impurity inside the insulation which weakens the insulation region and responsible for occurrence of PDs in the high voltage power equipment. It is studied that the field intensity while exceeds the breakdown strength of gas in void, then partial discharge takes place. However, once the PD starts inside the high voltage power equipment it is continue for a long time if it is not taken care of and

finally insulation properties of such materials degrades its quality. Because of the above reason PD detection and measurement is necessary for prediction of insulation life for HV power equipment. In this work, an electrical circuit model of void presence inside the solid insulation material is used to study the PD activity inside the insulator. A small cylindrical void is taken into consideration and placed at the middle of the insulator which is kept under the plane-plane electrode arrangement which produced the uniform electric field. The whole simulation has been done with very well known software MATLAB simulink environment. The simulation is the basis for a physically meaningful interpretation of PD data. In this study an efforts have been made to investigate the maximum PD magnitude, number of PDs and number of other PD related parameters like PD distribution, frequency content of obtained PD pulse by using phase resolve partial discharge (PRPD) measurement technique.

2. Electrical Circuit for PD Measurement

The schematic diagram for detection of partial discharge inside the solid insulation is shown in Fig. 1. It consists of high voltage transformer (V_s), filter unit (Z), high voltage measuring capacitor (C_m), coupling capacitor (C_k), void model of solid insulation called as test object (C_t), detector circuit for measurement of partial discharge (Z_m) and the measurement instrument (MI). The detector circuit for measurement of PD is a parallel combination of the resistor, inductor and the capacitor. The cylindrical void model (test object) of the insulating material is represented as 'abc' diagrams [5-6]. In the equivalent circuit the test object is represented in the form of small capacitance and the capacitance C_c corresponds to the cylindrical void present inside the solid insulation, C_b corresponds to the capacitance of the remaining series insulation with void (C_c) and C_a corresponds to the capacitance of the remaining discharge-free insulation of the rest of the solid insulator. Such circuit is energized with

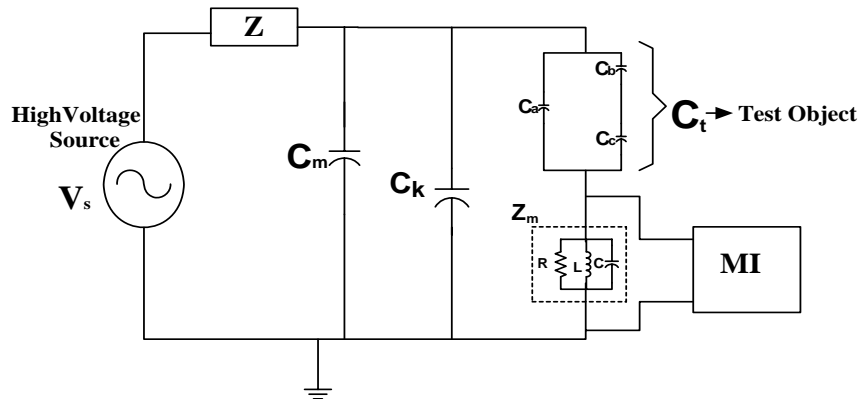

Figure 1. Electrical equivalent circuit model of cylindrical void (test object) in solid insulation along with high voltage equipment.

AC voltage, a recurrent discharge occurs C_c is charged, reaches the breakdown voltage of the cavity, is charged again and breaks down. The voltage across the cavity V_c is

$$V_c = \frac{V_a \times C_b}{(C_a + C_b)} \quad (1)$$

where, the V_a , V_b and V_c are the voltage across the corresponding capacitance C_a , C_b and C_c respectively. The apparent charge q across the test object is measurable during the PD activity inside the solid insulation which is calculated by the empirical Eqn.

$$q = C_b \times V_c \quad (2)$$

This apparent charge is not given the accurate results as all the relevant void parameter is not included. To overcome the above problem A. Pedersen has suggested a model which is based on induced charge [3]. According to this model, apparent charge for a given small cylindrical void can be expressed in the form

$$q = S \times V \times (E_i - E_l) \times \varepsilon_0 \times \varepsilon_r \times \Delta Z \quad (3)$$

in which, S is void geometric factor, V is volume of cylindrical void and is given by $\pi r^2 h$, r is radius of void, ε_0 is permittivity of free space, ε_r is relative permittivity of dielectric, E_i is inception voltage for streamer inception, E_l is limiting field for ionization and ΔZ is reciprocal of space between two electrodes is $(1/d)$. The value of $(E_i - E_l)$ can be calculated by Eqn.

$$\frac{E_i}{p} = \frac{E_l}{p} \cdot \left[1 + \frac{B}{\sqrt{2ap}} \right] \quad (4)$$

where, B is constant characteristic of gas in void, 'a' is radius of void, p is pressure of gas in void and E_l/p (for air) is taken 24.2 v/pa. m.

Tabel 1
Parameter Used for Simulation of Partial Discharge in solid Insulation

Sl. No.	Parameter	Symbol	Default value	Dimension
1	Gap spacing between electrodes	d	0.005	m
2	Relative permittivity of dielectric (for epoxide resin)	ε_r	3.5	--
3	Permittivity of free space	ε_0	8.852×10^{-12}	F/m
4	Constant characteristics of gas	B	8.6	$\text{Pa}^{0.5} \text{m}^{0.5}$
5	Pressure	p	10^5	N/m^2

A. Simulink Model Descriptions for Detection of Partial Discharge

Partial discharges are electrical discharges confined to a localized region of the insulating medium in high voltage (HV) power equipment. The PD phenomenon usually commences within the void, cracks, in bubbles within liquid dielectrics or inclusion within the solid insulating medium. In addition, PDs also occur at the boundaries between the different insulating materials, contamination, poor conductor profiles and floating metal-work in the HV equipment [5-10]. The electrical PD detection method are based on the appearance of the PD current or voltage pulse across the test object for fundamental investigation, which may be either a simple dielectric test object or large HV power apparatus [1-2]. To evaluate the fundamental quantities of PD pulse, a simple equivalent capacitor circuit of solid insulator having cylindrical void is taken into consideration for this work. In the equivalent circuit the capacitance C_c corresponds to the cylindrical void present inside the solid insulation, C_b corresponds to the capacitance of the remaining series insulation with void (C_c) and C_a corresponds to the capacitance of the remaining discharge-free insulation of the rest of the solid insulator. Generally, ($C_a \gg C_b \gg C_c$). According to the size of void in insulation sample (epoxide resin), a cylindrical void of height of 4 mm and a radius of 2 mm is used in a cube sample (30mm \times 30mm \times 5mm) in this model. The void is located in the centre of the insulation sample. The applied voltage to the sample is 5 kV and frequency of 50 Hz. The capacitance value of sample is calculated as $C_a = 4.83 \times 10^{-12}$ F, $C_b = 3.89 \times 10^{-13}$ F, $C_c = 2.78 \times 10^{-14}$ F. In this study the value of the void model and the other high voltage equipment for measurement of PD inside the solid insulation is taken as depicted in Table 1 and Table 2 respectively.

Table 1
Specification of Different Components and Their Values Used for Simulation

Sl. No.	Components	Value/ Rating
1	HV transformer	0.23/50 kV,50 kVA
2	HV measuring capacitor	200/1500pF
3	HV coupling capacitor	1000 μ F
4	Detector circuit resistance	50 Ω
5	Detector circuit inductance	0.63mH
6	Detector circuit capacitance	0.47 μ F

Partial discharge is a highly localized partial breakdown within a small region of the insulation system where the local electric field exceeds the electrical strength of the insulating material. Generally, the presence of void inside the insulation creates a weak zone which further suffers a high voltage stress during the operating of their life. In case of sinusoidal applied voltage the instantaneous voltage between the plate electrodes varies with time. If the rate of accumulation of charge within the void is higher than the rate of rise of applied voltage, which is true in the most of the cases, the field intensity within the void decreases quickly due to charge accumulation. Again, it is well known that the field intensity that is required to maintain a discharge is lower than that required to initiate the discharge. Hence, the field intensity below which PD stops is lower than that for PD inception. Due to fast accumulation of charge across the void when the field intensity within the void goes below this PD extinction value, the PD stops within the void.

B. Partial discharge pulse generation under applied high voltage

To analysis the PD pulse generation within the solid epoxy insulation a cylindrical void in between the two parallel plate electrodes in a two dimension system is taken into consideration which is shown in Fig. 3. In this case the potential distribution is capacitive in nature and the potential that is appear across the void is depends on its dimension with respect to the whole arrangement. The capacitance of the void is considered as $C_c = \frac{\epsilon_0 A_1}{h}$ and the rest of the healthy part of the insulation is $C_1 = \frac{\epsilon_0 \epsilon_r A_1}{(d-h)}$ in the both upper and lower side of solid epoxy insulation.

The potential across the void and the healthy part of the insulation is V_2 and $V_1 = \frac{(V-V_2)}{2}$ respectively. The electric field intensity is denoted by E . In case of sinusoidal applied voltage the instantaneous voltage between the electrodes varies with time. It is consider that the instantaneous voltage corresponding to phase angle ϕ_1 as shown in Fig.2 is such that the field intensity within the void exceeds the breakdown strength of gas in void and PD starts within the void. Due to the formation of PD, charges started accumulated at the surface of the void as shown in Fig. 3. (i). It is consider that initially the amount of charge accumulated in the void surface is q and the capacitance of the void is C_c . So voltage appear across the void is given by $V_3=q/C_c$ and it acts in opposite to V_2 which is shown in Fig. 3. (ii). Initially as the voltage across the void V_2 is higher than the generated voltage due to the accumulated charge V_3 , therefore the voltage across the void becomes (V_2-V_3) and the field intensity within the void becomes $(V_2-V_3)/d_1$. If the rate of accumulation of charge within the void is higher than the rate of rise of applied voltage, which is true in the most of the cases, the field intensity within the void decreases quickly due to charge accumulation. Again it is well known that the field intensity that is required to maintain a discharge is lower than that required to initiate the discharge. Hence the field intensity below which PD stops is lower than that for PD inception. Due to fast accumulation of the charge across the void, when the field intensity within the void goes below this PD extinction value the PD stops within the void. This generates one PD pulse at phase angle ϕ_1 . Consider, the charge accumulated at the surface of the void is q , when the first PD pulse is extinguished. Since, the dielectric surrounding the void is assumed to be a perfect insulator hence this charge is remain across the void. So the next PD pulse is taking place corresponding to the phase angle ϕ_2 , for which the difference between the voltages across

the void due to accumulated charge at the extinction of the void in excess of the PD inception strength. Thus the condition for the inception of second PD pulse is as follows:

$$E_{void}(\varphi_2) = \frac{[V(\varphi_2) - \frac{q_1}{C_c}]}{h} > PD_{inception\ strength} \quad (5)$$

In fact, the second PD pulse occurs at a voltage higher than that required for the first PD pulse.

At the extinction of the second PD pulse, the total charge across the void is q_2 , such that $q_2 = q_1 + q'_2$ where q'_2 is the charge accumulated due to the second PD pulse only. In this way, PD pulses are taking place at increasingly higher voltages and the accumulated charge across the void is increasing.

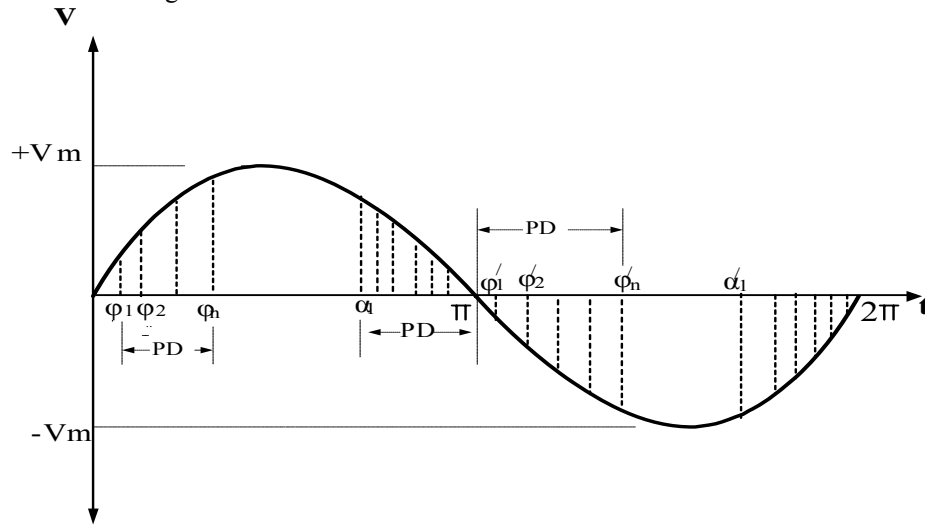

Figure 2. PD under sinusoidal applied voltage

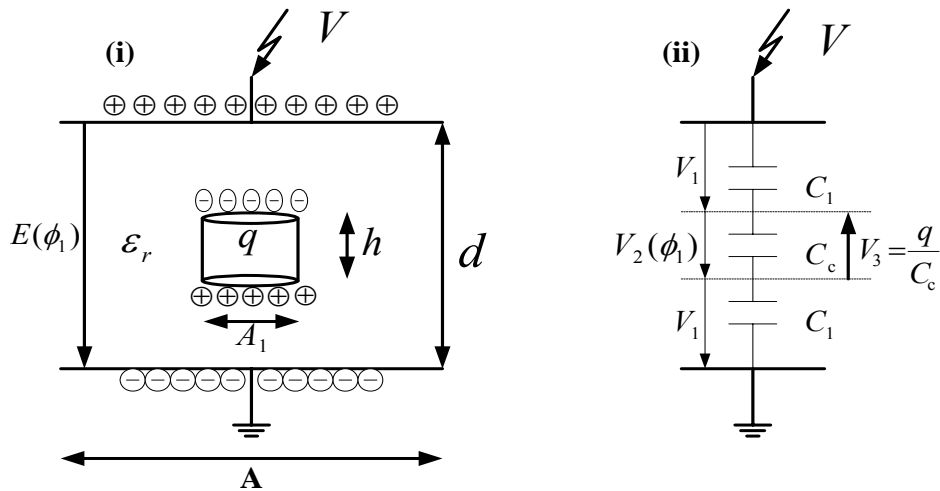

Figure 3. Schematic diagram of (i) void representation in parallel plate (ii) equivalent capacitive network

After the phase angle φ_n before the positive peak of the sinusoidal voltage, the rate of rise of applied voltage becomes small. During this period, the total charge across the void at the extinction of the PD pulse corresponding to the phase angle φ_n is q_n . The voltage across the void acting in opposition to the applied voltage is $V_n = \left[\frac{q_n}{C_c} \right]$ during this period. Due to lower rate of rise of applied voltage, the applied voltage between the two plates is not sufficient enough to cause field intensity within the void in excess of PD inception strength after the phase angle φ_n . Therefore there is no PD after the phase angle φ_n . In other words, PD is taking place between the phase angles φ_1 and φ_n . The total charge q_n remain trapped as the conductivity of the surrounding dielectric is assumed to be zero after the phase angle φ_n . The intensity within the void is always being less than the PD inception strength and hence there is no PD between the phases angle φ_n and α_1 . Therefore, for $\varphi_n < \varphi < \alpha_1$.

$$E_{void}(\varphi_n) = \frac{[V(\varphi_n) - \frac{q_n}{C_c}]}{h} > PD_{inception\ strength} \quad (6)$$

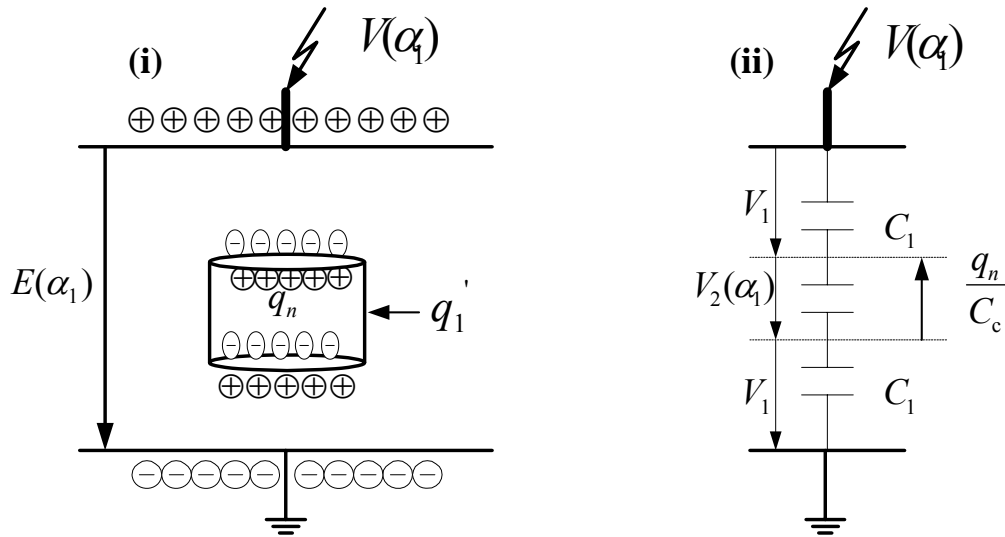

Figure 4. Inception of PD at $\phi = \alpha_1$ due to accumulated charge

But, at α_1 , the applied voltage between the plates becomes too small. Hence, the difference between the voltage across the void due to q_n and the voltage at α_1 is large enough to cause field intensity within the void in excess of PD inception strength as shown in Fig. 4. However, in this case the voltage across the void due to accumulated charge q_n is higher than that due to applied voltage. Hence, the field intensity within the void is act in opposite direction to that due to the applied field. Thus, PD is again occur in the void but in such a way that positive charge is accumulated at the upper surface and negative charges is accumulate at the lower surface of the void as shown in Fig.4 (ii). These charges are cause reduction of the total accumulated charge across the void, which in turn is cause extinction of this PD pulse. In this way PD pulse is appears in between the angle α_1 and π which is gradually reduce the charge accumulated across the void to zero for all practical purposes.

Further, in the negative half cycle, again PD is take place between the phase angles φ'_1 and φ'_n then latter on between the angle α'_1 and 2π . In this way the PD is reappear in the subsequent cycles of the applied high voltage.

3. Results and Discussions

To observe the PD activity due to presence of cylindrical void inside the developed solid insulation model a high voltage of 0-30 kV is applied in between the electrode. As the occurrence of the PD inside the power equipment is not directly measurable because of the PD sources are not accessible an apparent charge method is used. According to IEC 60270 apparent charge 'q' of a PD pulse is that charge which

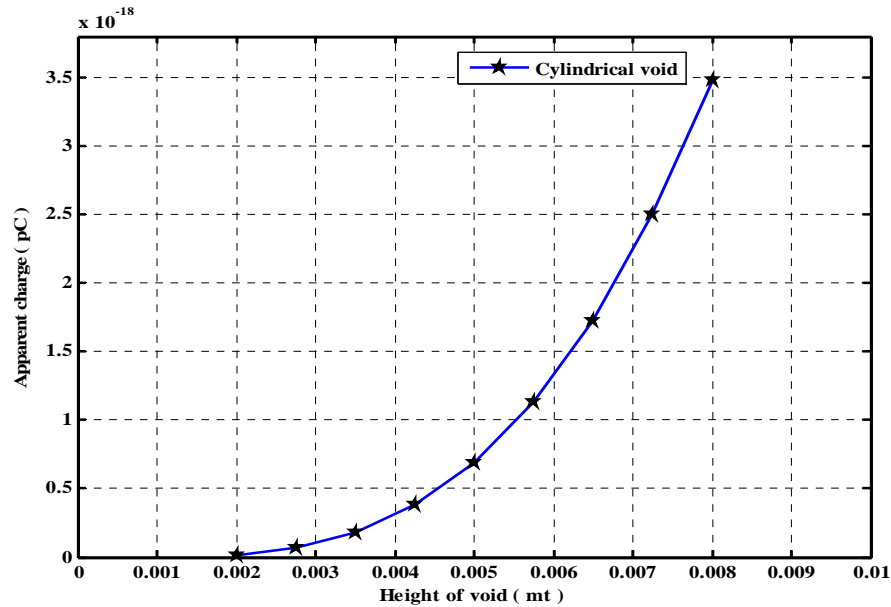

Figure 4. The relation between apparent charge and height of the void.

If injected in a short time between the terminals of a test object in a specified test circuit, would give the same reading on the measuring instruments as the PD current pulse itself. It also studied that, apparent charge is an important factor for PD measurement in the high voltage power equipment. As the partial discharge is highly depends on the geometrical configuration of the void presence in the solid insulation the relation between apparent charge and height of the void, volume of the void and diameter of the void is considered in this study. The relation between the apparent charge and the height of the cylindrical void is shown in Fig. 4. It is observed from the Fig. 4 that with increases of the cylindrical void height from 0.002 to 0.008 mt, the apparent charge is increase from 0.014×10^{-18} to 3.478×10^{-18} pC.

Another study has been made in this work which is the relation between the apparent charge and the volume of the void. It is observed that the apparent charge is also a function of volume geometry of the cylindrical void model. It is also observed that, the volume is directly related to apparent charge which is shown in Fig. 5. It is observed from simulation result that the relation between void volume and apparent charge curve is a linear one. To study the PD activity due to presence of cylindrical void inside the solid insulation, apparent charge and size of the void is also considered in this work. In Fig. 6 it is observed that with the increase of the diameter of the cylindrical void apparent charge is increase. It is observed from the Fig. 6 the diameter of the cylindrical void varies from 0.01 mt. - 0.08 mt. and the corresponding value of the apparent charge is varies from 0.034×10^{-18} to 0.8695×10^{-18} pC.

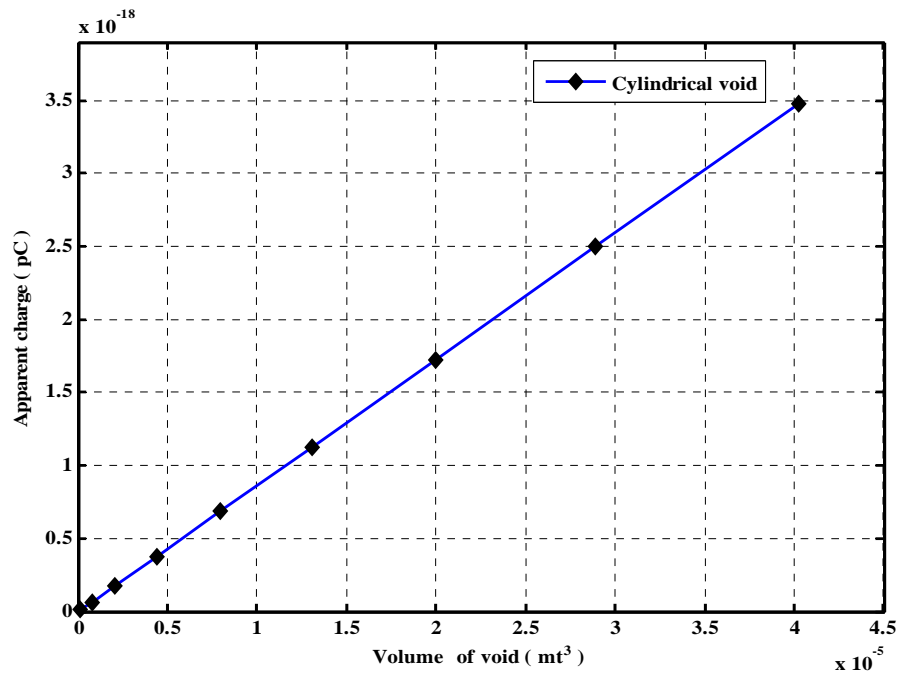

Figure 5 A linear relationship of volume of void with apparent charge.

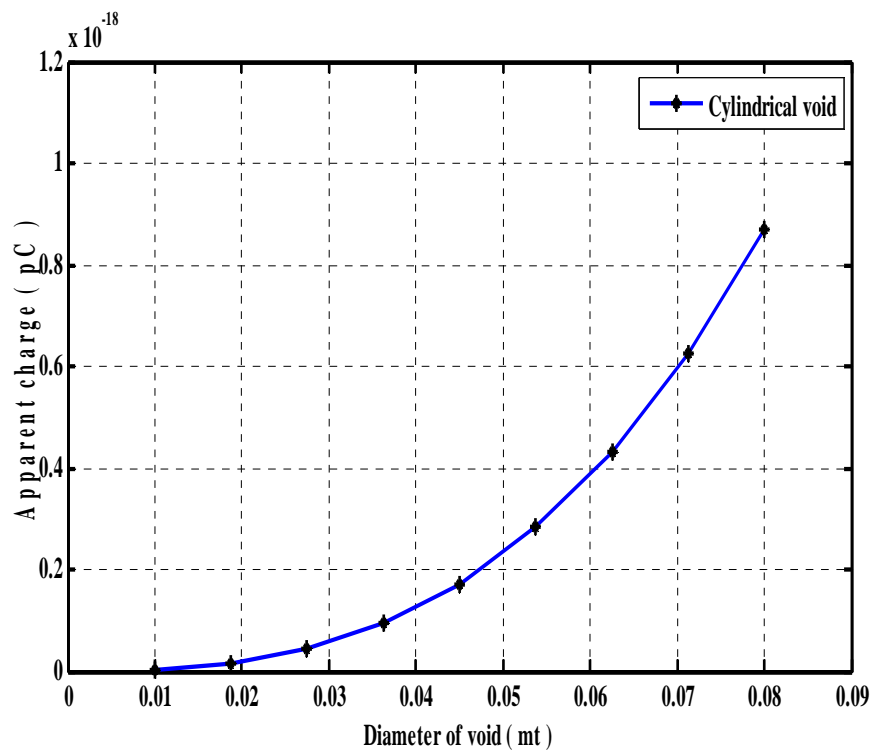

Figure 6. The relationship of diameter of void with apparent charge.

It is understand from the above result that the magnitude of the PD is also vary as the apparent charge is varing with changing the void height, diameter and void volume.

To simulate the PD activity inside the solid insulation medium a MATLAB Simulink model is considered in this work. An increasing voltage of 0-30 kV is applied between the void models to observe the PD activity inside the solid insulation. It is observed that with application of 0- 4 kV between the cylindrical void models no PD was found. The field intensity within the void not exceeds beyond the breakdown strength of gas in void below the applied voltage of 5 kV. In the presented model the field intensity within the cylindrical void not exceeds beyond the breakdown strength of air presence inside the void at the applied voltage of 4 kV. However, further with increase of high voltage between the test object PDs are appearing and it is having small amplitude. The PD inception voltage due to presence of cylindrical void in the solid insulation model is observed at 4.7 kV of applied high voltage. In this work the discharge mechanism inside the void model has been studied for inception voltage, breakdown voltage and between the inception voltage and breakdown voltage. It is observed that PD signal is appeared at the applied voltage of 4.7 kV with having small amplitude which consider as the inception voltage in the presented model and breakdown voltage is found beyond the applied voltage of 30 kV. However, the PD signal is observed and studied in between the different applied voltage from 4.7 kV to 30 kV.

Further with increase of high voltage between the test object PDs are appearing having small amplitude. At the applied voltage of 5 kV PDs are found due to presence of void inside the solid insulation. With the applied voltage of 5 kV the field intensity within the void exceeds the breakdown strength of gas in void and PD pulse is observed which is shown in Fig. 7. As the detection of the partial discharge signal are done generally in two way, either the measuring impedance Z_m is placed in series with the test object or Z_m is placed in series with the coupling capacitor. As the high voltage source impedance is large both the detection method is electrically same as the same voltage occurs across the impedance Z_m . In this work, as the test object is very small the measuring impedance is connected in series with the test object with a parallel combination of the RLC circuit. The output of the RLC circuit is damped oscillatory in nature which is shown in Fig. 7. Therefore, in positive half cycle of the applied voltage small negative pulses appear and in negative half cycle of the applied voltage small positive pulses appear. In RLC circuit, the voltage impulse of the specified applied voltage is given by

$$V = \frac{q}{C_a + C(1 + \frac{C_a}{C_k})} \times (e^{-t/2Rm}) \times \cos(wt) \quad (7)$$

where, V represents the value of PD amplitude, q for apparent charge, C_k for value of coupling capacitor, $\omega = \sqrt{\left(\frac{1}{Lm} - \frac{1}{4R^2m^2}\right)}$ and $m = \frac{C_a \times C_k}{C_a + C_k} + c$

To identify the position of PDs with respect to the phase angle, phase resolve partial discharge (PRPD) detection technique is an important tool for monitoring of HV power equipment. To distinguish the PDs with other discharges, the presence of PD pulses in the different quadrant gives the cause of occurrence of PDs [6-8]. The applied voltage of 5 kV and along with the PD pulse is shown in Fig. 8. It is observed that PD pulse is appears nearly 90 degree phase angle in positive half cycle and nearly 270 degree phase angle in negative half cycle of the 5 kV applied voltage which is shown in the Fig. 8. Due to lower rate of applied voltage between the test object is not enough to cause a field intensity within the void in excess of PD inception strength. Therefore, PDs are mostly appearing at 90 degree phase angle and 270 degree phase angle of the applied voltage where the maximum amplitude of the applied voltage is reached.

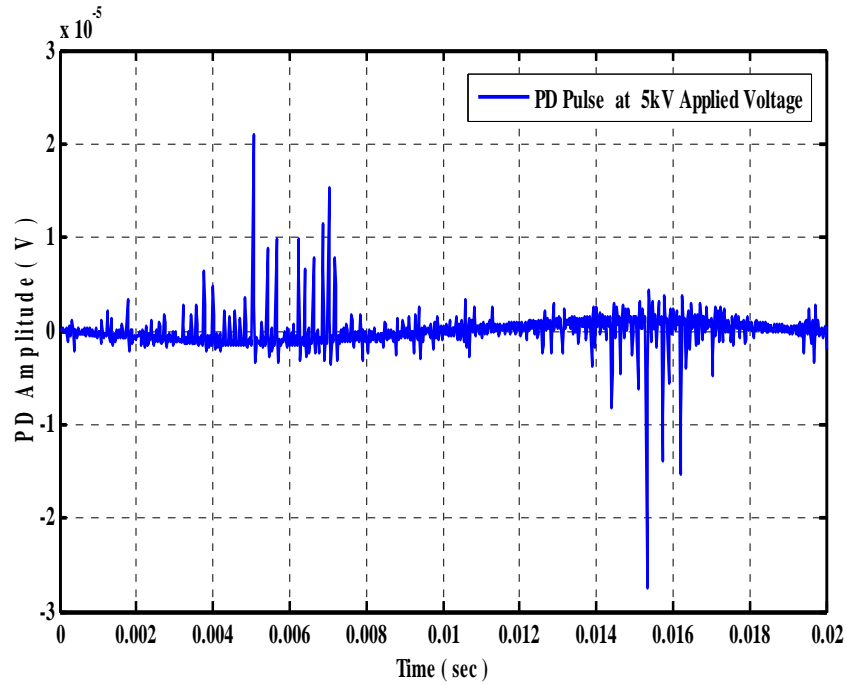

Figure 7. PD pulse observed with 5 kV Applied Voltage

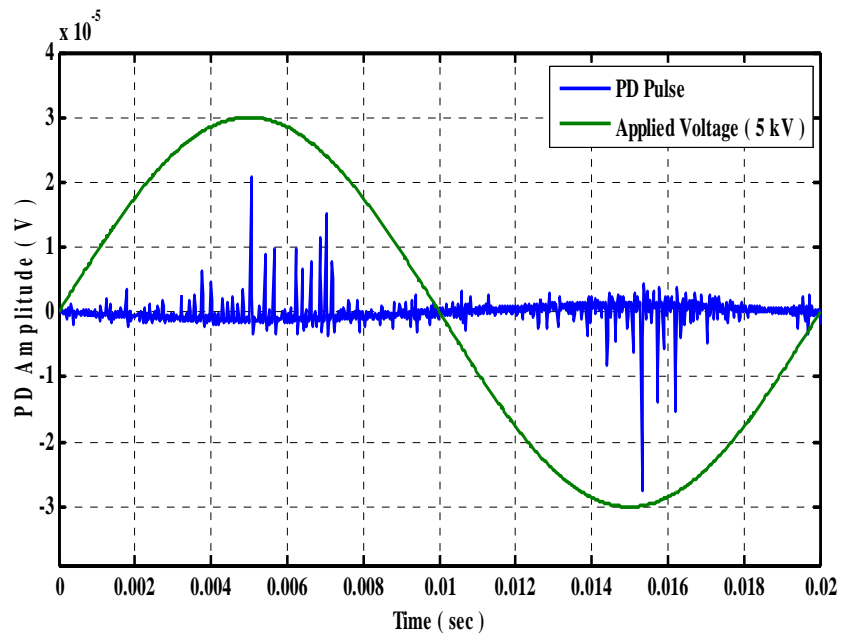

Figure 8. Observed PD Pulse with 5 kV Applied Voltage between the test object

Further an analysis has been made for presence of PD pulses over a total measuring period under applied voltage of 5 kV. In this study the total phase angle is divided into eight section having 45° phase angle each. It is observed that, the number of PD pulse appeared in the each section is not constant as the PD is the random phenomenon. In this Fig. 9, the number of PD pulses is appeared in the different phase angle of the applied voltage. It is observed that with the

application of the applied voltage of 5 kV, the observed PD signals contains seventy one (71) PD pulse out of which thirty nine (39) numbers of PD is appears in the positive half and thirty two (32) numbers of PD pulse are appeared in the negative half of the applied voltage. In addition, it is also observed that the number of the PD appears in different applied voltage is not fixed rather it is appears randomly.

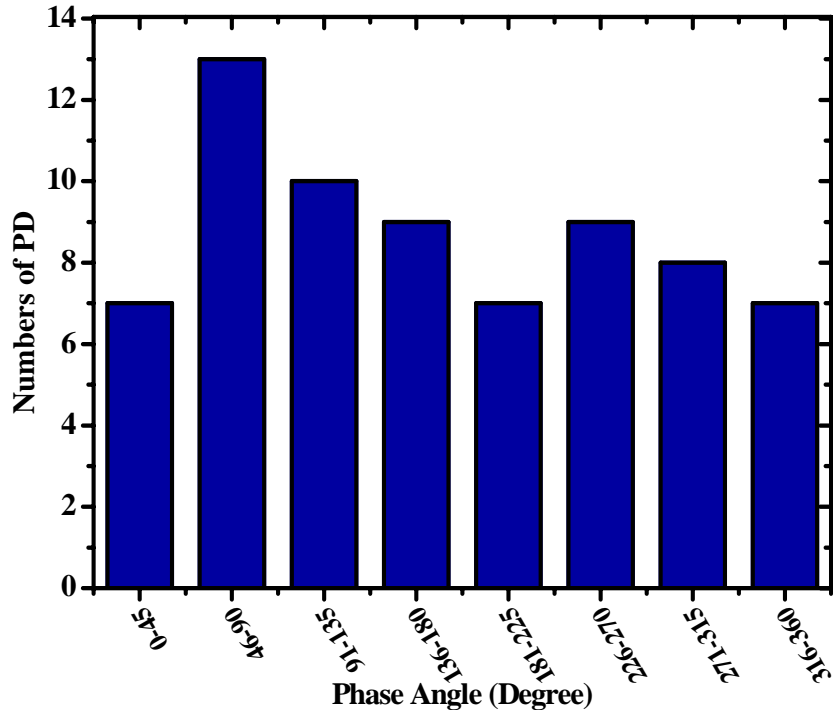

Figure 9. Number of PD pulse found at positive and negative half cycle of applied voltage of 5 kV

During the simulation process both the applied voltage of 5kV and the PD data are collected in the time domain with a length of 20 ms. There after only PD data are collected and processes for frequency analysis to know the actual frequency contain of the PD signal throughout the time domain. To analysis the observed PD signal the recorded PD data are analysis with Fast Fourier Transform (FFT) and corresponding frequency spectrum of the PD signal is plotted which is shown in Fig. 10. As the supply voltage frequency is always fixed and known value (i.e., 50 Hz) therefore the unknown frequency contain of the PD signal has been plotted by considering the PD data only. The frequency plot of the recorded PD signal is shown in Fig. 10. It is observed that the number of frequency spectrums is found due to presence of PD pulses at different time instances. It is observed that the frequency is varies in the range of 1.5 kHz to 20 kHz. Figure 10 shows that the different combination of the frequency is presence as the PD pulse duration of each PD pulse appears along the time axis is different. As the PD phenomenon is the random in nature so the frequency appears for this PD pulse is also fluctuating in nature. It is also observed from the each PD pulse presence in the both the positive and negative half cycle of the applied voltage is that the pulse duration of the PD signal appeared in the range of 60 to 70 μ sec respectively. It is also observed that the maximum amplitude of the frequency of the same PD pulse is appears at 5 kHz, 8 kHz and 12.5 kHz which is shown in Fig. 10. The dominant frequency of PD appeared at 5 kHz, 8 kHz

and 12.5 kHz because of the time duration of the PD pulses appears for such instance are much shorter compare to the other PD pulse instance present in the observed PD signals.

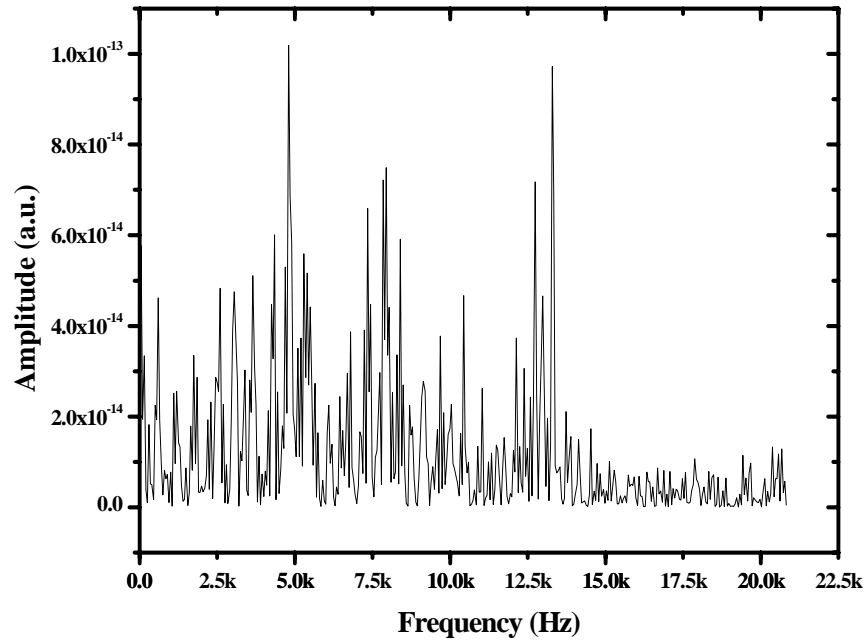

Figure 10. Frequency plot of observed PD pulse at 5 kV Applied Voltage.

In this work, an increasing voltage of 0-30 kV is applied between the void models to observe the wide range of the PD activity inside the solid insulation. It is also observed from the Fig. 11 that the maximum amplitude of the PD is the function of the applied voltage. As the PD is random phenomenon the appearance of maximum amplitude of such PD signal is also changes over a cycle of applied voltage. The maximum amplitude is varies in the range from 2.09×10^{-5} - 1.5×10^{-4} V with the application of the high voltage range of 5-30 kV which is depicted in Table 3. It is clear that with the increase of the high voltage the amplitude of the PD is also increased. Generally, the amplitude of the partial discharge phenomenon is the function of the applied voltage. It is observed during the simulation study that with the increase of the applied voltage on the test object the PD magnitude is also increases [1-2]. As the appearance of the PD and its magnitude is random phenomena i.e., the amplitude of the PD is highly variable with the applied voltage which is shown in Fig. 11. However, it is observed that the between the 5 kV to 7 kV applied voltage PD magnitude is decreasing and thereafter the PD magnitude the increasing with the increases of applied voltage upto 30 kV.

Table 3
Variation of PD Pulse Amplitude with Different Applied Voltage

Applied voltage (kV)	PD amplitude (V)
5	2.09×10^{-5}
6	8.15×10^{-6}
10	2.86×10^{-5}
20	5.6×10^{-5}
28	1.2×10^{-4}
30	1.5×10^{-4}

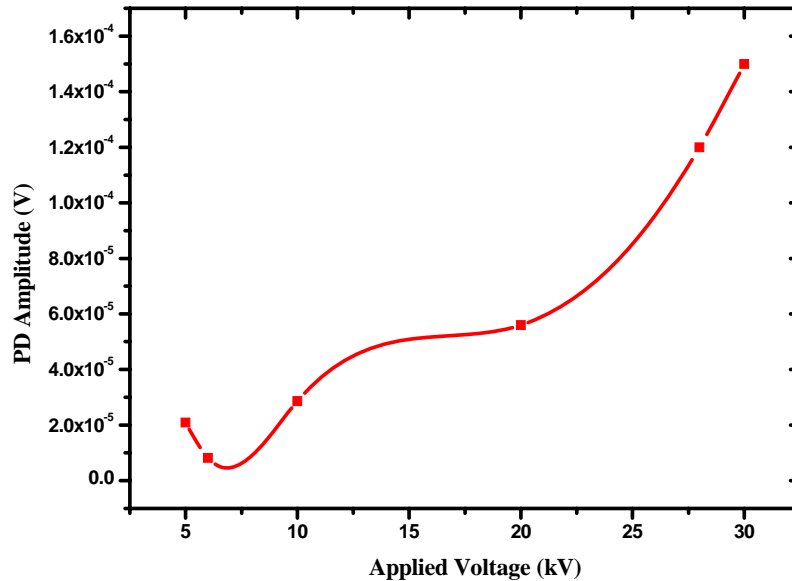

Figure 11. Maximum amplitude variation of PD pulse with different applied voltage.

4. Conclusion

Partial discharges are a major source of insulation failure in high voltage power system which needs to be monitor continuously to avoid the incipient failure in the power system network. To understand the PD activity inside the solid insulation a MATLAB based simulink model has been developed in this work. In this work it is studied that the PD activity in side the solid insulation is highly depends on the entire geometry of the void presence inside the solid insulation model. In addition, PD is increases with the increase of applied voltage inside the solid insulation. In this study an efforts have been made to investigate the maximum PD magnitude, number of PDs and number of other PD related parameters like PD distribution, frequency content of obtained PD pulse by using phase resolve partial discharge (PRPD) measurement technique.

This study will ensure the power engineers to predict the quality of the insulation used for high voltage power equipment. The present work is to be extended for further study in different high voltage power equipment such as current transformer (CT), potential transformer (PT), switch gear and circuit breaker.

5. Reference

- [1] E. Kuffel, W. S. Zaengl, and J. Kuffel, Non-destructive insulation test techniques, *High Voltage Engineering: Fundamentals*, Second Edition, Butterworth-Heinemann, Oxford, pp.395-459, 2000.
- [2] IEC Standard 60270, High Voltage Testing: Partial Discharge Measurement, 1996.
- [3] G.C. Crichton, P.W. Karlsson and A. Pedersen, 'Partial discharges in ellipsoidal and spherical voids', *IEEE Transaction on Electrical Insulation*, Vol. 24, No. 2, April 1989.
- [4] G. C. Crichton, P. W. Karlsson and A. Pedersen, "Partial Discharges in Ellipsoidal and Spherical Voids", *IEEE Trans. on Dielectric and Electrical Insulation*, Vol. 24, No. 2, , pp. 335-342, April 1989.
- [5] R. J. Van Brunt, "Physics and Chemistry of partial discharges and corona", *IEEE Transaction on dielectric and Electrical Insulation*, Vol. 1, No. 5, pp. 761-784 October 1994.

- [6] M. G. Danikas, "Some New Relationships and a Scaling Law Regarding Partial Discharges in Spherical Cavities Enclosed in Solid Insulation", *Acta Electrotechnica Napocensis*, Vol. 39, No. 1, pp. 5-9, 1998.
- [7] N. Kolev, P. Darjanov, E. Gadjeva and D. Darjanova, "Partial Discharge Phenomena Simulation using General-purpose Analysis Program", *Proc of 6th IEEE International Conference on Conduction and Breakdown in solid Dielectrics-ICSD 98*, June 22-25, Vasteras, Sweden, 1998, pp. 149-152.
- [8] C.Y. Ren, Y. H. Cheng, P. Yan, Y. H. Sun and T. Shao, "Simulation of Partial Discharges in Single and Double voids Using SIMULINK" *Journal of Xi'an Jiatong University*, Vol.38, No.10, pp. 120-122, 2004.
- [9] N. Kolev, P. Darjanov, E. Gadjeva and D. Darjanova, "An approach to develop a partial discharge investigation", *Proc. of the IEEE Electrical Insulation Conference and Electrical Manufacturing and Coil Windings conference, Chicago*, 1997, pp. 507-510.
- [10] F. Gutleisch and L. Niemeyer, "Measurement and Simulation of PD in Epoxy Voids", *IEEE Transaction on Dielectrics and Electrical insulation*, Vol.2, No.5, pp. 729-743, 1995.



Asima Sabat was born on 21st April, 1983. She received the B.E. degree in Electrical Engineering from Utkal University of Orissa, India, 2004. Currently she is pursuing M.Tech. degree from National Institute of Technology, Rourkela, Odisha, India. Her research interests are physical modelling and study of characteristics of partial discharge for high voltage power equipment.



S. Karmakar (M'10) was born in Balarampur, India, on 6th January, 1981. He received his Bachelor degree with Honours in Electrical Engineering from Burdwan University, India, in 2004. He received the M.Tech. degree in Industrial Electrical System and Ph.D degree in High Voltage Engineering from the National Institute of Technology, Durgapur, India in 2006, 2011 respectively.

Presently he holds the post of Assistant Professor, Department of Electrical Engineering, NIT Rourkela, India.

Dr. Karmakar is currently Associate member of The Institute of Engineers (India), Indian Laser Association (ILA) and life member of optical Society of India (OSI). His research interests include on-line monitoring of partial discharge in high voltage equipment and detection as well as signal processing in power equipment. He is also interest in fiber-optics based sensors and applications.