

# SIMULATION OF PRODUCTION PROCESS REORGANIZED WITH VALUE STREAM MAPPING

*Nikola Gjeldum, Ivica Veža, Boženko Bilić*

Original scientific paper

The philosophy of Lean production offers a wide variety of advantages. Lean production concept is understood as the realization of Lean principle through the efficient application of methods and tools, with faster and more effective discovering of wastes and mistakes in the production systems. This article contains a presentation of the simulation application on production process previously analyzed with Value stream mapping tool. The model was applied to a production line in the shipbuilding industry in Croatia. The production line current state is simulated with varying market requirements. Using Lean management tools, future improved state was developed and simulated. The simulation provides dynamic models with varying production performance results, unlike by applying only a Value stream mapping tool. During simulation runtime, adaptation of production process by varying resources assignment to continuous working cell was done to fulfill order requirements on time.

**Keywords:** *Lean management, production system, resource, simulation, Value stream mapping*

## Simulacija proizvodnog procesa reorganiziranog s Mapiranjem toka vrijednosti

Izvorni znanstveni članak

Filozofija Lean proizvodnje nudi široku paletu prednosti. Lean koncept proizvodnja predstavlja ostvarenje Lean principa kroz učinkovitu primjenu metoda i alata, za brže i učinkovitije otkrivanje gubitaka i pogrešaka u proizvodnim sustavima. Ovaj članak sadrži prikaz korištenja simulacije proizvodnog procesa koji je prethodno analiziran i reorganiziran pomoću Mapiranja toka vrijednosti. Model je primijenjen za jednu proizvodnu liniju u hrvatskoj brodograđevnoj industriji. Trenutno stanje proizvodne linije je simulirano s varijabilnim zahtjevima tržišta. Korištenjem alata Lean proizvodnje, razvijeno je i simulirano buduće stanje toka vrijednosti. Simulacija omogućava dobivanje i analizu dinamičkih modela s promjenjivim performansama proizvodnog sustava, za razliku od primjene samo alata Mapiranja toka vrijednosti. Tijekom simulacije, korištena je prilagodba proizvodnog procesa variranjem pridodavanja resursa radnoj stanici, koja je služila za ispunjavanje zahtjeva tržišta na vrijeme.

**Ključne riječi:** *Lean menadžment, Mapiranje toka vrijednosti, proizvodni sustav, resursi, simulacija*

## 1 Introduction Uvod

At the turn of the third millennium the world industry has found itself in probably the largest restructuring since the first industrial revolution. The progress is determined by two trends:

- dynamic progress of information and communication technologies which have enabled the creation of new markets and the redefinition of entire professions,
- globalization of economy thanks to new purchasing and selling markets.

Such a progress forces enterprises to modify their production strategies. New competitors, greater changes in demand in the course of time in market stagnation present enormous cost pressure upon many enterprises. In order to meet customers' needs everywhere in the world, the enterprise should increase its flexibility.

A long lasting success will be achieved only by the enterprises that will, besides the necessary optimization of production process, identify and conquer new markets as well.

One of the possible conceptions for the survival in a turbulent world market is the introduction of new technologies and organizational structures (for example fractal factory, network enterprises, Lean production, six sigma, business process reengineering, etc.).

Though lean production has been widely recognised for its effectiveness in continuously improving productivity, product quality, and on-time delivery to customers, the cost for hiring a full-time lean manufacturing engineer has kept many small businesses from implementing lean in their facilities [1].

Methods and tools used in Lean concept modeling can be described as important elements in manufacturing system construction (Fig. 1).

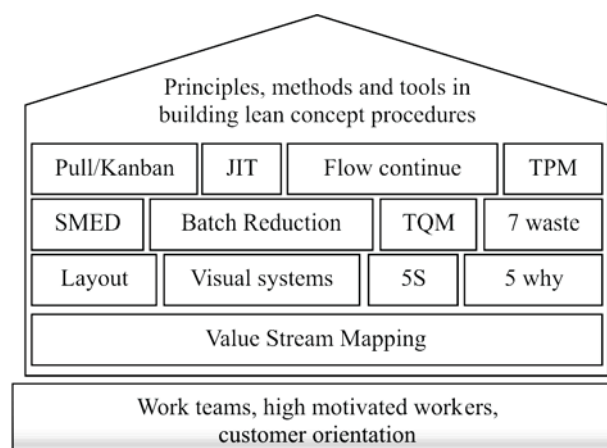

**Figure 1** *Lean concept principles, tools and methods*  
**Slika 1.** *Alati, metode i načela Lean koncepta*

As shown in Fig. 1 Lean concept principles symbolically represents a house, the base of everything are: work teams, highly-motivated workers and customer orientation. As all tools are important, they are arranged at random. Beside these tools there can be produced and shaped others which in certain conditions give better results.

Value stream mapping is an enterprise improvement tool to help in visualizing the entire production process, representing both material and information flow [2]. A graphic description of results and work process, and Value Stream Mapping analysis are bases for encouragement of managers to make decisions about loss reduction and Lean

concept modeling with given tools and methods.

Value stream mapping can be a communication tool, a business planning tool and a tool to manage a change process. Value stream mapping is essentially a language and, as with any new language, the best way to learn mapping is to practice it formally at first, until it can be used intuitively [3].

Value Stream Mapping (VSM) initially follows the steps shown in Fig. 2. The first step is drawing the current state, which is done by gathering information on the shop floor. This provides the information needed for developing a future state. Arrows between current and future state go both ways, indicating that development of the current and future states are overlapping efforts. Future state map presents a modification of the current state map. Likewise, drawing of future state map will often point out important current state information overlooked before.

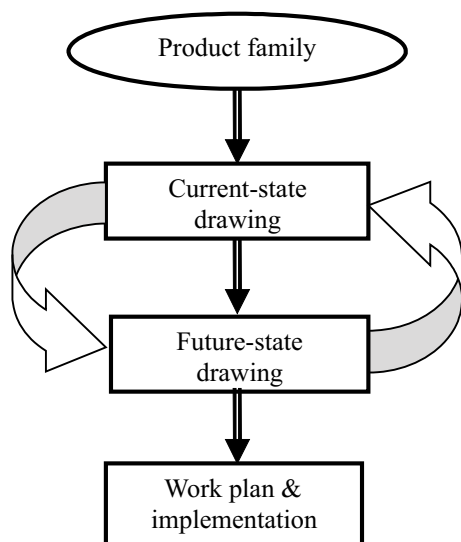

Figure 2 Initial Value stream mapping steps [4]  
Slika 2. Izvorni koraci mapiranja toka vrijednosti [4]

The final step is to prepare and begin activities using an implementation plan that describes how it is planned to achieve the future state. Then, as the future state becomes reality, a new future state map should be drawn. This is a continuous improvement at the value stream level.

In this paper is shown the reengineering of one production system in Croatian shipbuilding industry using Lean production principles.

## 2 Simulation of VSM models Simulacija VSM modela

Initial Value stream mapping tool shown in Fig. 2 presents one of most frequently used Lean management tools for production reorganization. The advantage of this tool is simplicity in modeling, analysis and development of future state map, which is based on changes of current state map. The main waste and production problems are recognizable from hand drawn maps immediately after data from shop floor is gained.

On the other hand, dynamic market and customer demands, implementation of gained knowledge about process errors, improvement of workers skills, and difficulties of exact process times and machine downtimes determination, make production process performance

depended on time as well. Despite availability of different tools and techniques proposed for manufacturing industry, it has been reported that manufacturers are usually facing significant practical problems when trying to model in detail production process and to predict results of changes implementation in existing environment [5].

Although VSM is often a continues process of improvement, which is iteratively drawn, it cannot be considered as a dynamic tool. Therefore, simulation of current state and developed future state presents a tool for improvement of results gained by VSM. Steps of new model for process reorganization using VSM and simulation together are presented in Fig. 3.

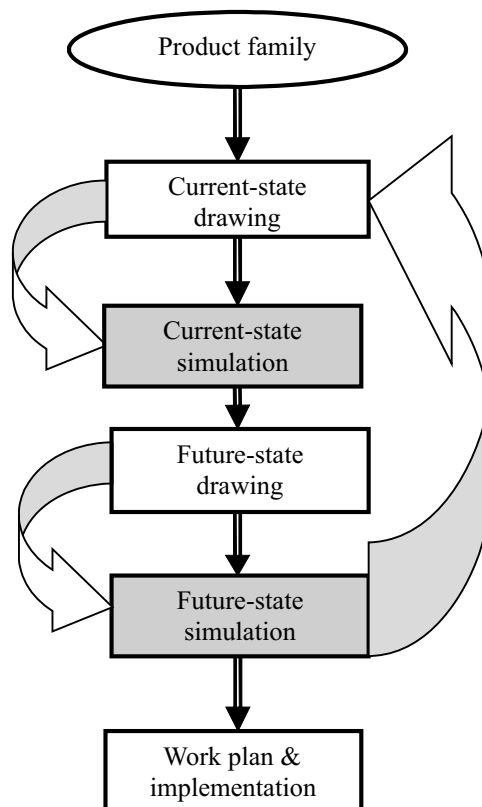

Figure 3 Steps of new production reorganization tool  
Slika 3. Koraci novog alata za reorganizaciju proizvodnje

Simulation of production process can be achieved by a large number of different simulation software available on market. Together with the use of drawing tools, which are capable of achieving realistic three dimensional shop floor models, simulation software uses distributions and random numbers for all kinds of process data which can vary during the time. Programmable logic can be applied for material and resources movements, downtime definition, decision making and adaptation of simulation model results for new model inputs. Optimization and simulation scenarios can also be introduced.

Combination of VSM and simulation therefore presents a powerful tool for production process reorganization and new improved production performance determination.

3

**Case study: pylon production line**

Primjer iz prakse: linija proizvodnje pilona

3.1

**Current state map of pylon production**

Mapa trenutnog stanja proizvodnje pilona

In this paper, the case of one production process in one Croatian shipbuilding factory is used for drawing the current-state Value stream map. First, all the necessary data related to the selected production process has been gathered on shop floor. The product family, for which the value stream will be monitored, is a group of pylons for gas platforms, produced in two versions. One version is for platforms Type-A and Type-B, and the other version is for platform Type-C. The pylons are used for strengthening platforms at the bottom of the sea. Gas platforms are positioned at two different sea depths in the Adriatic Sea, which is the reason for building the pylons of two different lengths, but of the same diameter.

The range for value stream for shipbuilding factory will be at the "door-to-door" level, and starts from the main supplier of raw material (steel plates). The value stream finishes with shipping to the customer.

The shipbuilding factory production is organized in two shifts of 7,5 working hours, and 5 working days per week. Overtimes are arranged due to being late in pylon production and supply, and it presents additional production costs.

Current state value stream map is drawn according to VSM symbols [6] and is shown in Fig. 4.

In pylons production process the flow of information is drawn back from the customer to the Production Planning

and Control (PPC) department and from there to the steel plate supplier. There are separate lines for the monthly orders and three month forecast. Regarding the received data from customer, PPC sends weekly order and one month forecast of raw material to steel plate supplier.

In the current state map it is shown that material movements are pushed by the producer, not pulled by the customer. Push means that a process produces something regardless of the actual needs of the downstream customer process.

Push typically results in producing according to a schedule driven by customer current needs. Because schedules changes and production rarely go exactly according to a schedule, inventory growth can be seen in most of production processes. When each process has its own schedule from PPC, it is operating as an "isolated island", disconnected from any sort of downstream customer. Each process is able to set batch sizes or to organize production at a pace, which makes sense from its perspective.

In this situation, the supplying processes will tend to make the parts their customer processes do not need now, and those parts are pushed into local storage or, at the end, into warehouse of finished products without purpose.

This type of "batch and push" processing makes it almost impossible to establish the smooth flow of work from one process to the next that is a hallmark of Lean production.

In pylons production process in shipbuilding factory lead time according to VSM is 86,74 days. For the production of one pylon 176 hours (11,74 days) are needed. The essence is to find out where 75 days are spent during the production.

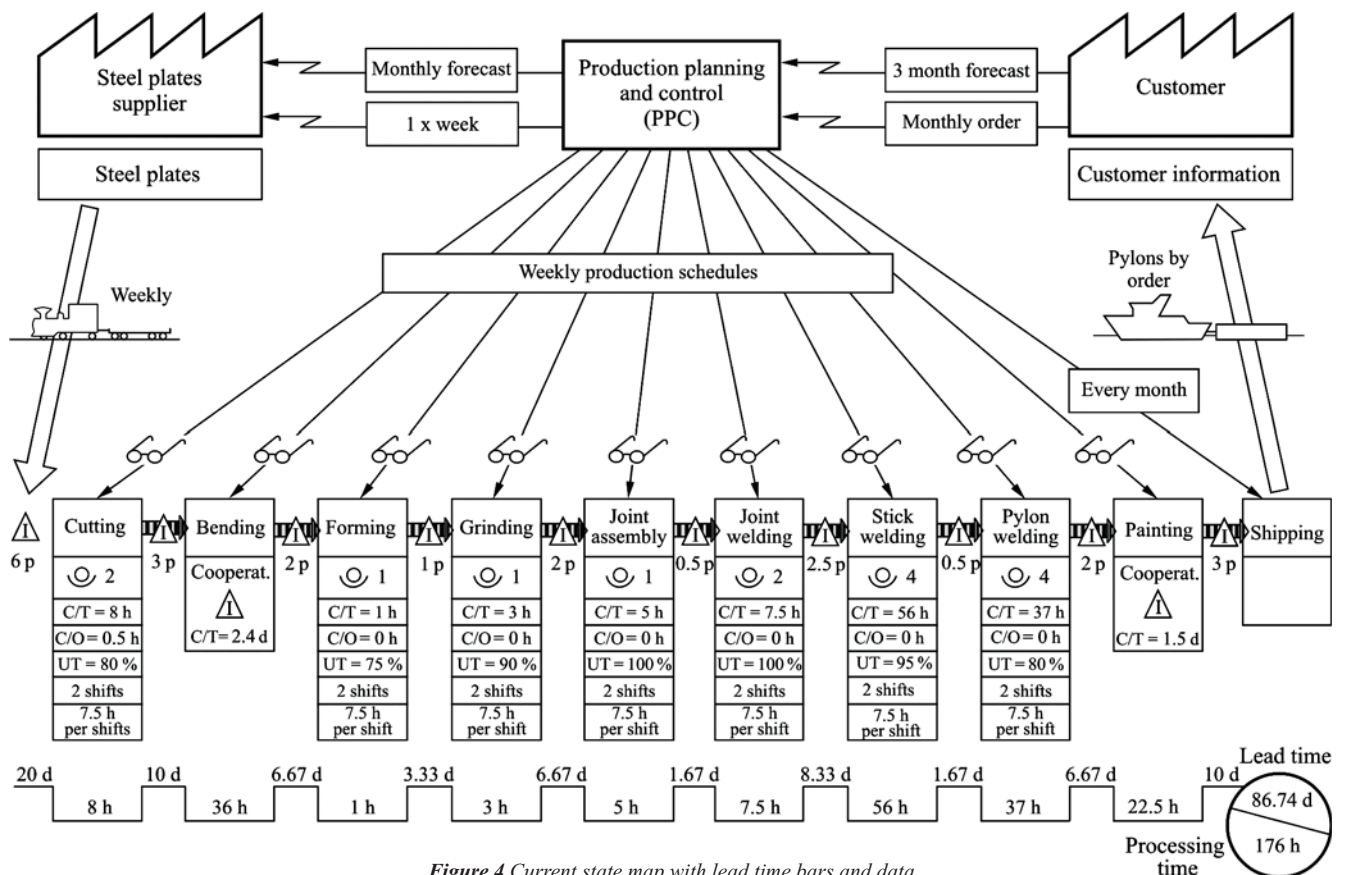

Figure 4 Current state map with lead time bars and data  
Slika 4. Mapa trenutnog stanja sa podacima o vremenu ciklusa proizvodva

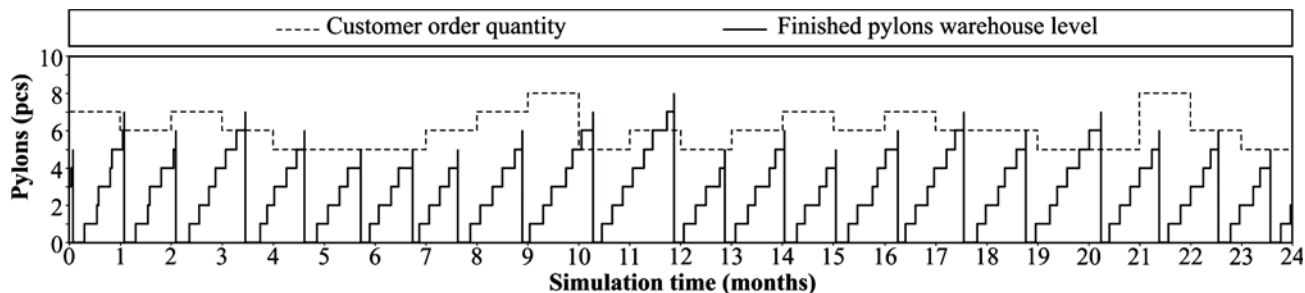

Figure 5 Current state varying orders and number of pylons in warehouse  
 Slika 5. Variranje količine narudžbe i broj završenih pilona u skladištu u trenutnom stanju

**3.2**  
**Simulation of current state**  
 Simulacija trenutnog stanja

Simulation of pylon production process was done using ProModel 7.5 simulation software. All processes were set to produce the amount of pylons according to varying monthly customer demand. Gathered input information data are entered into model using normal distribution random generator. Process times or cycle times (C/T), machine downtimes defined by uptime (UT) and changeover times (C/O) were set at mean values shown in Fig. 4 with variance of 10 %. Ordered quantity has mean value of 6,5 pcs, with variance of 1 pc. PPC launches orders weekly to all production processes. Local storages maximum inventory level was set at ten pylons, and maintenance of that level was obtained by 'go-see' inspections.

For simulation results analysis, it is important to define warm-up simulation period, to omit incorrect data gained by starting unemployment of late downstream processes. Warm-up period was set to two working months and total monitored simulation time was 24 working months. Results of simulation and the customer demand and number of finished pylons ready to ship are shown during simulation time in Fig. 5. Immediately after fulfilling the warehouse of finished products with ordered number of finished pylons, shipping by tug boat and barge starts. It can be seen that at the end of simulated time, delay in shipping was approximately 3,7 months (order for month 20 shipped on month 23,7). The length of delay time is changing due to varying ordered quantity and varying process times and machine downtimes. In Fig. 6 bottleneck process can be easily recognized. Stick assembly process has all simulation time only in operation and downtime mode and therefore presents a bottleneck process.

Inventory growth, up to limited amount, occurs in local storages, which are upstream of bottle neck process (joint assembly and joint welding). These processes are therefore blocked due to maintenance of maximum local storage inventory levels effort. Percentages of processes statuses are shown in Fig. 6.

**3.3**  
**Future state map according Lean production principles**

Buduća mapa toka vrijednosti prema principima Lean proizvodnje

The aim of the Lean manufacturing concept is to get one process to make only what the next process needs when it needs it. It is necessary to link all processes, from the final costumers back to raw material, in a smooth flow, without

detours, that generates the shortest lead time, highest quality, and lower cost.

In the future state developing process, the following guidelines are used:

1. Production to the tact time.
2. Developing continuous flow wherever possible.
3. Using supermarkets to control production where continuous flow does not extend upstream.
4. Trying to send the customer schedule to only one production process.
5. Distributing the production of different products evenly over time at the pacemaker process (Level the production mix).
6. Creating a pull system.

In order to succeed in implementation of Lean manufacturing, the foreign experience, like Toyota experience, [7] and [8], is used. By implementing the Lean manufacturing the lead time can be shorten, and thereby flexible production can be achieved, with faster and easier response to customer demand [9].

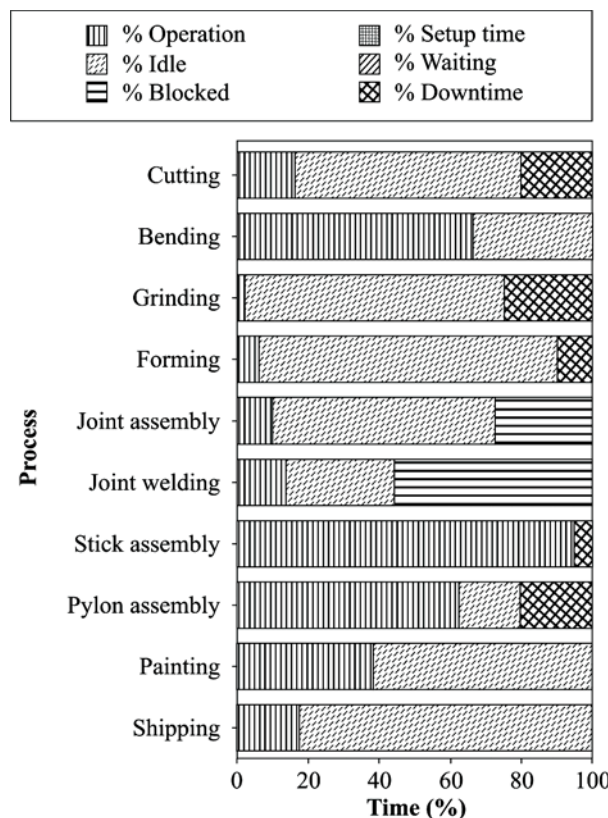

Figure 6 Current state processes statuses  
 Slika 6. Statusi procesa mape trenutnog stanja



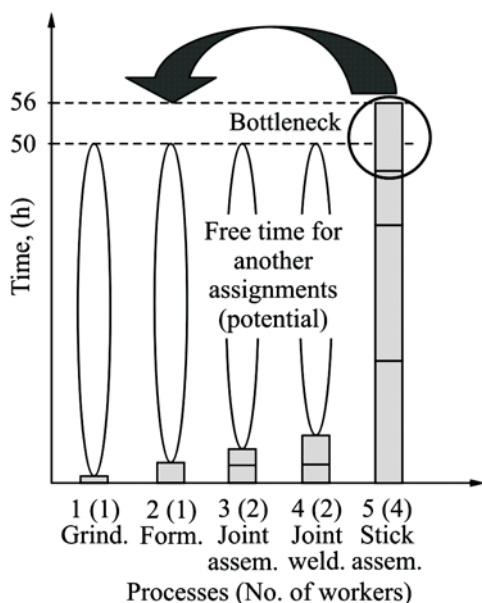

Figure 7 Current state worker assignments  
Slika 7. Trenutno stanje pridodavanja radnika

Based on current state analysis and production processes shop floor layout, continuous flow consisting of the grinding, forming, joint assembly, joint welding and stick assembly (bottleneck process) locations can be applied. All of these processes at the locations can be consolidated into one common process, or the location in which a specific number of resources can be assigned. Continuous process eliminates the local storages, and uneven utilization of resources assigned to previously arranged processes what can be seen in Fig. 7. By optimization of tasks assignment, shown in Fig. 8 and 9, it is possible to achieve shorter tact time of continuous process, with often smaller number of assigned resources (workers). All workers taking place at the new location have to be skilled in all kinds of work inside continuous process.

For the average customer demand level (6 pylons/month), customer tact time can be calculated. Available working time per month is 300 h, and thus tact time of 50 h, shown in Fig. 8, is necessary to fulfill average customer demand. After optimization of tasks assignment, total number of workers in continuous process is 6 (Fig. 8).

One of main principles, which provide a framework for managing production based on Lean production, is adjusting the production to the level of demand. In that

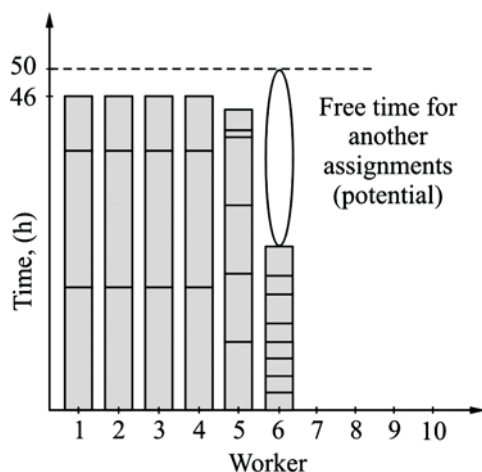

Figure 8 Future state worker assignments  
Slika 8. Buduće stanje pridodavanja radnika

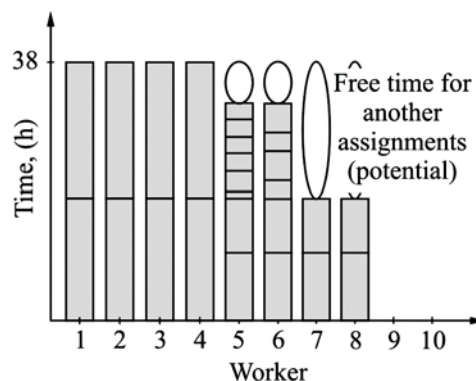

Figure 9 Additional workers assignments  
Slika 9. Dodatno pridodavanje radnika

way it is possible to accomplish all customer demands and needs in every stage of production process [5].

During simulation time, customer demand grows up to 8 pylons/month. To fulfill increased demand, production tact time has to be additionally reduced. By assignment of two more workers to continuous (bottleneck) process, cycle time is reduced to 38 hours (Fig. 9).

In case of further increasing of resources assignment to continuous process, pylon assembly process becomes a bottleneck process.

The number of resources by application of continuous process is reduced by 4 or 2. Except resources balancing throughout of continuous process arrangement, Lean tools like use of supermarkets with kanban pull system, heiyunka, first in first out (FIFO) material flow were also used in future state developing process.

Future state value stream map is developed using the Lean manufacturing tools and shown in Fig. 10. In future state, according to VSM, lead time is reduced to 55,07 days which represents saving of 31,67 days in comparison to current state. Like in current state, for the production of one pylon 176 hours (11,74 days) are needed.

### 3.4 Simulation of future state Simulacija budućeg stanja

Simulation model for future state was also developed. The same process time values and varying customer demand were applied.

Simulation results are shown in Fig. 11. The customer demand and number of finished pylons ready to ship are shown during simulation time. It can be seen that at the end of future state simulation time, delay in shipping was approximately 8 days which is appreciable improvement in comparison to current state simulation results. The delay time of maximum 11 days occurs in 17-th month of simulation time. The varying assignment of resources to continuous (bottleneck) process, also shown in Fig. 11, speeding up production process in periods of time when customer demand raises to 7 or more pylons per month. Increased number of resources continues to work in continuous process until shipment of that order is done.

The production was organized as pull system with FIFO material flow, which blocks processes in producing a larger amount of products that the next downstream process needs in that moment. During simulation time, because of bottleneck process cycle time adjusting, there was not a significant delay time in shipping.

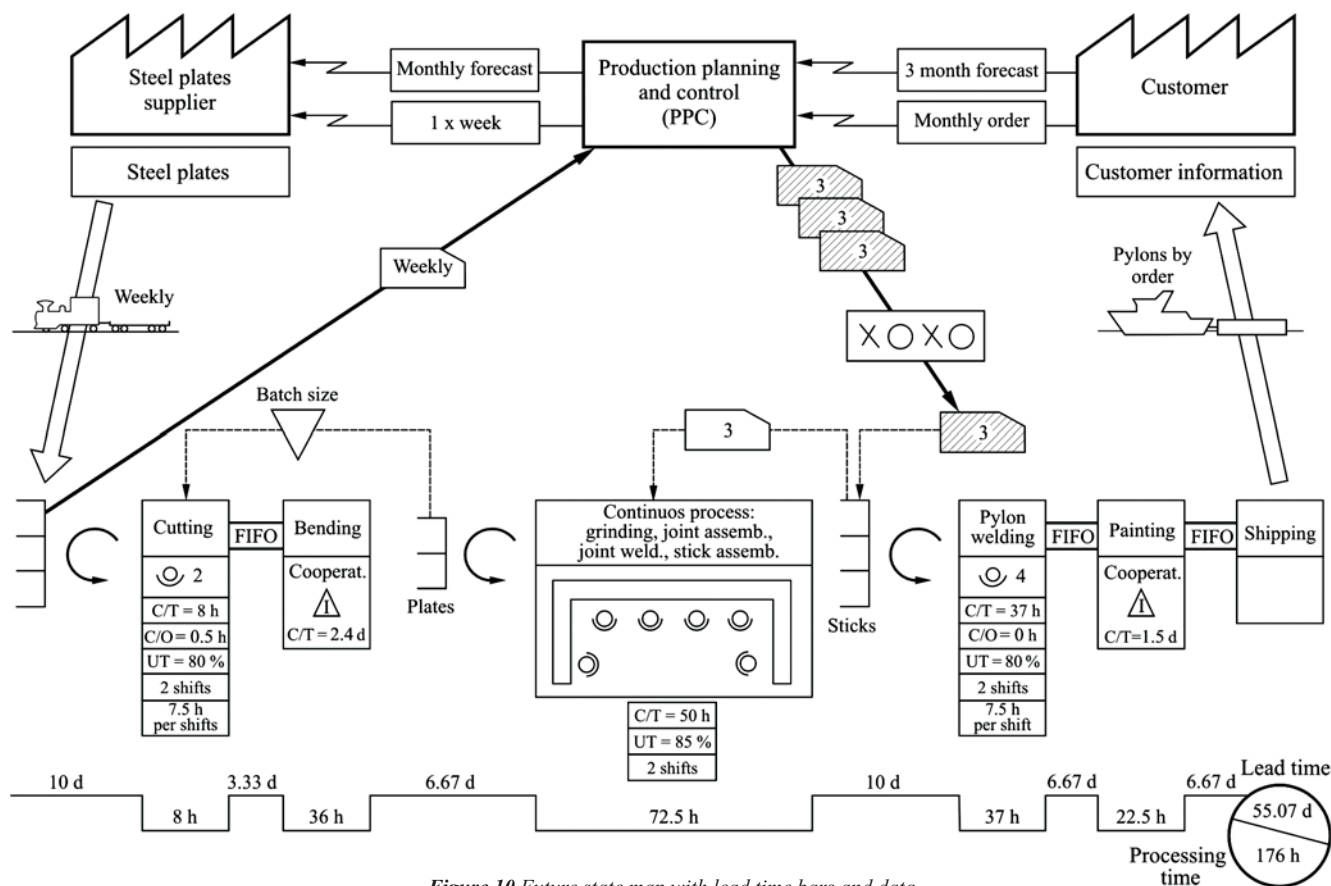

Figure 10 Future state map with lead time bars and data  
Slika 10. Mapa budućeg stanja s podacima o vremenu ciklusa proizvodnje

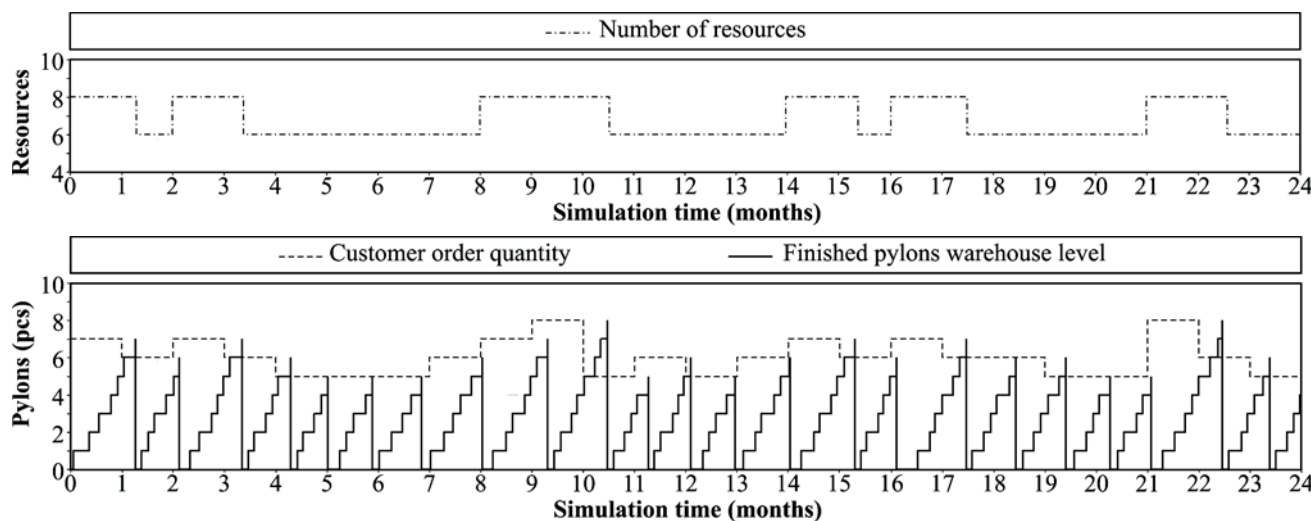

Figure 11 Future state workers assignments, varying orders and number of pylons in warehouse  
Slika 11. Broj resursa, variranje količine narudžbe i broj završenih pilona u skladištu u budućem stanju

In Fig. 12 the processes' status is shown. It can be seen in Fig. 12 that both the continuous process and the pylon assembly almost become bottlenecks at the same time. Future improvement in production output speed can be achieved only by reduction of cycle time in both processes. For continuous process it can be easily done by assignment of one more worker. For pylon assembly process, solution for cycle time reduction can be achieved by affiliation in already arranged continuous process.

#### 4 Current and future state results comparison Usporedba rezultata trenutnog i budućeg stanja

At the end of the simulation total number of pylons produced, and number of plates, sticks and pylons in the production process can be shown for both current and future state.

Comparing the results of the current and the future state leads to the data in terms of improvements in pylon production (Tab. 1). There was no excessive production and fulfilling of local storages in the future state, as was the case in the current state of pylon production. The

**Table 1** Simulation results of current and future state  
**Tablica 1.** Rezultati simulacije trenutnog i budućeg stanja

|               | Lead time days | Shipped pylons | Pylons in process | Average shipping delay time months | Last shipping delay time months | Resources used |
|---------------|----------------|----------------|-------------------|------------------------------------|---------------------------------|----------------|
| Current state | 123,38         | 126            | 49                | 1,69                               | 3,7                             | 16             |
| Future state  | 57,16          | 140            | 18                | 0,23                               | 0,67                            | 12/14          |

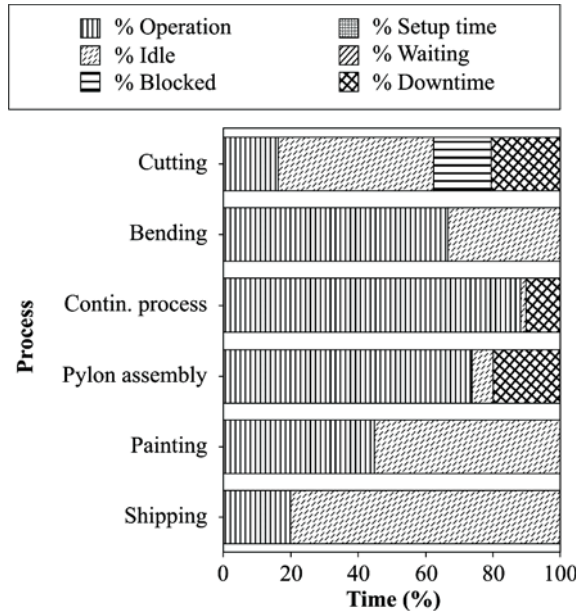

**Figure 12** Future state processes statuses  
**Slika 12.** Statusi procesa mape budućeg stanja

introduction of continuous flow at a new location no longer requires local storages between processes, and thus eliminates storage of large number of pylons between processes.

## 5

### Conclusion Zaključak

Lean concept has a powerful set of tools, methods and principles that when adopted can achieve superior organizational-management and also financial results. Its implementation principles must be applied in the whole industrial system to get more significantly the effects in work units and effective production systems.

Application of simulation software resulted in the inspection of defects and potential problems in pylon production. From the pylon production simulation results of the future state, it can be determined that overall production time and local inventory levels are significantly reduced in comparison to current state. It is achieved by applying the Lean production tools like production according to tact time and implementation of continuous flow optimization at a new location. In the future state, production process is managed to avoid the cases of shipment delay time, significant in the current state simulation. This leads to the increase in the net profit of the company by reducing overtime expenses, penalty costs, thus increasing the company's reliability and respectability in the field of special facility production.

Now, planning how and when to implement the Lean production on the shop floor is the next obligatory step for achieving a more effective production system.

## 6.

### References

#### Literatura

- [1] Chen, J. C.; Li, Y.; Shady, B. D. From value stream mapping toward a lean/sigma continuous improvement process: an industrial case study. // International Journal of Production Research, 48, 4(2010), p. 1069-1086.
- [2] Singh, B.; Garg, S. K.; Sharma, S. K. Value stream mapping: literature review and implications for Indian industry. // International Journal of Advanced Manufacturing Technology, 53, 5-8(2011), p. 799-809.
- [3] Womack, J. P.; Jones, D. T.; Roos, D. The Machine that Changes the World: The Story of Lean production. Harper Collins Publishers, New York, 1990.
- [4] Rother, M.; Shook, J. Learning to see: value stream mapping to create value and eliminate mud. The Lean Enterprise Institute, Cambridge Massachusetts, 2003.
- [5] Fandino Pita, J.; Wang, Q. A simulation approach to facilitate manufacturing system design. // International Journal of Simulation Modelling, 9, 3(2010), p. 152-164.
- [6] Stefanic, N.; Gjeldum, N.; Mikac, T. Lean concept application in production business. // Tehnicki Vjesnik - Technical Gazette, 17, 3(2010), p. 353-356.
- [7] Liker, J. K. The Toyota way 14 management principles from the world's greatest manufacturer. McGraw-Hill, New York, 2004.
- [8] Mittelhuber, B.; Kallmeyer, O. Wertstrom-design - Ein Werkzeug des Toyota - Produktion - Systems. Fraunhofer - Institut fuer Produktions-technik und Automatisierung (IPA), Stuttgart, 2002.
- [9] Stefanic, N.; Tosanovic, N.; Cala, I. Applying the Lean System in the Process Industry. // Strojarstvo: Journal for Theory and Application in Mechanical Engineering, 52, 1(2010), p. 59-67.

#### Author's addresses

Adrese autora

#### Nikola Gjeldum

University of Split  
Faculty of Electrical Engineering, Mechanical Engineering and Naval Architecture  
R. Boskovicica 32, 21000 Split  
Croatia  
Tel.: +385 21 305 934  
E-mail: nikola.gjeldum@fesb.hr

#### Ivica Veža

University of Split  
Faculty of Electrical Engineering, Mechanical Engineering and Naval Architecture  
R. Boskovicica 32, 21000 Split  
Croatia

#### Boženko Bilić

University of Split  
Faculty of Electrical Engineering, Mechanical Engineering and Naval Architecture  
R. Boskovicica 32, 21000 Split  
Croatia