

Title	Simulation of Resistance Welding for Selection of Optimum Welding Conditions and Process Control(Mechanics, Strength & Structure Design, INTERNATIONAL SYMPOSIUM OF JWRI 30TH ANNIVERSARY)
Author(s)	Murakawa, Hidekazu
Citation	Transactions of JWRI. 32(1) P.215-P.218
Issue Date	2003-07
Text Version	publisher
URL	http://hdl.handle.net/11094/11205
DOI	
rights	本文データはCiNiiから複製したものである
Note	

Osaka University Knowledge Archive : OUKA

<https://ir.library.osaka-u.ac.jp/>

Osaka University

Simulation of Resistance Welding for Selection of Optimum Welding Conditions and Process Control †

MURAKAWA Hidekazu*

Abstract

Weldability, or the formation of the sound nugget is influenced by various factors, such as electric current, electrode force, welding speed, shape of electrode tip and initial gap between work pieces. This makes it difficult to select the appropriate welding conditions and to control them dynamically during welding. To solve such problems, finite element methods are developed for numerical simulations of resistance spot welding and seam welding. The usefulness of the proposed methods is demonstrated through examples.

KEY WORDS: (Resistance Welding) (Finite Element Method) (Simulation) (Nugget Formation) (Weldability) (Welding Condition) (Pulsed Current)

1. Introduction

The welding conditions are selected to produce sound nuggets without the expulsion. However, the parameters influential to the welding process, such as the welding current, thickness of the work and the wear of the electrode tip, always involve variations. If the weldability lobe is wide enough, relatively small variations in these parameters can be accepted within the tolerance. However, if the variations exceed certain limits, sound welding cannot be achieved by the prefixed welding conditions. Dynamic or real time control based on the monitoring¹⁾ can be an effective way of solving this problem. To design such control systems, the following questions need to be answered.

- (1) How the variation of the parameter influences the phenomena?
- (2) What kind of physical value should be monitored?
- (3) How the welding process can be controlled?

To obtain an answer to the first question, for example, large numbers of experiments must be conducted. Also, it may be necessary to install a new measuring system for the development of innovative monitoring. If the development of the controlling system is carried out entirely based on physical experiments, large investments and long time periods are required. On the

other hand, the demand for the investment and time can be saved if a cyber laboratory, where it costs almost nothing to build a new apparatus, can conduct thousands of experiments over a week or so, is employed.

In this report, a finite element method (FEM)^{2,3)}, which can be considered as an example of a cyber laboratory, is proposed for resistance spot welding and resistance seam welding. Their usefulness is demonstrated through some examples.

2. Resistance Spot Welding

2.1 Procedure of analysis and model to analyze

The simulation of the resistance welding consists of three analyses, namely the electric field analysis, the thermal conduction analysis and the deformation analysis. These three analyses are cyclically repeated with a small time increment until the welding is

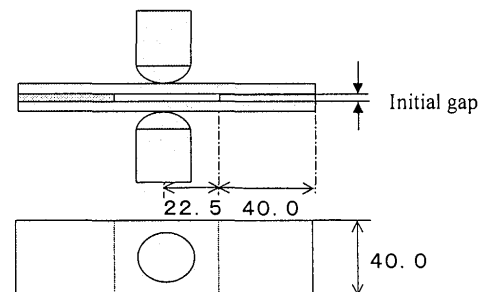

Fig.1 Spot welding model for analysis.

† Received on January 31, 2003

* Professor

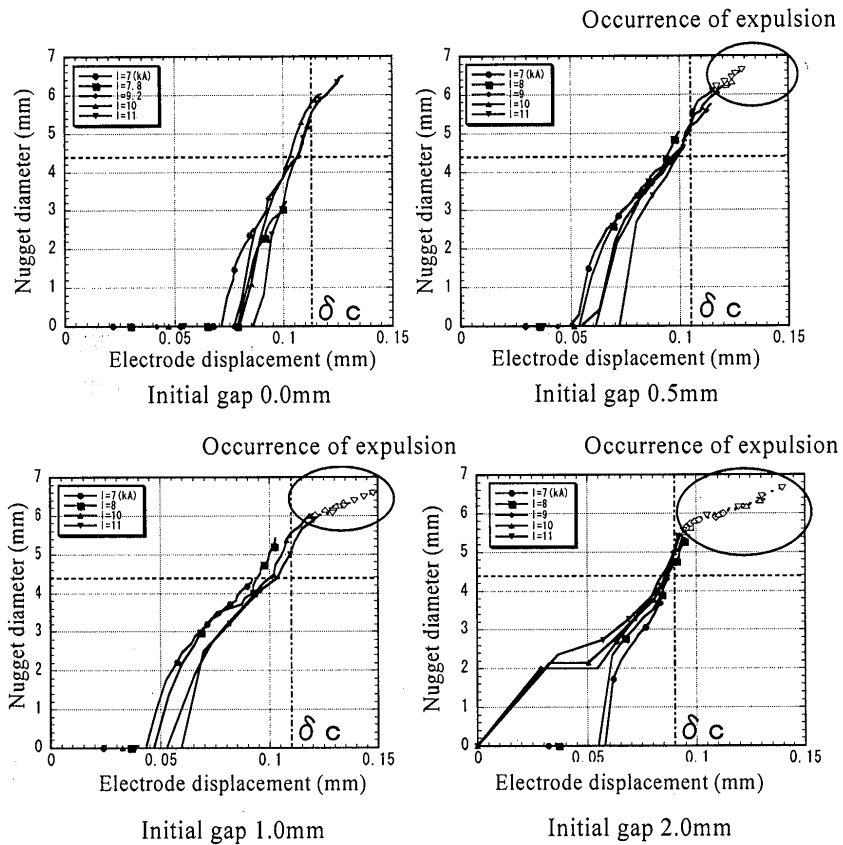

Fig.2 Correlation among electrode displacement, nugget formation and expulsion.

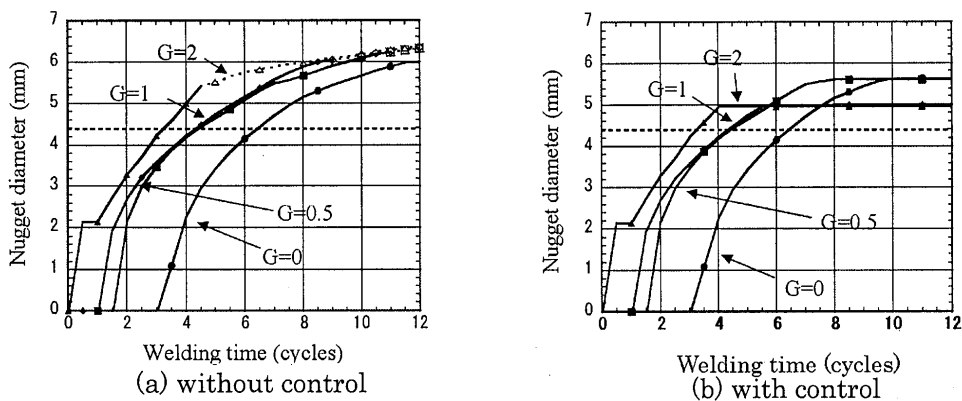

Fig.3 Effectiveness of welding current control using electrode displacement.

completed. Figure 1 shows the spot welding model with initial gap.

2.2 Influence of initial gap on formation of nugget and expulsion

The expulsion occurs when the nugget diameter exceeds that of the contact area between the work pieces. However it is practically impossible to measure them during the welding process. To control the welding process, monitoring an alternative measurable physical

quantity is necessary. In this report, the displacement at the electrode tip is selected as one of the candidates for effective monitoring and serial computations are conducted using FEM. The computed results are summarized in Fig.2. It shows a clear relation between the nugget diameter and the electrode displacement regardless of the value of the current. It is also seen that the expulsion occurs when the electrode displacement exceeds certain critical values δ_c which change with the magnitude of initial gap G .

	continuous	2-on/1-off	1-on/1-off
3.6 kA			
3.8 kA			
4.0 kA			
4.2 kA			
4.4 kA			

Welding speed: 1,500 mm/min Electrode force: 1,500 N

Fig.5 Influence of current mode on nugget formation.

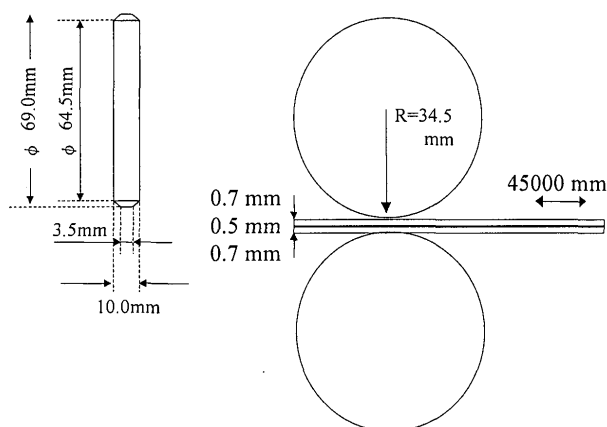

Fig.4 Spot welding specimen.

2.3 Controlling welding current using electrode displacement

By introducing the relation between the critical electrode displacement δ_c and the initial gap G , which is measurable in the process, the welding current can be controlled. Figure 3 shows the comparison between the formations of nugget without and with current control. The effectiveness of the control is clearly seen from the figure.

3. Resistance Seam Welding

3.1 Model to analyze

The model analyzed by the proposed method is illustrated in Fig.4.

3.2 Influence of current mode

Figure 5 shows the influence of the mode and the magnitude of the current on the formation of the nugget^{4,5,6}. Three types of current modes, namely continuous AC, 2-cycle on / 1-cycle off and 1-cycle on / 1-cycle off modes are compared. Before the computation,

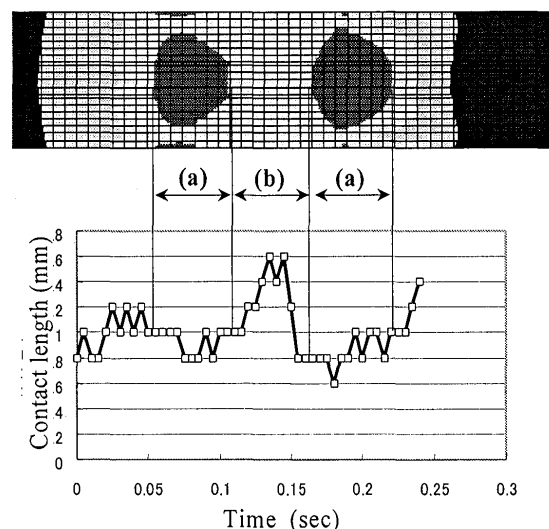

Fig.6 Relation between contact length and nugget formation (continuous AC).

a fairly uniform and continuous nugget is expected to be formed in the analysis. However, the computed results show that the formation of the nugget is not stable. Fluctuation, with a relatively long period is observed in the nugget formation and the continuous nugget is not formed. This phenomenon is closely related to the contact state between electrode / work and work / work. The case of continuous AC is closely examined in Fig.6. The highest temperature distribution and the time history of the contact length between the electrode and the work are shown. The abscissas of the two figures in Fig.6 are adjusted so that the time corresponds to the location of the electrode at that moment. It is clearly seen that the nugget is formed when the contact length is small and heat generation is large due to the current concentration. As the nugget grows, the work becomes soft and the contact length increases. This results in a reduction of

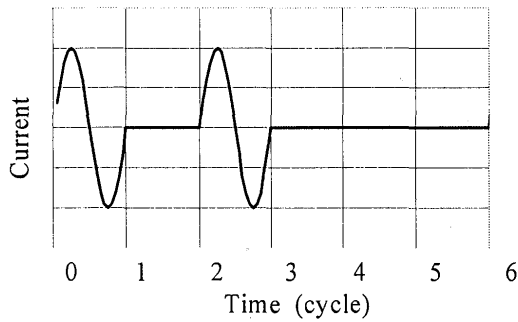

Fig.7 Modified current mode for enhanced cooling by electrode.

the current density and the heat generation. With the temperature drop, the nugget disappears. When the work is cooled and the electrode moves to the unheated part of the work, the contact length becomes small again and the same process is repeated with roughly a 0.1 second period.

3.3 Optimization of current mode

The computed results tell us that sufficient cooling of the nugget during the current off period is important to suppress the fluctuation in the nugget formation and to achieve a sound continuous nugget. To enhance the cooling, the current mode with a longer off period as shown by Fig.7 is employed in the computation. Figure 8 shows its effectiveness to produce a continuous nugget.

4. Conclusions

Numerical simulation is useful to understand the phenomena in resistance welding. It is especially effective for clarifying the influence of various factors on nugget formation and to propose ideas for control or optimization of the process. Through the examples presented in this report, the following conclusions are drawn.

- (1) The formation of the nugget and the occurrence of the expulsion are closely related to the electrode displacement. The relationship among the electrode displacement, the nugget size and the occurrence of expulsion is influenced by the size of the initial gap. But the effect of the welding current is small.
- (2) The welding current can be controlled using the critical electrode displacement δ_c as a threshold.

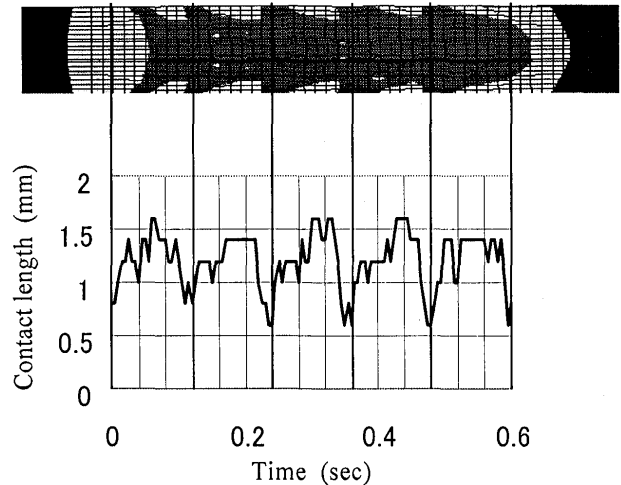

Fig.8 Relation between contact length and nugget formation (modified pulsed current).

- (3) When continuous AC is used in seam welding, instability with a long period is observed in nugget formation. This phenomenon is attributed to the unstable contact state.
- (4) Pulsed current with a sufficiently long current off period is effective to produce a continuous nugget in a stable manner.

References

- 1) C.L. Tsai, W.L. Dai, D.W. Dickinson and J.C. Papritan, "Analysis and Development of a Real-Time Control Methodology in Resistance Spot Welding", Welding Research Supplement, Dec. 1991, pp. 339-351.
- 2) H. Murakawa, H. Kimura and Y. Ueda, "Weldability Analysis of Spot Welding on Aluminum Using FEM", Trans. JWRI, Vol. 24, No. 1, 1995, pp.101-111.
- 3) H. Murakawa, J. Zhang and H. Minami: FEM Simulation of Spot Welding Process (Report III) -Controlling of Welding Current Using Electrode Displacement for Formation of Large Enough Nugget without Expulsion-, Trans. JWRI, Vol. 28 (1999), No. 1, pp.41-46.
- 4) N. Shimizu, T. Hayashida, N. Nishimoto, J. Fukai and O. Miyatake: Relation between Equivalent Contact Resistance and Resistance Seam Weldability for Beverage Cans, Iron & Steel, Vol.84 (1998), No.4, pp.249-254.
- 5) J. Fukui, S. Baba, Y. Toyomasu, O. Miyatake, N. Shimizu, N. Nishimoto and T. Hayashida: Effect of Electric Current Path Area on Resistance Seam Weldability, Iron & Steel, Vol.84 (1998), No.6, pp.429-434.
- 6) H. Murakawa, H. Minami and T. Kato: Finite Element Simulation of Seam Welding Process, Trans. JWRI, Vol. 30 (2001), No. 1, pp.111-117.