

Single pressure transducer probe for 3D flow measurements

Joel Schlienger*, Axel Pfau†, Anestis I. Kalfas‡, Reza S. Abhari§

ETH, Turbomachinery Laboratory, Sonneggstrasse 3, Zurich, Switzerland

Abstract. A new method of measuring 3D flow with a single pressure transducer mounted inside the head of a single probe is presented in this paper. The 3D flow field around the hemispherical or ellipsoidal probe head is used to derive the 3D flow vector in virtual 5-sensor mode. A pressure tap located in the vicinity of the probe head connects the instantaneous pressure of the measurement volume to the pressure transducer. By turning the probe to five different positions around the axis of the stem, a set of five pressures is formed. The relevant flow parameters such as total and static pressure, yaw and pitch angle as well as Mach number are derived from these five pressures using the proposed calibration model. A selection of six different probe head geometries with different pressure tap positions have been manufactured and calibrated in a free jet facility in order to find the ideal probe geometry. The results of the steady probe calibration showed that the probe captures 3D flow at a slightly higher error band compared to other probe techniques such as pneumatic multiple hole probes. A summary of the achieved model accuracy for each probe is given. Finally, the calibration model can be extended to any single sensor cylindrical probe, provided that the pressure coefficient shows a measurable variation with pitch angle.

Nomenclature

C_{pt}	Total Pressure Coefficient
P_i	Measured Pressure ($i=1\dots5$)
Θ_i	Probe Yaw Angle ($i=1\dots5$)
P_k	Peak Pressure
α	Flow Yaw Angle
β	Flow Pitch Angle
γ	Pressure Tap Inclination Angle
P_o	Total Pressure
P_s	Static Pressure
Ma	Mach Number
Re	Reynolds Number
K_α	Yaw Angle Coefficient
K_β	Pitch Angle Coefficient
K_t	Total pressure Coefficient
K_s	Static Pressure Coefficient
K_{ijk}	Coefficient of Polynomial Interpolation
m,n	Order of Interpolation Polynomial

Introduction

Flow in axial and radial turbomachines involves various levels of flow pitch angles. The third component of the flow vector becomes a dominant term for the evaluation of total pressure and flow velocity, in particular for low aspect ratio blades. In consequence, the estimation of total and static pressure as well as Mach number is biased by the third dimension. The experimental set-up for fast response probe measurements requires a certain degree of sophistication in addition to high level of engineering skills required for the manufacturing of multiple sensor probes [1-2].

As an alternative, experimentalists often resort to single sensor probes for 3D flow measurement. An alternative technique using a pair of geometrically identical probes is reported in literature [3]. In this case, both probes use a single sensor mounted inside the probe tip. The only difference is in the location of the pressure tap at the tip of the probe. The 3D flow vector is derived from the superposition of four pressure measurements referred to as virtual 4-sensor (V4S) mode. In this mode,

* Joel Schlienger: joel.schlienger@swissonline.ch

† Axel Pfau: Axel.Pfau@flowtec.endress.com

‡ Anestis I. Kalfas: akalfas@auth.gr

§ Reza S. Abhari: abhari@lec.mavt.ethz.ch

one of the probes (nonsensitive to pitch angle variations) is used to measure the pressures at three predefined angular positions around its axis. The second probe is used to provide the fourth pressure measurement from a pitch sensitive surface, to complete the data set. Finally, a calibration model relates the four pressures measurements to the unknown flow parameters.

Measuring 3D flow with a single probe could alleviate the complexity associated with the above technique. Obviously, the measurement of a fourth pressure is not possible since there is only one pressure tap available. This paper proposes a new calibration model to derive the 3D flow vector using only a single sensor probe and five consecutive pressure measurements in virtual 5sensor (V5S) mode. Two additional pressure measurements are required to replace the missing pressure tap of the second probe.

The 3D flow field around the probe tip depends on the probe geometry and the pitch angle. The potential flow field changes with pitch angle and therefore the pressure distribution on the surface of the probe head. These changes are registered in the five pressure measurements and the third component of the flow vector is derived using a novel definition of the pitch angle coefficient.

Tanaka et al. [4] presented a systematic evaluation of the pitch sensitivity for different probe heads and the highest pitch sensitive head was discussed. The 3D flow around the probes was measured in a large-scale experiment to study the pressure field on the head surface that a single pressure tap would potentially see if exposed to the flow.

In the following experiment, a commercial pressure transducer is mounted in the cylindrical shaft of a probe with an ellipsoidal or hemispherical head. The pressure tap that connects the transducer to the outer flow is drilled at a given point on the shaped probe head. The potential flow around the tip relative to the pressure tap is asymmetric in pitch angle and symmetric in yaw. This characteristic of the flow field is used to derive the full flow vector.

The first section of the paper addresses the pitch sensitivity of this probe design with a flow visualization experiment in a water channel. A further section presents the calibration model for this kind of probes and describes the introduced pitch angle coefficient aiming to capture the pitch sensitivity of the probe using the five pressures.

A set of six different miniature probes with different head characteristics was manufactured and calibrated according to the presented calibration model. In the final section of the paper, the calibration results for all probes are listed and discussed. Also, the calibration curves for the selected probe are presented.

1 Visualisation of the streamlines around the shaped probe head

The 3D flow around the tip of the shaped probe is visualized in a water channel as shown in Fig. 1. The streamlines around the probe head are coloured by ink injection upstream of the large scaled model. The diameter of the body is 20 mm and the ellipse has an

aspect ratio of 2:1. The experiment is performed at a subcritical Reynolds number of $1.2 \cdot 10^4$. As seen in Fig. 1 the streamlines are deviated by the potential field caused by the probe body. A vortex is formed at the back of the probe at a large negative pitch angle. This effect is not apparent for positive pitch angles.

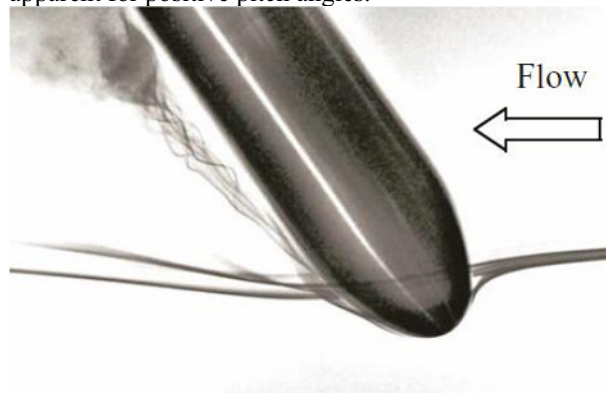

Fig. 1. Streamlines at Negative Pitch Angle

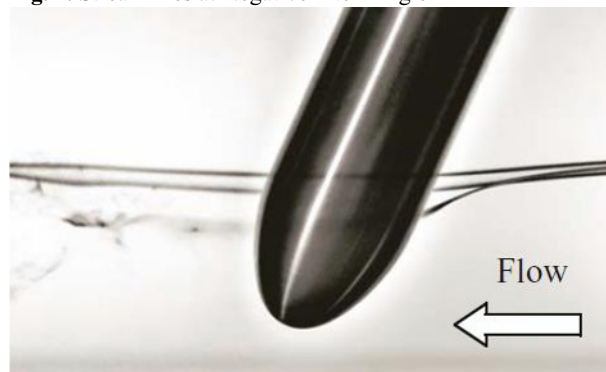

Fig. 2. Streamlines at Positive Pitch Angle

The incoming streamlines are stopped at the saddle point that is formed in front of the probe as seen in Fig. 1. This effect leads to an increase of surface static pressure on the shaped probe head and could be captured by a pressure tap. The registered pressure is close to the free stream total pressure. The pressure distribution along the circumference of the head at a given axial position is varying with pitch angle. This characteristic is strongly yaw sensitive going from low to high and back to low pressure with a change of probe yaw angle.

In Fig. 2 the other extreme case is shown. The saddle point has disappeared and a strong down wash of the streamlines is observed. The corresponding pressure distribution reduces and the pitch sensitivity increases. The yaw sensitivity of this set-up is low since the surface pressure tends to be uniform with respect to probe yaw angle.

The described pressure field on the surface of this shaped probe head can be evaluated appropriately in order to define an effective pitch angle coefficient.

2 Calibration model

The proposed calibration model involves five consecutive pressures acquired at five different probe angles in virtual 5-sensor mode. In this mode, the probe is kept at a fixed position on the measurement grid and the pressure tap is turned to five predefined probe angles Θ_1 to Θ_5 , (Fig. 3).

The pressures are used to define the yaw and pitch angle calibration coefficients K_α and K_β , as well as total and static pressure coefficients K_t and K_s .

These four coefficients are used to derive the unknown flow defined by the yaw angle α , the pitch angle β , the total and static pressures P^o and P_s and the isentropic Mach number Ma .

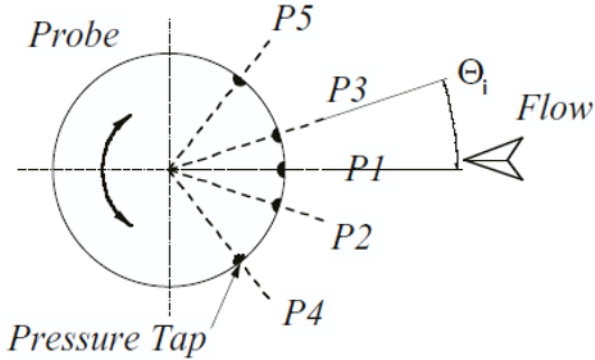

Fig. 3. Virtual 5-Sensor Mode

The ideal probe angles Θ_1 to Θ_5 , at which the different pressures P_1 to P_5 are acquired, need to be found empirically. They depend on the probe head geometry and calibration model used. The determination of Θ_1 to Θ_5 is achieved through an optimisation procedure based on the standard deviations of the computed flow parameters relative to the predefined calibration set-up conditions of the free jet facility.

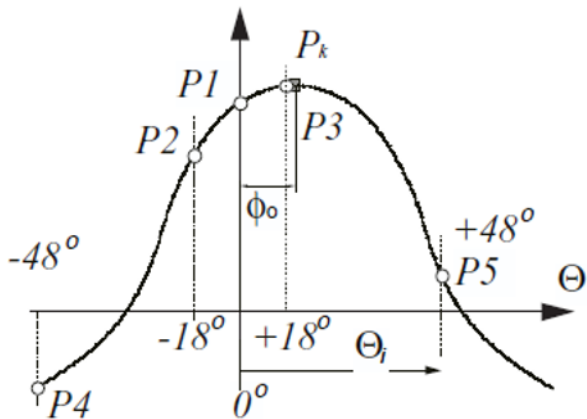

Fig. 4. Peak Pressure definition P_k (b)

The five measured pressures P_1 to P_5 are plotted relative to their corresponding probe angle Θ_i , as seen in Fig. 4. An interpolation curve of 4th degree is fitted to the data set to find the peak pressure P_k that corresponds to the maximum pressure that the probe would register for a given flow position. The peak pressure P_k is found at an angle ϕ_0 for an unknown pitch angle β . The angle ϕ_0 is similar to the unknown flow angle α but not accurate enough to be used in the calibration model. The estimation of the yaw or pitch angles must always be a function of yaw and pitch angle coefficients K_α and K_β for best calibration model accuracy. The definition for K_α is given using the peak pressure P_k for the 0° probe yaw angle rather than P_1 , which is conventionally used [5]. The computation of the peak pressure P_k is adaptive to the actual pressure set (P_1 to P_5) and the resulting value is less sensitive (more constant) to a change of yaw angle compared to the single pressure P_1 . Therefore, the

substitution of P_1 by P_k smoothens the calibration coefficients in eq. (1) and (2). As a result, the standard deviation for the derived flow pitch angle β is reduced by a factor of 2, leaving the accuracy of the yaw angle α unaffected.

The proposed pitch angle coefficient given in eq. (2), makes use of the five pressures to define a ratio between the dynamic head of the flow close to the leading edge of the probe and the one formed with the static pressure at the side of the probe head. A change of pitch angle affects this ratio since the flow is facing a different projected surface of the probe head. The ideal head for enhanced pitch angle sensitivity would involve a pronounced change of the projected area relative to the flow under consideration. It is suggested that further developments on the 3D head shapes should be considered in this light.

$$K_\alpha = \frac{P_4 - P_5}{P_k - \frac{P_4 + P_5}{2}} \quad (1)$$

$$K_\beta = \frac{P_k - \frac{P_4 + P_5}{2}}{P_k - \frac{P_2 + P_3}{2}} \quad (2)$$

The pressure tap of this probe can not be physically pitched to get the fourth pressure, as usual for 4 hole probes. As a result, the change of yaw angle coefficient (eq. 1) is larger for a given variation of yaw angle α , than the equivalent change for the pitch angle coefficient (eq. 2) for a variation of pitch angle β . The error band for the computation of yaw angle α is reduced compared with the pitch angle computation.

The calibration coefficients for total and static pressures are defined according to the flow angle coefficients as functions of the acquired pressures from the probe and the free jet calibration set-up data (eq. 3 and 4).

$$K_t = \frac{P^o - P_1}{P_1 - \frac{P_4 + P_5}{2}} \quad (3)$$

$$K_s = \frac{P^o - P_s}{P_1 - \frac{P_4 + P_5}{2}} \quad (4)$$

The relation between the flow angles α, β and flow angle coefficients K_α, K_β and the measured five pressures P_1 to P_5 are taken from a direct parametric model proposed by Bohn and Simon [6] (eq.5). Similarly, the total and static pressure coefficients K_t, K_s are obtained by these formulae.

$$\alpha = \sum_{i=0}^n \sum_{j=0}^m k_{ij\alpha} K_\alpha^i K_\beta^j$$

$$\beta = \sum_{i=0}^n \sum_{j=0}^m k_{ij\beta} K_\alpha^i K_\beta^j \quad (5)$$

$$K_t = \sum_{i=0}^n \sum_{j=0}^m k_{ijt} \alpha^i \beta^j$$

$$K_s = \sum_{i=0}^n \sum_{j=0}^m k_{ijs} \alpha^i \beta^j$$

The interpolation polynomial coefficients k_{ija} , $k_{ij\beta}$, $k_{ij\gamma}$ and k_{ijs} are derived from a least square approximation. The relevant data set is taken from the probe calibration in the freejet facility where the flow angles α and β as well as total and static pressure is known from the facility setup. The 2D interpolation polynomial is set to 6th order for both m and n in order to achieve an accurate calibration model. This model should be applied carefully as high polynomial order can induce oscillations of the interpolation surface for certain calibration ranges.

3 Probe design

The validation of the proposed calibration model is achieved by manufacturing a set of six different miniature probes (Table 1). All of the probes were calibrated in the freejet facility for various inclination angles (α, β) at a constant Ma number. Through systematic parametric variation of head geometry and pressure tap position on the probe tip (inclination angle γ), a most appropriate probe configuration was established. This probe was then used for flow measurements in a 2 stage axial turbine.

Table 1. Selected Probe Head Geometry with different Pressure Tap Angles γ

Probe Head	Tap Angle γ
Ellipse 2:1	0°
Ellipse 2:1	8°
Ellipse 2:1	15°
Ellipse 2:1	25°
Hemisphere	0°
Hemisphere	30°

A miniature pressure transducer of 34.5 kPa (5 PSI) range and 125 mV Full Scale Sensitivity was embedded into a cylindrical probe shaft with outer diameter of 1.8 mm as shown in Fig. 5. The pressure tap connecting the instantaneous pressure of the measurement volume to the covered pressure transducer was drilled at a given inclination angle γ , as listed in Table 1. The inner tap diameter was 0.3 mm. The values for γ are chosen in the range of 0° to 30°. The ideal position of the tap will result from the probe calibration procedure. A possible reduction of yaw sensitivity due to the down wash of the flow around the probe head for larger tap angles (Fig. 2), is avoided through systematic optimisation of the tap position. Moving the pressure tap away from the probe tip makes the pressure measurements less sensitive to changes of pitch angle and therefore difficult to handle with the proposed calibration model. On the other hand, locating the tap at the tangent point (inclination angle $\gamma=0^\circ$) keeps the tap close to the 3D flow field at the probe tip. At the same time, the measurement is affected only little by the down wash at positive flow pitch angles.

The manufacturing of the six probes has been relatively simple. This measurement technology can be used very effectively to measure unsteady flows at low

blade passing frequencies (<2 kHz) as it is common in most low speed turbomachinery research facilities.

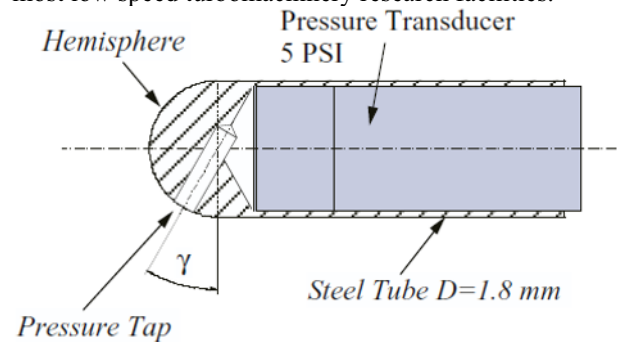

Fig. 5. Miniature Hemispherical Probe

The simple design of the probes leads to larger cavities in the probe head between pressure tap and transducer membrane. Consequently, the resonance frequency of the cavity reduces down to 13 kHz. Barigozzi et. al. [7] considered a similar probe design with cylindrical probe head. The reported cavity resonance frequency was 12 kHz.

4 Pitch sensitivity of probe head

The flow visualization experiments have demonstrated the variation of the flow field around the given probe head, for various pitch angles. The ideal shape of a pitch sensitive probe head and the most appropriate position of the pressure tap have been carefully considered. All geometries are cylindrical and symmetric with respect to the probe axis, in order to reduce dynamic effects caused by oscillating flows [4], often encountered in unsteady turbomachinery measurements.

The range of pitch angle is depicted in the two figures of the flow visualization experiment. The calibration range for pitch angle was set to +30°/16° whereas the yaw angle covers ±70°, for all probes. The probes are calibrated at a Mach number of 0.3 and flow temperature of 25°C leading to a Reynolds number of $1.2 \cdot 10^4$. The probe reading is expressed as a pressure coefficient C_{pt} , non-dimensionalised by the static and total pressure P^o and P_s of the freejet facility (eq. 6).

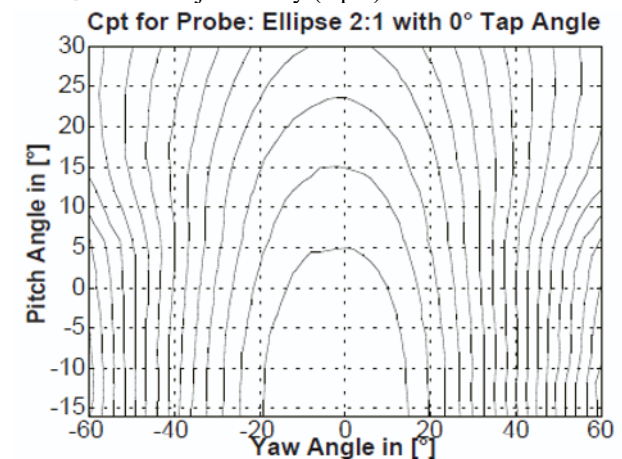

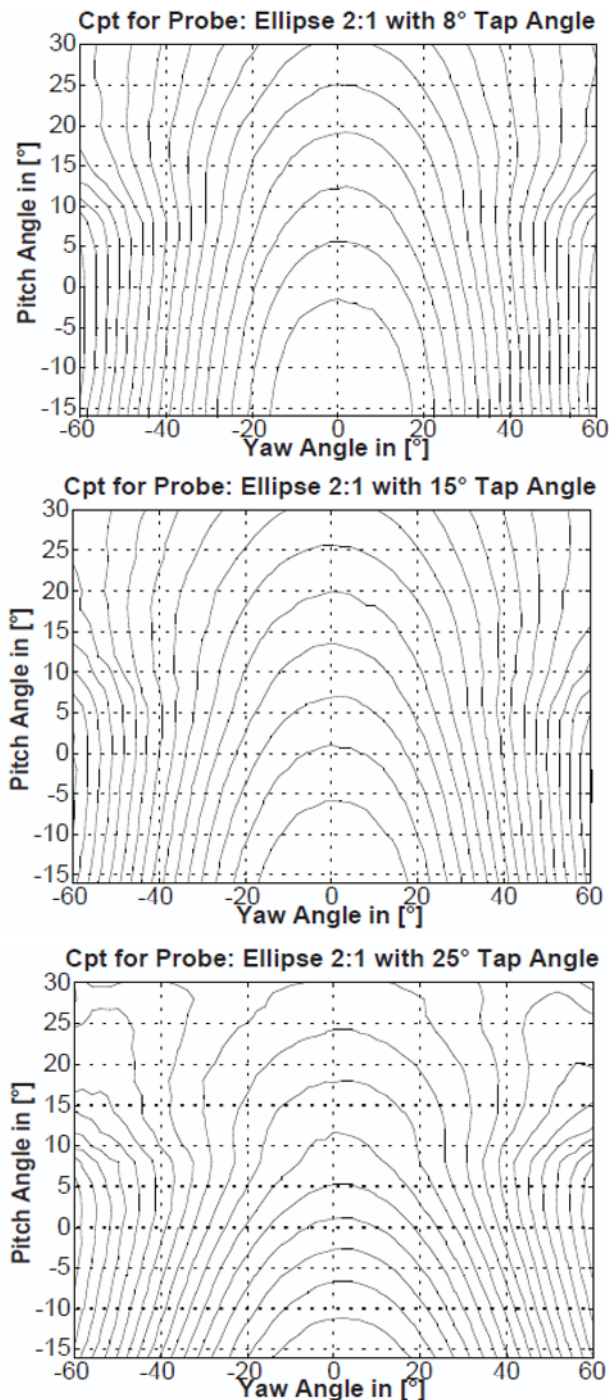

Fig. 6. C_{pt} Contours for Elliptical Probe 2:1 and Tap Angles ($0^\circ, 8^\circ, 15^\circ, 25^\circ$)

$$C_{pt} = \frac{P_{probe} - P_s}{P^o - P_s} \quad (6)$$

The absolute level of C_{pt} ranges for all contour plots between +1/-1.5. However, the level is not shown for the evaluation of the pitch sensitivity, since the C_{pt} gradient is the leading parameter for evaluating the probes.

A shaped probe with large tap angle (e.g. Elliptical Probe, 25°) is more affected by the down wash of the flow as seen in Fig. 2 for large positive pitch angles than a comparable probe with zero or small tap angle. The down wash reduces the yaw and pitch sensitivity of the probe for large positive pitch angles. In all cases, a region of low static pressure gradient for a variation of both yaw and

pitch angle was observed. The ranges of the flow angle calibration coefficient $K\alpha$ and $K\beta$ is considerably reduced for the cases with a large tap angle γ . The standard deviations of the calibration model for the computed flow angles and the subsequent pressures and Mach number are increased. This effect is apparent for the elliptical probe (25°) and the hemispherical probe (30°). The probes with 0° tap angles are therefore less affected by the down wash. As a result, improved calibration model accuracy is expected for these probes.

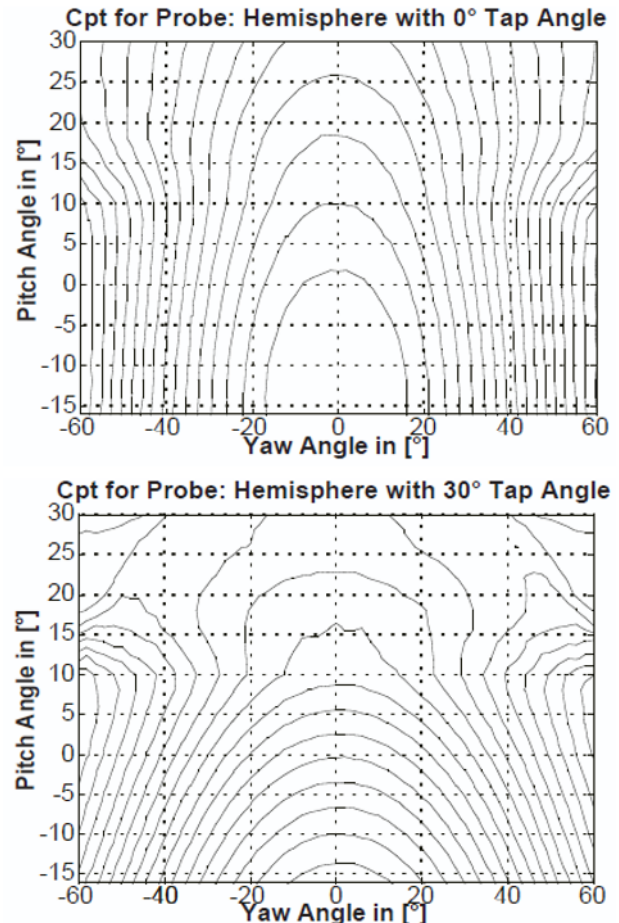

Fig. 7. C_{pt} Contours for Hemispherical Probe with Tap Angles ($0^\circ, 30^\circ$)

The ideal probe head is characterized by a high gradient in the pitchwise direction, nonparallel contour lines to the pitch angle axis and high yaw angle sensitivity of the pressure coefficient at positive pitch angles (reduced effect of the down wash).

As a consequence, the probes with large tap angles (25° and 30°) are not appropriate due to their low yaw angle sensitivity at positive pitch angles. The two cases with hemispherical and elliptical head and 0° relative tap angle are considered as the most suitable among the once considered here. The contour lines of the hemispherical probe (0°) shows a higher C_{pt} gradient in pitch wise direction for negative pitch angles than the elliptical probe head with 0° tap angle. Therefore, this head geometry performs better in terms of model accuracy. It is expected, that this probe will lead to the lowest standard deviations of the calibration model and qualifies for 3D flow measurements in a real turbomachinery flow environment.

The pronounced C_{pt} gradient at $+10^\circ$ pitch angle is remarkable for all calibrated probes. This effect occurs independently from the pressure tap position. It is, however, a function of the probe shaft and head geometry. This can be explained by the evolution of the stagnation point in the front face of the probe head (Fig. 1) into a stagnation line with a strong down wash effect (Fig. 2) as the pitch angle changes from negative to positive values.

5 Results of steady calibration

The calibration model described earlier is applied to all of the six probes and the results of the static calibration are presented. The pressure transducer is preloaded with 15 kPa of reference pressure in order to avoid the sensor being operated at alternating membrane deflections. The pressure transducer of the miniature probe is temperature compensated and therefore mainly depending on pressure rather than temperature changes. The eventual influence of the temperature on the accuracy of pressure measurement is neglected at this point, as the concept of a single sensor probe for 3D flow measurement is the primary focus, at a first step. Future work could also address this topic, which is expected to further increase the accuracy of the pressure measurement.

The calibration grid for the miniature probe is set to $\pm 70^\circ$ in yaw and $+30^\circ/-16^\circ$ in pitch angle, respectively. The step width is set to 2° in both directions. The probe calibration leads to a measurement set of approx. 1700 data points, out of which the virtual 5-sensor mode is assembled. Depending on the predefined probe yaw angles Θ_1 to Θ_5 and a given calibration range for yaw and pitch angles, the corresponding five pressures are picked from the data set and the calibration model is computed. A systematic parametric variation of the probe yaw angles is performed to reduce the standard deviation of the computed flow parameters, relative to the experimental set-up data. The probe yaw angles Θ_1 to Θ_5 identified in this fashion are identical for all six probes, independently of the chosen calibration range and pressure tap position. The resultant angles are given in Table 2.

Table 2. Virtual 5 Sensor Probe Setup Angles (for all Probes)

Probe Parameters	Angles
Θ_1	0°
Θ_2, Θ_3	$\pm 18^\circ$
Θ_4, Θ_5	$\pm 48^\circ$

The accuracy of the calibration model, for all six probes, is listed in Table 3 for a defined calibration range of $\pm 16^\circ$ in yaw angle and $\pm 10^\circ$ in pitch. The accuracy of the calibration model is quantified by the standard deviations σ of the computed parameters relative to the free jet set-up. The standard deviations of the flow angles α and β are evaluated in degrees. For the pressures P^o and P_s the error is expressed relative to the dynamic head in [%]. The isentropic Mach number M is derived from total and static pressure and error is given as absolute difference to the calibration Mach number.

Table 3. Standard Deviations for a Calibration Range of $\pm 16^\circ$ in Yaw and $\pm 10^\circ$ Pitch Angle

σ	α [°]	β [°]	P^o [%]	P_s [%]	M [%]
E21- 0°	0.14	1.2	1.7	0.5	0.9
E21- 8°	0.20	1.4	2.3	1.1	0.7
E21- 15°	0.40	1	2.7	0.9	1.2
E21- 25°	0.8	0.9	3.9	1.7	1.3
HS- 0°	0.10	1.1	1.5	0.7	0.5
HS- 30°	1.7	1.2	5.8	3.5	1.2

The ideal probe with the lowest standard deviation is effectively the hemispherical probe with 0° tap angle, as expected from the pitch sensitivity study in the previous section. Both 0° probes show comparable results with a minor difference in static pressure computation. The effect of the down wash on the accuracy for the large tap angle probes is apparent, reaching errors of total pressure of up to 5.8% relative to the dynamic head. However, those probes work well for large negative pitch angles (i.e. labyrinth leakage flows). For general applications within the main flow of an axial machine, where the pitch angles will vary between $\pm 10^\circ$, the HS- 0° probe should be used.

The presented calibration model reproduces the flow angle α at one order of magnitude (0.1) better accuracy than the pitch angle β (1.1). This difference in accuracy results from the shape of the calibration curve for the pitch angle coefficient $K\beta$ (see next section). The calibration error of 1.1° for the computation of pitch angle β and 0.10° for yaw angle α strongly affects the estimation of total and static pressure. Specifically, for high C_p gradients where any small pitch angle error results in a large total pressure error, a reduction of the calibration model accuracy has dramatic consequences. In this case, it is recommended to use a probe with moderate pitch angle sensitivity to limit the error of the total pressure computation. Furthermore, the accuracy of all subsequent values depending on the total pressure computation such as static pressure and Mach number will be enhanced.

5.1 Calibration Coefficient Curves for Hemispherical Probe Head with 0° Tap Angle

The calibration curves for the coefficients $K\alpha$, $K\beta$, K_t and K_s of the selected probe are shown in Fig. 8. The yaw angle coefficient shows a uniform increase with a change of yaw angle and is nearly decoupled from a variation of pitch angle. This behaviour is expected for the calibration coefficient $K\alpha$ in its present formulation. The calibration curves for the pitch angle depends on yaw as well as pitch angle. The errors of both flow angles coefficients are cumulated in the computation of pitch angle β , increasing inevitably the error band. The reduced sensitivity of this coefficient with respect to pitch angle and dependency on yaw angle is expected, since the definition of $K\beta$ uses a ratio of dynamic heads that also depends on yaw angle α . This parameter is less affected by a change of pitch angle than the same calibration coefficient formed with a fourth

pressure taken by a different pressure tap, common for multi hole probes. The pitch angle is captured within the correct range. Although this was proven to increase the accuracy of pressure calculation it is not adequate to be used for detailed flow studies, such as vorticity studies.

The total and static pressure coefficients are disturbed by the increased uncertainty of the computed flow angles, as depicted in the last two diagrams for K_t and K_s . The obtained accuracy for total and static pressure as given in Table 3 (1.5 and 0.7 %), are acceptable for detailed pressure measurements in the 3D flows. Using a less accurate pitch angle for the computation of the total pressure P^0 in virtual 5-sensor mode compensates the missing third flow vector component as opposed to pure 2D measurement techniques in virtual 3-sensor mode. (e.g. endwall or labyrinth leakage flow regions).

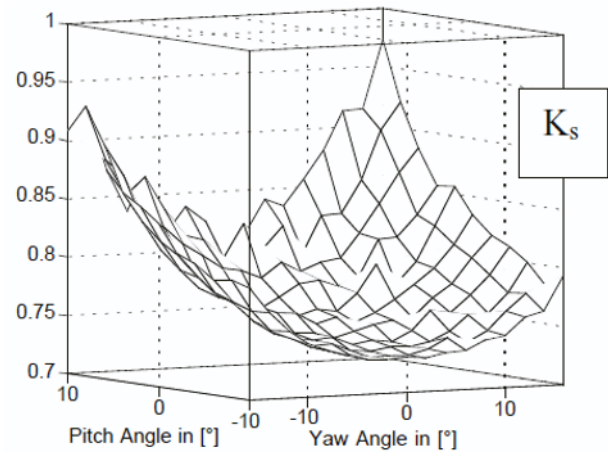
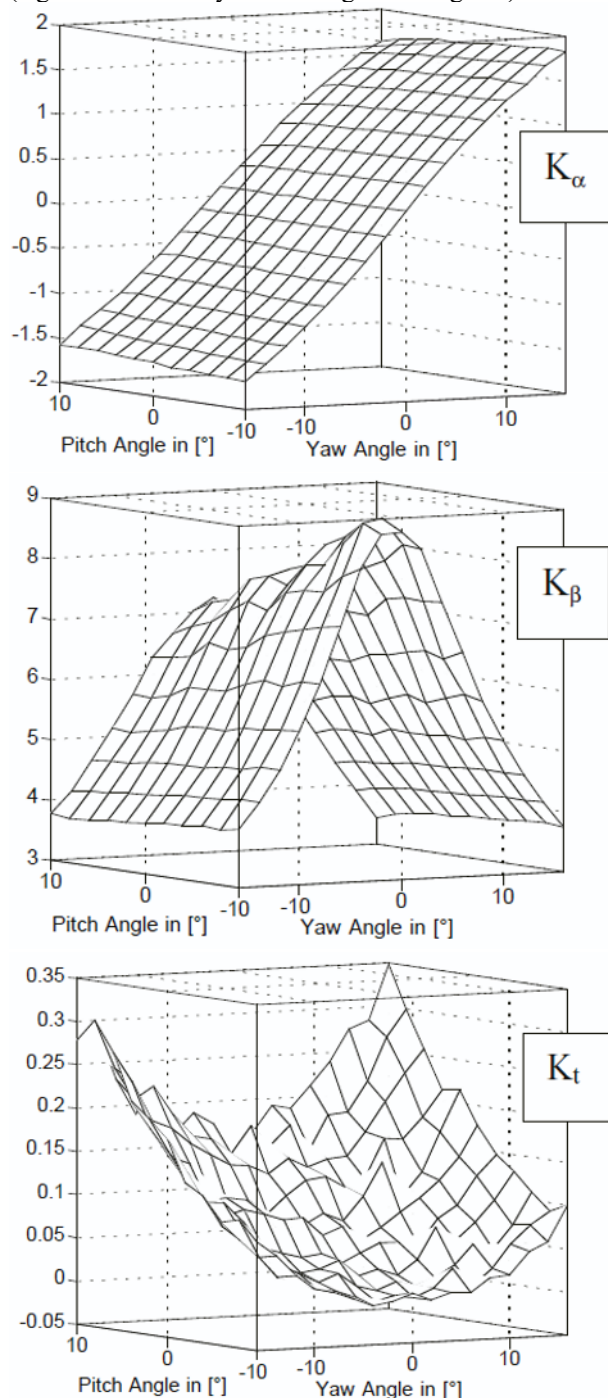

Fig. 8. Calibration Coefficients for Hemispherical Probe with 0° Tap Angle and Calibration Range of Yaw $\pm 16^\circ$, Pitch $\pm 10^\circ$

6 Conclusions

The proposed calibration model for a single probe with a single pressure transducer, to measure 3D flow in virtual 5-sensor mode is presented and validated with six different probes.

The calibration results showed that for a given probe head geometry the derived flow parameters are comparable to calibration results for multi-hole probes.

However, the model accuracy for the pitch angle is 3-4 times less than one would expect from a cylindrical multi-hole probe in the given calibration range. The derived pitch angle accuracy is acceptable for any main flow studies but needs improvement for reliable vorticity studies.

In any 3D flow regime, where large pitch angles are expected, the application of 2D probe techniques with a single sensor probe in virtual 3sensor mode, are restricted. Using the pitch angle estimation from a virtual 5-sensor mode provides the third component of the flow vector. Although the pitch angle computation is not particularly accurate, this mode of operation reduces the error in total and static pressure as well as Mach number measurement.

This proposed virtual 5-sensor mode technique could be applied to any probe that is originally used to measure 2D flow by altering the geometrical formation of the probe tip. In this case, probes need to be recalibrated for different pitch and yaw angles using the proposed calibration model.

7 Acknowledgments

The authors would like to express their gratitude to the technical support personnel, and in particular Mr. Lehner and Mr. Kuenzle of the Turbomachinery Laboratory for their excellent work in the manufacturing of the probes. We would also like to extend our thanks to Mr. Reshef for his help and advise in the numerous issues of Electronic Engineering that arose during the course of the probe development. The use of the water channel for the flow visualization and the kind support of Prof. Roesgen and Mr. Machacek of the Institute of Fluid Dynamics of ETH is gratefully acknowledged.

References

1. C. Gossweiler, *On Probes and Measuring Techniques for Fast-Response Flow Measurement Using Piezo-Resistive Pressure Transducers*, Dissertation ETH No. 10253, ETH Zurich, Switzerland (1993)
2. C. Gossweiler, *Unsteady Measurements with Fast Response Probes*, Von Karman Institute for Fluid Dynamics, Bruxelles, Lecture series (1996)
3. A. Pfau, J. Schlienger, A. I. Kalfas, R. S. Abhari, *Virtual Four Sensor Fast Response Aerodynamic Probe (FRAP)*, XVIth Symposium on Measuring Techniques in Transonic and Supersonic Flows in Cascades and Turbomachines, Cambridge, UK, September 23-24 (2002).
4. K. Tanaka, A. I. Kalfas, H. P. Hodson, *Development of Single Sensor Fast Response Pressure Probes*, XVth Symposium on Measuring Techniques in Transonic and Supersonic Flows in Cascades and Turbomachines, Florence, Italy (2000).
5. P. Kupferschmied, C. Gossweiler, *Calibration, Modelling and Data Evaluation Procedures for Aerodynamic Multihole Pressure Probes on the Example of a Four Hole Probe*, Proc. 11th Symp. on Meas. Tech. for Transonic and Supersonic Flows in Cascades and Turbomachines, Munich, Germany (1992).
6. D. Bohn, H. Simon, *Mehrparametrische Approximation der Eichraume und Eichflaechen von Unterschall- und Ueberschall-5-Loch-Sonden*, ATM Messtechnische Praxis, Germany, March (1975)
7. G. Barigozzi, V. Dossena, P. Gaetani, *Development and First Application of a Single Hole Fast Response Pressure Probe*, 15th Symposium on Measuring Techniques for Transonic and Supersonic Flows in Cascades and Turbomachines, Florence, Italy, Sep 28-29.