

General Disclaimer

One or more of the Following Statements may affect this Document

- This document has been reproduced from the best copy furnished by the organizational source. It is being released in the interest of making available as much information as possible.
- This document may contain data, which exceeds the sheet parameters. It was furnished in this condition by the organizational source and is the best copy available.
- This document may contain tone-on-tone or color graphs, charts and/or pictures, which have been reproduced in black and white.
- This document is paginated as submitted by the original source.
- Portions of this document are not fully legible due to the historical nature of some of the material. However, it is the best reproduction available from the original submission.



The Ohio State University

ADAPTIVE ANTENNA ARRAYS FOR WEAK INTERFERING SIGNALS

Inder J. Gupta

(NASA-CR-174336) ADAPTIVE ANTENNA ARRAYS
FOR WEAK INTERFERING SIGNALS (Ohio State
Univ., Columbus.) 71 p HC A04/MF A01

N85-17258

CSCL 09E

Unclas
G3/32 14069

The Ohio State University

ElectroScience Laboratory

Department of Electrical Engineering
Columbus, Ohio 43212

Technical Report 716111-2

Grant No. NAG3-536

January 1985



National Aeronautics and Space Administration
Lewis Research Center - 21000 Brookpark Road
Cleveland, Ohio 44135

REPORT DOCUMENTATION PAGE	1. REPORT NO.	2.	3. Recipient's Accession No.
4. Title and Subtitle ADAPTIVE ANTENNA ARRAYS FOR WEAK INTERFERING SIGNALS		5. Report Date January 1985	
7. Author(s) Inder J. Gupta		6.	
9. Performing Organization Name and Address The Ohio State University ElectroScience Laboratory Department of Electrical Engineering Columbus, Ohio 43212		8. Performing Organization Rept. No. ESL 716111-2	
12. Sponsoring Organization Name and Address National Aeronautics and Space Administration Lewis Research Center - 21000 Brookpark Road Cleveland, Ohio 44135		10. Project/Task/Work Unit No.	
15. Supplementary Notes		11. Contract(C) or Grant(G) No. (C) NAG3-536 (G):	
16. Abstract (Limit: 200 words) The interference protection provided by adaptive antenna arrays to earth station or satellite receive antenna system is studied. The special case where the interference is caused by the transmission from adjacent satellites or earth stations whose signals inadvertently enter the receiving system and interfere with the communication link is considered. Thus, the interfering signals are very weak (below thermal noise). Conventional adaptive arrays are unable to provide a significant suppression for such interfering signals. To increase the interference suppression, one can either decrease the thermal noise in the feedback loops (noise decorrelation is carried out) or increase the gain of the auxiliary antennas in the interfering signal direction (when these directions are approximately known). Both methods are examined in this report. It is shown that for significant suppression of weak interfering signals, one may have to reduce the noise correlation to impractically low values and if directive auxiliary antennas are used, the auxiliary antenna size may have to be too large. One can, however, combine the two methods to achieve the specified interference suppression with reasonable requirements of noise decorrelation and auxiliary antenna size. A relationship between these two quantities for a specified interference suppression is given. Effects of the errors in the steering vector on the adaptive array performance are also studied.		13. Type of Report & Period Covered Technical	
17. Document Analysis		14.	
a. Descriptors			
b. Identifiers/Open-Ended Terms			
c. COSATI Field/Group			
18. Availability Statement	19. Security Class (This Report) Unclassified	21. No. of Pages 66	
	20. Security Class (This Page) Unclassified	22. Price	

TABLE OF CONTENTS

	Page
ABSTRACT	i
LIST OF FIGURES	iv
I. INTRODUCTION	1
II. DECORRELATION OF NOISE	5
III. DIRECTIVE AUXILIARY ANTENNAS	12
IV. EFFECT OF ERRORS IN THE STEERING VECTOR	25
V. FULLY ADAPTIVE ARRAY	44
VI. CONCLUSIONS AND RECOMMENDATIONS	63
REFERENCES	66

PRECEDING PAGE BLANK NOT VIEWED

LIST OF FIGURES

<u>Figure</u>	<u>Page</u>
1. A typical feedback loop of a modified steered beam adaptive array. Two amplifiers are used to reduce the noise in the feedback loops.	6
2. A typical feedback loop of a conventional steered beam adaptive array.	7
3. Normalized output jammer (interference) power vs. the decorrelation factor (F). $\theta_d = 90^\circ$, SNR (main) = $\xi_{dm} = 20$ dB, SNR (aux.) = $\xi_{da} = 0$ dB, $\theta_i = 60^\circ$, INR (main) = INR (aux.) + 3 dB = $\xi_{ia} + 3$ dB, $G/\alpha = 100$.	10
4. Normalized output jammer power vs. the decorrelation factor (F) for various auxiliary antennas. INR (isotropic) = -10 dB, INR (main) = -7 dB, INR (aux.) = INR (isotropic) + gain.	13
5. Output SINR vs. the decorrelation factor for various auxiliary antennas.	20
6. Output desired signal power vs. the decorrelation factor (F) for various auxiliary antennas.	21
7. Normalized output noise power vs. the decorrelaion factor for various auxiliary antennas.	23
8. Output desired signal power vs. μ . $\theta_d = 90^\circ$, $\xi_{dm} = 20$ dB, $\xi_{da} = -10$ dB, $\frac{G}{\alpha} = 100$, no jammer.	27
9. Normalized output noise power vs. μ . $\theta_d = 90^\circ$, $\xi_{dm} = 20$ dB, $\xi_{da} = -10$ dB, $\frac{G}{\alpha} = 100$., No Jammer.	28
10. Output desired signal power vs. μ . $\theta_d = 90^\circ$, $\xi_{dm} = 20$ dB, $\xi_{da} = 0$ dB, $\frac{G}{\alpha} = 100$., No Jammer.	31
11. Normalized output noise power vs. μ . $\theta_d = 90^\circ$, $\xi_{dm} = 20$ dB, $\xi_{da} = 0$ dB, $\frac{G}{\alpha} = 100$., No Jammer.	32

<u>Figure</u>	<u>Page</u>
12. Output SINR vs. μ . $\theta_d = 90^\circ$, $\xi_{dm} = 20$ dB, $\xi_{da} = -10$ dB, $\frac{G}{\alpha} = 100.$, No Jammer.	33
13. Output SINR vs. μ . $\theta_d = 90^\circ$, $\xi_{dm} = 20$ dB, $\xi_{da} = 0$ dB, $\frac{G}{\alpha} = 100.$, No Jammer.	34
14. Output SINR vs. μ . $\theta_d = 90^\circ$, $\xi_{dm} = 20$ dB, ξ_{da} is varied, $G/\alpha = 100.$, $\rho = 1$, No Jammer.	36
15. Output SINR vs. μ . $\theta_d = 90^\circ$, $\xi_{dm} = 20$ dB, ξ_{da} is varied, $\theta_i = 60^\circ$, $\xi_{im} = -7$ dB, $\xi_{ia} = 3.5$ dB, $\frac{G}{\alpha} = 100$, $\rho = 1.0$.	37
16. A fully adaptive steered beam adaptive array.	45
17. A typical feedback loop of a fully adaptive array.	46
18. Normalized output interference power of a fully adaptive array vs. the input INR in the main antenna. $\theta_d = 90^\circ$, $\theta_i = 60^\circ$, SNR (main antenna) = 20 dB, SNR (auxiliary antenna) = 0 dB, $\frac{G}{\alpha} = 100$, $\mu=1$.	51
19. Normalized output jammer power of a sidelobe canceller vs. the input INR in the main antenna. $\theta_d = 90^\circ$, $\theta_i = 60^\circ$, SNR (main antenna) = 20 dB, SNR (auxiliary antenna) = 0 dB, $G/\alpha = 100$.	53
20. Normalized output interference power vs. the decorrelation factor of a fully adaptive array. $\theta_d = 90^\circ$, $\xi_{dm} = 20$ dB, $\xi_{da} = 0$ dB, $\xi_{im} = \xi_{ia} + 3$ dB, $G/\alpha = 100$, $\mu = 1$.	55
21. Normalized output interference power vs. the decorrelation factor for various auxiliary antennas. $\theta_d = 90^\circ$, $\xi_{dm} = 20$ dB, $\xi_{da} = 0$ dB, $\theta_i = 60^\circ$, $\xi_{im} = -7$ dB, $\xi_{ia} = -10 + \text{gain dB}$, $\frac{G}{\alpha} = 100$, $\mu = 1$.	58
22. Output SINR vs. the decorrelation factor for various auxiliary antennas.	60
23. Normalized output noise power vs. the decorrelation factor for various auxiliary antennas.	61

I. INTRODUCTION

In this report, the interference protection provided by adaptive antenna arrays to earth station or satellite receive antenna systems is studied. The special case where the interference is caused by the transmission from adjacent satellites or earth stations whose signals inadvertently enter the receiving system and interfere with the communication link is considered. Thus, the interfering signals are significantly weaker than the desired signal and may be below the noise level by several dB.

Adaptive antenna arrays have been thoroughly investigated over the last decade with the main objective of providing interference protection to radar and communication systems where the interference to desired signal ratio is large and the interference to noise ratio is even larger. In the satellite communication systems under consideration, however, the undesired signals are significantly weaker than the desired signals and in fact may even be below the noise level by several dB. Although weak, these signals because of their coherent nature and their similarity to the desired signal, do cause objectionable interference and must be suppressed. In our previous work [1], it was shown that conventional adaptive antenna arrays (sidelobe canceller was used), are incapable of suppressing such interfering signals. The reason for the lack of interference suppression is that for weak interfering signals, the thermal noise (sky noise and/or internal thermal noise) is the main source of degradation in the output signal-to-interference-plus noise ratio (SINR) and thus it (thermal noise) controls the array weights.

The array weights are adjusted to minimize the thermal noise which in turn maximizes the output SINR. A modification of the adaptive array was then proposed [1] which appears to overcome this difficulty.

In the modified adaptive array, the noise level in the feedback loops controlling the array weights is reduced. The noise level is reduced by reducing the correlation between the noise components of the two inputs to the loop correlator. Various techniques to decorrelate these noise components were discussed in technical report 716111-1 [1]. In this work, the amount of decorrelation needed to achieve a certain interference suppression is computed. It is shown that for a significant suppression of weak interfering signals, one may need to reduce the noise correlation to impractically low levels. Therefore, to achieve the desired interference suppression for a reasonable amount of noise decorrelation, other methods of interference suppression are combined with the modified adaptive arrays.

When the directions of the sources radiating the interfering signals are approximately known one can replace low gain auxiliary antennas (main antenna is highly directive and is steered in the desired signal direction) with high gain antennas and point their main beams along those directions. Thus, the interference signal level in the feedback loops will increase which in turn will increase the interference suppression. The larger the gain of the auxiliary antennas, the higher the interference suppression. If further interference suppression is desired, one can use modified feedback loops (noise correlation is carried out). Since the interfering signal level in the feedback loops is quite high, the amount of noise decorrelation

required to achieve the specified interference suppression will be within reasonable limits. An analytical expression for the amount of noise decorrelation required to achieve a specified interference suppression for given auxiliary antennas is developed.

The effects of noise decorrelation on the other signals (thermal noise and the desired signal) present in the communication system are also studied. It is shown that the desired signal level at the output port is maintained as long as an accurate steering vector [1] is used. The thermal noise at the output port, especially for low gain auxiliary antennas, increases with an increase in the noise decorrelation resulting in SINR degradation. A poor steering vector (in the case of a sidelobe canceller) causes additional thermal noise as well as a degradation in the desired signal level at the array output. Thus, the output SINR degrades sharply. The SINR degradation increases with an increase in noise decorrelation. Therefore, for the optimum performance, one should use as accurate a steering vector as possible and the noise decorrelation should be kept to minimum possible.

One way to avoid the degradation of the desired signal because of errors in the steering vector is to use a fully adaptive array. In the case a fully adaptive array, in contrast to a sidelobe canceller [1], even the main antenna has an adaptive feedback loop. Thus, the total number of feedback loops is $N + 1$ (N is the number of auxiliary antennas). The performance of such fully adaptive arrays is studied in this report. It is shown that a fully adaptive array provides the same interference protection as a sidelobe canceller and has a better output SINR (the desired signal is not degraded).

The effect of noise decorrelation on the interference suppression is studied in section II. Directive auxiliary antennas are considered in section III. Effect of errors in the steering vector are studied in section IV. Section V deals with fully adaptive array. Section VI contains conclusions.

II. DECORRELATION OF NOISE

Figure 1 shows a typical feedback loop of a modified steered beam adaptive array (sidelobe canceller). Two amplifiers in the feedback loop are used to reduce the noise level in the feedback loop [1]. For a sidelobe canceller with N auxiliary elements, there are N such feedback loops and the steady state weight vector W is given by

$$(\alpha I + G\Phi)W = G(R - U_s) \quad (1)$$

where α is the pole position of the low pass filter in the feedback loop and controls its bandwidth, G is the loop gain, I is an $N \times N$ identity matrix, Φ is a covariance matrix defining the correlation between the signals present in various auxiliary antennas, R is a correlation vector defining the correlation between the signals present in the main antenna and those in the auxiliary elements and U_s is the steering vector. In practice, the signal present on various antenna elements consists of a desired signal, interfering signals and uncorrelated noise (sky noise and/or internal thermal noise). Assuming that the various signals incident on the antennas are uncorrelated with each other and with the noise, and the noise voltages in various antennas are uncorrelated with each other and are zero mean gaussian with variance σ^2 , one can write (1) as

$$[\alpha I + G(\rho\sigma^2 I + \Phi_d + \sum_{i=1}^M \Phi_i)] W = G(U_d + \sum_{i=1}^M U_i - U_s) \quad (2)$$

where Φ_d is the covariance matrix due to the desired signal present at various auxiliary antennas, Φ_i is the covariance matrix due to the i th interfering signal, U_d and U_i are the correlation vector due to the

desired signal and i th interfering signal, respectively, and M is the total number of interfering signals. In (2), the factor ρ ($0 < \rho < 1$) represents the correlation between the noise signals of the two inputs of the correlator in the feedback loops (Figure 1). If $\rho = 0$, the two noise signals are completely decorrelated. If $\rho = 1$, the two noise signals are fully correlated and the performance of the sidelobe canceller will be the same as obtained using conventional feedback loops (Figure 2).

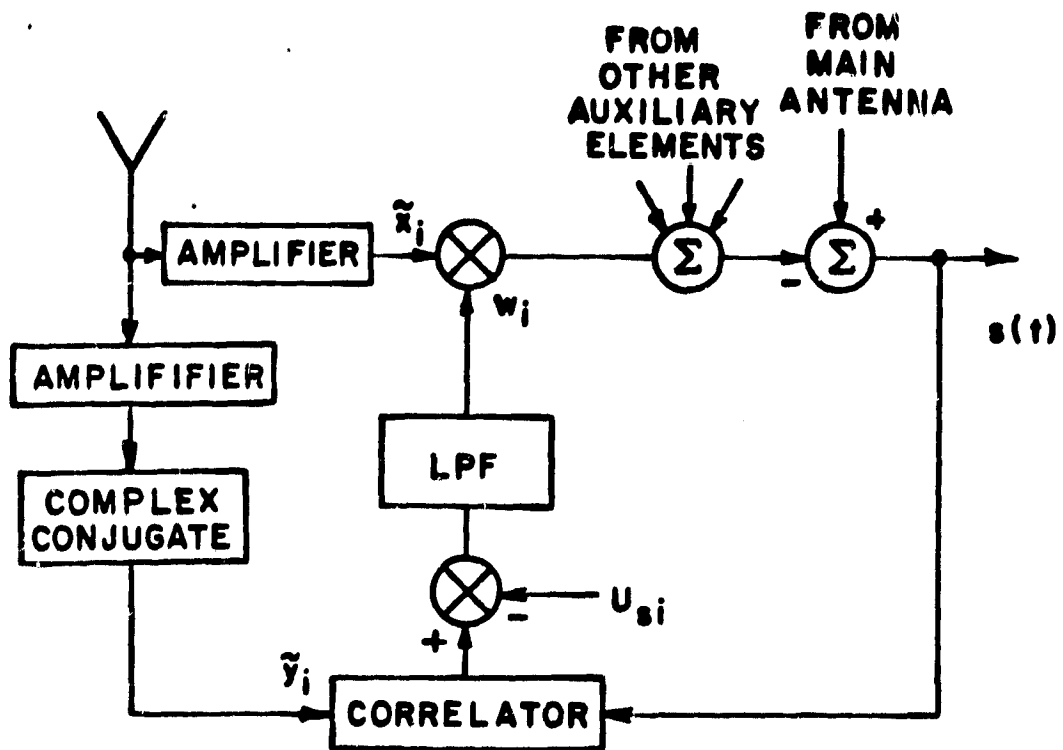

Figure 1. A typical feedback loop of a modified steered beam adaptive array. Two amplifiers are used to reduce the noise in the feedback loops.

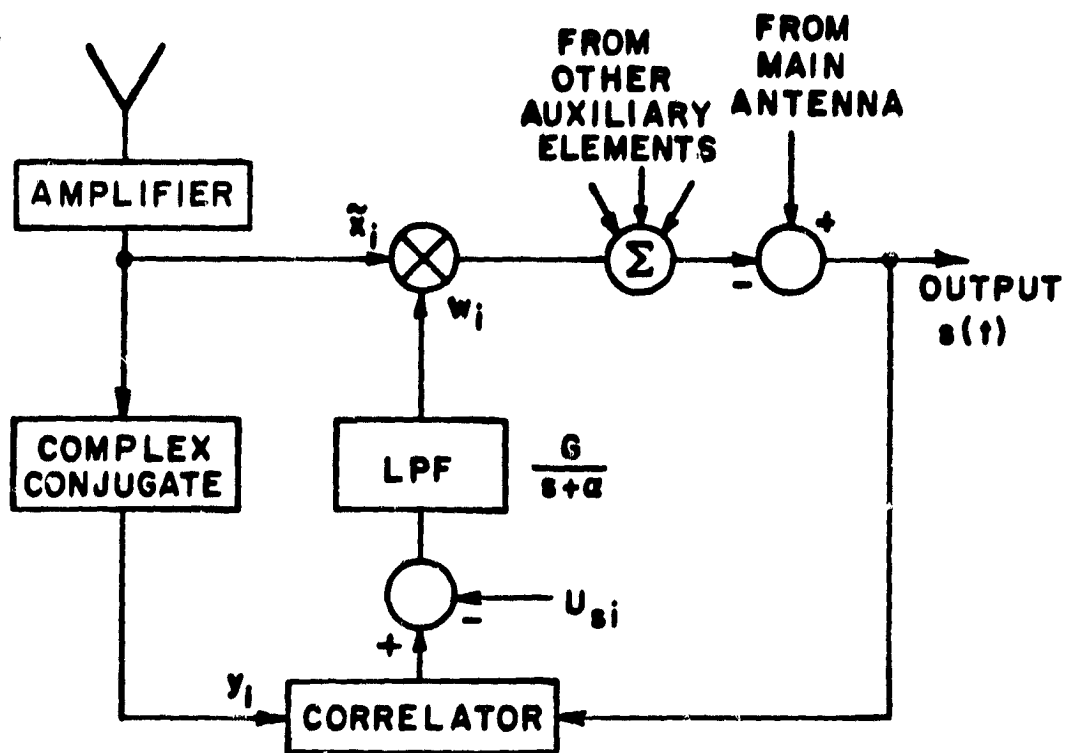

Figure 2. A typical feedback loop of a conventional steered beam adaptive array.

Let the steering vector be chosen so that

$$U_s = U_d \quad . \quad (3)$$

This choice of the steering vector prevents the cancellation of the desired signal [2]. Note that one should know the desired signal direction and its amplitude at the various antenna elements to choose a correct steering vector. In the case of ground station or satellite receive antennas, the location of the desired signal source is known and one can find the desired signal amplitude at the various antenna elements by knowing the gain of the various antennas in the desired signal's direction. Substituting (3) in (2), one gets

$$\left[I + \frac{G}{\alpha} (\rho \sigma^2 I + \hat{\rho}_d + \sum_{i=1}^M \hat{\rho}_i) \right] W = \frac{G}{\alpha} \sum_{i=1}^M U_i \quad . \quad (4)$$

Using (4), the steady state weights of the adaptive array can be computed and its performance can be evaluated. The desired signal power at the output port is

$$S_d = \frac{1}{2} \left| \tilde{x}_{do} - X_d^T W \right|^2 \quad (5)$$

where \tilde{x}_{do} is the desired signal in the main antenna and X_d is an $N \times 1$ column vector defining the desired signal in the various auxiliary antennas. The interference power at the output port is

$$S_j = \sum_{i=1}^M \frac{1}{2} \left| \tilde{x}_{io} - X_i^T W \right|^2 \quad (6)$$

where \tilde{x}_{i0} is the i^{th} interfering signal in the main antenna and x_j is an $N \times 1$ column vector defining the i^{th} interfering signal in various auxiliary antennas. The noise power at the output port is

$$S_n = \frac{1}{2} (\sigma_0^2 + \sigma^2 W^T W^*) \quad (7)$$

where σ_0^2 is the noise power in the main antenna.

Figure 3 shows the output interference power of an adaptive array consisting of four auxiliary antennas. The main antenna is assumed to be a linear array of ten isotropic antennas steered along broadside (the desired signal's direction). The interelement spacing is half a wavelength. The auxiliary antennas are also assumed to be isotropic radiators with interelement spacing of half a wavelength. This particular distribution is chosen to demonstrate the basic principle and represents a satellite communications system where the interfering signals are nearly planar with the desired signal. In practice, the main antenna may be a reflector antenna or it may be an array of directive antennas. The same is true for the auxiliary antennas.

The input SNR in the main antenna is assumed to be 20 dB while in the auxiliary antennas it (the input SNR) is 0 dB. The interfering signal scenario consists of a single CW jammer incident from 30° off broadside to the main antenna. The main antenna has a -17 dB sidelobe in this direction, i.e., if the desired signal is incident from this

† The noise is assumed to be receiver thermal noise and the noise power in the main antenna is the same as in the auxiliary elements.

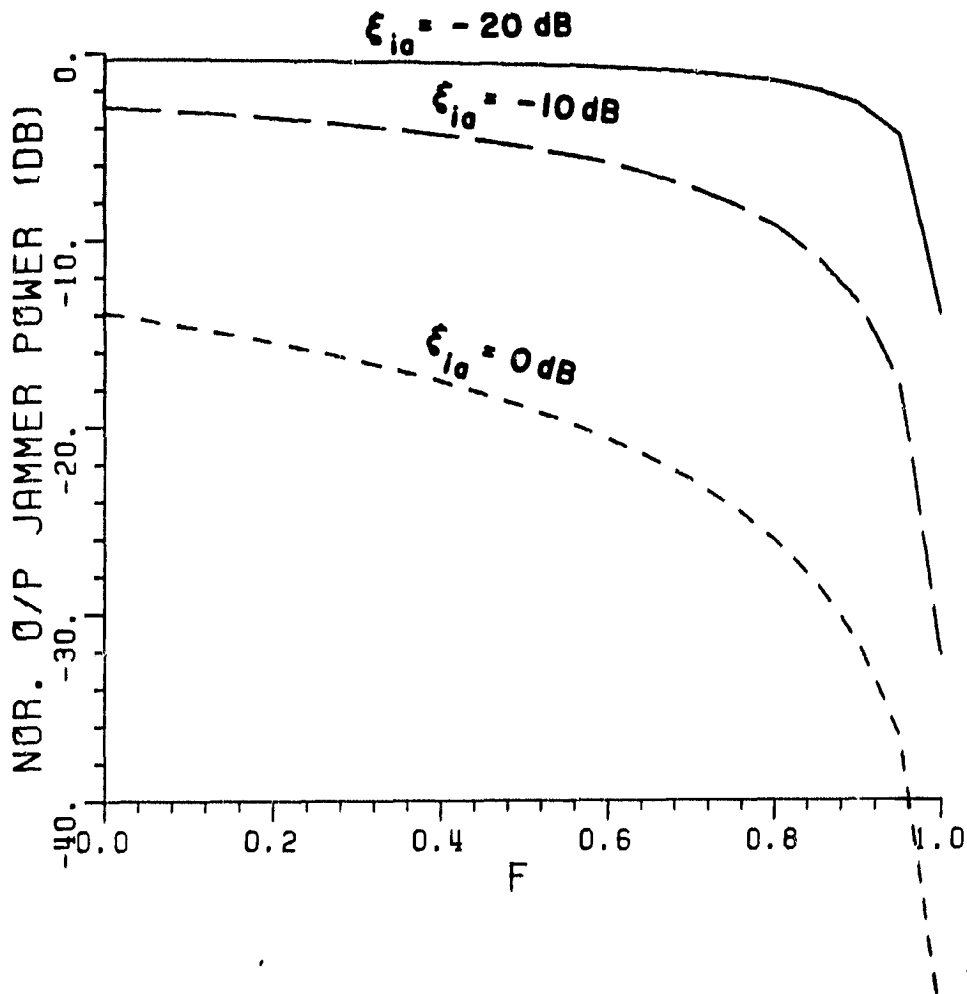

Figure 3. Normalized output jammer (interference) power vs. the decorrelation factor (F). $\theta_d = 90^\circ$, SNR (main) = $\epsilon_{dm} = 20 \text{ dB}$, SNR (aux.) = $\epsilon_{da} = 0 \text{ dB}$, $\eta_j = 60^\circ$, INR (main) = INR (aux.) + 3 dB = $\epsilon_{ja} + 3 \text{ dB}$, $G/\alpha = 100$.

direction, its SNR in the main antenna will be 3 dB instead of 20 dB. Due to the sidelobe structure, the input INR in the main antenna is assumed to be 3 dB higher than its value at an isotropic antenna (auxiliary antennas). The output interference power is plotted versus $1-\rho$ (F) for various values of input INR. We will call F the decorrelation factor. Thus, when the decorrelation factor is zero, the two noise voltages are perfectly correlated and if the decorrelation factor is one, the two noise voltages are completely decorrelated. Normalized interference power (normalized with respect to the interference power at the input of the main antenna) is plotted. Note that for weak interfering signals (INR < -10 dB), one needs a very low correlation between the noise voltages for any significant interference suppression. For example, for a -10 dB interfering signal, the decorrelation factor should be 0.95 to achieve a 20 dB jammer suppression (output normalized jammer power would be -20 dB). Decorrelating the noise to such an extent may not be possible. Thus, other methods of interference suppression should be explored, and should be combined with the modified adaptive array to achieve the desired interference suppression for a reasonable amount of noise decorrelation.

III. DIRECTIVE AUXILIARY ANTENNAS

In the case of adaptive antenna arrays, for weak interfering signals, the thermal noise is the main source of degradation in the output SINR and thus controls the array weights. Since in a sidelobe canceller, the noise in the main antenna is uncorrelated with the noise in the auxiliary antennas, it cannot be cancelled with the noise in the auxiliary antennas. Thus, the only way for the array to minimize the noise at the array output and consequently maximize the output SINR is to shut off the auxiliary antennas, i.e., make $W = 0$. This choice of the weight vector minimizes the noise. However, interference remains unsuppressed. By decorrelating the noise voltages in the feedback loops, the directional signals (interference and desired signals) are made more effective and thus these signals control the array weights. For perfectly decorrelated noise ($\rho = 0$), only these signals control the array weights and thus interference is suppressed. Another method of increasing the effect of interfering signals on the weights is to increase the magnitude of interfering signals in the auxiliary antennas while keeping the uncorrelated noise fixed. This can be achieved by using directive antennas as auxiliary antennas. If the direction of an interfering source is approximately known, the auxiliary antennas can be pointed along the interference's direction and thus the interfering signal amplitude in the auxiliary antennas can be increased. The array will then adjust its weights to suppress the interfering signal.

Figure 4 shows the output interference power of the 4-auxiliary elements sidelobe canceller versus F for various types of auxiliary

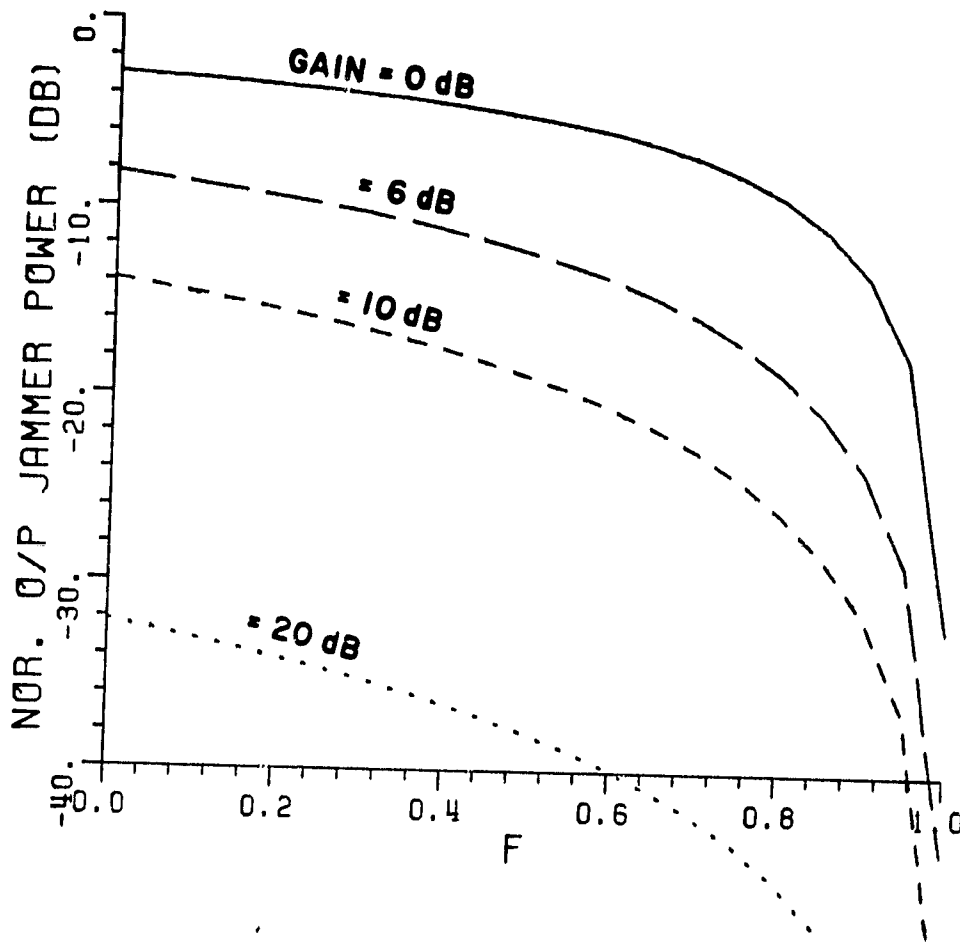

Figure 4. Normalized output jammer power vs. the decorrelation factor (F) for various auxiliary antennas. INR (isotropic) = -10 dB, INR (main) = -7 dB, INR (aux.) = INR (isotropic) + gain.

antennas (the auxiliary antenna element gain in the direction of interfering signal is varied). The input INR on an isotropic antenna is chosen to be -10 dB. Thus, the INR at the main antenna is -7 dB while at an auxiliary antenna it is -10 dB + the gain of the auxiliary antenna. All other parameters are the same as in Figure 3. Note that for a given F (the decorrelation factor), the output interference power decreases with an increase in the auxiliary element gain. Hence by using directive auxiliary antennas, one can increase the interference suppression. Another important observation to be made from the plots of Figure 4 is that one can trade off the noise decorrelation with the gain of the auxiliary antennas. For example, for a 20 dB jammer suppression (normalized output interference power would be -20 dB), the decorrelation factor for isotropic auxiliary antennas is 0.95 while for 6 dB and 10 dB auxiliary antennas the decorrelation factors, respectively, are 0.82 and 0.56. Hence, the larger the auxiliary antenna gain, the smaller the noise decorrelation required. A relationship between these two quantities is developed next.

Let the signal scenario consists of a single CW jammer (desired signal is absent). Then from (4)

$$\left[I + \frac{G}{\alpha} (\rho \sigma^2 I + G_a \Phi_j) \right] W = \frac{G}{\alpha} U_j \quad (8)$$

where G_a is the gain of auxiliary antenna and Φ_j is covariance matrix of the interfering signal present at various auxiliary elements when the auxiliary antennas are replaced by isotropic antennas. In (8), the desired signal is assumed to be absent because we want to study the

interference suppression which is unaffected by the presence or absence of the desired signal (the steering vector removes the desired signal from the feedback loops). For a narrowband interfering signal,

$$\phi_i = A_i^2 U_{ia}^* U_{ia}^T \quad (9)$$

$$\text{and } U_i = \sqrt{G_a} A_i A_{i0} U_{ia}^* \quad (10)$$

where A_i is the interfering signal amplitude at an isotropic antenna, A_{i0} is the interfering signal amplitude at the main antenna and U_{ia} is the interference signal vector and represents the relative phase of the interfering signal at various auxiliary elements (measured with respect to the phase center of the main antenna). In (9), superscripts $*$ and T denote complex conjugate and transpose, respectively. Substituting (9) and (10) in (8), one gets

$$\left[I + \frac{G}{\alpha} (\rho\sigma^2 I + G_a A_i^2 U_{ia}^* U_{ia}^T) \right] W = \frac{G}{\alpha} \sqrt{G_a} A_i A_{i0} U_{ia}^*$$

or,

$$\left(1 + \frac{G}{\alpha} \rho\sigma^2 \right) \left[I + \frac{\frac{G}{\alpha} G_a A_i^2}{1 + \frac{G}{\alpha} \rho\sigma^2} U_{ia}^* U_{ia}^T \right] W = \frac{G}{\alpha} \sqrt{G_a} A_i A_{i0} U_{ia}^* \quad (11)$$

From (11),

$$W = K \sqrt{G_a} A_i A_{i0} \left[I + K G_a A_i^2 U_{ia}^* U_{ia}^T \right]^{-1} U_{ia}^* \quad (12)$$

where

$$K = \frac{G/\alpha}{1 + \frac{G}{\alpha} \rho \sigma} \quad (13)$$

Now

$$(I + KG_a A_j^2 U_{ia}^T U_{ia})^{-1} = I - \frac{KG_a A_j^2 U_{ia}^T U_{ia}}{1 + KG_a A_j^2 U_{ia}^T U_{ia}} \quad (14)$$

Substituting (14) in (12), one gets

$$W = \frac{K\sqrt{G_a} A_j A_{io}}{1 + KG_a A_j^2 U_{ia}^T U_{ia}} U_{ia} \quad (15)$$

Using (15) in (6), the interference signal power at the array output is

$$S_j = \frac{1}{2} \left| A_{io} - \frac{KG_a A_j A_{io}}{1 + KG_a A_j^2 U_{ia}^T U_{ia}} U_{ia}^T U_{ia} \right|^2 \quad (16)$$

and the interference suppression is

$$\frac{S_j}{\frac{1}{2} A_{io}^2} = \left| \frac{1}{1 + KG_a A_j^2 U_{ia}^T U_{ia}} \right|^2 \quad (17)$$

Let the interference suppression be β^2 ($-20 \log_{10} \beta$ dB) then from (17)

$$\frac{1}{1 + K G_a A_i^2 U_{ia}^T U_{ia}^*} = \beta \quad (18)$$

For a side canceller with N - auxiliary antennas

$$U_{ia}^T U_{ia}^* = N \quad (19)$$

Thus,

$$\beta = \frac{1}{1 + K N G_a A_i^2} \quad (20)$$

or,

$$\beta = \frac{1}{1 + \frac{G}{\alpha} \frac{N G_a A_i^2}{1 + \frac{G}{\alpha} \rho \sigma}} \quad (21)$$

Let $\frac{G}{\alpha} \sigma^2 \gg \frac{1}{\rho}$ (the feedback loop gain is very large) then from (20)

$$\beta = \frac{1}{1 + \frac{G_a N \xi_i}{\rho}} \quad (22)$$

where $\xi_i = \frac{A_i^2}{\sigma^2}$ is the input INR at an isotropic antenna. From (22), it is clear that one can either increase the gain of the auxiliary antennas or reduce the correlation between the two noise signals to increase the interference suppression. From (22),

$$G_a = \frac{1-\beta}{\beta} \frac{\rho}{N\xi_i} \quad . \quad (23)$$

Eq. (23) gives a relationship between the gain of the auxiliary antennas and the noise correlation (ρ) for the required interference suppression. For example, for 20 dB jammer suppression, $\beta = 0.1$ and from (23)

$$G_a = 9 \frac{\rho}{N\xi_i} \quad . \quad (24)$$

For a sidelobe canceller with 4-auxiliary antennas and $\xi_i = 0.1$ (input INR at an isotropic antenna is -10 dB), Eq. (24) yields

$$G_a = 22.5 \rho$$

or,

$$\rho = \frac{G_a}{22.5} \quad . \quad (25)$$

For an isotropic radiator, $G_a = 1$ and thus $\rho = 0.04444$. Hence, one needs a noise decorrelation of the order of 0.95. For 10 dB auxiliary antennas, $G_a = 10$ and from (25), $\rho = 0.44$ or noise decorrelation of the

order of 0.56 is required. These values are the same as computed from the plots in Figure 4. From (23),

$$G_a = \frac{1-\beta}{\beta} \frac{1}{NE_f} (1-F) \quad (26)$$

Thus, the required gain of the auxiliary antennas decreases with an increase in the noise decorrelation. The effects of these two quantities on the output SINR is studied next.

Figure 5 shows the output signal-to-interference-plus-noise ratio (SINR) of the sidelobe canceller vs. the decorrelation factor. All parameters are the same as in Figure 4. Note that the output SINR increases with an increase in the gain of the auxiliary antennas and for highly directive auxiliary antennas, the output SINR is independent of the decorrelation factor. For low gain auxiliary antennas, the output SINR degrades with an increase in the noise decorrelation. For large noise decorrelation, the interference is suppressed by more than 20 dB (Figure 4). Therefore, the drop in the output SINR should be either due to the degradation in the desired signal or an increase in the thermal noise (receiver noise or external noise) at the output junction. However, because of the steering vector, U_s , the desired signal should not be affected by the presence of auxiliary antennas and this can be seen in Figure 6. In Figure 6, the desired signal power at the output port is plotted. All parameters are the same as in Figure 4. The desired signal power is normalized with respect to the thermal noise in the main channel (antenna). Note that the desired signal level is independent of the gain of the auxiliary antennas and the decorrelation

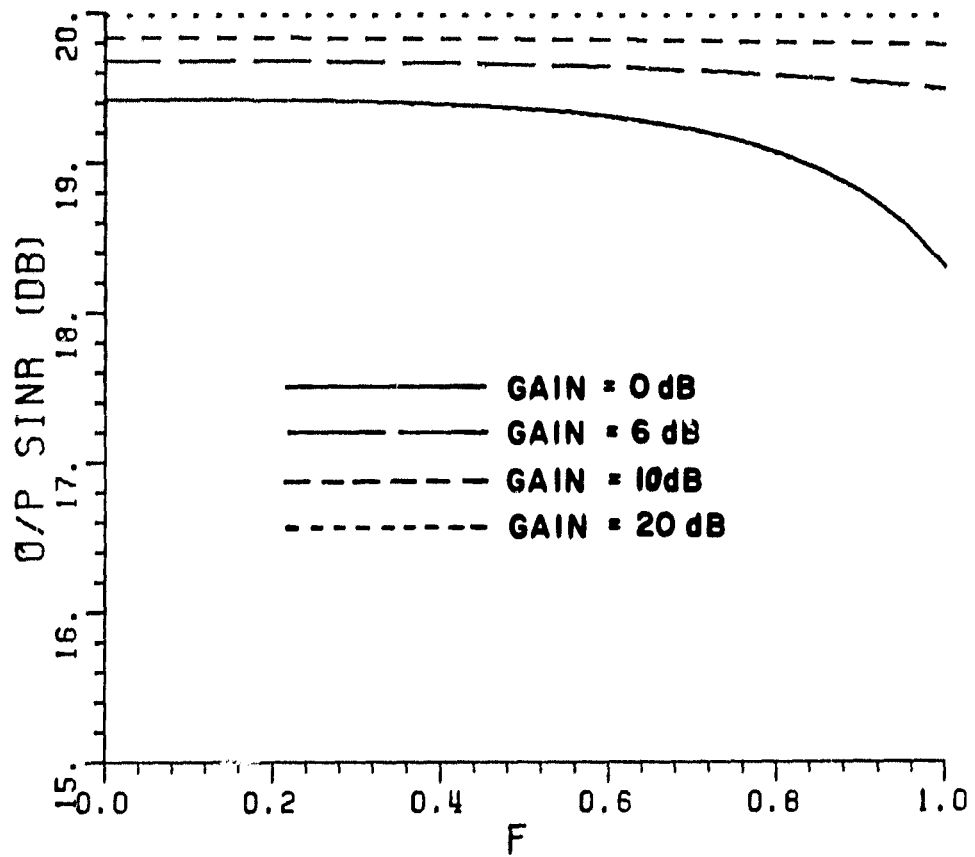

Figure 5. Output SINR vs. the decorrelation factor for various auxiliary antennas.

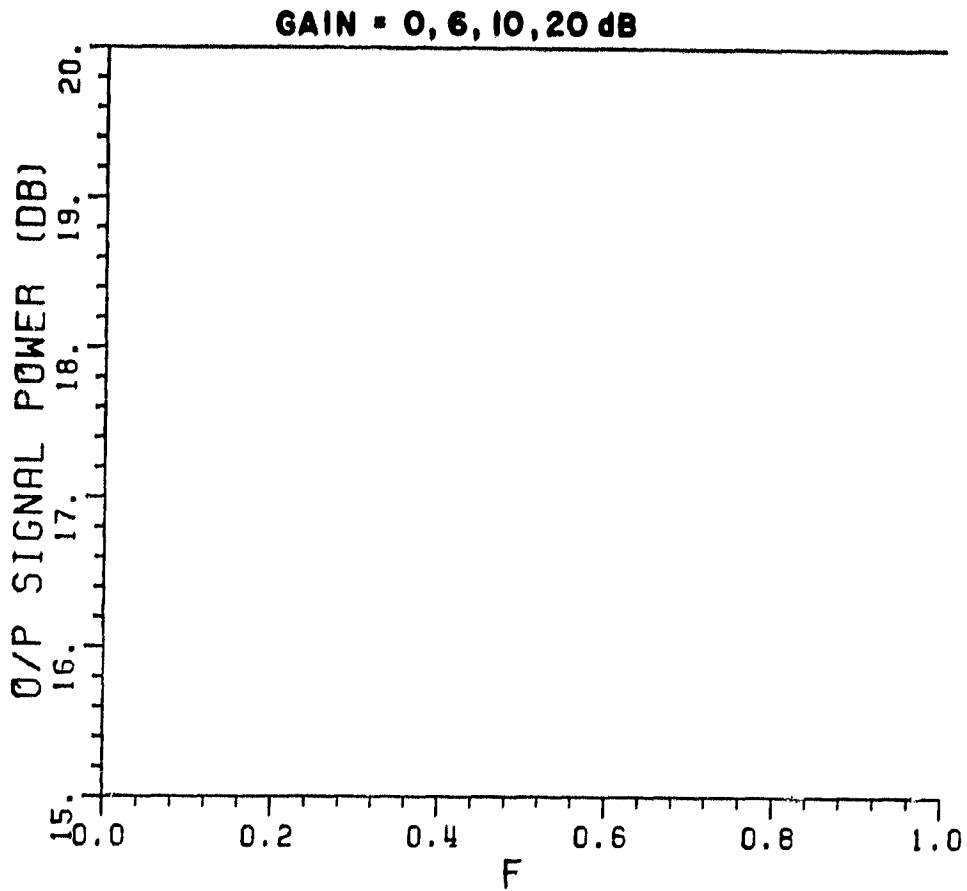

Figure 6. Output desired signal power vs. the decorrelation factor (F) for various auxiliary antennas.

factor. The drop in the output SINR, therefore, is due to the increase in the thermal noise at the output port.

Figure 7 shows the normalized output thermal noise vs. the decorrelation factor. The output noise has been normalized with respect to the thermal noise in the main channel. Note that the output thermal noise is always larger than the noise in the main channel and it increases with a decrease in the gain of the auxiliary antennas. The reason for this is that the noise in the auxiliary antenna is uncorrelated with the noise in the main antenna. Therefore, whenever the auxiliary antennas are activated, the auxiliary channels will add some noise to the output, resulting an increase in the total noise. The amount of noise added by a particular auxiliary antenna depends on its weight magnitude [Eq. 7]. In the presence of interfering signals, the auxiliary antennas are activated to cancel the interfering signal and the magnitude of the auxiliary antenna weights depend on the amplitude of the interfering signal in the auxiliary antenna as compared to that in the main antenna. If the interfering signal amplitude in the auxiliary antenna is lower than that in the main antenna, the auxiliary antenna weights will be large (assuming that the interference is being cancelled) and consequently the auxiliary antennas will add more noise to the output. On the other hand, if the interfering signal amplitude in the auxiliary antennas is larger than the interfering signal in the main antenna (auxiliary antennas are high gain antennas), the weights will be small and consequently less noise will be added to the output port. Another observation to be made from the plots in Figure 7 is that

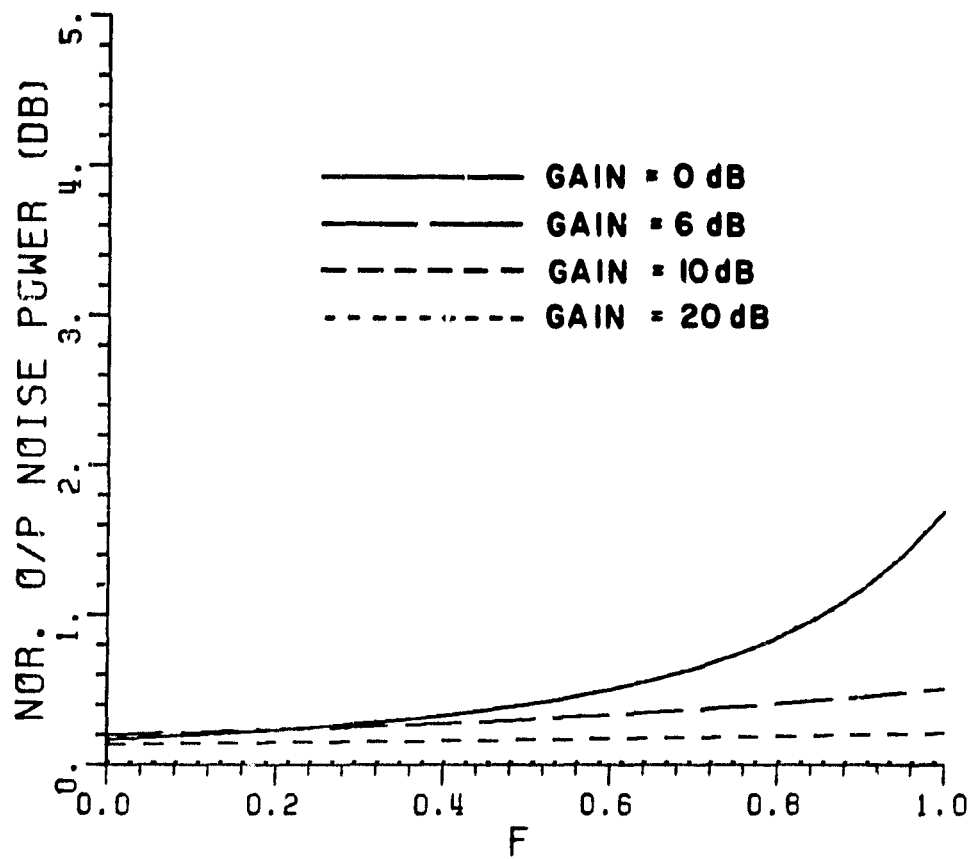

Figure 7. Normalized output noise power vs. the decorrelation factor for various auxiliary antennas.

for low gain auxiliary antennas, the output noise increases with an increase in the decorrelation factor F . This is because high noise decorrelation is required to cancel the interfering signal, or, the auxiliary antennas are not fully active for small values of F .

From the above discussion, it is clear that high gain (directive) auxiliary antennas not only decrease the amount of noise decorrelation required to achieve a specified interference suppression but also add less noise to the output. The degradation in the output SINR is, therefore, negligible. One should, therefore, use directive auxiliary antennas to provide interference protection to satellite communication systems.

In the above discussion, the steering vector was chosen to be an exact replica of the desired signal correlation vector. This choice of the steering vector prevented any degradation of the desired signal due to the auxiliary antennas. The desired signal correlation vector, however, is a function of the desired signal strength which may not be known exactly and may fluctuate. The steering vector, therefore, will not be equal to the desired signal correlation vector. In practice,

$$U_s = \mu U_d \quad \mu > 0 \quad (27)$$

Note that for optimum performance, $\mu = 1$. The effects of errors in the steering vector ($\mu \neq 1$) on the performance of the adaptive arrays is studied next.

IV. EFFECT OF ERRORS IN THE STEERING VECTOR

From (2), the steady state weight vector of a sidelobe canceller using the modified feedback loops is given by

$$[\alpha I + G(\rho\sigma^2 I + \phi_d + \sum_{i=1}^M \phi_i)] W = G[U_d + \sum_{i=1}^M U_i - U_s] \quad (28)$$

where U_s is the steering vector. Let,

$$U_s = \mu U_d \quad (29)$$

where μ is an arbitrary constant >0 and U_d is the desired signal correlation vector. Substituting (29) in (28) and assuming that the signal scenario consists of only desired signals (all interfering signals are absent) one gets

$$[\alpha I + G(\rho\sigma^2 I + \phi_d)] W = G[1-\mu] U_d \quad (30)$$

and

$$W = G(1-\mu) [\alpha I + G(\rho\sigma^2 I + \phi_d)]^{-1} U_d \quad (31)$$

We have assumed that all the interfering signals are absent because as will be demonstrated later, the errors in the steering vector affect the desired signal only. The interference suppression remains unaffected as long as the array has enough degrees of freedom. Using the weights given by Equation (31), various signals at the output port can be computed. The desired signal at the output port is

$$S_d = \frac{1}{2} \left| x_{do} - x_d^T W \right|^2 \quad (32)$$

and the noise power at the output port is

$$S_n = \frac{1}{2} \left| \sigma_o^2 + \sigma^2 W^T W \right| \quad (33)$$

From (31), it is clear that the magnitude of the array weights will be minimum when $\mu = 1$ (perfect steering vector) and thus the output noise power (33) will be minimum for this value of μ . For other values of μ , the weight vector and thus the noise power will increase with an increase in $|1 - \mu|$. The desired signal power at the array output, however, will increase with an increase in μ . The same can be seen in the plots of Figures 8 and 9 where the normalized output signal power and the normalized output noise power of the 4-auxiliary elements sidelobe canceller are plotted vs. μ . Again the main antenna is an array of 10 isotropic elements spaced half a wavelength apart. The signal scenario consists of a desired signal incident from broadside. The input SNR at the main antenna is 20 dB while it is -10 dB at auxiliary antennas. The thermal noise power in the main antenna and each auxiliary antenna is assumed to be the same. The ratio G/α is chosen to be 100. Note that the desired signal power is minimum for $\mu = 0$ and increases with an increase in μ . The output noise is minimum for $\mu = 1$ and increases with an increase in $|1 - \mu|$. Physically, this can be explained as follows.

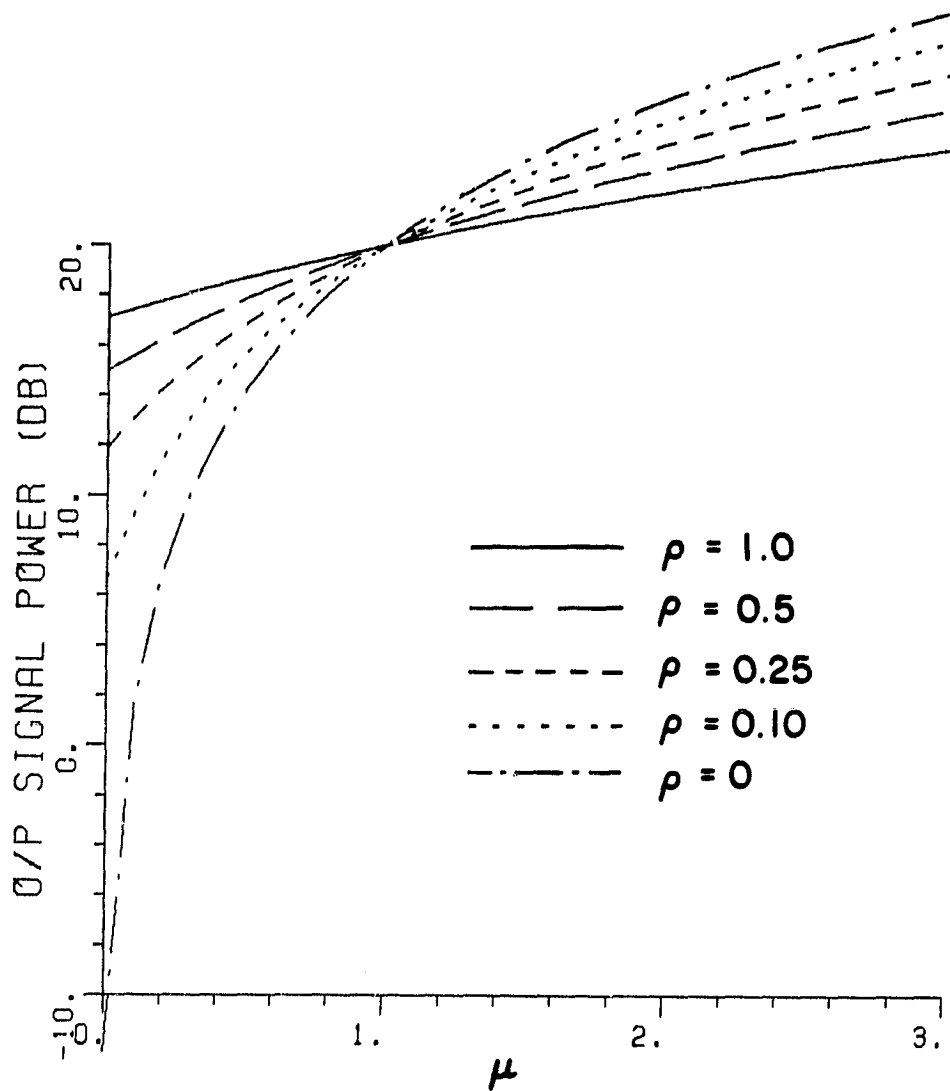

Figure 8. Output desired signal power vs. μ .
 $\theta_d = 90^\circ$, $\xi_{dm} = 20 \text{ dB}$, $\xi_{da} = -10 \text{ dB}$,
 $\frac{G}{\alpha} = 100$, no jammer.

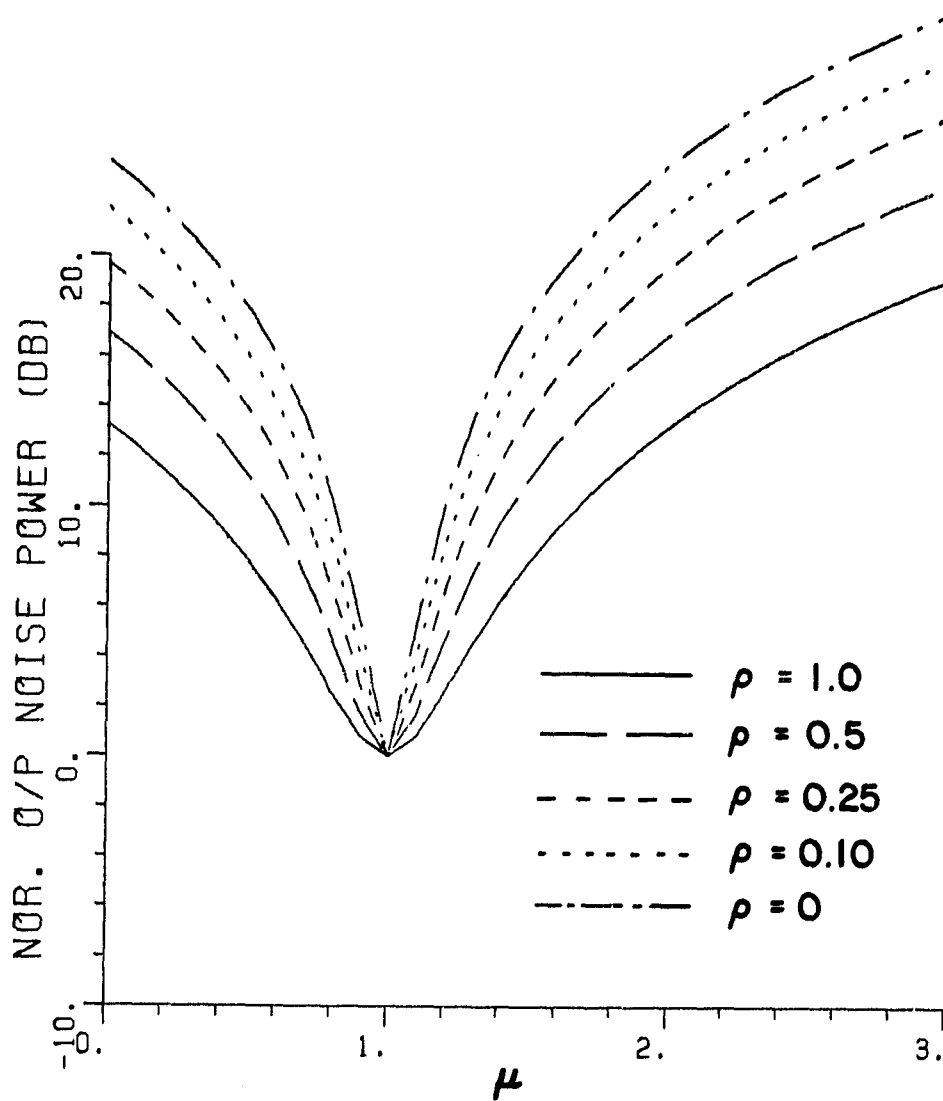

Figure 9. Normalized output noise power vs. μ .
 $\theta_d = 90^\circ$, $\xi_{dm} = 20$ dB, $\xi_{da} = -10$ dB,
 $\frac{G}{\alpha} = 100.$, No Jammer.

For $\mu = 0$, there is no steering vector and thus the desired signal is treated as an undesired signal and the array weights are adjusted to cancel the desired signal. Since the desired signal in the auxiliary antennas is quite weak as compared to the desired signal in the main antenna, the weight magnitudes are quite large which in turn leads to a high noise at the output port. As μ is increased above zero, the auxiliary antenna weights are adjusted to match the desired signal level at the correlator in the feedback loop with that of the steering vector amplitude. The smaller the difference between the two, the smaller the weights and thus the lower the output noise. The output desired signal power also increases because the array is no longer cancelling the desired signal. For $\mu = 1$, the desired signal level at the correlator becomes equal to the steering vector amplitude and thus the auxiliary antennas are turned off. The output noise power, therefore, is minimum for this value of μ and increases with any further increase in μ . The desired signal power on the other hand keeps on increasing with μ because for $\mu > 1$, the auxiliary element weights are adjusted to enhance the desired signal.

In Figures 8 and 9, curves are drawn for various values of ρ . Note that the increase in the desired signal power for $\mu > 1$ and the decrease in the desired signal power for $\mu < 1$ is enhanced by a decrease in ρ or an increase in the noise decorrelation. This is because the desired signal level in the auxiliary antennas is quite low (input SNR = -10 dB) and thus for $\rho = 1$, the sidelobe canceller does not fully react to the desired signal, i.e., thermal noise controls the array weights.

However, with an increase in the noise decorrelation ($\rho < 1$), the sidelobe canceller starts reacting to the desired signal and depending on μ causes either more degradation or more enhancement of the desired signal. The output noise power increases with a decrease in ρ because the auxiliary channels add more noise to the output port.

Figures 10 and 11 show the normalized output desired signal power and the noise power of the array when the input desired signal in the auxiliary antennas is increased such that input SNR at each auxiliary antenna is zero dB. All other parameters are the same as in Figures 8 and 9. Note that the variation in the two quantities with ρ is very small. The reason for this is that the desired signal in the auxiliary antennas is strong enough for the sidelobe canceller to react to the desired signal. Thus, the noise decorrelation in the feedback loops does not affect the array performance.

Figures 12 and 13 show the output SINR of the array vs. μ . All parameters are the same as in Figures 8 and 10, respectively. Note that the output SINR is maximum for $\mu = 1$ and for other values of μ it drops from its maximum value. The drop in the output SINR increases with an increase in $|1 - \mu|$. For a weak desired signal in the auxiliary antennas, the drop in the output SINR further increases with an increase in noise decorrelation ($\rho < 1$). Thus, for optimum performance ρ should be unity, i.e., no noise decorrelation should be carried out and μ should also be close to unity. The noise decorrelation is necessary for the suppression of weak interfering signals. Therefore, to avoid any degradation in the output SINR, μ should be equal to unity, i.e.,

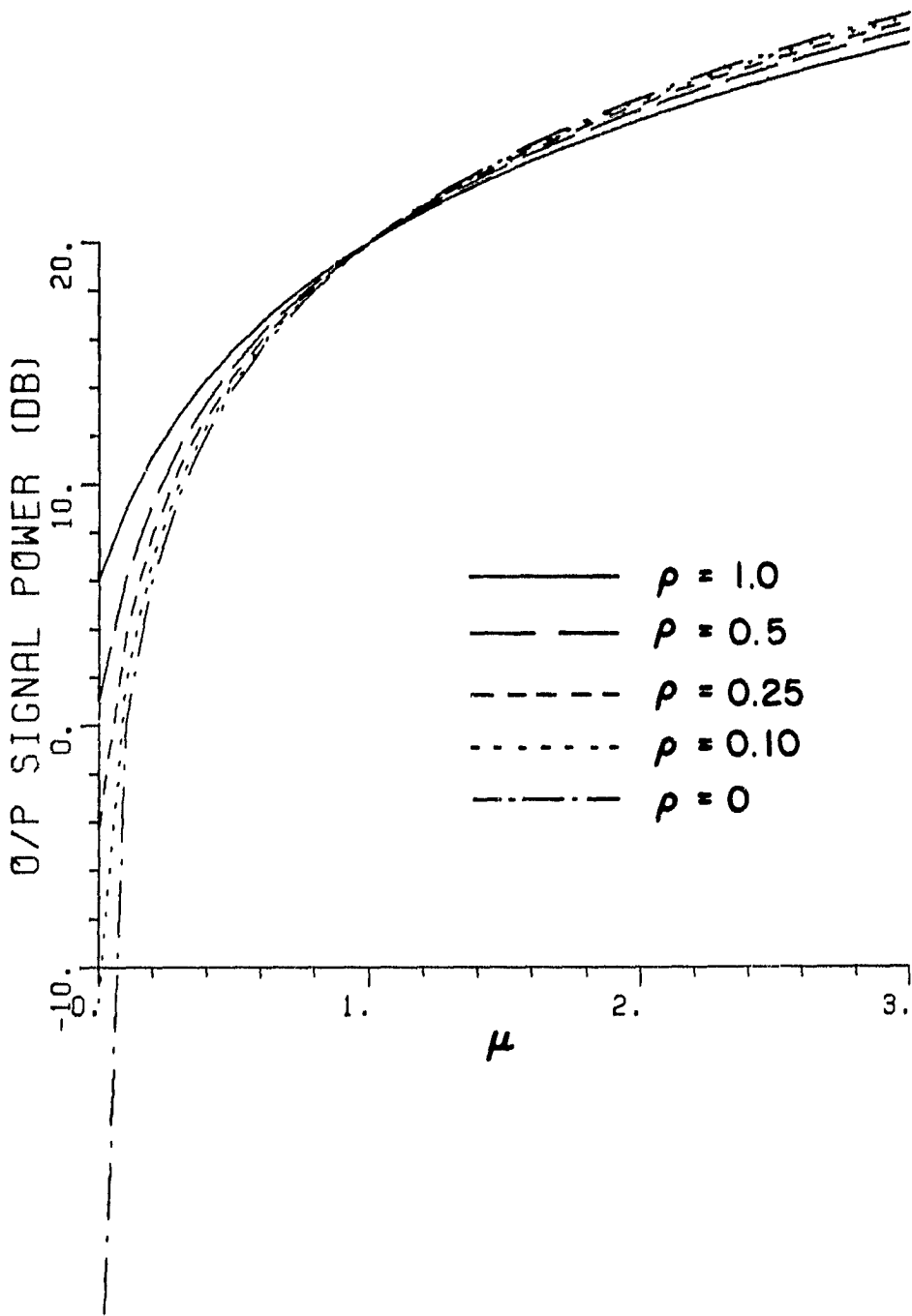

Figure 10. Output desired signal power vs. μ .
 $\theta_d = 90^\circ$, $\xi_{dm} = 20$ dB, $\xi_{da} = 0$ dB,
 $\frac{G}{\alpha} = 100.$, No Jammer.

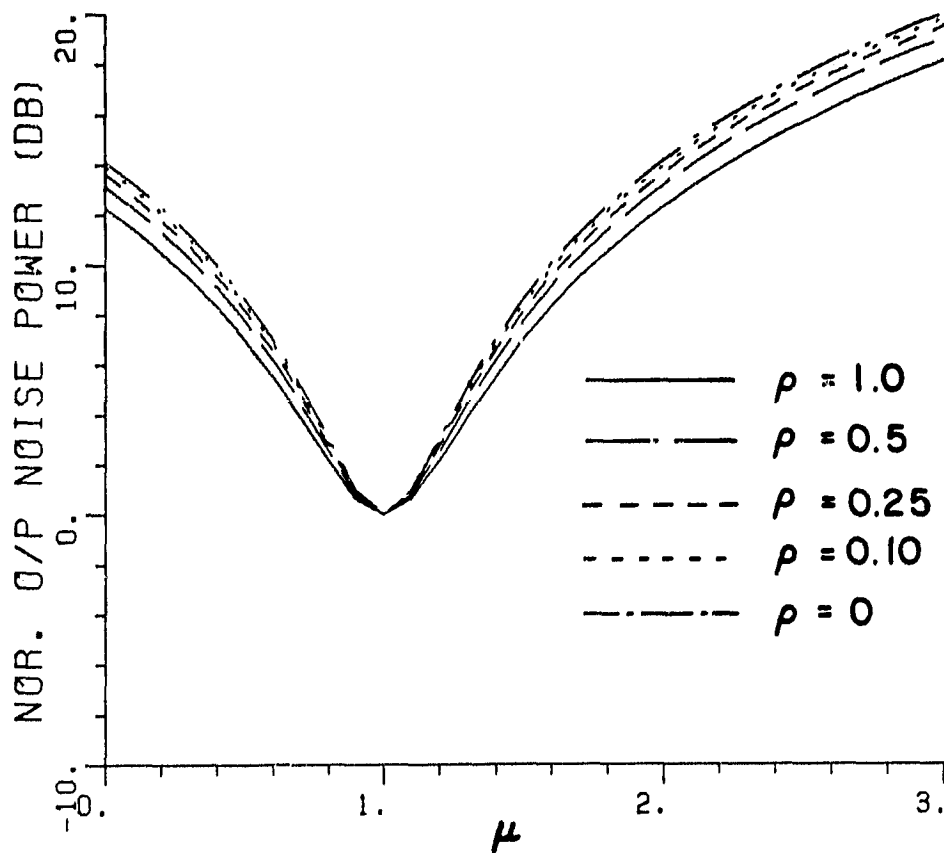

Figure 11. Normalized output noise power vs. μ .
 $\theta_d = 90^\circ$, $\xi_{dm} = 20$ dB, $\xi_{da} = 0$ dB,
 $\frac{G}{\alpha} = 100.$, No Jammer.

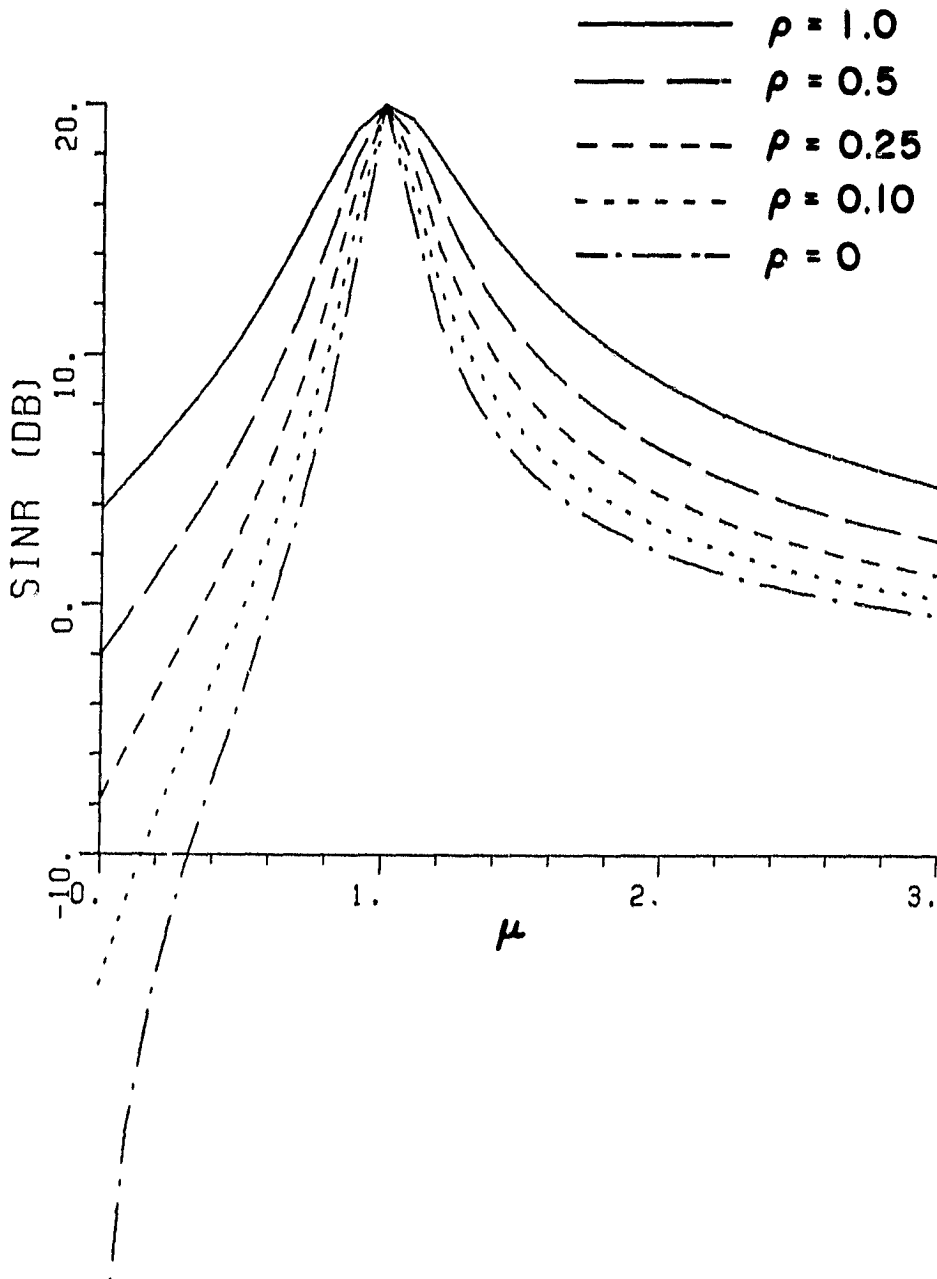

Figure 12. Output SINR vs. μ .
 $\theta_d = 90^\circ$, $\xi_{dm} = 20$ dB, $\xi_{da} = -10$ dB,
 $\frac{G}{\alpha} = 100.$, No Jammer.

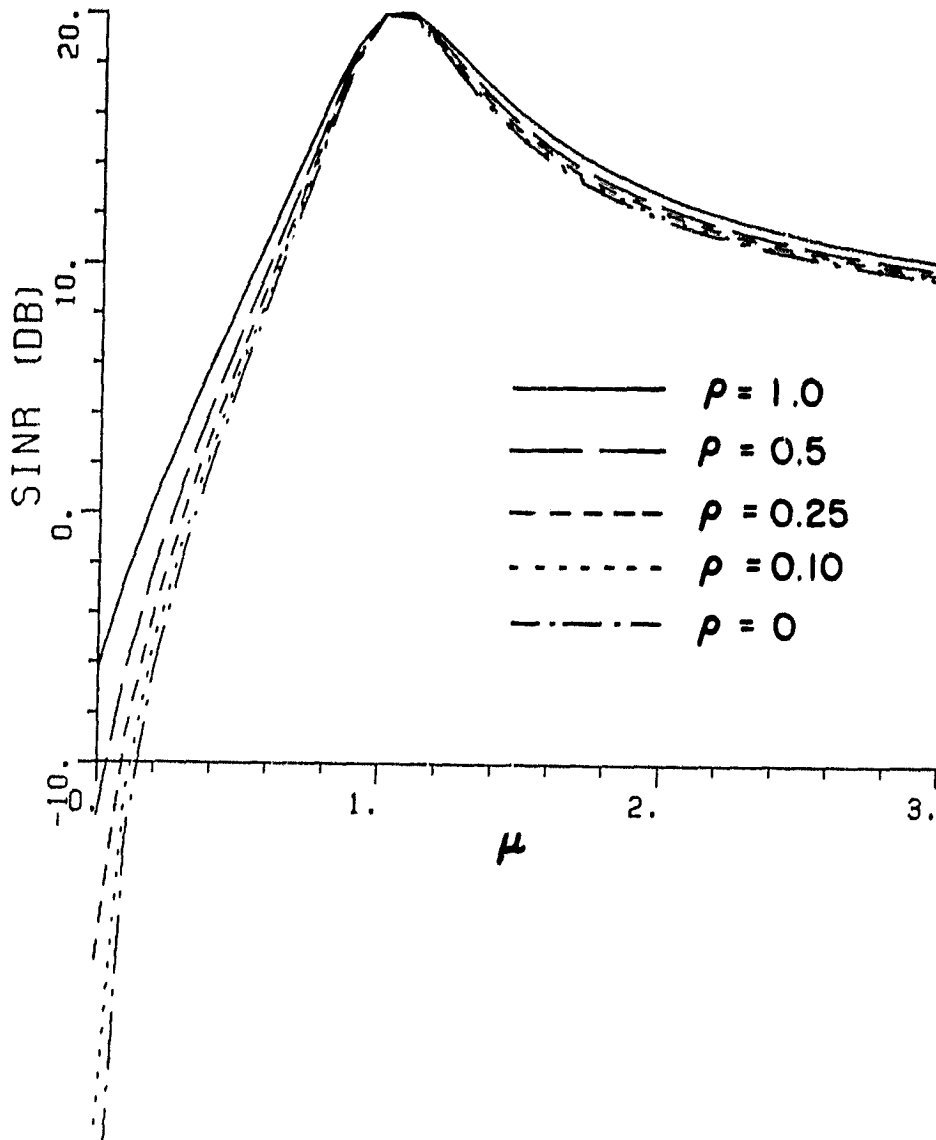

Figure 13. Output SINR vs. μ .
 $\theta_d = 90^\circ$, $\xi_{dm} = 20$ dB, $\xi_{da} = 0$ dB,
 $\frac{G}{\alpha} = 100.$, No Jammer.

perfect steering vector should be chosen. This restriction on the choice of steering vector, however, can be relaxed if one is dealing with strong desired signals in the auxiliary antennas which is quite obvious from the SINR plots in Figure 14.

In Figure 14, the output SINR of the array for various values of input SNR in the auxiliary antennas is plotted. The decorrelation factor is chosen to be zero in these plots and other parameters are the same as before. Note that the degradation in the output SINR for $\mu > 1$ decreases with an increase in the input SNR (ξ_{da}) in the auxiliary antennas. Thus, for strong desired signals in the auxiliary antennas one can use an imperfect steering vector ($\mu \neq 1$) provided that $\mu > 1$. The reason for the decrease in the SINR degradation with increased ξ_{da} is given below. However, first the performance of the array in the presence of an interfering signal is studied.

Figure 15 shows the output SINR of the array when an interfering signal is incident on the array from 30° off broadside. The input INR of the interfering signal on an isotropic element is -10 dB. Thus, the input INR at the main antenna is -7 dB. The auxiliary antenna elements gain in the interference source direction is assumed to be 13.5 dB. Thus, the input INR at the auxiliary antennas is 3.5 dB. This value of input INR at the auxiliary antennas yields 20 dB interference suppression. All other parameters are the same as in Figure 14. Comparing the plots in figures 14 and 15, one can see that the performance of the array in the presence of the interfering signal is the same as in the absence of the interfering signal. Thus, the

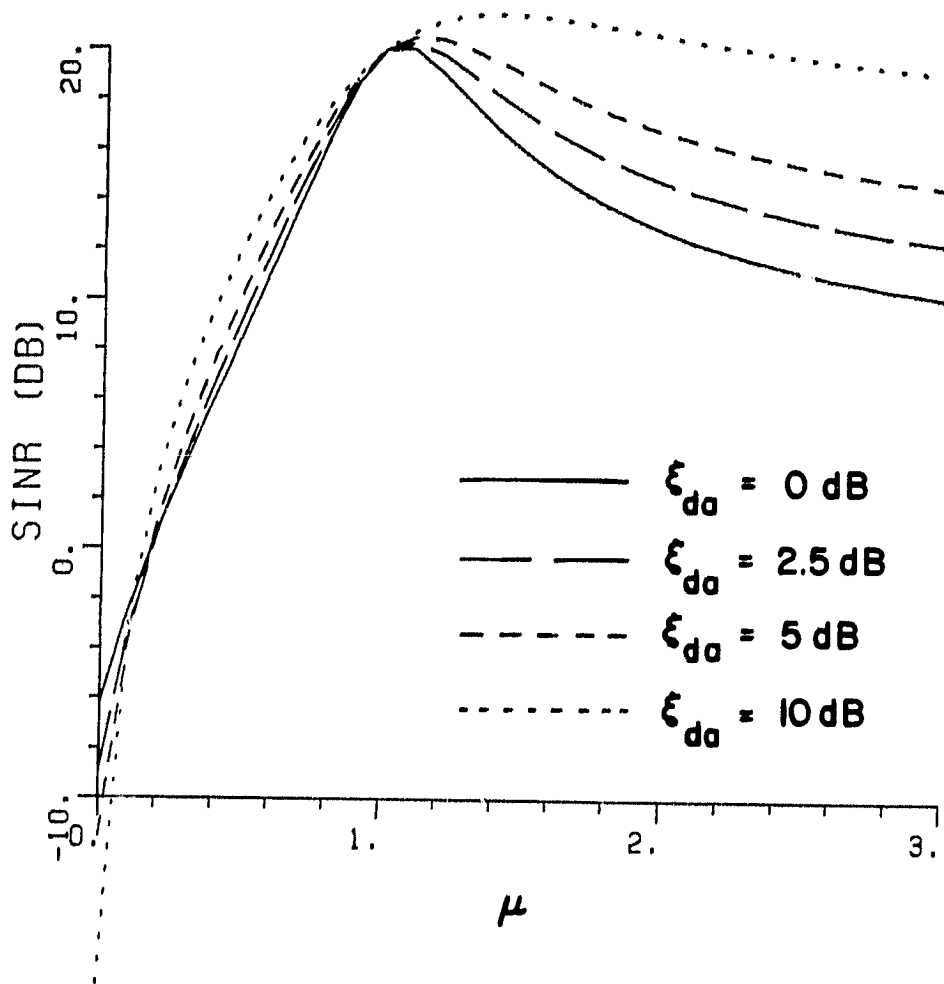

Figure 14. Output SINR vs. μ .
 $\theta_d = 90^\circ$, $\xi_{dm} = 20$ dB, ξ_{da} is varied,
 $G/\alpha = 100.$, $\rho = 1$, No Jammer.

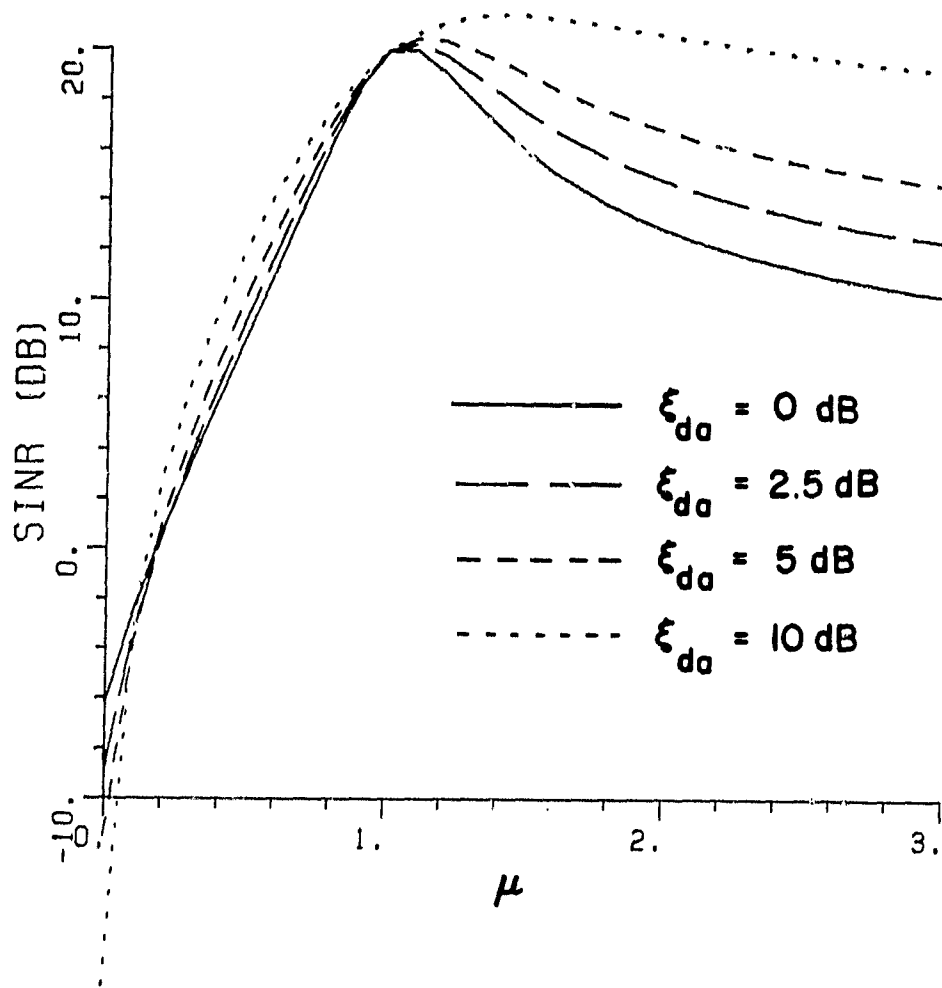

Figure 15. Output SINR vs. μ .
 $\theta_d = 90^\circ$, $\xi_{dm} = 20 \text{ dB}$, ξ_{da} is varied,
 $\theta_i = 60^\circ$, $\xi_{im} = -7 \text{ dB}$, $\xi_{ia} = 3.5 \text{ dB}$, $\frac{G}{\alpha} = 100$,
 $\rho = 1.0$.

degradation in the output SINR is independent of the interference. In the absence of all interfering signals, the steady state weight vector of the array is given by

$$\left[I + \frac{G}{\alpha} (\rho\sigma^2 I + \phi_d) \right] W = \frac{G}{\alpha} (1 - \mu) U_d \quad (34)$$

Let the desired signal be a narrowband signal. Then

$$\phi_d = A_{da} U_{da}^* U_{da}^T \quad (35)$$

$$\text{and } U_d = A_{dm} A_{da} U_{da}^* \quad (36)$$

where A_{da} is the desired signal amplitude in the auxiliary antenna, A_{dm} is the desired signal amplitude in the main antenna and U_{da} is the desired signal vector and defines the phase of the desired signal at various auxiliary antenna with respect to the desired signal phase at the phase center of the main antenna. Substituting (35) and (36) in (34), one gets

$$\left(1 + \frac{G}{\alpha} \rho\sigma^2 \right) \left[I + \frac{\frac{G}{\alpha} A_{da}^2}{1 + \frac{G}{\alpha} \rho\sigma^2} U_{da}^* U_{da}^T \right] W = \frac{G}{\alpha} (1 - \mu) A_{dm} A_{da} U_{da}^* \quad (37)$$

or,

$$W = K(1 - \mu) A_{dm} A_{da} \left[1 + K A_{da}^2 U_{da}^* U_{da}^T \right]^{-1} U_{da}^* \quad (38)$$

where,

$$K = \frac{G/\alpha}{1 + \frac{G}{\alpha} \rho \sigma} \quad (39)$$

Now

$$[I + KA_{da}^2 U_{da}^* U_{da}^T]^{-1} = (I - \frac{KA_{da}^2 U_{da}^* U_{da}^T}{1 + KA_{da}^2 U_{da}^* U_{da}^T}) \quad (40)$$

Substituting (40) in (38) and simplifying one gets

$$W = \frac{K(1 - \mu) A_{dm} A_{da}}{1 + KA_{da}^2 U_{da}^* U_{da}^T} U_{da}^* \quad (41)$$

Using these weights, the output desired signal power and the output noise power can be computed. The output desired signal power is

$$P_d = \frac{1}{2} \left| A_{dm} - A_{da} U_{da}^T W \right|^2 \quad (42)$$

and the output noise power is

$$P_n = \frac{1}{2} \left| \sigma_0^2 + \sigma^2 W^T W^* \right| \quad (43)$$

where the various parameters are as defined before. From (39), it is clear that the factor K depends on ρ . It increases with a decrease in ρ . For $\rho = 1$,

$$K = \frac{G/\alpha}{1 + \frac{G}{\alpha} \rho \sigma} \approx \frac{1}{\sigma^2} \quad (44)$$

In (44), we have assumed that $\frac{G}{\alpha} \sigma^2 \gg 1$ which is normally true. For other values of ρ , K will be greater than its value in (44). Now, for strong desired signals in the auxiliary antennas

$$1 + KA_{da}^2 U_{da}^T U_{da}^* \approx KA_{da}^2 U_{da}^T U_{da}^* \quad (45)$$

and from (41),

$$W = \frac{(1 - \mu) A_{dm}}{A_{da}} \frac{U_{da}^*}{U_{da}^T U_{da}^*} \quad (46)$$

Using (46) in (42) and (43), the output desired signal power is

$$P_d = \frac{1}{2} \mu^2 A_{dm}^2 \quad (47)$$

and the output noise power is

$$P_n = \frac{1}{2} \left| \sigma_0^2 + \sigma^2 \frac{(1 - \mu)^2 A_{dm}^2}{A_{da}^2 U_{da}^T U_{da}^*} \right| \quad (48)$$

Note that the output desired signal power is fixed while the noise power decreases with an increase in the desired signal in the auxiliary antenna. Thus, the output SINR will increase with an increase in the desired signal power in the auxiliary antennas. Further, for $\mu > 1$, the

desired signal power as well as the noise power increase with an increase in the value of μ . However, for strong desired signal in the auxiliary antennas, the increase in the noise power will not be large. Thus, the drop in the output SINR for $\mu > 1$ will not be significant. Hence for strong desired signals, one can use an imperfect steering vector.

In this section, the effects of the errors ($\mu \neq 1$) in the steering vector on the performance of a sidelobe canceller were studied. It was shown that when the desired signal in the auxiliary antennas is relatively weak, the output SINR degrades sharply with an increase in $|1 - \mu|$. The output SINR degrades because the auxiliary antennas add excessive amount of thermal noise to the array output. Thus, for the optimum performance the steering vector should be perfect ($\mu \approx 1$). For relatively strong desired signals in the auxiliary antennas, the degradation in the output SINR, specially for $\mu > 1$, was small. In this case, the enhancement in the desired signal due to auxiliary antennas makes up for the thermal noise added by the auxiliary elements. Thus, some error in the steering vector can be tolerated provided $\mu > 1$. Next, the desired signal level (A_{da}) in the auxiliary antennas above which the degradation in the output SINR, for $\mu > 1$, is small is computed.

From (43), it is clear that the output noise power will increase with an increase in the magnitude of the weight vector. We will compute the value of A_{da} for which the magnitude of the weight vector and thus the output noise is maximum. Differentiating (41) with respect to A_{da} one gets,

$$\frac{dW}{dA_{da}} = K(1 - \nu) A_{dm} \left\{ \frac{(1 + KA_{da}^2 U_{da}^T U_{da}^*) - 2KA_{da} U_{da}^T U_{da}^*}{(1 + KA_{da}^2 U_{da}^T U_{da}^*)} \right\} U_{da}^* \quad (49)$$

At a maximum,

$$\frac{dW}{dA_{da}} = 0 \quad (50)$$

and from (49)

$$1 - KA_{da}^2 U_{da}^T U_{da}^* = 0$$

$$\text{or, } A_{da}^2 = \frac{1}{K U_{da}^T U_{da}^*} \quad (51)$$

Substituting K from (39) in (51), one gets

$$A_{da}^2 = \frac{1 + \frac{G}{\alpha} \rho \sigma^2}{\frac{G}{\alpha} U_{da}^T U_{da}^*} \quad (52)$$

or

$$\epsilon_{da} = \frac{\frac{\alpha}{G\sigma^2 + \rho}}{U_{da}^T U_{da}^*} \quad (53)$$

where $\epsilon_{da} = \frac{A_{da}^2}{\sigma^2}$ is the input SNR in the auxiliary antennas. For large $\frac{G}{\alpha} \sigma^2$, (52) can be approximated as

$$\epsilon_{da} \approx \frac{\rho}{U_{da}^T U_{da}^*} = \frac{\rho}{N} \quad (53)$$

where N is the number of auxiliary antennas. For ξ_{da} greater than this value, the output noise power will decrease with an increase in ξ_{da} and one can use an imperfect steering vector. Such a large value of the input SNR in the auxiliary antennas may not be obtainable, especially if the auxiliary elements are directive antennas with their main beam in the interference source direction. Hence some alternative schemes to maintain the output SINR should be developed. Such a scheme is discussed next. In the scheme, the main antenna also has an adaptive feedback loop controlling its weight. Thus, there are $N + 1$ feedback loops, or, the array is a fully adaptive array and is no longer operating in the sidelobe canceller mode.

V. FULLY ADAPTIVE ARRAY

Figure 16 shows a typical fully adaptive array. The main antenna is highly directive and is steered in the desired signal direction. The auxiliary antennas are relatively low gain antennas and may have uniform radiation patterns in the given sector or may be directed towards the source of interference. Note that the only difference between this configuration and the sidelobe canceller [1] discussed above is that the main antenna output is also adaptively weighted. In Figure 16, the output of each antenna (main as well as auxiliary) is multiplied by a complex weight, w_i , and then all these signals are summed to form the output signal. Figure 17 shows a typical feedback loop used to control the weight of each antenna. There are $N + 1$ such feedback loops, where N is the number of auxiliary antennas. In Figure 17, u_{sj} is the i th component of the control signal. From Figures 16 and 17,

$$\frac{dw_i}{dt} + \alpha w_i = G (u_{sj} - \sum_{i=0, 1, 2, \dots, N} \tilde{y}_i X^T W) \quad (54)$$

where α is the pole position of the low pass filter and controls its (filter) bandwidth, G is the loop gain, X is an $N+1$ element column vector defining the input signals in various antennas, W is an $N+1$ element column vector defining the weights of various antenna elements and

$$\tilde{y}_i = \tilde{x}_i^* \quad (55)$$

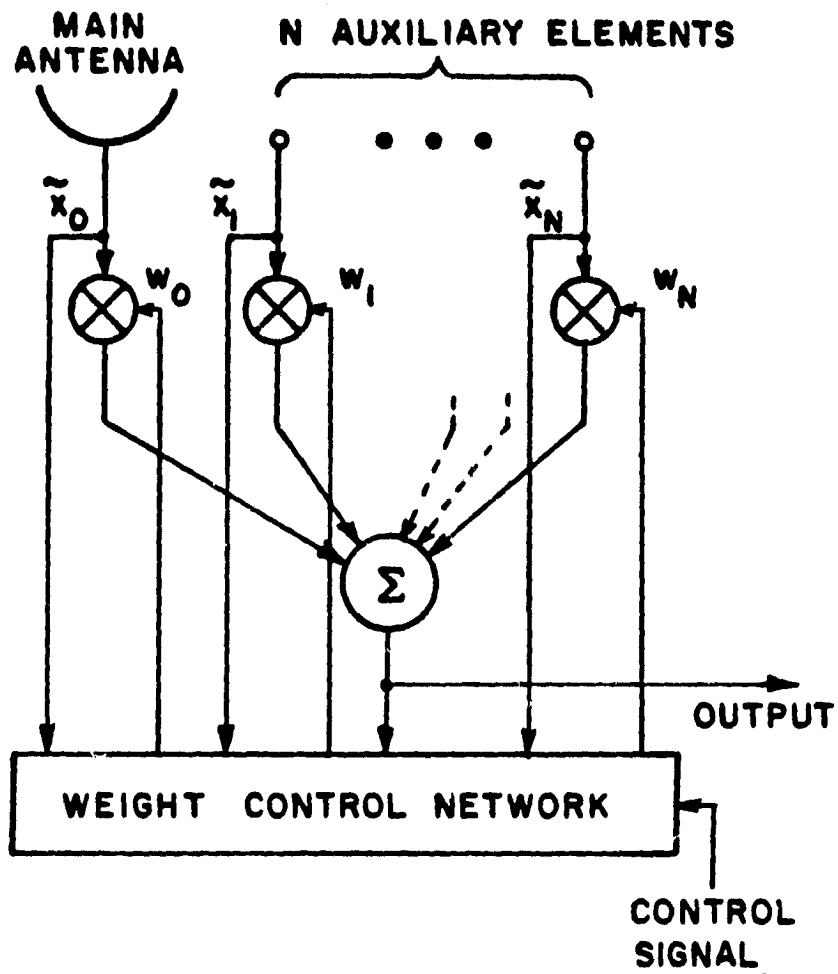

Figure 16. A fully adaptive steered beam adaptive array.

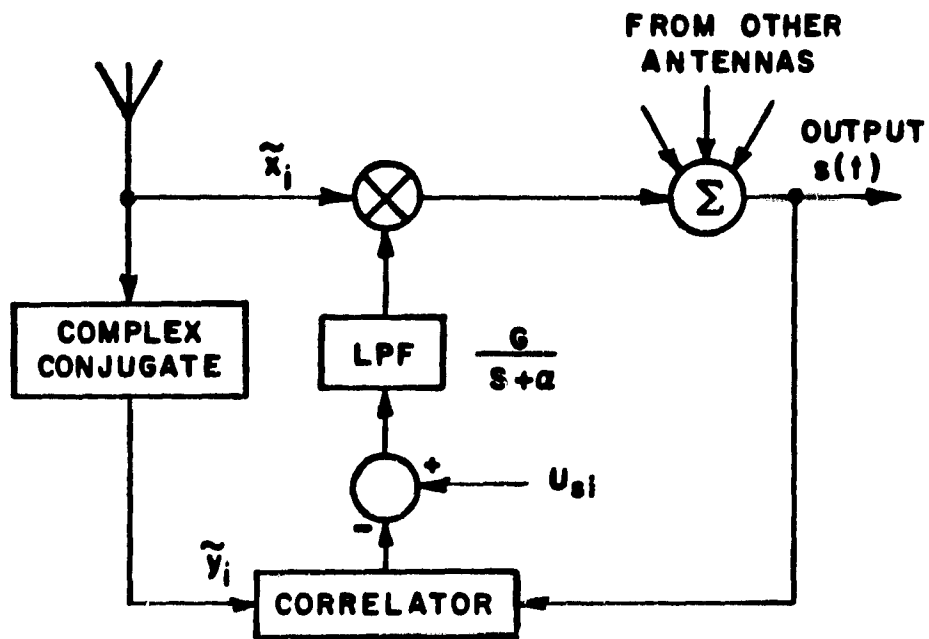

Figure 17. A typical feedback loop of a fully adaptive array.

where \tilde{x}_i is the signal in the i^{th} antenna element ($i=0$ means main antenna). In this work, analytical signal representation is used. For all antennas, the differential equation governing the antenna weights (59) can be written in vector form.

$$\frac{dW}{dt} + \alpha W = G(U_S - X X^* W) \quad (56)$$

where U_S is the control signal and will be called the steering vector. Assuming that the signals present in the antennas are ergodic processes and the weights of the adaptive array follow relatively slow changes in the signal scenario, (56) can be approximated as

$$\frac{dW}{dt} + (\alpha I + G\phi) W = GU_S \quad (57)$$

where

$$\phi = E\{X^* X^T\} \quad (58)$$

is a covariance matrix defining the correlation between the signals present on various antennas, $E\{\cdot\}$ denotes ensemble average and I is a $N+1 \times N+1$ identity matrix. In steady state,

$$\frac{dW}{dt} = 0 \quad (59)$$

and from (57),

$$(\alpha I + G\phi) W = GU_S \quad (60)$$

Knowing the signal scenario, one can compute the covariance matrix Φ and the steady state weights can be found. In practice, the signal $\tilde{x}_i(t)$, $i=0, 1, 2, \dots, N$ consists of a desired signal, interfering signals and thermal noise. Assuming that the various signals incident on the array are uncorrelated with each other and with the noise, and the noise voltages in various antennas are uncorrelated with each other and are zero mean gaussian with variance σ^2 , one can write (60) as

$$[\alpha I + G(\sigma^2 I + \Phi_d + \sum_{i=1}^M \Phi_i)] W = GU_s \quad (61)$$

where Φ_d is the covariance matrix due to the desired signal present at various antennas and Φ_i , is the covariance matrix due to the i^{th} interfering signal. To compute the weights (61), the steering vector should also be defined. Let the steering vector be chosen so that it is proportional to the correlation of the desired signal present in the various antennas with the desired signal in the main antenna[†], i.e.,

$$U_s = \mu U_d \quad (62)$$

where U_d is a correlation vector defining the correlation of the signal present in various antennas (main as well as auxiliary) with the desired signal in the main antenna, and μ is an arbitrary constant. Note that one should know the desired signal direction and its relative amplitude

[†] This steering vector is proportional to the correlation vector in LMS adaptive arrays, and thus will yield the maximum output SINR.

at the various antenna elements to choose a correct steering vector. In the case of ground station or satellite receive antennas, the location of the desired signal source is known and one can find the relative amplitude of the desired signal at various antennas by knowing their gain in the desired signal direction. Using (61) and (62), the steady state weights of the adaptive array can be computed and its performance can be evaluated. The desired signal power at the output junction is

$$S_d = \frac{1}{2} \left| X_d^T W \right|^2 \quad (63)$$

where X_d is an $N+1$ element column vector defining the desired signal in various antennas. The interference power at the output port is

$$S_j = \frac{1}{2} \sum_{i=1}^M \left| X_i^T W \right|^2 \quad (64)$$

where X_i is an $N+1$ column vector defining the i th interfering signal in various antennas. The noise power at the output port is

$$S_n = \frac{1}{2} \sigma^2 \left| W^T W \right| \quad (65)$$

First, we will discuss the effect of the factor μ on the array performance. From (61) and (62), it is clear that the magnitude of the array weights will be scaled up or down with μ . Thus, the level of various signals at the output port will change with a change in μ . However, all signals (eqs. 63, 64, 65) will be scaled up or down by the same factor and thus the output SINR will not be affected, or, the

output SINR in the case of a fully adaptive array, in contrast to a sidelobe canceller, is independent of μ . The interference suppression capabilities of the array are discussed next.

Figure 18 shows the normalized output interference power of an adaptive array consisting of four auxiliary antennas. The main antenna assumed to be a linear array of ten isotropic antennas is steered along broadside (the desired signal direction). The interelement spacing is half a wavelength. The auxiliary antennas are also assumed to be isotropic radiators with interelement spacing of half a wavelength. This particular distribution is chosen to demonstrate the basic principle and represents a satellite communication system where the interfering signals are nearly planar with the desired signal. Note that the element distribution is the same as discussed before (sidelobe canceller) except that the array is a fully adaptive array.

The input SNR in the main antenna is assumed to be 20 dB while in the auxiliary antennas it (the input SNR) is 0 dB†. The interfering signal scenario consists of a single CW signal incident from 30° off broadside to the main antenna. The main antenna has a -17 dB sidelobe in this direction, i.e., if the desired signal is incident from this direction, its SNR in the main antenna will be 3 dB instead of 20 dB. Due to the sidelobe structure, the input INR in the main antenna is assumed to be 3 dB higher than its value at an isotropic antenna (auxiliary antennas). The output INR is plotted as a function of the

† The noise is assumed to be receiver thermal noise and the noise power in the main antenna is the same as in the auxiliary antennas.

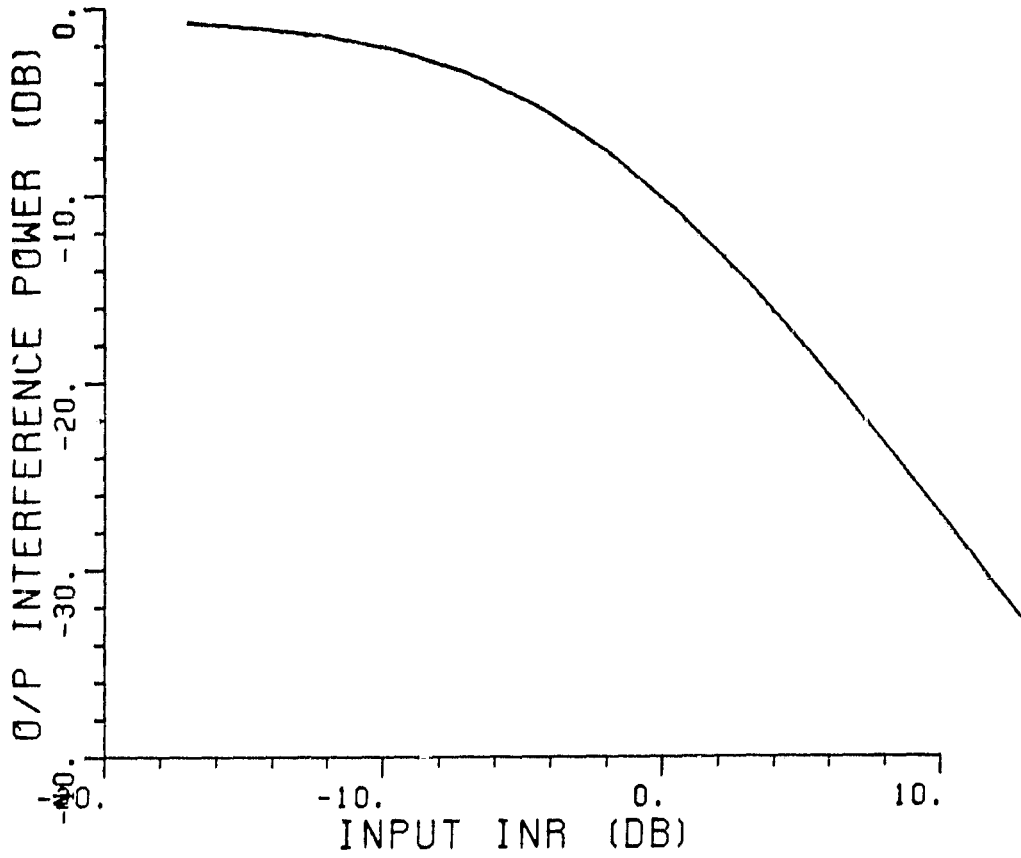

Figure 18. Normalized output interference power of a fully adaptive array vs. the input INR in the main antenna. $\theta_d = 90^\circ$, $\theta_i = 60^\circ$, SNR (main antenna) = 20 dB, SNR (auxiliary antenna) = 0 dB, $\frac{G}{\alpha} = 100$, $\mu=1$.

input INR in the main antenna. μ is chosen to be unity in the plot. Normalized interference power (normalized with respect to the interference power at the input of the main antenna) is plotted. Note that for weak interfering signals (INR < -10 dB), the interference power at the array output is approximately the same as that at the input of the main antenna. Thus, the interfering signal is not suppressed by the array. The interference power plot is similar to that of the sidelobe canceller [Ref. 1, Fig. 3], which is reproduced in Figure 19. The reason for the lack of interference suppression is that the interfering signal is very weak (below thermal noise) and thus adaptive array just ignores it and adjusts its weights to minimize the output thermal noise which leads to maximum output SINR.

In Figure 18, as the input INR increases, the output interference power decreases. Thus, the array is suppressing the interfering signal. For strong interfering signals ($\xi_j > 5$ dB), the interfering signal goes through a power inversion (the output interference power is inversely proportional to the input interference power). The fully adaptive array, therefore, like the sidelobe canceller, suppresses strong interfering signals. In the case of earth station or satellite receive antennas, the input INR is -15 to 5 dB and the interfering signals are to be further suppressed by 20-30 dB. Thus, one must suppress relatively weak interfering signals. To accomplish this, the feedback loops must be modified.

As suggested for the sidelobe canceller, one can modify the feedback loops such that the noise component of the signal $\tilde{y}_i(t)$

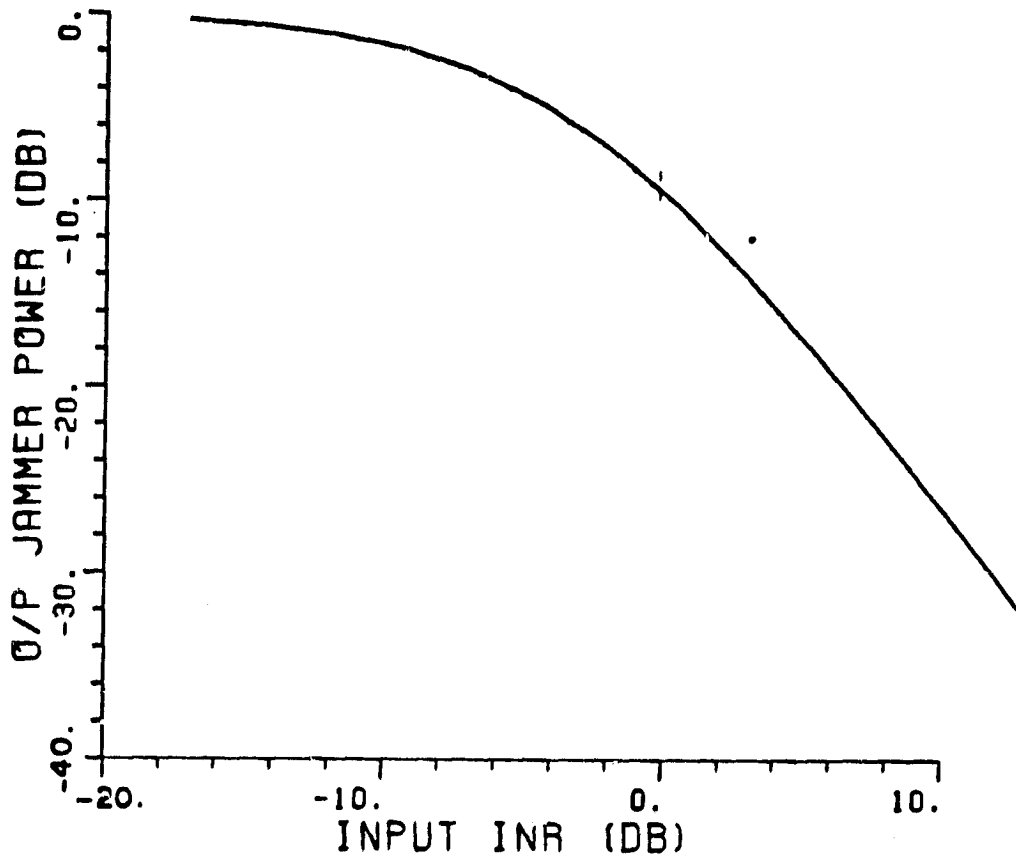

Figure 19. Normalized output jammer power of a sidelobe canceller vs. the input INR in the main antenna. $\theta_d = 90^\circ$, $\theta_j = 60^\circ$, SNR (main antenna) = 20 dB, SNR (auxiliary antenna) = 0 dB, $G/\alpha = 100$.

(Figure 17) is uncorelated with the noise component of the output signal $S(t)$. If the noise voltages in the two signals are partially correlated, then the noise power at the input of the low pass filter will be small and thus the interfering signals will control the array weights. One can use different techniques discussed in reference 1 to decorrelate the noise in the two signals. If the modified feedback loops are used to control the array weights, the steady state weight vector of the array will be given by

$$\left[\alpha I + G(\rho \sigma^2 I + \Phi_d + \sum_{i=1}^M \Phi_i) \right] W = GU_s \quad (66)$$

where ρ is the correlation between the two noise voltages. Note that $0 < \rho < 1$. Let us define a decorrelation factor F ,

$$F = 1 - \rho \quad , \quad 0 < \rho < 1 \quad . \quad (67)$$

Note that $0 < F < 1$ and if $F=0$, then the noise in the two signals is fully correlated and if $F=1$, the noise has been completely decorrelated.

Figure 20 shows the normalized output interference power of the four auxiliary elements adaptive array vs. F . All the parameters are the same as in Figure 18 except that modified feedback loops are used to control the array weights. The plots are given for various values of the input INR. Comparing the performance of the array with a sidelobe canceller (Figure 3), one can see that the two provide the same interference suppression. For weak interfering signals ($\text{INR} < -10 \text{ dB}$),

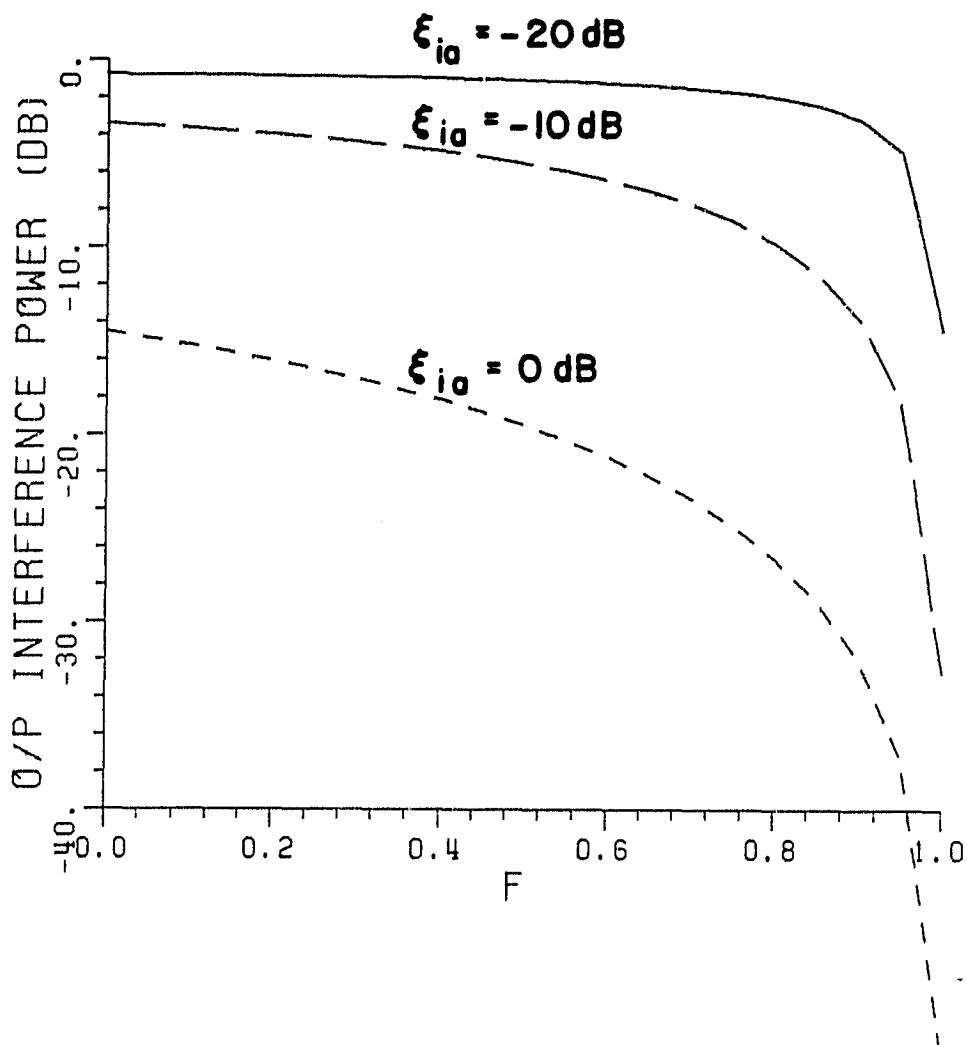

Figure 20. Normalized output interference power vs. the decorrelation factor of a fully adaptive array. $\theta_d = 90^\circ$, $\xi_{dm} = 20$ dB, $\xi_{da} = 0$ dB, $\xi_{im} = \xi_{ia} + 3$ dB, $G/\alpha = 100$, $\mu = 1$.

one needs a very low correlation between the two noise voltages for any significant interference suppression. For example, for a -10 dB interfering signal, the decorrelation factor should be 0.95 to achieve a 20 dB jammer suppression (output normalized jammer power would be -20 dB). Decorrelating the noise to such an extent may not be possible. Thus, other methods of interference suppression should be explored.

In the case of adaptive antenna arrays, for weak interfering signals, the thermal noise is the main source of degradation in the output SINR and thus controls the array weights. Since the noise in the main antenna is uncorrelated with the noise in the auxiliary antennas, it can not be cancelled with the noise in the auxiliary antennas. Thus, the only way for the array to minimize the noise at the array output and consequently maximize the output SNR is to shut off the auxiliary antennas, i.e., make $w_i, i=1,2,3 \dots N=0$. This choice of weight vector minimizes the noise. However, the interfering signal remains unsuppressed. By decorrelating the noise voltages in the feedback loops, the directional signals (interference and desired signals) are made more effective and thus control the array weights. For perfectly decorrelated noise ($\rho=0$), only these signals control the array weights and the interfering signals are suppressed. Another way to increase the effect of interfering signal on the array weights, as pointed out in the case of sidelobe canceller, is to increase the magnitude of the interfering signals in the auxiliary antennas while keeping the thermal noise fixed. This can be easily achieved by using directive auxiliary antennas. If the direction of an interfering source is approximately

known, the auxiliary antenna elements can be pointed along the interference's direction. The interfering signal amplitude in the auxiliary antennas, therefore, will increase and the array weights will be chosen to suppress the interfering signals.

Figure 21 shows the output interference power of the 4-auxiliary elements adaptive array vs. F for various types of auxiliary antennas (the auxiliary antenna element gain in the direction of interfering signal is varied). The input INR at an isotropic antenna is chosen to be -10 dB. Thus, the INR at the main antenna is -7 dB while at an auxiliary antenna the input INR is -10 dB + the gain of the auxiliary antenna in the interference source direction. All other parameters are the same as in Figure 20. Note that for a given F (the decorrelation factor), the output interference power decreases with an increase in the auxiliary antenna element gain. Thus, by using directive auxiliary antennas, the interference suppression can be increased. Another important observation to be made from the plots of Figure 21 is that, as in the case of the sidelobe canceller, one can trade off the noise decorrelation with the gain of the auxiliary antennas. For example, for a 20 dB interference suppression, the decorrelation factor for isotropic auxiliary antennas is 0.95 while for 6 dB and 10 dB auxiliary antennas the decorrelation factors, respectively, are 0.82 and 0.56. Hence, the larger the auxiliary elements gain, the smaller the required noise decorrelation. Again following the same procedure as given in section III, one can find a relationship between these two quantities to achieve the desired interference suppression. Comparing the plots in Figure 4

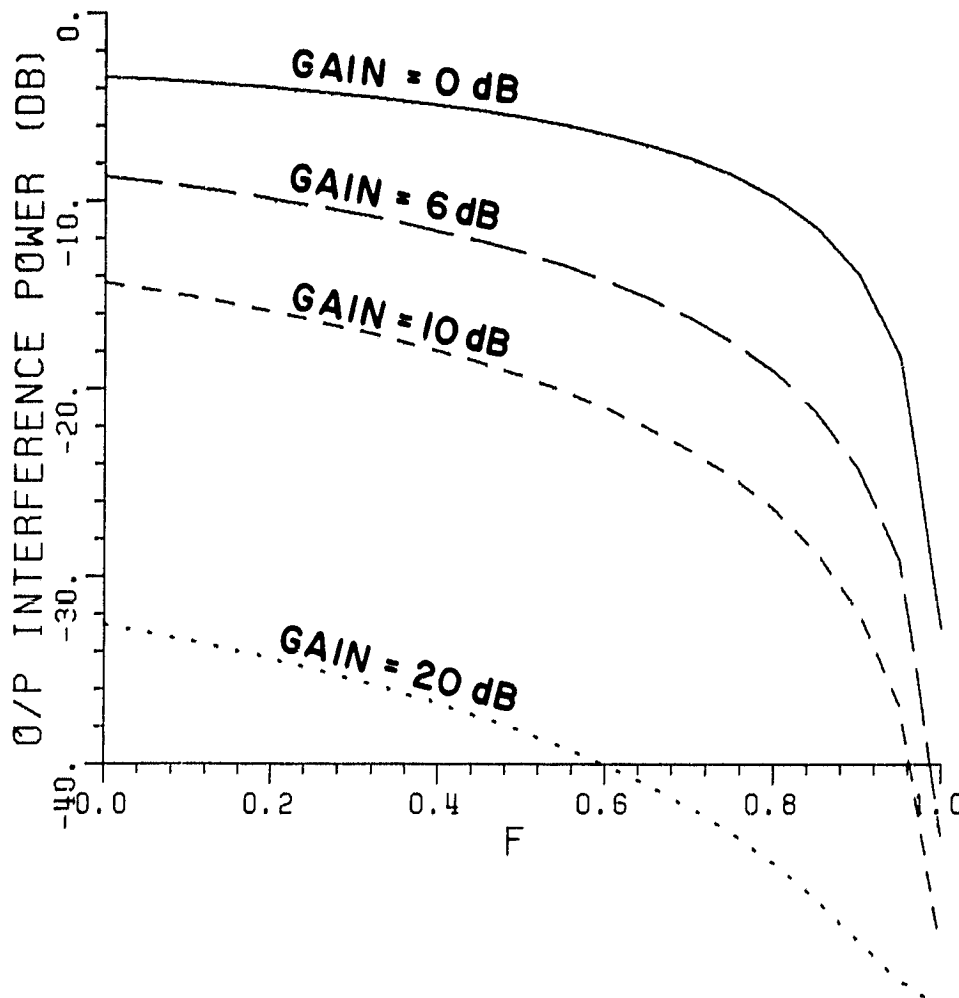

Figure 21. Normalized output interference power vs. the decorrelation factor for various auxiliary antennas. $\theta_d = 90^\circ$, $\xi_{dm} = 20$ dB, $\xi_{da} = 0$ dB, $\theta_j = 60^\circ$, $\xi_{im} = -7$ dB, $\xi_{ia} = -10 + \text{gain dB}$, $\frac{G}{\alpha} = 100$, $\mu = 1$.

can see that the same kind of relationship should exist. The effect of these two quantities on the output SINR is studied next.

Figure 22 shows that the output SINR of the array as a function of F . All parameters are the same in Figure 20. Note that the output SINR increases with an increase in the gain of auxiliary antennas and for highly directive antennas, the output SINR is almost independent of the decorrelation factor. For low gain auxiliary antennas, the output SINR decreases with an increase in the noise decorrelation. Comparing Figures 5 and 22, one can see that the performance of the adaptive array is similar to that of the sidelobe canceller. Therefore, the same argument can be used to explain the drop in the output SINR.

The drop in the output SINR is due to an increase in thermal noise at the output port, as shown in Figure 23. In Figure 23, the normalized output noise (normalized with respect to the noise in the main antenna) is plotted as a function of the decorrelation factor. Note that for low gain auxiliary antennas the total noise at the output port increases with an increase in the noise decorrelation (F). The output noise decreases with an increase in the gain of auxiliary antennas.

In the above discussion, the steering vector was chosen to be an exact replica of the desired signal correlation vector, i.e. $\mu=1$. However, since the desired signal correlation vector is a function of the desired signal strength which may not be known exactly and may fluctuate, μ may not be equal to one. Therefore, in general

$$U_s = \mu U_d \quad \mu > 0 \quad (68)$$

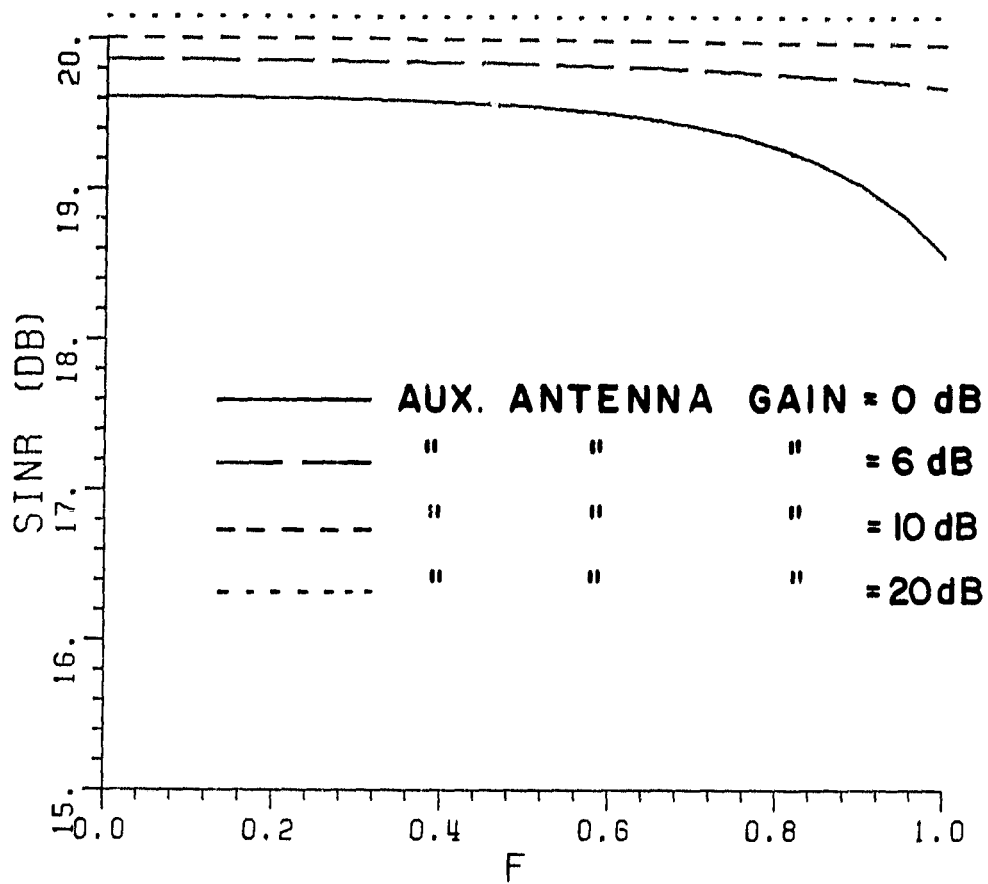

Figure 22. Output SINR vs. the decorrelation factor for various auxiliary antennas.

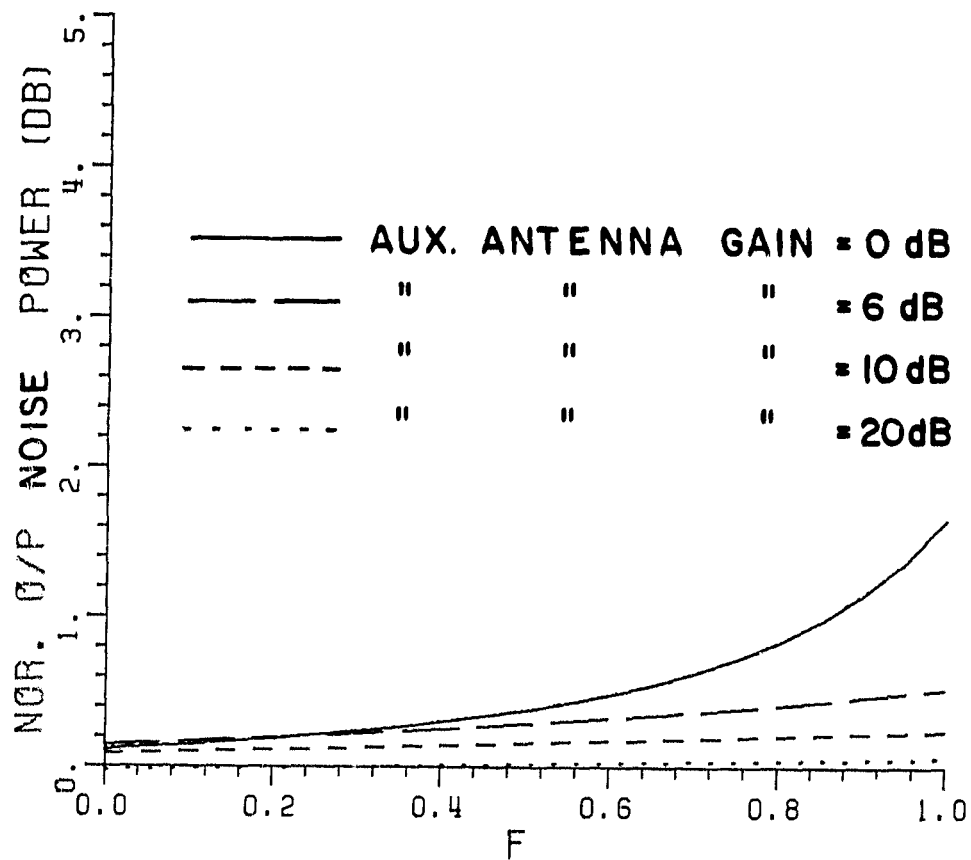

Figure 23. Normalized output noise power vs. the decorrelation factor for various auxiliary antennas.

Substituting (68) in (66) one gets

$$[\alpha I + G(\rho\sigma^2 I + \phi_d + \sum_{i=1}^M \phi_i)] W = G\mu U_d \quad (69)$$

Note that the weight vector magnitude will change with μ which in turn will affect the signal levels at the array output. However, all the signals will be scaled up or down by the same amount and, therefore, the output SINR will not be affected. Thus, the performance of the fully adaptive array, in contrast to the sidelobe canceller, is independent of the factor μ , i.e., no knowledge of the desired signal strength is required. However, as assumed in the above discussion, the angle of arrival of the desired signal should be known exactly. Any error in the estimation of the desired signal's direction will degrade the output SINR [3]. This is true for the sidelobe canceller as well as for the fully adaptive array. One should be aware of this fact while selecting the steering vector.

In this section, the performance of a fully adaptive steered beam adaptive array was studied. It was shown that the fully adaptive array provides the same interference suppression as the sidelobe canceller discussed in the previous sections. However, in contrast to the sidelobe canceller, the output SINR of the fully adaptive array does not degrade with errors in the steering vector. Thus, fully adaptive array seem to be a better choice. However, a fully adaptive array needs an extra feedback loop and one should decorrelate the noise in this feedback loop too. These factors should be considered while selecting an adaptive array for interference suppression.

VI. CONCLUSIONS AND RECOMMENDATIONS

The interference protection provided by adaptive antenna arrays to earth station or satellite receive antenna systems was studied. The special case where the interference was caused by transmission from satellites or earth stations whose signals inadvertently enter the receiving system and interfere with the communication link was considered. Thus, the interfering signals were significantly weaker than the desired signals and in fact were below the noise level by 5-10 dB. Conventional adaptive arrays are unable to suppress such interfering signals. The reason for lack of interference suppression is that for weak interfering signals, the thermal noise (sky noise and/or internal thermal noise) is the main source of degradation in the output SINR and thus it (thermal noise) controls the array weights. The array adjusts its weights to minimize the thermal noise and the interference is not suppressed.

In our previous work [1], we proposed a modification of the adaptive array which appears to overcome this difficulty. In the modified adaptive array, the noise level in the feedback loops is reduced. The noise level is reduced by reducing the correlation between the noise components of the two inputs to the loop correlator. In this work, the amount of noise decorrelation needed to achieve a specified interference suppression was computed. It was found that for a significant suppression of weak interfering signals, one may have to reduce the noise correlation to impractically low levels. For weak interfering signals, decorrelating the noise to such a low level also

degraded the output SINR. Alternate methods of interference suppression were, therefore, sought. It was suggested that when the directions of the sources of interfering signals are approximately known, one should replace low gain auxiliary antennas with high gain antennas and point their main beams along those directions. Thus, the interference signal level in the feedback loops will increase resulting in more interference suppression. The higher the gain of the auxiliary antenna the larger the interference suppression. Highly directive auxiliary antennas don't cause any degradation in the output SINR either.

For the signal scenarios considered in this work, the interfering signals are very weak (well below thermal noise). Therefore, to increase the interfering signal level in the auxiliary antennas to the desired level, one may need very large (electrically) auxiliary antennas. The auxiliary antennas may have to be larger than the main antenna. To avoid such a requirement a combination of two techniques (noise decorrelation and high gain auxiliary antennas) is recommended for interference suppression. Since directive auxiliary antennas will significantly increase the interfering signal levels in the feedback loops, the amount of noise decorrelation required to achieve the specified interference suppression will be within reasonable limits. A relationship between the amount of decorrelation required and the auxiliary antenna elements gain for the specified interference suppression was given.

The effects of errors ($\mu \neq 1$) in the steering vector on the output SINR were also studied. It was found that the sidelobe canceller is very sensitive to beam pointing errors. The output SINR of a sidelobe

canceller degrades sharply with small errors in the steering vector. The output SINR of the fully adaptive array on the other hand is insensitive to the beam pointing errors. Hence fully adaptive arrays are recommended for the interference suppression.

In this work, the incident signals were assumed to be narrowband signals. The performance of the array in the presence of wideband signals will be studied in the next phase of this work.

REFERENCES

- [1] I.J. Gupta and A.A. Ksienski, "Adaptive arrays for Satellite Communications", Technical Report 716111-1, The Ohio State University ElectroScience Laboratory, Dept. of Electrical Engineering, Prepared under Grant NAG3-536 for National Aeronautics and Space Administration/Lewis Research Center, Cleveland, Ohio.
- [2] S.P. Applebaum, "Adaptive Arrays", IEEE Trans. on Antennas and Propagation, Vol. AP-24, p. 585, September 1976.
- [3] R.T. Compton, Jr., "Pointing Accuracy and Dynamic Range in a Steered Beam Adaptive Array", IEEE Trans. on Aerospace and Electronic Systems, Vol. AES-16, p. 280, may 1980.