

Elsevier required licence: © <2018>. This manuscript version is made available under the CC-BY-NC-ND 4.0 license <http://creativecommons.org/licenses/by-nc-nd/4.0/>  
The definitive publisher version is available online at

[\[https://www.sciencedirect.com/science/article/pii/S1366554516303817?via%3Dihub\]](https://www.sciencedirect.com/science/article/pii/S1366554516303817?via%3Dihub)

# **Social media data analytics to improve supply chain management in food industries**

## **Abstract**

This paper proposes a big-data analytics-based approach that considers social media (Twitter) data for the identification of supply chain management issues in food industries. In particular, the proposed approach includes (i) the capturing of relevant tweets based on keywords, (ii) the pre-processing of the raw tweets, and (iii) text analysis using a support vector machine (SVM) and hierarchical clustering with multiscale bootstrap resampling. The result of this approach included a cluster of words which could inform supply-chain (SC) decision makers about customer feedback and issues in the flow/quality of food products. A case study in the beef supply chain was analysed using the proposed approach, where three weeks of data from Twitter were used. The results indicated that the proposed text analytics approach can be helpful to effectively identify and summarise crucial customer feedback for the supply chain management. This study proposes a holistic approach, in which social media data are utilised in the domain of the food supply chain. The findings of the analysis have been linked to all the segments of the supply chain.

Keywords – Beef Supply Chain, Twitter Data, Sentiment Analysis

## **1. Introduction**

In the modern era, food is a crucial commodity for consumers, as it has a direct impact on their health (Caplan, 2013; Swaminathan 2015; Tarasuk, et al., 2015). The food supply chain is more complicated than the manufacturing and other conventional supply chains, owing to the perishable nature of food products (La Scalia et al., 2015; Handayati et al., 2015). Food retailers aim to adjust their supply chain to become consumer centric (a supply chain designed as per the requirements of end consumers by addressing organisational, strategic, technology, process, and metrics factors) by taking into account various methods, including market surveys, market research, interviews, and offering the opportunity to consumers to provide feedback within the retailer store. However, food retailers are not able to attract large audiences by following these procedures; thus, their data sample is small. Any decisions made based on a smaller sample of customer feedback are prone to be ineffective. With the advent of online social media, there is substantial amount of consumer information available on Twitter, which reflects the true opinion of customers (Liang and Dai 2013; Katal et al., 2013). Effective analysis of this information can provide interesting insight into consumer sentiments and behaviours with respect to one or more specific issues. Using social media data, a retailer can capture a real-time overview of consumer reactions regarding an episodic event. Social media data are relatively inexpensive, and can be very effective in gathering the opinions of large and diverse audiences (Liang and Dai 2013; Katal et al., 2013). Using different information techniques, business organisations can collect social media data in real time, and can use it for the development of future strategies. However, social media data are qualitative and unstructured in nature, and are often large in volume, variety, and velocity (He et al., 2013; Hashem et al., 2015; Zikopoulos and Eaton, 2011). At times, it is difficult to

handle them using the traditional operation and management tools and techniques for business purposes. In the past, social media analytics have been implemented in various supply chain problems, predominantly in manufacturing supply chains. The research on the application of social media analytics in the domain of the food supply chain is in its primitive stage. In the present work, an attempt has been made to use social media data in the domain of the food supply chain to transform it into a consumer-centric supply chain. The results from the analysis have been linked with all the segments of the supply chain to improve customer satisfaction. For instance, the issues faced by consumers of beef products, such as discoloration, presence of foreign bodies, extra fat, and hard texture, have been linked to their root causes in the upstream of the supply chain. First, data were extracted from Twitter (via the Twitter streaming application programming interface (API)) using relevant keywords related to consumer opinion on different food products. Thereafter, pre-processing and text mining was performed to investigate the positive and negative sentiments of tweets, using a support vector machine (SVM). Hierarchical clustering of tweets from different geographical locations (world, UK, Australia, and the USA) using multiscale bootstrap resampling was performed. Furthermore, root causes of issues affecting consumer satisfaction were identified and linked with various segments of the supply chain to render it more efficient. Finally, recommendations for a consumer-centric supply chain were prescribed.

The organisation of the paper is as follows: Section 2 explores various issues associated with big-data applications, including Twitter and other social media platforms. In Section 3, a new framework of social-media data analytics adopted in this study is described in detail. Section 4 provides an implementation of the proposed framework on a case study in the beef supply chain. It also details the comparison of several sentiment-mining techniques, as well as their results. Section 5 comprises the identification of issues affecting consumer satisfaction and their respective means of mitigation within the supply chain. Section 6 explains the managerial implications on the supply chain decisions. Finally, the paper is concluded in Section 7.

## **2. Related work**

In literature, distinct frameworks have been proposed for the investigation of big-data problems and issues associated with the supply chain. Hazen et al., (2014) have determined the problems associated with the quality of data in the field of supply chain management. Novel procedures for the monitoring and the managing of data quality have been suggested. The importance of the quality of data in the application and further research in the field of supply chain management has been mentioned. Vera-Baquero et al. (2016) have recommended a cloud-based mechanism, utilising big-data procedures to efficiently improve the performance analysis of corporations. The competence of the framework was revealed in terms of delivering the monitoring of business activity comprising big data in real time with minimum hardware expenses. Frizzo et al., (2016) have performed a thorough analysis of the big-data literature available in reputed business journals. They considered 219 peer reviewed research papers, published in 152 business journals from 2009 to 2014. Both quantitative and qualitative investigation of the literature was performed by utilising the NVivo 10 software. Their investigation revealed that the research work conducted in the domain of big data is fragmented and primitive in terms of empirical analysis, variation in methodology, and theoretical grounding.

Twitter information has emerged as one of the most widely used data source for research in academia and practical applications. In the literature, there are various available examples associated with practical applications of Twitter information, such as brand management (Malhotra et al., 2012), stock forecasting (Arias et al., 2013) and crisis management (Wyatt, 2013). It is anticipated that there will be a swift expansion in the utilisation of Twitter information for numerous other purposes, such as market prediction, public safety, and humanitarian relief and assistance (Dataminr, 2014). In the past, Twitter data-based studies have been conducted in various domains. Most research work is conducted in the area of computer science for various purposes, such as sentiment analysis (Schumaker et al., 2016; Mostafa, 2013; Kontopoulos et al., 2013; Rui et al., 2013; Ghiassi et al. 2013; Hodeghatta & Sahney, 2016; Pak and Paroubek, 2010), topic detection (Cigarrán et al., 2016), gathering market intelligence (Li & Li, 2013; Lu et al., 2014; Neethu & Rajasree, 2013), and gaining insight of stock market (Bollen et al., 2011). There are various works which have been conducted in the domain of disaster management (Beigi et al. 2016), such as studies on dispatching resources in a natural disaster by monitoring real-time tweets (Chen et al., 2016) and on exploring the application of social media by non-profit organisations and media firms during natural disasters (Muralidharan et al., 2011). Analysis of Twitter data has also been conducted by researchers in the domain of operation management; such analyses include capturing big data in the form of tweets to improve the supply-chain innovation capabilities (Tan et al., 2015), investigating the state of logistics-related customer service which is provided by e-retailers on Twitter (Bhattacharjya et al., 2016), examining the process of service recovery in the context of operations management (Fan et al., 2016), developing a framework for assimilating social media into the supply chain management (Sianipar and Yudoko, 2014; Chae, 2015), determining the ranking of knowledge-creation modes by using extended fuzzy analytic hierarchy process (Tyagi et al., 2016), exploring the amalgamation of conventional knowledge management and the insights derived from social media (O'leary, 2011), improving the efficiency of the knowledge-creation process by developing a set of lean thinking tools (Tyagi et al., 2015a), and optimising the configuration of a platform via the coupling of product generations (Tyagi et al., 2015b).

Researchers have employed numerous methods for the extraction of intelligence from tweets, which are listed in detail in Table 1. For instance, Ghiassi et al., (2013) used n-gram analysis and artificial neural networks for determining sentiments of brand-related tweets. Their methodology offered improved precision in the classification of sentiments, and minimised the complexity of modelling as compared to conventional sentiment lexicons. However, their study was conducted by offsetting the false positives, and was performed on one single brand. Hence, the efficacy of the framework needs to be verified on other brands. Bollen et al., (2011) have utilised the Granger causality analysis and a self-organizing fuzzy neural network to analyse tweets for the measurement of the mood of people associated with the stock market. Their framework was sufficiently capable of measuring the mood of people along six distinct dimensions (such as calm, alert, sure, vital, kind, and happy) with an accuracy of 86.7%. Li & Li (2013) have developed a numeric opinion-summarisation framework for the extraction of market intelligence. The aggregated scores generated by the framework assisted the decision maker in effectively gaining insight into market trends through following the fluctuation in tweet sentiments. However, their study did not consider the synonymous terms while classifying the tweets into thematic topics, as different users might have used distinct terms in their tweets. For instance, a dictionary-based approach could be applied to incorporate all possible synonyms. Lu et al., (2014) proposed a visual analytics toolkit to gather data from Bitly and Twitter for the prediction of the ratings and

revenue generated by feature films. The advantages of the interactive environment for predictive analysis were demonstrated through statistical modelling methods, using results from the visual analytics science and technology (VAST) box-office challenge in 2013. The proposed framework was flexible to be used in other social media platforms for the analysis of advertisement and the forecasting of sales. However, the data-cleaning and sentiment analysis process employed was considerably challenging and became complicated for larger data sets. Mostafa (2013) applied lexicon-based sentiment analysis to explore the consumer opinion towards certain cosmopolitan brands. The text-mining techniques utilised were capable of exploring the hidden patterns of consumer opinions. However, their framework was quite oversimplified, and was not designed to perform some of the most prevalent analysis, such as topic detection. Tan et al., (2015) developed a deduction graph model for the extraction of big data to improve the capabilities for supply chain innovation. This model extracted and developed inter-relations among distinct competence sets, thereby generating opportunity for extensive strategic analysis of the capabilities of a firm. The mathematical methodology that was followed to achieve the optimum results was quite sophisticated and monotonous, considering that it was not autonomous. Chae, (2015) developed a Twitter analytics framework for the evaluation of Twitter information in the field of the supply chain management. An attempt was made by them to fathom the potential engagement of Twitter in the application of supply chain management, as well as in further research and development. This mechanism was composed of three procedures, which are known as descriptive analysis, network analysis, and content analysis. The shortcoming of this research was that data collection was performed using ‘#supply chain’ instead of keywords. Therefore, the data collected may not be the large enough for sentiment analysis. Bhattacharjya et al., (2016) implemented inductive coding to examine the efficiency of e-retailer logistics-specific customer service communications on social media (Twitter). Their approach illustrated informative interactions, and was able to distinguish with precision the beginning and conclusion of interactions among e-retailers and consumers. However, the data-mining mechanism which was utilised might have overlooked certain types of exchanges, which were relatively low in frequency. Kontopoulos et al., (2013) used formal concept analysis (FCA) to develop an ontology-based model for sentiment analysis. Their framework performed efficient sentiment analysis of tweets by differentiating the features of the domain and by allocating a respective sentiment grade to it. However, their framework was not sufficiently robust to deal with advertisement tweets. It was either considered as positive tweets or rejected by their mechanism, thereby reducing the precision of sentiment analysis. Similarly, Cigarran et al., (2016) also utilised the FCA approach for the analysis of tweets for topic detection. Although the FCA approach was quite efficient, it was not sufficiently robust to deal with tweets that presented lack of clarity; therefore, it created uncertainty on its ability to offer precise sentiment grades. Rui et al. (2013) used an amalgamation of the naive Bayes classifier and the SVM to explore the impact of pre-consumer opinion and post-consumer opinion on feature film sales data. The algorithms utilised by the researchers for sentiment analysis of tweets effectively classified sentiments into positive, negative, and neutral. The only limitation in their work is that the naive Bayes classifier is considered to be an oversimplified method; therefore, the accuracy of its results is not as appreciable compared to those of some of the more sophisticated tools which are currently available for sentiment analysis. Pak and Paroubek (2010) developed a Twitter corpus by gathering tweets via the Twitter API. The corpus was utilised to create a sentiment classifier derived from multinomial naive Bayes classifier (using n-grams and part-of-speech (POS) tags as features). This framework leaves room for error because only the polarity of emoticons was employed to label the tweet emotions in the training data set. Only the tweets with emoticons were available in the training data set, which rendered it fairly inefficient. Neethu & Rajasree,

(2013) utilised a machine-learning approach to investigate tweets on electronic products, such as laptops and mobile phones. A new feature vector was proposed for sentiment analysis, and it gathered intelligence on these products from the viewpoint of people. During the study, the researchers found that the SVM classifier yields results of higher accuracy than the naive Bayes classifier.

The application of social media data in the food supply chain is at a primitive stage. This study addresses the gap in the literature by analysing social media data to identify issues in the food supply chain and by investigating how these issues can be mitigated to achieve a consumer-centric supply chain. The consumer tweets regarding beef products were analysed through SVM and hierarchical clustering using multiscale bootstrap resampling to explore the major issues faced by consumers. For the accumulation of ultimate opinions, the subjectivity and polarity associated with the opinions were identified and merged into the form of a numeric semantic score (SS). The identified issues from the consumer tweets were linked to their root causes, in different segments of the supply chain. For instance, issues such as bad flavour, unpleasant smell, discoloration of meat, and presence of foreign bodies were linked to their root causes in the upstream of the supply chain, namely the beef farms, abattoir, processor, and retailer. The corresponding mitigation of these issues will be also provided in detail. The next section describes the Twitter data analysis process employed in the present work.

Table 1: Studies based on social media analytics in the literature

Area	Method	References
Sentiment analysis, topic detection and gathering market intelligence	Formal Concept Analysis (FCA), Descriptive statistics, ANOVA and t-tests, <i>n</i> -gram analysis and dynamic artificial neural network, numeric opinion summarization framework, Naive Bayesian classifier and support vector machine, lexicon-based Sentiment analysis, Granger causality analysis and a Self-Organizing Fuzzy Neural Network, Crowdsourced sentiment analysis	Schumaker et al., (2016); Mostafa, (2013); Kontopoulos et al., (2013); Rui et al., (2013); Ghiassi et al. (2013); Hodeghatta & Sahney, (2016); Cigarrán et al., 2016; Li & Li, (2013); Bollen et al., (2011), Lu et al., (2014); Neethu & Rajasree, (2013); Pak and Paroubek, (2010)
Disaster management	Implementation of a real-time tweet-based geodatabase, Content analysis.	Chen et al., (2016); Muralidharan et al., (2011).
Operation and Supply chain management	Descriptive analysis, Content analysis, Network analysis, Grounded theory approach, Inductive coding, sentiment analysis, Extended Fuzzy- AHP approach, Lean thinking, knowledge creation, DNA- based framework.	Chae, (2015); Tan et al., 2015; Fan et al. (2016); Tyagi et al., (2016); Bhattacharjya et al., (2016); Sianipar and Yudoko, (2014); O'leary, (2011), Tyagi et al., (2015a), Tyagi et al., (2015b)

### 3. Twitter data analysis process

In terms of social media data analysis, three major issues are considered: data harvesting/capturing, data storage, and data analysis. In the case of Twitter, data capturing starts with finding the topic of interest by using an appropriate keywords list (including texts and hashtags). This keywords list is used along with the Twitter streaming APIs to gather publicly available datasets from twitter postings. Twitter streaming APIs allow data analysts to collect 1% of the available Twitter datasets. There are other third-party commercial data providers, such as Firehose, which offer full historical twitter datasets.

Morstatter et al., (2013) demonstrated that the comparison between the data sample collected by Twitter streaming API and the full data stored by Firehose presented good agreement. This comparison was performed to test whether the data obtained by the streaming API is a good/sufficient representation of user activity on Twitter. Their study suggested that there are various ways of setting up the API to increase the representativeness of the data collected. One of the ways was to create more specific parameter sets through the use of bounding boxes and keywords. This approach can be used to extract more data from the API. Another key issue highlighted in their study was that the representation accuracy (in terms of topics) increased when the volume of data collected from the streaming API was large. Following these suggestions, we used set of specific keywords and regions to extract data from the streaming API in such a manner that data coverage, and consequently the representation accuracy, may be increased.

The Twitter streaming API allowed us to store/append twitter data in a text file. Then, a parsing method was implemented to extract datasets relevant to the present study (e.g. tweets, coordinates, hashtags, URLs, retweet count, follower count, screen name, favourites, location, etc.). Please refer to Figure 1 for details on the overall approach. The analysis of the gathered Twitter data is generally complex owing to the presence of unstructured textual information, which typically requires natural language processing (NLP) algorithms. To investigate the extracted Twitter data, we proposed two main types of content analysis techniques—sentiment mining and clustering analysis. More information on the proposed sentiment-mining method and hierarchical-clustering method will be presented in detail in the following subsections.

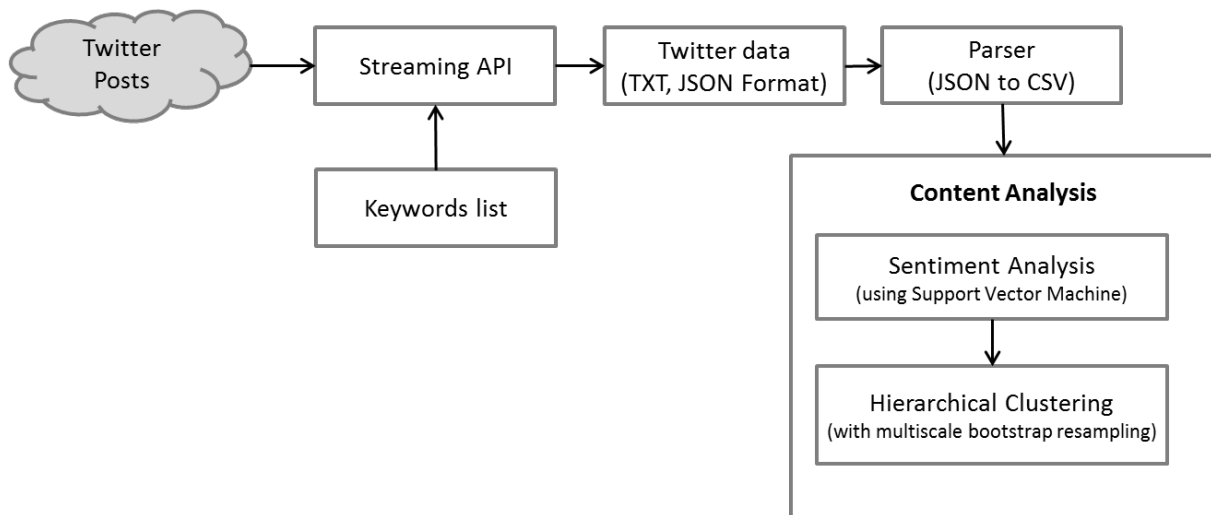

Figure 1: Overall approach for social media data analysis

### 3.1 Content Analysis

The information available on social media is predominantly in the unstructured textual format. Therefore, it is essential to employ content analysis (CA) approaches, which includes a wide array of text mining and NLP methods to accumulate knowledge from Web 2.0 (Chau and Xu, 2012). A tweet (with a maximum of 140 characters) comprises a small set of words, URLs, hashtags, numbers, and emoticons. Appropriate cleaning of the text and further processing is required for effective knowledge gathering. There is no optimal way to perform data cleaning, and several applications have used their own heuristics to clean the data. A text cleaning exercise, which included the removal of extra spaces, punctuation, numbers, symbols, and html links were used. Then, a list of major food retailers in the world (including their names and Twitter handles) was used to filter and select a subset of tweets, which are used for analysis.

#### 3.1.1 Sentiment analysis based on SVM

Tweets contain sentiments as well as information about the topic. Thus, sophisticated text-mining procedures, such as sentiment analysis, are vital for extracting true customer opinion. In the present work, the objective is to categorise each tweet as a one expressing either a positive or a negative sentiment.

Sentiment analysis, which is also widely known as opinion mining, is defined as the domain of research that evaluates public sentiments, appraisals, attitudes, emotions, evaluations, and opinions on various commodities, such as services, corporations, products, problems, situations, subjects, and their characteristics. It represents a broad area of issues. Several names exist to accommodate this concept, with minor differences, such as opinion mining, sentiment mining, sentiment analysis, opinion extraction, affect analysis, emotion analysis, subjectivity analysis, and review mining. Nonetheless, all these names are covered under the broad domain of opinion mining or sentiment analysis. In the literature, both terms, namely ‘opinion mining’ and ‘sentiment analysis’, are intermittently utilised.



In the proposed sentiment-mining approach, an opinion is elicited in the form of numeric values from a microblog (in text format). This approach identifies the subjectivity and polarity associated with the opinions, and merges them in the form of a numeric semantic score (SS) for the accumulation of ultimate opinions. The steps involved in this approach are the following:

*Identifying subjectivity from the text:* Although posts on microblogging websites are quite short in length, there are certain posts that comprise multiple sentences highlighting numerous subjects or views. The subjectivity of an opinion is investigated by determining the strength of an opinion for a topic. Bai (2005) and Duan and Whinston (2005) have classified opinions into subjective and objective opinions. Objective opinions reveal the basic information associated with an entity, and do not present subjective and emotional perspectives. On the other hand, subjective opinions represent personal viewpoints. As the purpose of this framework is to analyse Twitter user perspective on food products, subjective opinions are more crucial. People mostly utilise emotional words when describing their opinions, rather than objective information. Therefore, the opinion subjectivity (OS) of a post is defined as the average sentimental and emotional word density in every sentence of microblog  $m$ , which describes a topic  $t$  (in this study, we are examining words that are related to *beefsteak*).

The subjectivity level of opinions can be evaluated by developing a subjective word set which comprises sentimental and emotional words, and by expanding the word set through the use of WordNet. WordNet is a web-based semantics lexicon, and is the database of word synonyms and antonyms. In the present approach, a small set of seeds or sentiment words with defined positive and negative inclination was initially gathered manually. Then, the algorithm expanded this set by exploring an online dictionary, such as WordNet, for their respective synonyms and antonyms. The fresh words found were then transferred to the small set. Thereafter, the next iteration was initialised. This iterative procedure concluded when the search was complete, and no new words could be found. This approach was followed in the work of Hu and Liu (2004). Following this procedure, a subjective word set  $\phi$  was identified. The opinion subjectivity associated with a post  $m$  as per the topic  $t$ , denoted as  $OS_{m,t}$ , can be expressed as

$$OS_{m,t} = \frac{(\sum_{s \in S_t^m} \frac{|U_s \cap \phi|}{|U_s|})}{|S_t^m|} \quad (1)$$

where  $U_s$  denotes the set of unigrams contained in the sentence and  $S_t^m$  represents the set of sentences in tweet  $m$  which has the topic  $t$ .

*Sentiment classification module:* The identification of the polarity mentioned in the opinion is crucial for transforming the format of the opinion from text to numeric value. The performance of data-mining methods such as SVM is excellent for sentiment classification (Popescu & Etzioni, 2005). In the present approach, the SVM model was employed for the division of the polarity of opinions. The prerequisites for SVM are threefold. Initially, the features of the data must be chosen. Then, the data set utilised in training process needs to be marked with its true classes. Finally, the optimum combination of model settings and constraints needs to be calculated. The unigrams and bigrams are the tokens of one-word and two-word posts identified from the microblog, respectively. While there is a constraint on the length of the microblogging post, the probability of iterative occurrence of a characteristic in

the same post is quite low. As such, this study uses binary values  $\{0,1\}$  to represent the presence of these features in the microblog. The appearance of a feature in a message is denoted by '1', whereas the absence of a feature is denoted by '0'.

SVM is a technique for supervised machine learning, which requires a training data set to identify the best maximum-margin hyperplane (MMH). In the past, researchers have used approach where they have manually analysed and marked data prior to their use as training data set. Posts on a microblogging website are short; therefore, the number of features associated with them is also limited. In this case, we examined the use of emoticons to identify sentiments of opinions. In this study, Twitter data were pre-processed based on emoticons to create a training dataset for SVM. Microblogs with ':)' were marked as '+1', representing a positive polarity, whereas messages with ':(' were marked as '-1', representing negative polarity. It was observed that more than 89% messages (using a small sample of 1000 tweets) were manually marked with precision by following this procedure. Thus, the training data set was collected using this approach for SVM training. More specific details on the parameter values and associated details are provided in Section 4 where a case study is discussed. Then, a grid search (Hsu et al., 2003) was employed for the identification of the optimum combination of variables  $\gamma$  and  $c$  to carry out SVM with a Radial Basis Function kernel. The polarity ( $Pol_m \in \{+1, -1\}$ ), representing positive and negative sentiment of a microblog  $m$ , respectively, can be predicted using a trained SVM. Thus, the semantic score, SS, can be calculated by using the resultant subjectivity and opinion polarity on for a topic  $t$  via following equation:

$$SS_{m,t} = Pol_m \times OS_{m,t} \quad (2)$$

where  $SS_{m,t} \in [-1,1]$ .

In real life, when consumers buy beef products, they leave their true opinion (feedback) on Twitter. In this article, the SVM classifier was utilised to classify these sentiments into positive and negative, and consequently gather intelligence from these tweets.

### 3.1.2 Word and Hashtag analysis

Another type of content analysis that was conducted in the present work is word analysis. This type of analysis includes term frequency identification, summarisation of document, and word clustering. Term frequency is commonly utilised in text data retrieval and identification of word clusters and word clouds. These analyses can help to identify various issues under discussion in the tweets, as well as their relevance to the food supply chain management practices. Term frequency can help to extract popular hashtags and Twitter handles, which may offer information on the features and relevance of a tweet. Other types of analysis include machine-learning-based clustering and association rules mining. The association rules mining can help to identify associations of different terms that frequently occur in the tweets.

### 3.1.3 Hierarchical clustering with $p$ -values using multiscale bootstrap resampling

Once the semantic score is identified through the SVM and subjectivity identification, then hierarchical clustering method is applied individually to the tweets, which are positively and negatively scored. In this research, we employed a hierarchical clustering with  $p$ -values via multiscale bootstrap resampling (Suzuki and Shimodaira, 2006). The clustering method creates hierarchical clusters of words; moreover, it computes their significance using  $p$ -values

(obtained after the multiscale bootstrap resampling). This enables to easily identify significant clusters in the datasets and their hierarchy. The agglomerative method used was the ward.D2 (Murtagh and Legendre 2014). The pseudocode for the hierarchical clustering algorithm is presented in Fig 2.

$d_{i,j}$ : distance between cluster  $i$  and  $j$

$C$ : set of all clusters

$D$ : set of all  $d_{i,j}$

$n_i$ : number of data points in cluster  $i$

**Step 1:** Find smallest element  $d_{i,j}$  in  $D$

**Step 2:** Create new cluster  $k$  by merging cluster  $i$  and  $j$  (where  $i, j \in C$ )

**Step 3:** Compute new distances  $d_{k,l}$  (where  $l \in C$  and  $l \neq k$ ) as

$$d_{k,l} = \alpha_i d_{i,l} + \alpha_j d_{j,l} + \beta d_{i,j}$$

Compute number of data points in cluster  $k$  as  $n_k$  as

$$n_k = n_i + n_j$$

where,  $\alpha_i = \frac{n_i+n_l}{n_k+n_l}$ ,  $\alpha_j = \frac{n_j+n_l}{n_k+n_l}$ ,  $\beta = \frac{-n_l}{n_k+n_l}$  (Ward's minimum variance method)

**Step 4:** Repeat steps 1 to 3 until  $D$  contains a single group made of all data points.

Figure 2: Hierarchical Clustering Algorithm

Fig. 2 illustrates how the hierarchical clustering generates a dendrogram which contains clusters. However, the support of the data for these clusters was not determined using the method presented in Fig 2. One way to determine the support of data for these clusters is by adopting multiscale bootstrap resampling. In this approach, the dataset is replicated by resampling several times, and then the hierarchical clustering is applied (see Fig. 2). We conducted hierarchical cluster analysis with multiscale bootstrap with number of bootstrap equal to 1000. During resampling, the replicating of sample sizes was changed to multiple values including smaller, larger, and equal to the original sample size. Then, bootstrap probabilities are determined by counting the number of dendrograms which contain a particular cluster and by dividing it by the number of bootstrap samples. This procedure is performed for all the clusters and sample sizes. Then, these bootstrap probabilities are used for the estimation of the  $p$ -value, which is also known as approximately unbiased (AU) value.

The result from the hierarchical clustering with multiscale bootstrap resampling is a cluster dendrogram. At every stage, the two clusters which bear the highest resemblance are combined to form one new cluster, as presented in Fig. 2. The distance or dissimilarity between the clusters is denoted by the vertical axis of dendrogram. The various items and clusters are represented on horizontal axis, which also illustrates several values at the branches, such as the AU  $p$ -values (left), the bootstrap probability (BP) values (right), and the cluster labels (bottom). Clusters with an AU  $\geq 95\%$  are usually enclosed in red rectangles, which represent significant clusters (as depicted in Figure 4).

#### 4. Case study and Twitter data analysis

The proposed Twitter data analysis approach was used to understand issues related to the beef/steak supply chain based on consumer feedback on Twitter. This analysis can help to analyse the reasons behind positive and negative sentiments, to identify communication patterns, prevalent topics and content, and characteristics of Twitter users discussing about beef and steak. Based on the result of the proposed analysis, a set of recommendations were prescribed for the development of a customer-centric supply chain.

The total number of tweets extracted for this research was 1,338,638 (as per the procedure discussed in Section 3). They were captured from 23/03/2016 to 13/04/2016 using the keywords ‘beef’ and ‘steak’. Only tweets written in the English language were considered, with no geographic constraint. Figure 3 illustrates the location of tweets, and presents the geolocation data on the world map. Then, keywords were selected to capture the tweets relevant to this study. In order to select the keywords, on-site visits were carried out to various main and convenience retail stores in the UK, to discover the different negative and positive feedback left by the consumers with respect to beef products. We conducted interviews with the retail-store staff members dealing with consumer complaints, who provided access to databases of consumer complaints regarding beef products. Interviews of certain consumers were also conducted to explore the type of keywords used by them to express their view. The research team involved in this article also investigated the various complaints made by consumers to the store, worldwide. Different keywords employed on Twitter for beef products were captured and discussed with retailers and consumers. Consequently, a comprehensive list of the keywords (as listed in Table 2) was composed to explore issues that related to beef products, and that were highlighted by consumers on Twitter. The overall tweets were then filtered using this list of keywords, so that only the relevant tweets (26,269) would be retrieved. Then, country-wise classification of tweets was performed by using the name of the supermarket corresponding to each country. It was observed that tweets from the USA, the UK, Australia, and the world were 1,605, 822, 338, and 15,214, respectively. Several hashtags were observed in the collected tweets. The most frequently used hashtags (more than 1,000) are highlighted in Table 3. Top Twitter handles (that is, users who are mentioned very frequently) were identified among the extracted tweets. The Twitter users who have been mentioned more than 2,000 times were considered as top Twitter handles, and they are presented in Table 4.

Table 2. Keywords used for extracting consumer tweets

Beef##disappointment	Beef##rotten	Beef# rancid	Beef#was very chewy
Beef##taste awful	Beef##unhappy	Beef##packaging blown	Beef#was very fatty
Beef##odd colour beef	Beef##discoloured	Beef##plastic in beef	Beef##gristle in beef
Beef##complaint	Beef##grey colour	Beef##oxidised beef	Beef##taste
Beef##flavour	Beef##smell	Beef##rotten	Beef##funny colour
Beef##horsemeat	Beef##customer support	Beef##bone	Beef##inedible
Beef##mushy	Beef##skippy	Beef##use by date	Beef##stingy
Beef##grey colour	Beef##packaging	Beef##oxidised	Beef##odd colour
Beef##gristle	Beef##fatty	Beef##green colour	Beef##lack of meat
Beef##rubbery	Beef##suet	Beef##receipt	Beef##stop selling
Beef##deal	Beef##bargain	Beef##discoloured	Beef##dish
Beef##stink	Beef##bin	Beef##goes off	Beef##rubbish
Beef##delivery	Beef##scrummy	Beef##advertisement	Beef##promotion
Beef##traceability	Beef##carbon footprint	Beef##nutrition	Beef##labelling

Beef#price	Beef#organic/ inorganic	Beef#MAP packaging	Beef#tenderness
------------	----------------------------	--------------------	-----------------

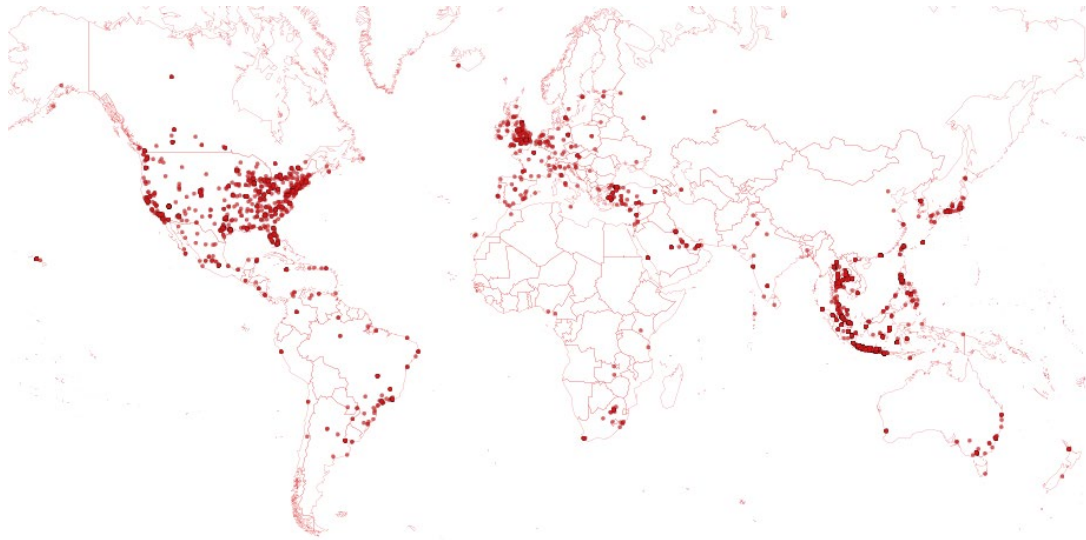

Figure 3: Visualisation of tweets with geolocation data (23,422 out of 1,338,638 tweets containing ‘beef’ and/or ‘steak’)

Table 3: Top hashtags used

Hashtag	Freq (>1000)	Freq (%)
#beef	17708	16.24%
#steak	14496	13.29%
#food	7418	6.80%
#foodporn	5028	4.61%
#whcd	5001	4.59%
#foodie	4219	3.87%
#recipe	4106	3.77%
#boycottearls	3356	3.08%
#gbbw	3354	3.08%
#kca	2898	2.66%
#dinner	2724	2.50%
#recipes	2159	1.98%
#accessibility	1999	1.83%

Hashtag	Freq (>1000)	Freq (%)
#aodafail	1908	1.75%
#earls	1859	1.70%
#votemainefpp	1795	1.65%
#win	1761	1.62%
#ad	1754	1.61%
#cooking	1688	1.55%
#mplusplaces	1686	1.55%
#meat	1607	1.47%
#lunch	1577	1.45%
#bbq	1557	1.43%
#yum	1424	1.31%
#yummy	1257	1.15%
#bdg	1255	1.15%

Hashtag	Freq (>1000)	Freq (%)
#bmg	1255	1.15%
#delicious	1243	1.14%
#soundcloud	1169	1.07%
#vegan	1131	1.04%
#rt	1128	1.03%
#mrpoints	1116	1.02%
#staydc	1116	1.02%
#wine	1072	0.98%
#np	1069	0.98%
#yelp	1052	0.96%
#ufc196	1048	0.96%
#britishbeefweek	1045	0.96%

As described in subsection 3.1.1, the collection of training data for the SVM was performed automatically, based on emoticons. The training data were developed by collecting 10,664 (from all the tweets with ‘beef’ and ‘steak’) messages from the Twitter data captured with emoticons ‘:)’ and ‘:(’. The microblogs/tweets consisting of ‘:)’ were marked as ‘+1’, whereas messages comprising ‘:(’ were marked as a ‘-1’. The tweets containing both ‘:)’ and

‘:(’ were removed. The automatic marking process was concluded by generating 8,560 positive, 2,104 negative, and 143 discarded messages. Positive and negative messages were then randomly classified into five categories. The 8,531 messages in the first four categories were utilised as the training data set and the rest of the 2,133 messages were utilised as the test data set. The values  $\gamma = 2.3$ ,  $c = 2.85$  (for positive class) and  $c = 11.4$  (for negative class) was used for radial basis function in SVM. We used differential costs for positive and negative class to account for class imbalance present in the dataset, *i.e.*, 8,560 positive and 2,104 negative tweets, *i.e.*, the misclassification penalty for the minority class is chosen to be larger than that of the majority class.

Numerous pre-processing steps were employed to minimise the number of features prior to the implementation of the SVM training. Initially, the target query and terms related to the topic (beef/steak-related words) were deleted to prevent the classifier from categorising sentiments based on certain queries or topics. Then, the numeric values in the messages were replaced with a unique token ‘NUMBER’. A prefix ‘NOT\_’ was added to the words followed by negative word (such as ‘never’, ‘not’, and words ending with ‘n’t’) in each sentence. Finally, the Porter stemming algorithm was utilised to stem the rest of the words (Rijsbergen et al., 1980).

Various feature sets were collected and their accuracy level was examined. Tweets with ‘:)’ and ‘:(’ are assumed to be the true classes representing positive and negative sentiments. These true classes were used for comparing the NB and SVM techniques. Unigrams and bigrams representing one-word and two-word tokens were extracted from the microblog posts. In terms of performance of the classifier, we used two types of indicators: (i) the five-fold cross validation (CV) accuracy and (ii) the accuracy level obtained when the trained SVM is used to predict sentiment in the test data set. We also implemented a naive Bayes classifier to be compared with the performance of the SVM classifier.

Table 5 lists the performance of the naive Bayes- (NB) and SVM-based classifiers on the collected microblogs. The best performance is provided when using the unigram feature set in both SVM and NB classifiers. It can be seen that the performance of the SVM is always superior to the NB classifier in terms of sentiment classification. The unigram feature set yields better result than the other feature sets. This occurs because additional casual and new terms are utilised to express the emotions. It negatively affects the precision of the subjective word set characteristic, as it is based on a dictionary. Furthermore, the binary representation scheme produced comparable results, except for the case of unigrams, with those produced by the term frequency (TF) based representation schemes. As the length of micro-blogging posts are quite short, the binary representation scheme and the TF representation scheme are similar to each other, and present almost matching performance levels. Therefore, the SVM-based classifier with unigrams as feature set represented in binary scheme was used for the estimation of the sentiment score of the microblog.

The sentiment analysis based on the SVM was performed on the country-wise classification of tweets. Table 6 lists certain example tweets and their sentiment scores.

Table 4: Top Twitter users

Twitter Handle	Freq (>2k)	Freq (%)
@historyflick	1090	9.16%

Twitter Handle	Freq (>2k)	Freq (%)
@chipotletweet	3701	3.11%

Twitter Handle	Freq (>2k)	Freq (%)
@shukzldn	2203	1.85%

	3		s					
@metroboomin	10725	9.01%	@globalgrind	3626	3.05%	@zacefron	2201	1.85%
@jackgilinsky	8814	7.40%	@trapegod	3499	2.94%	@foodpornsx	2190	1.84%
@itsfoodporn	8691	7.30%	@viralbuzznews	2964	2.49%	@redtractorfood	2166	1.82%
@kanyewset	7452	6.26%	@crazyfightz	2798	2.35%	@sza	2155	1.81%
@youtube	6593	5.54%	@soiocity	2795	2.35%	@therock	2131	1.79%
@earlsrestaurant	5822	4.89%	@kardashianreact	2765	2.32%	@tmzupdates	2093	1.76%
@hotfreestyle	3794	3.19%	@sexualgif	2564	2.15%	@ayookd	2031	1.71%
@audiesamuels	3775	3.17%	@cnn	2504	2.10%	@mcjuggernuggets	2015	1.69%
@freddyamazin	3758	3.16%	@euphonik	2335	1.96%			

Table 5: Performance of the SVM- and NB-based classifier on selected feature sets; CV: 5-fold cross validation, NB: naive Bayes

Representation scheme	Feature Type	Number of Features	SVM		NB
			CV (%)	Test data (%)	Test data (%)
Binary	Unigram	12,257	91.75	90.80	70.68
	Bigram	44,485	76.80	74.46	63.60
	Unigram + bigram	56,438	87.12	83.28	63.48
	Subjective word set ( $\phi$ )	6,789	66.58	65.52	41.10
Term Frequency	Unigram	12,257	88.78	86.27	72.35
	Bigram	44,485	77.49	71.68	65.90
	Unigram + bigram	56,438	84.81	80.97	59.24
	Subjective word set ( $\phi$ )	6,789	68.21	62.25	39.71

Table 6: Raw Tweets with Sentiment Polarity

Sentiment Polarity	Raw Tweets
Negative	@Tesco just got this from your D'ham Mkt store. It's supposed to be Men's Health Beef Jerky...The smell is revolting <a href="https://t.co/vTKVRIARW5">https://t.co/vTKVRIARW5</a>
Negative	@Morrisons so you have no comment about the lack of meat in your Family Steak Pie? #morrisons
Negative	@AsdaServiceTeam why does my rump steak from asda Kingswood taste distinctly of bleach please?
Positive	Wonderful @marksandspencer are now selling #glutenfree steak pies and they are delicious and perfect! Superb stuff.
Positive	Ive got one of your tesco finest* beef Chianti's in the microwave oven right now and im pretty pleased about it if im honest
Positive	@AldiUK beef chilli con carne! always a fav that goes down well in our house! of course with lots of added cheese on top! #WIN

To identify meaningful topics and their content in the collected tweets, initially, we performed sentiment analysis to identify sentiments of each of the tweets. To gain more insight, the sentiment scores and country type were then used to perform content analysis.

The next section explains the results by sub-setting the captured data based on sentiment scores and the country type.

## 4.1 Content analysis based on the country type

### 4.1.1 Analysis of all the tweets from the world

The collected tweets were examined to identify the most frequently used words by consumers to express their views. ‘Beef’ and ‘steak’ were the most frequently used words, followed by ‘fresh’, ‘taste’, and ‘smell’. Then, on these tweets, association rule mining was performed to discover which words are mostly used in conjunction with ‘beef’ and ‘steak’. It was found that the words ‘celebrate’ and ‘redtractorfood’ were the most widely used, and that words such as ‘smell’ and ‘roast’ were scarcely used with ‘beef’. For instance, tweets such as ‘*Celebrate St. Patrick's Day with dinner at the Brickstone! Irish Corned Beef and Cabbage tops the menu! <https://t.co/vRnewdKZYd>*’ present considerably higher frequency compared to the tweets similar to ‘*@Tesco just got this from your D'ham Mkt store. It's supposed to be Men's Health Beef Jerky...The smell is revolting <https://t.co/vTKVRIARW5>*’.

Furthermore, cluster analysis was carried out to classify tweets into certain groups (or clusters) as per the similarities between them. The proposed clustering approach involves hierarchical cluster analysis (HCA) with uncertainty assessment. For each cluster in hierarchical clustering, the  $p$ -values were calculated using multiscale bootstrap resampling. The  $p$ -value of a cluster indicates its strength (i.e. how well it is supported by data). A parallel-computing-based HCA with  $p$ -values was implemented to quickly analyse the high number of tweets. The cluster which presents high  $p$ -values (approximately unbiased) were strongly supported by the capture tweets. These clusters can help us to explain user opinion on beef and steak across the globe. The two predominant clusters identified (with a significance level of  $> 0.95$ ) are represented in Figure 4 as red coloured rectangles. The first cluster consists of certain closely related words, such as *gbbw*, *win*, *celebrate*, *hamper*, *redtractorfood*, and *dish*. It primarily highlights an event called *Great British Beef Week* in the UK, where an organisation associated with farm assurance schemes, called Red Tractor, has asked customers to share their dish to win a beef hamper for the celebration of this event. The second cluster consists of words such as *bone*, and highlights the presence of bone fragments in the beef and the steak of the customers. In their tweets, customers both appreciate or complain about the *taste*, *smell*, *freshness* and various *recipes* of the beef products. The details on the deals and promotions associated with food products, particularly with beef, have been described by the aforementioned customers.



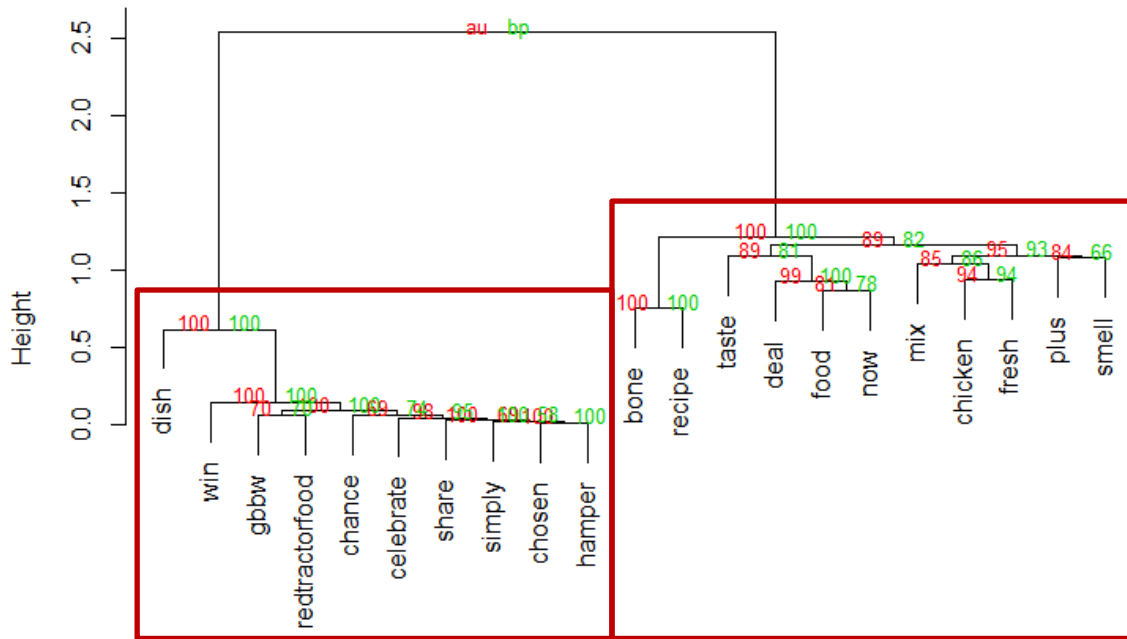

Figure 4: Hierarchical cluster analysis of the all tweets originating in the world; approximately unbiased p-value (AU, in red), bootstrap probability value (BP, in green)

During the analysis, it was found that Twitter data can be broadly classified in two clusters: tweets associated with episodic events and tweets associated with the opinion of consumers on beef products. The intelligence gathered from the episodic event cluster can help retailers to pursue effective marketing campaigns of their new products. Retailers can also identify the factors which have high influence within the network and on their association with other related products. They can also use this medium to address consumer concerns. The second cluster will provide insight into the likes and dislikes of consumers. Certain tweets in this cluster were positive and others were negative; this ambivalence will be explained in next subsections.

#### 4.1.2 Analysis of negative tweets from the world

The collected tweets were divided into positive- and negative-sentiment tweets. In the negative sentiment tweets, the most frequently used words associated with ‘beef’ and ‘steak’, were ‘smell’, ‘recipe’, ‘deal’, ‘colour’, ‘spicy’, ‘taste’, and ‘bone.’

Cluster analysis was performed for the negative tweets from the world, to divide them into clusters in terms of resemblance among their tweets. The three predominant clusters identified (with a significance level of  $> 0.95$ ) are represented in Figure 5 as red-coloured rectangles. The first cluster consists of *bone* and *broth*, which highlights the excess of bone fragments in the broth. The second cluster is composed of *jerky* and *smell*. The customers have expressed their annoyance with the bad smell associated with jerky. The third cluster consists of tweets comprising *taste* and *deal*. Customers have often complained to the supermarket about the bad flavour of the beef products bought within the promotion (deal). The rest of the words highlighted in Figure 5 do not lead to any conclusive remarks.

This cluster analysis will help global supermarkets to identify the major issues faced by customers. It will provide them the opportunity to mitigate these problems and raise customer satisfaction, as well as their consequent revenue.

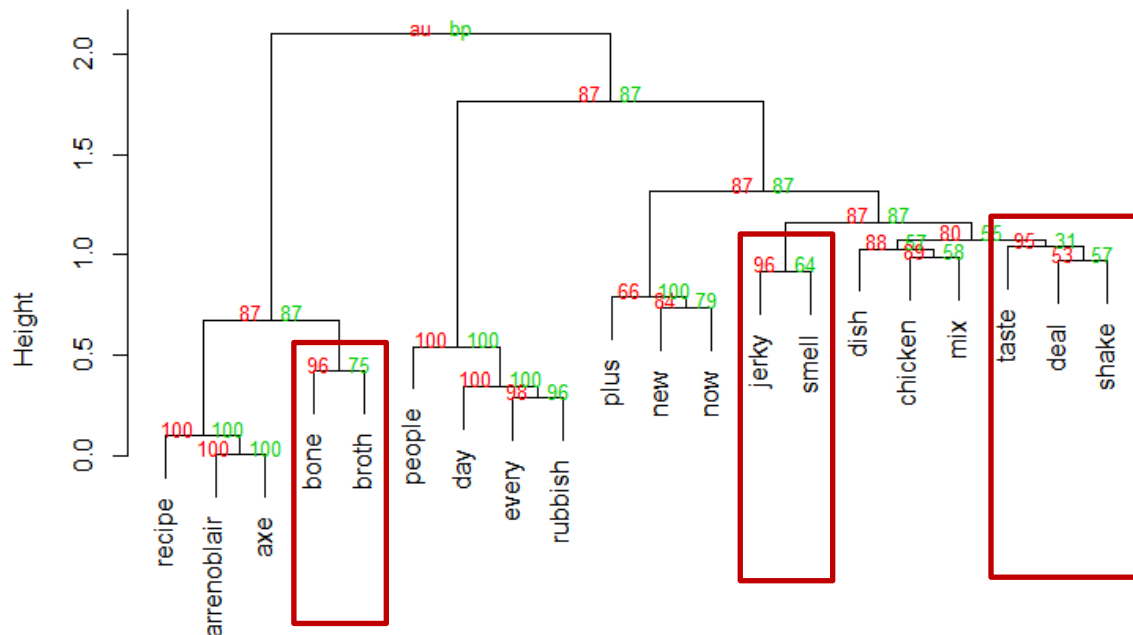

Figure 5: Hierarchical cluster analysis of the negative tweets originating in the world

#### 4.1.3 Analysis of positive tweets from the world

The positive tweets from the world were analysed, and the most frequently used words after ‘beef’ and ‘steak’ were ‘fresh’, ‘dish’, and ‘taste’.

The association rule mining evaluation of the positive tweets from around the world was performed. It was found that ‘beef’ was closely associated with words such as ‘celebrate’ and ‘redrtractorfood’, and was rarely used with words such as ‘months’ and ‘ways’. The word ‘steak’ was frequently used with words such as ‘awards’ and ‘kca’, whereas it was sparsely used with ‘chew’ and ‘night’.

The positive tweets from the world were classified into two clusters based on the similarity of their tweets. They were divided into two clusters, as shown in Figure 6. The first cluster was composed of words such as ‘dish’, ‘win’, ‘gbbw’, ‘celebrate’, ‘redrtractorfood’, ‘share’, and ‘hamper’. These tweets are associated with the celebration of the Great British beef week in the UK. Red Tractor has asked customers to share their dish in order to win a beef hamper. The findings from this cluster do not contribute to the objective of this study, which is the development of a consumer-centric supply chain. However, retailers may utilise it to develop a strategy to introduce appropriate promotional deals to capture a larger market share than their rivals during events such as the great British beef week. The second cluster is composed of words such as ‘love’, ‘taste’, ‘best roast’, and ‘delicious food’, where customers have praised the taste and the overall quality (such as smell and tenderness) of the beef products.

The words like ‘deal’ and ‘great’ highlight the promotions, which were very popular among customers while purchasing beef products.

This cluster analysis will help global supermarkets to present their best-performing beef products and their strengths such as taste and promotions. Moreover, the analysis can help supermarkets to introduce new products and promotions.

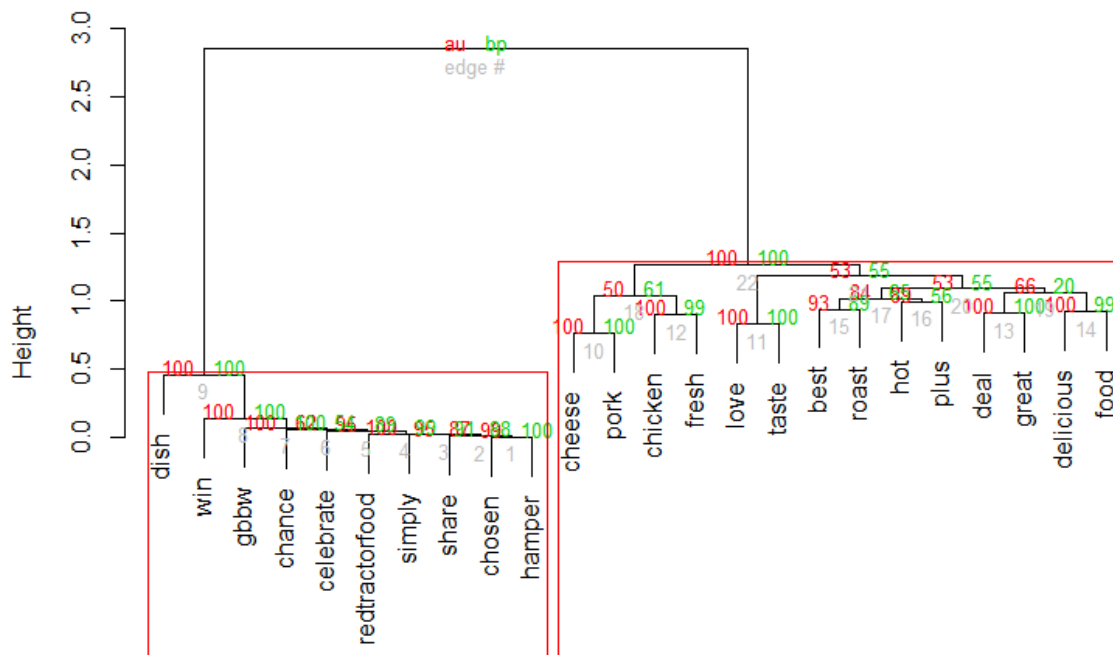

Figure 6: Hierarchical cluster analysis of the positive tweets originating from the world

#### 4.1.4 Analysis of positive tweets from the UK

The positive tweets from the UK were analysed; the most widely used words after ‘beef’ and ‘steak’ were ‘adliuk’, ‘morrison’s’, ‘waitrose’ and ‘tesco’. The association rule mining of tweets from the UK with positive sentiment was conducted, and the word ‘beef’ was most closely associated with terms such as ‘roast britishbeef’ and ‘Sunday’, whereas it was least used with words such as ‘type’ and ‘tell’. The term ‘steak’ was most frequently used with words such as ‘days’, ‘date’, and ‘free’, whereas it was rarely used with terms such as ‘supper’, ‘quick’, and ‘happy’.

The positive tweets from the UK were classified into three clusters based on the similarity to their tweets. The first cluster consists of words such as ‘leeds’ and ‘nfunortheast’, and highlights an event that took place in Leeds, UK, where supermarket Asda joined the National Farmers Union (NFU) Northeast in selling Red Tractor (farm assurance) approved beef products. The second cluster consists of words such as ‘delicious’, ‘roast’ and ‘lunch, Sunday’, where customers talk about cooking roast beef products on Sunday, which turn out to be delicious. The third cluster is composed of words such as ‘thanks’, ‘love’, ‘made’ and ‘meal’, where customers are grateful for the good quality of beef products after cooking them.

The cluster analysis will help UK supermarkets to discover customer preferences. For instance, they prefer the beef originating from the farms approved by farm assurance schemes (Red Tractor). Supermarkets may also monitor their best performing beef products, which will assist them in launching their new products. This will help retailers to develop a strategy to align their products with the preference of the consumers.

#### ***4.1.5 Analysis of negative tweets from the UK***

The most widely used words after ‘beef’ and ‘steak’ were ‘tesco’, ‘coffee’, ‘asda’, ‘aldi’. The association rule mining indicated that the word ‘beef’ was most closely associated with terms such as ‘brisket’, ‘rosemary’, and ‘cooker’. It was least used with terms such as ‘tesco’, ‘stock’ and ‘bit’. The word ‘steak’ was highly associated with ‘absolute’, ‘back’ and ‘flat’, and was rarely associated with words such as ‘stealing’, ‘locked’ and ‘drug’.

The four predominant clusters were identified (with a significance level of > 0.95). The first cluster contained words, such as ‘man’, ‘coffee’, ‘dunfermline’, ‘stealing’, ‘locked’, ‘addict’ and ‘drug’. When this cluster was analysed together with raw tweets, it was found that this cluster represents an event where a man was caught stealing coffee and steak from a major food store in Dunfermline. The finding from this cluster was not linked to our study. However, it could assist retailers in various purposes, such as developing strategy for an efficient security system in stores to address shoplifting. Cluster 2 was related to the tweets discussing high prices of steak meal deals. Cluster 3 represented the concerns of users on the use of horsemeat in many beef products offered by major superstores. This revealed that consumers are concerned about the traceability of beef products. Cluster 4 comprised tweets which discuss the lack of locally produced British sliced beef in major stores (with #BackBritishFarming). This reflects that consumers prefer the beef produced from British cattle instead of from imported beef. The rest of the clusters, when analysed together with raw tweets, did not highlight any conclusive remarks, and users mainly discussed one-off problems with cooking and cutting slices of beef.

The proposed HCA can help to identify (in an automated manner) root causes of the issues with the currently sold beef and steak products. This may help major superstores to monitor and respond quickly to the customer issues raised in social media platforms.

#### ***4.1.6 Analysis of negative tweets from Australia***

The tweets reflecting negative sentiment from Australia were analysed, and the most frequently used words after ‘beef’ and ‘steak’ were ‘aldi’ and ‘safeway’. The association analysis revealed that the term ‘beef’ was most closely associated with words such as ‘safeway’, and ‘corned’ and was least associated with ‘grass’, ‘gross’ and ‘packaged’. The word ‘steak’ was mostly used in conjunction with terms such as ‘woolworths’, ‘breast’ and ‘complain’, and was rarely used with terms such as ‘waste’, ‘wine’ and ‘tough’.

Cluster analysis was performed on the negative tweets from Australia; the results were classified into two clusters based on tweet similarity. The first cluster consisted of words such as ‘feel’, ‘eat’ and ‘complain’, which reflects customer complaints on the quality of beef products, particularly in terms of tenderness and flavour. The second cluster comprised words

such as *'disappointed'*, *'cuts'*, *'cook'*, *'sold'* and *'dinner'*, which illustrated the annoyance of customers regarding beef products cooked for dinner, particularly in terms of smell, cooking time, and overall quality.

This analysis will assist Australian supermarkets in exploring the issues faced by customers. It may help them backtrack their supply chain and mitigate these issues in order to improve customer satisfaction and consequent revenue.

#### ***4.1.7 Analysis of positive tweets from Australia***

The tweets from Australia which resonated positive sentiment were analysed, and the most frequently used words after 'beef' and 'steak' were 'aldi', 'woolworths', 'flemings' and 'roast'. The association analysis indicated that the word 'beef' was most closely associated with terms such as 'roast', 'safeway' and 'sandwich', whereas it was least used with terms such as 'see', 'slow' and 'far'. The word steak was commonly used with terms such as 'flemings' and 'plate', and was rarely used with words such as 'spent', 'prime' and 'house'.

Cluster analysis was performed on the positive tweets from Australia. Two significant clusters were identified. The first cluster consisted of words such as *'new'*, *'sandwich'*, *'best'* and *'try'*, where customers were praising the new beef sandwich they tried in different supermarkets. The second cluster included words such as *'delicious'*, *'Sunday'*, *'well'*, *'roast'* and *'best'*, in which customers were appreciative of the flavour of the roast beef that was cooked on Sunday, and bought from different supermarkets.

The cluster analysis of positive tweets may help Australian supermarkets to see the best performing beef products among their brands and their rival brands. Moreover, cluster analysis may help them to identify the most popular beef products among customers, as well as to launch new beef products and to strengthen their position in the market against their rivals.

#### ***4.1.8 Analysis of negative tweets from the USA***

The tweets from the USA resonating negative sentiments were analysed, and the most frequently used words were 'beef', 'carnival', 'steak', 'walmart', 'sum' and 'yall'. Association rule mining was performed, and the results indicated that the term 'beef' was most closely associated with words such as *'carnival'*, *'yall'* and *'dietz'*, and was least associated with terms such as *'cake'*, *'sum'*, *'ride'* and *'grow'*. The word 'steak' was most frequently used with terms such as *'shake'*, *'walmart'* and *'stolen'*, and was least frequently used with words such as *'show'*, *'minutes'* and *'fries'*.

Cluster analysis was performed on the negative tweets from the USA, and they have been classified into two clusters based on tweet similarity. The first cluster included words such as *'mars'*, *'corned'*, *'beef'*, *'cream'*, *'really'*, *'eggs'*, *'trending'*, *'bars'* and *'personally'*. There was a tweet which was retweeted several times, which expressed the annoyance of a customer regarding the price of corned beef, comparing it to Mars bars and Cream eggs. The second cluster was composed of terms such as *'jerky'*, *'eat'* and *'went'*, where customers have visited the supermarket to buy steak or joint, however, they could only find beef jerky on the shelves.

The negative cluster analysis may help the US supermarkets to understand the issues faced by customers. For instance, the high price of corned beef and the unavailability of steak and joint were the major issues highlighted. The supermarkets may liaise with their suppliers and develop appropriate strategies to satisfy their customers, and thereby generate more revenue.

#### ***4.1.9 Analysis of positive tweets from the USA***

The positive tweets from USA were analysed, and the most frequently used words were ‘beef’, ‘lamb’, ‘lbs’, ‘steak’, ‘tops’ and ‘walmart.’ The association rule mining of tweets from the USA was performed, and the results indicated that term ‘beef’ was most closely associated with words such as ‘lamb’, ‘pork’, ‘lbs’ and ‘generate’, and was least associated with terms such as ‘tops’, ‘cheese’ and ‘equivalents’. The word ‘steak’ was most frequently used with terms such as ‘butter’ and ‘affordable’, and was rarely used with terms such as ‘truffles’, ‘sea’ and ‘honey’.

Two significant clusters were identified. The first cluster consisted of words such as ‘tops’, ‘equivalents’, ‘cheese’, ‘greenhouse’, ‘gases’, ‘generate’, ‘pork’, ‘every’, ‘list’, ‘lamb’ and ‘lbs’. Customers have compared the greenhouse gases generated by the production of beef to that of lamb and cheese. They have suggested that beef production generates lower emissions than lamb. The second cluster comprises terms such as ‘top’, ‘new’, ‘publix’, ‘better’ and ‘best’, where customers appreciated the beef products sold by Publix compared to that of other supermarkets, in terms of quality and price.

The cluster analysis of positive tweets may help US supermarkets to find out the qualities preferred by consumers. For instance, supermarkets were conscious of the carbon footprint generated in the production of beef, lamb, and cheese. They also sought for high-quality beef products at a reasonable price. This analysis may help the US supermarket to develop their strategy for introduction of new products.

In the next section, we will describe how content analysis of Twitter data could help retailers in terms of waste minimisation, quality control, and efficiency improvement by linking them to the upstream segments of the supply chain.

## **5. Identification of issues affecting consumer satisfaction and their mitigation within the supply chain**

During the analysis of consumer tweets, it was revealed that there were numerous issues affecting customer satisfaction, such as bad flavour, hard texture, extra fat, discoloration of beef products, and presence of horsemeat in beef products, as listed in Table 7. The root causes of these issues are located within various segments of the supply chain, as depicted in Figure 7, and are often interrelated. Usually, retailers struggle to establish the relationship between customer dissatisfaction and their root causes. The major issues faced by consumers, their root cause, and the actions for their respective mitigation are described below:

1. Bad flavour and unpleasant smell—One of the major reasons for bad flavour and unpleasant smell is the oxidisation of beef products, which refers to the oxidisation of their proteins and lipids when exposed to air (Brooks, 2007). The beef products

associated with issues of bad flavour and unpleasant smell leads to consumer disappointment, and often become discarded. Inefficient packaging methods employed by the abattoir and the processor, and the mishandling of beef products in logistics and other stages of beef products leads to their oxidation (Barbosa-Pereira et al., 2014). Regular maintenance of packaging machines and random sampling of beef products could assist in addressing this issue (Cunningham, 2008). Appropriate training should be provided to the staff of logistics, as well as to all segments of the supply chains, to avoid product mishandling. Inefficiency of the cold chain also leads to unpleasant smell and bad flavour (Raab et al., 2011). Maintenance of chilled temperature at the premises of the abattoir and the processor, the retailer, and in the logistics vehicle is vital to mitigate this problem (Kim et al., 2012). Periodic maintenance of refrigeration equipment and regular temperature checks are necessary for the improvement of the efficiency of the cold chain management.

2. Traceability issues in beef products—The analysis of consumer tweets reveal their concern about the traceability of beef products, particularly regarding horsemeat since the scandal in the European market in 2013. The scandal undermined consumer confidence in the quality of beef products and on the audits performed by retailers on their suppliers (Barnett et al., 2016). These kinds of issues could be avoided in the future by following a strict traceability regime in the beef supply chain, and by mapping all stakeholders, viz. farms, abattoirs, as well as processors and retailers (Sarpong, 2014). This regime should be sufficiently robust so that each beef cut presented on retailer shelf could be traced back to the animal from which it derived, as well as to its associated farm, breed, diet, and gender. All stakeholders of the beef supply chain should store product flow information locally, and share it with other stakeholders in the supply chain. This would improve consumer confidence and assist audit authorities in identifying any potential adulteration.
3. Extra fat—Presence of extra fat on beef products leads to customer dissatisfaction (Brunsø et al., 2005). The yield of cattle that have not been raised as per the weight and conformation specifications of the retailer is often associated with excess of fat (Borgogno et al., 2016). Similarly, inefficient trimming procedures at abattoirs and at the processor affect the leanness of beef products (Mena et al., 2014). This issue could be mitigated by implementing appropriate guidelines of animal welfare in beef farms, so that cattle are raised as per weight and conformation specifications of the retailer, and by adopting appropriate trimming procedures at the abattoir and the processor.
4. Discoloration of beef products—The phenomenon of discoloration of beef products prior to the expiry of their shelf life was reported by certain consumers on Twitter. It adds up to the annoyance of consumers, as they perceive these products as inedible. Deficiency of vitamin E in cattle diet is the primary root cause, which indicates that cattle are not raised on fresh grass (Houben et al, 2000). Moreover, the failure of the cold chain also results in beef products losing their fresh red colour. The discoloration of beef products could be avoided by raising the cattle on fresh grass and by maintaining an efficient cold chain throughout the supply chain.

5. Hard texture—Consumers become disappointed if it is inconvenient to chew beef products owing to lack of tenderness (Huffman et al., 1996). The insufficient maturation of carcass of beef products leads to beef products of low tenderness (Vitale et al., 2014). Carcass is preserved in chilled temperatures from 7 to 21 days depending on the age, gender, and breed of the animal (Riley et al., 2005). Appropriate maturation of carcass could improve the tenderness of beef products.
  
6. Presence of foreign body—In certain instances, foreign bodies, such as insects, pieces of plastic, and metal, were found in beef products. Consumers perceive them as inedible, and these instances add up to their discontent. This issue is generated by the errors caused by packaging machines of the abattoir and the processor, the deficiency of food safety management procedures, such as Hazard Analysis and Critical Control Point (HACCP), and lack of safety checks, such as metal detection, damage of packaging due to mishandling of beef products (Goodwin, 2014; Lund et al., 2007; Goodwin, 2014). Regular maintenance of packaging machines; performing systematic safety checks, such as random sampling, physical inspection, and metal detection; implementing appropriate food safety process management techniques, such as Good Manufacturing Practices (GMP) and HACCP; and providing training to the workforce of all stakeholders of the beef supply chain could assist in addressing these issues.

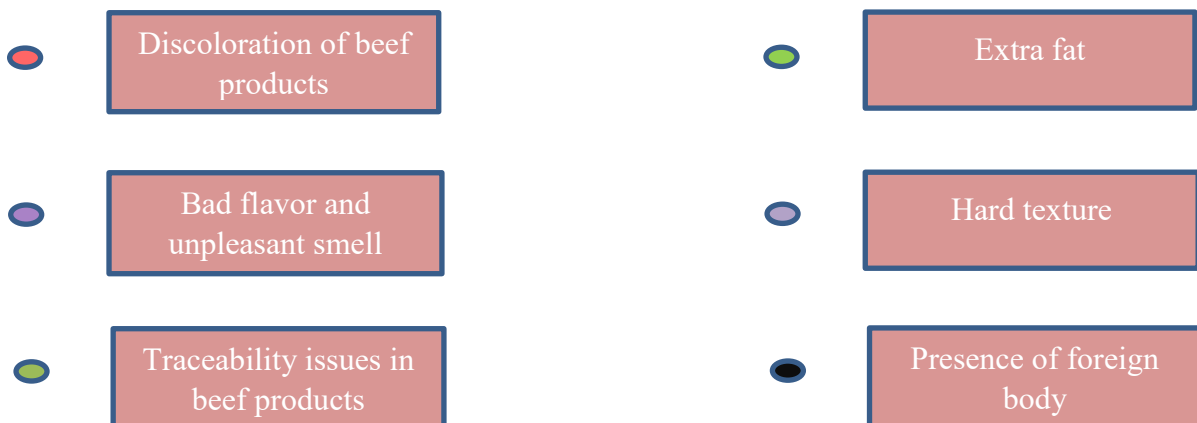
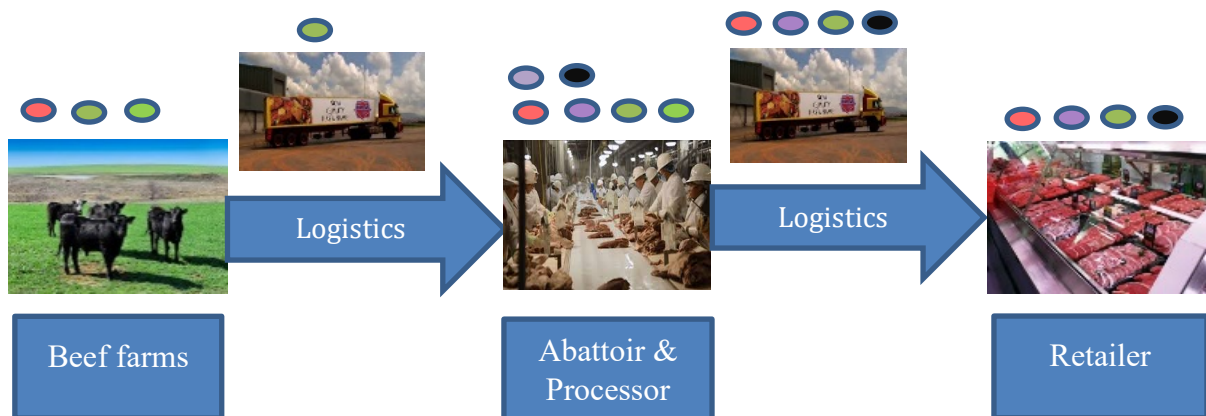



Figure 7. Highlighting the location of root causes of issues faced by consumers in the beef supply chain

Table 7 Summary of issues identified from consumer tweets, and actions for their mitigation

S. No.	Issues identified from consumer tweets	Mitigation of issues
1	Bad flavour and unpleasant smell	Periodic maintenance of packaging machines at abattoir and processor, efficient cold chain management, appropriate training of workforce in logistics and throughout the supply chain so that mishandling of beef products is avoided.
2	Traceability issues in beef products	Supply chain mapping, strong vertical and horizontal coordination, use of ICT.
3	Extra fat	Raising of cattle as per the weight and conformation specifications of retailer, and appropriate trimming of primals at abattoir and processor.
4	Discoloration of beef products	Raising cattle on fresh grass at beef farms and maintaining efficient cold chain management throughout the supply chain.
5	Hard texture	Appropriate maturation of carcass after slaughtering.
6	Presence of foreign body	Following renowned food safety process management techniques such as Good manufacturing practices (GMP), Hazard analysis and critical control points (HACCP). Appropriate safety checks, such as physical inspection, metal detection, and random sampling. Periodic maintenance of machines at abattoir and processor.

## 6. Managerial Implications

The findings of this study will assist beef retailers in developing a consumer-centric supply chain. During the analysis, it was found that sometimes, consumers were unhappy because of the high price of steak products, lack of local meat, bad smell, presence of bone fragments, lack of tenderness, cooking time, and overall quality. In a study, Wrap (2008) estimated that 161,000 t of meat waste occurred because of customer dissatisfaction. The majority of food waste was attributed to discoloration, bad flavour, smell, packaging issues, and the presence of a foreign body. Discoloration can be solved by using new packaging technologies and by incorporating natural antioxidants in diet of cattle. If the cattle consume fresh grass before slaughtering, it may help to increase vitamin E in the meat, and have a huge impact on

delaying the oxidation of colour and lipids. The issues related to bad smell and flavour can be attributed to temperature abuse of beef products. The efficient cold chain management throughout the supply chain, raising awareness and proper coordination among different stakeholders, may assist retailers in overcoming this issue. The packaging of beef products can be affected by mishandling during the product flow in the supply chain or by implementing inefficient packaging techniques at the abattoir and the processor, which can also lead to presence of foreign bodies within beef products. Inefficient packaging affects the quality, colour, taste, and smell. Periodic maintenance of packaging machines and using more advanced packaging techniques, such as modified atmosphere packaging and vacuum skin packaging, will assist retailers in addressing the above-mentioned issues. The high price of beef products can be mitigated by improving the vertical coordination within the beef supply chain. The lack of coordination in the supply chain leads to waste, which results in the high prices of beef products. Therefore, a strategic planning and its implementation may assist food retailers in reducing the price of their beef products more efficiently than their rivals.

During the analysis, it was found that products made from the forequarter and the hindquarter of cattle has different patterns of demand in the market, which leads to carcass imbalance (Simons et al., 2003; Cox & Chicksand 2005). This imbalance leads to retailers suffering huge losses, and contributes to food waste. Sometimes, consumers think that meat derived from different cuts, such as the forequarter and hindquarter, possess different attributes, such as flavour, tenderness, and cooking time, as well as price. The hindquarter products, such as steak and joint, are tenderer, require less time for cooking, and are more expensive, whereas forequarter products, such as mince and burger, are less tender, require more cooking time, and are relatively less expensive. Consumers think that beef products derived from the forequarter and hindquarter have different taste, and this affects their buying behaviour. In the present study, it was found that slow-cooking methods, such as casseroles, stewing, pot-roasting, and braising, can improve the flavour and the tenderness of forequarter products (Guide to Shopping for Rare Breed Beef). Through the help of proper marketing, and advertisement, retailers can raise awareness between the consumers, and can increase the demand of less favourable beef products, which will further assist in waste minimisation, and reform the supply chain to become more customer-centric.

The analysis of consumer tweets revealed that consumers, particularly the ones from the UK, were interested in consuming local beef products. Their main concerns were quality and food safety. Particularly after the horsemeat scandal, customers are prone towards the traceability of information, i.e. information related to animal breed, slaughtering method, animal welfare, use of pesticides, hormones, and other veterinary drugs in beef farms. Retailers can win consumer confidence by following the strict traceability regime within the supply chain.

The analysis of positive sentiments of tweets revealed that good promotional deals usually motivate consumers to buy the product from a particular retailer store. As food products have direct impact on the health, consumers assign more importance to the quality, food safety, and brand image than to the price of beef products. There were several positive tweets associated to the Red Tractor farm assurance scheme. By proper labelling, retailers will be able to capture maximum market share compared to their competitor. There were numerous discussions on consumers appreciating the combination of roast beef products along with different kinds of wine; this may assist retailers to develop marketing and promotional strategies.

There are few limitations associated with the approach discussed in this paper. First, Twitter API based data collection was performed only for limited time period. Larger samples of data can be collected over longer time periods to increase the representativeness of the collected sample. Second, keyword (using food retailer names) based approach involves time and resources to conduct appropriate review of the case study. More automated approach can be developed or employed to quickly and reliably extract topic-relevant tweets from the dataset. Third, twitter users may use different terms for the same topic and a comprehensive analysis and inclusion of synonyms could result in better visualisation of hierarchically clustered data. Fourth, accurate analysis of real opinion expressing users can prevent malicious spamming. Our approach does not take into account user's profile or basic information to increase the credibility of the analysis. Additional work can be conducted to rank customers on different products offered by companies and use these rankings to better manage and plan business strategies.

## 7. Conclusions

Consumers have started expressing their views on social media. Using social media data, a company may gain insight into the perception of their existing or potential consumers about their product offerings. Social media data are one of the cheapest and fastest methods to capture the viewpoint of larger audiences on a particular topic. Food is one of the most significant necessities of human life, and greatly impacts human health. In the current competitive market, consumers are searching for high-quality safe products at a minimum cost. Both positive and negative sentiments related to a particular product are crucial components for the development of a customer-centric supply chain. In this study, Twitter data were used to investigate consumer sentiments. More than one million tweets with 'beef' and/or 'steak' were collected using different keywords. Sentiment mining based on SVM and HCA with multiscale bootstrap sampling techniques was proposed for the investigation of positive and negative sentiments of the consumers, as well as for the identification of their issues/concerns regarding food products. The collected tweets were analysed to identify the main issues affecting consumer satisfaction. The root causes of these identified issues were linked to their root causes in different segments of the supply chain. As the focus of this work was to illustrate the use of the text-mining approach for social media analysis, it was therefore assumed that data from Twitter would be representative of real opinions. During the analysis of the collected tweets, it was found that the main concerns related to beef products among consumers were colour, food safety, smell, flavour, as well as the presence of foreign particles in beef products. These issues generate great disappointment among consumers. A significant number of tweets related to positive sentiments; the consumers had discovered and shared their experience about promotions, deals, and a particular combination of food and drinks with beef products. Based on these findings, a set of recommendations were prescribed for the development of a consumer-centric supply chain. However, there are certain limitations in the proposed approach. During the hierarchical clustering analysis, it was found that some of the results were not linked to the beef supply chain. These findings do not contribute towards the objective of the study, which is to develop a consumer-centric supply chain, and were therefore not described in detail. However, these results could be used for different purposes, and are a topic for future research. Moreover, other algorithms such as the latent Dirichlet algorithm may be used for the better understanding of consumer behaviours. A larger volume of tweets could be captured using Twitter Firehose instead of the streaming API, which may better represent the data. In the future, the proposed analysis could also be performed on other food supply chains, such as the lamb or pork food supply chains.

## Acknowledgement

The authors would like to thank the project ‘A cross country examination of supply chain barriers on market access for small and medium firms in India and UK’ (Ref no: PM130233) funded by British Academy, UK for supporting this research.

## References

- Arias, M., Arratia, A., & Xuriguera, R. (2013). Forecasting with twitter data. *ACM Transactions on Intelligent Systems and Technology (TIST)*, 5(1), 8.
- Bailey, K., & Francis, M. (2008). Managing information flows for improved value chain performance. *International Journal of Production Economics*, 111(1), 2-12.
- Banterle, A., & Stranieri, S. (2008). Information, labelling, and vertical coordination: an analysis of the Italian meat supply networks. *Agribusiness*, 24(3), 320-331.
- Barnett, J., Begen, F., Howes, S., Regan, A., McConnon, A., Marcu, A., Rowntree, S., & Verbeke, W. (2016). Consumers' confidence, reflections and response strategies following the horsemeat incident. *Food Control*, 59, 721-730.
- Bastian M., Heymann S., Jacomy M. (2009). Gephi: an open source software for exploring and manipulating networks. International AAAI Conference on Weblogs and Social Media.
- Beigi, G., Hu, X., Maciejewski, R., Liu, H. (2016) An Overview of Sentiment Analysis in Social Media and Its Applications in Disaster Relief, [Sentiment Analysis and Ontology Engineering](#), Springer International Publishing, pp 313-340.
- Bhattacharjya, J., Ellison, A., & Tripathi, S. (2016). An exploration of logistics related customer service provision on Twitter: The case of e-retailers. *International Journal of Physical Distribution & Logistics Management*, 46(6/7).
- Bollen, J., Mao, H., & Zeng, X. (2011). Twitter mood predicts the stock market. *Journal of Computational Science*, 2(1), 1-8
- Borgatti, S., Lin, X., 2009. On social network analysis in a supply chain context. *J. Supply Chain Manag.* 45, 5–22.
- Brown, C.G., Longworth, J.W. and Waldron, S. (2002), “Food safety and development of the beef industry in China”, *Food Policy*, Vol. 27 No. 3, pp. 269-284.
- Caplan, P. (Ed.). (2013). *Food, health and identity*. Routledge.
- Carter, C.R., Ellram, L.M., Tate, W., 2007. The use of social network analysis in logistics research. *J. Bus. Logist.* 28, 137–168.
- Chae, B. K. (2015). Insights from hashtag# supplychain and Twitter analytics: Considering Twitter and Twitter data for supply chain practice and research. *International Journal of Production Economics*, 165, 247-259.

- Chau, M., & Xu, J. (2012). Business intelligence in blogs: Understanding consumer interactions and communities. *MIS quarterly*, 36(4), 1189-1216.
- Chen, X., Elmes, G., Ye, X., & Chang, J. (2016). Implementing a real-time Twitter-based system for resource dispatch in disaster management. *GeoJournal*, 81(6), 863-873.
- Chung, A. D. (2015). *Brand personality research on Twitter* (Doctoral dissertation).
- Cigarrán, J., Castellanos, A., & García-Serrano, A. (2016). A step forward for Topic Detection in Twitter: An FCA-based approach. *Expert Systems with Applications*, 57, 21-36.
- Coene, J (2016). graphTweets: Visualise Twitter Interactions. R package version 0.3.1. Retrieved from <https://CRAN.R-project.org/package=graphTweets>
- Cox & Chicksand (2005). The Limits of Lean Management Thinking:: Multiple Retailers and Food and Farming Supply Chains. *European Management Journal*, 23(6), 648-662.
- Cox, A., Chicksand, D., & Palmer, M. (2007). Stairways to heaven or treadmills to oblivion? Creating sustainable strategies in red meat supply chains. *British Food Journal*, 109(9), 689-720.
- Crandall, P. G., O'Bryan, C. A., Babu, D., Jarvis, N., Davis, M. L., Buser, M., Adam, B., Marcy, J., & Ricke, S. C. (2013). Whole-chain traceability, is it possible to trace your hamburger to a particular steer, a US perspective. *Meat science*, 95(2), 137-144.
- Csardi G, Nepusz T, The igraph software package for complex network research, *InterJournal, Complex Systems*, 1695. (2006). Retrieved from <http://igraph.org>
- Das, Sanjiv and Mike Chen (2001). Yahoo! for Amazon: Extracting market sentiment from stock message boards. in *Proceedings of APFA-2001*. 2001.
- Dataminr, (2014). Dataminr's Event Detection Technology. Retrieved from <https://www.dataminr.com/technology/> (accessed 01.08.13)
- Dave, K., Lawrence, S., & Pennock, D. M. (2003, May). Mining the peanut gallery: Opinion extraction and semantic classification of product reviews. In *Proceedings of the 12th international conference on World Wide Web* (pp. 519-528). ACM.
- Davidson, D. J., Jones, K. E., & Parkins, J. R. (2016). Food safety risks, disruptive events and alternative beef production: a case study of agricultural transition in Alberta. *Agriculture and Human Values*, 33(2), 359-371.
- Duarte Canever, M., Van Trijp, H. C., & Beers, G. (2008). The emergent demand chain management: key features and illustration from the beef business. *Supply Chain Management: An International Journal*, 13(2), 104-115.
- Duffy, R., & Fearne, A. (2009). Value perceptions of farm assurance in the red meat supply chain. *British Food Journal*, 111(7), 669-685.
- Fan, Y., Fan, Y., Niu, R. H., & Niu, R. H. (2016). To tweet or not to tweet? Exploring the effectiveness of service recovery strategies using social media. *International Journal of Operations & Production Management*, 36(9), 1014-1036.
- Feinerer, I, Hornik, K (2015). tm: Text Mining Package. R package version 0.6-2. <https://CRAN.R-project.org/package=tm>
- Francis, M., Simons, D., & Bourlakis, M. (2008). Value chain analysis in the UK beef foodservice sector. *Supply chain management: an international journal*, 13(1), 83-91.

- Frizzo- Barker, J., Chow-White, P.A, Mozafari, M., & Ha, D. (2016). An empirical study of the rise of big data in business scholarship. *International Journal of Information Management*, 36, 403-413.
- Galaskiewicz, J., (2011). Studying supply chains from a social network perspective. *J. Supply Chain Manag.* 47, 4–8.
- Ghiassi, M., Skinner, J., & Zimbra, D. (2013). Twitter brand sentiment analysis: A hybrid system using n-gram analysis and dynamic artificial neural network. *Expert Systems with applications*, 40(16), 6266-6282.
- Guide to Shopping for Rare Breed Beef. Taste Tradition Direct. Retrieved from <https://tastetraditiondirect.co.uk/guide-shopping-rare-breed-beef/>
- Handayati, Y., Simatupang, T. M., & Perdana, T. (2015). Agri-food supply chain coordination: the state-of-the-art and recent developments. *Logistics Research*, 8(1), 1-15.
- Hashem, I. A. T., Yaqoob, I., Anuar, N. B., Mokhtar, S., Gani, A., & Khan, S. U. (2015). The rise of “big data” on cloud computing: Review and open research issues. *Information Systems*, 47, 98-115.
- Hazen, B. T., Boone, C. A., Ezell, J. D., & Jones-Farmer, L. A. (2014). Data quality for data science, predictive analytics, and big data in supply chain management: An introduction to the problem and suggestions for research and applications. *International Journal of Production Economics*, 154, 72-80.
- He, W., Zha, S., & Li, L. (2013). Social media competitive analysis and text mining: A case study in the pizza industry. *International Journal of Information Management*, 33(3), 464-472.
- Hodeghatta, U. R., & Sahney, S. (2016). Understanding Twitter as an e-WOM. *Journal of Systems and Information Technology*, 18(1), 89-115.
- Hu, M.inqing and Bing, L.,iu (2004). Mining and summarizing customer reviews. in Proceedings of ACM SIGKDD International Conference on Knowledge Discovery and Data Mining (KDD-2004). 2004.
- Kaplan, A. M., & Haenlein, M. (2011). Two hearts in three-quarter time: How to waltz the social media/viral marketing dance. *Business Horizons*, 54(3), 253-263.
- Katal, A., Wazid, M., & Goudar, R. H. (2013). Big data: issues, challenges, tools and good practices. In *Contemporary Computing (IC3), 2013 Sixth International Conference on* (pp. 404-409). IEEE.
- Kim, Y., Choi, T., Yan, T., Dooley, K., (2011). Structural investigation of supply networks: a social network analysis approach. *J. Oper. Manag.* 29, 194–211.
- Kontopoulos, E., Berberidis, C., Dergiades, T., & Bassiliades, N. (2013). Ontology-based sentiment analysis of twitter posts. *Expert systems with applications*, 40(10), 4065-4074.
- La Scalia, G., Nasca, A., Corona, O., Settanni, L., & Micale, R. (2015). An Innovative Shelf Life Model Based on Smart Logistic Unit for an Efficient Management of the Perishable Food Supply Chain. *Journal of Food Process Engineering*.
- Lewis, K. E., Grebitus, C., Colson, G., & Hu, W. (2016). German and British Consumer Willingness to Pay for Beef Labeled with Food Safety Attributes. *Journal of Agricultural Economics*.

- Li, Y. M., & Li, T. Y. (2013). Deriving market intelligence from microblogs. *Decision Support Systems*, 55(1), 206-217.
- Liang, P. W., & Dai, B. R. (2013). Opinion mining on social media data. In *2013 IEEE 14th International Conference on Mobile Data Management*(Vol. 2, pp. 91-96). IEEE.
- Loureiro, M. L., & Umberger, W. J. (2007). A choice experiment model for beef: What US consumer responses tell us about relative preferences for food safety, country-of-origin labeling and traceability. *Food policy*, 32(4), 496-514.
- Lu, Y., Wang, F., & Maciejewski, R. (2014). Business intelligence from social media: A study from the vast box office challenge. *IEEE computer graphics and applications*, 34(5), 58-69.
- Malhotra, A., Malhotra, C. K., & See, A. (2012). How to get your messages retweeted. *MIT Sloan Management Review*, 53(2), 61.
- McCluskey, J. J., Grimsrud, K. M., Ouchi, H., & Wahl, T. I. (2005). Bovine spongiform encephalopathy in Japan: consumers' food safety perceptions and willingness to pay for tested beef. *Australian Journal of Agricultural and Resource Economics*, 49(2), 197-209.
- McDermott, A., Lovatt, S., & Koslow, S. (2004). Supply chain performance measures for producers and processors of premium beef cuts: A conjoint approach. *Journal on Chain and Network Science*, 4(1), 33-43.
- Miller, George A., Richard Beckwith, Christiane Fellbaum, Derek Gross, and Katherine Miller, (1990). *WordNet: An on-line lexical database*1990: Oxford Univ. Press.
- Mishra, N., & Singh, A. (2016). Use of twitter data for waste minimisation in beef supply chain. *Annals of Operations Research*, 1-23.
- Mora, C., & Menozzi, D. (2005). Vertical contractual relations in the Italian beef supply chain. *Agribusiness*, 21(2), 213-235.
- Morstatter, F., Pfeffer, J., Liu, H., & Carley, K. M. (2013). Is the sample good enough? comparing data from twitter's streaming api with twitter's firehose. *arXiv preprint arXiv:1306.5204*.
- Mulrony, B. R., & Chaddad, F. R. (2005). Strategic alliances in the US beef supply chain. *Journal of Food Distribution Research*, 36(3), 18.
- Muralidharan, S., Rasmussen, L., Patterson, D., & Shin, J. H. (2011). Hope for Haiti: An analysis of Facebook and Twitter usage during the earthquake relief efforts. *Public Relations Review*, 37(2), 175-177.
- Murtagh, F., Legendre, P. (2014). "Ward's hierarchical agglomerative clustering method: which algorithms implement Ward's criterion?", *Journal of Classification*, 31(3), 274-295.
- Nasukawa, T., & Yi, J. (2003, October). Sentiment analysis: Capturing favorability using natural language processing. In *Proceedings of the 2nd international conference on Knowledge capture* (pp. 70-77). ACM.
- Neethu, M. S., & Rajasree, R. (2013). Sentiment analysis in twitter using machine learning techniques. In *Computing, Communications and Networking Technologies (ICCCNT), 2013 Fourth International Conference on* (pp. 1-5). IEEE.

- O'leary, D. E. (2011). The use of social media in the supply chain: survey and extensions. *Intelligent Systems in Accounting, Finance and Management*, 18(2-3), 121-144.
- Pak, A., & Paroubek, P. (2010). Twitter as a Corpus for Sentiment Analysis and Opinion Mining. In *LREc* (Vol. 10, pp. 1320-1326).
- Place, S. E., & Mitloehner, F. M. (2012). Beef production in balance: Considerations for life cycle analyses. *Meat science*, 92(3), 179-181.
- R Core Team (2015). R: A language and environment for statistical computing. R Foundation for Statistical Computing, Vienna, Austria. URL <https://www.R-project.org/>.
- Roesslein, J, tweepy Documentation Release 3.2.0, January 31, 2015.
- Rui, H., Liu, Y., & Whinston, A. (2013). Whose and what chatter matters? The effect of tweets on movie sales. *Decision Support Systems*, 55(4), 863-870.
- Rutsaert, P., Regan, Á., Pieniak, Z., McConnon, Á., Moss, A., Wall, P., & Verbeke, W. (2013). The use of social media in food risk and benefit communication. *Trends in Food Science & Technology*, 30(1), 84-91.
- Sarpong, S. (2014). Traceability and supply chain complexity: confronting the issues and concerns. *European Business Review*, 26(3), 271-284.
- Schumaker, R. P., Jarmoszko, A. T., & Labeledz, C. S. (2016). Predicting wins and spread in the Premier League using a sentiment analysis of twitter. *Decision Support Systems*.
- Shanahan, C., Kernan, B., Ayalew, G., McDonnell, K., Butler, F., & Ward, S. (2009). A framework for beef traceability from farm to slaughter using global standards: An Irish perspective. *Computers and electronics in agriculture*, 66(1), 62-69.
- Sianipar, C. P. M., & Yudoko, G. (2014). Social media: toward an integrated human collaboration in supply-chain management. *WIT Transactions on Information and Communication Technologies*, 53, 249-266.
- Simons, D., & Zokaei, K. (2005). Application of lean paradigm in red meat processing. *British Food Journal*, 107(4), 192-211.
- Simons, D., Francis, M., Bourlakis, M., & Fearne, A. (2003). Identifying the determinants of value in the UK red meat industry: A value chain analysis approach. *Journal on Chain and Network Science*, 3(2), 109-121.
- Soysal, M., Bloemhof-Ruwaard, J. M., & Van der Vorst, J. G. A. J. (2014). Modelling food logistics networks with emission considerations: The case of an international beef supply chain. *International Journal of Production Economics*, 152, 57-70.
- Suzuki, R., Shimodaira, H. (2006) "Pvclust: an R package for assessing the uncertainty in hierarchical clustering", *Bioinformatics*, 22 (12): 1540-1542.
- Swaminathan, M. S. (2015). *In search of biohappiness: biodiversity and food, health and livelihood security*. World Scientific.
- Tan, K. H., Zhan, Y., Ji, G., Ye, F., & Chang, C. (2015). Harvesting big data to enhance supply chain innovation capabilities: An analytic infrastructure based on deduction graph. *International Journal of Production Economics*, 165, 223-233.



- Tarasuk, V., Gundersen, C., Cheng, J., DeOliveira, C., & Dachner, N. (2015). Health Care Costs Associated with Household Food Insecurity in Ontario, Canada. *The FASEB Journal*, 29(1 Supplement), 261-3.
- Thackeray, R., Neiger, B. L., Smith, A. K., & Van Wageningen, S. B. (2012). Adoption and use of social media among public health departments. *BMC public health*, 12(1), 1.
- Tyagi, S. (2015b). *Optimization of a platform configuration with generational changes. International Journal of Production Economics*, 169, 299-309.
- Tyagi, S., Agrawal, S., Yang, K., & Ying, H. (2016). An extended Fuzzy-AHP approach to rank the influences of socialization-externalization-combination-internalization modes on the development phase. *Applied Soft Computing*.
- Tyagi, S., Cai, X., Yang, K., & Chambers, T. (2015a). Lean tools and methods to support efficient knowledge creation. *International Journal of Information Management*, 35(2), 204-214.
- van Dorp, K. J. (2003). Beef labelling: the emergence of transparency. *Supply Chain Management: An International Journal*, 8(1), 32-40.
- Vera-Baquero, A., Colomo-Palacios, R., & Molloy, O. (2016). Real-time business activity monitoring and analysis of process performance on big-data domains. *Telematics and Informatics*, 33(3), 793-807.
- Wang, T., Park, S. C., Bevers, S., Teague, R., & Cho, J. (2013). Factors affecting cow-calf herd performance and greenhouse gas emissions. *Journal of Agricultural and Resource Economics*, 38(3), 435-456.
- Wyatt, N., (2013). Best in Class Crisis Management with Social Media. Retrieved from <http://www.sparkcentral.com/best-class-crisis-management-social-media/>
- Zikopoulos, P., & Eaton, C. (2011). *Understanding big data: Analytics for enterprise class hadoop and streaming data*. McGraw-Hill Osborne Media.