

# SOMA: A method for developing service-oriented solutions



A. Arsanjani  
S. Ghosh  
A. Allam  
T. Abdollah  
S. Ganapathy  
K. Holley

Service-oriented modeling and architecture (SOMA) has been used to conduct projects of varying scope in multiple industries worldwide for the past five years. We report on the usage and structure of the method used to effectively analyze, design, implement, and deploy service-oriented architecture (SOA) projects as part of a fractal model of software development. We also assert that the construct of a service and service modeling, although introduced by SOA, is a software engineering best practice for which an SOA method aids both SOA usage and adoption. In this paper we present the latest updates to this method and share some of the lessons learned. The SOMA method incorporates the key aspects of overall SOA solution design and delivery and is integrated with existing software development methods through a set of placeholders for key activity areas, forming what we call *solution templates*. We also present a fractal model of software development that can enable the SOMA method to evolve in an approach that goes beyond the iterative and incremental and instead leverages method components and patterns in a recursive, self-similar manner opportunistically at points of variability in the life cycle.

## INTRODUCTION

The evolution of software engineering has passed through various eras, including structured programming, analysis, and design and undulated between data orientation or process orientation until it finally brought us to the notion of object orientation,<sup>1,2</sup> where data and process unite to form the object (class). An object exposes a set of methods that can be invoked to manipulate underlying data structures whose implementations are hidden from the invoker. Object-oriented (OO) analysis and design (OOAD) methods abounded<sup>2</sup> in the early 1990s. Component-based software engi-

neering then advanced the state of the art and built on the foundation laid by object orientation. The focus on the unit of deployment as the component gradually gave way to a protocol of remote invocation of those components over a distributed network using hitherto unprecedented consensus

©Copyright 2008 by International Business Machines Corporation. Copying in printed form for private use is permitted without payment of royalty provided that (1) each reproduction is done without alteration and (2) the Journal reference and IBM copyright notice are included on the first page. The title and abstract, but no other portions, of this paper may be copied or distributed royalty free without further permission by computer-based and other information-service systems. Permission to republish any other portion of the paper must be obtained from the Editor. 0018-8670/08/\$5.00 © 2008 IBM

around standards in this arena. Distributed objects and remote-object invocation using Object Management Group CORBA\*\*, Open Software Foundation Distributed Computing Environment (DCE), Microsoft Component Object Model (COM), and Sun Java\*\* Remote Method Invocation (RMI) have continued to mature.

Eventually, within client/server and network-centric computing environments in which the client knows about the identity of the server, a higher degree of separation of concerns emerged in terms of *n*-tier Web-based computing (i.e., e-business). This advanced with the emergence of standards within Web services under which provider and consumer were separated by a contract (the interface) and by the choice of binding (a concrete protocol and data format specification) that provided flexibility for the underlying technology protocols to be used. Capabilities that were significant to business and could be invoked over a network using these standards heralded the emergence of a service-oriented architecture (SOA).

Many definitions have been proposed for services. We have found the ones below to be practical and useful on actual projects.

From a business perspective, a *service* is a well-defined, encapsulated, reusable, business-aligned capability. A *service operation* is the elementary part of a service and specifies the associated inputs, purpose (function, duty or obligations), and outputs (artifacts, products, outcomes, or deliverables). A service is fully defined by a *service description*, a published document or artifact that outlines the overall objective of the service and its inputs, purpose, outputs, scope, responsibility, governance, sustainability (provision period, maintenance, and repair), and qualities of service provisioning.

From an information technology (IT) perspective, a service is a discoverable, invokable software resource that has a service description and interface and is configurable using policies. The service description is available for searching, binding, and invocation by a service consumer. The service description implementation is realized through a service provider that delivers quality of service (QoS) requirements for the service consumer.

With the advent of SOA, the programming principle that was learned from OO—program to interfaces

rather than implementations<sup>3</sup>—was elevated to the level of software architecture in which an actual logical layer is used to describe services.<sup>4,5</sup> It is often the case that programming concepts evolve into architectural constructs and then into methods.

Initial efforts to use traditional OOAD methods to support Web services and SOA found those methods insufficient to support the challenges and nuances required by new first-class constructs of service orientation, namely services, the components implementing those services, the flows of business processes choreographing those services,<sup>6</sup> and the information requirements and policies associated with services. To elaborate, services would be designated as the logical interface mechanism for decoupling a service consumer from a service provider through a standards-based protocol that allows invocation of distributed software resources on an as-needed basis. Further description of how services interact with their underlying realizations and implementations symbolized in the components of the application architecture and how they would be combined and composed in a new notion, termed *choreography* or *orchestration* into business process flows, required a new set of method constructs. This does not imply that the only way to leverage services is through composition and choreography. Services can also be leveraged by using them at a variety of levels: for example, services used to expose legacy functionality, simple services to provide new functionality, services used to increase reuse and refactoring in order to reduce the cost of system maintenance, services used to expose business-significant capabilities, and composite services.<sup>7</sup>

### **Paradigm shift from OO to SOA**

The lure of reusability has enticed many companies to evaluate and adopt SOA as an enabler for wider transformation initiatives or as an enabler for a development or systems-integration project. Our experiences working with hundreds of projects and executives (business and IT) surface a more refined objective. In the case of business stakeholders, a recurrent objective is to have greater flexibility in response to changing market demands. They therefore advocate using SOA tenets to make it possible to locate and assemble the component parts of new products and applications rather than having to buy new, hard-coded solutions or spend precious time and money with integration.

IT stakeholders, on the other hand, are being asked by the business to do more for less. Their view is that if SOA works, it can confer lower development costs through the ability to reuse common bits of functionality in multiple applications. This can result in a greater ease of doing business, more flexibility, and the enabling of more-direct and more-customized interaction with partners, suppliers, and consumers.

The change from OOAD to SOA can be seen on a spectrum: from those who advocate that “only the packaging is new” to those who believe there is a significant paradigm shift. We will elaborate the latter view.

Use-cases are often used to capture functional requirements of OO systems. A use-case captures a set of static object interactions that ultimately realize the use-case. These flows are most often hard-coded. This does not allow the easy recombination of functionality. In contrast, a *service-case* will identify the reconfigurable choreography of a set of service operations, each a unit of functionality. This flow is not hard-coded; instead of endeavoring to initially identify the objects that will sequence the interactions, the focus is on the set of business-aligned IT services that collectively enable the fulfillment of business goals, and the services can be recombined in unanticipated service contexts. Rather than being simply a user interacting with a system, it can be seen as an ecosystem of providers and consumers with often interchangeable roles that leverage the services through policies and new combinations in ever-changing service-cases.

The notion of a service as previously described provides an opportunity to increase the flexibility and reuse of business functionality within an enterprise and with partners. Our project experiences demonstrate that guidance is required for how services, components, and flows are identified and specified in much the same way as was done for objects in object orientation. Hence, we developed a service-oriented method in IBM called *service-oriented modeling and architecture* (SOMA).<sup>8</sup>

SOMA is an end-to-end software development method for building SOA-based solutions. This SOA method was harvested from hundreds of successful experiences and lessons learned from the difficulties and challenges encountered in early SOA design and

implementation projects. The expanse of these projects was wide and deep, ranging from diverse fields such as health care, telecommunications, and financial services to public-sector implementation projects. The key objective of harvesting these experiences was to arrive at a method that consisted of a set of task-performance roles used to produce deliverables (work products) using guidance and best practices from the emerging field of service orientation. IBM invested in this effort to develop methods to support the latest software engineering best practices associated with SOA. Over the past five years, SOMA has inspired such SOA terminology and concepts as service-oriented modeling, service identification, multiple complementary service identification techniques (including harvesting services from business processes), business use cases, usage of business-driven imperatives to identify services, and separation of the identification, specification, and design and realization of services.

SOMA is a software development life-cycle method invented and initially developed in IBM for designing and building SOA-based solutions. This method defines key techniques and provides prescriptive tasks and detailed normative guidance for analysis, design, implementation, testing, and deployment of services, components, flows, information, and policies needed to successfully design and build a robust and reusable SOA solution in an enterprise. The latest release of the method (v.3.1) has major additions and enhancements from the previous release<sup>8</sup> (v.2.x), based on feedback from clients, practitioners, and the industry at large.

In this paper, we provide a description of the method illustrated by two case studies: one concise and one more elaborate. We introduce the core concepts and key activities of SOMA and use a case study drawn from real-life client experiences to illustrate its key activities. Subsequently, we explore the latest enhancements and features that have been inspired by real-world project experiences calling for these features.

Our first case study is concise and demonstrates the value derived from using the capabilities defined within SOMA that focus on the solution of key business problems. We use a pattern format to convey this case study. The next case study is more

elaborate and demonstrates the major phases, activities, and sample outputs.

### Telecommunications: A short case study

*Context:* The case study is based on a telecommunications company that we will fictitiously name *Good Telecom*. The company decided to focus on a service-order creation process to create new services for an SOA project. They wanted to ensure that the service plans and service features would be offered consistently across the various channels: point of sale, Web, and customer service representatives. The business logic and rules were maintained in their mainframe computer. The channels were allowed to override the price plans offered by the back-end systems. This often led to a situation in which a user could get certain features or price plans at a better discount from one channel compared with the other. The company quickly realized that this is not a good business practice and made it business goal to provide consistent services across all channels.

*Problem:* To address the business goal of providing consistent service across channels while creating new service orders. Discussions with the client subject-matter experts and detailed analysis of the relevant systems and IT environment revealed the following challenges and opportunities:

- Duplicate logic had a negative impact on maintenance and support costs.
- Multiple calls to back-end systems resulted in expensive mainframe CPU-cycle consumption and had a negative impact on network traffic.
- An inflexible design and architecture could not support variations—for example, varying features by region.
- Performance was degraded by unstructured code, duplicate code, and code that was not required—that is, it did not support any specific business function.

*Solution:* To address these problems, the following SOMA *capability patterns*, also known as *techniques* (reusable parts of a larger method) were applied:

- *Service identification:* Decompose the service-order creation process to identify services.
- *Service specification:* Develop service-interface and message specifications, service dependencies,

service interactions, the component model, and identify reusable patterns.

- *Existing asset analysis:* Conduct detailed analysis of COBOL (Common Business Oriented Language) modules and copybooks. This was needed to develop an approach to either consolidate or refactor the code.
- *Service refactoring and rationalization:* Determine service granularity and apply a defined set of criteria called a *service litmus test* (SLT) to determine which candidate services are appropriate to expose—that is, to publish using Web Services Description Language (WSDL).
- *Technical feasibility exploration:* Identify potential viable solutions to various problems, such as the conversational nature of the service request when the front-end systems have to interact with back-end systems several times in order to service the request. Multiple fine-grained transactions to fulfill a service request have an impact on the service performance and hence user experience.

*Consequences:* The application of the above capability patterns helped in developing a solution to resolve the challenges:

- Duplicate logic was addressed by analyzing existing assets to develop refactoring approaches and by creating common reusable components.
- The problem of multiple calls to back-end systems was addressed by refactoring logic into appropriate SOA layers, by adding mediation logic in the integration layer and business logic in the service-component layer, and by caching.
- The inflexible design and architecture was rectified by refactoring the code and by creating common reusable components.
- Performance was improved by all of the above.

### Case study: XYZ Financial Services

The XYZ Financial Services case study is a composite of real-world experiences with multiline financial institutions. We use it to describe SOMA concepts and the key activities of the method that are recommended to identify, specify, realize, implement, and deploy services as prescribed by the SOMA method.

XYZ Financial Services, Inc., (XFS) has two major lines of business: insurance and investment. Its market analysis had revealed that the aging of baby boomers and their changing needs in their retire-

ment years presented unprecedented opportunities and challenges for financial institutions such as theirs.

The analysis by XFS had revealed that as the baby boomers advanced toward retirement age, their investment strategies were becoming more conservative and risk-averse, such as shifting a portion of their retirement savings from stocks and securities to savings accounts and certificates of deposits (CDs) in more-traditional, regulated markets that are insured by the Federal Deposit Insurance Corporation in the United States. The demise of defined pension plans and the trend toward defined contribution plans by most employers in the U.S. were further amplifying this trend. XFS also realized that no-interest or low-interest-bearing checking and saving accounts were increasingly becoming an important source of revenue, and CDs were providing a long-term source of funds.

XFS wanted to capitalize on these trends by designing market products and services that would attract and retain these customers. Thus, XFS set a goal of diversifying its business by providing banking services and relatively low-risk products such as saving accounts, CDs, money market accounts, and value-added online banking services (e.g., online bill payment, fund transfer, ability to view detailed account transactions and activity, e-statements, and check ordering). They selected the SOMA method as the means to accomplish this goal.

### OVERVIEW OF THE SOMA METHOD

As a software development life-cycle method for developing SOA-based solutions, or any solution using service-oriented principles, SOMA defines key techniques and describes the roles on a SOA project and a work breakdown structure (WBS). The WBS includes tasks, the input and output work products for tasks, and the prescriptive guidance needed for detailed analysis, design, implementation, and deployment of services, components, and flows needed to build a robust and reusable SOA environment. The SOMA method includes the seven major phases shown in *Figure 1*. The fractal phases contain capabilities that can be leveraged as needed in different sequences. (Fractal is used semi-metaphorically: We apply method capabilities in a self-similar manner within varying scopes. SOMA has a fractal software development life cycle because SOMA applies method components—capability pat-

terns—in a self-similar manner recursively in small release or iteration cycles, focusing on addressing technical risk and delivering software valued by the business.) Realization, for example is leveraged in all phases. No rigid sequencing is implied. In a fractal model, phases will consist of capabilities that may be used by other phases. Governance serves as the context and background for the service-oriented life cycle. SOMA provides support for and linkages to the two main aspects of governance: design-time and runtime governance.<sup>9</sup>

### Fractal model for service-oriented software development

It is important to note that SOMA phases are not linear. They are applied in a risk-driven, iterative, and incremental approach using a nuance peculiar to the SOA life cycle. The life cycle of an SOA project uses a fractal approach that is a combination of two key principles. The first principle of fractal software development is the application of method tasks to *self-similar scope*: that is, tasks are done in a similar way in larger or smaller boundary scopes (whether enterprise-wide, line-of-business, or single project initiatives). The notion of similarity indicates that the application of principles is *similar but not identical*, meaning that as we approach larger scopes, even though the same tasks apply, the additional work needed has to evolve in order to take into account factors that arise from the larger scope. Thus, the SOA method can be applied to SOA solution development at the level of projects, lines of business, between business lines, enterprise-wide, and between business partners.

The SOMA method is also fractal in nature, even in a given scope. SOMA is composed of capability patterns representing techniques applied in the method. Many of these capability patterns are executed in all phases in SOMA with different degrees of elaboration and precision. For one example, we make exposure decisions based on the information we know about the services during identification and then we elaborate and refine the exposure decisions in the specification phase when we know more about the nonfunctional requirements of the services. A second example is that we analyze the existing assets in the identification phase to identify systems and system functions that can be leveraged to realize the services, but we expand further on that analysis in the specification

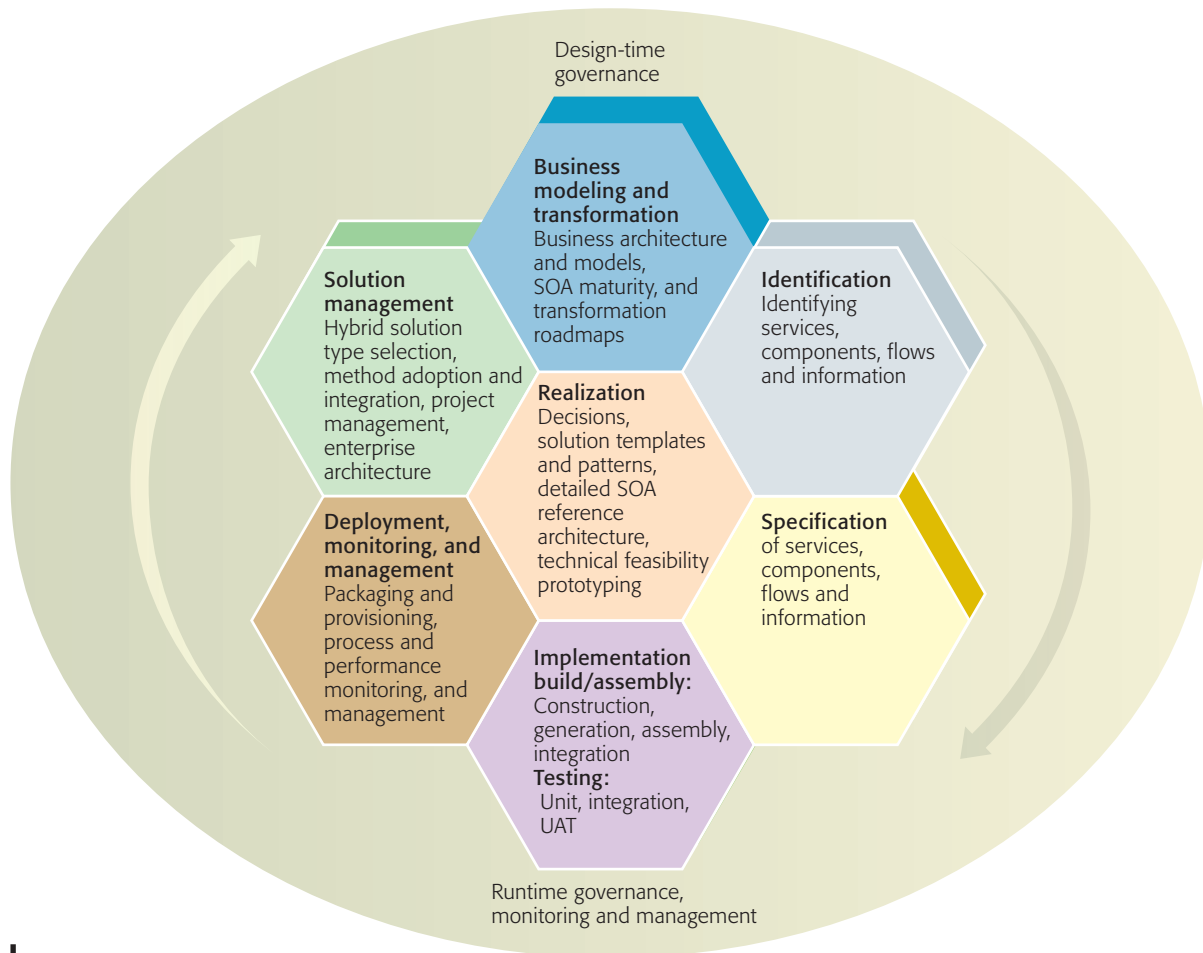

**Figure 1**  
SOMA phases—a fractal model of software development

phase to identify existing components and objects and their operations that we can reuse to realize the services. And as a third example, we initially model dependencies among services when we define the service portfolio but we further elaborate the dependencies of services with components and physical systems when we identify components and make decisions to realize the services. In addition, we apply similar principles in successive levels of detail to elaborate the SOA reference architecture as we progress in the SOMA life cycle.

The second principle of fractal software development is successive iteration. The concepts of iterative and incremental development life cycles have existed for a long time. They focus on prioritization and mitigation of risk factors in order to ensure the product quality of the solution. This has its roots in the spiral model of software development by Boehm.<sup>10</sup> Successive iteration is

connected with the notion of service evolution and implies a focus on not only the risks associated with the implementation, but also with the dependencies associated with the service portfolio as services evolve through the life cycle. The notion of service dependencies on other services, and potentially other dependencies on actual back-end systems, databases, and components, must be called out.

Thus, in SOMA, a prioritization of the service model is conducted and based on a service-dependency diagram and takes into account the risk factors involved in the IT aspects of the architecture. A subset of services is prioritized for the next implementation release in which technical feasibility is planned for, measured, and exercised within a proof-of-concept prototype.

Over time, functionality or business capabilities that were not selected for service exposure may get



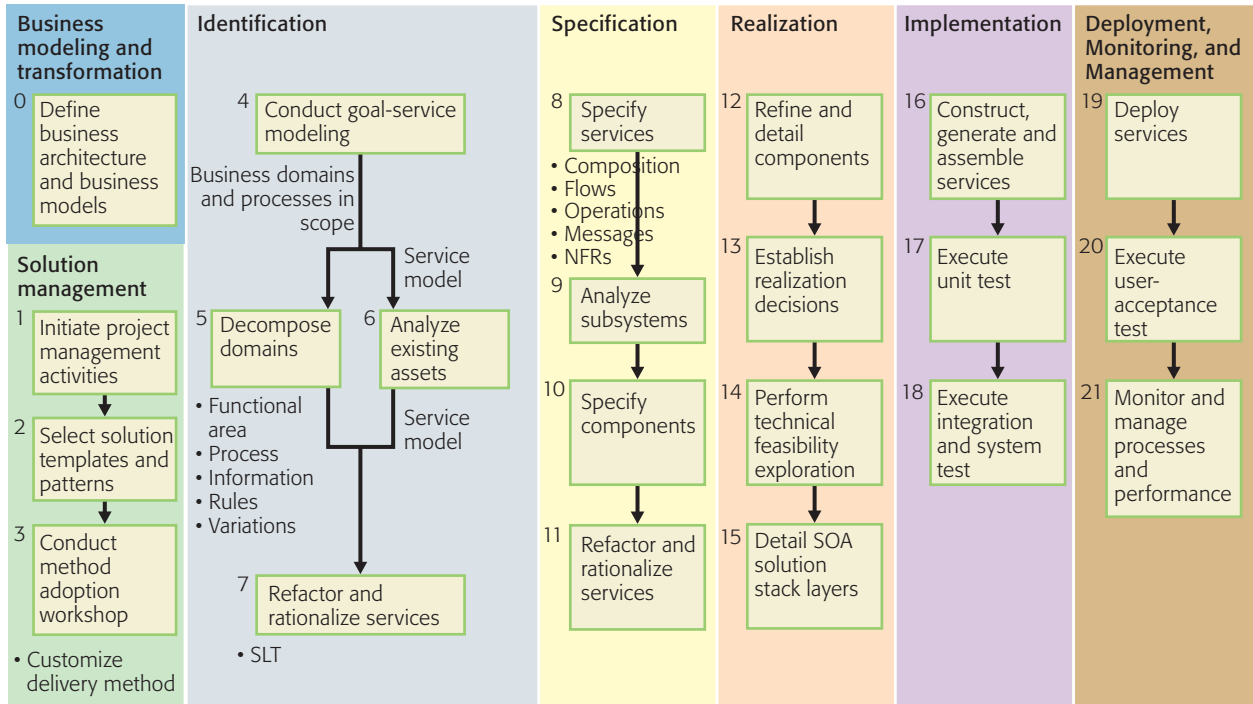

**Figure 2**  
SOMA life-cycle high-level flow

identified in a later iteration, when they are reassessed using the SOMA SLTs, and a determination is made whether they should be exposed as services in this release or implemented in a traditional manner.

The flow shown in *Figure 2* is a sequential depiction of the overall fractal flow at a high level. Whereas *Figure 1* depicts the capability patterns and fractal nature of the SOMA method, *Figure 2* illustrates a typical process flow of an engagement executing the SOMA method. In this paper we focus primarily on the identification, specification, and realization phases. In the following sections, for lack of space, we do not discuss the details of the roles; we do discuss activities, tasks, some work products, and some guidance concerning tasks. Collectively this constitutes the method.

### Business modeling and transformation

In this phase, the business is modeled, simulated, and optimized, and a focal area for transformation is identified that will drive a series of subsequent projects using the set of phases shown in *Figure 2* and discussed in the following sections. Note that

this phase is not strictly required but is highly recommended.

### Solution management

SOA solutions are hybrid in nature and typically include multiple solution types. This is because services identified and specified during the early phases in SOMA can be realized in subsequent phases of SOMA by different scenarios, such as custom development, legacy integration and transformation, and package application integration.

SOMA is designed to support the hybrid nature of SOA solutions and it prescribes specific activities and guidance to implement each of the above solution types. In the SOMA method, the method content common to all SOA solution types is separated from the variable method content that is dependent on specific solution types. The variable method content—tasks, work products, roles, and guidance—specific to each of the solution types is defined and externalized as a method template called a *solution template*. At the beginning of an engagement and subsequently when realization decisions for the services are made, we typically discover and select the solution types needed to

build an SOA solution for a client. The activities and tasks from the selected solution templates are inserted into predefined extension points in the SOMA method to provide a comprehensive process to execute for the engagement.

In the case of XFS, the existing customer relationship management (CRM) system is used to access customer information from the customer database. Hence, the solution template for package application integration was selected. This solution template provides prescriptive tasks necessary to integrate with packaged applications such as, in this case, a CRM system from SAP AG.

### Identification phase

The identification phase pertains to the identification of the three fundamental constructs of SOA: services, components, and flows. Our experience indicates that it is a best practice to utilize a set of complementary service identification techniques. Relying on a single technique tends to create an incomplete set of services. This introduces information entropy early in the development life cycle, often to be remedied at greater cost later in the service life cycle as it entails greater efforts of service refactoring. Additionally, this often leads to the failure to identify service dependencies early on, which impacts release planning and, ultimately, project delivery.

We conduct an initial pass of service identification techniques to identify the candidate services. Upon further assessment, we perform service refactoring and rationalization opportunistically, which includes the essential task of filtering out those business capabilities that will be exposed as services within the scope of the project. The latter assessment includes the SLT technique.

The recommendation is to start by aligning services with business goals, a step we call *goal-service modeling* (GSM). This aligns IT execution with business drivers, imperatives, and objectives as well as monitoring and managing the scope of further business-process modeling and existing asset analysis.

SOMA identification is a process of identifying candidate services and creating a service portfolio of business-aligned IT services that collectively support the business processes and goals of the organiza-

tion. It is done through the process of assessing existing functionality to see if it can be placed in the service model, and by determining missing IT capabilities that will be needed to support the alignment of business strategy, goals, and processes.

Thus, multiple complimentary techniques are introduced during SOMA identification to identify candidate services as well as components and flows. In this paper, we primarily focus on service identification rather than component and business-process flow identification, although the latter is also mentioned.

Services are initially designated as *candidate* during identification because all identified business capabilities and functionalities will not have to be exposed as services nor will funding be available to cover them all. Furthermore, only the relevant subset of candidate services will become exposed services, and thus participate in a given release. The entire service portfolio will often have to be staggered over several releases. Thus, services designated as exposed will still be implemented, albeit not as Web services but as functionality implemented in the ordinary course of software development, such as methods on the component or mapped to application program interfaces (APIs) or transactions of the back-end legacy system. When and if business prioritization of needs is able to make a strong case, some of those unexposed services will be reevaluated using the service refactoring and rationalization activity and may make their way back into the service portfolio over the lifetime of another release.

### Three main service identification techniques

Service identification follows three main complementary techniques: GSM, domain decomposition, and existing asset analysis. GSM uses an approach that is predicated on business challenges and opportunities, corporate strategy, and business goals. Domain decomposition—which comprises multiple service identification techniques of its own—uses a top-down analysis technique that is focused on business process modeling, rules, information, and variation-oriented analysis. Asset analysis addresses the fact that an organization typically will have acquired more than a quarter of a century of legacy systems and applications that are integrated and enhanced and whose ongoing support requires a significant amount of funding. One of



the main value drivers of SOA is to leverage existing resources and redirect them in new ways to support business needs. This bottom-up approach takes a look at the existing application portfolio and other assets and standards that may be used in identifying good candidates for service exposure.

GSM combines the top-down and bottom-up approaches and pulls them together into alignment. Over the course of the project and over the course of several projects, which may be guided by enterprise architecture, all services should be traceable back to a business goal that originates in the goal-service model.

### **Component and service flow identification techniques**

Domain decomposition includes an activity called *functional area analysis* that provides a structural partitioning of the business domains into distinct business functional areas. This provides a natural means of identifying components later in the life cycle. Process decomposition and process modeling, also parts of domain decomposition, provide the opportunity to not only identify services but the service flows that will be used to orchestrate them.

Variation-oriented analysis and design (VOAD) provides a means to capture variations in business processes, both structural variations (such as information and component variations) and variations in business rules and policies. Thus, VOAD identifies commonality and externalizes variations<sup>11</sup> that will play a significant role in reducing the impact of potential future changes to service portfolio components and processes.

Therefore, SOMA identification provides us with the techniques (activities, roles, work products, and guidance) to derive appropriate service abstractions at the right level of granularity from business requirements, business processes, existing systems and applications, business goals, and anticipated potential variation types. It accomplishes this by making use of complementary identification techniques in combination.

GSM maintains the alignment of services with business goals and refines the subsequent scope of business processes being evaluated as well as existing systems and assets. It accomplishes this alignment by ensuring that the scope of transfor-

mation is appropriately constrained to only those processes and existing resources that are absolutely essential to the solution of the problem, thus saving time and energy within the overall life cycle.

### **Goal-service modeling**

In GSM, a generalized statement of business goals relevant to the scope of the project is decomposed into subgoals that must be met in order for the higher-level goals to be met. This hierarchical decomposition then leads to a set of actionable goals which lead to identifying the services that will help in fulfilling the subgoals. It is also important to identify key performance indicators (KPIs) to provide an objective basis for evaluating the degree to which the goal has been achieved. KPIs and metrics identified during this process are used to measure, monitor, and quantify the success of the SOA solution in fulfilling business needs subsequent to the building and deployment of services in the service model.

In the XFS case study, the highest-level goal, determined by the client, was to attract and retain customers from the baby-boomer generation in the investment and insurance lines of business by offering them banking services that are enabled through multiple channels such as online, self-service portals, and interactive voice response systems (see *Table 1*).

GSM helped define the scope of the client engagement and to identify parts of the business that needed transformation and change to achieve the high-level goals. By using business goals, it played a very important role in identifying which business processes should be focused on, resulting in the identification of those services that would have the greatest business impact. This also provides traceability between business goals and services. The number of candidate services identified during process decomposition can be quite high. However, through GSM and business-process decomposition, the set of candidate services that meets business goals greatly refines the scope of the service orientation. The service portfolio from GSM consists of those listed in the Services column of *Table 1*.

### **Domain decomposition**

This technique focuses on top-down analysis of business domains and business process modeling to

Table 1 Goal-service model for the case study

Goal and Subgoals	KPIs	Metrics	Services
1. Attract and retain customers	Increase number of customers using banking products and services by 2% of the total customer base in the insurance and investment lines of business		
1.1 Enable banking products and services through channels such as self-service portals and interactive voice response systems	Increase number of customers using banking products and services		
1.1.1 Enable banking products such as checking, savings, money market accounts, CDs online	Increase number of customers using banking products	Number of accounts opened in banking products such as checking, savings, money market accounts, CDs	<ul style="list-style-type: none"> <li>• Open account</li> <li>• Close account</li> <li>• Get banking customer report</li> </ul>
1.1.1.1 Enable banking services such as bill payment, fund transfers, check status, and check reorders via self-service portal or IVR (integrated voice response)	Increase number of customers using banking services	Number of banking services through various channels  Number of transactions initiated by various channels	<ul style="list-style-type: none"> <li>• Make payment</li> <li>• Transfer funds</li> <li>• Get account summary</li> <li>• Get account activities</li> <li>• Order checks</li> <li>• Get check status</li> <li>• Get statement</li> <li>• Get payment history</li> </ul>

identify services, components, and flows. We analyze both static and dynamic views of the business including information, rules, and variations.

The business domain is partitioned into coarse-grained functional areas to arrive at a static view of its underlying structure. The key elements of a functional area are the business functions it is responsible for, the business entities that participate in fulfilling those responsibilities, and the associated policies and rules. The process of information analysis begins with the identification of business entities. Further partitioning is performed to arrive at set of loosely coupled subsystems as logical IT boundaries for carrying business functionalities. The domains and their functional areas are initial connections to governance under SOA; they will be the owners of the services.

The results of domain decomposition in our case study are shown in *Table 2*. We focused on the account services and customer management domains for analysis in accordance with the scope defined by the goal-service model.

A dynamic view of an enterprise is reflected in its business processes. Typically, processes are identified and a process hierarchy is developed for a business domain to initiate the process modeling and decomposition. A subset of business processes traceable to relevant business goals requires more detailed process modeling and decomposition to gain further insight into the interactions of the selected set of business processes. The objective of process modeling is to define *to-be* representations of business processes by taking into account *as-is* process models, best practices, industry and reference models, the goal-service model, and process optimization for the purpose of identifying services and their composition and flows. Reference to industry models is recommended in order to adopt de facto standards and leverage existing assets—which is a corresponding capability pattern within SOMA. The process, subprocess, and process activities are then considered as candidate services with some filtering criteria.

In our case study, a process hierarchy was first developed for the Manage Account business process, and further process decomposition of Open

**Table 2** Functional areas and subsystems

Domains	Functional Areas	Subsystems
<b>Account service</b>	<b>Customer accounting</b>	Account management Financial transaction processing
	Billing and payment Collection recovery	
<b>Customer management</b>	<b>Customer profile</b>	Customer profile
	Credit administration Contact and event history	

Boldface type: Domains and functional areas crucial to realize the business goal and corporate strategy

Account and Make Payment subprocesses was performed to identify candidate services (see *Table 3*). Processes and activities from process decomposition are added to the service model. Some of these services are also identified during GSM, and hence can validate the service model.

Information flows through all three constructs of SOA, namely, service, component, and flows. A common business glossary is essential so that everyone in the enterprise can learn to speak the same terminology, to define a consistent way to express the business in terms of information, and to ensure that terms mean the same for all parties. Business entities identified during functional area analysis and data flow in the business processes (if available) are the two key inputs to information analysis. In addition, existing client information models and industry models—such as IBM Information Framework (IFW), IBM Insurance Application Architecture (IAA), ACORD\*\* (Association for Cooperative Operations Research and Development) standards for the insurance industry, and TF Forum Enhanced Telecom Operations Map\*\* (eTOM)—are also potential inputs. Information life-cycle methods (create, retrieve, update, and delete) for each of the key entities might be considered as candidate information services. In addition, we analyze the existing information systems and data sources and, depending on the disparity in the same kinds of information from multiple data sources, we identify additional services to provide a consistent view of the data for the enterprise. The life cycles of business entities are analyzed for further candidate services. In the case study, the key business entities

that were identified are: customer, account, product, transaction, and statement.

The life-cycle methods for these significant business entities are added as candidate services to the service portfolio. At XFS there was a need to support marketing and outreach programs to educate their existing customers from the insurance and investment lines of business about the new banking products and services. A candidate information service was identified that would make it possible to search the customer base by factors such as location and net assets. As result of information analysis, the following services were added to the service portfolio: Get Customer, Update Customer, Delete Customer, Create Account, Get Account, Update Account, Delete Account, Create Transaction, Get Transaction, Update Transaction, Delete Transaction, and Search Customer.

Rules and policies drive day-to-day business in the financial services sector. Rule and policy analysis is essential when a large number of rules are involved within the scope. Rules are typically recorded during process modeling. In rules and policy analysis, we collect all instances of rules, categorize the rules into rule types, and identify candidate rule services based on rule types.

Variation-oriented analysis (VOA) identifies commonalities and variations in the process, structure, data, and rules.<sup>12</sup> VOA is a necessary part of service modeling to ensure reusability and robustness of service design. Structural variations for XFS were the following:

**Table 3** Process decomposition

1. Manage Accounts	1. Manage Accounts
1.1. Open Account	1.1. Open Account
1.2. Process Transactions	<b>1.1.1. Verify Customer Info</b>
1.2.1. Get Balance	<b>1.1.2. Check Credit Rating</b>
1.2.2. Deposit Funds	<b>1.1.3. Create Account</b>
1.2.3. Withdraw Funds	<b>1.1.4. Notify Customer</b>
1.2.4. Transfer Funds	1.2. Process Transactions
<b>1.2.5. Make Payment</b>	1.2.1. Get Balance
1.3. Close Account	1.2.2. Deposit Funds
	1.2.3. Withdraw Funds
	1.2.4. Transfer Funds
	1.2.5. Make Payment
	<b>1.2.5.1. Get Payees</b>
	<b>1.2.5.2. Add Payee</b>
	<b>1.2.5.3. Submit Payment</b>
	<b>1.2.5.3.1. Validate Payment</b>
	<b>1.2.5.3.2. Process Payment</b>
	1.3. Close Account

Boldface type: Performed further process decomposition of Open Account and Make Payment

- *Customer Type*: Preferred Plus, Preferred, or Regular.
- *Account Type*: Checking, Savings, or CD.
- *Transaction Type*: Deposit, Withdraw, Transfer, or Payment.

Process variations are identified to handle recurring versus one-time payment requests. Additional process activity to schedule the next payment is performed for recurring payment requests. Hence, Schedule Next Payment is added to the service portfolio as a candidate service.

**Existing asset analysis**

In this activity, the SOA architect conducts a high-level analysis of existing systems, application services, and other assets available to the project.

The purpose is to identify such assets as systems, packages, and legacy functionality that are capable of supporting the realization of services that meet business needs. The focus is on existing assets that play a role in business processes and functions. We initially perform a coarse-grained mapping of business processes and process activities to the portfolio of existing applications and application interfaces. Later in the specification, we perform a more fine-grained mapping, including message specification.

In practice, we tend to look at available system functions provided by existing assets, which leads to business functions that are then designated as candidate services. (We have found that it is better to refrain from adding all existing fine-grained system functions as candidate services; only the ones that provide business value to the enterprise should be added, and they can be identified using the SLT.) The reason to conduct an existing asset analysis and apply this technique is twofold: namely, to identify candidate services and to take inventory of existing assets and identify the ones that could be leveraged to realize the candidate services in the service portfolio. We focus primarily on existing systems that will help attain the goals and subgoals identified in the goal-service model or provide functionality for the business-process activities that are in the scope. (Note that a service registry is searched for available services as existing assets.)

The existing system at XFS was a SAP CRM application. The following existing business functions were identified as a result of examining the relevant APIs, and were thus added to the service portfolio as candidate services: Change Address, Add Alternate Address, Change Contact Information, Search Customer, and Retrieve Customer Info.

The comprehensive service model for the case study after applying all the complementary techniques for service identification is shown in **Table 4**.

**Service refactoring and rationalization**

This activity consists of three parts: refactoring of services, the service litmus tests, and rationalization. Services in the services hierarchy are refactored in such a way that lower-level services that have some kind of logical affinity are grouped together under a higher-level service. Subsequently,

**Table 4** Service portfolio and hierarchy after applying all complimentary identification techniques

<i>Customer Accounting</i>
1. Manage Account
1.1. Open Account
1.1.1. Verify Customer Info
1.1.2. Check Credit Rating
1.1.3. Create Account
1.1.4. Notify Customer
1.2. Process Transactions
1.2.1. Get Balance
1.2.2. Deposit Funds
1.2.3. Withdraw Funds
1.2.4. Transfer Funds
1.2.5. Make Payment
1.2.5.1. Get Payees
1.2.5.2. Add Payee
1.2.5.3. Submit Payment
1.2.5.3.1. Validate Payment
1.2.5.3.2. Process Payment
1.2.5.3.2. Schedule Next Payment
1.3. Close Account
1.4. Order Checks
1.5. Get Statement
2. Maintain Account
2.1. Create Account
2.2. Update Account
2.3. Delete Account
3. Get Account
3.1. Get Account Summary
4. Maintain Transaction
4.1. Create Transaction
4.2. Update Transaction
4.3. Delete Transaction
5. Get Transaction

5.1. Get Check Status
5.2. Get Account Activities
5.3. Get Payment History
<i>Customer Profile</i>
6. Get Customer
6.1. Search Customer
6.2. Retrieve Customer Info
7. Maintain Customer
7.1. Create Customer
7.2. Update Customer
7.3. Delete Customer
7.4. Change Address
7.5. Add Alternate Address
7.6. Change Contact Information
8. Create Customer Report
8.1. Get Banking Customer Report

the SLTs are applied to the set of candidate services to yield a set of exposed services. The services that have failed the SLTs will still be implemented as ordinary functionality within, for example, Sun Enterprise JavaBeans\*\* or mapped to back-end legacy systems, but will not be exposed as Web services. Note that not all services will be implemented in WSDL, but may be deferred to a later release for this form of implementation. The functionality will most likely still be required and will continue to be implemented by traditional means, but within the context and principles outlined by SOA. A release plan will include dependencies between services, components, flows, information, and rules. *Rationalization* consists of a review of the service model with the business stakeholders to verify the continued relevance of the services that have been selected for exposure and subsequently planned for and funded to be built in the next release.

We categorize or group services by functional areas to define a service hierarchy and we maintain parent-child relationships between services in the hierarchy, later to be used in separating out services and operations.

For XFS, we reviewed the service granularity based on the functional affinity and cohesiveness of the services. We then refactored, refined, and grouped the service portfolio in a hierarchy using the two functional areas, namely, customer accounting and customer profile (Table 4).

The combined application of technical feasibility exploration and service refactoring and rationalization accelerates SOA projects and helps in focusing development efforts and resources and in alleviating risk.

### **Specification phase**

In the SOMA specification phase, the SOA is designed. High-level design as well as significant parts of the detailed design of service components is completed in this phase. During the specification phase, we leverage the existing assets and further elaborate the services, flows, and components from the identification phase in an iterative and incremental fashion to help reach the realization decision. The service model is further elaborated in terms of service dependencies, flows and composition, events, rules and policies, operations, messages, nonfunctional requirements, and state management decisions.

We perform two foundational and preparatory activities before we elaborate and specify the services, flows, and subsystems (component boundaries): first, we elaborate and specify information models, and second, perform further fine-grained analysis and specification of existing assets.

Business entities and their high-level structure and relationships (entity relationship diagrams are relevant to the service scope) are identified during the identification phase. We elaborate the conceptual data model into a logical data model to populate the attributes to be implemented, which must be defined in terms of their domains or logical data types (e.g., character, number, date, and picture).

In doing specification, we also focus on the design of service messages which include input, output, and error messages. In order to eliminate multiple data transformations in the service layer, a best practice is to use a common message model that is accepted by the enterprise. The model defines the message flow in the services layer. In the canonical message model, we select the message format (e.g., Extensi-

ble Markup Language or fixed-length record) and we define the set of types, elements, and attributes representing the business entities and their business attributes. The message types are used as building blocks for input, output, and error messages for the services.

Refactoring of existing assets and code in preparation for making decisions about how to realize a given service (e.g., with the back-end legacy application) must be given careful thought and preparation. We analyze the system interfaces and the input and output parameters of the existing systems and perform a fine-grained mapping of the service to a specific legacy application transaction or batch process. The mapping provides a potential set of realization decisions for the SOA. The leveraging of existing assets through refactoring and mapping to services is a key aspect of service orientation. For example, we need to identify duplicate, unstructured, and unused code before we can rationalize and encapsulate the functionality to be exposed as a shared service across channels and consumers.

### **Service specification**

Service specification is the core of the service modeling activity and focuses on elaborating the detailed design of the services. The dependencies of services on other services, components, or applications, the composition of services, and the flow among services together define the realization and choreography of services to enable business functions and processes. Service operations are invoked to execute a business function in an IT implementation and hence are a key addition in the service model. Service operations are designated based on service granularity, functional affinity, and cohesiveness of services in the service hierarchy. When identifying service operations, we look only for services in the service hierarchy that are to be exposed (i.e., those that passed the SLTs). After service operations are identified, the service hierarchy will contain services that will not be exposed as well as services and their operations that will be exposed. All service operations map to operation in WSDL during IT implementation. Exposed services and service operations are mapped into IT implementation as one of following three scenarios, as illustrated in *Figure 3*:

1. Service operations of an unexposed service
2. Both service and its service operation are exposed



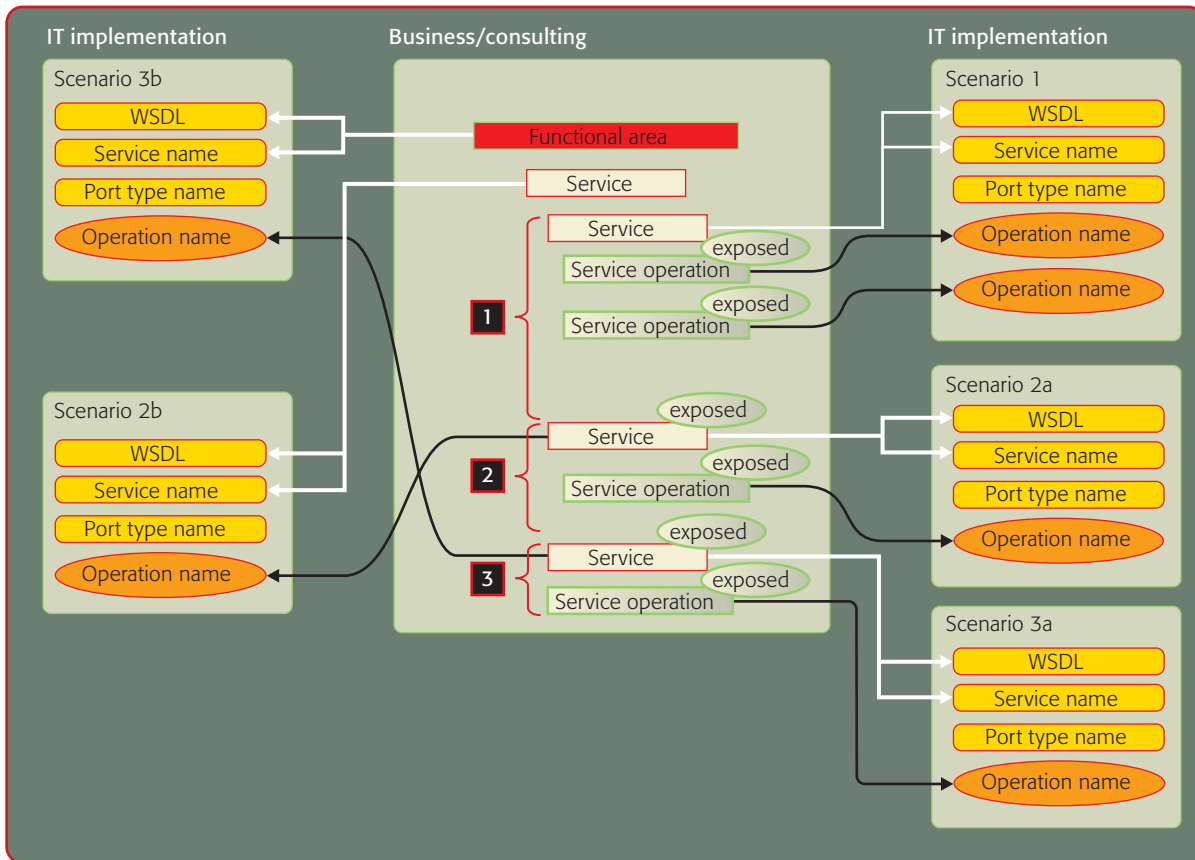

**Figure 3** Service model mapping into IT implementation as WSDL using three different scenarios, noted in the red numbered boxes

- Both service and its service operations are exposed but the parent of the exposed service is a functional area in the service hierarchy

Service operations are typically described in business use cases where requirements are gathered. We advocate the use of service-cases (see the section “Paradigm shift from OO to SOA” above for more detail) as an alternative. We specify the nonfunctional requirements affecting the quality of service (QoS) (e.g., cost of transaction, performance, availability, and security) for the service and its operations. The nonfunctional requirements will be used to commit resources for service components that offer the services and to fund the realization and maintenance of service components that will ensure the delivery of the QoS over time.

We develop a service context diagram depicting the service ecosystem for a group of related services illustrating service consumers and service providers

and indicate the flow of messages between services and the various underlying systems that implement them. We describe the input, output, and error messages for a service operation based on a canonical message model defined earlier. We also map parameters of service operations to the parameters of existing asset interfaces so service operations can be realized by leveraging those interfaces. We identify the fit gap, specify how to bridge the gap, and realize the gap using extension, configuration, and customization in order to leverage existing assets.

Although services in SOA are stateless, state management decisions ensure that the entities acted upon during the service invocation are at the right transactional state. We also document invocation and messaging styles, such as one-way and request-response, for the services. In a one-way message exchange pattern, the sender gives a best effort to

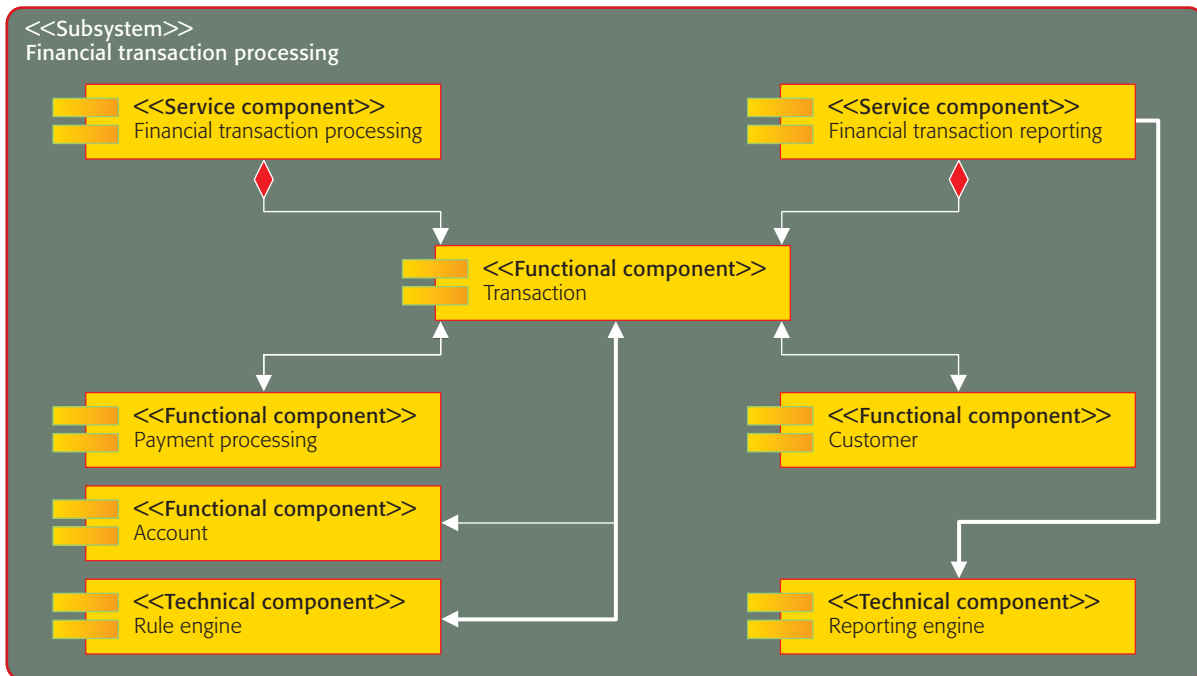

**Figure 4**  
Composition of a financial transaction processing subsystem

move a message from a source location to the destination. In a request-response message exchange pattern, a client asks a service provider a question and then receives the answer to the question, which may be a fault or exception.

### Subsystem analysis

Subsystems signify logical IT boundaries for business functionality. Subsystems are identified by functional decomposition of functional areas. Functional areas and the subsystems that exist in those functional areas are refined into coarse-grained service components that are each responsible for a functional aspect of the subsystem. A major output of this task is a subsystem dependency diagram that shows the dependencies of all subsystems and their interfaces to one another and identifies underlying existing assets. We typically apply OOAD within the confine of subsystems to better partition object graphs with fewer dependencies, as shown in *Figure 4* for XFS. This is in contrast to using OOAD for the entire system and building traditionally larger and more unwieldy object associations.

### Component specification

During component specification we explore the use of patterns that can help us to structure service

components into a set of functional components (supporting business capabilities) and we look for the technical components responsible for providing auxiliary support from the perspective of technology and infrastructure. As we perform OOAD within a subsystem, we are able to specify the service components that realize the subsystems. We model the static and dynamic behavior of service components by defining service component interfaces, developing component diagrams, identifying dependencies on functional and technical components, and determining the internal flows of the components. We select such patterns as the enterprise component pattern<sup>13</sup> to represent the inner structure of components for each of the service components and, depending on the complexity and function of the service components, all or a subset of the enterprise component pattern is used to generate the component specification, as shown in *Figure 5* for XFS.

### Realization phase

We validate realization decisions by performing technical feasibility exploration that seeks to exercise the architectural decisions and highest project risk factors through extensible prototypes designed and developed early on.

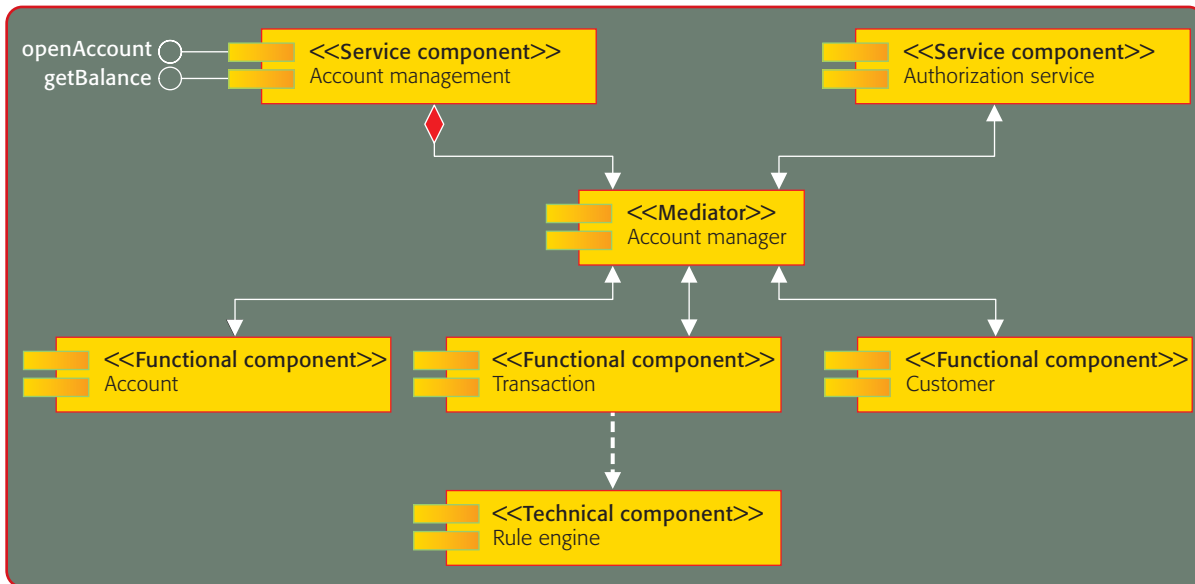

**Figure 5**  
Account management service component specification using the enterprise component pattern (static view)

Selection and instantiation of patterns is fundamental to successful and repeatable SOA deployment. We select corresponding pattern categories to handle several problem domains including information service patterns for information realization,<sup>14</sup> enterprise service bus (ESB) patterns for integration scenarios,<sup>15</sup> and rule patterns<sup>16</sup> for rule realization.

#### **Technical feasibility exploration and realization decisions**

Technical feasibility exploration is a way of assessing, planning, and implementing key prototypes that exercise the architectural constructs outlined in the realization decisions and that have the highest potential of impact and risk to the nonfunctional (operational) requirements of the SOA-based solution. In technical feasibility exploration, we plan for risk factors and technical challenges focusing on nonfunctional requirements. One key task in realization is to detail and instantiate the SOA reference architecture. It is recommended that technical feasibility exploration be conducted for each of the service interaction patterns chosen in the solution based on layers of the SOA reference architecture. Technical feasibility exploration designates interaction patterns that are selected based on several factors, including the maturity of the organization

adopting SOMA and its underlying technological infrastructure.

#### **SOA reference architecture layers**

In SOMA, as we discover the key elements and produce work products, we gradually populate a reference architecture that provides a snapshot view of our SOA. This view facilitates communication and provides a representation of progress and evolution of the SOA in one high-level diagram. Multiple detailed work products support this high-level view.

The layers of the SOA reference architecture<sup>4,5</sup> are thus instantiated (**Figure 6**) as we go through the SOMA 3.1 phases. The reference architecture provides a dashboard view of the artifacts that are produced and where we are in the SOMA 3.1 process. It can be used to cover all aspects of SOA development including the governance.

#### **Implementation and deployment, monitoring, and management phases**

In the implementation phase, we construct, generate, and assemble service, functional, and technical components that realize services, components, and flows. We create necessary wrappers or other mechanism by which an existing component can

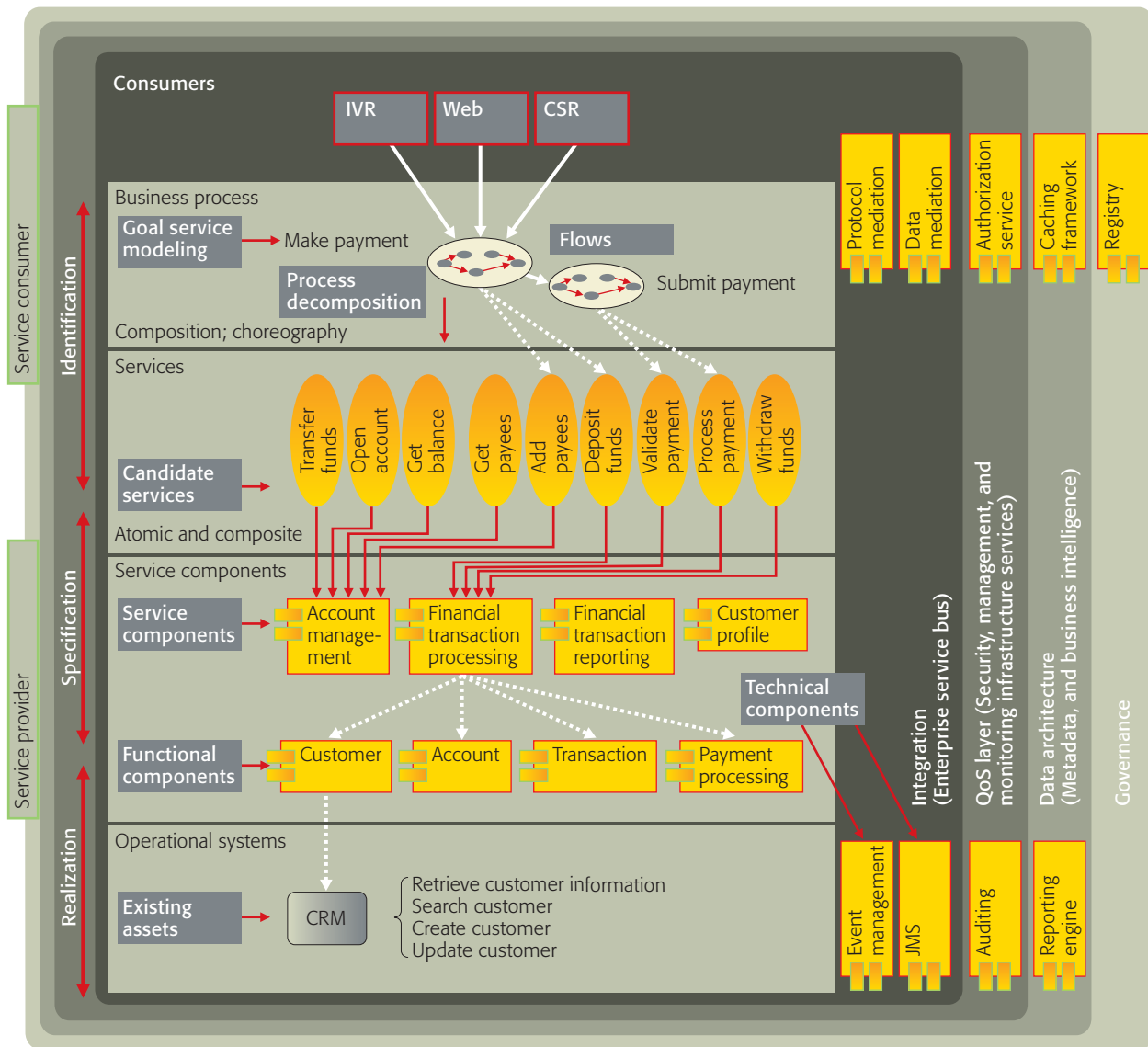

**Figure 6**  
Instantiation of the SOA reference architecture for the case study

participate in realizing a service. In some cases, existing assets are refactored and refined so that they can be used to realize a service. We perform unit, integration, and system testing for services, components, and flows.

SOMA uses a variety of solution templates that include support for custom development, packaged application integration, legacy integration and transformation, ESB design and use, and composite business services. The implementation phase is extended by activities and tasks from these solution templates for different solution types in the overall

solution. Depending on the solution types, additional activities and tasks from the corresponding solution templates are executed to create and update the necessary artifacts.

In the deployment, monitoring, and management phase, we focus on packaging, provisioning, executing user-acceptance testing, and deployment of services in the production environment. As in the implementation phase, the deployment phase is also extended by activities and tasks from solution templates for different solution types in the overall solution. In addition, SOMA provides support of

monitoring and management of business processes and performance monitoring in the production environment as part of this phase. SOMA also provides linkages to runtime monitoring and management aspects, as in system, infrastructure, and network management.

These later two phases of SOMA—implementation and deployment, monitoring and management—are outside the scope of this paper.

## CONCLUSION

We have provided a synopsis of the key concepts, activities, and tasks pertaining to a service-oriented software engineering life-cycle method. We have shown how to conduct service-oriented modeling to build an SOA by using the IBM SOMA method. This method has been developed over hundreds of projects around the world in multiple industries. SOMA provides a software engineering method for building end-to-end SOA solutions. We have outlined the salient activities and tasks of SOA and service-oriented modeling based on five years of multi-industry experience.

A motivation for SOMA, gleaned from hundreds of architecture, design, and technical reviews of client projects, suggests that application architectures tend to be brittle and inflexible (for a variety of reasons which are beyond the scope of this paper). However, what we learned is that the construct of a service can be used to further realize proper separation of concerns, resulting in IT architectures that are easier to maintain and costs that are lower. We know there is no single easy solution,<sup>5</sup> but at the same time we have learned that IT organizations can incrementally move IT architectures to reflect increased loose coupling and to make technology better represent how the business works and allow the business to respond to change on its terms. SOMA provides the detailed guidance for making this goal achievable.

SOMA has a rich WBS that comprises activities, tasks, and corresponding inputs and outputs. Scopes for the enterprise can scale down to the simple project testing of new Web services. It can be configured to be leaner (SOMA Agile), to support projects focused solely on integration or testing Web services, or it can be configured to a more rigorous method supporting business- or enterprise-wide transformations (SOMA Complete). SOMA can be

used to support identification and prioritization of high-priority services or it can be used to develop an application or system adopting SOA.

Any project that adopts object orientation and component-based development as part of its software engineering practices should adopt the construct of a service and its corresponding identification, specification, and realization techniques as a software engineering best practice. Whether or not the service is exposed to external partners is simply an architectural or business decision; however, the service construct promotes improved and recombinant separation of concerns of components and objects in a manner that is not presently done with other approaches.

SOA-based solutions will benefit from using the prescriptive guidance provided as part of SOMA. SOMA has a fractal life-cycle model that is used in successive iterations of service releases, which makes it possible for solutions to evolve beyond the more traditional iterative and incremental changes.

## ACKNOWLEDGMENTS

Many people at IBM worldwide have contributed to the ideas and concepts represented in SOMA, and they are too numerous to identify individually, but we are appreciative of all of them. SOMA would not have been possible without the contributions of our esteemed colleagues.

\*\*Trademark, service mark, or registered trademark of Object Management Group, Inc, Sun Microsystems, Inc., ACORD Corporation, or TeleManagement Forum Corporation in the United States, other countries, or both.

## CITED REFERENCES

1. D. L. Parnas, "On the Criteria to be Used in Decomposing Systems into Modules," *Communications of the ACM* **15**, No. 12, 1053–1058 (1972).
2. G. Booch, J. Rumbaugh, and I. Jacobson, *The Unified Modeling Language User Guide*, Addison-Wesley, Boston (1999).
3. E. Gamma, R. Helm, R. Johnson, and J. Vlissides, *Design Patterns: Elements of Reusable Object-Oriented Software Architecture*, Addison-Wesley Professional, Boston (1995).
4. A. Arsanjani, L.-J. Zhang, M. Ellis, A. Allam, and K. Channabasavaiah, "S3: A Service-Oriented Reference Architecture," *IEEE IT Professional* **9**, No. 3, 10–17 (2007).
5. A. Arsanjani, L.-J. Zhang, M. Ellis, A. Allam, and K. Channabasavaiah, "Design an SOA Solution Using a Reference Architecture," IBM developerWorks, IBM

- Corporation (2007), <http://www.ibm.com/developerworks/library/ar-archtemp/>.
6. O. Zimmerman, P. Krogdahl, and C. Gee, "Elements of Service-Oriented Analysis and Design," IBM developerWorks, IBM Corporation (2004), <http://www.ibm.com/developerworks/library/ws-soad1/>.
  7. A. Arsanjani and K. Holley, "The Service Integration Maturity Model: Achieving Flexibility in the Transformation to SOA," *Proceedings of the IEEE International Conference on Services Computing*, Chicago (2006), pp. 515.
  8. A. Arsanjani, "Service-oriented Modeling and Architecture: How to Identify, Specify and Realize Services for Your SOA," IBM developerWorks, IBM Corporation (2004), <http://www.ibm.com/developerworks/library/ws-soa-design1/>.
  9. R. Varadan, K. Channabasavaiah, S. Simpson, K. Holley, and A. Allam, "Increasing Business Flexibility and SOA Adoption Through Effective SOA Governance," *IBM Systems Journal* **47**, No. 3, 473-488 (2008, this issue).
  10. B. W. Boehm, "A Spiral Model of Software Development and Enhancement," *IEEE Computer* **21**, No. 5, 61-72 (1988).
  11. L. Bass, P. Clements, and R. Kazman, *Software Architecture in Practice*, Addison-Wesley Professional, Boston (1998).
  12. L.-J. Zhang, A. Arsanjani, A. Allam, D. Lu, and Y.-M. Chee, *Proceedings of the IEEE International Conference on Services Computing*, "Variation-Oriented Analysis for SOA Solution Design," Salt Lake City, UT, (2007), pp. 560-568.
  13. K. Levi and A. Arsanjani, "A Goal-driven Approach to Enterprise Component Identification and Specification," *Communications of the ACM* **45**, No. 10, 45-52 (2002).
  14. G. Sauter, B. Mathews, M. Selvage, and E. Lane, "Information Service Patterns, Part 1: Data Federation Pattern," IBM developerWorks, IBM Corporation (2006), <http://www-128.ibm.com/developerworks/webservices/library/ws-soa-infoserv1/>.
  15. M. Keen, O. Adinolfi, S. Hemmings, A. Humphreys, H. Kanthi, and A. Nottingham, "Patterns: SOA with an Enterprise Service Bus in WebSphere Application Server V6," IBM Redbooks (2005), <http://www.redbooks.ibm.com/abstracts/sg246494.html>.
  16. A. Arsanjani, "Rule Object 2001: A Pattern Language for Adaptive and Scalable Business Rule Construction," *Proceedings of the 8th Conference on Pattern Languages of Programs*, Monticello, IL (2001), [http://jerry.cs.uiuc.edu/~plop/plop2001/accepted\\_submissions/PLoP2001/AArsanjani1/PLoP2001\\_AArsanjani1\\_0.pdf](http://jerry.cs.uiuc.edu/~plop/plop2001/accepted_submissions/PLoP2001/AArsanjani1/PLoP2001_AArsanjani1_0.pdf).

*Accepted for publication February 7, 2008.*

*Published online August 6, 2008.*

#### **Ali Arsanjani**

IBM Global Business Services, 625 32nd Avenue SW, Suite 130, Cedar Rapids, IA 52404 ([arsanjani@us.ibm.com](mailto:arsanjani@us.ibm.com)). Dr. Arsanjani is an IBM Distinguished Engineer and Chief Technical Officer, Emerging SOA Technologies, supporting larger IBM clients in complex, distributed projects. He leads the 6000-member IBM SOA Community of Practice and is a member of the IEEE and the IBM Academy of Technology. He received a Ph.D. degree in computer science and engineering from DeMontfort University, U.K.

#### **Shuvanker Ghosh**

IBM Global Business Services, 3031 N. Rocky Point Drive West, Tampa, FL 33607 ([sghosh@us.ibm.com](mailto:sghosh@us.ibm.com)). Mr. Ghosh is a member of the SOA and Web Services Center of Excellence, supporting IBM clients in financial services and health care. He is a member of the IBM SOMA team. His interests include SOA, industry models, assets and solution, component-based development, and distributed computing. He received a B.S. degree in mechanical engineering from the Indian Institute of Technology (IIT), India, and an M.S. degree in mechanical engineering from the University of Maryland at College Park.

#### **Abdul Allam**

IBM Global Business Services, 3100 Smoketree Court, Raleigh, NC 27604 ([allam@us.ibm.com](mailto:allam@us.ibm.com)). Mr. Allam is a certified executive IT architect in application development practice. He has published several papers on SOA and SOA reference architecture for IBM developerWorks and IEEE publications. His current focus is developing SOA estimation models, SOA reference architecture, and context-aware services. He holds an M.S. degree in systems science and an M.B.A. degree, both from the University of Ottawa.

#### **Tina Abdollah**

IBM Global Business Services, 100 N. Sepulveda Boulevard, El Segundo, CA 90245 ([abdollah@us.ibm.com](mailto:abdollah@us.ibm.com)). Ms. Abdollah is a certified executive IT architect in the Enterprise and Architecture Technology practice. She is a member of the SOA and Web Services Center of Excellence and SOMA and SOA acceleration teams. She was awarded the 2007 EA&T Best Efforts Award, the 2007 National Women of Color Technology All-Stars Award, and an IBM developerWorks Author Award. She received a B.S. degree in economics from the National Cheng-chi University of the Republic of China, a B.S. degree in computer information science from Santa Monica College, and an M.S. degree in library and information science from the University of California at Los Angeles.

#### **Sella Ganapathy**

IBM Global Business Services, 4400 N. 1st Street, Suite 100, San Jose, CA 95134 ([sellag@us.ibm.com](mailto:sellag@us.ibm.com)). Mr. Ganapathy is a senior IT architect and senior certified IT specialist and a member of the IBM SOMA team. His interest is in developing and deploying the SOMA method for implementing SOAs. He also has expertise in enterprise application integration. He received an M.S. degree in industrial engineering from the Dr. Ambedkar Institute of Productivity, India, and a B.S. degree in chemical engineering from Annamalai University, India.

#### **Kerrie Holley**

IBM Global Business Services, 425 Market Street, San Francisco, CA 94105 ([klholley@us.ibm.com](mailto:klholley@us.ibm.com)). Mr. Holley is an IBM Fellow. He is the chief technical officer (CTO) of the IBM SOA CoE and a member of the IBM Academy of Technology. His responsibilities include technical leadership for SOA projects, architecture and design, technical oversight, enterprise architecture design, and IT strategy. As CTO, he is responsible for IBM SOA delivery methods and related tools. His focus is on helping customers realize the sustained benefits of applying SOA. As an IBM Fellow, he helps define IBM SOA strategy and direction. He has a B.A. degree in mathematics from DePaul University and a J.D. degree in law from the DePaul School of Law. ■