

CERN 84-11
Super Proton Synchrotron
Division
8 October 1984

ORGANISATION EUROPÉENNE POUR LA RECHERCHE NUCLÉAIRE
CERN EUROPEAN ORGANIZATION FOR NUCLEAR RESEARCH

SOME FUNDAMENTAL ASPECTS OF FLUCTUATIONS
AND COHERENCE IN CHARGED-PARTICLE BEAMS
IN STORAGE RINGS^{*)}

Swapan Chattopadhyay^{**)}

GENEVA
1984

^{*)} Invited contribution to the Proceedings of the 1983 Summer School on Physics of High-Energy Particle Accelerators held at Brookhaven National Laboratory, Upton, New York, USA, 6-16 July 1983, and to be published in the American Institute of Physics Conference Proceedings Series.

^{**)} Permanent address: Lawrence Berkeley Laboratory, Berkeley, Calif., USA.

© Copyright CERN, Genève, 1984

Propriété littéraire et scientifique réservée pour tous les pays du monde. Ce document ne peut être reproduit ou traduit en tout ou en partie sans l'autorisation écrite du Directeur général du CERN, titulaire du droit d'auteur. Dans les cas appropriés, et s'il s'agit d'utiliser le document à des fins non commerciales, cette autorisation sera volontiers accordée.

Le CERN ne revendique pas la propriété des inventions brevetables et dessins ou modèles susceptibles de dépôt qui pourraient être décrits dans le présent document; ceux-ci peuvent être librement utilisés par les instituts de recherche, les industriels et autres intéressés. Cependant, le CERN se réserve le droit de s'opposer à toute revendication qu'un usager pourrait faire de la propriété scientifique ou industrielle de toute invention et tout dessin ou modèle décrits dans le présent document.

Literary and scientific copyrights reserved in all countries of the world. This report, or any part of it, may not be reprinted or translated without written permission of the copyright holder, the Director-General of CERN. However, permission will be freely granted for appropriate non-commercial use.

If any patentable invention or registrable design is described in the report, CERN makes no claim to property rights in it but offers it for the free use of research institutions, manufacturers and others. CERN, however, may oppose any attempt by a user to claim any proprietary or patent rights in such inventions or designs as may be described in the present document.

ABSTRACT

A conceptual survey and exposition is presented of some fundamental aspects of fluctuations and coherence, as well as the interplay between the two, in coasting charged-particle beams—both continuous and bunched—in storage rings. A detailed study is given of the spectral properties of the incoherent phase-space Schottky fluctuations, their propagation as waves in the beam, and the analytic complex coherent beam electromagnetic response or transfer function. The modification or distortion of these by collective interactions is examined in terms of simple regeneration mechanisms. Collective or coherent forces in the beam-storage-ring system are described by defining suitable impedance functions or propagators, and a brief discussion of the coherent collective modes and their stability is provided, including a general and rigorous description of the Nyquist stability criterion. The nature of the critical fluctuations near an instability threshold is explored. The concept of Landau damping and its connection with phase-mixing within the beam is outlined. The important connection between the incoherent fluctuations and the beam response, namely the Fluctuation-Dissipation relation, is revealed. A brief discussion is given of the information degrees of freedom, and effective temperature of the fluctuation signals. Appendices provide a short résumé of some general aspects of various interactions in a charged-particle beam-environment system in a storage ring and a general introduction to kinetic theory as applied to particle beams.

CONTENTS

1. Introduction	1
2. The Unperturbed Single-Particle Orbits	4
3. Fluctuations: Schottky Noise	11
4. Information Degrees of Freedom in Fluctuation Signals	48
5. Coherent Beam Response: Concepts	53
6. Coherent Beam Response: Microscopic Kinetic-Theoretical Formalism	66
7. Coherent Beam Response: Examples	76
8. The Collective Forces	88
9. Collective Distortion of Beam Response	95
10. Coherent Collective Modes and their Stability	103
11. Collective Distortion of Fluctuation Spectrum	109
12. Critical Fluctuations	127
13. Landau Damping and Phase Mixing	129
14. Fluctuation-Dissipation Relation	135
15. Epilogue	139
Acknowledgements	139
Appendix A	141
Appendix B	148
References	153

In the garden of Indra shine a million pearls,
reflecting and caught in a web.
Each pearl, by reflecting its neighbour,
reflects the infinity of all the others
and their images.

From the *Avatamsaka Sutra*

1. INTRODUCTION

The physics of charged-particle beams in accelerators and storage rings incorporates techniques and concepts in classical and modern physics in its extreme variety. The fundamental interaction relevant to a charged-particle beam-storage-ring system is of electromagnetic origin only. Yet the basic dynamical processes consistently allowed and exhibited by the system are very large in number indeed. They have observable effects that are extremely relevant either for the purpose of diagnostics or as important tools for understanding the usefulness or basic limitations of the accelerator as an experimental apparatus directed towards a specific goal. Occasionally, deeper studies of some of these processes have led to fundamentally new dimensions in basic physics research. For example, stochasticity in synchrotron motion and the beam-beam interaction in the colliding mode has given practical motivation and renewed impetus to non-linear dynamics, and the study of Schottky fluctuations in a particle beam has initiated the whole new field of stochastic cooling, the singularly distinctive invention behind the recent discovery (1983) of the massive weak quanta W^\pm and Z^0 , the intermediate vector bosons (IVBs) at CERN.

The rich variety of processes in accelerators and storage rings stems from the fact that the number of particles in a charged-particle beam is large, but finitely so. The number is neither too small (e.g. five or ten or a hundred), so that a finite small number of normal modes will suffice for a description of the few-body system, nor too large (e.g. 10^{23}), so that one can treat the beam as a continuous fluid in configuration. Thus it is that there exist in particle beams intrinsic fluctuations due to a finite number of discrete particles, as well as coherence or collective correlations due to the rather large number of interacting particles; they are both manifest with equal strength in beam behaviour. For a satisfactory description, one thus needs to resort to the rather unappetizing formalism of general kinetic theory in the microscopic phase space of the many-body system. Nevertheless, this richness in the variety of physical processes in storage rings can mostly be understood in terms of its three categorical aspects: a) the incoherent discrete single-particle phenomena; b) the coherent collective phenomena; and c) the interesting and subtle interplay between aspects (a) and (b) above.

Aspect (a) reminds us of keywords such as scattering, fluctuations, diffusion, etc. The corresponding relevant processes in accelerators are intrabeam multiple Coulomb scattering, Schottky fluctuations in a charged-particle beam, RF noise diffusion, Schottky noise diffusion in stochastic cooling, quantum fluctuations in e^\pm storage rings, synchrotron radiation damping, incoherent beam-beam effect, etc. Aspect (b) embodies the key concept of correlation or

coherence. Collective phenomena are manifestations of the dynamics of correlations in the phase space of dynamical variables at different hierarchical levels. The corresponding processes are numerous: the coherent oscillation modes and instabilities (both hydrodynamic and Vlasov kinetic types) of the charged-particle beam; phenomenon of coherent beam response; Landau damping; mixing, etc. Aspect (c) involves feedback between (a) and (b) and is variously known as the closed-loop distortion effect, dynamic screening or shielding (e.g. Debye shielding in plasmas), induced polarization, etc. The particular processes are the distortion of incoherent Schottky fluctuations and the coherent electromagnetic response of a beam either by collective interaction with the storage ring impedance or by coherent feedback through the beam and the gain of a stochastic cooling loop, incoherent frequency shift of particles by collective interaction with a reactive impedance (space-charge), critical fluctuations near an instability (i.e. near a collective phase transition), induced friction in electron cooling, etc. It is worth mentioning here that the process of stochastic cooling is one of a few uniquely distinctive cases where all the above three aspects (a), (b), and (c) manifest themselves to a significant degree. In addition, stochastic cooling provides the unique case where the dynamics is not conservative and Hamiltonian, but where genuinely non-conservative (dissipative) self-interaction of a particle is induced by a properly matched feedback loop (see Appendix A).

It is not the purpose of this exposé to give an encyclopaedic account of all these various processes at work in charged-particle storage rings. What is intended rather is to provide the skeleton of a cogent fundamental conceptual formalism, wedded to some basic physical illustrations for only three fundamental generic aspects that have been singled out: fluctuations, coherence, and the interplay between the two. It is hoped that the exposition will induce some appreciation, on the part of the reader, of the importance of these aspects, that it will provide an introduction to some of the key concepts, will equip him or her with the necessary theoretical framework to understand and analyse them and, lastly, to the newly initiated, will provide some amount of cohesiveness, necessary in the ever-broadening field of particle accelerators.

This article then is multipurpose and partly pedagogical in nature. However, it also contains a fair amount of original research. Mainly because of its very nature, the essay will take the form of a mosaic of different concepts and different areas, a mixture of the known and the unknown, always hinged nevertheless to a basic underlying formalism. Pedagogy allows for a certain amount of diversion and playfulness with the basic ideas, and we will indulge in some without pretense. In order that the necessary abstraction is not too imposing, we will try to keep close to the physical observables. For fear that it will not be possible to see the wood for the trees, we only provide the conceptual framework at a fundamental level, followed by physical discussions and a few simple illustrations. The technicalities of particular cases and applications are only hinted at and are sometimes stated without derivation; most of them are referred to in the references cited at the end of this paper.

In the following we do not consider the beam dynamics under acceleration at all. We thus consider charged-particle beams in circular accelerators of the storage-ring type, in the storage or colliding mode where there is always a nominal reference particle in the beam, continuous or bunched, which coasts at a fixed angular velocity around the ring with a fixed energy.

A few remarks on the notation and conventions adopted in this report are also in order. We adopt the symbol γ_r to denote the relativistic gamma factor of a particle in the storage ring. It is simply the ratio of the particle's total energy E to its rest energy E_0 : $E = \gamma_r E_0$. The symbol γ_{tr} denotes the gamma factor corresponding to the 'transition energy' of the storage ring¹⁻³⁾, above

which the particles in the storage ring have anomalous dispersion in revolution angular frequencies relative to kinematic momentum, i.e. above which $d\omega(p)/dp$ is negative. The machine 'off-energy function' η is defined in our report as

$$\eta = \frac{1}{\gamma_{tr}^2} - \frac{1}{\gamma_r^2} \quad (1.1)$$

so that the dispersion in angular frequencies is given by

$$\frac{\Delta\omega}{\omega_0} = -\eta \frac{\Delta p}{p_0} \quad (1.2)$$

Thus η is negative below transition energy $\gamma_r < \gamma_{tr}$ and positive above transition energy $\gamma_r > \gamma_{tr}$, in our convention. The symbol γ is reserved for a vanishingly small positive number, which is always taken to the limit $\gamma \rightarrow 0^+$. It will appear very frequently in our discussions on the coherent beam response, and has very special and significant implications for collective properties of the beam-storage-ring system.

Our convention for the Fourier transform of a time-function is

$$\tilde{g}(\Omega) = \int_{-\infty}^{+\infty} dt e^{i\Omega t} g(t) \quad (1.3)$$

with inverse

$$g(t) = \frac{1}{2\pi} \int_{-\infty}^{+\infty} d\Omega \tilde{g}(\Omega) e^{-i\Omega t} \quad (1.4)$$

The delta-function then is represented by

$$\delta(\Omega) = \frac{1}{2\pi} \int_{-\infty}^{+\infty} dt e^{i\Omega t} \quad (1.5)$$

In the literature of applied electrotechnology, one encounters the symbol j instead of i . The relevant transforms as defined there are simply obtained from the above by the replacement $j \rightarrow (-i)$. All the gymnastics in the complex Ω -plane (analyticity, upper and lower half-planes in complex Ω , and all that) will then necessarily reflect this change of sign in the definition of transforms.

Quantities varying in azimuth θ in the storage ring and time are frequently decomposed into circular wave-like states with the convention for the azimuthal harmonic-frequency decomposition as follows:

$$\rho(\theta, t) = \frac{1}{2\pi} \sum_{m=-\infty}^{+\infty} \int_{-\infty}^{+\infty} d\Omega \tilde{\rho}_m(\Omega) e^{i(m\theta - \Omega t)} \quad (1.6)$$

with inverse

$$\tilde{\rho}_m(\Omega) = \frac{1}{2\pi} \int_0^{2\pi} d\theta \int_{-\infty}^{+\infty} dt \rho(\theta, t) e^{-i(m\theta - \Omega t)} \quad (1.7)$$

2. THE UNPERTURBED SINGLE-PARTICLE ORBITS

A charged-particle beam is confined spatially by the focusing electromagnetic fields of the storage-ring lattice. Neglecting all other interactions, each particle in a beam moves in an externally applied space-time dependent guiding electromagnetic field distributed around the ring. A single-particle Lagrangian is simply

$$\mathcal{L}_i^0 = -m_0 c^2 \left[1 - \frac{\vec{v}_i \cdot \vec{v}_i}{c^2} \right]^{\frac{1}{2}} - q \Phi_{\text{ext}}(\vec{r}_i, t) + \frac{q}{c} [\vec{v}_i \cdot \vec{A}_{\text{ext}}(\vec{r}_i, t)] , \quad (2.1)$$

$$i = 1, \dots, N,$$

where $\Phi_{\text{ext}}(\vec{r}_i, t)$ and $\vec{A}_{\text{ext}}(\vec{r}_i, t)$ are the scalar and vector potentials of the external electromagnetic field sampled on the particle trajectory $\vec{r}_i(t)$ at time t ; $\vec{v}_i = \dot{\vec{r}}_i$, the particle velocity; q is the electric charge; and m_0 is the rest mass of the particles. Here the potentials are defined via Maxwell's equations in such a way that the actual electromagnetic fields \vec{E}_{ext} and \vec{B}_{ext} are given by the usual relations

$$\vec{B}_{\text{ext}} = \nabla \times \vec{A}_{\text{ext}} , \quad (2.2)$$

$$\vec{E}_{\text{ext}} = -\nabla \Phi_{\text{ext}} - \frac{1}{c} \frac{\partial \vec{A}_{\text{ext}}}{\partial t} .$$

In terms of canonical momenta

$$\vec{P}_i = \frac{\partial \mathcal{L}_i^0}{\partial \vec{v}_i} = \frac{m_0 \vec{v}_i}{\left[1 - \frac{\vec{v}_i \cdot \vec{v}_i}{c^2} \right]^{\frac{1}{2}}} + \frac{q}{c} \vec{A}_{\text{ext}}(\vec{r}_i, t) = \vec{p}_i + \frac{q}{c} \vec{A}_{\text{ext}}(\vec{r}_i, t) , \quad (2.3)$$

where $\vec{p}_i = \gamma_r m_0 \vec{v}_i$ is the ordinary kinetic or mechanical momentum, the Hamiltonian associated with \mathcal{L}_i^0 is

$$\mathcal{H}_i^0 = \vec{P}_i \cdot \vec{v}_i - \mathcal{L}_i^0 = \left\{ m_0^2 c^4 + c^2 \left[\vec{P}_i - \frac{q}{c} \vec{A}_{\text{ext}}(\vec{r}_i, t) \right]^2 \right\}^{\frac{1}{2}} + q \Phi_{\text{ext}}(\vec{r}_i, t) . \quad (2.4)$$

The single-particle equations of motion are simply given by

$$\dot{\vec{r}}_i = \partial \mathcal{H}_i^0 / \partial \vec{P}_i , \quad \dot{\vec{P}}_i = -\partial \mathcal{H}_i^0 / \partial \vec{r}_i . \quad (2.5)$$

The Lagrangian and Hamiltonian of the whole beam containing N particles, in the absence of interparticle or any other interactions, are simply

$$\mathcal{L}_{\text{beam}}^0 = \sum_{i=1}^N \mathcal{L}_i^0 \quad \text{and} \quad \mathcal{H}_{\text{beam}}^0 = \sum_{i=1}^N \mathcal{H}_i^0 . \quad (2.6)$$

In a storage ring, one conveniently uses the orthogonal right-handed coordinate system illustrated in Fig. 1, where $[s,x,z]$ locates a single particle in the ring with respect to the closed ideal design orbit in the median plane for a particle having the ideal longitudinal momentum $p = p_0$. The vector potential $\vec{A}_{\text{ext}}(\vec{r},t)$ is usually provided by the magnetic focusing fields B_x, B_z which confine the particles transversely in the $(z-x)$ plane and the magnetic bending fields. The focusing fields are such that transversely the particles execute betatron oscillations about an equilibrium orbit. Longitudinally the particles either drift along free-streaming orbits with constant angular velocity (continuous coasting beam), in which case one may conveniently choose $\Phi_{\text{ext}} \equiv 0$, or execute synchrotron (energy) oscillations about a synchronous particle (bunched beam), in which case $\Phi_{\text{ext}}(\vec{r},t)$ and $\vec{A}_{\text{ext}}(\vec{r},t)$ as relevant for longitudinal motion, are provided by the longitudinal electric fields E_s of the longitudinally focusing travelling- or standing-wave radio-frequency cavities. We consider only non-accelerating stationary bunches where the synchronous particle moves with constant angular velocity by sampling the phase-locked radio-frequency cavity voltage at each turn with such phase that it always sees zero longitudinal field ($E_s = 0$). In most cases the betatron oscillations in directions transverse to the beam are very weakly coupled to the synchrotron oscillations in energy. This is so because the synchrotron oscillation frequencies are usually very small compared with the betatron oscillation frequencies, and the betatron oscillations average to zero over a long synchrotron period.

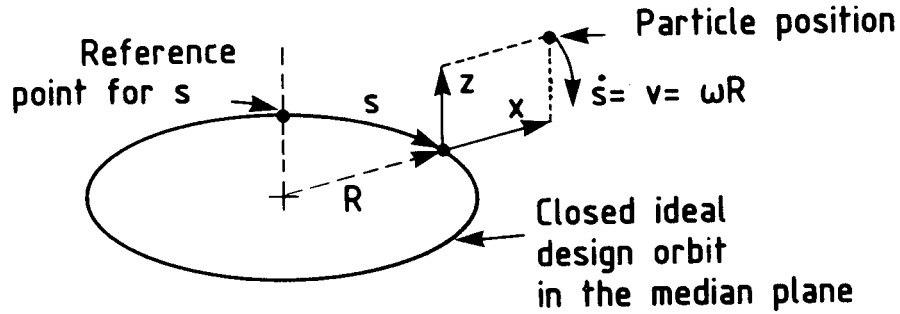

- x = Radial displacement in the median plane.
- z = Vertical displacement perpendicular to the median plane.

Fig. 1 Coordinate system for single-particle orbits in a storage ring

We do not rediscuss here the details of the transverse and longitudinal particle orbits in ideal storage rings, which are described at length in standard texts¹⁻³⁾ and classic review papers⁴⁻⁶⁾. Generally speaking, the particles in the storage ring can be described⁷⁾ as circulating three-dimensional oscillators with canonical action-angle variables of oscillation $(\vec{I}, \vec{\psi}) \equiv [(I_x, I_z, J); (\phi_x, \phi_z, \psi)]$ satisfying equations of motion

$$\begin{aligned} \dot{\vec{I}} &= 0, \quad \text{i.e. } I_x, I_z, J \text{ are constants of motion,} \\ \dot{\vec{\psi}} &= \vec{\omega}(\vec{I}), \quad \text{i.e. } \vec{\psi}(t) = \vec{\omega}(\vec{I})t + \vec{\psi}^0, \end{aligned} \tag{2.7}$$

where the action-dependent oscillation frequencies $\vec{\omega} \equiv [\omega_x(I_x), \omega_z(I_z), \omega_s(J)]$ include non-linear oscillations. In the linear approximation, the lateral transverse betatron motion, when observed at a particular azimuth $s = s_0$, is indistinguishable from a sampled simple harmonic oscillation at a

frequency $\omega_{x,z} = Q_{x,z}\omega$ called the betatron frequencies, with betatron displacement, say for the z-motion, being given by

$$z_{s_0}(t_j) = a_z \sqrt{\beta_z(s_0)} \sin [Q_z \omega t_j + \phi_{0,s_0}^z] , \quad (2.8)$$

where $t_j = jT = (2\pi/\omega)j$ are the times for the j^{th} passage ($j = 0, 1, 2, \dots$) through the azimuth $s = s_0$; ϕ_{0,s_0}^z is the phase at 0^{th} passage ($j = 0$), ω is the angular frequency of revolution of the particle; a_z is an arbitrary constant depending on initial conditions; and

$$Q_{x,z} = \frac{1}{2\pi} \int_0^{C=2\pi R} \frac{ds}{\beta_{x,z}(s)} \quad (2.9)$$

are known as the x,z betatron tunes (number of betatron oscillations in one complete revolution). In fact, the betatron oscillations detected at a particular azimuth $s = s_0$, arise solely from the fractional part Q^f of $Q = n' + Q^f$, where n' is a positive integer, due to 'aliasing', as is evident from Eq. (2.8). The actual orbit as a function of azimuth s is described by pseudoharmonic betatron oscillations with both phase and amplitude depending on the instantaneous wavelenghts $\beta_{x,z}(s)$ (also called the 'amplitude functions') which satisfy

$$\frac{1}{2} \beta_{x,z}(s) \beta_{x,z}''(s) - \frac{1}{4} \beta_{x,z}'^2(s) + k_{x,z}(s) \beta_{x,z}^2(s) = 1 , \quad (2.10)$$

$$\beta_{x,z}(s+L) = \beta_{x,z}(s) ,$$

where $\beta' = d\beta(s)/ds$, $L = C/N$ is the circumferential length of one period of the N-fold periodic focusing lattice within the full circumference of length C , and $k_{x,z}(s)$ are certain 'field gradients' determined by the magnetic field configuration of the focusing magnets.

We will use the following amplitude-phase representation of linear betatron oscillations at a fixed azimuth:

$$x(t) = A_x \sin \phi_x(t) ; \quad \dot{x}(t) = A_x Q_x \omega \cos \phi_x(t) , \quad (2.11)$$

and

$$z(t) = A_z \sin \phi_z(t) ; \quad \dot{z}(t) = A_z Q_z \omega \cos \phi_z(t) ,$$

where

$$\phi_{x,z}(t) = Q_{x,z} \omega t + \phi_{x,z}^0 . \quad (2.12)$$

With $Q_{x,z}$ independent of oscillation amplitudes $A_{x,z}$ in the linear regime, particles rotate in circles of radius $A_{x,z}$ with frequencies $Q_{x,z}\omega$ in $(x, \dot{x}/Q_x\omega)$ and $(z, \dot{z}/Q_z\omega)$ phase planes (Fig. 2). The variables $I_{x,z} = \frac{1}{2} A_{x,z}^2 Q_{x,z} \omega \cdot m_0$ and $\phi_{x,z}$ represent the familiar canonical action and angle variables for a linear harmonic oscillator obtained by a canonical transformation $(x, \dot{x}) \rightarrow (I_x, \phi_x)$ and similarly for the z-motion. If we split the tune into integer and fractional parts $Q_{x,z} = n'_{x,z} + Q^f_{x,z}$, then after one complete turn in the storage ring, the point in the phase plane in Fig. 2 has made n'_x revolutions of the circle (n'_z revolutions for z-motion) plus an angle $2\pi Q_x^f$ ($2\pi Q_z^f$ for z-motion). Note that as far as betatron oscillations at a particular azimuth are concerned, what

happens within a single turn is immaterial and the phase point in Fig. 2 traces out the full circle in discrete steps of $2\pi Q_{x,z}^f$ in angle sampled at times $t = jT = j(2\pi/\omega)$, as long as $Q_{x,z}$ is not a simple integer or vulgar fraction (i.e. away from resonance $l_x Q_x + l_z Q_z = l$, where l_x, l_z, l are integers). In case of resonance the point will return to the same position in the phase plane after a characteristic number of turns and may give rise to resonant growth (arising from spontaneous disturbances), which is to be avoided.

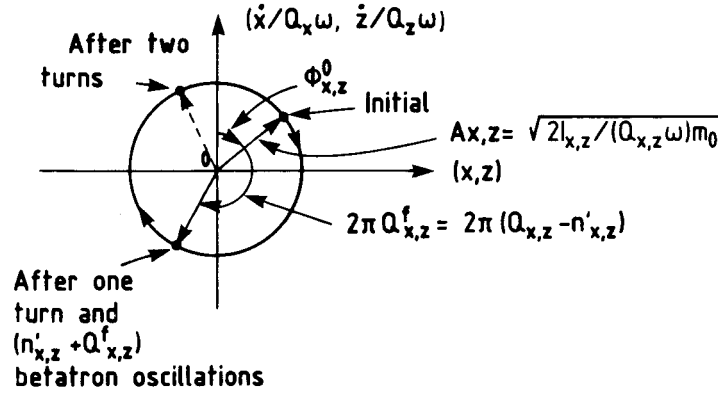

Fig. 2 Rotation in the phase plane in the amplitude-phase representation of linear betatron oscillation

A particle of longitudinal momentum $p = p_0 + \Delta p$ deviating from the design momentum p_0 will execute its betatron oscillations about a closed orbit displaced radially from the central p_0 orbit by an amount $x_0(s) = \alpha_p(s)(\Delta p/p)$, where $\alpha_p(s)$ is known as the ‘momentum compaction function’ of the machine⁶. The total horizontal displacement is $x(s) = x_\beta(s) + \alpha_p(s)(\Delta p/p)$, where $x_\beta(s)$ is the true betatron displacement relative to the displaced closed orbit corresponding to $p = p_0 + \Delta p$. The change of β_x and β_z with p has a negligible effect on the amplitudes, but the wave numbers or betatron tunes become modified to

$$Q_{x,z}(p) = Q_{x,z}(p_0) [1 + \xi_{x,z} (\Delta p/p)] , \quad (2.13)$$

where ξ_x, ξ_z are the horizontal and vertical ‘natural chromaticities’ of the storage ring. There may be additional contributions to the chromaticities $\xi_{x,z}$ in Eq. (2.13), other than the ‘natural chromaticities’ due to finite non-zero Δp , usually determined and controlled by the multipole fields (sextupole, etc.) of the magnetic lattice.

Longitudinally, for continuous coasting beams filling the whole ring, the particles coast in free-streaming orbits with constant angular velocity. There are no longitudinal synchrotron oscillations. The circular streaming motion around the ring may be represented by canonical action and angle variables as:

$$J = \int_{E_0}^E \frac{dE}{\omega} \quad (2.14)$$

and

$$\psi(t) = \theta(t) - \theta_0(t) = (\omega - \omega_0)t + \psi^0 = \Delta\omega \cdot t + \psi^0 , \quad (2.15)$$

where E_0, ω_0 , and $\theta_0(t)$ are the energy, angular revolution frequency, and azimuthal position as a function of time of a nominal reference particle in the beam.

For bunched beams, bunched by an arbitrary scaled RF potential $V(\phi)$ seen by the beam and generated by an RF cavity, the synchrotron oscillations can be described by the scaled Hamiltonian⁷⁾ (with units of s^{-2}):

$$\mathcal{H} = \frac{1}{2} P_\phi^2 + V(\phi) , \quad (2.16)$$

where $\phi(t)$ represents the deviation at time t of the particle's RF phase from the synchronous value, and $P_\phi(t) = \dot{\phi}(t)$, the conjugate momentum. The equation of motion corresponding to (2.16) is

$$\ddot{\phi} + V'(\phi) = 0 . \quad (2.17)$$

We can perform a canonical Hamilton-Jacobi transformation⁸⁾ $(\phi, P_\phi) \rightarrow (\tau, E)$ by introducing a generating function $W(\phi, E)$ determined by

$$\frac{1}{2} \left[\frac{\partial W(\phi, E)}{\partial \phi} \right]^2 + V(\phi) = E . \quad (2.18)$$

The new canonical variables (τ, E) are related to (ϕ, P_ϕ) via

$$\tau = \frac{\partial W(\phi, E)}{\partial E} = \int_0^\phi \frac{d\phi'}{\sqrt{2[E - V(\phi')]}}, \quad (2.19)$$

$$P_\phi = \frac{\partial W(\phi, E)}{\partial \phi} = \sqrt{2[E - V(\phi)]} . \quad (2.20)$$

The solution of Eq. (2.19) is given by $\phi(E, \tau)$ after inversion, and the transformed Hamiltonian is

$$\tilde{\mathcal{H}} = E . \quad (2.21)$$

The new equations of motion are

$$\begin{aligned} \dot{\tau} &= 1 , \\ \dot{E} &= 0 , \end{aligned} \quad (2.22)$$

which can be trivially integrated to give

$$\begin{aligned} \tau &= \tau_0 + t , \\ E &= E_0 = \text{const.} \end{aligned} \quad (2.23)$$

Thus E and τ are really the scaled invariant total energy (in s^{-2}) and the conjugate time along the particle orbit, respectively. We can now define the scaled action variable $J(E)$ (in units of s^{-1} , which is the unit of scaled angular momentum P_ϕ in our formalism) by

$$2\pi J(E) = \oint P_\phi d\phi = \oint \sqrt{2[E - V(\phi)]} d\phi \quad (2.24)$$

and

$$\frac{\partial J(E)}{\partial E} = \frac{1}{2\pi} \oint \frac{d\phi}{\sqrt{2[E - V(\phi)]}} = \frac{T(E)}{2\pi} = \frac{1}{\omega(E)} \quad , \quad (2.25)$$

where $T(E)$ is the period of synchrotron oscillation. The corresponding angle variable ψ is defined by

$$\psi = \frac{2\pi}{T(E)} \tau = \omega(E)\tau = \omega_s(J)t + \psi^0 \quad , \quad (2.26)$$

where

$$\omega_s(J) = \omega[E(J)] \quad .$$

The longitudinal dynamics described above is very general and is valid for potential wells of arbitrary shapes created by the RF cavities [virtually any arbitrary shape can be created for the potential well by combining two or more RF cavities, each with conventional sinusoidal time-varying electric field with suitable strength and harmonically related frequencies⁹⁾]. For a single RF cavity with sinusoidal excitation at a frequency $\omega_{RF} = h\omega_0$ (h being known as the harmonic of the cavity) as is conventionally used in storage rings, $V(\phi) = -V_0 \cos \phi$ and the longitudinal phase-space trajectories are simply those of a simple pendulum. These are shown in Fig. 3(b) for a stationary bunch, i.e. a coasting bunched beam as opposed to the longitudinal

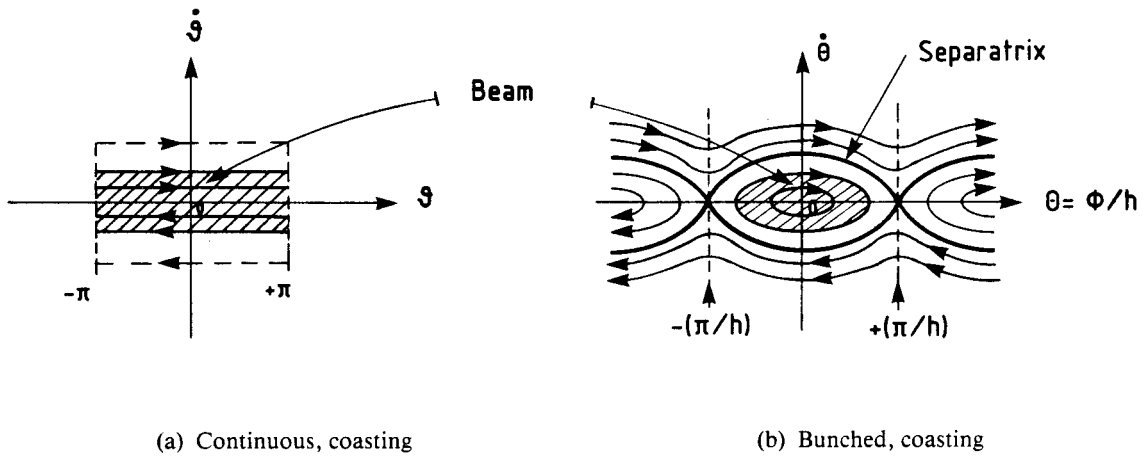

Fig. 3 Longitudinal phase-space trajectories of coasting continuous and sinusoidal RF bunched beams

phase-space trajectories of a continuous ring-filling coasting beam, shown in Fig. 3(a). Here $\Theta = \phi/h$ and $\dot{\Theta}$ are defined as

$$\begin{aligned}\theta(t) &= \omega_0 t + \Theta(t) , \\ \dot{\theta}(t) &= \omega_0 + \dot{\Theta}(t) ,\end{aligned}\tag{2.27}$$

$\theta(t)$ being the azimuth of the particle at time t in the laboratory frame and $\Theta(t)$ the same in the bunch frame moving with angular velocity ω_0 relative to the laboratory.

If the beam particles do not occupy the full trapped region bounded by the separatrices but only a modest fraction of it, it is often convenient to represent the synchrotron oscillations by quasi-linear orbits, which are sinusoidal orbits similar to linear harmonic oscillators with, however, the oscillation frequencies depending on the particle energy or action (i.e. amplitude-dependent non-linear oscillation frequencies) as follows:

$$\Theta = a \sin \psi(t) ,\tag{2.28}$$

$$\dot{\Theta} = a \omega_s(J) \cos \psi(t) ,\tag{2.29}$$

where

$$\psi(t) = \omega_s(J)t + \psi^0 \quad \text{and} \quad J \propto \frac{1}{2} a^2 .\tag{2.30}$$

This representation is valid for only slightly non-linear oscillators, i.e. for small amplitudes, as can be verified from a first-order asymptotic non-linear perturbation series solution¹⁰.

For vanishingly small amplitudes, the oscillations are linear with constant synchrotron frequency ω_s and may be represented by amplitude-phase variables (a, ψ) , leading to constant frequency rotation in the $(\Theta, \dot{\Theta}/\omega_s)$ phase plane similar to betatron oscillations in Fig. 2, with the linear oscillation action¹¹) $J \propto \frac{1}{2} a^2$ (the scaled action in units of s^{-1} is $J = \frac{1}{2} a^2 \omega_s$ in our formalism), except that this representation is valid, as opposed to betatron oscillations, for continuous time. For quasi-linear orbits given by Eqs. (2.28) to (2.30), the phase-plane trajectories when plotted with axes normalized to zero-amplitude particles, i.e. in the $[\Theta, \dot{\Theta}/\omega_s (J=0)]$ plane, form various ellipses with semi-axes $[a]$ and $[a\omega_s(a)/\omega_s(0)]$, except the very small amplitude particles with $\omega_s(a)/\omega_s(0) \approx 1$ which form approximate circles of radius a . The exact trapped trajectories for arbitrary amplitudes no matter how large, as shown in Fig. 3b, are given rigorously in terms of elliptic integrals embedded in each term of an infinite Fourier series containing all the odd harmonics of $\omega_s(J)$ ¹².

Finally, in the most general representation of the three-dimensional oscillations of the particles in the storage ring by action-angle variables $(\vec{I}, \vec{\psi})$, the oscillation amplitudes $x \equiv x(I_x, \phi_x)$, $z \equiv z(I_z, \phi_z)$, and $\Theta \equiv \Theta(J, \psi)$ are periodic functions of the angle variables $\vec{\psi} \equiv (\phi_x, \phi_z, \psi)$ with period 2π .

3. FLUCTUATIONS: SCHOTTKY NOISE

A particle beam can only be partially specified by its macroscopic state, given in terms of a set of statistically averaged quantities such as the average particle number density, average charge density, average current, average transverse displacement, average transverse electric dipole moment, etc. The very necessity of statistical averaging to establish the macroscopic state implies the existence of fluctuations characteristic of the microscopic state. The deviations of the instantaneous values of these macroscopic quantities from their mean values is caused by the finite, albeit large, number of moving particles with randomly distributed phases within the beam, and are called fluctuations of the corresponding physical quantities. One may also consider fluctuations in phase-space functions, e.g. single-particle phase-space distribution fluctuations due to a finite number of particles. Thus the density field in the single-particle phase space of the charged-particle beam may be written as

$$\mathcal{F}(\vec{r}, \vec{v}; t) = \sum_{i=1}^N \delta[\vec{r} - \vec{r}_i(t)] \delta[\vec{v} - \vec{v}_i(t)] \quad , \quad (3.1)$$

where $[\vec{r}_i(t), \vec{v}_i(t)]$ represent the phase-space trajectory of the i^{th} particle. The smoothed single-particle density or distribution function in phase space is just the average of \mathcal{F} :

$$f(\vec{r}, \vec{v}; t) = \langle \mathcal{F}(\vec{r}, \vec{v}; t) \rangle \quad . \quad (3.2)$$

The phase-space fluctuation is then

$$\delta f(\vec{r}, \vec{v}; t) = \mathcal{F}(\vec{r}, \vec{v}; t) - \langle \mathcal{F}(\vec{r}, \vec{v}; t) \rangle = \mathcal{F}(\vec{r}, \vec{v}; t) - f(\vec{r}, \vec{v}; t) \quad , \quad (3.3)$$

with $\langle \delta f(\vec{r}, \vec{v}; t) \rangle = 0$.

Since $\mathcal{F}(\vec{r}, \vec{v}; t)$ is a function of the dynamical variables of all the particles, $\delta f(\vec{r}, \vec{v}; t)$ is macroscopically a stochastic quantity which is governed by the microscopic state of the beam (microscopically, of course, δf is a 'sure' function, since individual particles are known to move in fixed deterministic orbits). The corresponding Fourier components, written as a sum of extremely numerous terms with randomly varying phases, represent a set of random variables and can be analysed in terms of their spectral functions¹³⁾, e.g. power spectrum, etc., defined through the Fourier transform of statistical averages such as multiple correlations etc. that contain information about the detailed time structure.

The study of these beam fluctuations is far from being of academic interest only. In fact the longitudinal current fluctuations and the transverse dipole moment current fluctuations of the beam can be detected as Schottky noise (named after Schottky who first detected the fluctuation noise of a d.c. electron beam in 1918) by suitable low-noise localized longitudinal and transverse electromagnetic pick-ups (PUs) placed around the beam in the storage ring¹⁴⁻¹⁹⁾. This provides us with an extremely useful non-destructive diagnostic tool, as the PUs influence the beam insignificantly while monitoring all the relevant microscopic phase-space information about the beam. For a small number of particles N in the beam, or for small coupling impedance (see Section 8 for definition) of the beam-storage-ring system, the Schottky signal power is proportional to N and its spectral distribution contains information about the particle oscillation frequencies (betatron tunes Q_i , revolution frequencies ω_i , synchrotron oscillation frequencies ω_s^i , etc.), the

total frequency spread $\Delta\omega$ in the beam, beam-phase-space distribution, etc., as we will see in this section. At high intensity, i.e. large N or high coupling impedance, the Schottky signal power is independent of N but proportional to the beam temperature T and the coupling impedance (see Sections 8 and 11). The significance of these beam Schottky fluctuations is, however, most dramatized by the invention of stochastic cooling, where the detection of Schottky signals is ingeniously coupled with the capability of feeding the detected signal appropriately back to the beam phase-space sample generating the same signal with enough power and bandwidth, leading to observable and controllable increase in beam microscopic phase-space density^{7,20-23}). In the final analysis, it may be said that stochastic cooling, a sampled control system of the highest order in the microscopic phase space, is possible because of the existence of beam Schottky fluctuations due to the finite number of particles.

We will study the longitudinal charge and current density and the transverse dipole-moment fluctuation spectra of coasting continuous and bunched beams in a storage ring. The fluctuation signals we consider first are those that are detected by a localized PU, as a function of time only. The longitudinal current at a PU located azimuthally at $\theta = \theta_P$ and due to a particle j in the beam, periodically passing through the PU, is

$$I_j^P(t) = q\omega_j \sum_{m=-\infty}^{+\infty} \delta[\theta_j(t) - \theta_P - 2\pi m] = q \frac{\omega_j}{2\pi} \sum_{m=-\infty}^{+\infty} e^{-im[\theta_j(t) - \theta_P]} \quad , \quad (3.4)$$

where we have used the Fourier series representation of the periodic delta-function sampling at the PU. The total Schottky current signal at $\theta = \theta_P$ due to all the particles $j = 1, \dots, N$ in the beam is given by

$$I^P(t) = q \sum_{j=1}^N \frac{\omega_j}{2\pi} \sum_{m=-\infty}^{+\infty} e^{-im[\theta_j(t) - \theta_P]} \quad . \quad (3.5)$$

Using the unperturbed uncorrelated orbits for a continuous coasting beam particle

$$\theta_j(t) = \omega_j t + \theta_j^0 \quad , \quad (3.6)$$

we obtain

$$I^P(t) = \frac{q}{2\pi} \sum_{j=1}^N \sum_{m=-\infty}^{+\infty} e^{-im(\omega_j t - \theta_P) - im\theta_j^0} \omega_j \quad (3.7)$$

as the time-domain representation of the longitudinal Schottky current signal of a continuous coasting beam at a PU. In the frequency domain, it consists of bands, centred around the revolution harmonics $m\omega_0$, $m = -\infty, \dots, -1, 0, +1, \dots, +\infty$, each band containing a spectrum of lines within it at frequencies $m\omega_j = m(\omega_0 + \Delta\omega_j)$ corresponding to different revolution angular frequencies $\omega_j = \omega_0 + \Delta\omega_j$ of the particles and strengths $q(\omega_j/2\pi) = qf_j$. In the space of real positive physical frequencies, we see that each single particle line has actually a strength $(2qf_j)$ and

a randomly varying phase given by $\Delta\phi_m^j = m(\theta_j^0 - \theta_P)$, except the $m = 0$ d.c. component, where lines due to each particle have strengths (qf_j) and the same zero phase so that they add up coherently:

$$I^P(t) = q \sum_{j=1}^N f_j + 2q \sum_{j=1}^N \sum_{m=1}^{+\infty} f_j \cos(m\omega_j t + \Delta\phi_m^j) \quad (3.8)$$

The negative frequency lines are indistinguishable from the corresponding positive frequency ones since $\cos(m\omega_j t + \Delta\phi_m^j) = \cos(-m\omega_j t + \Delta\phi_{-m}^j)$. The d.c. ($m = 0$) term represents each particle's charge q being spread around the complete circumference of the orbit. One easily sees that the macroscopic beam current is

$$\langle I^P(t) \rangle = \frac{1}{2\pi} \sum_{j=1}^N \int_0^{2\pi} d\theta_j^0 I_j^P(t) = q \sum_{j=1}^N f_j \quad (3.9)$$

and manifests itself only as the d.c. current at the $m = 0$ harmonic. For a beam distributed symmetrically in the angular velocities or frequencies ω around a central value ω_0 , $f(\omega_0 + \Delta\omega) = f(\omega_0 - \Delta\omega)$, and this d.c. current is simply

$$q \sum_{j=1}^N f_j = q \frac{1}{2\pi} \int d\omega \omega \cdot f(\omega) = \frac{q}{2\pi} \int d\Delta\omega (\omega_0 + \Delta\omega) f(\omega_0 + \Delta\omega) = q f_0 N \quad (3.10)$$

the term involving $\Delta\omega$ cancelling by symmetry. The Schottky current *fluctuations* are then

$$\delta I^P(t) = I^P(t) - \langle I^P(t) \rangle = 2q \sum_{j=1}^N \sum_{m=1}^{+\infty} f_j \cos(m\omega_j t + \Delta\phi_m^j) \quad (3.11)$$

No coherent macroscopic signal remains at any non-zero harmonic $m \neq 0$, provided no coherent collective longitudinal modes are excited in the beam by other interactions. Using $f_j = f_0 + \Delta f_j$, we can rewrite the current fluctuations as

$$\delta I^P(t) = 2q f_0 \sum_{j=1}^N \sum_{m=1}^{+\infty} \cos(m\omega_j t + \Delta\phi_m^j) + 2q \sum_{j=1}^N \Delta f_j \sum_{m=1}^{+\infty} \cos(m\omega_j t + \Delta\phi_m^j) \quad (3.12)$$

Both terms above give a set of revolution bands, with exactly the same frequency space structure. However, the second term gives single-particle lines with much smaller relative strengths,

$$\frac{(2q\Delta f_j)}{(2q f_0)} = \frac{\Delta f_j}{f_0} \ll 1 \quad (3.13)$$

since relative frequency spreads in usual beams are extremely small indeed. For small relative spread in revolution frequencies in the beam, the second term is thus of first order in strength relative to the first term and is often neglected from analysis:

$$\delta I^P(t) = 2q f_0 \sum_{j=1}^N \sum_{m=1}^{+\infty} \cos(m\omega_j t + \Delta\phi_m^j) [1 + \mathcal{O}(\Delta f/f_0)] . \quad (3.14)$$

The azimuthal charge density (coulomb/rad) at the PU in time-domain is

$$\rho^P(t) = \frac{q}{2\pi} \sum_{j=1}^N \sum_{m=-\infty}^{+\infty} e^{-im(\omega_j t - \theta_P) - im\theta_j^0} = \frac{qN}{2\pi} + \frac{q}{\pi} \sum_{j=1}^N \sum_{m=1}^{+\infty} \cos(m\omega_j t + \Delta\phi_m^j) , \quad (3.15)$$

and the azimuthal charge density fluctuation, obtained by subtracting the macroscopic azimuthal charge density $\langle \rho^P(t) \rangle = qN/2\pi$, is

$$\delta\rho^P(t) = \rho^P(t) - \langle \rho^P(t) \rangle = \frac{q}{\pi} \sum_{j=1}^N \sum_{m=1}^{+\infty} \cos(m\omega_j t + \Delta\phi_m^j) . \quad (3.16)$$

The transverse Schottky signal of the beam, detected by a transverse PU with linear response, is given by the total transverse dipole-moment current of the beam in the relevant transverse direction:

$$d^P(t) = \sum_{j=1}^N d_j^P(t) = \sum_{j=1}^N x_j(t) I_j^P(t) , \quad (3.17)$$

where $x_j(t) = A_j \cos(Q\omega_j t + \phi_j^0)$ represents the transverse betatron oscillation with tune Q and amplitude A_j of the j^{th} particle. Using the Fourier series representation of the periodic delta-function again, we get

$$\begin{aligned} d^P(t) &= \sum_{j=1}^N qf_j \frac{A_j}{2} \sum_{m=-\infty}^{+\infty} \left\{ e^{-i[(m+Q)\omega_j t - m\theta_P + \phi_j^0 + m\theta_j^0]} + \right. \\ &\quad \left. e^{-i[(m-Q)\omega_j t - m\theta_P - \phi_j^0 + m\theta_j^0]} \right\} \\ &= \sum_{j=1}^N qf_j A_j \sum_{m=-\infty}^{+\infty} \cos[(m+Q)\omega_j t + \Delta\phi_m^j + \phi_j^0] \\ &= \sum_{j=1}^N qf_j A_j \left\{ \sum_{n=0}^{+\infty} \cos[(n+Q_f)\omega_j t + \Delta\phi_{n-n'}^j + \phi_j^0] + \right. \\ &\quad \left. \sum_{n=1}^{+\infty} \cos[(n-Q_f)\omega_j t + \Delta\phi_{n+n'}^j - \phi_j^0] \right\} \end{aligned} \quad (3.18)$$

where Q_f is the fractional part of Q . Again the negative frequencies $(-n + Q_f)\omega_j$ ($n = +1, +2, \dots, +\infty$) are indistinguishable from the mirrored positive ones $-(-n + Q_f)\omega_j = (n - Q_f)\omega_j$, so that on a spectrum analyser in real positive physical frequencies, one would see two betatron bands $(n + Q_f)$ and $(n - Q_f)$ per interval of width f_0 , both below and above the revolution harmonic lines nf_0 , $n = +1, +2, \dots, +\infty$. Each band is centred around $(n \pm Q_f)f_0$ with a spectrum of lines within them at $(n \pm Q_f)f_j$, corresponding to different revolution frequencies $f_j = f_0 + \Delta f_j$ of the particles with strengths $qf_j A_j$, and a randomly varying phase given by $\Delta\phi_{n,j}^\pm = \Delta\phi_{n \mp n'}^\pm \pm \phi_j^0 = (n \mp n')(\theta_j^0 - \theta_P) \pm \phi_j^0$, where n' is the integer part of $Q = n' + Q_f$. Even the $n = n'$, i.e. $m = 0$ band has random phases for each particle line owing to the ϕ_j^0 term. The macroscopic beam dipole moment thus vanishes since

$$\langle d^P(\tau) \rangle = \frac{1}{(2\pi)^2} \sum_{j=1}^N \int_0^{2\pi} d\phi_j^0 \int_0^{2\pi} d\theta_j^0 d_j^P(\tau) = 0, \quad (3.19)$$

and the transverse Schottky dipole current *fluctuations* are the same as the transverse Schottky signal itself as detected by the PU:

$$\delta d^P(\tau) = d^P(\tau) - \langle d^P(\tau) \rangle = d^P(\tau). \quad (3.20)$$

No coherent macroscopic dipole signal remains at any harmonic $(n \pm Q_f) \equiv (m + Q)$ ($n = 0, 1, 2, 3, \dots, m = -\infty, \dots, -1, 0, +1, \dots, +\infty$) including $m = 0$, provided no coherent collective transverse modes are excited in the beam by other interactions.

Again, for small relative spreads in revolution frequencies, $\Delta f/f_0 = \epsilon \ll 1$, one obtains zeroth-order transverse fluctuations in dipole-moment current density by simply replacing $(qf_j A_j)$ by $(qf_0 A_j)$ in the spectral line strengths, thus omitting terms $\mathcal{O}(\Delta f/f_0)$. The transverse dipole-moment charge density fluctuation $\sum_{j=1}^N x_j(t) q_j^P(t) = D^P(t)$ is obtained by omitting f_j 's altogether from the strengths $(qf_j A_j)$ and dividing by 2π , i.e. by replacing $(qf_j A_j)$ by $(qA_j/2\pi)$.

If the transverse displacement of the j^{th} particle at the PU located at $s = s_P$ has a fixed displacement $x_0^j(s)|_{PU} = x_0^j(s_P)$ in addition to the betatron oscillation displacement $A_j \cos(Q\omega_j t + \phi_j^0)$ due to the offset of the displaced equilibrium closed orbit at the PU, arising from the momentum deviation of the particle from the ideal design value p_0 , i.e. if $x_j(t) = x_0^j(s_P) + A_j \cos(Q\omega_j t + \phi_j^0)$, there will be an additional contribution to the right-hand side of Eq. (3.18) [as follows from Eq. (3.17)] given by

$$\sum_{j=1}^N qf_j x_0^j(s_P) \sum_{m=-\infty}^{+\infty} e^{-im[\theta_j(t) - \theta_P]} = \sum_{j=1}^N qf_j x_0^j(s_P) + \sum_{j=1}^N 2qf_j x_0^j(s_P) \sum_{m=1}^{\infty} \cos(m\omega_j t + \Delta\phi_m^j)$$

Note that the first term vanishes in the zeroth order if the particles are distributed symmetrically in $(\Delta p/p)$ [see paragraph containing Eq. (2.13)]. Thus if the PU is placed in a dispersive region of the storage-ring lattice so that an off-momentum particle has an equilibrium orbit with non-vanishing

offset $x_0^j(s_P) \neq 0$ at the PU, the transverse signal will also contain information about the longitudinal lines. In fact, this is precisely the case in the Palmer-type longitudinal stochastic cooling^{17,20,23}, where information about the beam's longitudinal time structure is extracted from the difference Δ -signals obtained from a transverse PU placed in a dispersive region of the storage-ring lattice. We will ignore this term from now on, assuming that the PU is placed in a purely non-dispersive region so that the transverse signal contains information about the pure betatron oscillations only.

The longitudinal and transverse single-particle Schottky signals for a continuous ring-filling coasting beam are shown in Figs. 4a and 4b, respectively, both in the general frequency domain including negative frequencies and in the real positive frequency domain. In Fig. 4b, the integer part, n' , of Q is taken to be 2, i.e. $Q = 2 + Q_f$, for illustration only.

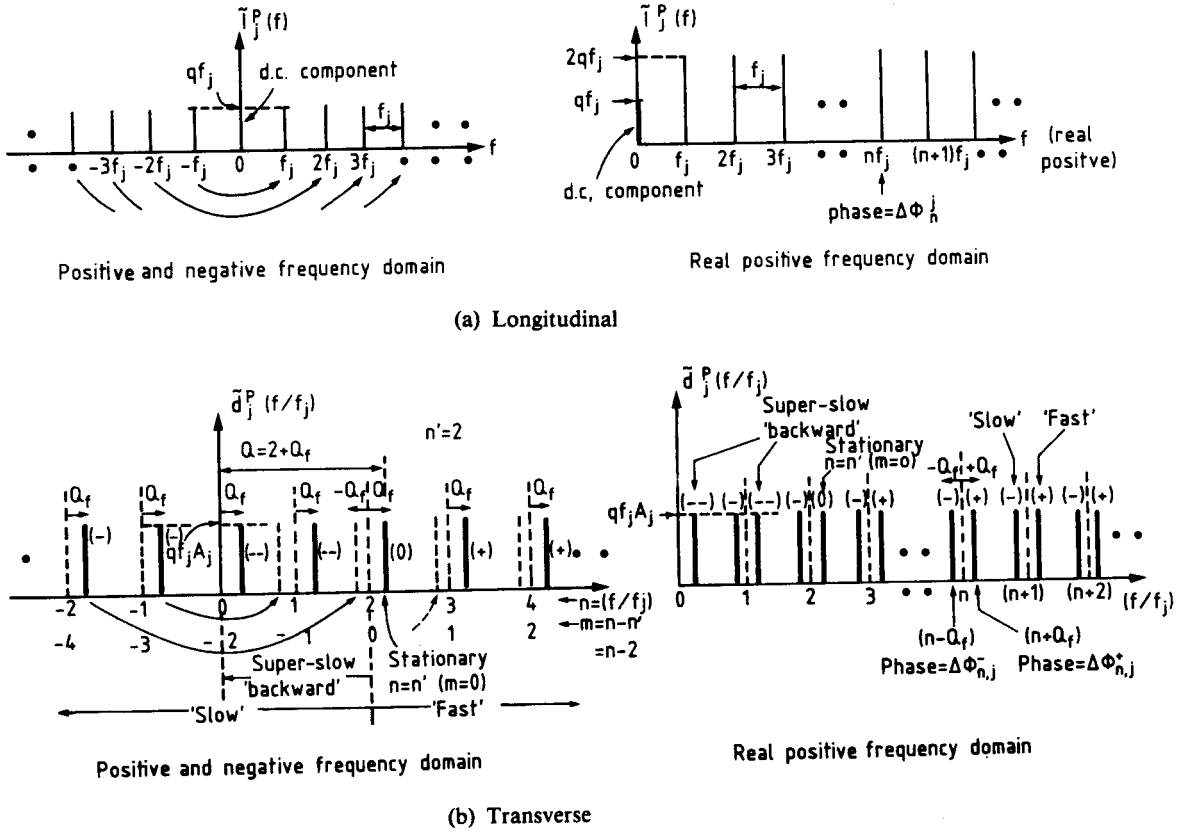

Fig. 4 Single-particle Schottky signals for a continuous ring-filling coasting beam in different frequency domains

Note that the lines $(n + Q_f)$ ($n \geq 0$) and $(n - Q_f)$ ($n \geq 1$) are not truly associated with n but with revolution harmonics far away from n . The lines $(n + Q_f)$ ($n \geq 0$) are truly associated with revolution harmonics $m = n - n'$ ($-n'$, $-n'+1$, ..., 0 , 1 , 2 , ..., $+\infty$) and $|m| = |n - n'|$. The lines $(n - Q_f)$ ($n \geq 1$) are truly associated with revolution harmonics $m = -n - n'$ ($-n'$, $-1 - n'$, $-2 - n'$, ..., $-\infty$, and $|m| = |n + n'|$. Although a spectrum analyser observing signals at a fixed azimuth along the particle orbit in the storage ring cannot discriminate between these positive and negative frequencies, the phases associated with the lines $(n \pm Q_f)$ contain the full information about the true harmonic association and hence the sign of the frequency.

More importantly, as soon as we consider the behaviour of these beam fluctuations not only at a fixed azimuth $\theta = \theta_P$ but more completely as a function of the azimuth θ or distance $s = R\theta$ around the storage ring, the positive and negative revolution or orbital harmonics and frequencies reveal qualitatively different patterns.

The transverse betatron fluctuations $d_j(s,t)$ of a particle j in a continuous debunched coasting beam as a function of time t and azimuthal distance s can be decomposed into propagating or travelling transverse waves along the beam, in space and time, of the form $\exp[-i(\Omega t - \kappa s)] = \exp[-i(\Omega t - m\theta)]$, where $m = \kappa R = 2\pi R/\lambda$ is the number of full wavelengths λ in a complete circumference and must be an integer, since the wave pattern must close on itself at any time t owing to 2π -periodicity in θ . We denote by m the orbital revolution mode number of the wave; κ is the usual wave number of the wave (angle/distance). We can then write

$$d_j(\theta, t) = \frac{1}{2\pi} \int_{-\infty}^{+\infty} d\Omega \sum_{m=-\infty}^{+\infty} \tilde{d}_j^m(\Omega) e^{-i(\Omega t - m\theta)} . \quad (3.21)$$

Such a representation is already provided by Eq. (3.18) if we treat θ_P as a continuous angle variable θ . We then see that the fluctuation waves (betatron) do not propagate at arbitrary frequencies Ω , but at frequencies that are related to the orbital harmonic mode number m of the wave: $\Omega_m = (m + Q)\omega_j$. The second line of Eq. (3.18) provides the following particular representation:

$$d_j(\theta, t) = q f_j A_j \sum_{m=-\infty}^{+\infty} \cos \left[(m\theta - \Omega_m t) - \phi_j^0 - m\theta_j^0 \right] . \quad (3.22)$$

The angular phase velocity ω_m of the orbital wave with mode number m is

$$\omega_m = \frac{\Omega_m}{m} = \left(1 + \frac{Q}{m} \right) \omega_j . \quad (3.23)$$

Thus $\omega_m^+ = [1 + (Q/|m|)]\omega_j > \omega_j$ for $m > 0$ and $\omega_m^- = [1 - (Q/|m|)]\omega_j < \omega_j$ for $m < 0$. In a reference frame which moves with the particle (i.e. a frame which moves with angular velocity ω_j with respect to the laboratory frame and in which the particle is at rest azimuthally), the $m > 0$ and $m < 0$ waves travel in opposite directions with angular velocities $+(Q/|m|)\omega_j$ and $-(Q/|m|)\omega_j$, respectively (Fig. 5a). In the laboratory frame, the betatron fluctuation waves associated with orbital harmonics $m > 0$ travel faster than the particle with angular velocity $\omega_m^+ > \omega_j$ and those associated with $m < 0$ travel slower than the particle with angular velocity $\omega_m^- < \omega_j$. They are often referred to as the ‘fast’ and ‘slow’ linear betatron fluctuation wave signals, respectively¹⁴⁻¹⁹. In fact, some of the ‘slow’ waves are so slow that they travel backward opposite to the beam direction even in the laboratory frame (Fig. 5b). These belong to the small subset of ‘slow’ waves with $|m| < Q$, so that $\omega_m^- = [1 - (Q/|m|)]\omega_j < 0$. The number of such super-slow ‘backward’ waves is equal to the integer part n' of $Q = n' + Q_f$. Note that the $m = 0$ fluctuations do not propagate. In the frequency domain, all negative frequency waves $(-n + Q_f)\omega_j$ ($n > 0$), corresponding to $(n - Q_f)\omega_j$ in mirrored positive frequency, are ‘slow’. Positive frequency waves

$(n + Q_f)\omega_j$ ($n > 0$) with $n > Q$ are 'fast'. A small number of positive low-frequency waves ($n + Q_f$) ω_j with $0 < n < Q$ are super-slow 'backward' waves.

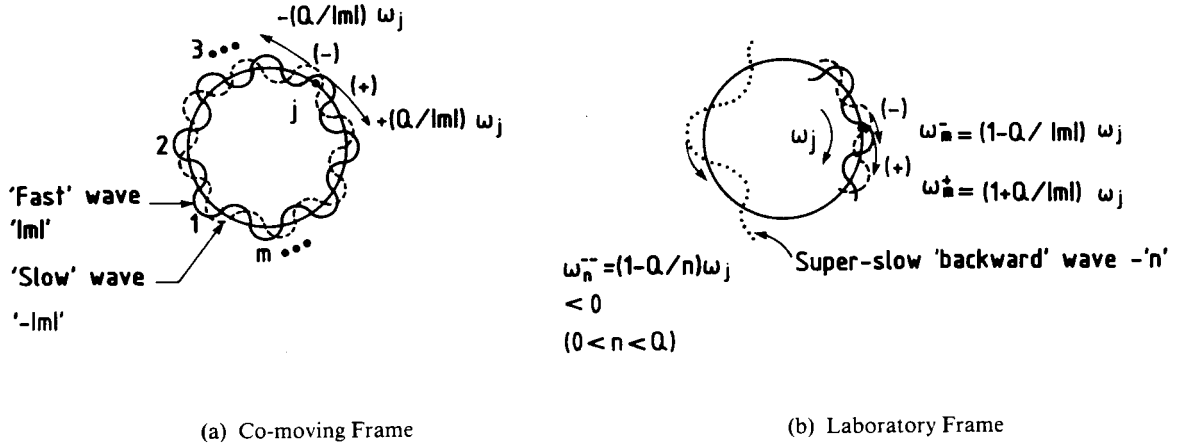

Fig. 5 'Fast' and 'slow' transverse betatron fluctuation waves

Particle and wave betatron motions as sampled at a particular azimuth at intervals of time $T_j = 1/f_j = 2\pi/\omega_j$ are shown in a simplified sketch in Fig. 6 for one member each of the fast, slow, and backward waves, corresponding to the betatron side bands $(3 + Q_f)$, $(1 - Q_f)$, and $(0 + Q_f)$, respectively, for a tune of $Q = 2 + 0.25 = 2.25$.

It is interesting to compare the slope of the wave $d(\theta, t) \sim \tilde{d}^m(\Omega_m)e^{-i(\Omega_m t - m\theta)}$ at any azimuth θ at time t with respect to the particle motion $x(\theta, t)$. We have

$$\begin{aligned} \frac{\partial d(\theta, t)}{\partial t} &= -i\Omega_m d(\theta, t); & \frac{\partial d(\theta, t)}{\partial \theta} &= +imd(\theta, t); \\ \frac{\partial x(\theta, t)}{\partial t} &= -iQ\omega_j x(\theta, t); & \frac{\partial x(\theta, t)}{\partial \theta} &= -iQx(\theta, t). \end{aligned} \quad (3.24)$$

Thus the slope in time of the wave relative to that of the particle ($d \equiv x$ for waves sampled on a particle) at any fixed azimuth has opposite signs for $\Omega_m > 0$ and $\Omega_m < 0$. This is clearly seen in Fig. 6 where the slope of the negative frequency 'slow' (-)-waves is opposite to that of the particles and the positive frequency (+) and (- -) waves. From Eq. (3.24) it also follows that the slope in azimuth θ at any fixed time for the waves is opposite to that of the particles for $m > 0$, and the same as that of the particles for $m < 0$. These points play crucial roles in determining the stability properties of the transverse coherent motion of the particles in a beam^{14,24}.

The betatron fluctuation waves mentioned above are not just mathematical constructs but can actually be supported by the beam as propagating transverse waves under suitable conditions. Thus waves corresponding to all the spectral lines Ω_n^\pm of the transverse fluctuations we have considered can be excited in the beam as coherent modes of propagation by suitable transverse electromagnetic kickers jiggling the beam at characteristic mode frequencies Ω_n^\pm . Moreover, electromagnetic interaction of the beam with the storage ring impedance (see Section 8) can produce self-generated transverse fields at appropriate frequencies and with proper phases that can act effectively as a transverse kicker and generate these coherent waves spontaneously^{3,6,14,24}.

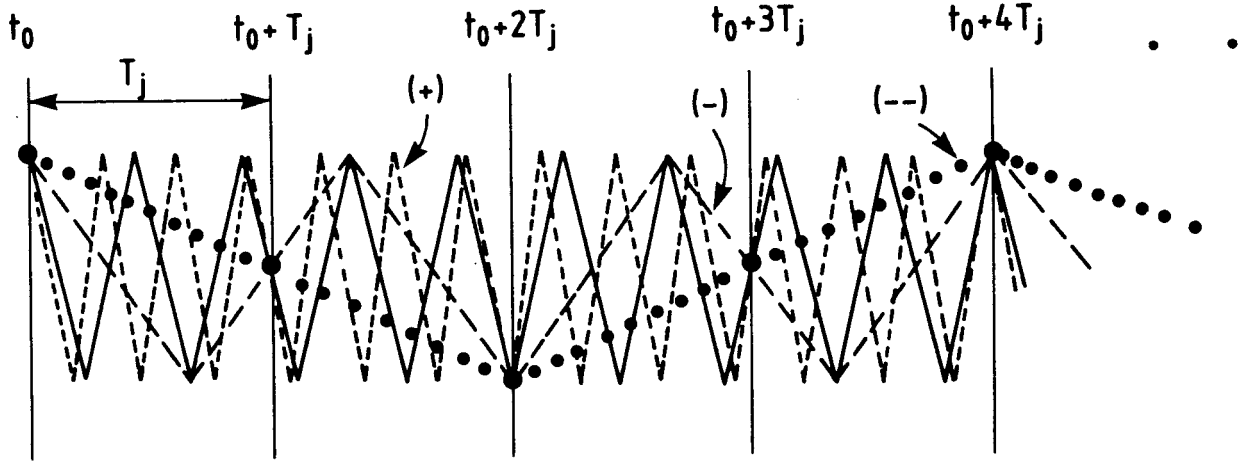

- (+) ----- 'Fast' wave $(3 + Q_f)\omega_j = 3.25 \omega_j$; $m = +1$
 (-) ----- 'Slow' wave $(1 - Q_f)\omega_j = 0.75 \omega_j$; $m = -3$
 (- -) Super-slow 'backward' wave $(0 + Q_f)\omega_j = 0.25 \omega_j$; $m = -2$
 ————— Particle motion $Q\omega_j = 2.25 \omega_j$, $Q = n' + Q_f = 2.25$, $n' = 2$, $Q_f = 0.25$
 • Particle position, the same as 'sampled' by all the waves.

Fig. 6 Betatron wave and particle motion sampled at a fixed azimuth at intervals of T_j

The finite spreads in each revolution and betatron band, centred around $n\omega_0$ and $(n \pm Q_f)\omega_0$ respectively, are given by the dispersion in momentum and transverse tune as

$$|\Delta\omega_n| = |n\Delta\omega| = |n\eta\omega_0 \left(\frac{\Delta p}{p_0}\right)| \quad \text{and} \quad |\Delta\omega_n^\pm| = |n\eta \mp (Q_0\xi + n'\eta)| \omega_0 \left|\frac{\Delta p}{p_0}\right|, \quad (3.25)$$

where ξ and η are the chromaticity and the off-energy function defined by

$$\left(\frac{\Delta\omega}{\omega_0}\right) = -\eta\left(\frac{\Delta p}{p_0}\right); \quad \frac{\Delta Q}{Q_0} = \xi\left(\frac{\Delta p}{p_0}\right) = -\frac{\xi}{\eta} \left(\frac{\Delta\omega}{\omega_0}\right), \quad (3.26)$$

and $\eta = (\gamma_{tr}^{-2} - \gamma_r^{-2})$. [The above can be derived by noting that the lines near $(n + Q_f)$ correspond to a true orbital harmonic $m = n - n'$ and those near $(n - Q_f)$ correspond to a true orbital harmonic $m = (-n - n')$, and the spread in the betatron line corresponding to $(m + Q)$ is $\Delta\omega_m = m\Delta\omega + \Delta Q\omega_0 = (-m\eta + Q_0\xi)\omega_0(\Delta p/p_0)$, $m = -\infty, \dots, -1, 0, +1, \dots, +\infty$, where the tune Q is defined in such a way that the betatron frequencies of all the particles are always referred to the nominal orbital frequency ω_0 : $\omega_x^i = Q^i\omega_0$, so that the frequency corresponding to $(m + Q)$ is $\Omega_m^i = m\omega^i + Q^i\omega_0 = m\omega^i + \omega_x^i$ for the i^{th} particle. If instead we refer ω_x^i to the revolution frequency ω^i of the particle itself, $\omega_x^i = Q^i\omega^i$, we have $\Omega_m^i = (m + Q^i)\omega^i$, as before, and the expression for the shifts (3.25) takes the form

$$|\Delta\omega_n^\pm| = |n\eta \mp [(\xi - \eta)Q_0 + n'\eta]| \omega_0 \left|\frac{\Delta p}{p_0}\right|. \quad (3.27)$$

In all the above, n' is the integer part of $Q_0 = n' + Q_0^f$.

Thus for the transverse betatron signals, the width of the $(m + Q)$ and $(-m + Q)$ bands are different if the machine has non-zero chromaticity $\xi \neq 0$, i.e. if the betatron tune depends on momentum $Q = Q(p)$. Even if the chromaticity were zero ($\xi = 0$), the width of the lines $(n \pm Q_f)$ adjacent on two sides of a positive revolution harmonic $n\omega_0$ would be different owing to the fact that they correspond to different orbital harmonic numbers $m = n - n'$ for $(n + Q_f)$ and $m = -(n + n')$ for $(n - Q_f)$ bands. Thus the 'fast' and 'slow' betatron wave bands have quite different spectral widths in general. More importantly, as is evident from Eqs. (3.25), the width of both the longitudinal and the transverse betatron bands increases with frequency, exactly in proportion to the harmonic n for longitudinal bands and roughly so for betatron bands also. At sufficiently high frequencies with correspondingly high harmonic numbers, the fluctuation Schottky bands will overlap, corresponding to harmonics n satisfying the band overlap condition

$$|n\Delta\omega| = |\Delta\omega_n| \gtrsim \omega_0, \quad \text{i.e.} \quad |n\eta(\Delta p/p_0)| \gtrsim 1 \quad (3.28a)$$

for the longitudinal signals, and

either
$$\frac{1}{2} \left(|\Delta\omega_n^+| + |\Delta\omega_n^-| \right) \geq 2Q_0^f \omega_0 \quad (3.28b)$$

or
$$\frac{1}{2} \left(|\Delta\omega_n^+| + |\Delta\omega_{n+1}^-| \right) \geq (1 - 2Q_0^f) \omega_0$$

for the transverse betatron signals.

In this region of overlapping frequencies, single frequency fluctuations will propagate as waves with different orbital mode numbers m corresponding to different particles in the beam generating the same frequency $\Omega = (m + Q^i)\omega^i = (m' + Q^j)\omega^j = \dots$, with $m \neq m'$. Excitation by a transverse kicker will then induce waves with more than a single azimuthal harmonic number, all of which will correspond to the same frequency, namely the frequency of the excitation at the kicker.

The longitudinal and transverse Schottky signals for the whole beam containing N particles in continuous ring-filling coasting orbits with a spread Δf in revolution frequencies are shown in Figs. 7a and 7b, respectively, in the real positive frequency domain.

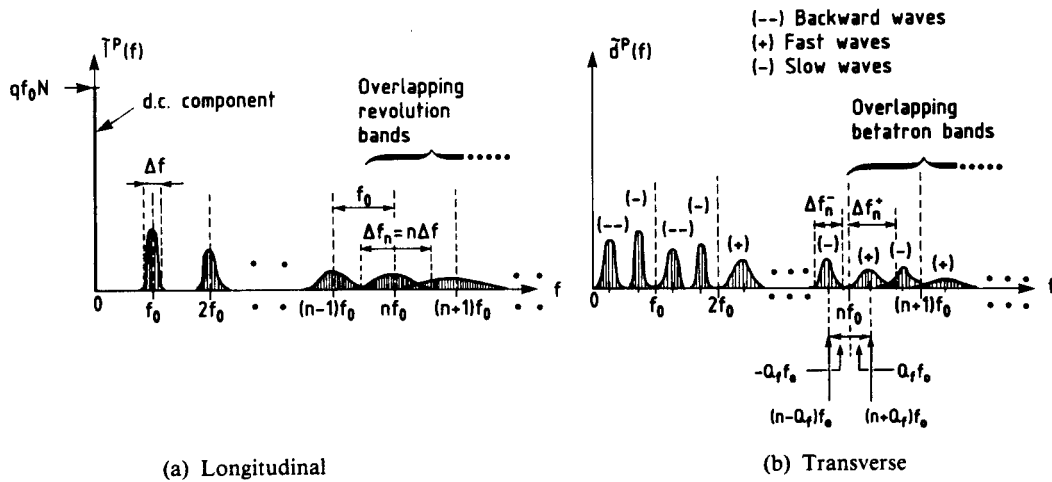

Fig. 7 The full-beam Schottky signals for a continuous ring-filling coasting beam in the real positive frequency domain

Note that the form of the longitudinal current signal corresponds to that observed by an ideal sum PU, and the form of the transverse dipole moment signal corresponds to that observed by an ideal difference PU with linear response only. Transverse PUs with non-linear response will observe moments higher than the dipole moment as well²¹). Also, finite pick-up dimensions will in reality broaden the delta-function sampling and must in practice be included in the total PU response. In general, this broadening will lead to a tapering of the spectrum at very high frequencies with an approximate 'cut-off' frequency $f_c \approx (\delta t)^{-1}$, where (δt) is the sampling time resolution of the PU. For small δt , the low-frequency spectrum remains relatively unaffected.

The Fourier frequency components of the beam current fluctuations and the beam dipole-moment current fluctuations are given by

$$\widetilde{\delta I^P}(\Omega) = q \sum_{j=1}^N \sum_{\substack{m=-\infty \\ \neq 0}}^{+\infty} \omega_j e^{-i\Delta\phi_m^j} \delta(\Omega - m\omega_j) \quad (3.29)$$

$$\text{and } \widetilde{\delta d^P}(\Omega) = \widetilde{d^P}(\Omega) = q \sum_{j=1}^N \sum_{m=-\infty}^{+\infty} \frac{\omega_j A_j}{2} e^{-i\Delta\phi_m^j} \left\{ \delta[\Omega - (m+Q)\omega_j] e^{-i\phi_j^0} + \delta[\Omega - (m-Q)\omega_j] e^{+i\phi_j^0} \right\}. \quad (3.30)$$

Since ϕ_j^0 and θ_j^0 are randomly distributed between 0 and 2π , we have

$$\langle \widetilde{\delta I^P}(\Omega) \rangle = 0 \quad \text{and} \quad \langle \widetilde{d^P}(\Omega) \rangle = 0. \quad (3.31)$$

What is more relevant for these stochastic variables of Fourier frequency components is the power spectrum of the fluctuations, defined in terms of a suitable representation in the Fourier-transformed frequency space of the autocorrelation function

$$C_I(t, t') = \langle \delta I^P(t) \delta I^P(t')^* \rangle \quad (3.32)$$

and similarly for the dipole-moment fluctuations. In performing the average over the random initial phases as suggested by the angular brackets, we encounter terms of the form

$$\exp i(m\theta_j^0 - n\theta_i^0) = \exp \left[\frac{1}{2} i(m+n)(\theta_j^0 - \theta_i^0) \right] \exp \left[\frac{1}{2} i(m-n)(\theta_j^0 + \theta_i^0) \right]$$

for averaging. Averaging over the fast phase given by the second term, we obtain $\delta_{m,n}$. The first term then, for $j \neq i$, oscillates and averages to zero. So the only contribution comes from $j = i$. Performing in detail the required averages for the longitudinal signal of continuous coasting beams as given by Eq. (3.11), we find that $C_I(t, t') = C_I(t - t') = C_I(\tau)$ is a function of $\tau = (t - t')$ alone, a characteristic of 'weakly stationary' noise¹³), so that a single-frequency power spectrum can be defined as

$$P_I(\Omega) = \int_{-\infty}^{+\infty} d\tau C_I(\tau) e^{i\Omega\tau}, \quad (3.33)$$

and

$$\left\langle \widetilde{\delta I^P}(\Omega) \widetilde{\delta I^P}^*(\Omega') \right\rangle = 2\pi P_I(\Omega) \delta(\Omega - \Omega') \quad . \quad (3.34)$$

In fact, for continuous coasting beams the fluctuation noise is even 'strongly stationary', with all higher-order moments being functions of time differences alone owing to time translation invariance. Then replacing $\sum_{j=1}^N F(\omega_j)$ by $N \int d\omega F(\omega) \Psi_0(\omega)$, where $\Psi_0(\omega)$ is a normalized (to unity, i.e. $\int \Psi_0(\omega) d\omega = 1$) distribution of particles in revolution angular frequency and $F(\omega)$ is any function of ω , we find for the longitudinal current-density fluctuation power spectrum,

$$P_I(\Omega) = \frac{q^2 N}{2\pi} \sum_{\substack{m=-\infty \\ \neq 0}}^{+\infty} \int d\omega \omega^2 \Psi_0(\omega) \delta(\Omega - m\omega) = \frac{q^2 N}{2\pi} \sum_{\substack{m=-\infty \\ \neq 0}}^{+\infty} \frac{1}{|m|} \left(\frac{\Omega}{m}\right)^2 \Psi_0\left(\frac{\Omega}{m}\right) \quad , \quad (3.35)$$

and for the longitudinal charge-density fluctuation power spectrum,

$$P_\rho(\Omega) = \frac{q^2 N}{2\pi} \sum_{\substack{m=-\infty \\ \neq 0}}^{+\infty} \int d\omega \Psi_0(\omega) \delta(\Omega - m\omega) = \frac{q^2 N}{2\pi} \sum_{\substack{m=-\infty \\ \neq 0}}^{+\infty} \frac{1}{|m|} \Psi_0\left(\frac{\Omega}{m}\right) \quad . \quad (3.36)$$

We may also write Eq. (3.36) simply as

$$P_\rho(\Omega) = \frac{q^2 N}{2\pi} \Psi(\Omega) \quad , \quad \text{where } \Psi(\Omega) = \sum_{\substack{m=-\infty \\ \neq 0}}^{+\infty} \frac{1}{|m|} \Psi_0\left(\frac{\Omega}{m}\right) \quad . \quad (3.37)$$

We note that we can interpret $\Psi(\Omega)$ as the normalized distribution of particles in the real frequency space Ω , its magnitude giving a relative measure of the number of all the particles that can harmonically generate a frequency in the neighbourhood of Ω :

$$\Psi(\Omega) d\Omega = (dN/d\Omega) d\Omega = dN \quad . \quad (3.38)$$

Obviously for overlapping bands, particles with different fundamental revolution frequencies ω , ω' , ω'' , ..., etc., can contribute to $\Psi(\Omega)$ through different revolution harmonics m , m' , m'' , etc., by satisfying the resonance condition

$$\Omega = m\omega = m'\omega' = m''\omega'' = \dots \quad ; \quad (3.39)$$

hence the appearance of the summation over m in $\Psi(\Omega)$. We note also that the width of the m^{th} harmonic increases as m , whilst the height must decrease as $1/|m|$ in order to preserve normalization at the fundamental harmonic band centred at ω_0 with $m = 1$. This explains the scaling $\Psi_0(\Omega/m)/|m|$ for the contribution to $\Psi(\Omega)$ from the m^{th} harmonic. If the bands do not overlap, the resonance condition is satisfied for, say, only one value of $m = n$, satisfying $\Omega = n\omega$, and we obtain

$$[P_\rho(\Omega)]_n = \frac{q^2 N}{2\pi |n|} \Psi_0\left(\frac{\Omega}{n}\right) = \frac{q^2 N}{2\pi |n|} \Psi_0(\omega) \quad . \quad (3.40)$$

The average power¹³⁾ of the longitudinal charge-density fluctuation in a full non-overlapping observable revolution band is simply (a factor of 2 appearing since we have to add contributions from $-n$ and n , generating the same frequency observed by a spectrum analyser):

$$[P_\rho]_n = 2 \frac{1}{2\pi} \int_{|\Omega - n\omega_0| \leq n(\Delta\omega)_{\text{beam}}} [P_\rho(\Omega)]_n d\Omega = \frac{2q^2 N}{(2\pi)^2 |n|} \int d\omega \Psi_0(\omega) = \frac{q^2 N}{2\pi^2} , \quad (3.41)$$

where $\omega_0 - (\Delta\omega)_{\text{beam}} \leq (\Omega/n) \leq \omega_0 + (\Delta\omega)_{\text{beam}}$, $(\Delta\omega)_{\text{beam}}$ being the full spread in revolution angular frequencies in the beam. We thus see that the shape of the power spectral density for longitudinal charge-density Schottky fluctuations provides the ω distribution in the beam for non-overlapping bands, and its strength is proportional to the intensity N of the beam. For overlapping bands, it provides the distribution of particles in real frequency Ω , i.e. $\Psi(\Omega)$.

Again, for small relative spreads in angular revolution frequencies in the beam, we can write the spectral density of longitudinal current fluctuations as

$$P_I(\Omega) = \omega_0^2 P_\rho(\Omega) = \frac{q^2 \omega_0^2 N}{2\pi} \Psi(\Omega) = 2\pi q^2 f_0^2 N \Psi(\Omega) , \quad (3.42)$$

and for non-overlapping bands

$$[P_I(\Omega)]_n = 2\pi q^2 f_0^2 \frac{N}{|n|} \Psi_0\left(\frac{\Omega}{n}\right) , \quad (3.43)$$

and the average current fluctuation power in a full revolution band is

$$[P_I]_n = 2 \frac{1}{2\pi} \int_{|\Omega - n\omega_0| \leq n(\Delta\omega)_{\text{beam}}} [P_I(\Omega)]_n d\Omega = 2q^2 f_0^2 N = \frac{2q^2 \omega_0^2 N}{(2\pi)^2} . \quad (3.44)$$

We can also consider the cross-correlation function of fluctuations at two different azimuths, $\theta = \theta_P$ and $\theta = \theta_K$ say, given by

$$P_\rho^{\text{PK}}(t, t') = P_\rho(\theta_P, t; \theta_K, t') = \langle \delta\rho(\theta_P, t) \delta\rho^*(\theta_K, t') \rangle \quad (3.45)$$

for charge-density fluctuations, for example. For continuous coasting beams, there is the symmetry of invariance under arbitrary time translations and rotations around the ring, implying that the above is a function of $(\theta_P - \theta_K)$ and $(t - t')$ alone, as one can easily verify. The 2π -periodicity in angle around the ring then allows the decomposition

$$P_\rho^{\text{PK}}(t - t') = P_\rho(\theta_P - \theta_K; t - t') = \sum_{n=-\infty}^{+\infty} (P_\rho)_n(t - t') e^{in(\theta_P - \theta_K)} , \quad (3.46)$$

so that the cross-power spectral density is given by

$$P_{\rho}^{\text{PK}}(\Omega) = \sum_{n=-\infty}^{+\infty} \left(P_{\rho} \right)_n(\Omega) e^{in(\theta_P - \theta_K)} . \quad (3.47)$$

The same is true for the longitudinal current fluctuations. The azimuthal harmonics $(P_{\rho})_n(\Omega)$ are the same as the contribution $[P_{\rho}(\Omega)]_n$ of the n^{th} harmonic to the fluctuation power component at frequency Ω at a localized PU, as obtained before for $n \neq 0$ and zero for $n = 0$:

$$\left(P_{\rho} \right)_n(\Omega) = [P_{\rho}(\Omega)]_n = \frac{q^2 N}{2\pi |n|} \Psi_0 \left(\frac{\Omega}{n} \right) , \quad n \neq 0 , \quad (3.48)$$

and for $\theta_P = \theta_K$ we recover the previously obtained result

$$P_{\rho}^{\text{P=K}}(\Omega) = P_{\rho}(\Omega) = \sum_{n=-\infty}^{+\infty} \left(P_{\rho} \right)_n(\Omega) = q^2 \frac{N}{2\pi} \sum_{\substack{n=-\infty \\ \neq 0}}^{+\infty} \frac{1}{|n|} \Psi_0 \left(\frac{\Omega}{n} \right) . \quad (3.49)$$

Fluctuations exist in the beam independently of whether they are observed at a localized PU or not. We can thus speak about the azimuthal Fourier harmonics n of the fluctuations as a function of azimuth around the ring and time, as independent relevant quantities characterizing the fluctuation waves. This is irrespective of the fact that we can also consider these azimuthal harmonic components as the contribution of that azimuthal wave of harmonic n in the n^{th} revolution band to the fluctuation component at frequency Ω , observed in the frequency domain at a localized PU. We thus consider the longitudinal charge-density fluctuation as a function of azimuth around the ring and time,

$$\delta\rho(\theta, t) = q \left[\sum_{j=1}^N \delta[\theta_j(t) - \theta] - \frac{N}{2\pi} \right] = \sum_{n=-\infty}^{+\infty} \delta\rho_n(t) e^{in\theta} , \quad (3.50)$$

where

$$\begin{aligned} \delta\rho_n(t) &= \frac{q}{2\pi} \sum_{j=1}^N e^{-in\theta_j(t)} = \frac{q}{2\pi} z_n(t) \quad \text{for } n \neq 0 , \\ &= 0 \quad \text{for } n = 0 . \end{aligned} \quad (3.51)$$

For $n \neq 0$ we thus have $\delta\rho_n(t) = \varrho_n(t)$. For a large number of particles $N \gg 1$, $\varrho_n(t)$ ($n \neq 0$) is thus a sum of a large number of complex and independent random variables $(q/2\pi)z_n^j = (q/2\pi) \exp[-in\theta_j(t)] = (q/2\pi)(x_n^j - iy_n^j)$, $i = 1, \dots, N$. Using the Central Limit Theorem of probability¹³⁾ together with the fact that the mean and variance of the variables $x_n^j = \cos[n\theta_j(t)]$

and $y_n^j = \sin [n\theta_j(t)]$ are given by $\bar{x}_n^j = \bar{y}_n^j = 0$ and $\overline{(x_n^j)^2} = \overline{(y_n^j)^2} = 1/2$, we can assert that the probability distribution of finding harmonics of amplitude z_n in the beam is given by

$$g_n(z_n) = \frac{1}{(\pi N)} \exp \left(- \frac{|z_n|^2}{N} \right) \quad (3.52)$$

in the limit of large N . The corresponding probability distribution for finding charge-density harmonics of amplitude ρ_n is given by

$$f_n(\rho_n) = \frac{4\pi}{q^2 N} \exp \left(- \frac{4\pi^2}{q^2 N} |\rho_n|^2 \right) . \quad (3.53)$$

Note that these distributions are consistent with the already found fluctuation moments of the beam as a whole, namely $\langle z_n \rangle = 0$, $\langle |z_n|^2 \rangle = N$, and $\langle \rho_n \rangle = 0$, $\langle |\rho_n|^2 \rangle = (q^2 N / 4\pi^2)$, valid for both positive and negative n separately and $n \neq 0$.

[If $\bar{x} = \sum_{j=1}^N \bar{x}_j$, where \bar{x}_j 's are *independent real* random variables with respective means and variances

$$\bar{x}_j = \eta_j \quad \text{and} \quad \bar{x}_j^2 = \sigma_j^2 \quad (3.54)$$

and respective densities $g_j(x)$, then the mean η and variance σ^2 of \bar{x} are given by

$$\eta = \sum_{j=1}^N \eta_j \quad \text{and} \quad \sigma^2 = \sum_{j=1}^N \sigma_j^2 \quad (3.55)$$

and its density by

$$g(x) = \prod_{j=1}^N g_j(x) = g_1(x) \times g_2(x) \times \dots \times g_N(x) . \quad (3.56)$$

The Central Limit Theorem¹³⁾ states that as N increases, under certain general conditions, $g(x)$ approaches a normal curve

$$g(x) \sim \frac{1}{\sqrt{2\pi}\sigma} \exp \left[- \frac{(x-\eta)^2}{2\sigma^2} \right] . \quad (3.57)$$

In our example above, for the complex random variable $z = x + iy$, the distribution $g(z) dx dy$ is given by the joint density $g(z) = g(x) \times g(y)$, with $\eta_x = \eta_y = 0$ and $\sigma_x^2 = \sigma_y^2 = (N/2)$ giving

$$\begin{aligned} g(z) &= g(x, y) = g(x) \times g(y) = (\pi N)^{-1} \exp \left[-(x^2 + y^2)/N \right] \\ &= (\pi N)^{-1} \exp (-|z|^2/N) \end{aligned} \quad (3.58) .]$$

For the cross-spectral power density of betatron dipole-moment current fluctuations at $\theta = \theta_P$ and $\theta = \theta_K$, a similar analysis for the transverse fluctuations yields the following:

$$\begin{aligned} P_d^{PK}(\Omega) &= \sum_{n=-\infty}^{+\infty} [P_d(\Omega)]_n e^{in(\theta_P - \theta_K)} \\ &= \frac{q^2}{2\pi} \sum_{j=1}^N \sum_{\substack{n \\ (-\infty)}}^{+\infty} \sum_{(\pm)} \frac{1}{4} \omega_j^2 A_j^2 \delta[\Omega - (n \pm Q)\omega_j] e^{in(\theta_P - \theta_K)} \quad . \end{aligned} \quad (3.59)$$

Introducing a normalized distribution $N\Psi(\omega, A)$ of particles in revolution angular frequencies ω and betatron oscillation amplitudes A , we obtain the power spectral density for $\theta_P = \theta_K$ as

$$P_d(\Omega) = \frac{q^2 N}{4(2\pi)} \sum_{n=-\infty}^{+\infty} \sum_{(\pm)} \iint d\omega dA \Psi(\omega, A) \omega^2 A^2 \delta[\Omega - (n \pm Q)\omega] \quad . \quad (3.60)$$

Taking $\Psi(\omega, A) = \Psi_0(\omega)\Phi_0(A)$, which assumes independent distributions in ω and A , we then have

$$\begin{aligned} P_d(\Omega) &= \frac{q^2 N}{4(2\pi)} \langle A^2 \rangle \sum_{n=-\infty}^{+\infty} \sum_{(\pm)} \int d\omega \omega^2 \Psi_0(\omega) \delta[\Omega - (n \pm Q)\omega] \\ &= \frac{q^2 N}{4(2\pi)} \langle A^2 \rangle \cdot \sum_{n=-\infty}^{+\infty} \sum_{(\pm)} \left(\frac{\Omega}{n \pm Q} \right)^2 \frac{\Psi_0\left(\frac{\Omega}{n \pm Q}\right)}{|n \pm Q|} \quad , \end{aligned} \quad (3.61)$$

where $\langle A^2 \rangle = \int dA A^2 \Phi_0(A)$ is the mean squared betatron amplitude in the beam. For the dipole-moment charge density, we obtain

$$P_D(\Omega) = \frac{q^2 N}{4(2\pi)} \langle A^2 \rangle \sum_{n=-\infty}^{+\infty} \sum_{(\pm)} \int d\omega \Psi_0(\omega) \delta[\Omega - (n \pm Q)\omega] = \frac{q^2 N}{4(2\pi)} \langle A^2 \rangle \Psi(\Omega) \quad , \quad (3.62)$$

where

$$\Psi(\Omega) = \sum_{n=-\infty}^{+\infty} \sum_{(\pm)} \frac{1}{|n \pm Q|} \Psi_0\left(\frac{\Omega}{n \pm Q}\right) \quad (3.63)$$

is the total density of particles in the real betatron frequency space for overlapping betatron bands.

Thus the contribution of the $(n \pm Q)$ harmonic to the total power density at frequency Ω is

$$\overline{[P_d(\Omega)]_n^{(\pm)}} = \frac{q^2 N}{4(2\pi)} \langle A^2 \rangle \left(\frac{\Omega}{n \pm Q} \right)^2 \Psi_0 \left(\frac{\Omega}{n \pm Q} \right) \frac{1}{|n \pm Q|} \quad (3.64)$$

and

$$\overline{[P_D(\Omega)]_n^{(\pm)}} = \frac{q^2 N}{4(2\pi)} \langle A^2 \rangle \Psi_0 \left(\frac{\Omega}{n \pm Q} \right) \frac{1}{|n \pm Q|} \quad ,$$

and for non-overlapping betatron Schottky bands the average power per betatron harmonic $(n \pm Q)$ in the real positive frequency domain (i.e. contributions from negative n 's added) is (after integrating over a single band)

$$\overline{[P_{(n \pm Q)}]_d} = q^2 f_0^2 N \frac{\langle A^2 \rangle}{2} \quad \text{and} \quad \overline{[P_{(n \pm Q)}]_D} = \frac{q^2 N}{(2\pi)^2} \frac{\langle A^2 \rangle}{2} \quad (3.65)$$

for small relative spreads in angular frequencies $(\Delta\omega/\omega_0) \ll 1$.

The above analysis of fluctuations in a continuous coasting beam assumes all the particles in the beam to be moving independently of each other in totally uncorrelated orbits. The simple spectral properties of Schottky fluctuations obtained above no longer remain if the particles are somehow correlated. To see this, we again consider the charge-density fluctuations at a PU, localized at $\theta = \theta_p$, and consider the frequency domain correlation

$$\langle \rho^P(\Omega) \rho^{P*}(\Omega') \rangle = \frac{q^2}{4\pi^2} \sum_{\substack{i \\ =1}}^N \sum_{\substack{j \\ \neq 0}}^N \sum_{n,m=-\infty}^{+\infty} \langle \tilde{\rho}_n^i(\Omega) \tilde{\rho}_m^j(\Omega') \rangle e^{i(n-m)\theta_p} \quad , \quad (3.66)$$

where

$$\tilde{\rho}_n^i(\Omega) = \overbrace{\exp[-in\theta_i(t)]}(\Omega) = \int_{-\infty}^{+\infty} dt e^{-in\theta_i(t) + i\Omega t} \quad (3.67)$$

is the density field of the i^{th} particle in the n^{th} azimuthal harmonic and Fourier transformed to frequency Ω . With uncorrelated trajectories, the statistically averaged quantity denoted by brackets $\langle \dots \rangle$ in Eq. (3.66) is simply $4\pi^2 \delta_{ij} \delta_{nm} \delta(\Omega - n\omega_i) \delta(\Omega' - m\omega_j) N \Psi_0(\omega_i)$, as assumed before, where $\Psi_0(\omega_i)$ is the normalized (to unity) single-particle distribution in ω_i . In the presence of correlations, we have to add an extra term

$$4\pi^2 N^2 C_{nm}(\omega_i, \omega_j) \delta(\Omega - n\omega_i) \delta(\Omega' - m\omega_j) \quad , \quad (3.68)$$

where $C_{nm}(\omega_i, \omega_j)$ describes a suitably normalized 'correlation function' between the n^{th} and m^{th} azimuthal harmonics of the density fields of particles i and j with angular frequencies ω_i and ω_j .

Then

$$\begin{aligned}
\langle \rho^P(\Omega) \rho^{P*}(\Omega') \rangle &= q^2 \left\{ N \delta(\Omega - \Omega') \sum_{n \neq 0} \int d\omega \Psi_0(\omega) \delta(\Omega - n\omega) \right. \\
&\quad \left. + N^2 \sum_{\substack{n \\ \neq 0}} \sum_m \iint d\omega d\omega' c_{nm}(\omega, \omega') e^{i(m-n)\theta_P} \cdot \delta(\Omega - n\omega) \delta(\Omega' - m\omega') \right\} \\
&= q^2 \left\{ N \left[\sum_{n \neq 0} \frac{1}{|n|} \Psi_0\left(\frac{\Omega}{n}\right) \right] \delta(\Omega - \Omega') \right. \\
&\quad \left. + N^2 \sum_{\substack{n \\ \neq 0}} \sum_m \frac{1}{|n||m|} c_{nm}\left(\frac{\Omega}{n}, \frac{\Omega'}{m}\right) e^{i(m-n)\theta_P} \right\} \quad (3.69)
\end{aligned}$$

For non-overlapping bands, we obtain the power spectral density at a frequency Ω lying within the n^{th} non-overlapping revolution band as

$$[P_{\rho}(\Omega)]_n = \frac{q^2}{2\pi} \left[\frac{N}{|n|} \Psi_0\left(\frac{\Omega}{n}\right) + \frac{N^2}{|n|^2} \int d\Omega' c_{nn}\left(\frac{\Omega}{n}, \frac{\Omega'}{n}\right) \right]. \quad (3.70)$$

Thus Schottky signals are deformed by correlations. Even with incoherent random initial phases at $t = 0$ when interparticle correlations are zero, finite non-zero correlations may develop for $t > 0$ because of other effects, which will distort the shape of the fluctuation spectrum.

Such correlations or ‘bunching’ may be either microscopic or macroscopic. Microscopic correlations are always induced in the beam by the electromagnetic interaction between the beam particles (e.g. space charge), by the electromagnetic interaction of the beam as a whole with the environment through the electromagnetic coupling impedances of the storage ring, or by interaction with an external active feedback loop as in stochastic cooling. The resulting distortion affected by these microscopic correlations or coherence induced by collective interactions will be called ‘collective distortion of fluctuation spectra’ and will be the subject of much quantitative study in a later section (Section 11). We will only mention here that this effect is analogous to the polarization and Debye shielding of test-charge fields in plasma physics, where a ‘dielectric function or permittivity’ is used to describe the details²⁵. In storage rings the corresponding dielectric function is often called the ‘collective signal suppression factor’ or ‘closed-loop distortion factor’; it will be derived and studied later in Section 11.

Macroscopic correlation or ‘bunching’ is, of course, explicitly imposed when the particle beam is bunched by external radio-frequency fields. The particles in a bunched beam are for ever correlated to remain within the bunch. These correlations, expressed by the extra synchrotron oscillations of particles in a bunch, endow bunched beam Schottky fluctuation signals with uniquely different properties and frequency space structure (from continuous coasting beams), which we study briefly below.

Let $\theta_j(t) = \omega_0 t + a_j \sin[\omega_s(a_j)t + \psi_j^0] = \omega_0 [t - \tau_j(t)]$ represent the quasi-linear [i.e. sinusoidal orbits but with amplitude-dependent oscillation frequency $\omega_s(a_j)$] synchrotron oscillation of the j^{th} particle in the beam, with the usual meaning of symbols. Then the

longitudinal charge-density Schottky signal derived from a distribution of particles in a bunch, upon repeated traversals through a localized azimuth $\theta = \theta_P$, have the following spectral representation, obtained after Fourier analysing the train of delta-functions at $\theta = \theta_P$:

$$\begin{aligned} \rho^P(t) &= \rho(\theta_P; t) = \sum_{j=1}^N \rho_j(\theta_P; t) = q \sum_{j=1}^N \sum_{m=-\infty}^{+\infty} \delta[\theta_j(t) - \theta_P - 2m\pi] \\ &= \sum_{j=1}^N \sum_{m, \mu=-\infty}^{+\infty} r_{m, \mu}(j) e^{i\alpha_{m, \mu}(j)} e^{-i\Omega_{m, \mu}(j)t} , \end{aligned} \quad (3.71)$$

where the frequencies $\Omega_{m, \mu}(j)$, amplitudes $r_{m, \mu}(j)$, and phases $\alpha_{m, \mu}(j)$, are given by

$$\begin{aligned} \Omega_{m, \mu}(j) &= m\omega_0 + \mu\omega_s(a_j) , \\ r_{m, \mu}(j) &= (q/2\pi) J_\mu(ma_j) , \\ \alpha_{m, \mu}(j) &= -\mu\psi_j^0 + m\theta_P . \end{aligned} \quad (3.72)$$

Here m and μ are the revolution and synchrotron harmonics, respectively (both ranging from $-\infty$ to $+\infty$), and $J_\mu(x)$ is an ordinary Bessel function of integer order μ appearing by virtue of the identity

$$e^{ix \sin y} = \sum_{\mu=-\infty}^{+\infty} J_\mu(x) e^{i\mu y} \quad (3.73)$$

used in deriving the spectrum. Thus we obtain a spectrum of lines at the revolution harmonics $m\omega_0$, each one of which is accompanied by synchrotron satellite bands (an infinite number of them in principle) $[m\omega_0 \pm \mu\omega_s(a_j)]_{j=1, \dots, N}$ whose strengths are given by $(q/2\pi)J_\mu(ma_j)$ for particle j . For a distribution of particles $j = 1, \dots, N$, the central $\mu = 0$ line at $\Omega = m\omega_0$ is infinitely sharp, whilst the synchrotron satellites form bands of finite widths $\mu\Delta\omega_s$ owing to the spread $\Delta\omega_s$ in the amplitude-dependent synchrotron frequencies.

The charge density signal is modulated by the particle angular revolution frequencies $\omega_j = \omega_0 + \Delta\omega_j \cos [\omega_s(a_j)t + \psi_j^0]$ in producing the longitudinal current signal, given by

$$I^P(t) = I(\theta_P; t) = q \sum_{j=1}^N \sum_{m=-\infty}^{+\infty} \omega_j \delta[\theta_j(t) - \theta_P - 2m\pi] \quad (3.74)$$

$$\begin{aligned} &= \sum_{j=1}^N \sum_{m, \mu=-\infty}^{+\infty} \left\{ \omega_0 r_{m, \mu}(j) e^{i\alpha_{m, \mu}(j)} e^{-i\Omega_{m, \mu}(j)t} + \frac{\Delta\omega_j}{2} r_{m, \mu}(j) \right. \\ &\quad \left. \left[e^{i\alpha_{m, \mu+1}(j)} e^{-i\Omega_{m, \mu+1}(j)t} + e^{i\alpha_{m, \mu-1}(j)} e^{-i\Omega_{m, \mu-1}(j)t} \right] \right\} . \end{aligned}$$

The second term gives a set of first-order synchrotron satellite bands at $[m\omega_0 \pm (\mu \pm 1)\omega_s(a_j)]$ displaced by $\pm \omega_s(a_j)$ from the zeroth-order bands given by the first term, and whose relative strengths are given by

$$\frac{(\Delta\omega_j/2)}{\omega_0} \sim \frac{1}{2} \frac{a_j \omega_s(a_j)}{\omega_0} \ll 1 \quad (3.75)$$

since synchrotron oscillations are usually much slower than the revolution time ($a\omega_s \ll \omega_0$). A similar analysis can be done for the transverse betatron dipole-moment signal⁷⁾. The spectral representations of the zeroth-order transverse dipole-moment signal and the zeroth-order longitudinal current signal, neglecting these first-order bands, are summarized for a bunched beam in Table 1 below⁷⁾. Here Q is the betatron tune, ξ the chromaticity, and η the off-energy function of the storage ring. The spectrum analyser records two betatron bands centred around $(n + Q_f)f_0$ and $(n - Q_f)f_0$ per revolution band in real positive frequency, where Q_f is the fractional part of Q .

Table 1

	Transverse dipole-moment signal	Longitudinal current signal
Schottky signal considered	$d(t) = \sum_{j=1}^N d_j(t) = \sum_{j=1}^N x_j \cdot I_j(t)$ $= \sum_{j,m,\mu(\pm)} r_{m,\mu}^{(\pm)}(j) \exp [i\alpha_{m,\mu}^{(\pm)}(j)] \exp [-i\Omega_{m,\mu}^{\pm}(j)t]$	$I(t) = \sum_{j=1}^N I_j(t)$ $= \sum_{j,m,\mu} r_{m,\mu}(j) e^{i\alpha_{m,\mu}(j)} e^{-i\Omega_{m,\mu}(j)t}$
Frequencies	$\Omega_{m,\mu}^{(\pm)}(j) = (m \pm Q)\omega_0 + \mu\omega_s(a_j)$	$\Omega_{m,\mu}(j) = m\omega_0 + \mu\omega_s(a_j)$
Amplitudes	$r_{m,\mu}^{(\pm)}(j) = qf_0 \frac{A_j}{2} J_{\mu} [(m \mp Q)a_j - Q \frac{\xi}{\eta} a_j]$	$r_{m,\mu}(j) = qf_0 J_{\mu}(ma_j)$
Phases	$\exp [i\alpha_{m,\mu}^{(\pm)}(j)] = \exp (\pm i\phi_j^0 - i\mu\psi_j^0 + im\theta_p)$	$e^{i\alpha_{m,\mu}(j)} = e^{-i\mu\psi_j^0 + im\theta_p}$

Note that whilst the longitudinal fluctuation spectrum is centred at the origin $\Omega = 0$ of the frequency axis, the transverse fluctuation spectrum is centred around the 'chromatic frequency' $\Omega = \omega_{\xi} = (\xi/\eta)Q\omega_0$ (the Bessel functions may be written as $J_{\mu}[\Omega_m^{\pm} \hat{\tau}]$, where $\hat{\tau} = a_j/\omega_0$ and $\Omega_m^{\pm} = [(m \mp Q)\omega_0 - \omega_{\xi}]$). For finite non-zero chromaticity $\xi \neq 0$, the relative amplitudes of various synchrotron side-bands μ are thus changed because of this shift ω_{ξ} of the Bessel function envelopes. For example, $\mu > 0$ side-bands have non-vanishing amplitudes $J_{\mu}[-\omega_{\xi}(a_j/\omega_0)] \neq 0$ at $\Omega = 0$, whilst they have zero amplitudes for the longitudinal case [$J_{\mu}(0) = 0$ for $\mu > 0$].

The single-particle longitudinal Schottky current spectrum for a bunched beam is shown on the global frequency scale in Fig. 8a. The splitting of each revolution band $m\omega_0$ into two betatron side-bands $(m + Q)\omega_0$ and $(m - Q)\omega_0$ for the transverse dipole signal is illustrated in Fig. 8b. The chromatic shift of the envelope functions for the transverse spectrum with non-zero chromaticity is shown in Fig. 8c. The detailed satellite band structure of each longitudinal revolution band due

to synchrotron oscillations is shown on a magnified scale in Fig. 8d for a revolution harmonic $m = 20000$ and synchrotron oscillation amplitude $a_j = 0.00112$ rad as an example of a typical particle undergoing synchrotron oscillations in a storage ring.

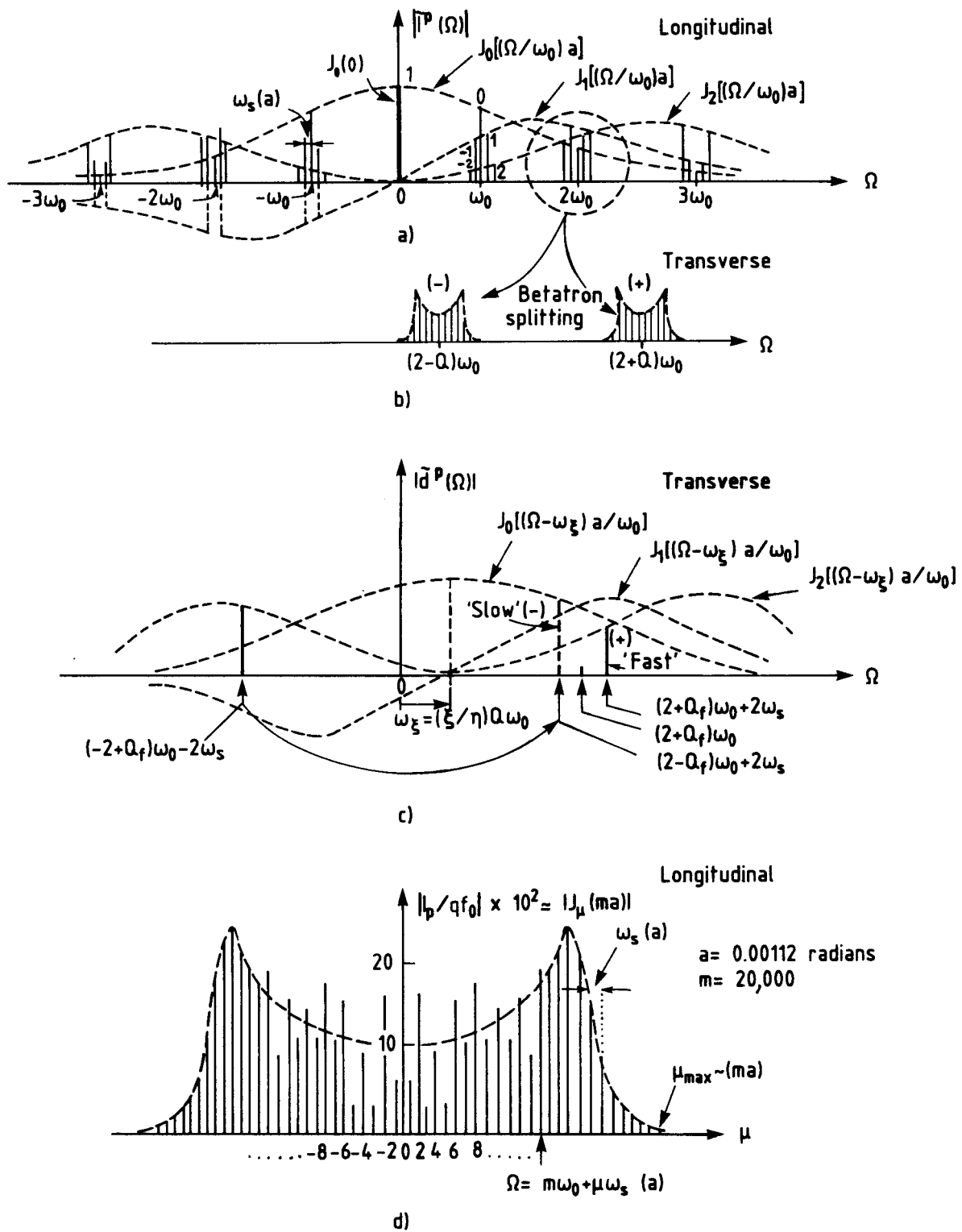

Fig. 8 Single-particle Schottky spectrum in a bunch

We note that when viewed more completely as a function of azimuth θ around the storage ring and time, the fluctuations can be decomposed into propagating fluctuation waves, e.g. for the azimuthal charge-density fluctuations

$$\begin{aligned} \rho_j(\theta, t) &= \frac{q}{2\pi} \sum_{\substack{m \neq 0 \\ (-\infty)}}^{(+\infty)} \sum_{\substack{\mu \neq 0 \\ (-\infty)}} J_\mu(ma_j) e^{i\mu\psi_j^0} e^{-i[\Omega_{m,\mu}(j)t - m\theta]} \\ &= \frac{q}{\pi} \sum_{m>0}^{+\infty} \sum_{\substack{\mu=-\infty \\ \neq 0}}^{+\infty} J_\mu(ma_j) \cos [m\theta - \Omega_{m,\mu}(j)t - \mu\psi_j^0] . \end{aligned} \quad (3.76)$$

The angular phase velocity $\Omega_{m,\mu}$ of the orbital wave with mode number m and frequency $\Omega_{m,\mu}(j) = m\omega_0 + \mu\omega_s(j)$ generated by the particle's synchrotron oscillation with synchrotron mode number μ (≤ 0) is

$$\omega_{m,\mu} = \frac{\Omega_{m,\mu}(j)}{m} = \omega_0 + \frac{\mu}{m} \omega_s(a_j) . \quad (3.77)$$

Thus $\omega_{m,+ \mu} = \omega_{m,\mu}^+ = \omega_0 + (|\mu|/m)\omega_s(a_j) > \omega_0$ and $\omega_{m,- \mu} = \omega_{m,\mu}^- = \omega_0 - (|\mu|/m)\omega_s(a_j) < \omega_0$. The synchrotron oscillations then split the longitudinal fluctuation waves into 'fast' and 'slow' waves relative to the motion of the bunch centre. In terms of the azimuth $\Theta = \theta - \omega_0 t$ in the co-moving frame (which moves with angular velocity ω_0 relative to the laboratory) in which the bunch is macroscopically at rest, we may write

$$\begin{aligned} \rho_j(\Theta, t) &= \frac{q}{\pi} \sum_{m>0}^{+\infty} \left[\sum_{\mu>0}^{+\infty} J_\mu(ma_j) \cos (m\Theta - \mu\omega_s t - \mu\psi_j^0) \right. \\ &\quad \left. + \sum_{\mu<0}^{-\infty} J_{-|\mu|}(ma_j) \cos (m\Theta + |\mu|\psi_j^0 + |\mu|\omega_s t) \right] . \end{aligned} \quad (3.78)$$

In the bunch frame the 'slow' and 'fast' synchrotron fluctuation waves corresponding to $-|\mu|$ and $+|\mu|$ thus propagate in opposite directions with phase velocities $-(|\mu|/m)\omega_s(a_j)$ and $(|\mu|/m)\omega_s(a_j)$, respectively. Note that since $J_{-|\mu|}(x) = (-1)^{|\mu|} J_{|\mu|}(x) = e^{i\pi|\mu|} J_{|\mu|}(x)$, the 'slow' $-|\mu|$ -waves at $-\Theta$ at any time have a phase of $(-1)^{|\mu|} = e^{i\pi|\mu|}$ relative to that of the 'fast' $+|\mu|$ -waves at $+\Theta$ at the same time. Thus the 'fast' waves at $+\Theta$ and the 'slow' waves at $-\Theta$ are strongly correlated according to

$$\rho_j^{-|\mu|,m}(-\Theta, t) = (-1)^{|\mu|} \rho_j^{+|\mu|,m}(+\Theta, t) . \quad (3.79)$$

They have the same magnitude and sign for $|\mu|$ even, and same magnitude, but opposite sign for $|\mu|$ odd. The ‘fast’ wave at $+\Theta$ and the ‘slow’ wave at $-\Theta$ may thus be considered as a conjugate correlated pair consisting of a ‘direct’ wave and an ‘instantaneous non-locally reflected’ wave, a feature which is unique to azimuthally confined bunched beams and which has significant implications for Landau damping and coherent wave regeneration properties. This is in contrast to debunched continuous beams, as we will see in Section 13. In the bunch synchrotron phase space, the ‘fast’ and ‘slow’ longitudinal synchrotron fluctuation waves may be thought of as travelling on the top and bottom of the bunch as shown in Fig. 9 for a particular azimuthal mode m , and may be referred to as the ‘top’ and ‘bottom’ waves of synchrotron fluctuations. Note that the instantaneous particle velocity oscillates about the wave velocity, the relative velocity being $\Delta\omega(t) = \omega_j(t) - (|\mu|/m)\omega_s(j) = a_j\omega_s(j) [\cos [\omega_s(j)t + \psi_j^0] - |\mu|/ma_j]$. This is illustrated in Fig. 10a. Note that $[\omega_j(t)]_{\max} = a_j\omega_s(j)_{\max} \geq (|\mu|/m)\omega_s(j)$, since $|\mu| \ll ma$ for significant fluctuation wave strengths $J_\mu(ma)^{26}$. The particle phase relative to the wave oscillates about an average value which increases linearly for the slow waves and decreases linearly for the fast waves. On the average, the particle slips behind the ‘fast’ wave and ahead of the ‘slow’ wave linearly in time (Fig. 10b).

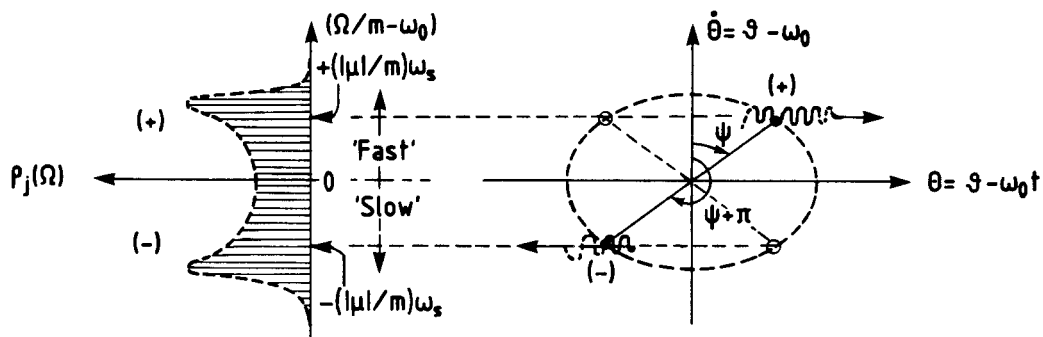

Fig. 9 ‘Top’ and ‘bottom’ longitudinal synchrotron fluctuation waves

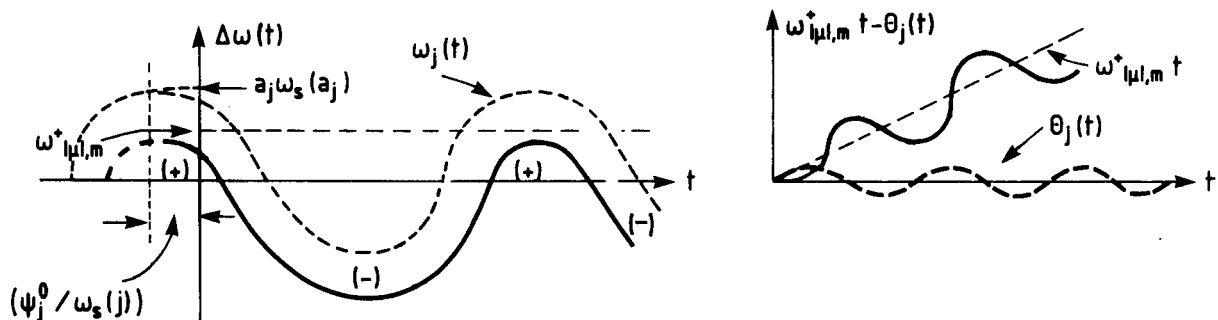

Fig. 10 Particle versus synchrotron wave phase slips

It is important to note that in contrast to debunched continuous coasting beams, a bunched beam cannot support any one of these single, revolution-frequency harmonic fluctuation waves [$\Omega_{m,\mu}(j) = \mu\omega_s(a_j) + m\omega_0$] alone, as this would imply the existence of physical fluctuations outside of the bunch length. Physical fluctuations are for ever confined to remain within the bunch, and single-revolution harmonic fluctuation waves only provide suitable mathematical basis functions, orthogonal over the interval $(0, T_0)$, with $T_0 = 2\pi/\omega_0$ for a convenient decomposition of the bunch fluctuations without any potential for manifesting themselves as real physical propagation. It can be readily seen from Eqs. (3.76) and (3.78) that to obtain physical fluctuation wave-packet signals existing only within the bunch of azimuthal length $\Delta\theta = 2a_j$, we would have to superpose two sets, each with at least a number of $B/2 = \pi/2a_j$ such azimuthal-harmonic, single-frequency basis fluctuation waves $\Omega_{m,\mu} = m\omega_0 + \mu\omega_s(a_j)$, $m = m_1, m_1 + 1, \dots, m_1 + [(B/2) - 1]$, where $B = 2\pi/\Delta\theta = \pi/a_j$ is the 'bunching factor', the two sets being in quadrature (relative phase $\pi/2$) relative to each other. [This can be seen by noting that $J_\mu(x)$ has a fairly constant value in an interval of $|\Delta x| < \pi/2$ around the peak of the cosine-like curve of $J_\mu(x)$ for large x and

$$\sum_{m=m_1}^{m_1 + [(B/2) - 1]} \cos [-\mu\omega_s t + m\theta - \mu\psi_j^0] = \cos \Phi \sum_{n=1}^{(B/2) - 1} \cos n\theta + \sin \Phi \sum_{n=1}^{(B/2) - 1} \sin n\theta ,$$

where $\Phi = \mu(\omega_s t + \psi_j^0) - m_1 \theta$ and, using the Lagrange identity,

$$\sum_{n=1}^{(B/2) - 1} \cos n\theta = \frac{\sin [(B-1)/2]\theta}{2 \sin (\theta/2)} - \frac{1}{2} .$$

The first term above has a typical width of $\Delta\theta \cong 2\pi/(B-1) \simeq 2\pi/B = 2a_j$, equal to the bunch length.]

In the laboratory frame these individual harmonic waves that make up the physically confined bunch fluctuations have frequencies $\Omega_m = m\omega_0 + \mu\omega_s(a_j)$, $m \in [m_1, m_1 + (B/2) - 1]$ so that the group angular velocity of the fluctuation wave-packet confined to and moving with the bunch is simply $\omega_{\text{group}}^L = d\Omega_m/dm = \omega_0$. In the bunch frame, their frequencies $\Omega = \mu\omega_s(a_j)$ are independent of m and $\omega_{\text{group}}^B = d\Omega/dm = 0$ so that the wave packet is stationary (see Fig. 11).

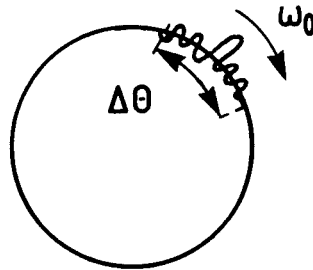

Fig. 11 Fluctuation wave packet confined within the bunch moving with group velocity ω_0 in the laboratory frame

These fluctuation waves within the bunch can, however, be excited coherently by suitable single frequency excitations $\Omega_{m,\mu}$ at a localized kicker, since the bunch will see all the frequencies $\Omega^k = \Omega_{m,\mu} + k\omega_0$ due to periodic sampling at the kicker and treat them quite innocently. The bunch will produce and support suitable localized density waves compatible with and compounded of all these generated frequencies Ω^k .

Propagation of a fluctuation wave packet with group velocity $\omega_{\text{group}}^L = d\Omega_m/dm = \omega_0 + \Delta\omega$ and $\omega_{\text{group}}^B = \Delta\omega$ within the bunch in the bunch frame can be achieved by superposing single frequency waves not only of different orbital mode number m but also of different synchrotron modes μ derived from a distribution of particles in synchrotron frequencies $\omega_s(a_j)$ so that $m\Delta\omega = \mu\omega_s(a_j)$. Only particles with $\omega_s(a_j) = (m/\mu)\Delta\omega$ will contribute to a wave signal propagating with group velocity $\Delta\omega$ relative to the bunch. Density fluctuations can thus propagate as coherent localized density perturbations, as illustrated in Fig. 12. The group velocity of such waves depends on the local density of the bunch and hence the particle distribution in the synchrotron phase space.

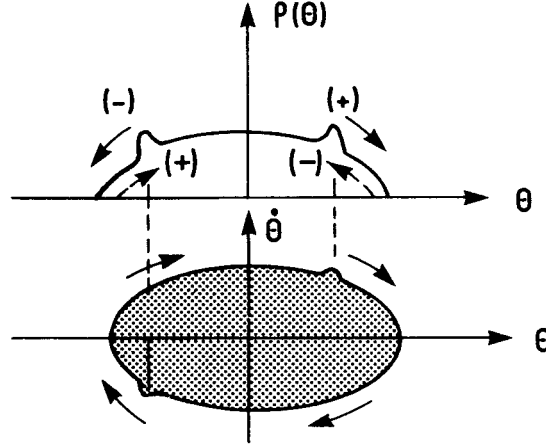

Fig. 12 Propagation of coherent localized density perturbation waves in the bunch

The spreads in the longitudinal synchrotron side-bands arising from a distribution of particles are given by

$$\Delta\Omega_{m,\mu} = \mu\Delta\omega_s, \quad (3.80)$$

where $\Delta\omega_s$ is the total synchrotron frequency spread in the bunch. Since $J_\mu(ma)$ has significant magnitudes only for $\mu \leq ma$ and rapidly falls off to zero for $\mu \geq ma$ [$J_\mu(x) \xrightarrow{\mu \rightarrow \infty} (2\pi\mu)^{-1/2} (ex/2\mu)^\mu$] (Ref. 26), the synchrotron side-band spectrum extends up to $\mu_m\omega_s(0) \sim ma_m\omega_s(0) = m\dot{\theta}_{\text{max}}$, where a_m is the maximum synchrotron amplitude in the bunch. The total spread in the revolution harmonic band m thus approaches the value for a continuous coasting beam with frequency spread $\Delta\Omega_m = m\Delta\omega_{\text{max}}$, where $\Delta\omega_{\text{max}}$ corresponds to the maximum instantaneous angular velocity spread in the bunch [see Eq. (3.25)]. The profile of the Schottky band at a given revolution harmonic mf_0 duplicates the longitudinal velocity distribution of the bunch.

For the betatron bands, it should be noted that all the particles in the bunch are constrained to move with the same *average* orbital angular velocity ω_0 ; so the Q appearing in the betatron side-band frequencies $\Omega_{m,\mu} = (m+Q)\omega_0 + \mu\omega_s(a)$ is the same for all the particles, namely the tune of the nominal reference particle with angular velocity ω_0 . Thus the ‘natural chromaticity’ ξ does not appear in the observed frequencies at all. Therefore the only spread ΔQ in tune can come from the so-called ‘non-linear tune spread’, arising from the multipole components of the machine

(second-order sextupoles, octupoles, etc.) and the space-charge effect¹⁸⁾. With such a non-linear tune spread ΔQ , the widths of the betatron side-bands are given by

$$\begin{aligned}\Delta\Omega_{m,\mu}^{(\pm)} &= \mu\Delta\omega_s \pm \Delta Q \cdot \omega_0, & \mu \neq 0, \\ &= m(\Delta\omega)_{\max} \pm \Delta Q \cdot \omega_0, & \\ |\Delta\Omega_{m,\mu=0}^{\pm}| &= |\Delta Q \cdot \omega_0|, & \mu = 0.\end{aligned}\quad (3.81)$$

In a linear machine without ripple, $\Delta Q = 0$, and the $\mu = 0$ central betatron bands are infinitely sharp, whilst the synchrotron satellites reproduce the momentum distribution of the beam. We thus see an important difference compared with continuous coasting beams, namely that as long as there is no non-linear tune spread, even a finite non-zero 'natural chromaticity' $\xi \neq 0$ does not alter the frequencies in the frequency space. The information about the machine chromaticity simply lies in the relative heights of the satellites $J_\mu[(m \pm Q)a - Q(\xi/\eta)a]$ in the (\pm) bands, as is evident from Fig. 8c.

For low-revolution harmonics m , the fluctuation noise density of synchrotron side-bands is enhanced by $\Gamma_\mu = (\omega_s/\mu\Delta\omega_s)$ compared with that of a continuous coasting beam, until the side-bands overlap, i.e. $\Gamma_\mu \lesssim 1$ for large m . This is so because the average power per full revolution (and betatron) band is the same for continuous and bunched beams as we will see later [for example, Eqs. (3.115) and (3.116)] and the widths of the revolution (and betatron) bands are comparable in both cases as we have already seen. In the synchrotron-band overlapped region, different particles with different oscillation amplitudes generate the same frequency Ω through different synchrotron harmonics:

$$\Omega = m\omega_0 + \mu\omega_s(a) = m\omega_0 + \mu'\omega_s(a') = \dots, \quad (3.82)$$

with $a \neq a'$ and $\mu \neq \mu'$. For still higher frequencies and hence harmonics m , even the revolution bands start to overlap, i.e.

$$\Omega = m\omega_0 + \mu\omega_s(a) = n\omega_0 + \mu'\omega_s(a') = \dots, \quad (3.83)$$

with $m \neq n$, $\mu \neq \mu'$, and $a \neq a'$.

The same holds for the betatron bands. This overlapping of bands as a function of frequency is shown in Fig. 13 for the longitudinal current fluctuation spectrum.

The Fourier-transformed frequency domain representation of the longitudinal charge-density bunched beam Schottky signal is

$$\tilde{\rho}^P(\Omega) = \tilde{\rho}(\theta_P; \Omega) = q \sum_{j=1}^N \underbrace{\sum_{\mu}^{(+\infty)} J_\mu(ma_j)}_{(-\infty)} e^{-i\mu\psi_j^0} e^{+im\theta_P} \delta[\Omega - m\omega_0 - \mu\omega_s(a_j)]. \quad (3.84)$$

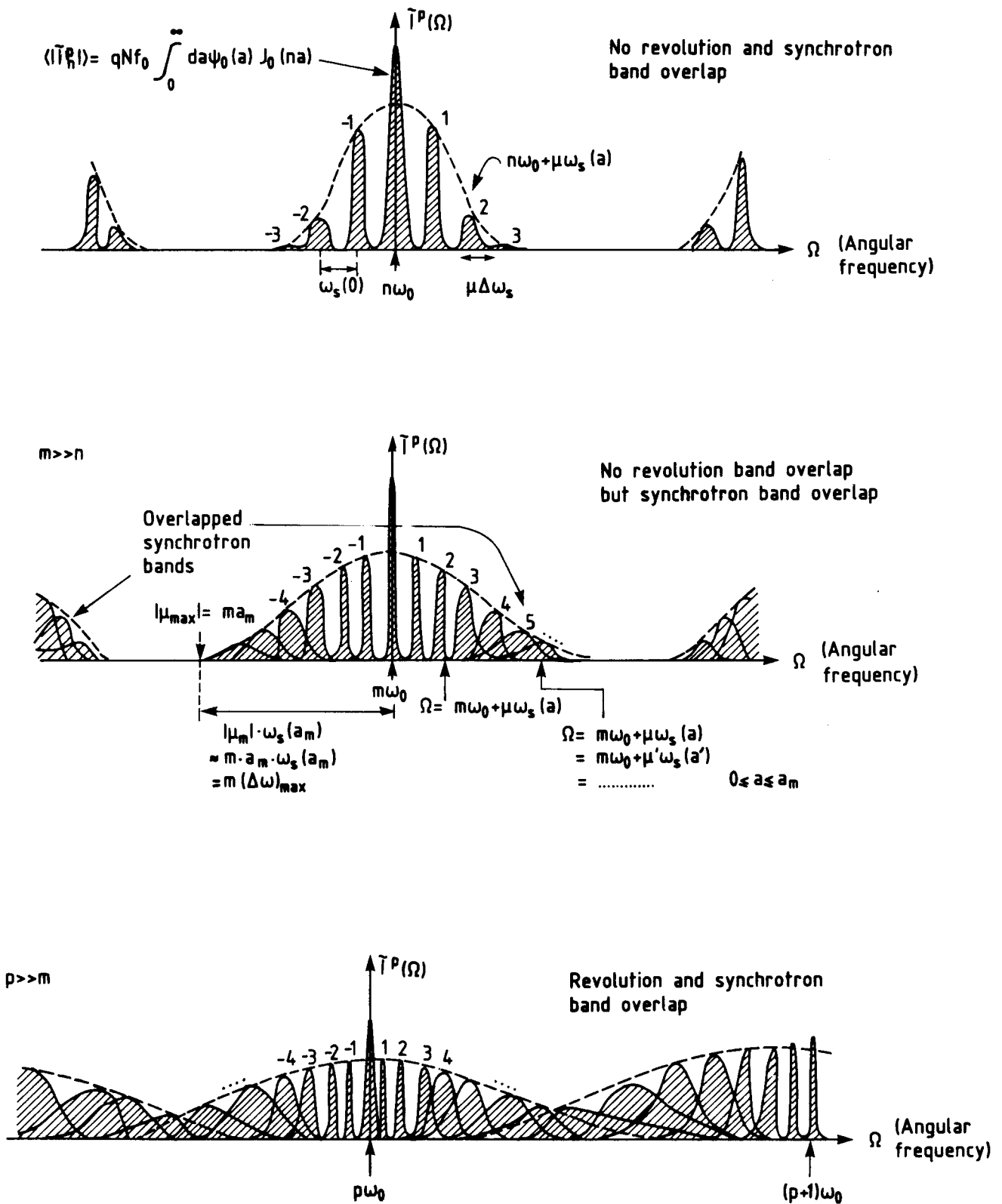

Fig. 13 Overlapping of bunched beam fluctuation bands as a function of frequency in different frequency domains

The macroscopic charge-density signal is given by

$$\langle \tilde{\rho}^P(\Omega) \rangle = q \sum_{j=1}^N \sum_{m=-\infty}^{+\infty} J_0(ma_j) e^{+im\theta_P} \delta[\Omega - m\omega_0] \quad (3.85)$$

and has contributions from only the $\mu = 0$ central bands [since $\langle \exp(i\mu\psi_j) \rangle = \delta_{\mu,0}$]. It is zero at all frequencies except for those which are exact multiples of ω_0 , $\Omega = m\omega_0$, $m = 0, \pm 1, \pm 2, \dots, \pm \infty$. The magnitude of the Fourier component at a particular harmonic $m = n$ of the time periodic (period $T_0 = 2\pi/\omega_0$) macroscopic charge-density signal is given by

$$\langle \tilde{\rho}_n^P \rangle = \frac{q}{2\pi} \sum_{j=1}^N J_0(na_j) e^{+in\theta_P} = \frac{q}{2\pi} \sum_{j=1}^N J_0\left(\frac{\Omega}{\omega_0} a_j\right) e^{+i(\Omega/\omega_0)\theta_P} \quad (3.86)$$

or

$$\langle \tilde{\rho}_n^P \rangle = \frac{qN}{2\pi} \int_0^\infty da \Psi_0(a) J_0(na) e^{+in\theta_P}, \quad (3.87)$$

where $\Psi_0(a)$ is a suitably normalized (to unity) distribution of particles in synchrotron oscillation amplitudes. The corresponding macroscopic (coherent) bunch current in the n^{th} harmonic is simply obtained by multiplying Eq. (3.87) by $\omega_0 = 2\pi f_0$ [in Eq. (3.74) the $\delta_{\mu+1,0}$ and $\delta_{\mu-1,0}$ terms, containing the $\Delta\omega_j$ contribution, cancel out since $J_1(x) = -J_{-1}(x)$] and is given by

$$\langle \tilde{I}_n^P \rangle = qNf_0 \int_0^\infty da \Psi_0(a) J_0(na) e^{+in\theta_P}. \quad (3.88)$$

It is easy to verify that the above is identical with the Fourier components of a periodic infinite pulse-train representation of the macroscopic coherent bunch current, thus:

$$\langle I(\theta(t); t) \rangle = qN\omega_0 \int d\dot{\theta} g(\theta(t), \dot{\theta}) \quad (3.89)$$

and

$$\begin{aligned} \langle I_n(t) \rangle &= qN \frac{\omega_0}{2\pi} \iint d\theta d\dot{\theta} g(\theta(t), \dot{\theta}) e^{-in\theta(t)} \\ &= qNf_0 \int_0^\infty \int_0^{2\pi} da d\psi \Psi_0(a, \psi) e^{-ina \sin \psi} e^{-in\omega_0 t} \\ &= qNf_0 \int_0^\infty da \Psi_0(a) J_0(na) e^{-in\omega_0 t} \end{aligned} \quad (3.90)$$

so that

$$\langle I(\theta_P; t) \rangle = \sum_{n=-\infty}^{+\infty} \langle I_n(t) \rangle e^{+in\theta_P} = \sum_{n=-\infty}^{+\infty} \langle \tilde{I}_n^P \rangle e^{-in\omega_0 t}, \quad (3.91)$$

where

$$\langle \tilde{I}_n^P \rangle = qNf_0 \int_0^\infty da \Psi_0(a) J_0(na) e^{+in\theta_P} . \quad (3.92)$$

We have used the invariance of phase-space density $g(\theta, \dot{\theta}) d\theta d\dot{\theta} = \Psi_0(a, \psi) da d\psi$ in going from the first line to the second in Eq. (3.90). We have also assumed that the stationary bunch distribution $\Psi_0(a, \psi) \equiv \Psi_0(a)$ is independent of the angle variable ψ . We can also write

$$\langle I(\theta_P; t) \rangle = \frac{1}{2} C_0 + \sum_{n=1}^{\infty} C_n \cos [2\pi n f_0 t + \phi_n] , \quad (3.93)$$

where

$$C_0 = qNf_0$$

$$C_n = 2(qNf_0) \int_0^\infty da \Psi_0(a) J_0(na) \quad \text{and} \quad \phi_n = +n\theta_P . \quad (3.94)$$

Thus, rather than computing the coherent harmonics from Eq. (3.88), which requires using a specific distribution $\Psi_0(a)$, we can simply compute it by taking for the bunch a periodically repeating simple pulse shape in time, which is approximately known experimentally.

For example, for a cosine-squared pulse bunch (Fig. 14), characteristic of the proton bunches in the SPS at CERN,

$$I(t) = \frac{2Nq}{t_0} \cos^2 \pi \left(\frac{t}{t_0} \right) = \frac{Nq}{t_0} \left[1 + \cos 2\pi \left(\frac{t}{t_0} \right) \right] \quad \text{for } -\frac{1}{2} t_0 < t < \frac{1}{2} t_0 ,$$

$$= 0 \quad \text{otherwise} \quad (3.95)$$

we obtain

$$C_n = 2(Nqf_0) \left| \frac{\sin(n\pi t_0/T_0)}{(n\pi t_0/T_0)[1-(nt_0/T_0)^2]} \right| . \quad (3.96)$$

Note that the area under one pulse is Nq , the total charge per pulse. The power in the coherent harmonics thus falls off as $|C_n|^2 \propto 1/n^6$ for large n .

Another example is the case of electron bunches in electron storage rings. Owing to thermodynamic equilibrium between various diffusive processes (e.g. quantum diffusion due to discrete emission of photons in synchrotron radiation, intra-beam Coulomb scattering, etc.) and the synchrotron radiation damping process, the electron bunches may be fairly well characterized by Gaussian pulse shapes in time or longitudinal length, as follows (Fig. 15):

$$I(t) = \frac{Nq}{\sqrt{2\pi}t_0} e^{-t^2/2t_0^2} = \frac{Nqc}{\sqrt{2\pi}\sigma} e^{-(ct)^2/2\sigma^2} = I_b \frac{\sqrt{2\pi}R}{\sigma} e^{-(ct)^2/2\sigma^2} , \quad (3.97)$$

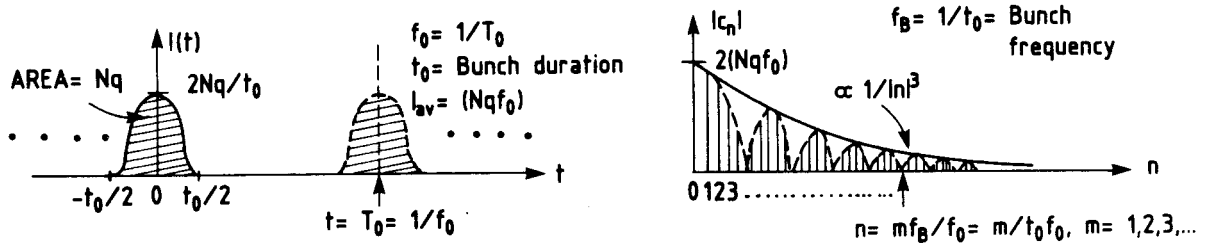

Fig. 14 Macroscopic current and coherent harmonics of a cosine-squared pulse bunch

where $\sigma = ct_0$ is the longitudinal r.m.s. length of the bunch; $I_b = (Nqc/2\pi R) = Nqf_0$ is the d.c. average current of the bunch; R is the average storage ring radius; and c is the speed of the centre of the bunch, almost the speed of light. Assuming negligible overlap between successive periodic bunches because of infinitely long Gaussian tails ($T_0 \gg t_0$), we obtain

$$C_n = 2(Nqf_0) e^{-2\pi^2 t_0^2 n^2 f_0^2} \quad (3.98)$$

The power in the coherent harmonics thus falls off as $|C_n|^2 \propto \exp(-4\pi^2 t_0^2 n^2 f_0^2)$.

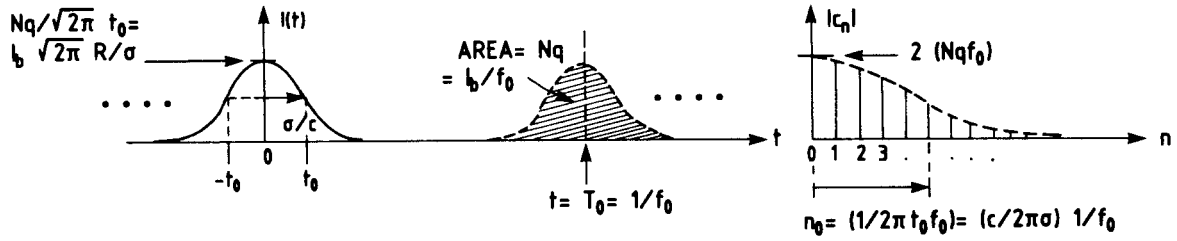

Fig. 15 Macroscopic current and coherent harmonics of a Gaussian pulse bunch

In general, if $\Delta t = \Delta\theta/\omega_0$ is a measure of the effective bunch duration as it passes the PU, the spectrum of coherent revolution harmonics at $f = nf_0$ tapers off at very high frequencies with a characteristic 'cut-off' frequency given roughly by $f_c \cong 1/\Delta t \cong \omega_0/\Delta\theta$.

The longitudinal charge-density fluctuations then contain only the $\mu \neq 0$ terms and are given by

$$\begin{aligned} \widetilde{\delta\rho^P}(\Omega) &= \widetilde{\rho^P}(\Omega) - \langle \widetilde{\rho^P}(\Omega) \rangle \\ &= q \sum_{j=1}^N \sum_{\substack{m, \mu \neq 0 \\ (-\infty) \\ (-\infty)}} J_{\mu}(ma_j) e^{-i\mu\psi_j^0 + im\theta_P} \delta[\Omega - m\omega_0 - \mu\omega_s(a_j)] \end{aligned} \quad (3.99)$$

and

$$\langle \widetilde{\delta\rho^P}(\Omega) \rangle = 0 \quad (3.100)$$

The bi-frequency cross-power spectral density of the charge-density fluctuations is then

$$\begin{aligned}
P_{\delta\rho}^{\text{PK}}(\Omega, \Omega') &= \langle \widetilde{\delta\rho}^{\text{P}}(\Omega) \widetilde{\delta\rho}^{\text{K}*}(\Omega') \rangle \\
&= q^2 \sum_{i,j=1}^N \underbrace{\sum_{m,n} \sum_{\mu, \mu' \neq 0}^{(+\infty)} (-\infty)}_{(-\infty)} J_{\mu}(ma_j) J_{\mu'}(na_i) \langle e^{-i\mu\psi_j^0 + i\mu'\psi_i^0} \rangle e^{-in\theta_K + im\theta_P} \\
&\quad \delta[\Omega - m\omega_0 - \mu\omega_s(a_j)] \delta[\Omega' - n\omega_0 - \mu'\omega_s(a_i)] \quad . \quad (3.101)
\end{aligned}$$

After performing the averaging indicated by the angular brackets, we obtain

$$P_{\delta\rho}^{\text{PK}}(\Omega, \Omega') = 2\pi \sum_{k=-\infty}^{+\infty} (P_{\delta\rho}^{\text{PK}})_k(\Omega) \delta(\Omega - \Omega' - k\omega_0) \quad , \quad (3.102)$$

where

$$\begin{aligned}
(P_{\delta\rho}^{\text{PK}})_k(\Omega) &= \frac{q^2 N}{(2\pi)} \int_0^{\infty} da \Psi_0(a) \underbrace{\sum_m \sum_{\mu \neq 0}^{(+\infty)} (-\infty)}_{(-\infty)} J_{\mu}[(m-k)a] J_{\mu}(ma) e^{+im(\theta_P - \theta_K) - ik\theta_P} \\
&\quad \delta[\Omega - m\omega_0 - \mu\omega_s(a)] \quad , \quad (3.103)
\end{aligned}$$

and we have replaced $\sum_{j=1}^N F(a_j)$ by $N \int_0^{\infty} da \Psi_0(a) F(a)$ as before. The bunched beam fluctuations are thus not even ‘weakly stationary’. The non-stationarity is, however, periodic, thus correlating fluctuations at frequency Ω with fluctuations only at those other frequencies $\Omega' = \Omega + m\omega_0$, $m = 0, \pm 1, \dots$, as is typical of periodically time-varying systems.

Similar cross-power spectral densities, with correlated harmonic structure due to periodic time-variations, can be written down for the transverse dipole-moment fluctuations. The only difference is that the macroscopic beam dipole-moment vanishes, i.e. $\langle \bar{D}^{\text{P}}(\Omega) \rangle = 0$ owing to the random betatron phase-factor ϕ_j^0 , and the total dipole-moment signal is the same as the dipole-moment fluctuation signal, which thus includes the $\mu = 0$ contribution. For the dipole-moment charge-density fluctuations, we get the following cross-power spectral density (including the $\mu = \mu' = 0$ term):

$$\begin{aligned}
(P_D^{\text{PK}})_k(\Omega) &= \frac{q^2 N}{4(2\pi)} \int_0^{\infty} \int_0^{\infty} da \, dA \, A^2 \Psi(a, A) \\
&\quad \sum_m \sum_{\mu} \sum_{(\pm)}^{(+\infty)} (-\infty) J_{\mu}[(m-k\pm Q)a - Q\frac{\xi}{\eta}a] J_{\mu}[(m\pm Q)a - Q\frac{\xi}{\eta}a] \\
&\quad e^{-im(\theta_P - \theta_K) - ik\theta_P} \delta[\Omega - (m\pm Q)\omega_0 - \mu\omega_s(a)] \quad . \quad (3.104)
\end{aligned}$$

Taking $\Psi(a, A) = \Psi_0(a)\Phi_0(A)$, which assumes independent distributions in a and A , we have

$$\begin{aligned}
(P_D^{PK})_k(\Omega) &= \frac{q^2 N}{4(2\pi)} \langle A^2 \rangle \int_0^\infty da \Psi_0(a) \\
&\sum_{\substack{m \\ (-\infty)}}^{(+\infty)} \sum_{\mu} \sum_{(\pm)} J_\mu \left[(m-k\pm Q)a - Q \frac{\xi}{\eta} a \right] J_\mu \left[(m\pm Q)a - Q \frac{\xi}{\eta} a \right] \\
&e^{-im(\theta_P - \theta_K) - ik\theta_P} \delta \left[\Omega - (m\pm Q)\omega_0 - \mu\omega_s(a) \right] , \quad (3.105)
\end{aligned}$$

where again $\langle A^2 \rangle = \int_0^\infty dA A^2 \Phi_0(A)$ is the mean squared betatron amplitude in the beam.

The components $(P_D^{PK})_k(\Omega)$ and $(P_B^{PK})_k(\Omega)$, $k = 0, \pm 1, \pm 2, \dots$, may be thought of as the Bloch components of fluctuation power spectral-density of the periodic structure formed by the bunched beam and the PUs in the storage-ring system. For the moment, let us consider the zeroth Bloch component $k = 0$ of the fluctuations. It is obvious that for overlapping bands (revolution and betatron bands overlapping), the particles in different revolution and betatron bands, in different synchrotron bands, and having different synchrotron oscillation amplitudes, will contribute to the $k = 0$ Bloch component (the same is true for $k \neq 0$ components) of power spectral-density by harmonically generating the same frequency Ω through the resonance conditions

$$\Omega = m\omega_0 + \mu\omega_s(a) = m'\omega_0 + \mu'\omega_s(a') = \dots \quad (3.106)$$

for the longitudinal fluctuations and

$$\Omega = (m\pm Q)\omega_0 + \mu\omega_s(a) = (m'\pm Q)\omega_0 + \mu'\omega_s(a') = \dots \quad (3.107)$$

for the transverse fluctuations. If the revolution bands do not overlap, the resonance condition is satisfied for only one value of $m = m' = \dots$, equal to n , say. If for the transverse signals, the betatron bands also do not overlap, we may write $\Omega = \Omega_n^{(\pm)} = (n\pm Q)\omega_0 + \Delta\Omega = (n\pm Q)(\omega_0 + \omega')$, and for $\theta_P = \theta_K$, the zeroth Bloch component becomes

$$\begin{aligned}
(P_D^{P=K})_{k=0} \left[\Omega = \Omega_n^{(\pm)} \right] &= (P_D)_0 \left[\Omega_n^{(\pm)} \right] \\
&= \frac{q^2 N}{4(2\pi)} \langle A^2 \rangle \int_0^\infty da \Psi_0(a) \sum_{\mu=-\infty}^{+\infty} J_\mu^2 \left[(n\pm Q)a - Q \frac{\xi}{\eta} a \right] \\
&\delta \left[(n\pm Q)\omega' - \mu\omega_s(a) \right] . \quad (3.108)
\end{aligned}$$

The average power per non-overlapping betatron band is then

$$\langle |D_{n\pm Q}|^2 \rangle = \frac{q^2 N}{4(2\pi)^2} \langle A^2 \rangle \sum_{\mu=-\infty}^{+\infty} F_{n,\mu}^{(\pm)} , \quad (3.109)$$

where the form factor $F_{n,\mu}^{(\pm)}$ is the integral along the bunch of the Bessel function squared, weighted by the normalized amplitude distribution:

$$F_{n,\mu}^{(\pm)} = \int_0^{\infty} da \Psi_0(a) J_{\mu}^2[(n\pm Q)a - Q \frac{\xi}{\eta} a] . \quad (3.110)$$

Since

$$\sum_{\mu=-\infty}^{+\infty} J_{\mu}^2(x) = 1 \quad \text{and} \quad \int_0^{\infty} da \Psi_0(a) = 1 , \quad (3.111)$$

we have the following 'sum rules' for the form factors:

$$\sum_{\mu=-\infty}^{+\infty} F_{n,\mu}^{(+)} = \sum_{\mu=-\infty}^{+\infty} F_{n,\mu}^{(-)} = 1 , \quad (3.112)$$

and the total power per non-overlapping betatron band ($n \pm Q$) of a bunched beam, summed over all the synchrotron bands, is simply

$$\langle |D_{n\pm Q}|^2 \rangle = \frac{q^2 N}{4(2\pi)^2} \langle A^2 \rangle . \quad (3.113)$$

In the space of real positive revolution harmonics $|n|$, we have the average power per band ($|n| \pm Q_f$) detected by a spectrum analyser in real positive frequency given by

$$\langle |D_{|n|\pm Q_f}|^2 \rangle = 2 \langle |D_{n\pm Q_f}|^2 \rangle = \frac{q^2 N}{2(2\pi)^2} \langle A^2 \rangle . \quad (3.114)$$

Multiplying by ω_0^2 [thus neglecting modulations induced by $\Delta\omega$ in $(\omega_0 + \Delta\omega)^2$], we get the zeroth-order dipole-moment current-density average power per band ($|n| \pm Q$) given by

$$\langle |d_{|n|\pm Q_f}|^2 \rangle = \omega_0^2 \langle |D_{|n|\pm Q_f}|^2 \rangle = \frac{N}{2} q^2 f_0^2 \langle A^2 \rangle , \quad (3.115)$$

in full agreement with the result for continuous coasting beams.

Similarly, the average longitudinal charge-density fluctuation power per revolution harmonic $|n|$ in the real positive observable frequency domain is

$$\langle |\delta\rho_{|n|}|^2 \rangle = 2N \frac{q^2}{(2\pi)^2} = \frac{q^2 N}{2\pi^2} , \quad (3.116)$$

and the zeroth-order current-density fluctuation average power per observable revolution harmonic $|n|$ is

$$\langle |\delta I_{|n|}|^2 \rangle = \omega_0^2 \langle |\delta \rho_{|n|}|^2 \rangle = 2Nq^2 f_0^2 \quad . \quad (3.117)$$

Note that the average power per band for the total charge density is

$$\langle |\rho_{|n|}|^2 \rangle = \frac{q^2}{2\pi^2} [N + \mathcal{O}(N^2)] \quad . \quad (3.118)$$

The second term of $\mathcal{O}(N^2)$ is the contribution of the macroscopic coherent bunch current at harmonic $|n|$ and contains no fluctuation power.

It is illuminating to re-express the zeroth Bloch component, $(P_{\delta q}^{P=K})_{k=0}(\Omega)$ say, in a different form that lends itself easily to a comparison with the power spectral-density of continuous coasting beams. We introduce the new variable $W = \mu\omega_s(a) = m\omega'$ and perform the following transformation:

$$\begin{aligned} \int d\omega_s \sum_{\substack{\mu=-\infty \\ \neq 0}}^{+\infty} F_{\mu}^m(\omega_s) \delta(\Omega - m\omega_0 - \mu\omega_s) &= \int d\omega_s \sum_{\substack{\mu=-\infty \\ \neq 0}}^{+\infty} F_{\mu}^m(\omega_s) \delta(\Omega - m\omega_0 - W) \delta(W - \mu\omega_s) dW \\ &= \int_{-\Delta_m}^{+\Delta_m} dW H_m(W) \delta(\Omega - m\omega_0 - W) \\ &= \int d\omega' K_m(\omega') \delta(\Omega - m\omega_0 - m\omega') \\ &= \int d\omega G_m(\omega) \delta(\Omega - m\omega) \quad , \end{aligned} \quad (3.119)$$

where $\omega = \omega_0 + \omega'$ and $2\Delta_m$ is the width of the m^{th} revolution band, and

$$H_m(W) = \sum_{\substack{\mu=-\infty \\ \neq 0}}^{+\infty} \frac{1}{|\mu|} F_{\mu}^m\left(\frac{W}{\mu}\right) \quad (3.120)$$

$$K_m(\omega') = \sum_{\substack{\mu=-\infty \\ \neq 0}}^{+\infty} \frac{m}{|\mu|} F_{\mu}^m\left(\frac{m\omega'}{\mu}\right) \quad (3.121)$$

$$G_m(\omega) = \sum_{\substack{\mu=-\infty \\ \neq 0}}^{+\infty} \frac{m}{|\mu|} F_{\mu}^m\left[\frac{m(\omega - \omega_0)}{\mu}\right] \quad . \quad (3.122)$$

We thus sum over μ and $\omega_s(a)$ first, for all values, such that $\mu\omega_s(a) = W = \text{const}$, and then integrate over $W = m\omega' = m(\omega - \omega_0)$ covering the whole m^{th} revolution band. The transformation from summation over μ and integration over ω_s to an effective integration over W is depicted in Fig. 16.

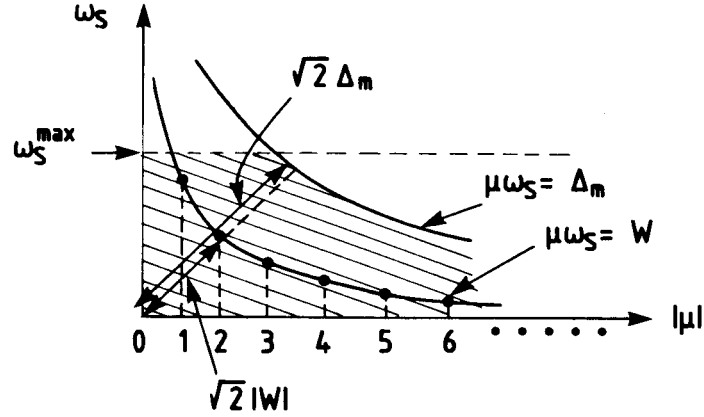

Fig. 16 The transformation $\sum_{\mu} \int d\omega_s \rightarrow \int dW$

Taking into account the Jacobian of the transformation $a \rightarrow \omega_s(a)$, we can then rewrite

$$(P_{\delta\rho}^{P=K})_{k=0}(\Omega) = \frac{q^2 N}{2\pi} \sum_{m=-\infty}^{+\infty} \int dW \Psi_m(W) \delta(\Omega - m\omega_0 - W) \quad , \quad (3.123)$$

where

$$\begin{aligned} \Psi_m(W) &= \sum_{\substack{\mu=-\infty \\ \neq 0}}^{+\infty} \frac{1}{|\mu|} \left\{ \Psi_0[a(\omega_s)] J_{\mu}^2[ma(\omega_s)] \left| \frac{da(\omega_s)}{d\omega_s} \right| \right\}_{\omega_s=W/\mu} \\ &= \sum_{\substack{\mu=-\infty \\ \neq 0}}^{+\infty} \frac{1}{|\mu|} g_0\left(\frac{W}{\mu}\right) \left\{ J_{\mu}^2[ma(\omega_s)] \right\}_{\omega_s=W/\mu} \quad . \end{aligned} \quad (3.124)$$

Here $g_0(\omega_s)$ is the distribution of particles in synchrotron oscillation frequencies, so that $g_0(\omega_s) d\omega_s = \Psi_0(a) da$, and $a(\omega_s)$ is the oscillation amplitude as a function of synchrotron frequency. In terms of ω , we may write

$$(P_{\delta\rho}^{P=K})_{k=0}(\Omega) = \frac{q^2 N}{2\pi} \sum_{m=-\infty}^{+\infty} \int d\omega G_m(\omega) \delta(\Omega - m\omega) \quad , \quad (3.125)$$

where

$$G_m(\omega) = \sum_{\substack{\mu=-\infty \\ \neq 0}}^{+\infty} \frac{m}{|\mu|} g_0 \left[\frac{m(\omega-\omega_0)}{\mu} \right] \left\{ J_\mu^2 [ma(\omega_s)] \right\}_{\omega_s = m(\omega-\omega_0)/\mu} \quad (3.126)$$

We may also write Eqs. (3.123) and (3.125) simply as

$$\left(P_{\delta\rho}^{P=K} \right)_{k=0}(\Omega) = \frac{q^2 N}{2\pi} \Psi(\Omega) \quad , \quad (3.127)$$

where

$$\begin{aligned} \Psi(\Omega) &= \sum_{m=-\infty}^{+\infty} \Psi_m(\Omega - m\omega_0) = \sum_{m=-\infty}^{+\infty} \frac{1}{|m|} G_m \left(\frac{\Omega}{m} \right) \\ &= \sum_{\substack{\mu=-\infty \\ \neq 0}}^{+\infty} \sum_{m=-\infty}^{+\infty} \frac{1}{|\mu|} g_0 \left(\frac{\Omega - m\omega_0}{\mu} \right) \left\{ J_\mu^2 [ma(\omega_s)] \right\}_{\omega_s = (\Omega - m\omega_0)/\mu} \end{aligned} \quad (3.128)$$

We may then again interpret $\Psi(\Omega)$ as the normalized distribution of particles in the real frequency-space Ω , its magnitude giving a relative measure of the number of all the particles that can harmonically generate a frequency in the neighbourhood of Ω , as in Eq. (3.37), for the continuous coasting beam case. The $\Psi_m(W)$ may be interpreted as the distribution of particles in the frequency offset $W = \Omega - m\omega_0$ in the m^{th} revolution Schottky band. The quantity ω in $G_m(\omega)$ can be interpreted as the revolution angular frequency of particles, with $G_m(\omega)$ being the equivalent distribution of the bunch particles in the fundamental revolution frequencies ω as far as the m^{th} revolution band is concerned. We then see that for the zeroth Bloch component of power spectral-density, a bunched beam may be thought of as an equivalent continuous coasting beam with effective distribution in revolution angular frequency $G_m(\omega)$ with half-spread $\Delta\omega = \Delta_m/m$, $G_m(\omega)$ varying from harmonic to harmonic. All the fine structure due to synchrotron oscillations within a bunch is then hidden in the fine structure of $G_m(\omega)$, or, more simply, $\Psi(\Omega)$ as a function of frequency. However, the correlation from harmonic to harmonic, which is due to the spatially confined and periodically repeating bunched structure, remains, as is evident from the existence of $k \neq 0$ Bloch components. Similar equivalent distributions, $\Psi_m^k(W)$, $G_m^k(\omega)$, and $\Psi^k(\Omega)$, can however be introduced to re-express $k \neq 0$ Bloch components of cross-power spectral-density in a similar manner.

The above analysis of bunched beam Schottky signals can be generalized to arbitrary oscillatory synchrotron orbits⁷⁾ (not necessarily quasi-linear sinusoidal orbits as above) by defining certain orbit integrals $O_\mu(n, J)$ which, for the simple case of quasi-linear sinusoidal orbits, reduce to the Bessel functions $J_\mu(na)$ used in this section. The $O_\mu(n, J)$'s are defined⁷⁾ by writing

$$\theta(t) = \omega_0 t + \Theta[J, \psi(t)] \quad , \quad (3.129)$$

where J and ψ are general action-angle variables as introduced in Section 2, and Fourier decomposing $\exp[in\Theta(J,\psi)]$ in the 2π -periodic angle variable ψ :

$$e^{in\Theta(J,\psi)} = \sum_{\mu=-\infty}^{+\infty} O_{\mu}(n,J) e^{i\mu\psi} , \quad (3.130)$$

where

$$O_{\mu}(n,J) = \frac{1}{2\pi} \int_0^{2\pi} d\psi e^{in\Theta(J,\psi)-i\mu\psi} \quad (3.131)$$

$$\text{and } \psi(t) = \omega_s(J)t + \psi_0 .$$

The following important properties of $O_{\mu}(n,J)$ follow immediately:

$$O_{\mu}(n,J) = O_{-\mu}^*(-n,J)$$

$$\sum_{\substack{\mu \\ (-\infty)}}^{(+\infty)} \sum_{\mu'} O_{\mu}(n,J) O_{\mu'}(-n,J) e^{i(\mu+\mu')\psi} = 1 \quad (3.132)$$

$$\sum_{\mu=-\infty}^{+\infty} O_{\mu}(n,J) O_{-\mu}(-n,J) = \sum_{\mu=-\infty}^{+\infty} |O_{\mu}(n,J)|^2 = 1 .$$

The generalization is trivial and we will not discuss it any further. Indeed, the appearance of the synchrotron side-bands due to RF phase modulation of the beam is analogous to the FM side-bands produced in the frequency modulation of a carrier sine wave in communications theory, where a large variety of such modulations have already been studied.

Again as for continuous coasting beams, correlations between particles, in addition to the macroscopic gross correlation due to the bunched structure, will deform the bunch fluctuation spectrum. Such deformation, due to correlations induced by impedances or external feedback loops, will be studied in Section 11. In general, for both the continuous and the bunched coasting beams, the collective correlations will distort the fluctuation spectrum and may produce additional peaks on top of the broad central peaks around $n\omega_0$, $(n \pm Q_f)\omega_0$, which are present in the uncorrelated fluctuation spectrum owing to the velocity distribution and the zeroth-order time structure of the beam.

4. INFORMATION DEGREES OF FREEDOM IN FLUCTUATION SIGNALS

Longitudinal and transverse Schottky fluctuation signals derived from a beam at a localized pick-up contain information about the phase space and time structure of the beam. However, the signal needs to be processed with a finite non-zero bandwidth to extract this information. A single fixed-frequency line of constant amplitude and phase does not, of course, carry any information. The information is embedded only when either the amplitude or the phase or the frequency itself is allowed to vary with time. Such amplitude, phase, or frequency modulation will, however, produce side-bands at the modulation frequencies and their harmonics in general, extending over a frequency range typically proportional to the inverse of the characteristic time scale of the variation. Such side-bands then effectively constitute or generate the bandwidth necessary to characterize the time structure of the variations imposed on the fixed-frequency constant carrier signal. If τ_0 measures the characteristic time interval for significant variation of the signal, the side-bands will have significant strengths over a bandwidth of $W_0 \sim (\tau_0)^{-1}$ in the frequency space. Taking into account all the generated frequency lines within a bandwidth $\geq W_0$ then gives an effective time resolution of $\tau \leq \tau_0$, which is necessary for a precise knowledge of the time structure. A bandwidth of W_0 is thus sufficient to fully characterize the signal. Processing the signal with a bandwidth less than the modulation bandwidth of the signal, $W < W_0$, will then produce an effective time resolution of $\tau = 1/W > 1/W_0 = \tau_0$ and will introduce imprecision or uncertainty in the time signal reconstructed for times less than $\tau = 1/W$. Information about the signal time structure is thus incomplete. If the modulation bands are distributed more or less evenly in the frequency space, the information content in W thus increases linearly with W , approaching near-completeness as $W \rightarrow W_0$, until W_0 —beyond which it stays the same. The processing bandwidth W is thus a direct measure of the information content in the reconstructed signal.

Let us consider, for the moment, the longitudinal fluctuation signal of a charged-particle beam detected at a particular azimuth in the storage ring. The single-particle longitudinal current signal from the j^{th} particle per turn, denoted by (t_j, ξ_j) , is essentially two-dimensional, and is characterized by the time t_j the j^{th} particle is at the PU and by the strength ξ_j of the signal induced. For the current fluctuations, ξ_j is proportional to the longitudinal energy E_j or angular velocity ω_j of the j^{th} particle, and the set (t_j, ξ_j) is thus simply related to the two-dimensional longitudinal phase space of the dynamical coordinates of the particle. The fluctuation signal from the whole beam per turn is then completely characterized by the $2N$ independent numbers given by the set $\bigcup_{j=1, \dots, N} (t_j, \xi_j)$, the same number as that of the longitudinal phase-space degrees of freedom (DOF) of the whole beam. The inherent DOF of the longitudinal fluctuation signal of the whole beam is thus $2N$. In the frequency domain, these $2N$ independent numbers, containing complete information about the fluctuations, have to be extracted from the *amplitude* and *phase* of N *different uncorrelated* (i.e. independent) frequency lines.

The longitudinal fluctuation signal of a charged-particle beam detected at a particular azimuth in the storage ring, as we have just seen in Section 3, is distributed in the frequency space in bands around each harmonic $n\omega_0$ of the fundamental revolution frequency ω_0 of the nominal particle. For continuous (i.e. debunched) coasting beams, as we move from one revolution harmonic band to the next, we obtain new information about the beam distribution in phase space owing to the different phase factors $\exp(in\theta_j^0)$, $j = 1, \dots, N$ in each band. In other words, the frequency components $(\Omega_k) = (\Omega' + k\omega_0)_{k=0, \pm 1, \pm 2, \dots}$ [where $n\omega_0 - n(\Delta\omega/2) \leq \Omega' \leq n\omega_0 + n(\Delta\omega/2)$ ($\Delta\omega$ being the full spread in the beam angular revolution frequencies)] in successive

harmonics of the revolution frequency are *uncorrelated, independent, and orthogonal* in the interval $(0, 2\pi)$ in azimuth or $(0, T_0)$ in time occupied by a continuous coasting beam. We thus obtain maximum information with no redundancy in going from band to band successively, as it provides us with magnitudes (both amplitude and phase) of successive orthogonal projections of the full beam signal over the entire beam space with a fundamental cell of $(0, 2\pi)$ in angle or $(0, T_0)$ in time. The $2N$ independent numbers, necessary for a complete knowledge of the fluctuations, can then be obtained from the amplitude and phase information from N successive revolution harmonic bands, constituting a minimum bandwidth of $W_0 = Nf_0$ which is required for such complete specification of fluctuations. This is expected, since the particles in a continuous coasting beam are distributed over an interval of time equal to the period $T_0 = 1/f_0$ in the storage ring, and the average spacing in time between particles is of the order of $\delta t \sim (T_0/N)$. To distinguish between successive particles by discriminating each particle's arrival time, we have to have a time resolution of at most $\tau_0 \sim \delta t \sim (T_0/N)$. The bandwidth that is sufficient for this is $W_0 \sim (\tau_0)^{-1} = (N/T_0) = Nf_0$. The number of revolution harmonics necessary to be within the bandwidth so as to recover the complete information in the fluctuation signal, is thus equal to the total number of particles N , typically 10^{11} , say. This number is large indeed, and practical PUs or signal processing devices will normally have bandwidths less than above, $W < W_0 = Nf_0$. The fluctuation signal processed by a finite bandwidth $W < W_0$ will, however, have a different number of DOF, less than $2N$, and the corresponding information content is always less than complete. What, then, is the DOF of the observed fluctuation signal, processed by a bandwidth $W < Nf_0$ of the detecting PU?

If the beam signal is processed by a PU with a bandwidth $W (< W_0 = Nf_0)$ in frequency, the DOF of the message or time signal characterized by a length $T_0 = 1/f_0$ and a width W in frequency is simply²⁷⁾ $M \cong 2WT_0 = (2W/f_0)$, i.e. twice the number of revolution harmonics within the bandwidth W . Note that we have to specify both the amplitude and phase at each of the (W/f_0) orthogonal components and hence the factor of 2 (the amplitude is related to the strengths ξ_j and the phase to the times t_j in single-particle signals in the time domain). The signal from a continuous coasting beam per turn is thus characterized by $(M/2) = (W/f_0)$ independent complex numbers. These $(M/2)$ independent complex numbers per turn, characterizing this information, will change from turn to turn both in their magnitudes and phases owing to ever-mixing phases within the beam; this is the crucial element in the stochastic cooling practice²⁰⁻²³⁾. In the time-domain, the M numbers correspond to approximately $M = 2WT_0 = (2W/f_0)$ different and independent time signals obtained from M successive time samples of the beam at the PU. The larger the number of these samples, the more we know about the beam phase space—the PU probes the beam with higher resolution and the corresponding information content M in the PU signals is larger. The change of this information content from turn to turn then corresponds to the migration of particles in the beam from sample to sample each turn, i.e. phase mixing. When $W = W_0 = Nf_0$, we recover $M_0 = (2W_0/f_0) = 2N$ as the inherent total number of DOF of the fluctuation signals. The PU discriminates each individual particle. No new information is obtained for $W > W_0$ so that the maximum number of DOF is simply M_0 , $M \leq M_0 = 2N$.

The situation is different for a single bunch of azimuthal length less than 2π in the storage ring. Whilst components at each successive revolution harmonic are still orthogonal to each other over the interval $(0, 2\pi)$ in θ , they are not so over the interval $\Delta\theta$ in azimuth occupied by the beam. Successive revolution harmonics are strongly correlated to reproduce the azimuthally confined bunched nature of the beam. They contain pretty much the same information as far as the

structure within $\Delta\theta$ is concerned, until we consider revolution harmonics nf_0 and mf_0 spaced by the bunch frequency $f_B = (\Delta t)^{-1}$, where Δt is the bunch duration. It is apparent from Table 1 in Section 3 that lines corresponding to the same synchrotron mode number μ in successive revolution harmonic bands m have the same phase factor $e^{i\mu\psi_j^0}$ (θ_P can be assumed zero without loss of generality) and similar weight factors $J_\mu(ma_j)$, until we consider harmonics where the argument of the Bessel function has gone through a phase change of π , $(\Delta m)a_j \sim \pi$. (This corresponds to a separation in frequency of $(\Delta m)f_0 = (\pi/a_j)f_0 = Bf_0 = f_B$, where $B = \pi/a_j = 2\pi/2a_j$ is the bunching factor for a bunch of azimuthal extent $2a_j$.) All the intermediate revolution bands between the bands spaced by f_B merely reproduce the fact that there is no beam in the rest of the storage ring except in the interval $\Delta\theta$, or that the beam signal is empty at the PU for most of the time except during the short period of bunch duration. For a single bunch in a storage ring, this information is thus redundant and says very little about the structure within the particular non-empty bunch of interest. A little reflection makes it clear that indeed in the bunch space ($\Delta\theta$ or Δt) it is the lines separated by f_B , $(\Omega_k) = (\Omega' + kf_B)_{k=0, \pm 1, \pm 2, \dots}$, that are orthogonal over the interval $\Delta\theta$ or Δt , and maximum non-redundant information is obtained only by considering components at successive bands spaced approximately f_B apart. The number of DOF of a single bunch signal of duration Δt , processed by a bandwidth W , i.e. the number of independent numbers characterizing the signal per single bunch per turn, is then²⁸⁾

$$M = 2W \cdot \Delta t = \frac{2W}{f_B} = \frac{2W}{f_0} B^{-1} \quad , \quad (4.1)$$

where $B = T_0/\Delta t = f_B/f_0$ is the ‘bunching factor’. This is again expected since the average spacing in time between N particles in a bunch of duration Δt is of the order of $\delta t \sim (\Delta t)/N$. To discriminate each particle in time, we have to have a time resolution of at most $\tau_0 \sim \delta t \sim (\Delta t)/N$. The bandwidth sufficient for this is $W_0 \sim (\tau_0)^{-1} = N/\Delta t = N(T_0/\Delta t)(1/T_0) = (NB)f_0$. The number of revolution harmonics needed within the bandwidth in order to recover the complete information in the fluctuation signal of a bunched beam is thus enhanced over that required for a ring-filling continuous beam by the bunching factor B and is given by (NB) . Note that this merely increases the effective bandwidth, necessary for complete knowledge of the signal from bunched beams, by the bunching factor B . The number of independent revolution bands is still N , but now they have to be spaced by $Bf_0 = f_B$ in frequency. The number of DOF of a bunched beam fluctuation signal processed with a bandwidth $W < W_0 = (NB)f_0$ is thus suppressed by the bunching factor B , as in Eq. (4.1), compared with the DOF of a ring-filling continuous beam signal processed by the same bandwidth W . Equivalently, we can always compare a bunched beam with an equivalent coasting beam containing an enhanced effective number of particles $N_{\text{eff}} = (NB)$, when processed by the same continuous bandwidth W .

The above considerations are manifest in the fluctuation signal power at the PU as well²⁸⁾. The average signal power in a time interval T_0 is given by the sum of signal powers in the individual orthogonal components, orthogonal over the interval T_0 . Let us for the moment consider the transverse betatron fluctuation signals. For a broad-band PU with bandwidth $W \gg f_B$, there are $(2W/f_0)$ betatron bands, and the *average* Schottky signal power of transverse dipole current signal over a full revolution period T_0 is just the sum of the individual powers per band and is given by [see Eq. (3.115)]:

$$\left(P_W \right)_{\text{av}} = \frac{2W}{f_0} \left\langle \left| d_{n \pm Q} \right|^2 \right\rangle = \frac{2W}{f_0} \frac{N}{2} (qf_0)^2 \langle A^2 \rangle \quad . \quad (4.2)$$

This average power corresponds to the d.c. power of a continuous coasting beam signal which is distributed uniformly in time, with the peak power being the same as the average power. For a bunched beam, however, all this power is concentrated in only a time interval of bunch duration $\Delta t \ll T_0$ since we are considering the PU rise-time to be much shorter than the bunch duration Δt [$W \gg (1/\Delta t) = f_B$, i.e. $\tau_r = 1/W \ll \Delta t$]. The *peak pulsed power* is enhanced over the *average power* by the bunching factor $B = T_0/\Delta t = 1/(f_0\Delta t)$, so that for a bunched beam

$$\hat{P}_W = \left(P_W \right)_{\text{peak}} = B \left(P_W \right)_{\text{av}} = Nq^2 \langle A^2 \rangle W f_B . \quad (4.3)$$

It can be verified that this is the same as what would be obtained by summing the individual powers of orthogonal components (over the interval Δt) spaced by f_B in frequency. (Note that these orthogonal components would be enhanced by a factor B , and their powers by a factor B^2 , when evaluated over an interval Δt rather than T_0 , and their number would be reduced by B for the same bandwidth W so that peak power or average power over Δt would be enhanced by $B^2(1/B) = B$.) In the frequency domain, all the betatron bands within an interval f_B are strongly correlated and add up coherently rather than incoherently in mean square for the peak power. However, bands separated by f_B or more than f_B , add up incoherently and the situation is similar to that of a continuous coasting beam. This is illustrated in Figs. 17a and 17b.

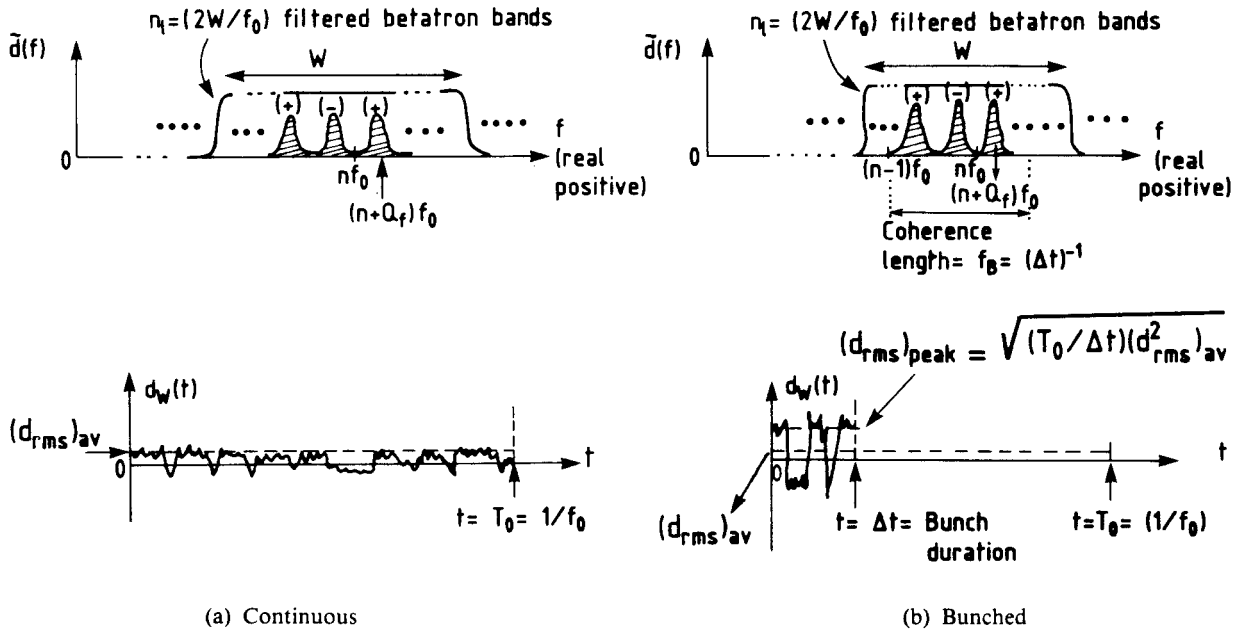

Fig. 17 Fluctuation signals of continuous and bunched beams processed by a wide-band PU with bandwidth $W \gg f_B$

If the PU rise-time is much longer than the bunch duration Δt (narrow-band PU with bandwidth much less than the bunch frequency, $f_0 \ll W \ll f_B = 1/\Delta t$), the peak power from $n_\ell/2$ coherent (+) betatron bands and $n_\ell/2$ coherent (-) betatron bands is

$$\hat{P}_W = 2P_{(n\pm Q)} \left(\frac{n_\ell}{2} \right)^2 = \left(P_W \right)_{\text{av}} \frac{n_\ell}{2} = \left(P_W \right)_{\text{av}} \frac{T_0}{(\Delta t)_W} = \frac{N}{2} (qf_0)^2 \langle A^2 \rangle \frac{n_\ell^2}{2} , \quad (4.4)$$

where $(\Delta t)_w = 1/W$ is the effective bunch length in time as seen by the PU. For a set of M such identical PUs as above, but centred on frequencies spaced by the bunch frequency f_B (Fig. 18), the peak power is given by

$$\hat{P}_W = P_{(n \pm Q)} \frac{n_\ell^2}{2} M = \left(P_W \right)_{av} \frac{n_\ell}{2} M = \frac{N}{2} (q f_0)^2 \langle A^2 \rangle \frac{n_\ell^2}{2} M \quad (4.5)$$

This peak power can be interpreted as the average power of an equivalent continuous coasting beam with an effective number of particles $(N_{eff})_w = N(n_\ell/2) = N[T_0/(\Delta t)_w]$. For $W \gg f_B$, we have $(\Delta t)_w = \Delta t$ and $N_{eff} = NB$, and for $W \approx f_0$, $(\Delta t)_w = T_0$ and $N_{eff} = N$.

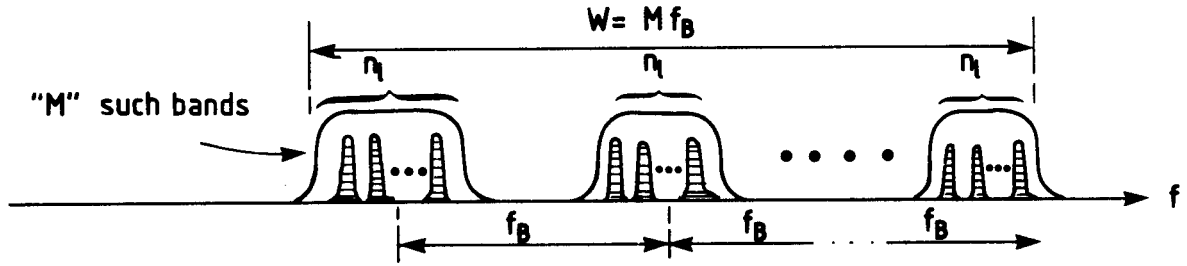

Fig. 18 Fluctuation signals processed by M identical narrow-band PUs with bandwidth $\ll f_B$ and centred at frequencies f_B apart

All the above considerations of the distinctive features of bunched beam fluctuation signals compared with those of continuous beams, from the point of view of information content, correlation between frequency lines, and fluctuation power, would play crucial roles in Schottky fluctuation signal processing schemes relevant for any feasible phase-space stochastic cooling scenario of bunched beams²⁸⁾.

It is important to observe, however, that the above considerations for single bunches have to be suitably modified if the storage ring is filled with many, many bunches. The necessary modifications are all too apparent from considerations of frequency space correlations described before. In the limit of a storage ring completely filled with bunches (every bucket completely full), we again need all the successive revolution bands as orthogonal components in order to obtain maximum non-redundant information about all the bunches in the storage ring.

5. COHERENT BEAM RESPONSE: CONCEPTS

The coherent response of charged-particle beams in storage rings to small electromagnetic perturbations contains essential information about the single-particle and collective dynamical properties of the beam. In the absence of interparticle interactions, the collective response of the beam is simply obtained by an appropriate summation over the single-particle dynamics, represented by a collection of non-interacting three-dimensional oscillators circulating in the storage ring, with oscillation frequencies and orbits determined by the focusing electromagnetic fields of the storage ring lattice. Interparticle interactions, induced either naturally by electromagnetic forces between charged particles in an intense beam and electromagnetic interaction of the beam with the environment, which acts as a passive feedback on the beam (e.g. space charge, external impedances, etc.), or by active feedback loops (e.g. a stochastic cooling loop), always generate additional collective properties. The beam response thus gets modified and includes the causal transfer function (Green's function) of the relevant collective interaction, in addition to the single-particle dynamics summed over the beam distribution.

Moreover, discrete single-particle effects are often influenced significantly by collective interactions. It is well known^{29, 30}, for example, that reactive impedances in the beam-wall system produce finite shifts in single-particle incoherent frequencies. Similarly, we will see in Section 11 how the spectral properties of incoherent and finite observable microscopic phase-space fluctuations (the Schottky fluctuations studied before) are modified when interparticle interactions or correlations are introduced.

In all the above instances, knowledge of the response properties of the beam is crucial for estimating the appropriate collective effect, be it the growth rate of a collective mode or the distortion of fluctuation signals, etc. The response contains critical information about such aspects as Landau damping and wave regeneration properties of the charged-particle beam as a many-body system, to be introduced later. The coherent beam transfer function measurement is thus an important diagnostic tool also for estimating single-particle and collective effects, since it contains information about the beam-storage-ring impedance (Fourier transform in frequency of the Green's function for collective interaction between the beam and the storage-ring elements; see Section 8 for definition), the beam phase-space distribution, and the incoherent and coherent frequencies of the whole system, when analysed in the frequency domain.

A typical layout for the beam response or transfer function measurement is shown in Fig. 19. Small-amplitude perturbing signals applied at point B excite the appropriate kicker K (transverse,

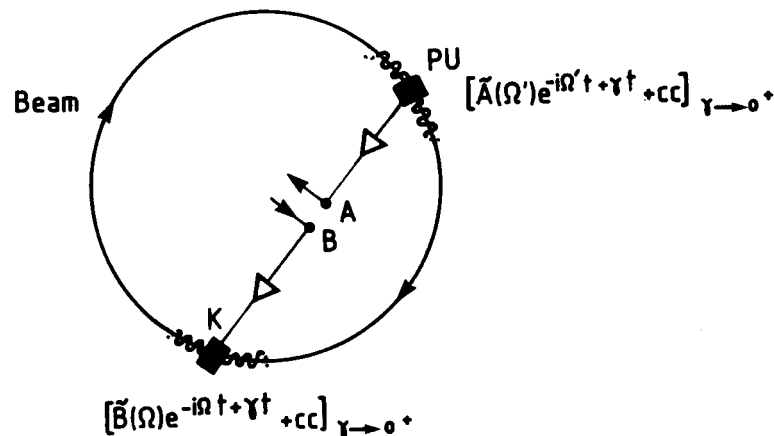

Fig. 19 A typical layout for beam response or BTF measurement

longitudinal, or both) and the beam. The kicker fields introduce modulations in the beam, thus creating correlations between particles. These correlations or modulations are then propagated coherently by the beam (through the collective motion of the particles described by the beam transfer function) back to the PU. The resulting PU signals are then carried back to point A. A network analyser then measures the amplitude and phase transmission from B to A. Such a beam transfer function (BTF) measurement, performed over a band of frequencies, is extremely useful since it contains information about the whole system, including its stability and phase delay properties over the band. In our transfer function we have included the extra electrical paths B-K and PU-A, which may contain electrical elements — amplifiers, filters, and cables or other (optical, microwave, etc.) transmission lines — in order to take into account situations such as stochastic cooling where points A and B coincide and are electrically connected in the closed-loop cooling mode^{20, 31}). Opening the loop, thus separating A and B slightly, then allows us to measure the open-loop transfer function for a stochastic cooling system, which again contains the whole story since the cooling feedback loop elements between PU and K are automatically included in the beam response. However, when switching and balancing cables, care must be taken to make A and B effectively in the same place.

For time-translation invariant systems (such as continuous coasting beams), excitation by a fixed frequency Ω at the kicker generates, in the linear approximation, a response at the PU at the same frequency $\Omega' = \Omega$ only, and at no others. Repeating the measurement to excitations at other frequencies over the bandwidth of interest (either by single frequency sweep generators or by finite bandwidth noise generators) reveals the complete story about the amplitude and phase response, indicating possible delay and stability properties. In general, for high frequencies where revolution bands of the beam overlap, $\ell\Delta\omega > \omega_0$, perturbation at a fixed frequency Ω will excite a large number of azimuthal harmonics $\{\ell\}$ in the beam; for example, $\Omega = \ell\omega(p) = \ell'\omega(p') = \dots$ for the longitudinal response where $\omega(p) = \omega_0 + \Delta\omega(p) = \omega_0 - \eta\Delta p(\omega_0/p_0)$ describes the angular frequency dispersion in the continuous beam with a distribution of momentum offset Δp , and determined by the machine off-energy function η . The response function then contains an intrinsic sum over all these excited harmonics $\{\ell\}$. Response at a given beam harmonic ℓ is then experimentally a moot concept, since it can never be observed isolated by a PU, although it exists theoretically. Rather, we should always refer to response at a given electrical frequency Ω . At low frequency however, where revolution bands are separated and non-overlapping, $\ell\Delta\omega \leq \omega_0$, a fixed frequency Ω will only excite a single harmonic in the beam significantly, namely the harmonic satisfying the resonance condition $\Omega = \ell\omega(p)$. For non-overlapping bands, such a condition is satisfied by only one value of ℓ . We can then speak of observable response at a given harmonic ℓ . The same is true for transverse response functions, where the sense or nonsense of the concept of observable response at a given betatron harmonic $(\ell \pm Q_f)f_0$ depends on whether the betatron bands overlap or not at the frequency of interest. For beams that are not invariant under time translations, perturbation at a frequency Ω will in general excite other frequencies Ω' also, including $\Omega' = \Omega$. For example, the response of bunched beams is periodically non-stationary, i.e. it is invariant not with respect to arbitrary time translations but with respect to translations by a multiple k of the nominal revolution period $T_0 = 1/f_0 = 2\pi/\omega_0$ only, where $k = 0, \pm 1, \pm 2, \dots$. An exciting frequency Ω at K will then generate excited frequencies at all the revolution-frequency translates of the beam: $\Omega' = \Omega + k\omega_0$, $k = 0, \pm 1, \pm 2, \dots$. The response function, then, is not given by a single complex function at a given Ω , but by a matrix of complex functions, each element connecting response near harmonic $\{\ell\}$ to an excitation near harmonic $\{m\}$. The analysis

and measurement of the BTF of bunched beams are thus complicated and subtle compared to those for continuous beams.

We are interested in the response of some physical observable \vec{A} of the beam due to perturbation in some other physically inducible variable \vec{B} . The variables \vec{A} and \vec{B} may in general be vector quantities with components related to the two transverse dimensions and one longitudinal dimension of the beam. For example, \vec{B} may be the transverse electric field excitation \vec{E} or angular kick $\vec{\alpha}$ induced by the kicker, and \vec{A} the resulting transverse dipole-moment current modulation \vec{d} at the PU. Alternatively, \vec{B} may be the longitudinal voltage modulation $V(t|\theta_K)$ at K, and \vec{A} the resulting longitudinal current modulation $I(t|\theta_P)$ at the PU. In the general case they may include both, which means that they are true three-component vectors \vec{A} and \vec{B} . The response will usually be of the form

$$\vec{A} = \hat{\mathcal{J}}_{AB} \vec{B} + \mathcal{O}(|\vec{B}|^2) + \dots \quad (5.1)$$

For small excitation or perturbation signals \vec{B} applied to the beam, we are interested in the linear response only and will neglect the terms of order $|\vec{B}|^2$ and higher. In the time domain, the response matrix or tensor $\hat{\mathcal{J}}_{AB}$ is simply a linear integral operator:

$$\vec{A}(t|\theta_P) = \int_{-\infty}^t dt' \mathcal{J}_{AB}(t, t'|\theta_P, \theta_K) \vec{B}(t'|\theta_K) \quad (5.2)$$

In asserting such a representation for the response, we are assuming that the system is stable against the disturbance $\vec{B}(t|\theta_K)$ and that the strength of the disturbance is sufficiently weak so that the induced quantity \vec{A} may be represented by that part of the response which is linear in the disturbing field \vec{B} , thus guaranteeing the validity of the superposition principle embodied in Eq. (5.2). Such a representation then assumes the existence of a Green's function $\mathcal{J}_{AB}(t, t'|\theta_P, \theta_K)$ in the beam-storage-ring system, describing the propagation characteristics of a disturbance in \vec{B} applied at (θ_K, t') and observed at (θ_P, t) as an induced observable \vec{A} . [Note: The existence of such a Green's function for the linear response is characteristic of systems satisfying finite-order linear differential equations in the response variable, with the excitation as the source term.] We are also assuming that the response is 'causal'. This 'causality' is reflected in the choice of the domain $(-\infty, t)$ for the range of t' -integration in Eq. (5.2). Starting from an undisturbed state at $t = -\infty$, the quantity \vec{A} is gradually induced in the beam owing to the application of the perturbation \vec{B} : the effect $\vec{A}(t|\theta_P)$ cannot precede the cause $\vec{B}(t'|\theta_K)$; $\mathcal{J}_{AB}(t, t'|\theta_P, \theta_K)$ is zero for $t < t'$ and describes the causal BTF in the time domain. This BTF or response function, as long as it represents a linear response relation as in Eq. (5.2), is determined solely by the properties of the beam-storage-ring system in the absence of the perturbation \vec{B} , i.e. by the zeroth-order unperturbed trajectories and distribution of the particles in the beam. In Section 6, while computing the BTF from microscopic kinetic theory, we will observe that such a linear response relationship as that described above does indeed provide a valid description of the response properties of the beam-storage-ring system.

Some amount of care is now necessary in order to obtain the response in the frequency domain. In general, the response is an integral operator in the frequency domain also, as can be seen by Fourier transformation of Eq. (5.2) to the frequency space:

$$\begin{aligned}
\tilde{\tilde{A}}(\Omega|\theta_P) &= \frac{1}{2\pi} \int_{-\infty}^{+\infty} d\Omega' \tilde{\mathcal{J}}_{AB}(\Omega, \Omega' | \theta_P, \theta_K) \tilde{\tilde{B}}(\Omega' | \theta_K) , \\
&= \frac{1}{2\pi} \int_{-\infty}^{+\infty} d\Omega' \tilde{\mathcal{R}}_{AB}(\Omega - \Omega', \Omega' | \theta_P, \theta_K) \tilde{\tilde{B}}(\Omega' | \theta_K) ,
\end{aligned} \tag{5.3}$$

where we have introduced an equivalent response function \mathcal{R}_{AB} , defined in the time domain as

$$\mathcal{R}_{AB}(t, \tau | \theta_P, \theta_K) = \mathcal{R}_{AB}(t, t-t' | \theta_P, \theta_K) \equiv \mathcal{J}_{AB}(t, t' | \theta_P, \theta_K) , \quad \tau = (t-t') . \tag{5.4}$$

In Eq. (5.3), $\tilde{\mathcal{J}}_{AB}(\Omega, \Omega' | \theta_P, \theta_K)$ and equivalently $\tilde{\mathcal{R}}_{AB}(\Omega - \Omega', \Omega' | \theta_P, \theta_K)$ describe the bi-frequency representation of the time-dependent response or transfer function and are given by

$$\tilde{\mathcal{J}}_{AB}(\Omega, \Omega' | \theta_P, \theta_K) = \int_{-\infty}^{+\infty} dt \int_{-\infty}^t dt' \mathcal{J}_{AB}(t, t' | \theta_P, \theta_K) e^{i\Omega t - i\Omega' t'} , \tag{5.5}$$

$$\tilde{\mathcal{R}}_{AB}(\Omega - \Omega', \Omega' | \theta_P, \theta_K) = \int_{-\infty}^{+\infty} dt \int_0^{+\infty} d\tau \mathcal{R}_{AB}(t, \tau | \theta_P, \theta_K) e^{i(\Omega - \Omega')t} e^{i\Omega' \tau} . \tag{5.6}$$

For continuous ring-filling coasting beams, the response is expected to be invariant under arbitrary time translations. Thus $\mathcal{J}_{AB}(t, t' | \theta_P, \theta_K) \equiv \mathcal{R}_{AB}(t, t-t' | \theta_P, \theta_K)$ can only depend on the age variable $\tau = (t-t')$ so that

$$\tilde{\mathcal{R}}_{AB}(\Omega - \Omega', \Omega' | \theta_P, \theta_K) = 2\pi \tilde{\mathcal{R}}_{AB}(\Omega' | \theta_P, \theta_K) \delta(\Omega - \Omega') , \tag{5.7}$$

and the response is described by a single-frequency complex transfer function $\tilde{\mathcal{R}}_{AB}(\Omega | \theta_P, \theta_K)$ as follows:

$$\tilde{\tilde{A}}(\Omega | \theta_P) = \tilde{\mathcal{R}}_{AB}(\Omega | \theta_P, \theta_K) \tilde{\tilde{B}}(\Omega | \theta_K) , \tag{5.8}$$

where

$$\tilde{\mathcal{R}}_{AB}(\Omega | \theta_P, \theta_K) = \int_0^{+\infty} d\tau \mathcal{R}_{AB}(\tau | \theta_P, \theta_K) e^{i\Omega \tau} . \tag{5.9}$$

The time integral in Eq. (5.2) is a pure convolution in this case, allowing the single-frequency Fourier transform relation as in Eq. (5.8). For continuous coasting beams, we may thus represent the beam-storage-ring system in the block diagrammatic convention of Fig. 20 as a time-invariant linear lumped system with transfer function $\tilde{\mathcal{R}}_{AB}(\Omega | \theta_P, \theta_K)$, as far as coherent response properties are concerned.

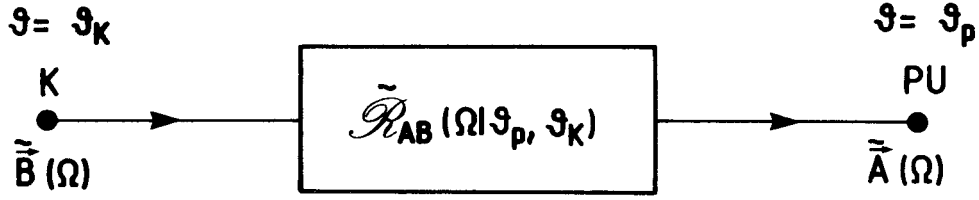

Fig. 20 Coherent BTF of a continuous beam represented as a time-invariant linear lumped system

We note that in Eq. (5.9), $\tilde{\mathcal{R}}_{AB}(\Omega|\theta_P, \theta_K)$ has been defined in terms of a one-sided Fourier transformation with respect to time. This is a consequence of the ‘causality’ inherent in Eq. (5.2), i.e. $\mathcal{R}_{AB}(\tau|\theta_P, \theta_K) = 0$ for $\tau < 0$. Formally the range of integration can be extended to $-\infty$ at the lower limit, remembering however that we have to invoke this causality as a crucial element in any practical computation of the response in the frequency domain for any physical system such as the beam-storage-ring complex.

It follows immediately, from the reality of $\tilde{B}(t|\theta_K)$, $\tilde{A}(t|\theta_P)$, and $\mathcal{R}_{AB}(\tau|\theta_P, \theta_K)$, that

$$\begin{aligned}\tilde{B}(\Omega|\theta_K) &= \tilde{B}^*(-\Omega|\theta_K) \\ \tilde{A}(\Omega|\theta_P) &= \tilde{A}^*(-\Omega|\theta_P) \\ \tilde{\mathcal{R}}_{AB}(\Omega|\theta_P, \theta_K) &= \tilde{\mathcal{R}}_{AB}^*(-\Omega|\theta_P, \theta_K)\end{aligned}\quad (5.10)$$

for real frequencies Ω . From the definition (5.9), it also follows that $\tilde{\mathcal{R}}_{AB}(\Omega|\theta_P, \theta_K)$, considered for complex values of Ω , is analytic on the upper half-plane $\text{Im } \Omega > 0$ of complex Ω [assuming that $\mathcal{R}_{AB}(\tau|\theta_P, \theta_K)$ is finite for all τ] and

$$\tilde{\mathcal{R}}_{AB}^*(\Omega|\theta_P, \theta_K) = \tilde{\mathcal{R}}_{AB}(-\Omega^*|\theta_P, \theta_K) \quad (5.11)$$

A positive imaginary part of Ω may be sufficient to guarantee convergence of the integration in Eq. (5.9); $\tilde{\mathcal{R}}_{AB}(\Omega|\theta_P, \theta_K)$ can then be continued analytically into the lower half of the complex Ω -plane with $\text{Im } \Omega \leq 0$. There the analytically continued $\tilde{\mathcal{R}}_{AB}(\Omega|\theta_P, \theta_K)$ generally has singularities, such as poles. Inverse transformation of Eq. (5.9) can be carried out according to

$$\mathcal{R}_{AB}(\tau|\theta_P, \theta_K) = \frac{1}{2\pi} \int_C d\Omega e^{-i\Omega\tau} \tilde{\mathcal{R}}_{AB}(\Omega|\theta_P, \theta_K) \quad , \quad (5.12)$$

where the contour C extends from $-\infty$ to $+\infty$ along a path in the upper half of the complex Ω -plane in such a way as to see the singularities of $\tilde{\mathcal{R}}_{AB}(\Omega|\theta_P, \theta_K)$ in the region $\text{Im } \Omega \leq 0$ from above (see Fig. 21a). For $\tau > 0$, we can close the contour with an infinite semicircle in the lower half-plane [the contribution from the semicircle vanishes by virtue of the exponential in Eq. (5.12)]. Cauchy’s theorem may then be used for the inverse transformation (5.12), yielding finite non-zero $\mathcal{R}_{AB}(\tau|\theta_P, \theta_K)$ for $\tau > 0$, given by the contribution from the residues of $\tilde{\mathcal{R}}_{AB}(\Omega|\theta_P, \theta_K)$ at the singularities in this lower half-plane of complex Ω . For $\tau < 0$, we can close the contour with

an infinite semicircle in the upper half-plane. Since there are no singularities for $\text{Im } \Omega > 0$ in $\tilde{\mathcal{R}}_{AB}(\Omega|\theta_P, \theta_K)$, we have

$$\tilde{\mathcal{R}}_{AB}(\tau|\theta_P, \theta_K) = 0 \quad \text{for } \tau < 0 \quad , \quad (5.13)$$

as expected for a causal response.

We thus observe that causality (and convergence) demands that the frequency Ω be considered to have at least a small positive imaginary part $i\gamma$, $\gamma \rightarrow 0^+$, in order for the direct and inverse transformations (5.9) and (5.12) to guarantee the proper analytic structure in the frequency space and proper causal structure in real time for the physical response. The presence of this small imaginary part $i\gamma$ in Ω can be understood physically by imagining the perturbation $\vec{B}(t|\theta_K)$ at frequency Ω to have been adiabatically turned on from the infinite past, where the perturbation was zero. We thus take for the applied perturbation

$$\vec{B}(t|\theta_K) = \lim_{\gamma \rightarrow 0^+} [\tilde{B}(\Omega|\theta_K) e^{-i\Omega t + \gamma t} + \text{cc}] \quad , \quad (5.14)$$

so that

$$\lim_{t \rightarrow -\infty} \vec{B}(t|\theta_K) = 0 \quad . \quad (5.15)$$

This is quite physical since the existence of a constant amplitude, single-frequency, sinusoidal perturbation for all time from the infinite past is rather unrealistic and we have to allow for 'switching on' processes in order to avoid this artificial circumstance. The induced modulation in the observable $\vec{A}(t|\theta_P)$ may also be taken in the same form:

$$\vec{A}(t|\theta_P) = \lim_{\gamma \rightarrow 0^+} [\tilde{A}(\Omega|\theta_P) e^{-i\Omega t + \gamma t} + \text{cc}] \quad , \quad (5.16)$$

with

$$\lim_{t \rightarrow -\infty} \vec{A}(t|\theta_P) = 0 \quad . \quad (5.17)$$

The response in the time domain may then be written as

$$\tilde{A}(\Omega|\theta_P) e^{-i\Omega t + \gamma t} = \int_{-\infty}^t dt' \mathcal{R}_{AB}(t-t'|\theta_P, \theta_K) \tilde{B}(\Omega|\theta_K) e^{-i\Omega t' + \gamma t'} \quad , \quad (5.18)$$

so that the frequency response may be written

$$\tilde{\mathcal{R}}_{AB}(\Omega|\theta_P, \theta_K) = \lim_{\gamma \rightarrow 0^+} \int_0^{\infty} d\tau \mathcal{R}_{AB}(\tau|\theta_P, \theta_K) e^{i(\Omega + i\gamma)\tau} \quad . \quad (5.19)$$

This artificial introduction of the small imaginary term $i\gamma$ in the frequency response can, however, be best avoided by appealing to the Laplace transform, which establishes its presence rigorously. By now it is evident from the above description that this one-sided Fourier transform

of the causal response function given by Eq. (5.19) is nothing but equivalent to a Laplace transform. Physically the form of the response function $\mathcal{R}_{AB}(\tau|\theta_P, \theta_K)$ calculated by any method is valid for $\tau \geq 0$ only and cannot be arbitrarily extended to $\tau < 0$ by continuation. The response is zero for $\tau < 0$ by definition, as demanded by causality. Thus Laplace transformation provides the only natural mathematically justifiable transform of the causal response function. If we consider the physical externally applied excitation to have a definite beginning at $t = 0$ say, so that $\vec{B}(t|\theta_K) = 0$ for $t < 0$, the direct transformation to the Laplace variable s -domain and the inverse transformation back to the time domain are given by

$$\vec{B}(s|\theta_K) = \int_0^{\infty} dt e^{-st} \vec{B}(t|\theta_K) \quad , \quad (5.20)$$

and

$$\vec{B}(t|\theta_K) = \frac{1}{2\pi i} \int_C ds e^{st} \vec{B}(s|\theta_K) \quad . \quad (5.21)$$

In Eq. (5.21), the contour C is a vertical line in the complex s -plane with $\text{Re } C > 0$ and to the right of the singularities of $\vec{B}(s|\theta_K)$. In Eq. (5.20), we take $\text{Re } s > 0$, with $\text{Re } s$ large enough so that the integral converges. We are thus assuming that $\vec{B}(t|\theta_K)$ is a given function that has a Laplace transform so that $\vec{B}(s|\theta_K)$ exists and is given, at least for all s having the real part sufficiently positive. The response $\vec{A}(t|\theta_P)$ then has also a definite beginning at $t = 0$ and $\vec{A}(t|\theta_P) = 0$ for $t < 0$. Its Laplace transform in the s -domain, for a time-invariant response characterized by $\mathcal{R}_{AB}(\tau|\theta_P, \theta_K)$ for continuous beams, is related algebraically to $\vec{B}(s|\theta_K)$ as follows:

$$\vec{A}(s|\theta_P) = \tilde{\mathcal{R}}_{AB}(s|\theta_P, \theta_K) \vec{B}(s|\theta_K) \quad , \quad (5.22)$$

where

$$\tilde{\mathcal{R}}_{AB}(s|\theta_P, \theta_K) = \int_0^{\infty} d\tau e^{-s\tau} \mathcal{R}_{AB}(\tau|\theta_P, \theta_K) \quad (5.23)$$

with the inverse

$$\mathcal{R}_{AB}(\tau|\theta_P, \theta_K) = \frac{1}{2\pi i} \int_C ds e^{s\tau} \tilde{\mathcal{R}}_{AB}(s|\theta_P, \theta_K) \quad . \quad (5.24)$$

Typically, a vanishingly small and positive real part of s , $\text{Re } s = \gamma \rightarrow 0^+$, is sufficient for the convergence of Eq. (5.23) and hence for the availability of a Bromwich contour C in the complex s -plane for the subsequent inversion in Eq. (5.24). Closing the contour with an infinite semicircle on the right half of the s -plane for $\tau < 0$ and on the left half of the s -plane for $\tau > 0$ as before, reproduces the proper causal time structure of $\mathcal{R}_{AB}(\tau|\theta_P, \theta_K)$ as calculated from Eq. (5.24). Thus defined, the Laplace transform is unambiguous and takes explicit account of the initial conditions and causal boundary conditions in time for the response variables and the response function in the integral equation (5.2) for linear response (an integral equation is frequently equivalent to a

differential equation with initial and boundary conditions, which are well known to be specially conducive to treatments via Laplace transforms). It is then possible to interpret Eq. (5.23) as the response at a given frequency Ω by letting $s = -i\Omega + \gamma$, with $\gamma \rightarrow 0^+$, a vanishingly small positive number. Then the single-frequency response at a real frequency Ω may be written as:

$$\begin{aligned} \tilde{\mathcal{R}}_{AB}(\Omega | \theta_P, \theta_K) &= \lim_{\gamma \rightarrow 0^+} \tilde{\mathcal{R}}_{AB}(s | \theta_P, \theta_K) \Big|_{s=-i\Omega+\gamma} \\ &= \lim_{\gamma \rightarrow 0^+} \int_0^{\infty} d\tau e^{(i\Omega-\gamma)\tau} \mathcal{R}_{AB}(\tau | \theta_P, \theta_K) \quad , \end{aligned} \quad (5.25)$$

identical to the one obtained in Eq. (5.19). The integration contour C for the inverse transformation and a possible singularity structure in the frequency Ω - and Laplace variable s -domains of the analytic beam response are shown in Fig. 21.

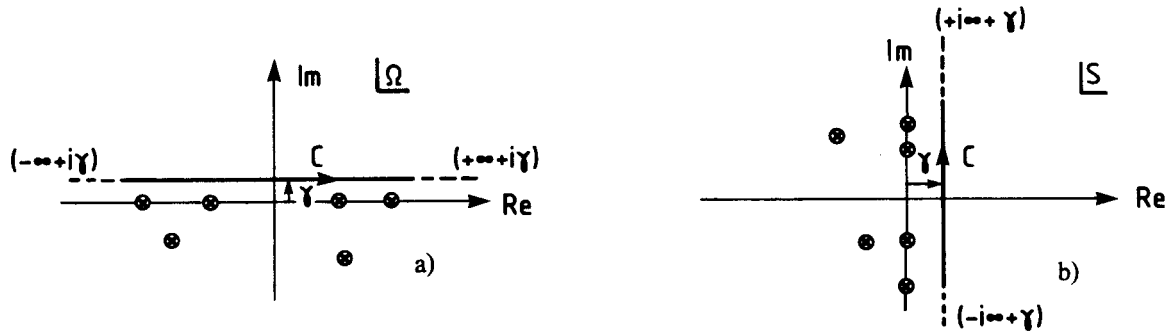

Fig. 21 Integration contour for the inverse transformation and singularity structure in the frequency and Laplace variable domains of the analytic beam response

We note that

$$\lim_{\gamma \rightarrow 0^+} \int_{-\infty}^{+\infty} d\Omega' \frac{\tilde{\mathcal{R}}_{AB}(\Omega' | \theta_P, \theta_K)}{[\Omega' - \Omega + i\gamma]} = 0 \quad . \quad (5.26)$$

We can prove this identity by closing the contour with an infinite semicircle in the upper half-plane and then by using Cauchy's theorem for integration (Fig. 22a). The contribution from the semicircle vanishes with the assumption that for physical responses $\tilde{\mathcal{R}}_{AB}(\Omega' | \theta_P, \theta_K)$ vanishes rapidly enough at infinity, $|\Omega'| \rightarrow \infty$, in the upper half-plane. The integration around the closed contour then vanishes since $\tilde{\mathcal{R}}_{AB}(\Omega | \theta_P, \theta_K)$ is analytic and free of singularities in the upper half-plane and the point $\Omega' = \Omega$ lies outside the contour from $(-\infty + i\gamma)$ to $(+\infty + i\gamma)$, or equivalently the point $\Omega' = \Omega - i\gamma$ lies outside the contour along the real axis from $-\infty$ to $+\infty$. When considering the response at a real Ω , the $i\gamma$ in the above denominator simply serves as a mnemonic for the distortion of the contour C along the real axis via a infinitesimal semicircular detour above the point $\Omega' = \Omega$, as shown in Fig. 22b.

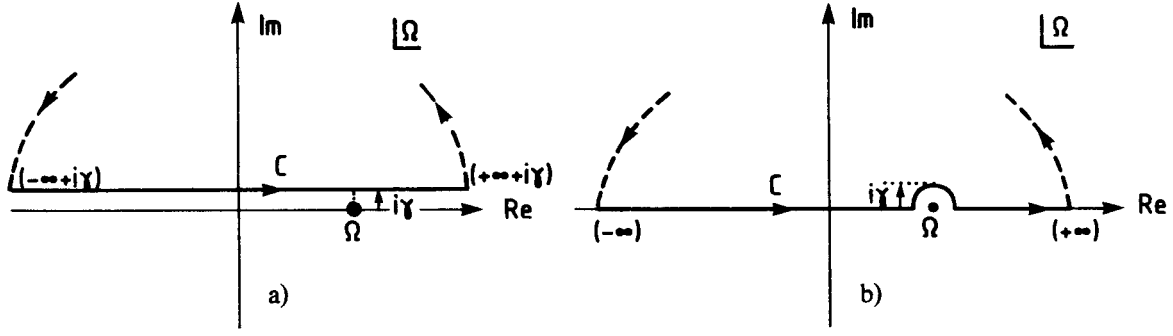

Fig. 22 Integration contours for the identity (5.26)

With the aid of the Dirac identities

$$\lim_{\gamma \rightarrow 0^+} \frac{1}{[x \pm i\gamma]} = \mathcal{P} \left(\frac{1}{x} \right) \mp i\pi\delta(x) \quad , \quad (5.27)$$

where \mathcal{P} stands for the principal value part, we may now split Eq. (5.26) into real and imaginary parts to obtain

$$\begin{aligned} \text{Im} [\tilde{\mathcal{R}}_{AB}(\Omega | \theta_P, \theta_K)] &= \frac{1}{\pi} \int_{-\infty}^{+\infty} d\Omega' \mathcal{P} \frac{\text{Re} [\tilde{\mathcal{R}}_{AB}(\Omega' | \theta_P, \theta_K)]}{[\Omega - \Omega']} \\ &= \frac{2}{\pi} \int_0^{\infty} d\Omega' \frac{\Omega}{[\Omega^2 - \Omega'^2]} \text{Re} [\tilde{\mathcal{R}}_{AB}(\Omega' | \theta_P, \theta_K)] \quad , \end{aligned} \quad (5.28)$$

and

$$\begin{aligned} \text{Re} [\tilde{\mathcal{R}}_{AB}(\Omega | \theta_P, \theta_K)] &= \frac{1}{\pi} \int_{-\infty}^{+\infty} d\Omega' \mathcal{P} \frac{\text{Im} [\tilde{\mathcal{R}}_{AB}(\Omega' | \theta_P, \theta_K)]}{[\Omega' - \Omega]} \\ &= \frac{2}{\pi} \int_0^{\infty} d\Omega' \frac{\Omega'}{[\Omega'^2 - \Omega^2]} \text{Im} [\tilde{\mathcal{R}}_{AB}(\Omega' | \theta_P, \theta_K)] \quad . \end{aligned} \quad (5.29)$$

These relations are the relevant Kramers-Kronig relations for the analytic beam response. Thus the real and imaginary parts of the BTF are not independent of each other, and a knowledge of one implies a knowledge of the other, and hence the full complex and analytic BTF, by

$$\tilde{\mathcal{R}}_{AB}(\Omega | \theta_P, \theta_K) = \frac{i}{\pi} \lim_{\gamma \rightarrow 0^+} \int d\Omega' \frac{\text{Re} [\tilde{\mathcal{R}}_{AB}(\Omega' | \theta_P, \theta_K)]}{[\Omega - \Omega' + i\gamma]} \quad (5.30)$$

$$= \frac{1}{\pi} \lim_{\gamma \rightarrow 0^+} \int d\Omega' \frac{\text{Im} [\tilde{\mathcal{R}}_{AB}(\Omega' | \theta_P, \theta_K)]}{[\Omega' - \Omega + i\gamma]} \quad . \quad (5.31)$$

We note that the positive infinitesimal γ that serves to assure the adiabatic turning on of the disturbance and thereby to guarantee a causal response of the system, also produces real and imaginary parts in the beam response. Depending on the definition, these real and imaginary parts of the beam response for $\theta_P = \theta_K$ are interchangeably related to the energy absorbing (i.e. dissipative) and reactive (i.e. oscillatory) parts of the collective dynamics of the whole beam, as we will soon see. We will also see later (Section 13) that the presence of γ is related to the important phenomenon of ‘Landau damping’.

As we have already mentioned in Section 2, each particle in a storage ring behaves as a circulating loss-less three-dimensional oscillator, with amplitude- or action-dependent oscillation frequencies $\vec{\omega}(\vec{I})$. The response of an individual oscillator will have the typical resonant character as the frequency Ω of the external perturbation approaches one of the resonance values $\Omega \rightarrow \vec{n} \cdot \vec{\omega}(\vec{I})$, where $\vec{n} \equiv (n_x, n_z, n)$ is a triplet of integers. Specifically, the response near $\Omega = \vec{n} \cdot \vec{\omega}(\vec{I})$ will have the singular resonant denominator $[\Omega - \vec{n} \cdot \vec{\omega}(\vec{I})]^{-1}$. The response of the whole beam is obtained by summing over all the individual oscillators (particles) in the beam and, as we will see in Sections 6 and 7, will have typically the form of

$$\tilde{\mathcal{R}}(\Omega | \theta_P, \theta_K) \sim \sum_{\vec{n}} \int d\vec{I} \frac{F_{\vec{n}}^{\text{PK}}(\vec{I})}{[\Omega - \vec{n} \cdot \vec{\omega}(\vec{I})]} , \quad (5.32)$$

where $F_{\vec{n}}^{\text{PK}}(\vec{I})$ are certain form factors related to the beam distribution $\Psi_0(\vec{I})$, oscillator strengths for oscillators with action \vec{I} to couple to a wave $\exp(-i[\vec{n} \cdot \vec{\omega}(\vec{I})]t)$ of frequency $\vec{n} \cdot \vec{\omega}(\vec{I})$, etc. The poles on the real frequency axis arising from the whole beam of particles are shown in Fig. 23a. For longitudinal response, $\vec{n} \cdot \vec{\omega}(\vec{I}) \equiv n\omega(p)$ and for transverse linear betatron response $\vec{n} \cdot \vec{\omega}(\vec{I}) \equiv (n \pm Q_f)\omega(p)$. Physically, then, for a continuous distribution of particles in the space of revolution frequencies $\omega(p)$, only a vanishing number of oscillators, $dN = \Psi_0(\omega) d\omega \rightarrow 0$ as $d\omega \rightarrow 0$ have frequencies exactly coinciding with that of the excitation and contribute to the singularity from the denominator, which is thus no cause for grief. Mathematically, the small $i\gamma$ term in Ω then saves us from the divergent singular integral as $\vec{n} \cdot \vec{\omega} \rightarrow \Omega$ and clearly indicates how to compute or treat this integral. Computation should proceed with $\text{Im } \Omega = \gamma > 0$, and making use of the identity (5.27), which is equivalent to choosing a contour of integration in revolution frequencies of the oscillators such that it avoids $\vec{n} \cdot \vec{\omega} = \Omega$ by a small semicircular detour, as shown in Fig. 23b, for the longitudinal response. The response thus calculated can then be analytically continued into the lower half of the complex Ω -plane. In this way the physical principle of causality is automatically embedded in the computation of beam response. [Note: The multiple poles on the ω -axis in Fig. 23b occur only if the frequency Ω is situated in the region of overlapping poles in Fig. 23a. If Ω is in a region of non-overlapping poles in Fig. 23a, there is only one pole in Fig. 23b to be avoided by the contour.]

The frequency response of bunched beams is uniquely different and has additional structure aside from the above considerations of analytic structure in the complex frequency space. A bunched beam interacting with the K-PU elements in the BTF measurement set-up is essentially a ‘sampled’ system (in the closed-loop situation of stochastic cooling, when points A and B in Fig. 19 are electrically connected, it actually becomes a ‘sampled control system’) and is characterized by a non-stationary time-varying response. However, the time variation is periodic,

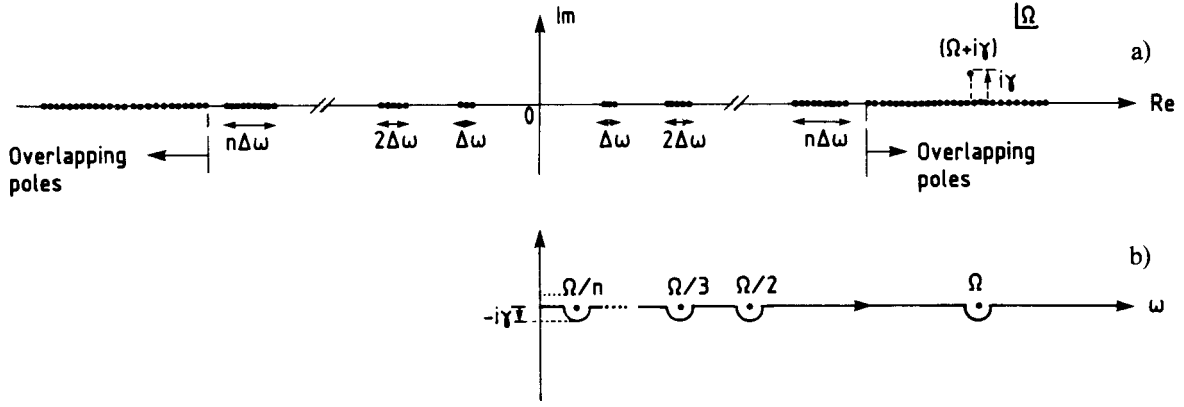

Fig. 23 Single-particle poles on the real frequency axis arising from the beam and the integration contour in revolution frequency ω for computation of beam response

with the period being the revolution time-period of the reference synchronous particle in the bunch. Thus

$$\begin{aligned} \mathcal{H}_{AB}(t, t' | \theta_P, \theta_K) &= \mathcal{R}_{AB}(t-t'; t' | \theta_P, \theta_K) = \sum_{k=-\infty}^{+\infty} \mathcal{R}_{AB}^k(t-t' | \theta_P, \theta_K) e^{-ik\omega_0 t'} \\ &= \sum_{k=-\infty}^{+\infty} s_{AB}^k(t-t' | \theta_P, \theta_K) e^{-ik\omega_0 t} \end{aligned} \quad (5.33)$$

and

$$\begin{aligned} \tilde{\mathcal{H}}_{AB}(\Omega, \Omega' | \theta_P, \theta_K) &= 2\pi \sum_{k=-\infty}^{+\infty} \tilde{\mathcal{R}}_{AB}^k(\Omega | \theta_P, \theta_K) \delta(\Omega - \Omega' - k\omega_0) \\ &= 2\pi \sum_{k=-\infty}^{+\infty} \tilde{s}_{AB}^k(\Omega - k\omega_0 | \theta_P, \theta_K) \delta(\Omega - \Omega' - k\omega_0) \end{aligned} \quad (5.34)$$

where

$$s_{AB}^k(t-t' | \theta_P, \theta_K) = \mathcal{R}_{AB}^k(t-t' | \theta_P, \theta_K) e^{ik\omega_0(t-t')} \quad (5.35)$$

and

$$\tilde{s}_{AB}^k(\Omega | \theta_P, \theta_K) = \tilde{\mathcal{R}}_{AB}^k(\Omega + k\omega_0 | \theta_P, \theta_K) \quad (5.36)$$

This leads to a coupling of the exciting signal to the modulated output signal at all frequencies which are discrete translations of each other by multiples of the revolution frequency as follows:

$$\begin{aligned} \tilde{\mathcal{A}}(\Omega | \theta_P) &= \sum_{k=-\infty}^{+\infty} \tilde{\mathcal{R}}_{AB}^k(\Omega | \theta_P, \theta_K) \tilde{\mathcal{B}}(\Omega - k\omega_0 | \theta_K) \\ &= \sum_{k=-\infty}^{+\infty} \tilde{s}_{AB}^k(\Omega - k\omega_0 | \theta_P, \theta_K) \tilde{\mathcal{B}}(\Omega - k\omega_0 | \theta_K) \end{aligned} \quad (5.37)$$

If the excitation at the kicker is at a fixed frequency Ω only, given by $\vec{\vec{B}}(\Omega|\theta_K)$, we can easily verify that a response is generated at the PU not only at the frequency Ω but also at the frequencies $\Omega + m\omega_0$, where $m = \pm 1, \pm 2, \dots$, and is given by

$$\vec{\vec{A}}(\Omega+m\omega_0|\theta_P) = \vec{\mathcal{R}}_{AB}^m(\Omega+m\omega_0|\theta_P, \theta_K) \vec{\vec{B}}(\Omega|\theta_K) = \vec{\mathcal{S}}_{AB}^m(\Omega|\theta_P, \theta_K) \vec{\vec{B}}(\Omega|\theta_K) \quad , \quad (5.38)$$

$$(m = 0, \pm 1, \pm 2, \dots, \pm\infty) \quad .$$

The set $[\vec{\vec{S}}_{AB}^m(\Omega|\theta_P, \theta_K)]_{m=-\infty, \dots, +\infty} \equiv [\vec{\vec{\mathcal{R}}}_{AB}^m(\Omega+m\omega_0|\theta_P, \theta_K)]_{m=-\infty, \dots, +\infty}$, describing the bunched beam transfer function, provides the response $\vec{\vec{A}}(\Omega+m\omega_0|\theta_P)$ at θ_P at frequency $\Omega + m\omega_0$ to an excitation at θ_K , $\vec{\vec{B}}(\Omega|\theta_K)$, at frequency Ω . We can also rewrite the response in the following operator notation:

$$\vec{\vec{A}}(\Omega|\theta_P) = \vec{\mathcal{R}}_{AB}(\Omega|\theta_P, \theta_K) \vec{\vec{B}}(\Omega|\theta_K) \quad , \quad (5.39)$$

where the response operator is given by

$$\vec{\mathcal{R}}_{AB}(\Omega|\theta_P, \theta_K) = \sum_{k=-\infty}^{+\infty} \vec{\mathcal{R}}_{AB}^k(\Omega|\theta_P, \theta_K) \hat{T}^{-k} = \sum_{k=-\infty}^{+\infty} \hat{T}^{-k} \vec{\mathcal{S}}_{AB}^k(\Omega|\theta_P, \theta_K) \quad (5.40)$$

and \hat{T}^k is the translation operator in frequency space for a translation by $k\omega_0$, i.e.

$$\hat{T}^k \vec{\vec{B}}(\Omega|\theta_K) = \vec{\vec{B}}(\Omega+k\omega_0|\theta_K) \quad , \quad (k = 0, \pm 1, \pm 2, \dots) \quad . \quad (5.41)$$

Thus the response of the periodically time-varying bunched-beam-storage-ring system can be characterized by the block-diagrammatic representation of Fig. 24 as an expansion in a parallel-series combination of a set of time-invariant elements $\vec{\vec{\mathcal{S}}}_{AB}^k(\Omega|\theta_P, \theta_K) \equiv \vec{\vec{\mathcal{R}}}_{AB}^k(\Omega+k\omega_0|\theta_P, \theta_K)$, each one modulated by sinusoidally time-varying gains $\exp(-ik\omega_0 t)$, the parallel branches ranging in $k = -\infty, \dots, -1, 0, +1, \dots, +\infty$.

The above considerations allow us to interpret the generated response $\vec{\vec{A}}(\Omega+k\omega_0|\theta_P)$ of a bunched-beam-storage-ring system as the components of a Bloch function $\vec{\vec{A}}_\Omega(t|\theta_P)$ written in the Bloch form³²⁾:

$$\vec{\vec{A}}_\Omega(t|\theta_P) = e^{-i\Omega t} \vec{\vec{F}}_\Omega(t|\theta_P) \quad , \quad (5.42)$$

where

$$\vec{\vec{F}}_\Omega(t|\theta_P) = \sum_{k=-\infty}^{+\infty} \vec{\vec{A}}(\Omega+k\omega_0|\theta_P) e^{-ik\omega_0 t} \quad (5.43)$$

is periodic in t with period $T_0 = 2\pi/\omega_0$, i.e. $\vec{\vec{F}}_\Omega(t|\theta_P) = \vec{\vec{F}}_\Omega(t+nT_0|\theta_P)$, $n = 0, \pm 1, \pm 2, \dots$, etc. This is similar to Floquet functions usually encountered in periodically time-varying systems, with the important difference that the periodic function $\vec{\vec{F}}_\Omega(t|\theta_P)$ in Eq. (5.42), and hence the coefficients in its Fourier expansion in Eq. (5.43), depend on the frequency Ω of interest—unlike in Floquet theory.

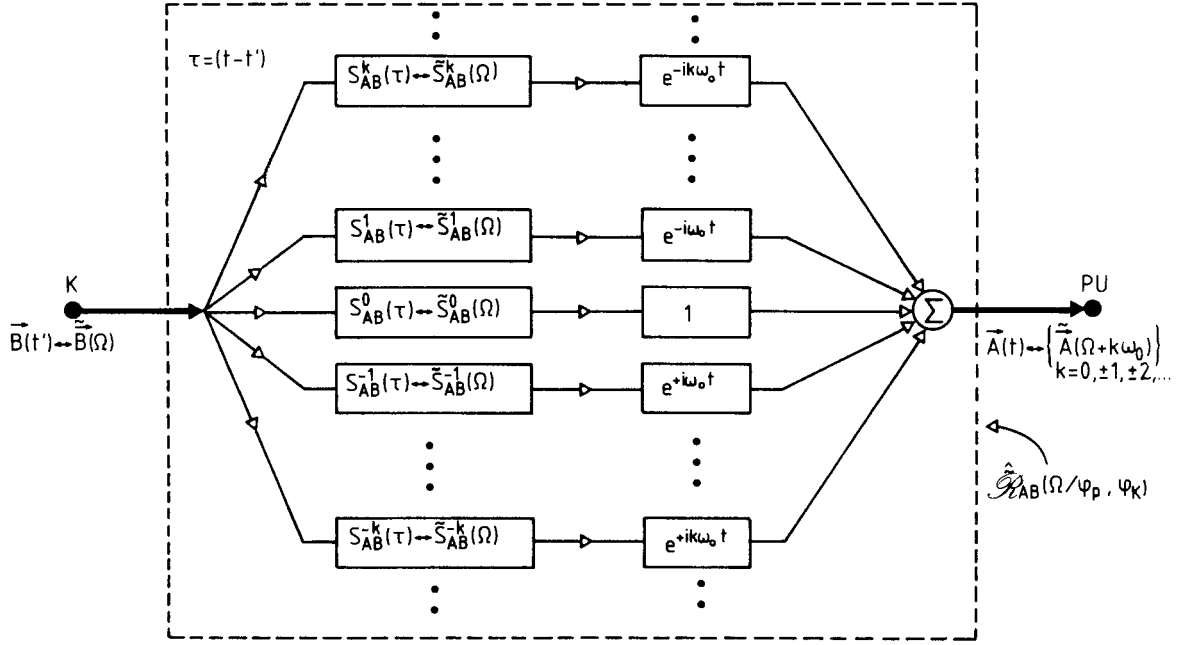

Fig. 24 Coherent BTF of a bunched beam represented as a parallel set of time-invariant elements followed by sinusoidally time-varying gains

It also follows that

$$\tilde{\mathcal{R}}_{AB}^k(\Omega | \theta_P, \theta_K) = [\tilde{\mathcal{R}}_{AB}^{-k}(-\Omega | \theta_P, \theta_K)]^* \quad (5.44)$$

for real frequencies Ω . Again $\tilde{\mathcal{R}}_{AB}^k(\Omega | \theta_P, \theta_K)$, considered for complex values of Ω , is analytic on the upper half-plane $\text{Im } \Omega > 0$ of complex Ω , and

$$[\tilde{\mathcal{R}}_{AB}^k(\Omega | \theta_P, \theta_K)]^* = \tilde{\mathcal{R}}_{AB}^{-k}(-\Omega^* | \theta_P, \theta_K) \quad (5.45)$$

All the considerations of analytic structure in the complex Ω -plane elaborated before, now apply to each of the individual Bloch components $\tilde{\mathcal{R}}_{AB}^k(\Omega | \theta_P, \theta_K)$, $k = 0, \pm 1, \pm 2$, etc., separately. Again, as before, one should really keep in mind the unambiguous Laplace transform $\tilde{\mathcal{R}}_{AB}^k(s | \theta_P, \theta_K)$ as the rigorous transform of the response, to be interpreted as a response to a frequency Ω by the replacement $s = -i\Omega + \gamma$, $\gamma \rightarrow 0^+$ only.

6. COHERENT BEAM RESPONSE: MICROSCOPIC KINETIC-THEORETICAL FORMALISM

A practical computation of the BTF or response function requires the use of the single-particle dynamics and distribution in microscopic phase space. Such a consistent microscopic theory is provided by the general kinetic theory introduced in Appendix A. Since we are interested in the coherent motion of the distribution of particles in the beam as a whole, the first equation in the hierarchy, namely the Vlasov equation, will suffice for a relevant ‘law of flow’ in phase space. We only need to deal with the ensemble averaged one-particle distribution $\Psi([x];t)$ in this linear Vlasov response formalism where $[x] \equiv [\{p\},\{q\}]$ is any canonical set of single-particle dynamical variables. For notational brevity, we only deal with single component excitation B and response A . The formalism can be extended trivially to general multicomponent cases involving vectors \vec{A} and \vec{B} and response tensor \mathcal{R}_{AB} . Occasionally we will also drop the indices θ_P, θ_K for convenience with the understanding that the exciting force $B(t)$ is always applied at a fixed kicker location $\theta = \theta_K$ and response $A(t)$ is measured always at a fixed PU location $\theta = \theta_P$.

We assume that the externally applied force perturbation may be represented by an additional term \mathcal{H}' of the single-particle Hamiltonian so that

$$\mathcal{H}([x];t) = \mathcal{H}_0([x];t) + \mathcal{H}'([x];t) = \mathcal{H}_0([x];t) - \mathcal{B}([x])B(t), \quad (6.1)$$

where $\mathcal{B}([x]) \equiv \mathcal{B}(\{p\},\{q\})$ is some suitable function on phase space. The Hamiltonian \mathcal{H}_0 in absence of perturbation may be time-independent, in which case it is a function of the single-particle constants of motion, e.g. action variables, only. Assuming the applied perturbation $B(t)$ is small, we can write the one-particle phase-space distribution function as an unperturbed part Ψ_0 plus a small perturbed part $\Delta\Psi$:

$$\Psi([x];t) = \Psi_0([x];t) + \Delta\Psi([x];t). \quad (6.2)$$

The ‘law of flow’ of Ψ is given by the Vlasov equation in phase space:

$$\frac{\partial \Psi}{\partial t} = [\mathcal{H}, \Psi], \quad (6.3)$$

where the right-hand side is a classical Poisson bracket⁸⁾. Since the beam in absence of perturbation is governed by the Hamiltonian \mathcal{H}_0 , we may use

$$\frac{\partial \Psi_0}{\partial t} = [\mathcal{H}_0, \Psi_0] \quad (6.4)$$

for the unperturbed state, yielding immediately for the perturbed part

$$\frac{\partial \Delta\Psi}{\partial t} = [\mathcal{H}_0, \Delta\Psi] - B(t)[\mathcal{B}([x]), \Psi_0] \quad (6.5)$$

to terms up to first order in the perturbation (i.e. neglecting terms of second order in the perturbation, e.g. $\Delta\Psi \cdot B(t)$, since we are interested in linear response only). In terms of canonical

action-angle variables $[x] = [\vec{I}, \vec{\psi}]$, one immediately recognizes (6.5) as the familiar^{7,29)} form of the first-order linearized Vlasov equation for the perturbed phase-space density $\Delta\Psi$:

$$\frac{\partial \Delta\Psi}{\partial t} + \dot{\vec{\psi}} \cdot \frac{\partial \Delta\Psi}{\partial \vec{\psi}} + \dot{\vec{I}} \cdot \frac{\partial \Psi_0}{\partial \vec{I}} = 0 \quad (6.6)$$

for the situation of time-independent unperturbed state where $\partial\Psi_0/\partial t = 0$ and Ψ_0 can only be a function of the single-particle constants of motion, namely the action variables, so that

$$\Psi_0 \equiv \Psi_0(\vec{I}) ; \quad \partial\Psi_0/\partial\vec{\psi} = 0 , \quad (6.7)$$

$$\dot{\vec{\psi}} = \frac{\partial \mathcal{H}_0(\vec{I})}{\partial \vec{I}} , \quad (6.8)$$

$$\dot{\vec{I}} = - \frac{\partial \mathcal{H}'([\vec{I}, \vec{\psi}]; t)}{\partial \vec{\psi}} = \frac{\partial}{\partial \vec{\psi}} [\mathcal{B}([\vec{I}, \vec{\psi}])B(t)] . \quad (6.9)$$

The equation (6.5) may be rewritten as

$$\frac{\partial \Delta\Psi}{\partial t} = -i\hat{L}_0 \Delta\Psi - B(t)[\mathcal{B}, \Psi_0] , \quad (6.10)$$

where \hat{L}_0 is the unperturbed Liouville operator in single-particle phase space, which operates on any arbitrary phase function $g([x]; t)$ as follows:

$$\hat{L}_0 g = i[\mathcal{H}_0, g] . \quad (6.11)$$

The formal solution of the homogeneous equation

$$\frac{\partial \Delta\Psi}{\partial t} = -i\hat{L}_0 \Delta\Psi \quad (6.12)$$

can be affected by a unitary transformation $\hat{U}_0(t|t')$ such that

$$\Delta\Psi([\mathbf{x}], t) = \hat{U}_0(t|t') \Delta\Psi([\mathbf{x}]; t') = \hat{U}_0(t|0) \Delta\Psi([\mathbf{x}]; 0) . \quad (6.13)$$

Here $\hat{U}_0(t|t')$ is a unitary time-evolution operator which transforms a state $\Delta\Psi(t')$ at time t' to a state $\Delta\Psi(t)$ at time t , with $\hat{U}_0(t|t) = 1$. For time-invariant systems, e.g. continuous coasting beams, \hat{L}_0 does not have any explicit time dependence (either in the laboratory frame or in the co-moving beam frame) and depends only on the phase-space coordinates so that the formal homogeneous solution to Eq. (6.12) may be written as

$$\Delta\Psi_H(t) = e^{-i\hat{L}_0(t-t')} \Delta\Psi_H(t') = e^{-i\hat{L}_0 t} \Delta\Psi_H(0) , \quad (6.14)$$

whence

$$\hat{U}_0(t|t') \equiv e^{-i\hat{L}_0(t-t')} . \quad (6.15)$$

We can now solve the inhomogeneous equation (6.10), with the aid of the above Green's function $\hat{U}_0(t|t')$, formally as a first-order linear differential equation with $-B(t) [\mathcal{B}([x]), \Psi_0]$ as a driving source term to get (by the method of characteristics):

$$\begin{aligned}\Delta\Psi([x];t) &= - \int_{-\infty}^t dt' \hat{U}_0(t|t') B(t') [\mathcal{B}([x(t')]), \Psi_0(t')] \\ &= - \int_{-\infty}^t dt' e^{-i(t-t')\hat{L}_0} B(t') [\mathcal{B}([x(t')]), \Psi_0(t')] .\end{aligned}\quad (6.16)$$

This procedure of solving an inhomogeneous equation is often called 'integration over unperturbed trajectories'. Here we have assumed $\Delta\Psi = 0$ at $t = -\infty$. Let $\mathcal{Q}([x])$ be the dynamical variable of the response corresponding to the physical response observable $A(t|\theta_P)$. We will use the notation $\mathcal{Q}(t) \equiv \mathcal{Q}[x(t)]$, $\mathcal{B}(t) \equiv \mathcal{B}[x(t)]$, $\mathcal{Q}(0) = \mathcal{Q}([x(0)]) \equiv \mathcal{Q}([x])$ and $\mathcal{B}(0) = \mathcal{B}[x(0)] \equiv \mathcal{B}([x])$ in the following. The physical response $A(t|\theta_P)$ is then given by the expectation value of $\mathcal{Q}([x])$ weighted with the perturbed phase-space density $\Delta\Psi([x];t)$ as follows:

$$\begin{aligned}A(t|\theta_P) &= \langle \mathcal{A}([x]) | \Delta\Psi([x];t) \rangle \\ &= \int d[x] \mathcal{A}([x]) \Delta\Psi([x];t) \\ &= - \int_{-\infty}^t dt' B(t'|\theta_K) \left\{ \int d[x] \mathcal{A}([x]) e^{-i(t-t')\hat{L}_0} [\mathcal{B}([x(t')]), \Psi_0(t')] \right\} \\ &= - \int_{-\infty}^t dt' B(t'|\theta_K) \left\{ \int d[x] \left[e^{i(t-t')\hat{L}_0} \mathcal{A}([x]) \right] [\mathcal{B}(t'), \Psi_0(t')] \right\} \\ &= - \int_{-\infty}^t dt' B(t'|\theta_K) \left\{ \int d[x] [\mathcal{B}(t'), \Psi_0(t')] \mathcal{A}(t-t') \right\} .\end{aligned}\quad (6.17)$$

Here we have used the fact that the equation of motion for any dynamical variable $\mathcal{Q}([x])$ which does not depend explicitly on time, may be written as⁸⁾

$$\frac{d\mathcal{A}}{dt} = - [\mathcal{H}_0, \mathcal{A}] = i\hat{L}_0\mathcal{A} ,\quad (6.18)$$

with the formal solution

$$\mathcal{A}(t) = e^{i(t-t')\hat{L}_0} \mathcal{A}(t') = e^{it\hat{L}_0} \mathcal{A}(0) .\quad (6.19)$$

We have used this in going from the fourth line to the fifth in Eq. (6.17). In going from the third line to the fourth, we have used the fact that $\exp(\pm i\hat{L}_0)$ is unitary, which follows from the fact that the unperturbed Liouville operator is Hermitian³³⁾, i.e.

$$\int d[\mathbf{x}] g^*([\mathbf{x}]) \hat{L}_0 h([\mathbf{x}]) = \int d[\mathbf{x}] (\hat{L}_0 g([\mathbf{x}]))^* h([\mathbf{x}]) \quad (6.20)$$

for phase functions $g([\mathbf{x}])$ and $h([\mathbf{x}])$ that vanish sufficiently rapidly at infinity in momentum space and outside of some finite volume in configuration space.

Note that the azimuth θ_K enters into $\mathcal{B}(t')$ as a parameter (not as a dynamical variable) and similarly θ_P enters into $\mathcal{A}(t')$ as a parameter; we may imply this dependence by writing $\mathcal{B}^K(t')$ and $\mathcal{A}^P(t')$ for $\mathcal{B}(t')$ and $\mathcal{A}(t')$ in our equations. For time-translation invariant systems like continuous coasting beams then we can write Eq. (6.17) in response form (noting the time-dependences Eqs. (6.14) and (6.19) imposed by the unperturbed Liouville operator \hat{L}_0 on distributions and phase-space functions):

$$A(t|\theta_P) = \int_{-\infty}^t dt' \mathcal{R}_{AB}(t-t'|\theta_P, \theta_K) B(t'|\theta_K) \quad , \quad (6.21)$$

with the response function given by

$$\mathcal{R}_{AB}(\tau|\theta_P, \theta_K) = \int d[\mathbf{x}] [\Psi_0, \mathcal{B}^K(0)] \mathcal{A}^P(\tau) \quad . \quad (6.22)$$

The Laplace transform of the response in the domain of the Laplace variable s , is

$$\begin{aligned} \tilde{\mathcal{R}}_{AB}(s|\theta_P, \theta_K) &= \int_0^{\infty} d\tau \mathcal{R}_{AB}(\tau|\theta_P, \theta_K) e^{-s\tau} \\ &= \int_0^{\infty} d\tau e^{-s\tau} \int d[\mathbf{x}] [\Psi_0, \mathcal{B}^K(0)] \mathcal{A}^P(\tau) \\ &= \int d[\mathbf{x}] [\Psi_0, \mathcal{B}^K(0)] \tilde{\mathcal{A}}^P(s) \quad . \end{aligned} \quad (6.23)$$

By the usual prescription discussed in Section 5, it is possible to interpret Eq. (6.23) as the response at a given frequency Ω by letting $s = -i\Omega + \gamma$ with $\gamma \rightarrow 0^+$, a vanishingly small positive number. Then the single-frequency response at frequency Ω is given by

$$\begin{aligned} \tilde{\mathcal{R}}_{AB}(\Omega|\theta_P, \theta_K) &= \lim_{\gamma \rightarrow 0^+} \int_0^{\infty} d\tau \mathcal{R}_{AB}(\tau|\theta_P, \theta_K) e^{(i\Omega - \gamma)\tau} \\ &= \lim_{\gamma \rightarrow 0^+} \int d[\mathbf{x}] [\Psi_0, \mathcal{B}^K(0)] \tilde{\mathcal{A}}^P(-i\Omega + \gamma) \quad . \end{aligned} \quad (6.24)$$

The phase-space dynamical variables that enter into our formalism have to be canonical by necessity, since we have made use of the canonical Poisson brackets. If we choose these canonical variables to be the action-angle variables $[x] \equiv (\vec{I}, \vec{\psi})$, we may write the response function using the form given by Eq. (6.22) as

$$\mathcal{R}_{AB}(\tau | \theta_P, \theta_K) = \int d\vec{I} \int_0^{2\pi} d\vec{\psi}_0 \sum_{\alpha=x, z, \theta} - \left[\frac{\partial \Psi_0(\vec{I})}{\partial I_\alpha} \cdot \frac{\partial \mathcal{B}^K[\vec{I}, \psi(0)]}{\partial \psi_{0, \alpha}} \right] \mathcal{A}^P[\vec{I}, \vec{\psi}(\tau)], \quad (6.25)$$

where $\alpha = x, z, \theta$ correspond to the two transverse and one longitudinal degrees of freedom of the beam and $\Psi_0(\vec{I})$, the stationary time-independent distribution, is a function of the constants of motion \vec{I} , i.e. action alone. Since $\mathcal{B}^K(\tau) \equiv \mathcal{B}^K[\vec{I}, \vec{\psi}(\tau)]$ and $\mathcal{A}^P(\tau) \equiv \mathcal{A}^P[\vec{I}, \vec{\psi}(\tau)]$ are periodic in the 2π -periodic angle variables $\vec{\psi}(\tau) = \vec{\psi}_0 + \vec{\omega}(\vec{I})\tau$, we may Fourier expand as

$$\mathcal{B}^K(\tau) = \sum_{\vec{n}} \mathcal{B}_{\vec{n}}^K(\vec{I}) e^{i\vec{n} \cdot \vec{\psi}(\tau)} = \sum_{\vec{n}} \mathcal{B}_{\vec{n}}^K(\vec{I}) e^{i\vec{n} \cdot \vec{\psi}_0 + i\vec{n} \cdot \vec{\omega}(\vec{I})\tau}, \quad (6.26)$$

$$\mathcal{A}^P(\tau) = \sum_{\vec{n}'} \mathcal{A}_{\vec{n}'}^P(\vec{I}) e^{i\vec{n}' \cdot \vec{\psi}(\tau)} = \sum_{\vec{n}'} \mathcal{A}_{\vec{n}'}^P(\vec{I}) e^{i\vec{n}' \cdot \vec{\psi}_0 + i\vec{n}' \cdot \vec{\omega}(\vec{I})\tau}, \quad (6.27)$$

where $\vec{n} \equiv (n_x, n_y, n_z)$ and $\vec{n}' \equiv (n'_x, n'_y, n'_z)$ are triplets of integer numbers $n_{x,y,z}, n'_{x,y,z} = 0, \pm 1, \pm 2, \dots$, etc., characterizing the angle harmonics of the Fourier decomposition. Using the identity

$$\frac{1}{(2\pi)^3} \int_0^{2\pi} d\vec{\psi}_0 e^{i(\vec{n} + \vec{n}') \cdot \vec{\psi}_0} = \delta_{\vec{n}', -\vec{n}}, \quad (6.28)$$

we obtain for the response function the following:

$$\tilde{\mathcal{R}}_{AB}(\Omega | \theta_P, \theta_K) = \lim_{\gamma \rightarrow 0^+} (2\pi)^3 \int d\vec{I} \sum_{\vec{n}} \left[\vec{n} \cdot \frac{\partial \Psi_0(\vec{I})}{\partial \vec{I}} \right] \frac{\mathcal{A}_{-\vec{n}}^P(\vec{I}) \mathcal{B}_{\vec{n}}^K(\vec{I})}{[\Omega - \vec{n} \cdot \vec{\omega}(\vec{I}) + i\gamma]}. \quad (6.29)$$

Extreme care is to be exercised in using this general expression for calculating any particular beam response. The differential integration element $(2\pi)^3 d\vec{I}$ has to be interpreted as $(2\pi)^3 d\vec{I} \equiv (2\pi dI_x)(2\pi dI_z)(2\pi dJ)$. Some of the factors of (2π) will disappear if we do not care about the full 6-dimensional character of the beam phase space for any particular response. For example, for longitudinal response of a continuous coasting beam, \vec{I} and $\vec{\psi}$ are simply scalars given by the longitudinal action $J = \int_{E_0}^E dE/\omega$ and the angle around the ring θ , where E is the energy and ω the revolution angular velocity of a particle. The integration element is simply $2\pi dJ$ in this case. The phase-space distribution is taken to be $\Psi_0(\vec{I}) \equiv \Psi_0(J)$, obtained after integrating over the transverse distributions. The harmonic \vec{n} is simply a scalar n , the azimuthal harmonic in the Fourier series expansion in the 2π -periodic angle around the ring. Thus $\vec{n} \cdot \vec{\omega}(\vec{I}) \equiv n\omega(J)$ and $\mathcal{A}_{-n}^P(J), \mathcal{B}_n^K(J)$ are functions of J (or equivalently E or ω), with θ_P and θ_K as parameters.

For transverse response of a continuous coasting beam in any one transverse plane x , say, $\vec{\Gamma} \equiv (I_x, J)$, $\vec{\psi} \equiv (\phi_x, \theta)$ where $\theta = \theta_0 + \omega(J)t$ and $\phi_x = \phi_x^0 + (\omega_\beta)_x t = \phi_x^0 + Q\omega(J)t$, Q being the transverse betatron tune. The integration element is $(2\pi dI_x)(2\pi dJ)$ and the phase-space distribution is taken to be $\Psi_0(\vec{\Gamma}) \equiv \Psi_0(I_x, J)$, obtained after integrating over the transverse z -distribution. For dipole transverse response only, the values of n_x are simply ± 1 , so that $\vec{n} \cdot \vec{\omega}(\vec{\Gamma}) \equiv (n \pm Q)\omega(J)$ in the denominator in Eq. (6.29). The coupling coefficients in the numerator in Eq. (6.29), $\mathcal{A}_{-\vec{n}}^P(\vec{\Gamma}) \equiv \mathcal{A}_{-n, \mp 1}^P(I_x, J)$ and $\mathcal{B}_{\vec{n}}^K(\vec{\Gamma}) \equiv \mathcal{B}_{n, \pm 1}^K(I_x, J)$ are function of J (or equivalently E or ω) and the betatron action I_x , with θ_P and θ_K as parameters again. However, the multiplying coefficient $[\vec{n} \cdot \partial \Psi_0(\vec{\Gamma}) / \partial \vec{\Gamma}]$ in Eq. (6.29) is simply $n_x [\partial \Psi_0(I_x, J) / \partial I_x]$, with no $n [\partial \Psi_0(I_x, J) / \partial J]$ appearing in it, for pure transverse excitation and response in the x -plane. This is evident from Eq. (6.25) where only the $\alpha = x$ term involving $\partial / \partial I_x$ and $\partial / \partial \psi_{0,x} \sim in_x$ would appear if the exciting force is in the x -plane only. Note that the summation $\sum_{\vec{n}}$ is still over the full vector $\vec{n} \equiv (n, n_x) = (n, \pm 1)$ since both longitudinal and transverse motion play roles in determining the unperturbed trajectories in the absence of the transverse excitation. For linear betatron oscillations, $I_x \propto A_x^2$ where A_x is the betatron oscillation amplitude and the tune Q is independent of I_x . For linear transverse dipole-moment excitation and response, one can then verify that $\mathcal{A}_{-n, \mp 1}^P(I_x, J) \propto A_x e^{-in\theta_P} \mathcal{A}(J) \propto \sqrt{I_x} e^{-in\theta_P} \mathcal{A}(J)$ and $\mathcal{B}_{n, \pm 1}^K(I_x, J) \propto A_x e^{in\theta_K} \mathcal{B}(J) \propto \sqrt{I_x} e^{in\theta_K} \mathcal{B}(J)$. In such a case an integration by parts of Eq. (6.29) yields the following alternative expression for the linear dipole transverse response in any one plane, say x :

$$\begin{aligned} \tilde{\mathcal{R}}_{AB}(\Omega | \theta_P, \theta_K) &= \lim_{\gamma \rightarrow 0^+} (2\pi)^2 \int dI_x \int dJ \\ &\sum_{n, n_x = \pm} (\pm) \frac{\partial}{\partial I_x} [\mathcal{A}_{-n, \mp 1}^P(I_x, J) \mathcal{B}_{n, \pm 1}^K(I_x, J)] \\ &\times \frac{\Psi_0(I_x, J)}{[\Omega - (n \pm Q)\omega(J) + i\gamma]} \end{aligned} \quad (6.30a)$$

$$\propto \lim_{\gamma \rightarrow 0^+} (2\pi) \int dJ \sum_{n, n_x = \pm} (\pm) e^{in(\theta_K - \theta_P)} \mathcal{A}(J) \mathcal{B}(J) \frac{\Psi_0(J)}{[\Omega - (n \pm Q)\omega(J) + i\gamma]}, \quad (6.30b)$$

where in the last step we have used the explicit forms of $\mathcal{A}_{-n, \mp 1}^P(I_x, J)$ and $\mathcal{B}_{n, \pm 1}^K(I_x, J)$ given above and assumed a normalized longitudinal distribution, integrated over transverse phase space according to $2\pi \int dI_x \Psi_0(I_x, J) \equiv \Psi_0(J)$.

The general expression (6.29) is valid for arbitrary excitation and includes the full three-dimensional response with coupling between various transverse and longitudinal degrees of freedom, where the tensorial character of $\tilde{\mathcal{R}}_{AB}(\Omega | \theta_P, \theta_K)$ is composed of the vectors \vec{n} and $\vec{\alpha}$ (response in any one of the three planes in phase space) and given by the diadic $\vec{n} \vec{\alpha}$. One needs to derive expressions for the coupling harmonics of the response and excitation dynamical variables [i.e. $\vec{\mathcal{A}}_{\vec{n}}^P(\vec{\Gamma})$ and $\vec{\mathcal{B}}_{\vec{n}}^K(\vec{\Gamma})$] in any specific case from the Hamiltonian and the general definitions of observables provided by our formalism. The procedure of actually evaluating the response will be clearer in the next section, where we calculate one such response explicitly.

The expression for response has to be modified for time-dependent systems such as bunched beams, as has been hinted in the previous section. The unperturbed Liouville operator \hat{L}_0 is

time-dependent in the laboratory frame. In the co-moving beam frame, however, we can still use, as before, the time-independent unperturbed Liouville operator \hat{L}_0 , which depends only on the canonical phase-space coordinates defined in the beam frame, with no explicit time dependence. However, the dynamical variables $\mathcal{A}^P(t)$ and $\mathcal{B}^K(t)$ corresponding to observable response at θ_P and excitation at θ_K would depend on time not only through the time-dependent phase-space dynamical coordinates $[x(t)]$ in the beam frame alone, but they would also have explicit time dependences. For stationary coasting bunched beams, this time dependence is periodic with the period being the nominal revolution time period in the ring. Fourier series decomposing this periodic time dependence, we may then write

$$\mathcal{A}^P(t) = \mathcal{A}^P([x(t)]; t) = \sum_{\ell=-\infty}^{+\infty} \mathcal{A}_{\ell}^P([x(t)]) e^{-i\ell\omega_0 t}, \quad (6.31)$$

$$\mathcal{B}^K(t) = \mathcal{B}^K([x(t)]; t) = \sum_{m=-\infty}^{+\infty} \mathcal{B}_m^K([x(t)]) e^{-im\omega_0 t}. \quad (6.32)$$

With this decomposition and following the same procedure as before, one verifies that the bunched beam response may be written as

$$A(t|\theta_P) = \sum_{k=-\infty}^{+\infty} \int_{-\infty}^t dt' \mathcal{R}_{AB}^k(t-t'|\theta_P, \theta_K) B(t'|\theta_K) e^{-ik\omega_0 t'}, \quad (6.33)$$

where

$$\mathcal{R}_{AB}^k(\tau|\theta_P, \theta_K) = \sum_{\ell=-\infty}^{+\infty} \int d[x] [\Psi_0, \mathcal{B}_{\ell-k}^K(0)] \mathcal{A}_{\ell}^P(\tau) e^{i\ell\omega_0 \tau} \quad (6.34)$$

in the time domain and

$$\tilde{A}(\Omega|\theta_P) = \sum_{k=-\infty}^{+\infty} \tilde{\mathcal{R}}_{AB}^k(\Omega|\theta_P, \theta_K) \tilde{B}(\Omega - k\omega_0|\theta_K), \quad (6.35)$$

where

$$\begin{aligned} \tilde{\mathcal{R}}_{AB}^k(\Omega|\theta_P, \theta_K) &= \lim_{\gamma \rightarrow 0^+} \sum_{\ell=-\infty}^{+\infty} \int d[x] \int_0^{\infty} d\tau [\Psi_0, \mathcal{B}_{\ell-k}^K(0)] \mathcal{A}_{\ell}^P(\tau) e^{i[(\Omega + \ell\omega_0) + i\gamma]\tau} \\ &= \lim_{\gamma \rightarrow 0^+} \sum_{\ell=-\infty}^{+\infty} \int d[x] [\Psi_0, \mathcal{B}_{\ell-k}^K(0)] \tilde{\mathcal{A}}_{\ell}^P(-i\Omega - i\ell\omega_0 + \gamma) \end{aligned} \quad (6.36)$$

in the frequency domain, where $\tilde{\mathcal{G}}_i^P(s)$ is the Laplace transform of $\mathcal{G}_i^P(\tau)$.

The canonical variables may be chosen to be the action-angle variables of the transverse betatron oscillations and longitudinal synchrotron oscillation, i.e. $[x] \equiv (\vec{I}, \vec{\psi}) = (I_x, I_z, J; \phi_x, \phi_z, \psi)$ with $\phi_{x,z}(t) = \phi_{x,z}^0 + Q_{x,z}\omega_0 t$ and $\psi(t) = \psi^0 + \omega_s(J)t$, and $\Psi_0(\vec{I}) = \Psi_0(I_x, I_z, J)$. Again one can Fourier expand $\mathcal{G}_i^P(\tau) = \mathcal{G}_i^P[\vec{I}, \vec{\psi}(\tau)]$ and $\mathcal{B}_m^K(\tau) = \mathcal{B}_m^K[\vec{I}, \vec{\psi}(\tau)]$ in the 2π -periodic angle variables $\vec{\psi} = \vec{\psi}_0 + \vec{\omega}(\vec{I})\tau$ where $\vec{\omega}(\vec{I}) = (\omega_x, \omega_z, \omega_s(J)) = (Q_x\omega_0, Q_z\omega_0, \omega_s(J))$, as follows:

$$\mathcal{A}_\ell^P(\tau) = \sum_{\vec{n}} [\mathcal{A}_\ell^P]_{\vec{n}}(\vec{I}) e^{i\vec{n} \cdot \vec{\psi}(\tau)} = \sum_{\vec{n}} [\mathcal{A}_\ell^P]_{\vec{n}}(\vec{I}) e^{i\vec{n} \cdot \vec{\psi}_0 + i\vec{n} \cdot \vec{\omega}(\vec{I})\tau}, \quad (6.37)$$

$$\mathcal{B}_m^K(\tau) = \sum_{\vec{n}'} [\mathcal{B}_m^K]_{\vec{n}'}(\vec{I}) e^{i\vec{n}' \cdot \vec{\psi}(\tau)} = \sum_{\vec{n}'} [\mathcal{B}_m^K]_{\vec{n}'}(\vec{I}) e^{i\vec{n}' \cdot \vec{\psi}_0 + i\vec{n}' \cdot \vec{\omega}(\vec{I})\tau}, \quad (6.38)$$

where $\vec{n} = (n_x, n_z, \mu)$ are triplets of integer numbers $n_{x,z}, \mu = 0, \pm 1, \pm 2, \dots$, etc., with n_x, n_z the betatron harmonics and μ the synchrotron harmonic and similarly for \vec{n}' . Using the identity (6.28) again, we obtain the following expression for the response function:

$$\begin{aligned} \tilde{\mathcal{R}}_{AB}^k(\Omega | \theta_P, \theta_K) &= \lim_{\gamma \rightarrow 0^+} (2\pi)^3 \sum_{\ell=-\infty}^{\infty} \int d\vec{I} \sum_{\vec{n}} \left[\vec{n} \cdot \frac{\partial \Psi_0(\vec{I})}{\partial \vec{I}} \right] \\ &\times \frac{[\mathcal{A}_\ell^P]_{-\vec{n}}(\vec{I}) [\mathcal{B}_{\ell-k}^K]_{\vec{n}}(\vec{I})}{[\Omega - \ell\omega_0 - \vec{n} \cdot \vec{\omega}(\vec{I}) + i\gamma]}. \end{aligned} \quad (6.39)$$

Note that here $\vec{n} \cdot \vec{\omega}(\vec{I}) = n_x\omega_x + n_z\omega_z + \mu\omega_s(J) = (\pm Q_x \pm Q_z)\omega_0 + \mu\omega_s(J)$ for linear dipole response. For longitudinal response the denominator is simply $[\Omega - \ell\omega_0 - \mu\omega_s(J) + i\gamma]$ and for transverse dipole response in one transverse plane, say x , the denominator is $[\Omega - (\ell \pm Q_x)\omega_0 - \mu\omega_s(J) + i\gamma]$. Looking ahead in the next section, we can say that for longitudinal response with $J \propto a^2$, $[\mathcal{A}_\ell^P]_\mu(J) \propto J_\mu(\ell a)e^{i\ell\theta_P}$, $[\mathcal{B}_{\ell+k}^K]_\mu(J) \propto J_\mu((\ell+k)a)e^{i(\ell+k)\theta_K}$ where J_μ 's are ordinary Bessel functions of integer order⁷⁾.

The physical mechanism of the response is simple. Excitation at a frequency Ω at the kicker $\theta = \theta_K$ given by $\tilde{B}(\Omega|\theta_K)e^{-i\Omega t}$ will excite azimuthal waves $\langle \ell, \Omega | \sim e^{-i(\ell\theta - \Omega t)} f(\vec{I}, \vec{\psi})$ of all possible integer azimuthal harmonics $\langle \ell, \Omega |$, $\ell = 0, \pm 1, \pm 2, \dots$, etc., in the beam. Each one of these azimuthal waves $\langle \ell, \Omega |$ imposed externally at the kicker will couple to the internal dynamics of the beam phase space and in particular will excite, in principle, all the harmonic waves $|\vec{n}, \Omega\rangle \sim e^{i\vec{n} \cdot \vec{\psi} - i\Omega t} f(\vec{I})$ in the action-angle variable. The coupling of the azimuthal wave $\langle \ell, \Omega |$ to the action-angle harmonic wave $|\vec{n}, \Omega\rangle$ in bunch phase space at the kicker is just $\langle \ell, \Omega | \vec{n}, \Omega\rangle \sim [\mathcal{B}_{\ell}^K]_{\vec{n}}(\vec{I})$. The excitation is then propagated or carried along as action-angle harmonic waves by the intrinsically circular dynamics of particle orbits in bunch phase space $(\vec{I}, \vec{\psi})$ and projected onto the azimuthal wave states $|\{m\}, \Omega\rangle$ again at the pick-up, which add up to give the response $\tilde{A}(\Omega'|\theta_P)e^{-i\Omega' t}$ at the pick-up. The coupling of each bunch internal wave $\langle \vec{n}, \Omega |$ to the azimuthal wave $|\{m\}, \Omega\rangle$ at the pick-up is just $\langle \vec{n}, \Omega | \{m\}, \Omega\rangle \sim [\mathcal{A}_m^P]_{-\vec{n}}(\vec{I})$. Rotation with frequency $\vec{\omega}(\vec{I})$ in bunch phase space and frequency ω_0 around the storage ring will give rise to simple poles at frequencies $\Omega = (\ell - m)\omega_0 + \vec{n} \cdot \vec{\omega}(\vec{I})$ in the propagation from $\langle \ell, \Omega |$ to $|\{m\}, \Omega\rangle$ through the phase-space dynamics, when Fourier transformed in frequency. Contribution of a single particle

of oscillation action $\vec{\Gamma}$ in the propagation of excitation $\langle \ell, \Omega |$ to generate a response $|m, \Omega\rangle$ is then given by the matrix element $\tilde{M}_{\ell, m}(\Omega)$ with an effective sum over the internal oscillation harmonics \vec{n} as follows:

$$\begin{aligned} \tilde{M}_{\ell, m}(\Omega) &= \sum_{\vec{n}} \tilde{M}_{\ell, m}^{\vec{n}}(\Omega) = \langle \ell, \Omega | m, \Omega \rangle = \sum_{\vec{n}} \frac{\langle \ell, \Omega | \vec{n}, \Omega \rangle \langle \vec{n}, \Omega | m, \Omega \rangle}{[\Omega - \ell\omega_0 + m\omega_0 - \vec{n} \cdot \vec{\omega}(\vec{\Gamma})]} \\ &= \sum_{\vec{n}} \frac{[\mathcal{B}_{\ell}^K]_{\vec{n}}(\vec{\Gamma}) \cdot [\mathcal{A}_m^P]_{-\vec{n}}(\vec{\Gamma})}{[\Omega - (\ell - m)\omega_0 - \vec{n} \cdot \vec{\omega}(\vec{\Gamma})]} \quad (6.40) \end{aligned}$$

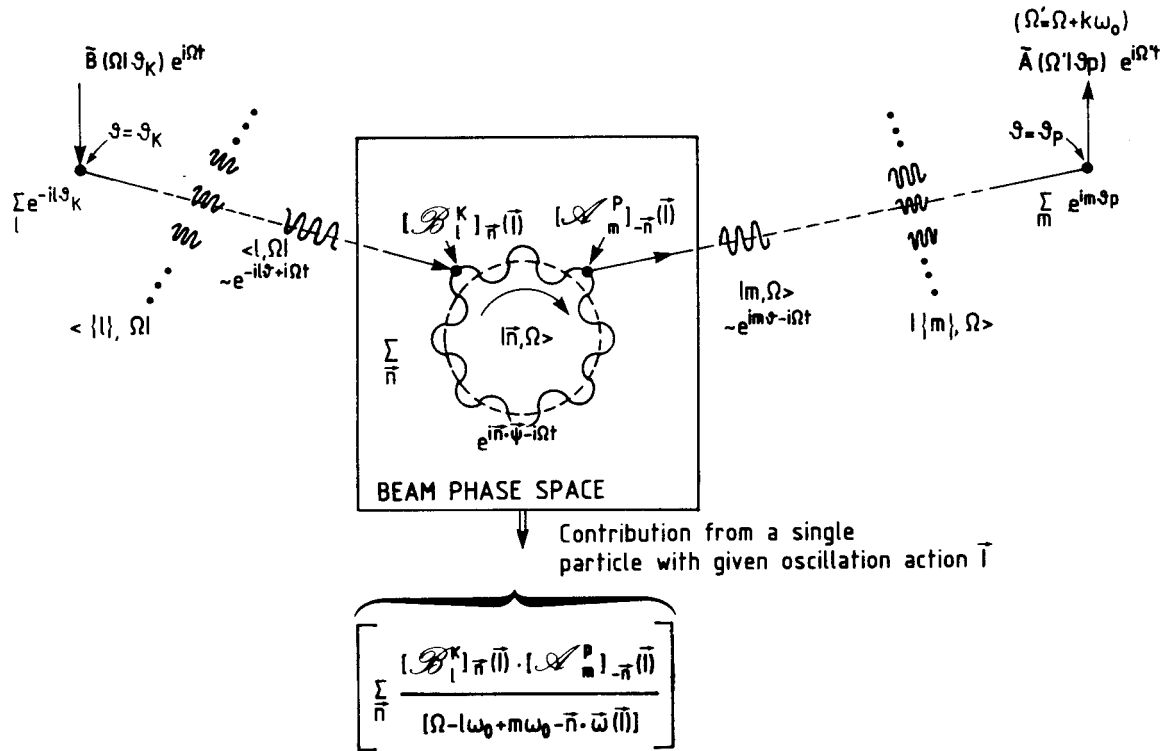

Fig. 25 Physical mechanism of beam response

We leave it up to the reader to be convinced that such a response between the azimuthal harmonic wave states $\langle \ell, \Omega |$ and $|m, \Omega\rangle$ at a given frequency Ω independent of any reference to locations of excitations and observation of response (θ_k and θ_p) will reproduce the response $\tilde{A}(\Omega'|\theta_p)$ at $\theta = \theta_p$ from excitation $\tilde{B}(\Omega|\theta_k)$ at $\theta = \theta_k$ exactly as given by Eq. (6.39), when one sums over all the particles and all the harmonics properly to localize the excitation at θ_k and observed response at θ_p . This physical mechanism of beam response is shown pictorially in Fig. 25.

One comment is in order regarding the appearance of the derivative $[\partial\Psi_0(\vec{I})/\partial\vec{I}]$ in all our response expressions. We note that Eq. (6.3) can be written as a total derivative

$$\frac{d\Psi}{dt} = \frac{\partial\Psi}{\partial t} + [\Psi, \mathcal{H}] = 0 \quad (6.41)$$

implying conservation of the phase-space density $\Psi(\vec{I}, \vec{\psi}; t)$ in the $[\vec{\psi}, \vec{I}]$ phase space (Liouville's theorem). Thus the particles move in the phase space like an incompressible fluid and any perturbing force can only produce a distortion in the distribution by affecting particles that are located in a region in phase space where there is some gradient in the unperturbed phase-space density $\Psi_0(\vec{I})$. Hence the appearance of $\partial\Psi_0(\vec{I})/\partial\vec{I}$ in our response expressions.

7. COHERENT BEAM RESPONSE: EXAMPLES

The formal expressions for the response given in the preceding section are elegant and concise but have to be supplemented with an example of a practical calculation of the BTF using those expressions. We demonstrate the calculation of the longitudinal response function for a continuous coasting beam as an example.

The first task is to determine the phase functions $\mathcal{B}([x])$ and $\mathcal{Q}([x])$, as functions of the dynamical canonical variables $[x]$, corresponding to the physical observables $B(t)$ and $A(t)$ entering into the response \mathcal{R}_{AB} of interest to us. Also, the phase function $\mathcal{B}([x])$ corresponding to the excitation $B(t)$ has to be such as to correspond to the interaction Hamiltonian in Eq. (6.1).

For longitudinal response we are interested in the current modulation $I(t|\theta_P)$, say, generated at a pick-up at $\theta = \theta_P$ by a voltage $V(t|\theta_K)$, which modulates the energy, applied at a kicker at $\theta = \theta_K$. The current modulation may be written as

$$I(t|\theta_P) = q \int_0^{2\pi} d\theta \int d\omega \cdot \omega \cdot \sum_{n=-\infty}^{+\infty} \delta[\theta(t) - \theta_P - 2\pi n] \Delta\psi(\omega, \theta; t) \quad (7.1)$$

In terms of canonical variables θ and longitudinal continuous coasting beam action J

$$J = \int_{E_0}^E \frac{dE}{\omega}, \quad (7.2)$$

we can write

$$I(t|\theta_P) = q \int dJ \int_0^{2\pi} d\theta \left\{ \frac{\omega(J)}{(2\pi)} \sum_{n=-\infty}^{+\infty} e^{-in[\theta(t) - \theta_P]} \right\} \Delta\Psi(J, \theta; t) \quad (7.3)$$

where we have used the Fourier series representation of the periodic delta-function and

$$\Delta\Psi(\omega, \theta; t) d\omega = \Delta\Psi(E, \theta; t) dE = \Delta\Psi(J, \theta; t) dJ \quad (7.4)$$

Accordingly the phase function $\mathcal{Q}(t)$ corresponding to the response variable $A(t|\theta_P) \equiv I(t|\theta_P)$ is given by

$$\mathcal{A}(t) \equiv \mathcal{A}([x(t)]) = \mathcal{A}(\theta(t), J) = \frac{q\omega(J)}{(2\pi)} \sum_{n=-\infty}^{+\infty} e^{-in[\theta(t) - \theta_P]}. \quad (7.5)$$

The angle derivative of the phase function $\mathcal{B}(t) \equiv \mathcal{B}(\theta(t), J)$ corresponding to the exciting variable $B(t|\theta_K) \equiv V(t|\theta_K)$ is given by

$$\frac{\partial \mathcal{B}(t)}{\partial \theta} v(t|\theta_K) = \dot{j} = \frac{1}{\omega} \cdot \dot{E} = \frac{1}{\omega} \cdot \omega q \sum_{m=-\infty}^{+\infty} \delta[\theta(t) - \theta_K - 2\pi m] v(t|\theta_K), \quad (7.6)$$

where we have used $dJ = dE/\omega$. Thus, using the Fourier series representation of the periodic delta-function again, we obtain

$$\frac{\partial \mathcal{B}(\tau)}{\partial \theta} = \frac{\partial \mathcal{B}(\theta(\tau), J)}{\partial \theta} = \frac{q}{2\pi} \sum_{m=-\infty}^{+\infty} e^{-im[\theta(\tau)-\theta_K]} \quad (7.7)$$

Using the form (6.25), the longitudinal response $\mathcal{R}_{\parallel}(\tau|\theta_P, \theta_K)$ can be written as

$$\mathcal{R}_{\parallel}(\tau|\theta_P, \theta_K) = \int dJ \int_0^{2\pi} d\theta \left[-\frac{\partial \Psi_0(J)}{\partial J} \cdot \frac{\partial \mathcal{B}(\theta)}{\partial \theta} \right] \mathcal{A}(\tau), \quad (7.8)$$

where we have used $\partial \Psi_0(J)/\partial \theta = 0$ since the stationary zeroth-order distribution $\Psi_0(J)$ is a function of the constant of motion J , i.e. the action alone. Noting that

$$\Psi_0(J) = \Psi_0(E) \left| \frac{dE}{dJ} \right| = \omega \Psi_0(E) = N\omega \Psi_0(\omega) \left| \frac{d\omega}{dE} \right| = N\kappa \omega \Psi_0(\omega) \text{Sgn}\kappa, \quad (7.9)$$

where $\kappa = d\omega(E)/dE$, and $\Psi_0(\omega)$ is the normalized (to unity) distribution in ω , we can write

$$\begin{aligned} \mathcal{R}_{\parallel}(\tau|\theta_P, \theta_K) = & -\frac{q^2 \kappa N}{(2\pi)^2} \int d\omega \int_0^{2\pi} d\theta_0 \cdot \omega \cdot \frac{\partial}{\partial \omega} [\omega \Psi_0(\omega)] \sum_{m=-\infty}^{+\infty} e^{-im[\theta_0 - \theta_K]} \\ & \times \sum_{n=-\infty}^{+\infty} e^{-in[\theta(\tau) - \theta_P]} \end{aligned} \quad (7.10)$$

Using the unperturbed zeroth-order orbits

$$\theta(\tau) = \theta_0 + \omega\tau, \quad \theta(0) = \theta_0 \quad (7.11)$$

and

$$\frac{1}{2\pi} \int_0^{2\pi} d\theta_0 e^{i(m+n)\theta_0} = \delta_{m, -n}, \quad (7.12)$$

we obtain

$$\mathcal{R}_{\parallel}(\tau|\theta_P, \theta_K) = -\frac{Nq^2 \kappa}{(2\pi)} \int d\omega \cdot \omega \cdot \frac{\partial}{\partial \omega} [\omega \Psi_0(\omega)] \sum_{n=-\infty}^{+\infty} e^{-in(\theta_K - \theta_P)} e^{-in\omega\tau}. \quad (7.13)$$

The Laplace transform of the response is immediately obtained as

$$\begin{aligned} \tilde{\mathcal{R}}_{\parallel}(s|\theta_P, \theta_K) &= \int_0^{\infty} d\tau \mathcal{R}_{\parallel}(\tau|\theta_P, \theta_K) e^{-s\tau} = -\frac{Ng^2\kappa}{(2\pi)} \int d\omega \cdot \omega \cdot \frac{\partial}{\partial\omega} [\omega\Psi_0(\omega)] \\ &\times \sum_{n=-\infty}^{+\infty} \frac{e^{in(\theta_P-\theta_K)}}{[s+i\omega]} \end{aligned} \quad (7.14)$$

Then the single-frequency response at frequency Ω is obtained by setting $s = -i\Omega + \gamma$ as:

$$\tilde{\mathcal{R}}_{\parallel}(\Omega|\theta_P, \theta_K) = (-i) \frac{Ng^2\kappa}{(2\pi)} \int d\omega \cdot \omega \cdot \frac{\partial}{\partial\omega} [\omega\Psi_0(\omega)] \lim_{\gamma \rightarrow 0^+} \sum_{n=-\infty}^{+\infty} \frac{e^{in(\theta_P-\theta_K)}}{[\Omega-n\omega+i\gamma]} \quad (7.15)$$

The sum over n in Eq. (7.15) can be performed exactly and yields³⁴⁾

$$\begin{aligned} \sum_{n=-\infty}^{+\infty} \frac{e^{in(\theta_P-\theta_K)}}{[\Omega-n\omega]} &= -i \left(\frac{2\pi}{\omega} \right) \frac{\exp \left[i(\theta_P-\theta_K) \frac{\Omega}{\omega} \right]}{1 - \exp \left[2\pi i \frac{\Omega}{\omega} \right]} = -i \left(\frac{\pi}{\omega} \right) \left[1 + i \cot \left(\pi \frac{\Omega}{\omega} \right) \right] \\ &\times \exp \left[i(\theta_P-\theta_K) \frac{\Omega}{\omega} \right], \end{aligned} \quad (7.16)$$

where we have assumed that $(\theta_P - \theta_K)$ is positive and $0 < (\theta_P - \theta_K) < 2\pi$. The frequency response then may be written as

$$\begin{aligned} \tilde{\mathcal{R}}_{\parallel}(\Omega|\theta_P, \theta_K) &= \frac{Ng^2\kappa}{2} \int d\omega \cdot \frac{\partial}{\partial\omega} [\omega\Psi_0(\omega)] \left[1 + i \cot \left(\pi \frac{\Omega}{\omega} \right) \right] \\ &\times \exp \left[i(\theta_P-\theta_K) \frac{\Omega}{\omega} \right] \end{aligned} \quad (7.17)$$

Note that this response relates the actual beam current modulation to the actual voltage seen by the beam. In the context of a BTF measurement, as shown in Fig. 19, one measures the ratio of the observable current I_P generated by the pick-up to the voltage applied at the kicker. The measured BTF should therefore include the electrical quantities such as the PU sensitivity and kicker efficiency, etc. In addition it will include other impedances or gains in the transfer lines PU-A and B-K (Fig. 19) and more importantly a phase factor corresponding to the electrical delay of the transfer line. For a sum pick-up, the PU sensitivity is a function of the electrical frequency only. However, for a difference PU, the sensitivity is a function of beam position, and the current modulation observed at the PU will contain a contribution from the beam energy modulation as well. Thus the effect of the pick-up, which may be sensitive to the beam energy in addition to the electrical frequency, may be incorporated simply by including a frequency- and energy-dependent sensitivity function $P(\Omega, \omega)$ inside the integral in Eq. (7.17). The electrical delay in the cables of the transfer line may be included simply by a multiplying phase factor of $\exp(i\Omega\tau_C)$, where τ_C is the delay time. If the storage-ring lattice is irregular, there may be additional terms in

the response function. For an irregular lattice, one may define a quantity α_1 , analogous to $\alpha = (\theta_K - \theta_P)/2\pi = 1 - (s/2\pi R_{av})$, by

$$\alpha_1 = 1 - \frac{\int_0^s \lambda ds}{2\pi \kappa R_{av}^2}, \quad (7.18)$$

where

$$\lambda = \frac{\partial}{\partial E} \left(\frac{ds}{dt} \right), \quad \lambda_{av} = \kappa R_{av} = \frac{\eta \omega_0}{\beta^2 E_0} R_{av} \quad \left(\kappa = \frac{d\omega}{dE} \right) \quad (7.19)$$

denotes a lattice property, which is a function of the particle energy, the local dispersion and the radius of curvature. One can show that

$$\lambda = \frac{c}{p} \left(\frac{1}{\gamma_{tr}^2} - \frac{\alpha}{\rho} \right) \quad (p \text{ in eV}/c) \quad (7.20)$$

and

$$2\pi(\alpha_1 - \alpha) = \frac{1}{\eta} \left[\frac{2\pi\alpha}{\gamma_{tr}^2} - \frac{1}{R_{av}} \int_s^0 \frac{\alpha}{\rho} ds \right], \quad (7.21)$$

where ρ is the local bending radius and the integral is taken from the PU (at s) to the kicker (at $s = 0$) position and

$$(\alpha_1 - \alpha)_{av} = 0 = (\alpha_1)_{av} - \alpha_{av}. \quad (7.22)$$

If we define a normalized longitudinal beam transfer function by

$$\tilde{B}_{||}(\Omega | \theta_P, \theta_K) = \frac{\tilde{I}_P(\Omega)}{\tilde{V}(\Omega)} \cdot \frac{1}{q^2 \kappa} \cdot e^{i\Omega \tau_c}, \quad (7.23)$$

one obtains the normalized longitudinal BTF for a continuous coasting beam, including all the above effects, as^{21,35,36)}

$$\begin{aligned} \tilde{B}_{||}(\Omega | \theta_P, \theta_K) &= \frac{N}{2} e^{-i\Omega(2\pi\alpha/\omega_0 - \tau_c)} \int d\omega \cdot P(\Omega, \omega) C(\Omega, \omega) \left[1 + i \cot \left(\pi \frac{\Omega}{\omega} \right) \right] \\ &\quad \times \left\{ \frac{\partial}{\partial \omega} [\omega \Psi_0(\omega)] + i 2\pi(\alpha_1 - \alpha) \Psi_0(\omega) \frac{\Omega}{\omega} \right\}, \quad (7.24) \end{aligned}$$

where

$$C(\Omega, \omega) = \exp \left[-i 2\pi \alpha \Omega \left(\frac{1}{\omega} - \frac{1}{\omega_0} \right) \right] \quad (7.25)$$

Note that the normalized longitudinal BTF as defined in (7.23) is a dimensionless quantity and the sign of its imaginary part is the same for machines working below or above transition (κ has been included in the definition). It is thus relatively machine-independent compared to the usual response function $\tilde{\mathcal{R}}_{\parallel}(\Omega|\theta_P, \theta_K)$.

Frequency-dependent gains in the transfer lines and frequency- and energy-dependent kicker efficiency may be included in $P(\Omega, \omega)$ if desired.

If the pick-up and kicker considered happen to be those corresponding to a stochastic cooling feedback loop^{35,36}, the phase-factor in front in $\tilde{\mathcal{B}}_{\parallel}(\Omega|\theta_P, \theta_K)$ is simply unity, since for stochastic cooling the electrical delay τ_C is matched exactly to the transit time of the nominal reference particle with angular velocity ω_0 from the pick-up to the kicker, i.e. $\tau_C = (\theta_K - \theta_P)/\omega_0 = 2\pi\alpha/\omega_0$. The additional phase shift

$$\Delta\phi(\Omega, \omega) = 2\pi\alpha\Omega \left(\frac{1}{\omega} - \frac{1}{\omega_0} \right) \quad (7.26)$$

for particles with frequency $\omega \neq \omega_0$, is then properly included in the factor $C(\Omega, \omega) = e^{-i\Delta\phi(\Omega, \omega)}$ and gives rise to the special effect known as ‘mixing between pick-up and kicker’ in stochastic cooling theory^{20,35,36}.

Note that

$$\frac{\partial}{\partial\omega} [\omega\Psi_0(\omega)] = \Psi_0(\omega) + \omega \frac{d\Psi_0(\omega)}{d\omega} \quad (7.27)$$

In the usual theory of response of beams²⁹, one usually finds only the second term involving the derivative of $\Psi_0(\omega)$. This is approximately true only if the relative revolution frequency spread is small so that $\omega \simeq \omega_0$ can be taken out of the derivative. The addition of $\Psi_0(\omega)$ to $\omega_0 (d\Psi_0/d\omega)$ is then negligible. However if the spread is large or frequency Ω is high so that the beam revolution harmonic Schottky bands are wide, it is not only non-negligible but absolutely essential theoretically in order for the beam response to have correct properties. To see this, we consider an ideal sum pick-up with unit sensitivity at the same place as the kicker $\theta_P = \theta_K$ so that $\alpha = \alpha_1 = 0$ and $P = C = 1$. For this special case, we also consider the beam Schottky harmonic bands non-overlapping. If we excite the beam at a frequency Ω which lies in the non-overlapping region in between two Schottky bands, the response of the beam should be purely reactive with only imaginary component, since there are no particles in the beam that can resonate and absorb energy by generating such a frequency Ω , i.e. $\Psi_0(\Omega) = 0$ at such Ω where $\Psi_0(\Omega)$ is the distribution in frequency in the frequency space. With only the $\omega(d\Psi_0/d\omega)$ term, however, the real part of the response is non-zero and finite

$$\text{Re } \tilde{\mathcal{B}}_{\parallel} = \frac{N}{2} \int_0^{\infty} d\omega \cdot \omega \frac{d\Psi_0(\omega)}{d\omega} = -\frac{N}{2} \int \Psi_0(\omega) d\omega = -\frac{N}{2} \quad (7.28)$$

The addition of $\Psi_0(\omega)$ to $\omega[d\Psi_0(\omega)/d\omega]$ is thus essential since it cancels $-N/2$ precisely giving $\text{Re } \tilde{\mathcal{B}}_{\parallel} = 0$, thus avoiding an in-phase component of the current that would correspond to energy absorption by the beam. One also sees this by noting

$$\int_0^{\infty} d\omega \frac{\partial}{\partial\omega} [\omega\Psi_0(\omega)] = 0 \quad (7.29)$$

It is important to remember that we obtained the $\partial[\omega\Psi_0(\omega)]/\partial\omega$ term by properly transforming the term $\partial\Psi_0(J)/\partial J$, a simple derivative in the canonical action variable. Extreme care is therefore needed in using the properly canonical variables in our Hamiltonian–Vlasov formulation of the beam response.

If the frequency Ω falls within a revolution Schottky band of the beam or if the bands overlap so that Ω falls within more than one such band, the real part of \tilde{B}_{\parallel} will be non-zero but it will consist of only the contributions from the singularities of $\cot[\pi(\Omega/\omega)]$, given by the usual $(-i\pi)$ times the Cauchy residues. This is so because of Eq. (7.29) and the fact that the principal value term adds an imaginary part only. These singularities occur for each ω_k that satisfies

$$\frac{\Omega}{\omega_k} = k \quad \text{or} \quad \omega_k = \frac{\Omega}{k}, \quad k = 0, \pm 1, \pm 2, \dots, \text{etc.} \quad (7.30)$$

Introducing the real number variable σ by

$$\frac{\Omega}{\omega} = \sigma, \quad d\omega = -\frac{d\sigma}{\sigma^2} \Omega \quad (7.31)$$

we notice that $\cot(\pi\sigma) \xrightarrow{\sigma \rightarrow k} [\pi(\sigma-k)]^{-1}$ near these poles. The contributions from the residues of $\cot(\pi\sigma)$ are thus obtained by replacing it by $-i\pi\delta(\sigma-k)\cdot(1/\pi) = -i\delta(\sigma-k)$. For a small total spread in $\Delta\omega$, i.e. $(\Delta\omega/\omega_0) \ll 1$, one verifies that the real part is given approximately by (neglecting the Ψ_0 term)

$$\text{Re } \tilde{B}_{\parallel}(\Omega) \cong -\frac{N}{2} \Omega \omega_0 \frac{\partial\Psi(\Omega)}{\partial\Omega}, \quad (7.32)$$

where $\Psi(\Omega) = \sum_k (1/|k|) \Psi_0(\Omega/k)$ and $\partial\Psi(\Omega)/\partial\Omega$ are the total normalized distribution and its derivative in actual frequency space with overlapping bands as in (3.37) and thus includes a summation over all overlapping bands. For non-overlapping bands, the real part is zero for frequencies outside the Schottky bands since $\partial\Psi(\Omega)/\partial\Omega = 0$ in that case. Since $\Psi(\Omega)$ is proportional to the total longitudinal Schottky fluctuation power density of the beam [see Eqs. (3.37) and (3.42)], Eq. (7.32) is a relation between the dissipative real part of the beam response and fluctuation power. It is a special case of the Fluctuation–Dissipation relationship to be studied in Section 14.

A similar analysis may be performed for the transverse response of a continuous coasting beam. The BTF will relate the transverse position modulation $\tilde{D}(\Omega)$ of the beam at the pick-up $\theta = \theta_P$ caused by a small sinusoidal angular excitation $\tilde{\alpha}(\Omega)$, at the kicker $\theta = \theta_K$, of the transverse trajectory of the beam. We define a normalized, dimensionless BTF at frequency Ω by

$$\tilde{B}_{\perp}(\Omega | \theta_P, \theta_K) = -\frac{\tilde{D}(\Omega)}{\tilde{\alpha}(\Omega)} \cdot \frac{N}{\sqrt{\beta_P \beta_K}} \cdot e^{i\Omega\tau_c}, \quad (7.33)$$

where β_P and β_K are the usual lattice beta-functions at the location of the pick-up and kicker respectively and τ_c the electronic delay of the cable in the transfer line from PU to A and B to K, as before. So defined the BTF is independent of the transverse lattice property $\beta(s)$ which measures the sensitivity of transverse betatron oscillation amplitudes as a function of azimuthal position in the ring ($\sqrt{\beta_P \beta_K}$ in the denominator cancels this dependence), is proportional to the total number of particles in the beam as expected for coherent response and has a positive real part. Note that

$\tilde{\alpha}(\Omega)$ is related to the transverse force $\tilde{F}_\perp(\Omega)$ applied at the kicker. A similar computation^{35,36)} then yields

$$\begin{aligned} \tilde{B}_\perp(\Omega | \theta_P, \theta_K) &= i \frac{N}{4} e^{-i\Omega(2\pi\alpha/\omega_0 - \tau_c)} \int_0^\infty d\omega \cdot \Psi_0(\omega) C(\Omega, \omega) \\ &\times \left\{ e^{i2\pi Q\alpha_2} \left[1 + i \cot \pi \left(\frac{\Omega}{\omega} + Q \right) \right] - e^{-i2\pi Q\alpha_2} \left[1 + i \cot \pi \left(\frac{\Omega}{\omega} - Q \right) \right] \right\}, \end{aligned} \quad (7.34)$$

where $\alpha_2 = 1 - (\mu/2\pi Q)$, α and $C(\Omega, \omega)$ the same as for the longitudinal case, Q being the betatron tune and μ the betatron phase at the PU, counted from the kicker, i.e. betatron phase-advance from kicker to PU, with

$$\mu' = \frac{d\mu}{ds} = \frac{1}{\beta(s)}, \quad (7.35)$$

$$\mu = \int_{\substack{s=0 \\ \theta=\theta_K}}^{\substack{s \\ \theta=\theta_P}} \frac{ds}{\beta(s)}; \quad \mu = 2\pi Q \quad \text{at} \quad s = 2\pi R_{av}. \quad (7.36)$$

For zero distance between pick-up and kicker, $\alpha_2 = 0$ and the real terms inside the integral cancel out. In that case we also have $\alpha = (\theta_K - \theta_P)/2\pi = 0$ so that $C(\Omega, \omega) \exp[i\Omega(2\pi\alpha/\omega_0)] \equiv 1$. We then find

$$\tilde{B}_\perp(\Omega) = -\frac{N}{4} e^{i\Omega\tau_c} \int_0^\infty d\omega \cdot \Psi_0(\omega) \left[\cot \pi \left(\frac{\Omega}{\omega} + Q \right) - \cot \pi \left(\frac{\Omega}{\omega} - Q \right) \right]. \quad (7.37)$$

On the other hand if the PU and kicker belong to a stochastic cooling loop^{35,36)}, then $(2\pi\alpha/\omega_0) = (\theta_K - \theta_P)/\omega_0 = \tau_c$ and μ is an odd multiple of $\pi/2$ for optimum betatron cooling so that $\alpha_2 = [k + (1/2)]/2Q$, k being an integer. The real terms inside the integral then add up and we get

$$\begin{aligned} \tilde{B}_\perp(\Omega) &= -(-1)^k \cdot \frac{N}{4} \int_0^\infty d\omega \cdot \Psi_0(\omega) C(\Omega, \omega) \left[2 + i \cot \pi \left(\frac{\Omega}{\omega} + Q \right) \right. \\ &\quad \left. + i \cot \pi \left(\frac{\Omega}{\omega} - Q \right) \right]. \end{aligned} \quad (7.38)$$

The longitudinal irregularity of the lattice characterized by the local lattice properties λ and α_1 do not modify this transverse response in contrast to the longitudinal case. If there is finite non-zero dispersion at the pick-up, we again have to include a sensitivity function $P(\Omega, \omega)$ inside the integral and with non-zero chromaticity one has to take into account the variation of the betatron tune with its longitudinal energy or revolution frequency.

The absorption of energy or dissipation induced by the external force at the kicker is proportional to the real part of $\tilde{D}(\Omega)\tilde{\alpha}(\Omega) \propto \tilde{D}(\Omega) \cdot \tilde{F}_\perp^K(\Omega) = -i\Omega\tilde{D}(\Omega) \cdot \tilde{F}_\perp(\Omega)$, where $\tilde{D}(\Omega)$ is proportional to the transverse velocity of the coherent motion, at the kicker. It is thus obvious that if we consider the full ring transverse beam transfer function $\tilde{B}_\perp(\Omega)$ as in Eq. (7.37), it is the imaginary part of $\tilde{B}_\perp(\Omega)$ that is 'resistive' or 'dissipative', representing a motion in which the velocity $\propto \tilde{D}(\Omega) = -i\Omega\tilde{D}(\Omega)$ is in phase with the force $\tilde{F}_\perp(\Omega)$ or $\tilde{\alpha}(\Omega)$, so that there is steady absorption of energy by the set of oscillating and resonating particles in the beam from the applied force. The real part of $\tilde{B}_\perp(\Omega)$ is

reactive and describes forced oscillations of the beam particles at frequency Ω with no net absorption of energy. We will discuss the physical mechanism of these two parts in some more detail when discussing Landau damping in Section 13.

The situation is different for the transverse beam transfer function $\tilde{\mathbf{B}}_{\perp}(\Omega)$ that describes the situation of stochastic cooling, as given by Eq. (7.38). Here since the pick-up is placed an odd multiple of quarter betatron wavelengths upstream from the kicker, a dipole position modulation at the PU corresponds to an equivalent dipole transverse velocity modulation of betatron motion at the kicker. Since energy absorption is given by $\text{Re} [\tilde{\mathbf{D}}(\Omega) \cdot \tilde{\mathbf{F}}_{\perp}^{\mathbf{K}}(\Omega)]$ at the kicker only, it is obvious that it is the real part of $\tilde{\mathbf{B}}_{\perp}(\Omega)$, as applicable to a stochastic cooling situation and given by Eq. (7.38), that is 'resistive', in contrast to the full ring beam transfer function (7.37).

If we assume $C(\Omega, \omega) = 1$ in Eq. (7.38), i.e. the longitudinal phase-mixing $\Delta\phi(\Omega, \omega)$ between the PU and kicker is zero (or very small), and assume that k is even, the first term in Eq. (7.38) gives a contribution of $-N/2$ to the real part of $\tilde{\mathbf{B}}_{\perp}(\Omega)$. Similar to the longitudinal case, the contribution to the real part from the second and third terms in Eq. (7.38) comes from the singularities of $\cot \pi[(\Omega/\omega) \pm Q]$, which occur for each ω_k that satisfies

$$\frac{\Omega}{\omega_k} \pm Q = k \quad \text{or} \quad \omega_k = \frac{\Omega}{[k \mp Q]} \quad k = 0, \pm 1, \pm 2, \dots \text{ etc.} \quad (7.39)$$

Each contribution is $[\Psi_0(\omega_k) \cdot \Omega / 4(k \mp Q)^2]$. As in the longitudinal case, for a small spread in $\Delta\omega$, i.e. $\Delta\omega/\omega_0 \ll 1$, one obtains the real part to be given approximately by

$$\text{Re} [\tilde{\mathbf{B}}_{\perp}(\Omega)] = \frac{\Psi(\Omega)\omega_0}{4} - \frac{N}{2}, \quad (7.40)$$

where

$$\Psi(\Omega) = \sum_{n=-\infty}^{+\infty} \sum_{(\pm)} \frac{1}{|n \pm Q_f|} \Psi_0 \left(\frac{\Omega}{n \pm Q_f} \right) \quad (7.41)$$

is the total density or normalized distribution at a frequency Ω in actual betatron frequency space with overlapping betatron bands as in Eq. (3.63) and hence includes a summation over overlapping bands. It is a measure of the transverse Schottky fluctuation power and Eq. (7.40) is again a special Fluctuation-Dissipation relation.

For beam transfer function relevant to a stochastic cooling system then, the real part corresponding to dissipation as given by Eq. (7.40) is not zero for frequencies Ω outside the betatron bands for non-overlapping bands [$\Psi(\Omega) = 0$] but is given by $-N/2$, in contrast to the longitudinal case of Eq. (7.32) where it is zero. However, as is evident from Eq. (7.37), this term $-N/2$ in Eq. (7.40) disappears for a full ring beam transfer function with $\theta_P = \theta_K$ and is a peculiarity of the restricted spacing between PU and kicker for stochastic cooling only. This, however, has significant implications for optimum cooling³⁶⁾.

For symmetrical distributions $\Psi_0(\omega)$ in angular velocities ω within the beam, the real and imaginary parts and the amplitude and phase of the full ring ($\theta_P = \theta_K$) longitudinal and transverse beam transfer functions $\tilde{\mathbf{B}}_{\parallel}(\Omega)$ and $\tilde{\mathbf{B}}_{\perp}(\Omega)$ for non-overlapping bands around revolution harmonics $\Omega = n\omega_0$ (longitudinal) and betatron harmonics $\Omega^* = (n \pm Q_f)\omega_0$ (transverse), typically look as shown in Fig. 26^{20,22,31,37-39)}. Note the phase jump of $2\pi \equiv 360^\circ$ as one fully crosses a revolution band and the phase jump of $\pi \equiv 180^\circ$ as one fully crosses a single betatron band, either 'fast' or

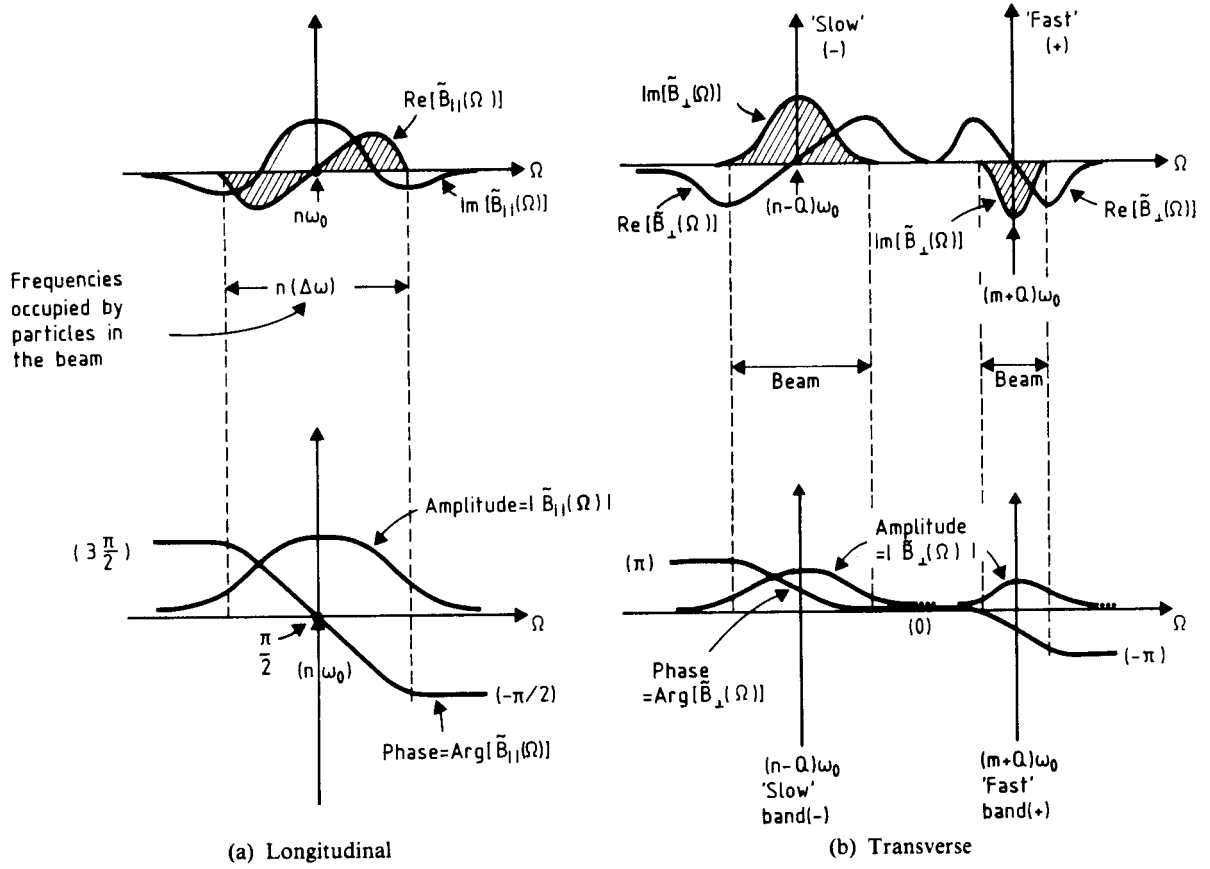

Fig. 26 Real-imaginary and amplitude-phase diagrams of longitudinal and transverse response of continuous coasting beams as function of exciting frequency Ω

'slow'. The total phase jump for transverse response as one fully crosses a 'slow' betatron band and then the adjacent 'fast' betatron band is again $2\pi \equiv 360^\circ$. For narrow non-overlapping bands, the real part of $\tilde{B}_\perp(\Omega)$ will then pass through zero in the centre of the symmetrical distribution, since only one of the fast or slow waves will dominate. However, if the bands are wide, the effect of the slow wave on the fast wave and vice versa is non-negligible. The effect of one of the terms on the other in Eq. (7.37) will not be negligible and this will cause the zero-crossing to shift away from the centre of the distribution (unless Q_f is an integer multiple of 0.25). For response in a stochastic cooling configuration, the real and imaginary parts in the transverse response should be interchanged. For broad bands then, according to Eq. (7.40), the response outside the bands is not purely reactive and the total phase-jump across a betatron band will be more than 180° as usual for narrow bands with only the first term in Eq. (7.40) dominating. The second term in Eq. (7.40) is equally important for broad bands. For fully overlapping bands, one has $\Psi = 2N/\omega_0$ and $\text{Re } \tilde{B}_\perp(\Omega) = 0$ in this situation for stochastic cooling.

The curves traced out by the response function $\tilde{B}(\Omega)$ and its inverse $[\tilde{B}(\Omega)]^{-1}$ in the complex $\tilde{B}(\Omega)$ and $[\tilde{B}(\Omega)]^{-1}$ planes, as Ω passes through the relevant frequency bands, are known as the Nyquist diagram and the stability diagram respectively. These are shown in Fig. 27(a) and (b) for the longitudinal and transverse responses as correspond to those given in Fig. 26. Note the odd orientation of the real and imaginary axes for the transverse case, as demanded by convention in the literature. One can understand this convention simply by noting that the horizontal axis is always the dissipative or resistive part of the response and the vertical axis the reactive part of the response. In Fig. 26, the sharp range in frequency determined by the phase-jump of the

phase-curve is a precise measure of the range of frequencies harmonically generated by the beam particles; in other words it is a direct measure of the beam frequency spread.

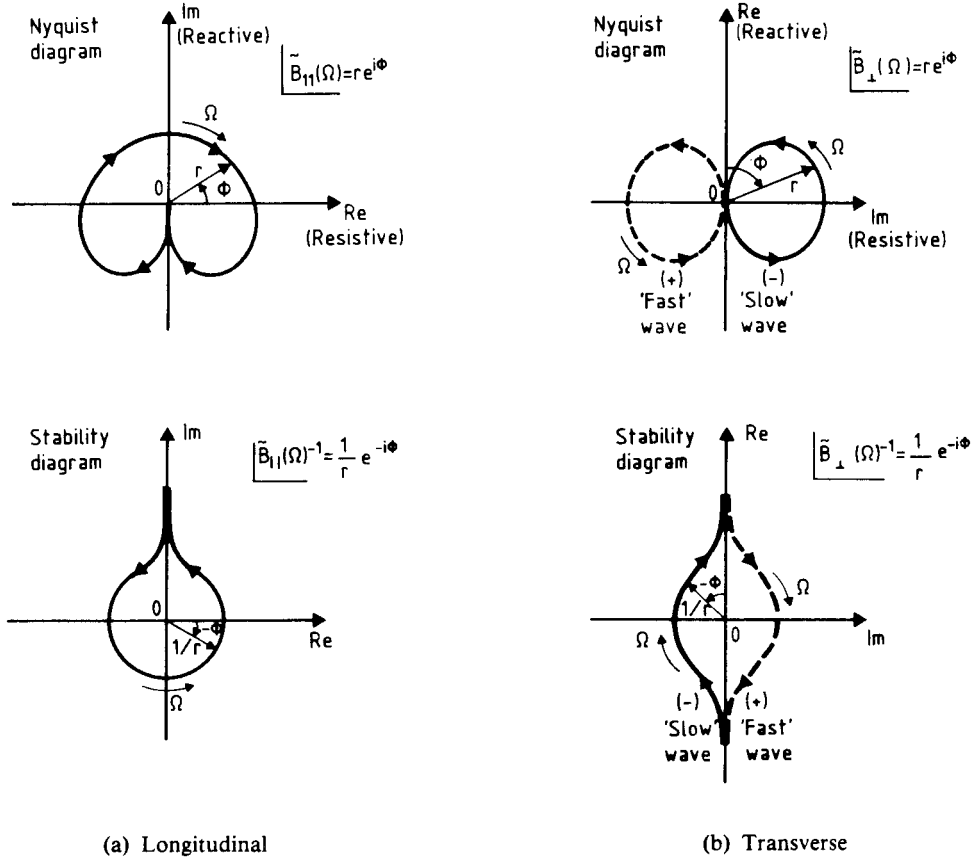

Fig. 27 Nyquist and stability diagrams for longitudinal and transverse response of a continuous coasting beam

Response of bunched beams is a more involved and subtle subject and a detailed analysis is beyond the scope of this report. We only discuss it briefly to give a flavour of the peculiarities. We define the longitudinal BTF of a bunched beam to relate the induced current $\tilde{I}_P(\Omega')$ at $\theta = \theta_P$ to the imposed voltage $\tilde{V}_K(\Omega)$ at $\theta = \theta_K$. A Vlasov response formalism according to Section 6 shows that^{7,40)}

$$\tilde{I}_P(\Omega) = \sum_{k=-\infty}^{\infty} \tilde{\mathcal{R}}_{\parallel}^k(\Omega | \theta_P, \theta_K) \tilde{V}_K(\Omega + k\omega_0), \quad (7.42)$$

where

$$\tilde{\mathcal{R}}_{\parallel}^k(\Omega | \theta_P, \theta_K) = (-i) \frac{Nq^2 \omega_0^2 k}{2\pi} \lim_{\gamma \rightarrow 0^+} \int_0^{\infty} da \cdot \left[\frac{d\Psi_0(a)}{da} \right] \sum_{\substack{n=-\infty \\ \neq 0}}^{+\infty} \sum_{\mu=-\infty}^{+\infty} \left(\frac{\mu}{n} \right) \\ \times \frac{J_{\mu}[(n-k)a] J_{\mu}(na) e^{-in(\theta_P - \theta_K)}}{[\Omega - (n-k)\omega_0 - \mu\omega_s(a) + i\gamma]} e^{-ik\theta_K} \quad (7.43)$$

The amplitude variable 'a' of longitudinal synchrotron oscillations is simply $a \propto \sqrt{2J}$ in the quasi-linear approximation where J is the synchrotron oscillation action. The current perturbation above is calculated by multiplying the perturbed phase-space density by ω_0 only, thus neglecting second-order modulations due to $\Delta\omega$ which we would obtain if we multiplied by $\omega = \omega_0 + \Delta\omega$.

Similarly the transverse BTF, defined to relate the induced dipole-moment current density $\tilde{D}_P(\Omega)$ at θ_P to applied force per unit charge $\tilde{E}_K(\Omega)$ at θ_K , is given by a relation similar to Eq. (7.42) with^{7,40)}

$$\begin{aligned} \tilde{\mathcal{R}}_1^k(\Omega | \theta_P, \theta_K) &= -\frac{qI_0 N}{2m_0 \gamma_r Q \omega_0} \lim_{\gamma \rightarrow 0^+} \int_0^\infty da \cdot \Psi_0(a) \\ &\quad \sum_{n=-\infty}^{+\infty} \sum_{\mu(\pm)} J_\mu \left[(n \pm Q - Q \frac{\xi}{\eta}) a \right] J_\mu \left[(n - k \pm Q - Q \frac{\xi}{\eta}) a \right] \\ &\quad \frac{e^{-in(\theta_P - \theta_K)} e^{-k\theta_K}}{[\Omega - (n - k \pm Q)\omega_0 - \mu\omega_s(a) + i\gamma]} \end{aligned} \quad (7.44)$$

where $I = qf_0$, m_0 the rest mass of particles and γ_r the relativistic gamma factor. The response for the $k = 0$ terms in Eqs. (7.43) and (7.44) can be simplified by an exact summation over μ by using the identities^{26,41)}

$$S_\nu(x) = \sum_{\mu=-\infty}^{+\infty} \frac{\mu J_\mu^2(x)}{[\mu - \nu]} = S^{(1)}(x) + \nu S_\nu^{(2)}(x), \quad (7.45)$$

$$S^{(1)}(x) = \sum_{\mu=-\infty}^{+\infty} J_\mu^2(x) = 1, \quad (7.46)$$

$$S_\nu^{(2)}(x) = \sum_{\mu=-\infty}^{+\infty} \frac{J_\mu^2(x)}{[\mu - \nu]} = -\pi [\sin(\pi\nu)]^{-1} J_\nu(x) J_{-\nu}(x), \quad (7.47)$$

to give

$$\begin{aligned} \tilde{\mathcal{R}}_{\parallel}^{k=0}(\Omega | \theta_P, \theta_K) &= (-i) \frac{Nq^2 \omega_0^2 K}{2\pi} \int_0^\infty da \cdot \left[\frac{d\Psi_0(a)}{da} \right] \frac{1}{\omega_s(a)} \sum_{\substack{n=-\infty \\ \neq 0}}^{+\infty} \frac{e^{-in(\theta_P - \theta_K)}}{n} \\ &\quad \times \left[1 - \pi \nu_n(a) \frac{J_{\nu_n(a)}^{(na)} J_{-\nu_n(a)}^{(na)}}{\sin[\pi \nu_n(a)]} \right] \end{aligned} \quad (7.48a)$$

and

$$\begin{aligned} \tilde{\mathcal{R}}_1^{k=0}(\Omega | \theta_P, \theta_K) &= -\frac{qI_0 N \pi}{2m_0 \gamma_r Q \omega_0} \int_0^\infty da \cdot \Psi_0(a) \frac{1}{\omega_s(a)} \sum_{n(\pm)} [\sin(\pi \nu_n^{(\pm)}(a))]^{-1} \\ &\quad \times J_{\nu_n^\pm(a)} \left[(n \pm Q - Q \frac{\xi}{\eta}) a \right] J_{-\nu_n^\pm(a)} \left[(n \pm Q - Q \frac{\xi}{\eta}) a \right] e^{-in(\theta_P - \theta_K)}, \end{aligned} \quad (7.48b)$$

where

$$v_n(a) = \frac{\Omega - n\omega_0}{\omega_s(a)} \quad \text{and} \quad v_n^{(\pm)}(a) = \frac{\Omega - (n \pm Q)\omega_0}{\omega_s(a)} . \quad (7.49)$$

Similar to the analysis from Eq. (3.119) to (3.128) in Section 3, we may also write Eqs. (7.48) and (7.49) as

$$\tilde{\mathcal{R}}_n^{k=0}(\Omega | \theta_P, \theta_K) = (-i) \frac{Nq^2\omega_0^2 K}{2\pi} \lim_{\gamma \rightarrow 0^+} \sum_{\substack{n=-\infty \\ \neq 0}}^{+\infty} \int d\omega \frac{[\partial \Psi_0^n(\omega) / \partial \omega]}{[\Omega - n\omega + i\gamma]} e^{-in(\theta_P - \theta_K)} \quad (7.50)$$

and

$$\tilde{\mathcal{R}}_{\pm}^{k=0}(\Omega | \theta_P, \theta_K) = -\frac{qI_0 N}{2m_0 \gamma_r \omega_0 Q} \lim_{\gamma \rightarrow 0^+} \sum_n \sum_{(\pm)} \int d\omega \frac{\psi_0^{n, \pm}(\omega)}{[\Omega - (n \pm Q)\omega + i\gamma]} e^{-in(\theta_P - \theta_K)}, \quad (7.51)$$

where

$$\psi_0^{n, \pm}(\omega) = \sum_{\substack{\mu=-\infty \\ \neq 0}}^{+\infty} \frac{1}{\mu} g_0 \left(\frac{(n \pm Q)(\omega - \omega_0)}{\mu} \right) \left[J_{\mu}^2 \left[(n \pm Q - Q \frac{\xi}{\eta}) a(\omega_s) \right] \frac{da(\omega_s)}{d\omega_s} \right]_{\omega_s = \frac{(n \pm Q)(\omega - \omega_0)}{\mu}} \quad (7.52)$$

and

$$\frac{\partial \psi_0^n(\omega)}{\partial \omega} = \sum_{\mu=-\infty}^{+\infty} \frac{1}{n} \left[J_{\mu}^2(na(\omega_s)) \frac{da(\omega_s)}{d\omega_s} \frac{dg_0(\omega_s)}{d\omega} \right]_{\omega_s = \frac{n(\omega - \omega_0)}{\mu}} . \quad (7.53)$$

Here $g_0(\omega_s)$ is the particle distribution in synchrotron frequency $\Psi_0(a) da \equiv \mathbf{g}(\omega_s) d\omega_s$, and $a(\omega_s)$ the synchrotron oscillation amplitude as a function of synchrotron frequency. The terms $\Psi_0^{n, \pm}(\omega)$ and $\partial \Psi_0^n(\omega) / \partial \omega$ may be interpreted as the effective distribution in revolution frequencies and its slope respectively in an equivalent coasting continuous beam description, as far as the $(n \pm Q)$ betatron bands and the n^{th} revolution band are concerned.

In the region of non-overlapping betatron or revolution bands but overlapping synchrotron bands [large spread in synchrotron frequencies ($\Delta\omega_s$)], the amplitude characteristic of bunched beam response is similar to that for continuous coasting beams as in Figs. 26 and 27. For very small spread $\Delta\omega_s$, synchrotron side-bands are separate and non-overlapping and the same pattern repeats for each synchrotron side-band separately. In this situation of non-overlapping synchrotron bands, one can actually excite each synchrotron mode in the beam separately. One can then measure the transfer function of the synchrotron dipole mode, quadrupole mode, etc. individually. The phase characteristic of the BTF for bunches is however more subtle. Typically it will have a sharp discontinuity at a frequency corresponding to particles near the bunch centre for a non-overlapping synchrotron band. In general, it is quite complicated^{29,30,49}.

8. THE COLLECTIVE FORCES

The details of the electromagnetic fields produced by collective interaction of the beam with itself and its environment are usually quite complicated and require solving the full set of Maxwell's equations with boundary conditions in a complicated geometry of the beam-storage-ring system^{29,30,42}. For our purposes it will suffice to describe the collective interaction in all generality by a causal Green's function or propagator relating perturbations in beam physical observables at an azimuth θ' in the storage ring at time t' to the resulting collective fields generated at azimuth θ at time t . Since the storage ring is fixed during any specific operation, the collective fields will be generated by time-invariant elements in the ring predominantly. The collective propagator is thus a function of $(t - t')$ alone, due to translational invariance in time. However, the electromagnetically susceptible elements may be non-uniformly distributed in lumped fashion all around the ring, except for the case where the only such element is the smooth and uniform vacuum chamber wall of the storage ring. The propagator will thus be a general complicated function of θ and θ' . We will however consider, for the moment, a smoothed-out propagator, obtained after averaging over the rapidly varying lumpiness along the storage ring circumference. The propagator then becomes a function of $(\theta - \theta')$ alone implying rotational symmetry after 'smoothing'.

We will thus represent the smooth transverse collective force $F(\theta, t)$ in any transverse direction (x or z) at azimuth θ at time t as

$$\frac{F(\theta, t)}{\gamma_r m} = \frac{q}{(2\pi)} \int_{-\infty}^t dt' \int_0^{2\pi} d\theta' g_{\perp}(\theta - \theta'; t - t') D(\theta', t') \quad (8.1)$$

$$= \frac{iq\omega_0}{(2\pi)^2 m \gamma_r c} \int_{-\infty}^t dt' \int_0^{2\pi} d\theta' z_{\perp}(\theta - \theta'; t - t') d(\theta', t') , \quad (8.2)$$

where $D(\theta', t')$ and $d(\theta', t')$ are the transverse dipole-moment *charge* density and the transverse dipole-moment *current* respectively of the beam at (θ', t') , in the laboratory frame, m the rest mass of the particles, γ_r the relativistic gamma factor, ω_0 the angular revolution frequency of a nominal reference particle in the beam and q the charge of the particles. The upper limit of the t' -integration is t , since the collective propagator is expected to be causal, i.e. $g_{\perp}(\theta - \theta'; t - t') = 0$ for $t' > t$. It can be formally extended to $+\infty$ only by imposing this crucial causality condition. Fourier series expanding in the 2π -periodic angle variable θ and Fourier-transforming to the frequency domain Ω we obtain

$$\tilde{F}_n(\Omega) = (\gamma_r m) q \tilde{g}_{\perp, n}(\Omega) \tilde{D}_n(\Omega) = i \frac{q\omega_0}{2\pi c} \tilde{z}_{\perp, n}(\Omega) \tilde{d}_n(\Omega) , \quad (8.3)$$

where

$$\tilde{g}_{\perp, n}(\Omega) = \frac{1}{2\pi} \int_0^{2\pi} d\theta \int_0^{\infty} d\tau g_{\perp}(\theta, \tau) e^{-in\theta + i\Omega\tau} \quad (8.4)$$

and similarly for $\tilde{Z}_{\perp,n}(\Omega)$. Note that we may also write the proportionality constant in front of $\tilde{Z}_{\perp,n}(\Omega)$ as $(q\omega_0/2\pi c) = (q\beta/2\pi R)$, conforming with conventional usage³⁰⁾, where $\beta = v/c$ and R the average radius of the storage ring. Remembering that $\tilde{d}_n(\Omega) = \omega_0 \tilde{D}_n(\Omega)$ for zeroth-order dipole-moment current, we see that the quantity $\tilde{Z}_{\perp,n}(\Omega)$ is related to $\tilde{g}_{\perp,n}(\Omega)$ as

$$\tilde{g}_{\perp,n}(\Omega) = i \frac{\omega_0^2}{2\pi m \gamma_r c} \tilde{Z}_{\perp,n}(\Omega) \quad (8.5)$$

and has units of ohms/metre. It corresponds to the standard definition of transverse collective impedance of the beam-storage-ring system³⁰⁾. The quantity $\tilde{g}_{\perp,n}(\Omega)$ has units of $(\text{coulomb}\cdot\text{sec})^{-2}$. All the details of the transverse collective beam-storage-ring interaction are thus hidden in the harmonic and frequency structure of the transverse coupling impedance $\tilde{Z}_{\perp,n}(\Omega)$ or equivalently of $\tilde{g}_{\perp,n}(\Omega)$, both of which are complex quantities in general.

This transverse collective force can be incorporated into the single-particle Hamiltonian by an additional interaction Hamiltonian $\mathcal{H}_I = -\mathbf{x}F$:

$$\mathcal{H}(\vec{I}, \vec{\psi}; t) = \mathcal{H}_0(\vec{I}) + \mathcal{H}_I(\vec{I}, \vec{\psi}; t) = \mathcal{H}_0 - \mathbf{x}F(\theta, t), \quad (8.6)$$

where

$$\mathcal{H}_I(\vec{I}, \vec{\psi}; t) = -\mathbf{x}F(\theta, t) = -\mathbf{x}(I_x, \phi_x)F[\theta(J, \psi), t] \quad (8.7)$$

and \mathcal{H}_0 is the unperturbed Hamiltonian in the absence of collective interactions. Note that F depends on the beam dipole-moment charge density D which is a functional of the beam phase-space distribution $\Psi(\vec{I}, \vec{\psi}; t)$:

$$D(\theta, t) = D[\Psi] = q \iint d\vec{I} d\vec{\psi} \mathbf{x}(I_x, \phi_x) \Psi(\vec{I}, \vec{\psi}; t) \delta[\theta - \theta(J, \psi)] \quad (8.8)$$

Thus for studying the self-consistent evolution of the whole beam, the above single-particle Hamiltonian is not enough and must be supplemented with a 'law of flow' of Ψ in phase space, e.g. the Vlasov equation, used in Section 6.

The interaction Hamiltonian can be written down in terms of phase-space coordinates of all the particles by writing the beam dipole moment as

$$D(\theta, t) = q \sum_{j=1}^N \sum_{n=-\infty}^{+\infty} \mathbf{x}_j(t) \delta[\theta - \theta_j(t) - 2\pi n] = \sum_{n=-\infty}^{+\infty} D_n(t) e^{in\theta}, \quad (8.9)$$

where

$$D_n(t) = \frac{q}{2\pi} \sum_{j=1}^N \mathbf{x}_j(t) e^{-in\theta_j(t)} \quad (8.10)$$

For continuous coasting beams we can use the orbits $\theta_j(t) = \omega_j t + \theta_j^0$ and $x_j(t) = A_j \cos \phi_j(t)$ where $\phi_j(t) = Q\omega_j t + \phi_j^0$. It is easy then to verify that the transverse force (collective) can be written down as

$$F[\theta_i(t), t] = q^2 \frac{(\gamma_r m)}{4\pi} \sum_{j=1}^N \sum_{n=-\infty}^{+\infty} \sum_{(\mp)} A_j \tilde{g}_{\perp, n} [(n\mp Q)\omega_j] e^{in[\theta_i(t) - \theta_j(t)]} e^{\pm i\phi_j(t)} \quad (8.11)$$

and the interaction Hamiltonian is given by

$$\mathcal{H}_I(i) = \sum_{j=1}^N v(i, j), \quad (8.12)$$

where

$$\begin{aligned} v(i, j) &= -\frac{q^2}{8\pi} (\gamma_r m) \sum_{n=-\infty}^{+\infty} \sum_{(\mp)} A_i A_j \tilde{g}_{\perp, n} [(n\mp Q)\omega_j] e^{in[\theta_i(t) - \theta_j(t)]} \\ &\quad \times [e^{i\phi_i(t)} + e^{-i\phi_i(t)}] e^{\pm i\phi_j(t)} \\ &= -i \frac{q^2 \omega_0^2}{16\pi^2 c} \sum_{n=-\infty}^{+\infty} \sum_{(\mp)} A_i A_j \tilde{z}_{\perp, n} [(n\mp Q)\omega_j] e^{in[\theta_i(t) - \theta_j(t)]} \\ &\quad \times [e^{i\phi_i(t)} + e^{-i\phi_i(t)}] e^{\pm i\phi_j(t)} \quad (8.13) \end{aligned}$$

We recognize Eq. (8.13) immediately as the harmonic decomposition of the interaction Hamiltonian in amplitude-phase variables, as expressed generally in action-angle harmonic decomposition by Eq. (A.5) in Appendix A. For a bunched beam, we would obtain

$$v(i, j) = \sum_{\mu} \sum_{\mu'} \sum_{(\mp)}^{+\infty} v_{\mu\mu'}^{(\mp)}(i, j) e^{i\mu\psi_i(t) + i\mu'\psi_j(t)} [e^{i\phi_i(t)} + e^{-i\phi_i(t)}] e^{\pm i\phi_j(t)}, \quad (8.14)$$

where

$$v_{\mu\mu'}^{(\mp)}(i, j) = -i \frac{q^2 \omega_0^2}{16\pi^2 c} \sum_{n=-\infty}^{+\infty} A_i A_j J_{\mu} [(n\mp Q) a_i] J_{\mu'} [(-n\mp Q) a_j] \tilde{z}_{\perp, n} [(n\mp Q)\omega_0 - \mu'\omega_s(a_j)] \quad (8.15)$$

The ordinary Bessel functions $J_\mu(x)$ appear due to the Fourier harmonic decomposition of azimuthal harmonics in the ring in synchrotron oscillation action-angle variables, as in Eq. (3.73). The effect of the machine chromaticity can be included by replacing the arguments $[(n \pm Q)a]$ of the Bessel functions by $[(n \pm Q)a - Q(\xi/\eta)a]$.

Similarly we will represent the smooth longitudinal collective force $F_{\parallel}(\theta, t) = qE_{\parallel}(\theta, t)$ at azimuth θ at time t (where E_{\parallel} is the equivalent longitudinal electric field) as

$$F_{\parallel}(\theta, t) = qE_{\parallel}(\theta, t) = q \int_{-\infty}^{+t} dt' \int_0^{2\pi} d\theta' g_{\parallel}(\theta - \theta'; t - t') I(\theta', t') \quad (8.16)$$

$$= -\frac{q}{2\pi R} \int_{-\infty}^{+t} dt' \int_0^{2\pi} d\theta' z_{\parallel}(\theta - \theta'; t - t') I(\theta', t'), \quad (8.17)$$

where $I(\theta', t')$ is the longitudinal current of the beam at (θ', t') in the laboratory frame and R the average radius of the storage ring. Again in the domain of frequency and angular harmonics

$$\tilde{F}_{\parallel, n}(\Omega) = q\tilde{E}_{\parallel, n}(\Omega) = (2\pi)q\tilde{g}_{\parallel, n}(\Omega)\tilde{I}_n(\Omega) = -\frac{q}{R}\tilde{z}_{\parallel, n}(\Omega)\tilde{I}_n(\Omega), \quad (8.18)$$

where

$$\tilde{g}_{\parallel, n}(\Omega) = \frac{1}{2\pi} \int_0^{2\pi} d\theta \int_0^{\infty} d\tau g_{\parallel}(\theta, \tau) e^{-in\theta + i\Omega\tau} \quad (8.19)$$

and similarly for $\tilde{z}_{\parallel, n}(\Omega)$. The quantity $\tilde{z}_{\parallel, n}(\Omega)$ has units of ohms. It corresponds to the standard definition of longitudinal coupling impedance of the beam-storage-ring system²⁹⁾. The quantity $\tilde{g}_{\parallel, n}(\Omega)$ given by

$$\tilde{g}_{\parallel, n}(\Omega) = -\frac{1}{2\pi R}\tilde{z}_{\parallel, n}(\Omega) \quad (8.20)$$

has units of ohms/metre. Again all the details of the longitudinal collective interaction are embedded in the harmonic and frequency structure of the longitudinal coupling impedance $\tilde{z}_{\parallel, n}(\Omega)$ or equivalently $\tilde{g}_{\parallel, n}(\Omega)$, complex quantities in general. It is often useful to define a collectively induced longitudinal voltage $V(\theta, t) = 2\pi R E_{\parallel}(\theta, t)$. Then

$$V(\theta, t) = - \int_{-\infty}^{+t} dt' \int_0^{2\pi} d\theta' z_{\parallel}(\theta - \theta'; t - t') I(\theta', t') \quad (8.21)$$

and

$$\tilde{V}_n(\Omega) = -(2\pi)\tilde{z}_{\parallel, n}(\Omega)\tilde{I}_n(\Omega) \quad (8.22)$$

A similar analysis as for the transverse case yields for the interaction Hamiltonian of longitudinal collective interactions of continuous coasting beams

$$\mathcal{H}_I(i) = \sum_{j=1}^N v(i, j), \quad (8.23)$$

where

$$v(i, j) = (-i) \frac{q^2}{2\pi} \sum_{\substack{n=-\infty \\ \neq 0}}^{+\infty} \omega_j \frac{\tilde{Z}_{\parallel, n}(n\omega_j)}{n} e^{in[\theta_i(t) - \theta_j(t)]} \quad (8.24)$$

$$\approx (-i) \frac{q^2}{2\pi} \omega_0 \sum_{\substack{n=-\infty \\ \neq 0}}^{+\infty} \frac{\tilde{Z}_{\parallel, n}(n\omega_j)}{n} e^{in[\theta_i(t) - \theta_j(t)]} \left[1 + \mathcal{O}\left(\frac{\Delta\omega}{\omega_0}\right) \right], \quad (8.25)$$

ω_0 being the revolution angular velocity of a nominal reference particle. For a bunched beam we would obtain

$$v(i, j) = \sum_{\substack{\mu \\ (-\infty}}^{(+\infty)} \sum_{\substack{\mu' \\ (-\infty}}^{(+\infty)} v_{\mu\mu'}(a_i, a_j) e^{i\mu\psi_i(t) + i\mu'\psi_j(t)}, \quad (8.26)$$

where

$$v_{\mu\mu'}(a_i, a_j) \cong (-i) \frac{q^2 \omega_0}{2\pi} \sum_{n=-\infty}^{+\infty} \frac{\tilde{Z}_{\parallel, n}[n\omega_0 - \mu'\omega_s(a_j)]}{n} J_{\mu}(n a_i) J_{\mu'}(-n a_j) \left[1 + \mathcal{O}\left(\frac{\Delta\omega}{\omega_0}\right) \right] \quad (8.27)$$

All the above discussion is for a storage ring whose impedance is distributed uniformly and smoothly around the ring. The harmonic dependence of $\tilde{Z}_n(\Omega)$ on n is then essential in order to take into account the propagation of electromagnetic fields along the storage-ring-wall elements between (θ', t') and (θ, t) . The phase velocity of a longitudinal or transverse disturbance $\tilde{\xi}_n(\Omega) \times \exp(in\theta - i\Omega t)$ is Ω/n . If a particle in the beam has angular velocity $\omega = \Omega/n$, i.e. $\Omega = n\omega$, it will sample the generated collective wave field $\tilde{F}_n(\Omega) \exp(in\theta - i\Omega t)$ with a constant phase relationship all around the ring and accumulate a total non-zero energy gain (longitudinal) or a total non-zero amount of work done on it by the storage ring (transverse) in a single turn. Harmonics other than the resonating one will oscillate rapidly with respect to the particle and average to zero, thus contributing to no net energy gain or work done. The impedance function given by the constant of proportionality in $\tilde{F}_n(\Omega) \sim \tilde{Z}_n(\Omega) \tilde{\xi}_n(\Omega)$ may be sensitive to the particular harmonic n of the perturbation azimuthal wave in the storage ring for these propagating structures. Usually, however, collective interactions in conventional storage rings in the high-energy ultra-relativistic limit are

given by purely ‘local’ impedances, with no non-local propagation. However, these local impedances may be distributed uniformly all over the ring, i.e. they may not be localized. Then

$$\begin{aligned} Z_{\perp, \parallel}(\theta - \theta'; t - t') &= \delta(\theta - \theta') Z_{\perp, \parallel}(t - t'), \\ g_{\perp, \parallel}(\theta - \theta'; t - t') &= \delta(\theta - \theta') g_{\perp, \parallel}(t - t'), \end{aligned} \quad (8.28)$$

so that

$$\left(\widetilde{g}_{\perp, \parallel} \right)_n(\Omega) = (2\pi)^{-1} \widetilde{g}_{\perp, \parallel}(\Omega) \quad \text{and} \quad \left(\widetilde{Z}_{\perp, \parallel} \right)_n(\Omega) = (2\pi)^{-1} \widetilde{Z}_{\perp, \parallel}(\Omega) \quad (8.29)$$

In particular

$$\left(\widetilde{g}_{\perp, \parallel} \right)_n(n\omega_j) = (2\pi)^{-1} \widetilde{g}_{\perp, \parallel}(n\omega_j) \quad \text{and} \quad \left(\widetilde{Z}_{\perp, \parallel} \right)_n(n\omega_j) = (2\pi)^{-1} \widetilde{Z}_{\perp, \parallel}(n\omega_j) \quad (8.30)$$

Thus the impedance is independent of the azimuthal harmonic n . It can depend on n only through its dependence on the frequencies $\Omega_n = n\omega_j$ relevant for the beam. It also follows that

$$\widetilde{F}(\theta, \Omega) \sim \widetilde{Z}(\Omega) \widetilde{\xi}(\theta, \Omega) \quad (8.31)$$

for any θ , characteristic of local interaction. There are no induced fields until the particle in the beam passes through the structure, in the high-energy ultra-relativistic limit $\gamma_r \rightarrow \infty$. The fields produced at and after the passage of the particle will then ring and decay in time according to $g(t - t')$. The impedance function in these cases is simply proportional to the one-sided Fourier transform $\widetilde{g}(\Omega)$ of the so-called wake-function $g(t - t') \equiv g(\tau)$ (zero for $\tau < 0$)⁴². Most common in conventional storage rings are impedances which are not only local but are also sharply localized or lumped. Let us consider the effect of such a structure, say a resonating cavity, localized azimuthally at $\theta = \theta_K$ in the ring. The induced fields are produced at $\theta = \theta_K$ only and are derived from beam current at $\theta = \theta_K$ only. Thus:

$$\widetilde{F}(\theta_K, \Omega) \sim \widetilde{Z}(\Omega) \widetilde{\xi}(\theta_K, \Omega) \quad (8.32)$$

valid at $\theta = \theta_K$ only and no other θ . The impedance $\widetilde{Z}(\Omega)$ again is simply related to the Fourier transform of the wake-function of the cavity. For more than one such localized structure one has to simply sum the relevant impedances $\widetilde{Z}_{\perp, \parallel}^i(\Omega)$ over the number $i = 1, \dots, m$ of such structures to get the effect in a single full turn:

$$\widetilde{Z}_{\perp, \parallel}^T(\Omega) = \sum_{i=1}^m \widetilde{Z}_{\perp, \parallel}^i(\Omega) \quad (8.33)$$

Again the impedance is a function of frequency alone in these cases and only dependence on the azimuthal harmonic number n arises through the frequency $\Omega' = \Omega + n\omega_j$ in the moving frame of the particle:

$$\widetilde{Z}(\Omega') = \widetilde{Z}(\Omega + n\omega_j) \quad (8.34)$$

It is easy to verify, analogous to the BTF studied in Section 5, that for physical wake-functions, $\tilde{g}(\Omega)$ considered for complex values of Ω , is analytic in the upper half-plane $\text{Im } \Omega > 0$ of complex Ω and $\tilde{g}^*(\Omega) = \tilde{g}(-\Omega^*)$. For real frequencies, one has $\tilde{g}^*(\Omega) = \tilde{g}(-\Omega)$, as follows from the reality of $g(t)$ in the time domain. The above causality and analyticity properties of the collective Green's function or impedance function imply that they satisfy, analogous to the BTF, the following Kramers-Kronig relations:

$$\text{Im } [\tilde{g}(\Omega)] = \frac{1}{\pi} \int_{-\infty}^{+\infty} d\Omega' \text{P} \frac{\text{Re } [\tilde{g}(\Omega')]}{[\Omega - \Omega']} = \frac{2}{\pi} \int_0^{\infty} d\Omega' \frac{\Omega}{[\Omega^2 - \Omega'^2]} \text{Re } [\tilde{g}(\Omega')], \quad (8.35)$$

$$\text{Re } [\tilde{g}(\Omega)] = \frac{1}{\pi} \int_{-\infty}^{+\infty} d\Omega' \text{P} \frac{\text{Im } [\tilde{g}(\Omega')]}{[\Omega' - \Omega]} = \frac{2}{\pi} \int_0^{\infty} d\Omega' \frac{\Omega'}{[\Omega'^2 - \Omega^2]} \text{Im } [\tilde{g}(\Omega')], \quad (8.36)$$

where $\tilde{g}(\Omega)$ is either $\tilde{g}_{\perp}(\Omega)$ or $\tilde{g}_{\parallel}(\Omega)$. Thus the real and imaginary parts of $\tilde{g}(\Omega)$ are not independent of each other and a knowledge of one implies the knowledge of the other, and hence the full complex and analytic $\tilde{g}(\Omega)$ by

$$\tilde{g}(\Omega) = \frac{i}{\pi} \lim_{\gamma \rightarrow 0^+} \int d\Omega' \frac{\text{Re } [\tilde{g}(\Omega')]}{[\Omega - \Omega' + i\gamma]} = \frac{1}{\pi} \lim_{\gamma \rightarrow 0^+} \int d\Omega' \frac{\text{Im } [\tilde{g}(\Omega')]}{[\Omega' - \Omega - i\gamma]} \quad (8.37)$$

Similar relations for the impedance functions $\tilde{Z}_{\perp, \parallel}(\Omega)$ follow immediately by noting

$$\begin{aligned} \text{Re } [\tilde{g}_{\perp}(\Omega)] &= -\frac{\omega_0^2}{2\pi m \gamma_r c} \text{Im } [\tilde{Z}_{\perp}(\Omega)] \\ \text{Im } [\tilde{g}_{\perp}(\Omega)] &= \frac{\omega_0^2}{2\pi m \gamma_r c} \text{Re } [\tilde{Z}_{\perp}(\Omega)] \\ \text{Re } [\tilde{g}_{\parallel}(\Omega)] &= -\frac{1}{2\pi R} \text{Re } [\tilde{Z}_{\parallel}(\Omega)] \\ \text{Im } [\tilde{g}_{\parallel}(\Omega)] &= -\frac{1}{2\pi R} \text{Im } [\tilde{Z}_{\parallel}(\Omega)] \end{aligned} \quad (8.38)$$

If the collective interaction is provided by an external feedback loop as in stochastic cooling, all the above discussions remain valid provided one replaces the propagators $\tilde{g}_{\perp, \parallel}(\Omega)$ by the total gain $\tilde{G}_{\perp, \parallel}(\Omega)$ of the feedback loop (including PU and kicker sensitivities) which relates current or dipole moment at a pick-up to the voltage or transverse fields at a kicker⁷⁾.

9. COLLECTIVE DISTORTION OF BEAM RESPONSE

It is obvious that the beam transfer function studied in Sections 6 and 7 for a non-interacting system of charged particles in the beam should get modified when collective interactions, as discussed in Section 8, are taken into account. Let us characterize the collective interaction by a causal Green's function $G(\theta, \theta' | t, t')$ such that a modulation in the observable $A(t' | \theta')$ at all θ' generates a collective field $B_{\text{ind}}(t | \theta)$ induced at θ given by:

$$B_{\text{ind}}(t | \theta) = \frac{1}{(2\pi)^2} \int_{-\infty}^t dt' \int_0^{2\pi} d\theta' G(\theta, \theta' | t, t') A(t' | \theta') \quad (9.1)$$

Obviously, depending on the definition of the observable A and the field B , $G(\theta, \theta' | t, t')$ is related to the relevant $g_{\perp, \parallel}(\theta, \theta' | t, t')$, discussed in Section 8, for the collective interactions. In particular the Fourier harmonic transform $\tilde{G}_n(\Omega)$ of G is simply related to the relevant impedance $(\tilde{Z}_{\perp, \parallel})_n(\Omega)$ mentioned there.

The externally applied field $B(t_1 | \theta_K)$ at the kicker generates a modulation $A(t' | \theta')$ at θ' given by the zeroth-order BTF, which in turn generates an induced field $B_{\text{ind}}(t'' | \theta'')$ at θ'' through the collective interaction G . This induced field at θ'' generates extra modulations in $A(t_2 | \theta_P)$ at the pick-up again either directly through the zeroth-order BTF or through another cycle of induced fields and another and so on. The cycles can be repeated indefinitely for all possible points around the ring and for all possible intermediate times. The overall effect is to reduce or enhance (with possible phase shifts), depending on the collective interaction, the effective field seen by the beam at the kicker. These various possibilities of regeneration of response at θ_P through external field at θ_K and repeated cycles of induced fields actually form an infinite series. Since we are interested in linear response only, we can add these various regeneration paths linearly to get the total response. Thus:

$$\begin{aligned} \mathcal{R}_{AB}(t_2, t_1 | \theta_P, \theta_K) &= \mathcal{R}_{AB}^0(t_2, t_1 | \theta_P, \theta_K) \\ &+ \frac{1}{(2\pi)^2} \int_0^{t_2} dt'' \int_0^{2\pi} d\theta'' \mathcal{R}_{AB}^0(t_2, t'' | \theta_P, \theta'') \\ &\times \int_0^{t''} dt' \int_0^{2\pi} d\theta' G(\theta'', \theta' | t'', t') \mathcal{R}_{AB}^0(t', t_1 | \theta', \theta_K) \\ &+ \frac{1}{(2\pi)^4} \int_0^{t_2} dt''' \int_0^{2\pi} d\theta''' \mathcal{R}_{AB}^0(t_2, t''' | \theta_P, \theta''') \\ &\times \int_0^{t'''} dt'''' \int_0^{2\pi} d\theta'''' G(\theta''', \theta'''' | t''', t''') \end{aligned}$$

$$\begin{aligned}
& \times \int_0^{2\pi} \int_0^{t'''} dt'' d\theta'' \mathcal{R}_{AB}^0(t''', t'' | \theta''', \theta'') \\
& \times \int_0^{2\pi} \int_0^{t''} dt' d\theta' G(\theta'', \theta' | t'', t') \mathcal{R}_{AB}^0(t', t_1 | \theta', \theta_K) \\
& + \dots
\end{aligned} \tag{9.2}$$

For homogeneous beams invariant under arbitrary time-translations, i.e. for continuous coasting beams, $\mathcal{R}_{AB}^0(\theta', \theta'' | t', t'')$ and $G(\theta', \theta'' | t', t'')$ are functions of the age variables $\tau = t' - t''$ and $\theta = \theta' - \theta''$ alone; all the multiple integrals have the form of convolutions. It is then convenient to consider single-frequency Fourier transforms and Fourier harmonic decomposition in θ into beam harmonics n , without any specific reference to position or time in the ring. One then obtains the algebraic relation:

$$\begin{aligned}
[\tilde{\mathcal{R}}_{AB}]_n(\Omega) &= [\tilde{\mathcal{R}}_{AB}^0]_n(\Omega) + [\tilde{\mathcal{R}}_{AB}^0]_n(\Omega) \tilde{G}_n(\Omega) [\tilde{\mathcal{R}}_{AB}^0]_n(\Omega) + \dots \\
&= [\tilde{\mathcal{R}}_{AB}^0]_n(\Omega) \left[1 + \tilde{G}_n(\Omega) [\tilde{\mathcal{R}}_{AB}^0]_n(\Omega) + \left(\tilde{G}_n(\Omega) [\tilde{\mathcal{R}}_{AB}^0]_n(\Omega) \right)^2 + \dots \right].
\end{aligned} \tag{9.3}$$

The infinite regeneration series is represented pictorially in Fig. 28.

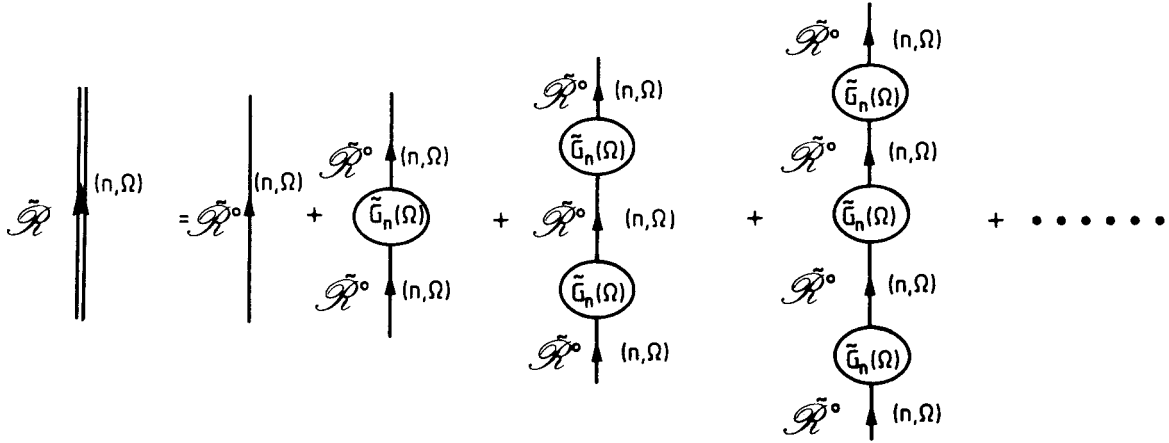

Fig. 28 The infinite series of regeneration paths leading to distortion of beam response by collective interactions

The infinite geometric series can actually be summed to give

$$[\tilde{\mathcal{R}}_{AB}]_n(\Omega) = \frac{[\tilde{\mathcal{R}}_{AB}^0]_n(\Omega)}{[1 - \tilde{G}_n(\Omega) [\tilde{\mathcal{R}}_{AB}^0]_n(\Omega)]} \tag{9.4}$$

and

$$\tilde{\mathcal{R}}_{AB}(\Omega|\theta_P, \theta_K) = \sum_{n=-\infty}^{+\infty} [\tilde{\mathcal{R}}_{AB}]_n(\Omega) e^{in(\theta_P - \theta_K)} = \sum_{n=-\infty}^{\infty} \frac{[\tilde{\mathcal{R}}_{AB}^0]_n(\Omega) e^{in(\theta_P - \theta_K)}}{[1 - \tilde{G}_n(\Omega)[\tilde{\mathcal{R}}_{AB}^0]_n(\Omega)]} . \quad (9.5)$$

The effect of the collective interaction on the beam response may then be represented by the block diagram of a feedback flow circuit³⁹⁾, shown in Fig. 29.

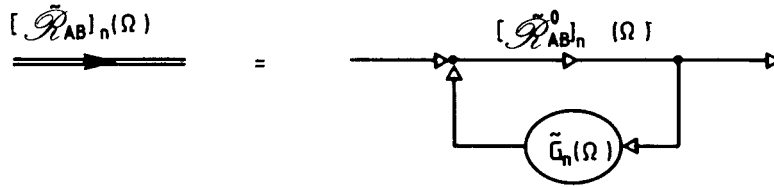

Fig. 29 Feedback flow representation of the distortion of beam response by collective interactions

For local impedances one simply replaces $\tilde{G}_n(\Omega)$ by $\tilde{G}(\Omega)$. If the impedance is not only local but also localized at an azimuth $\theta = \theta_L$ say, one easily verifies that

$$\tilde{\mathcal{R}}_{AB}(\Omega|\theta_P, \theta_K) = \tilde{\mathcal{R}}_{AB}^0(\Omega|\theta_P, \theta_K) + \frac{\tilde{\mathcal{R}}_{AB}^0(\Omega|\theta_P, \theta_L) \tilde{G}(\Omega) \tilde{\mathcal{R}}_{AB}^0(\Omega|\theta_L, \theta_K)}{1 - \tilde{G}(\Omega) \tilde{B}_{AB}^0(\Omega)} , \quad (9.6)$$

where $\tilde{B}_{AB}^0(\Omega) = \tilde{\mathcal{R}}_{AB}^0(\Omega|\theta_L, \theta_L)$ is the beam transfer function for a complete turn from θ_L to θ_L . If $\theta_P = \theta_K$ then the beam transfer function for a complete turn $\tilde{B}_{AB}(\Omega|\theta_P, \theta_P)$ for $\theta_P = \theta_K \neq \theta_L$ is seen to be

$$\tilde{B}_{AB}(\Omega|\theta_P, \theta_P) = \tilde{B}_{AB}^0(\Omega|\theta_P, \theta_P) + \frac{\tilde{\mathcal{R}}_{AB}^0(\Omega|\theta_L, \theta_P) \tilde{G}(\Omega) \tilde{\mathcal{R}}_{AB}^0(\Omega|\theta_P, \theta_L)}{1 - \tilde{G}(\Omega) \tilde{B}_{AB}^0(\Omega)} . \quad (9.7)$$

Finally the beam transfer function for a complete turn at the location $\theta_P = \theta_L$ of the cavity is given by

$$\tilde{B}_{AB}(\Omega) = \frac{\tilde{B}_{AB}^0(\Omega)}{[1 - \tilde{G}(\Omega) \tilde{B}_{AB}^0(\Omega)]} . \quad (\theta_P = \theta_K = \theta_L) \quad (9.8)$$

The modification of BTF by collective interactions is particularly transparent in the complex plane of the inverse response $[\tilde{\mathcal{R}}_{AB}(\Omega)]^{-1}$, the so-called 'stability diagram' discussed in Section 7,

where it simply manifests itself as a shift³⁷⁻³⁹⁾ of the origin locally at the frequency Ω of interest by an amount $\tilde{G}_n(\Omega)$:

$$\frac{1}{[\tilde{\mathcal{R}}_{AB}]_n(\Omega)} = \frac{1}{[\tilde{\mathcal{R}}_{AB}^0]_n(\Omega)} - \tilde{G}_n(\Omega) , \quad (9.9)$$

$$\frac{1}{\tilde{B}_{AB}(\Omega)} = \frac{1}{\tilde{B}_{AB}^0(\Omega)} - \tilde{G}(\Omega) . \quad (9.10)$$

These shifts are illustrated in the stability diagrams of Fig. 30a for the transverse ‘fast’ wave response with a mostly resistive and slightly capacitive transverse impedance and Fig. 30b for the longitudinal response with a mostly resistive and slightly inductive longitudinal impedance, for a continuous coasting beam.

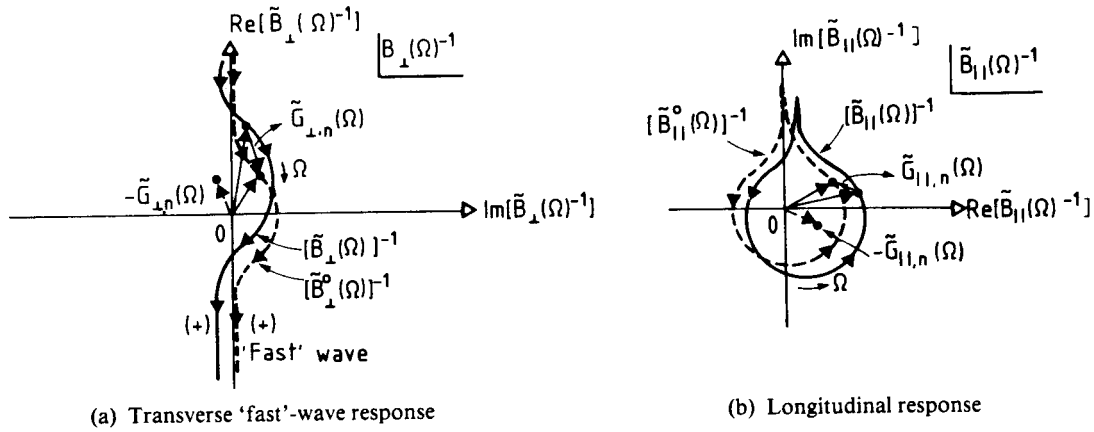

Fig. 30 Manifestation of collective distortion of beam response in the ‘stability diagram’

For longitudinal response $\tilde{B}_{\parallel}(\Omega)$, relating induced current modulations to externally applied voltages, $\tilde{G}_{\parallel}(\Omega)$ should be defined so as to relate induced voltages to current modulations in the beam. In Eqs. (9.8) and (9.10), $\tilde{G}_{\parallel}(\Omega)$ is then simply related to the longitudinal impedance $\tilde{Z}_{\parallel}(\Omega)$, as defined in Section 8, as follows:

$$\tilde{G}_{\parallel}(\Omega) = - (2\pi)^2 \tilde{Z}_{\parallel}(\Omega) \quad (9.11)$$

For transverse response $\tilde{B}_{\perp}(\Omega)$, relating induced dipole-moment current modulation to the transverse angular kick $\tilde{\alpha}(\Omega)$, $\tilde{G}_{\perp}(\Omega)$ should be defined so as to relate induced transverse angular kick to the dipole-moment current modulation in the beam. One can verify that the $\tilde{G}_{\perp}(\Omega)$ in Eqs. (9.8) and (9.10), when considered for transverse response, is then related to the transverse impedance $\tilde{Z}_{\perp}(\Omega)$, as defined in Section 8, as follows:

$$\tilde{G}_{\perp}(\Omega) = i \frac{q\omega_0 R}{\beta E_0 c} \tilde{Z}_{\perp}(\Omega) , \quad (9.12)$$

where E_0 is the energy of the nominal reference particle in the beam.

The BTF measurement thus provides important information about the coupling impedance of collective interaction of the beam-storage-ring system. In principle, the BTF provides information on any interaction that generates a perturbation on the particle orbits, since the BTF is determined by the collection of the individual particle dynamics, summed over the particle distribution in the beam. Thus, for example, an externally imposed transverse or longitudinal active feedback system will again shift the ‘stability diagram’ of the relevant BTF with feedback ‘on’ relative to the same with feedback ‘off’, by an amount given by the complex (reactive and/or resistive) gain of the feedback loop, similar to the shifts produced by coupling impedances. Similarly, shifts in incoherent frequencies of the particles caused by a reactive impedance (e.g. space charge), the incoherent tune-shift caused by interaction with the collective fields of another beam in the colliding mode (the beam-beam interaction), high-order resonances (linear and non-linear as well as coupled resonances connecting different degrees of freedom of the beam, with their characteristic strengths and widths) due to magnetic field imperfections of the storage-ring lattice, beam-beam induced resonances, etc., all can be deduced qualitatively and quantitatively from the manifest distortion of the BTF, e.g. notches and/or spikes in the real and imaginary parts of the relevant BTF, dips and peaks with characteristic heights and widths in the amplitude and phase diagram of the BTF, shifts in the ‘stability diagram’, local phase excursions (in crossing a resonance) manifesting themselves as ‘loops’ around the resonance in the Nyquist diagram (polar plot of the BTF), etc.³⁸⁾. The BTF thus provides an indispensable diagnostic tool for storage-ring physics.

The strengths of some of the above collective (coherent) and incoherent perturbing effects may be weak enough to be barely observable in the BTF measurement. In some cases, these strengths can be enhanced by suitable control, e.g. strengths of the beam-beam resonances induced in the ‘affected’ beam by the non-linear fields of the ‘affecting’ beam, can be enhanced simply by increasing the intensity (i.e. current) of the ‘affecting’ beam; the strengths of the high-order magnetic imperfection resonances of the storage-ring lattice can be controlled by suitable powering of sets of magnetic multipole elements (e.g. octupoles, etc.) in the lattice, etc. Such enhancement will then make the relevant perturbation manifest itself in the BTF. Collective and incoherent perturbing effects also affect the Schottky fluctuation spectra of the beam studied in Section 3. In Section 11 we will see how the fluctuation spectra get distorted by collective effects. A prolonged observation on a spectrum analyser attached to a suitable Schottky pick-up will then produce a Schottky scan (i.e. the relevant fluctuation spectrum) which will display even the very weak perturbing influences, whether collective or incoherent, enhanced by cumulative effect.

Figure 31a shows qualitatively a typical generic example of the beam-beam resonances being clearly visible on the imaginary part of the transverse BTF (i.e. the resistive part for the BTF relating position modulation to angular kick) as a function of frequency. Figure 31b shows the typical ‘local’ phase-excursions, i.e. ‘loops’ visible in the Nyquist diagram (BTF polar plot) around the resonances for the same example as Fig. 31a.

All the above discussion was for continuous coasting beams. The modification of the bunched beam BTF by collective and other incoherent effects is more intricate owing to the qualitatively different frequency-space structure of the bunched beam response, as discussed in Section 5. The qualitative features of the BTF distortion discussed above for continuous beams remain valid in general, however, for each individual Bloch-component $\tilde{\mathcal{R}}_{AB}^k(\Omega|\theta_P, \theta_K)$, $k = 0, \pm 1, \pm 2, \dots$, etc., of the bunched beam BTF; but equations corresponding to (9.9) and (9.10) are more complicated.

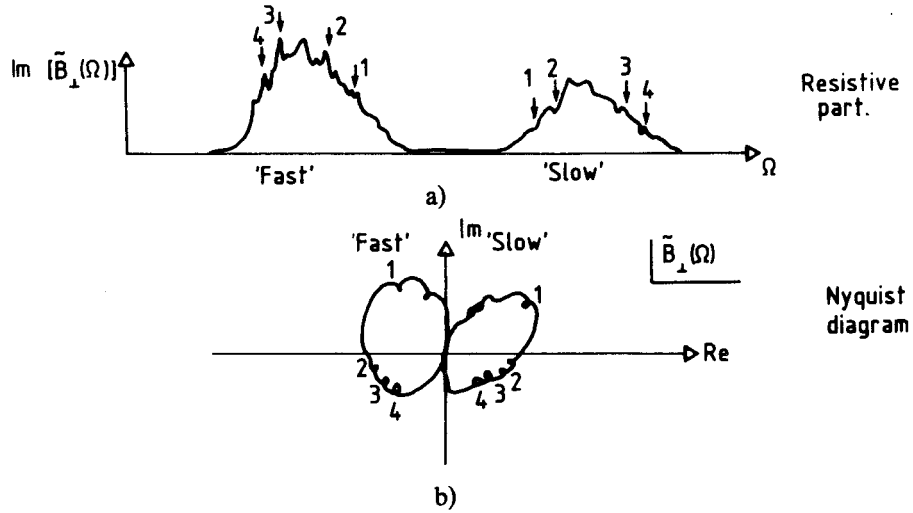

Fig. 31 Manifestation of beam-beam resonances in the BTF

The effect of the collective interaction on the BTF has to be represented now by an *operator* block diagram of a feedback flow circuit, as shown in Fig. 32a, where the response operator $\hat{\mathcal{R}}(\Omega)$ is given by Eq. (5.40) and $\tilde{\mathcal{G}}(\Omega)$ is simply the operation of multiplying by a scalar $\tilde{G}(\Omega)$:

$$\hat{\mathcal{G}}(\Omega) \tilde{\mathcal{A}}(\Omega) = \tilde{G}(\Omega) \tilde{\mathcal{A}}(\Omega), \quad (9.13)$$

where $\tilde{G}(\Omega)$ is the relevant collective interaction impedance or gain function. In this operator form, one sees from Fig. 32a that the modified BTF is given by

$$\hat{\mathcal{R}}(\Omega) = [\hat{\mathcal{I}} - \hat{\mathcal{R}}^0(\Omega) \hat{\mathcal{G}}(\Omega)]^{-1} \hat{\mathcal{R}}^0(\Omega) \quad (9.14)$$

$$[\hat{\mathcal{R}}(\Omega)]^{-1} = [\hat{\mathcal{R}}^0(\Omega)]^{-1} - \hat{\mathcal{G}}(\Omega), \quad (9.15)$$

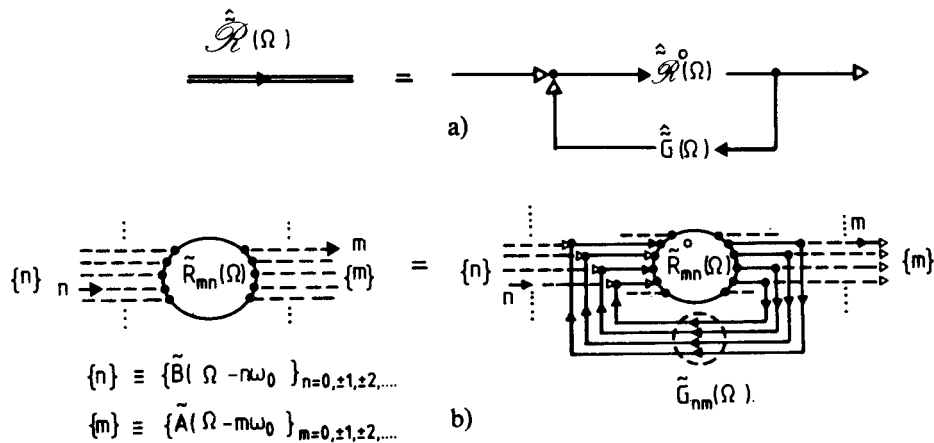

Fig. 32 Block diagrammatic feedback flow of the BTF distortion of bunched beams in (a) the operator notation and (b) the matrix representation

where \hat{I} is the unit operator. For continuous coasting beams, the operators are simply represented by scalars 1, $\tilde{\mathcal{R}}(\Omega)$ and $\tilde{\mathcal{G}}(\Omega)$, operating locally at the same frequency Ω . Figure 32a then simply reduces to the scalar representation of Fig. 29 locally at each frequency Ω and Eqs. (9.14) and (9.15) reduce to the corresponding scalar local relations in frequency given by Eqs. (9.8) and (9.10) respectively. The intrinsic non-local connection in the frequency space of the bunched beam response does not allow a local scalar representation of the BTF in the frequency domain. The Bloch representation of the response given by Eq. (5.37), as demanded by periodic time variations, implies a natural infinite 'matrix'-representation of the bunched beam response $\tilde{\mathcal{R}}(\Omega) \leftrightarrow \tilde{\mathcal{R}}_{mn}(\Omega)$ such that

$$\tilde{\mathcal{A}}_m(\Omega) = \sum_{n=-\infty}^{+\infty} \tilde{\mathcal{R}}_{mn}(\Omega) \tilde{\mathcal{B}}_n(\Omega) \quad , \quad m = 0, \pm 1, \pm 2, \dots, \quad (9.16)$$

where

$$\begin{aligned} \tilde{\mathcal{A}}_m(\Omega) &= \tilde{\mathcal{A}}(\Omega - m\omega_0) \\ \tilde{\mathcal{B}}_n(\Omega) &= \tilde{\mathcal{B}}(\Omega - n\omega_0) \\ \tilde{\mathcal{R}}_{mn}(\Omega) &= \tilde{\mathcal{R}}^{n-m}(\Omega - m\omega_0) \quad , \end{aligned} \quad (9.17)$$

$\tilde{\mathcal{A}}(\Omega)$ and $\tilde{\mathcal{B}}(\Omega)$ being the Fourier frequency transforms of the response observable and the excitation observable, which are related by the relevant BTF, $\tilde{\mathcal{R}}_{AB}(\Omega)$, under study, and $\tilde{\mathcal{R}}^k(\Omega)$ on the right-hand side of the third relation in Eq. (9.17) is the same as defined in Section 5. The BTF distortion for bunched beams is then represented by the matrix representation of the block diagrammatic feedback flow as shown in Fig. 32b, where $\tilde{\mathcal{R}}_{mn}(\Omega)$ as well as $\tilde{\mathcal{R}}_{mn}^0(\Omega)$ are general matrices of infinite rank and $\tilde{\mathcal{G}}_{nm}(\Omega)$ is a diagonal matrix

$$\tilde{\mathcal{G}}_{nm}(\Omega) = \delta_{nm} \tilde{\mathcal{G}}(\Omega - m\omega_0) \quad (9.18)$$

of infinite rank, defining transformations in the infinite dimensional space of the vectors $\{m\} \equiv \tilde{\mathcal{A}}_m(\Omega)$ and $\{n\} \equiv \tilde{\mathcal{B}}_n(\Omega)$. The practical difficulty and complication in obtaining a solution for the collectively modified BTF of a bunched beam is then to invert the operator $[\hat{I} - \tilde{\mathcal{R}}^0(\Omega)\tilde{\mathcal{G}}(\Omega)]$ effectively or equivalently to invert the infinite matrix $\underline{\underline{\mathcal{E}}}(\Omega)$ given by

$$\begin{aligned} \underline{\underline{\mathcal{E}}}(\Omega) &= \underline{\underline{I}} - \underline{\underline{\mathcal{R}}}^0(\Omega)\underline{\underline{\mathcal{G}}}(\Omega) \\ \mathcal{E}_{mn}(\Omega) &= \delta_{mn} - \mathcal{R}_{mn}^0(\Omega)\mathcal{G}(\Omega - n\omega_0) \end{aligned} \quad (9.19)$$

The modified BTF is then

$$\underline{\underline{\mathcal{R}}}(\Omega) = [\underline{\underline{\mathcal{E}}}(\Omega)]^{-1} \underline{\underline{\mathcal{R}}}^0(\Omega) \quad (9.20)$$

This inversion is generally a difficult task. In the particular case of a collective interaction given by a very narrow-band impedance with bandwidth less than ω_0 and centred around $\pm n_0\omega_0$, the matrix is essentially two by two, since only the lines $\pm n_0$ contribute in the feedback path in Fig. 32(b). The inversion is simple and the modified BTF connecting any two lines can be obtained trivially.

Finally, we mention that all the above results on the modification of the BTF by collective interactions could also be derived from the Vlasov equation (6.5) with the addition of the collective force term to the right-hand side. The results are identical. The feedback flow representation, however, makes the process (and the paths) of collective regeneration easier to visualize.

10. COHERENT COLLECTIVE MODES AND THEIR STABILITY

Collective interactions, described by the coupling impedance of the beam-storage-ring system, always generate additional dynamical states of the beam. Thus a beam may be characterized by a set of collective oscillation modes with complex frequencies in general describing growing (i.e. unstable), decaying (i.e. transient) or stable collective motion, depending on the nature of the causal propagator or impedance of the collective interaction and the single-particle properties of the beam distribution. An externally applied feedback loop (as in stochastic cooling) can also cause and/or enhance instabilities of the beam if the loop transfer function is not carefully chosen. A feedback loop with properly chosen transfer function on the other hand, can suppress the instabilities and stabilize the otherwise unstable modes, as is often done in storage rings with feedback dampers.

Collective modes are nothing but a manifestation of spontaneous perturbations in the beam phase space, self-sustaining by virtue of proper phase relationships with respect to the collectively induced fields. This self-sustained coherence is generated and determined by a combination of transfer through the BTF and transfer through the collective interaction propagator. Since we have already discussed both these physical processes, we are immediately in a position to derive the collective modes without any further concepts. Let us consider the full-ring BTF $\tilde{\mathcal{R}}_{AB}(\Omega)$ relating an observable physical quantity $\tilde{A}(\Omega)$ of the beam as response to an impressed generalized force $\tilde{B}(\Omega)$ on the beam at the same azimuth in the ring:

$$\tilde{A}(\Omega) = \tilde{\mathcal{R}}_{AB}(\Omega) \tilde{B}(\Omega) \quad (10.1)$$

If the impressed force $\tilde{B}(\Omega)$ is self-generated (rather than being external), through the collective propagator $\tilde{\mathcal{G}}(\Omega)$, by the spontaneous perturbations $\tilde{A}(\Omega)$ in A itself, we have

$$\tilde{B}(\Omega) = \tilde{\mathcal{G}}(\Omega)\tilde{A}(\Omega) \quad \text{and} \quad [1 - \tilde{\mathcal{R}}_{AB}(\Omega)\tilde{\mathcal{G}}(\Omega)] \tilde{A}(\Omega) = 0 \quad (10.2)$$

For first-order linear collective properties with a relatively small $\tilde{\mathcal{G}}$, we may replace $\tilde{\mathcal{R}}_{AB}(\Omega)$ by $\tilde{\mathcal{R}}_{AB}^0(\Omega)$, the BTF in the absence of collective interactions, since $\tilde{\mathcal{R}}_{AB}(\Omega) = [1 - \tilde{\mathcal{G}}(\Omega)\tilde{\mathcal{R}}_{AB}^0(\Omega)]^{-1} \tilde{\mathcal{R}}_{AB}^0(\Omega) = \tilde{\mathcal{R}}_{AB}^0(\Omega) + \mathcal{O}(\tilde{\mathcal{G}})$ and Eq. (10.2) may be written as

$$\tilde{A}(\Omega) = \tilde{\mathcal{R}}_{AB}^0(\Omega)\tilde{\mathcal{G}}(\Omega)\tilde{A}(\Omega) + \mathcal{O}(\tilde{\mathcal{G}}^2) \quad (10.3)$$

In this linear approximation, self-sustained coherence requires that spontaneous coherent perturbations satisfy

$$[1 - \tilde{\mathcal{R}}_{AB}^0(\Omega)\tilde{\mathcal{G}}(\Omega)] \tilde{A}(\Omega) = 0 \quad (10.4)$$

or

$$\varepsilon(\Omega) \tilde{A}(\Omega) = 0, \quad (10.5)$$

where

$$\varepsilon(\Omega) = 1 - \chi(\Omega), \quad \chi(\Omega) = \tilde{\mathcal{R}}_{AB}^0(\Omega)\tilde{\mathcal{G}}(\Omega) \quad (10.6)$$

This is pictorially represented in Fig. 33.

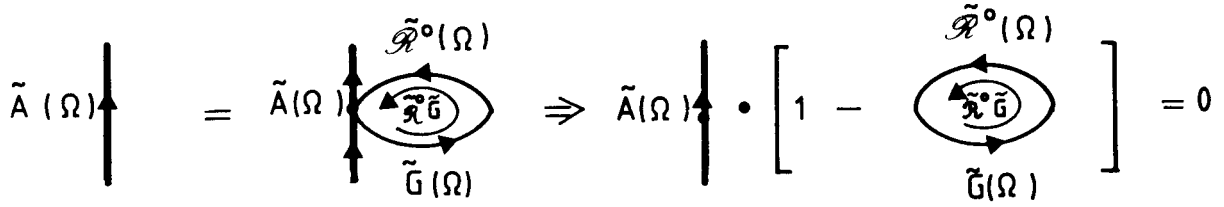

Fig. 33 Regeneration loop diagram for self-sustained coherence of spontaneous perturbations

The condition for the existence of a non-vanishing coherent collective state $\tilde{A}(\Omega) \neq 0$, is then simply

$$\epsilon(\Omega) = 1 - \tilde{\mathcal{R}}_{AB}^0(\Omega) \cdot \tilde{G}(\Omega) = 0, \text{ i.e. } \chi(\Omega) = \tilde{\mathcal{R}}_{AB}^0(\Omega) \tilde{G}(\Omega) = 1 \quad (10.7)$$

This is illustrated in Fig. 34.

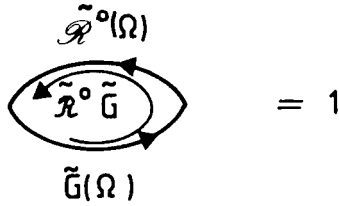

Fig. 34 Closed-loop condition for self-sustained coherence

The oscillation frequencies $\{\Omega_k\}$ of these collective modes are then given by the roots of $\epsilon(\Omega) = 0$, often called the Dispersion Relation^{25,29}. The eigenfrequencies $\{\Omega_k\}$ may be complex:

$$\epsilon(\Omega_k) = 0 \Rightarrow \Omega_k = \omega_k + i\gamma_k \quad (10.8)$$

If for any mode k , $\gamma_k > 0$, the mode will grow in time as $\exp(\gamma_k t)$ in addition to oscillating as $\exp(-i\omega_k t)$, in the linear regime. The beam is said to be linearly unstable when excited to mode k .

As already noted in Section 5, $\tilde{\mathcal{R}}^0$ and hence ϵ should actually be properly defined as functions of the Laplace variable s , i.e. $\tilde{\mathcal{R}}^0 = \tilde{\mathcal{R}}^0(s)$, $\tilde{G} = \tilde{G}(s)$ and $\epsilon = \epsilon(s)$ with s having some positive real part γ , i.e. for $s = -i\Omega + \gamma$, $\gamma > 0$ and then taking the limit $\gamma \rightarrow 0^+$. The question of the stability of the collective modes is now determined by whether the equation $\epsilon(s) = 1 - \chi(s) = 0$ has any roots with $\text{Re } s > 0$.

In view of the analyticity properties of $\tilde{\mathcal{R}}^0(\Omega)$ and $\tilde{G}(\Omega)$ discussed before, $\epsilon(s)$ is also analytic in the right half- s -plane $\text{Re } s > 0$. (Note: analyticity in the right half-plane is dependent on some limitations or conditions on the distribution function $\Psi_0(\vec{I})$ or its derivative $d\Psi_0/d\vec{I}$, e.g. Lipschitz condition and power-law fall off asymptotically. These conditions are usually satisfied by the beams.) We can also define values of $\epsilon(s)$ on the imaginary s -axis in some proper limit ($\gamma \rightarrow 0^+$) and then analytically continue to the left half-plane. Since $\epsilon(s)$ was originally defined on the right half-plane, we call this extended analytically continued function, $\epsilon^+(s)$. Obviously $\epsilon^+(s) \equiv \epsilon(s)$ for $\text{Re } s > 0$. Since $\epsilon^+(s)$ is regular (i.e. no poles, only zeros) for $s \in S^+$, i.e. in the right half-plane we have

$$N_0 = \frac{1}{2\pi i} \oint_C ds \frac{[\epsilon^+(s)]'}{\epsilon^+(s)} = \frac{1}{2\pi i} \oint_C \frac{ds}{\epsilon^+(s)} \frac{d\epsilon^+(s)}{ds} = \begin{array}{l} \text{Number of zeros of} \\ \epsilon^+(s) \text{ in the right} \\ \text{half plane } s \in S^+, \\ \text{i.e. in } \text{Re } s > 0 \end{array} \quad (10.9)$$

where C is the contour shown in Fig. 35. The circled crosses are the poles of $[\epsilon^+(s)]^{-1}$, i.e. zeros of $\epsilon^+(s)$. (Note that the integral gives the sum of the residues at the poles of $[\epsilon^+(s)]^{-1}$, each one divided by the residues themselves so that it is actually the number of simple poles of $[\epsilon^+(s)]^{-1}$ which is the same as the number of zeros of $[\epsilon^+(s)]$.) The condition for stability is then that $N_0 = 0$, i.e. Eq. (10.9) vanishes.

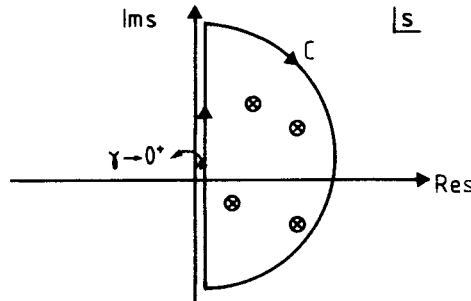

Fig. 35 Contour for evaluating the zeros of $\epsilon(s)$

As s moves along $s = -i\Omega + \gamma$ from $\Omega = \infty$ to $\Omega = -\infty$ (Fig. 36a), $\lim_{\gamma \rightarrow 0^+} \epsilon(s = -i\Omega + \gamma)$ traces out a path (Fig. 36b) in the complex $\epsilon(s)$ -plane, called the Nyquist diagram of beam stability²⁵. Since $\epsilon(s) = 1 - \tilde{R}^0(s)\tilde{G}(s)$, it is simply the Nyquist diagram of the beam response discussed in Section 7 (Fig. 27a and b), scaled by the complex collective impedance $[-\tilde{G}(s)]$ and shifted in origin by an amount $+1$. The number of times this curve encircles the origin $(0,0)$ [$\epsilon(s) = 0$] or the corresponding susceptibility $\chi(s)$ (Fig. 36c) encircles the point $(1,0)$ [$\chi(s) = 1$] gives the number of zeros N_0 , with $\text{Re } s > 0$, for the function $\epsilon(s)$. Each time s on the contour in Fig. 36a passes close to a zero of $\epsilon(s)$ or equivalently a pole of $[\epsilon(s)]^{-1}$ (marked with crossed circles), the phase of $\epsilon(s)$ goes through a complete cycle of 2π . Note that the curves in Fig. 36b and c are closed since $\epsilon(s)|_{s = \pm i\infty + \gamma} = 1$ and $\chi(s)|_{s = \pm i\infty + \gamma} = 0$. This is expected since $\tilde{G}(\Omega) [\equiv \tilde{G}(s = -i\Omega)]$ or equivalently the coupling impedance $\tilde{Z}(\Omega)$ have finite cut-off frequencies $\pm\Omega_c$ beyond which they are zero. To be more precise, actually $\epsilon(+i\infty) = e^{2\pi i N_0}$, $\epsilon(-i\infty) = 1$ and $\chi(+i\infty) = 1 - e^{2\pi i N_0}$, $\chi(-i\infty) = 0$. The common points of intersection $(1,0)$ in Fig. 36b and $(0,0)$ in Fig. 36c then correspond to the points $s = \pm i\infty + \gamma$ on the contour in Fig. 36a, for the case when there are only two zeros of $\epsilon(s)$ on the right half-plane.

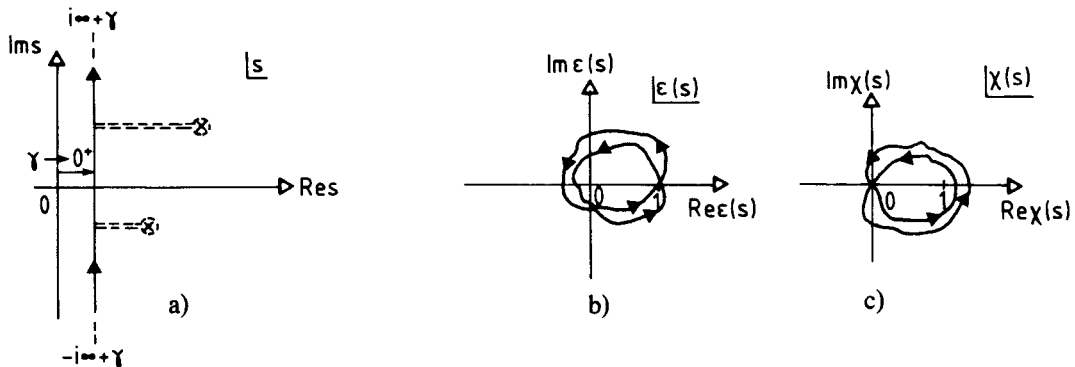

Fig. 36 Laplace variable contour and associated Nyquist diagrams of beam stability

Thus there are no zeros of $\epsilon(s)$ with $\text{Re } s > 0$ if the Nyquist diagram for $\epsilon(s)$ does not encircle the origin or the susceptibility curve $\chi(s)$ does not encircle the point (1,0). Since the curve for $\chi(s)$ has to pass through the origin which lies to the left of the point (1,0), this will be sufficiently ensured if

$$\lim_{\gamma \rightarrow 0^+} \left[\chi(s = -i\Omega + \gamma) \right]_{\text{Im}\chi(s)=0} < 1, \quad (10.10)$$

which is the Nyquist criterion for beam stability against growing collective modes. Note that this is only a sufficient condition and not a necessary one. It is obvious that there may be situations, as the one shown in Fig. 37, where (10.10) is not satisfied and still the beam is stable since $\chi(s)$ does not completely encircle the point (1,0).

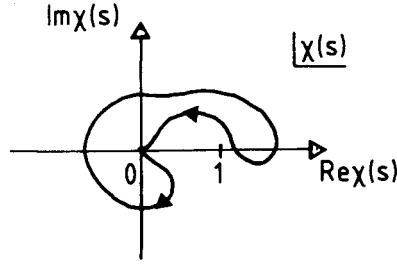

Fig. 37 A typical Nyquist diagram for a stable situation, but violating Nyquist sufficient stability criterion

We observe that both $\tilde{G}(\Omega)$ and $\tilde{\mathcal{R}}^0(\Omega)$ are complex quantities in general, having real and imaginary parts; $\tilde{G}(\Omega)$ is related to the beam-storage-ring coupling impedance $\tilde{Z}(\Omega)$ which may have reactive and resistive parts and as we have seen in Section 7, the same is true for the beam response $\tilde{\mathcal{R}}(\Omega)$. Let

$$\tilde{G}(\Omega) = \tilde{U}(\Omega) + i \tilde{V}(\Omega) \quad \text{and} \quad \tilde{\mathcal{R}}^0(\Omega) = X(\Omega) + iY(\Omega) \quad (10.11)$$

The sufficient Nyquist stability criterion for the beam is then

$$\left[\tilde{X}(\Omega)\tilde{U}(\Omega) - \tilde{Y}(\Omega)\tilde{V}(\Omega) \right] < 1 \quad (10.12)$$

with

$$\left[\tilde{X}(\Omega)\tilde{V}(\Omega) + \tilde{Y}(\Omega)\tilde{U}(\Omega) \right] = 0 \quad (10.13)$$

If Eq. (10.13) is satisfied at $\Omega = \Omega_c$ say, we may write the stability criterion (10.12) in the following alternative forms:

$$\left[(\tilde{U}^2 + \tilde{V}^2) \frac{\tilde{X}}{\tilde{U}} \right]_{\Omega=\Omega_c} < 1 \quad \text{i. e.} \quad \left[1 - |\tilde{G}|^2 \frac{\tilde{X}}{\tilde{U}} \right]_{\Omega=\Omega_c} = \left[1 + |\tilde{G}|^2 \frac{\tilde{Y}}{\tilde{V}} \right]_{\Omega=\Omega_c} > 0 \quad (10.14)$$

$$\left[(\tilde{X}^2 + \tilde{Y}^2) \frac{\tilde{U}}{\tilde{X}} \right]_{\Omega=\Omega_c} < 1 \quad \text{i. e.} \quad \left[1 - |\tilde{\mathcal{R}}^0|^2 \frac{\tilde{U}}{\tilde{X}} \right]_{\Omega=\Omega_c} = \left[1 + |\tilde{\mathcal{R}}^0|^2 \frac{\tilde{V}}{\tilde{Y}} \right]_{\Omega=\Omega_c} > 0 \quad (10.15)$$

Using the relevant impedances $\tilde{g}_{\parallel}(\Omega)$ or $\tilde{g}_{\perp}(\Omega)$ for $\tilde{G}(\Omega)$ and the corresponding beam response $\tilde{R}_{\parallel}(\Omega)$ or $\tilde{R}_{\perp}(\Omega)$, one obtains the stability criterion for longitudinal or transverse collective modes of the beam^{29,30}. For example the real part of the longitudinal response of a continuous coasting beam at a frequency Ω , close to a revolution harmonic band centred around $n\omega_0$, in the approximation of non-overlapping bands at low enough frequencies and small total spread in revolution frequencies ω around ω_0 , is given, from Eq. (7.15), by

$$\tilde{X}(\Omega) = \text{Re } \tilde{R}_{\parallel}(\Omega) = \frac{Nq^2 \kappa}{2} \omega_0^2 \cdot \frac{1}{n} \left. \frac{\partial \Psi_0(\omega)}{\partial \omega} \right|_{\omega=\Omega/n} \quad (10.16)$$

For a purely resistive longitudinal coupling impedance $\tilde{V} = 0$ and $\tilde{U} \equiv \tilde{Z}(\Omega)$, and the stability criterion is

$$\tilde{X}(\Omega) \tilde{Z}(\Omega) < 1 \quad (10.17)$$

where Ω is such that $\tilde{Y}(\Omega) = 0$. Instead of finding a solution for such an Ω , a sufficient condition can be obtained by simply calculating the maximum of $\tilde{X}(\Omega)$. The maximum of $\tilde{X}(\Omega)$ occurs at the maximum of $[\partial \Psi_0(\omega)/\partial \omega]_{\omega = \Omega/n}$. For a Gaussian distribution $\Psi_0(\omega)$ with full dispersion $(\Delta\omega)$ in ω :

$$\Psi_0(\omega) = \frac{1}{\sqrt{\pi} \Delta\omega} e^{-(\omega-\omega_0)^2 / (\Delta\omega)^2}, \quad (10.18)$$

this maximum occurs at

$$\left(\frac{\Omega}{n} - \omega_0 \right) = \pm \frac{\Delta\omega}{\sqrt{2}}, \quad \text{i.e.} \quad \Omega = n \left(\omega_0 \pm \frac{\Delta\omega}{\sqrt{2}} \right) \quad (10.19)$$

One then verifies that the stability criterion²⁹⁾ becomes

$$\frac{\tilde{Z}(\Omega/n)}{n} \frac{Nq^2 \omega_0 \omega'(\rho_0)}{2\pi R (\Delta\omega)^2} < 1, \quad (10.20)$$

where we have approximated $(\sqrt{\pi}/2) e^{-1/2}$ by unity.

The stability diagram for longitudinal response, as shown in Fig. 27a, can in fact be reasonably approximated by a circle²⁹⁾ except for large Ω . Thus the value of the real part $\tilde{X}(\Omega)$ when the imaginary part $\tilde{Y}(\Omega)$ is zero is approximately the same as the value of the imaginary part $\tilde{Y}(\Omega)$ when the real part $\tilde{X}(\Omega)$ is zero and is approximately given by the radius of the circle. In fact, for an arbitrary impedance with non-vanishing real and imaginary parts, one can derive the stability criterion²⁹⁾

$$\left| \frac{\tilde{Z}(\Omega/n)}{n} \right| < \frac{2\pi R (\Delta\omega)^2}{Nq^2 \omega_0 \omega'(\rho_0)} F = \frac{m_0 c^2 \beta^2 \gamma_r |\eta| (\Delta p/p)^2}{Nq^2 f_0} F, \quad (10.21)$$

where F is a form factor depending on the beam distribution and the impedance and is typically of order unity^{29,30)}.

For high frequencies with overlapping bands, one has to sum over the values of n corresponding to overlapping poles at $\Omega = n\omega(p)$ and use Eqs. (7.17) and (7.32) for $\tilde{R}(\Omega)$ and $\tilde{X}(\Omega)$ in obtaining the stability criterion from Eqs. (10.12) and (10.13).

The stability of bunched beams is a more involved subject, owing to the matrix nature of the bunched-beam response, as hinted at in the last section. The collective modes will be given by the roots of the dispersion relation, which is now given by the determinant of the infinite matrix $\underline{\underline{\epsilon}}(\Omega)$:

$$\det [\underline{\underline{\epsilon}}(\Omega)] = \left\| \delta_{mn} - \tilde{R}_{mn}^0(\Omega) \tilde{G}(\Omega - n\omega_0) \right\| = 0 \quad (10.22)$$

For a narrow-band collective impedance $\tilde{G}(\Omega - n\omega_0)$ centred at $\pm n_0\omega_0$, with a bandwidth less than ω_0 , this determinant is simple to evaluate and the dispersion relation can be solved for the collective modes trivially.

The treatment of bunched beam stability for arbitrary impedances is complicated enough to be beyond our scope. It is a subject of much detailed study in the existing literature on storage-ring physics (see Ref. 42 and the references cited there). One will get a flavour of the complications, however, by looking at the next section, where a similar analysis is performed for the collective distortion of fluctuations in a bunched beam.

11. COLLECTIVE DISTORTION OF FLUCTUATION SPECTRUM

In studying the Schottky fluctuation spectrum in Section 3, we assumed uncorrelated particle trajectories. Interparticle interactions generate collective fields (as discussed in Section 8) which introduce correlations between particles. Such correlations deform the fluctuation spectrum. The phenomenon is similar to the Debye shielding of the field of a point test charge in a plasma by charge displacement (i.e. position correlations) due to collective Coulomb fields²⁵⁾.

If the collective interactions of the beam-storage-ring system through impedances or external feedback loops do not give rise to collective instabilities, but rather lead to an equilibrium situation between relevant interactions and the beam, the beam may be characterized by an equilibrium distribution with a characteristic temperature T , say. We may then apply a thermodynamical or equilibrium statistical-mechanical analysis to describe the deformation of fluctuations due to particle interactions induced by collective fields⁴³⁾. In the absence of such interactions, we saw in Section 3 [Eq. (3.52)] that the probability distribution for finding density harmonics $z_n(t) = \sum_{j=1}^N \exp[-in\theta_j(t)]$ in the beam is given by

$$g_n(z_n) = \frac{1}{(\pi N)} \exp\left(-\frac{|z_n|^2}{N}\right) \quad (11.1)$$

for longitudinal density fluctuations. If $V(i,j)$ is the longitudinal interaction energy between particles i and j induced by the longitudinal collective interaction, the probability distribution, taking into account particle interactions, is obtained simply by multiplying Eq. (11.1) by the equilibrium statistical-mechanical Boltzmann distribution

$$\exp\left(-\frac{E_{\text{int}}}{kT_{\parallel}}\right) = \exp\left[-\frac{1}{2kT_{\parallel}} \sum_{i,j=1}^N V(i,j)\right], \quad (11.2)$$

where T_{\parallel} is the longitudinal temperature of the beam, $E_{\text{int}} = 1/2 \sum_{i,j=1}^N V(i,j)$ is the total interaction energy, taken pair-wise [the factor 1/2 appearing because each particle is counted twice in the summation, once in $V(i,j)$ and then in $V(j,i)$], and k is the Boltzmann constant. From Eq. (8.25), the pair interaction energy between particles i and j induced by collective interaction through a longitudinal impedance $\tilde{Z}_{\parallel,n}(\Omega)$ of the beam-storage ring-system is

$$V(i,j) = (-i) \frac{q^2 \omega_0}{2\pi} \sum_{\substack{n=-\infty \\ \neq 0}}^{+\infty} \frac{\tilde{Z}_{\parallel,n}(n\omega_j)}{n} e^{in[\theta_i(t) - \theta_j(t)]} \left[1 + \mathcal{O}\left(\frac{\Delta\omega}{\omega_0}\right)\right] \quad (11.3)$$

If the total spread in angular velocities of the beam is small relative to ω_0 , i.e. $(\Delta\omega/\omega_0) \ll 1$, we may neglect the $\mathcal{O}(\Delta\omega/\omega_0)$ terms. Moreover, we may also assume that the impedance $\tilde{Z}_{\parallel,n}(n\omega_j)$ is almost constant over the range $n\Delta\omega$ of $n\omega_j$ in frequencies in the neighbourhood of $n\omega_0$ so that $\tilde{Z}_{\parallel,n}(n\omega_j) \approx \tilde{Z}_{\parallel,n}(n\omega_0) \equiv \tilde{Z}_{\parallel,n}$, the second identity being merely a definition. Then

$$E_{\text{int.}} = (-i) \frac{1}{2} \frac{q^2 \omega_0}{2\pi} \sum_{\substack{n=-\infty \\ \neq 0}}^{+\infty} \frac{\tilde{Z}_{\parallel,n}}{n} |z_n|^2 = \frac{1}{2} \frac{q^2 \omega_0}{2\pi} \sum_{n=-\infty}^{\infty} \frac{\text{Im}[\tilde{Z}_{\parallel,n}]}{n} |z_n|^2, \quad (11.4)$$

since $\tilde{Z}_{\parallel,n}^* = \tilde{Z}_{\parallel,-n}$ and $z_n^* = z_{-n}$ ($\text{Re } \tilde{Z}_{\parallel,n}$ is symmetric and even in n and cancels out by symmetry).

The longitudinal temperature T_{\parallel} in the frame of the beam may be written as

$$T_{\parallel} = \frac{\langle (\delta p)^2 \rangle}{m_{\text{eff}}} = \frac{1}{2} R \omega'(p_0) (\Delta p)^2 = \frac{1}{2} \frac{R(\Delta\omega)^2}{\omega'(p_0)} \quad (11.5)$$

consistent with a Gaussian distribution in ω around ω_0 , where the effective mass m_{eff} is given by

$$\frac{1}{m_{\text{eff}}} = R \left. \frac{d\omega(p)}{dp} \right|_{p=p_0} = R \omega'(p_0) = -R \omega_0 \frac{\eta}{p_0} \quad (11.6)$$

Note that the temperature as defined above is in units of energy. We thus delete k from our analysis from now on. Here R is the average radius of the ring, $\delta p = p - p_0$ is the momentum deviation from a nominal reference particle, and $(\Delta p)^2 = 2\langle(\delta p)^2\rangle$ and $(\Delta\omega)^2 = 2\langle(\delta\omega)^2\rangle$ are full dispersions in momentum and angular velocity of the beam. From Eqs. (11.2), (11.4), and (11.5), the probability distribution of density harmonics $z_n(t)$ in the beam in the presence of longitudinal interactions is given by

$$g_n(z_n) = A_n \exp \left[- \frac{|z_n|^2}{N} \left(1 + \frac{Nq^2\omega_0}{2\pi R \omega'(p_0) (\Delta p)^2} \frac{\text{Im}[\tilde{Z}_{\parallel, n}]}{n} \right) \right], \quad (11.7)$$

$$= A_n \exp \left[- \frac{|z_n|^2}{N} \left(1 - \frac{N}{N_{\text{cr}}} \right) \right], \quad (11.8)$$

where A_n is a normalization constant and we have introduced a quantity N_{cr} , the critical number of particles, given by

$$N_{\text{cr}} = - \frac{2\pi R \omega'(p_0) (\Delta p)^2}{q^2 \omega_0} \left(\frac{n}{\text{Im}[\tilde{Z}_{\parallel, n}]} \right) = - \frac{2\pi R (\Delta\omega)^2}{q^2 \omega_0 \omega'(p_0)} \left(\frac{n}{\text{Im}[\tilde{Z}_{\parallel, n}]} \right) \quad (11.9)$$

Note that the above equilibrium distribution of fluctuations, based on equilibrium statistical mechanics, remains valid in its canonical Boltzmann form only as long as

$$1 - \frac{N}{N_{\text{cr}}} > 0, \text{ i.e. } N < N_{\text{cr}}. \quad (11.10)$$

For beams containing a number of particles equal to or exceeding the critical number, $N \geq N_{\text{cr}}$, our analysis is completely invalidated. One observes that the above condition for the validity of thermodynamic analysis may also be written as

$$1 + \frac{Nq^2\omega_0\omega'(p_0)}{2\pi R(\Delta\omega)^2} \frac{\text{Im}[\tilde{Z}_{\parallel, n}]}{n} > 0, \quad (11.11)$$

which is the condition that the longitudinal collective interactions do not give rise to collective instabilities, i.e. a longitudinal stability condition²⁹⁾ for continuous coasting beams, N_{cr} coinciding with the threshold number of particles for longitudinal stability. [Compare with Eq. (10.20).]

The above statements concern the situation when $N_{cr} > 0$, i.e. $\omega'(p_0)(\text{Im} [\tilde{Z}_{\parallel,n}]/n) < 0$, which is the case below the transition energy of the ring $\eta < 0$, $\omega'(p_0) > 0$ and a $\text{Im} [\tilde{Z}_{\parallel,n}]/n < 0$ (inductive) or above the transition energy of the ring $\eta > 0$, $\omega'(p_0) < 0$ and a $\text{Im} [\tilde{Z}_{\parallel,n}]/n > 0$ (capacitive). But we note that N_{cr} may also be negative, e.g. below transition with a positive $\text{Im} [\tilde{Z}_{\parallel,n}]/n$ or above transition with a negative $\text{Im} [\tilde{Z}_{\parallel,n}]/n$. However, there are no collective longitudinal instabilities in these cases and $[1 - (N/N_{cr})]$ stays positive also. The thermodynamic analysis then remains valid for all N .

The density noise intensity, determined by the dispersion of the quantity z_n , is easily seen from Eq. (11.8) to be given by

$$\langle |z_n|^2 \rangle = N \frac{N_{cr}}{N_{cr} - N} \quad (11.12)$$

and the corresponding charge-density fluctuation intensity by [from Eq. (3.53)]

$$\langle |\rho_n|^2 \rangle = \frac{q^2}{4\pi^2} N \frac{N_{cr}}{N_{cr} - N} \quad (11.13)$$

If $N_{cr} < 0$, we may write these as

$$\langle |z_n|^2 \rangle = N \frac{|N_{cr}|}{|N_{cr}| + N} \quad \text{and} \quad \langle |\rho_n|^2 \rangle = \frac{q^2}{4\pi^2} N \frac{|N_{cr}|}{|N_{cr}| + N} \quad (11.14)$$

We see from Eq. (11.14) that if $N_{cr} < 0$ [i.e. $\omega'(p_0)(\text{Im} [\tilde{Z}_{\parallel,n}]/n) > 0$], the fluctuation strength is proportional to beam intensity N and is independent of the angular frequency spread or dispersion $(\Delta\omega)^2$, i.e. the temperature of the beam when $N \ll |N_{cr}|$:

$$\langle |z_n|^2 \rangle = N, \quad N \ll |N_{cr}| \quad (11.15)$$

In the other extreme situation when $N \gg |N_{cr}|$, the strength of fluctuations is independent of beam intensity N , but simply proportional to the beam temperature or dispersion in angular velocities:

$$\langle |z_n|^2 \rangle = |N_{cr}| = \frac{2\pi R(\Delta\omega)^2}{q^2 \omega_0 \omega'(p_0)} \frac{n}{\text{Im}[\tilde{Z}_{\parallel,n}]} = \frac{4\pi}{q^2 \omega_0} \left(\frac{n}{\text{Im}[\tilde{Z}_{\parallel,n}]} \right) T_{\parallel}, \quad (11.16)$$

$$N \gg |N_{cr}|$$

The two asymptotic limits above correspond to the familiar temperature-independent but beam-intensity-dependent ‘shot noise’ in one case ($\propto N$, $N \ll |N_{cr}|$) and the intensity-independent but temperature-dependent ‘Nyquist resistance noise’ in the other ($\propto T_{\parallel}$, $N \gg |N_{cr}|$). This behaviour of fluctuation strength as a function of beam intensity N , for $N_{cr} < 0$ is shown in Fig. 38.

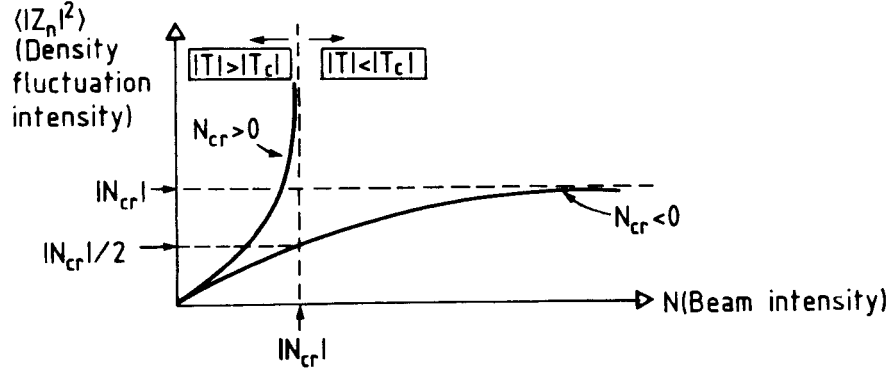

Fig. 38 Fluctuation intensity versus beam intensity for different regimes of temperature and N_{cr}

When $N_{cr} > 0$ [i.e. $\omega'(p_0)(\text{Im}[\tilde{Z}_{\parallel,n}]/n) < 0$], the collective interactions in the beam-storage-ring system generally leads to an enhancement of the fluctuation intensity for a given beam azimuthal harmonic n relative to the situation when $N_{cr} < 0$ for the same N and $|N_{cr}|$, as can be seen from Eqs. (11.13) and (11.14) [$(|N_{cr}| - N)^{-1} > (|N_{cr}| + N)^{-1}$ for $N < |N_{cr}|$]. Fluctuation intensity is still proportional to N for $N \ll N_{cr}$, but grows dramatically as N approaches N_{cr} , leading to infinitely large intensity fluctuations as $N \rightarrow N_{cr}$. Fluctuations are of course ill-defined for $N \geq N_{cr}$ in our formulation because of the breakdown of thermodynamical analysis as observed before and the onset of longitudinal collective instabilities. This critical behaviour of fluctuations is also shown in Fig. 38 for comparison with the case $N_{cr} < 0$. It is possible, for the case $N_{cr} > 0$, to define a critical temperature T_c by

$$T_c = - \frac{Nq^2\omega_0}{4\pi} \left[\frac{\text{Im}[\tilde{Z}_{\parallel,n}]}{n} \right] \quad (11.17)$$

Obviously $(T_c/T_{\parallel}) = (N/N_{cr}) > 0$ when $N_{cr} > 0$. The temperature $T_{\parallel} = R(\Delta\omega)^2/2\omega'(p_0) > 0$ when $\omega'(p_0) \propto -\eta > 0$, whence $T_c > 0$ since $\text{Im}[\tilde{Z}_{\parallel,n}]/n < 0$ for $N_{cr} > 0$; $T_{\parallel} < 0$ when $\omega'(p_0) \propto -\eta < 0$, whence $T_c < 0$ since $\text{Im}[\tilde{Z}_{\parallel,n}]/n > 0$. The region $|T_{\parallel}| \leq |T_c|$ is the region of collective longitudinal instability, where our fluctuations are not well defined. Our fluctuations exist only over the region $|T_{\parallel}| > |T_c|$ and become 'critical fluctuations' with infinitely large intensity in the limit $|T| \rightarrow |T_c|^+$, i.e. $T \rightarrow |T_c|^+$ for $T > 0$ or $T \rightarrow [-|T_c|]^-$ for $T < 0$. The different regions of quiescent stable fluctuations (shaded region), critical fluctuations (region of $\epsilon = T_{\parallel} - T_c \rightarrow 0^{\pm}$) and the region beyond critical fluctuations (unshaded region) with a sharp open-ended threshold or boundary (heavy line at T_c and $-|T_c|$) for critical fluctuations are mapped in the $T_{\parallel} - \text{Re}[\tilde{Z}_{\parallel,n}]/n$ plane in Fig. 39.

The threshold of critical fluctuations depends on the number of particles, N , in the beam, on the imaginary part of the beam-storage-ring impedance (both enter into T_c) and the angular velocity spread of the beam (which enters into beam temperature). Thus fluctuations may be critically enhanced either for large N , i.e. highly intense beam or for a very cool beam, i.e. low $(\Delta\omega)^2$, for the same $\text{Im}[\tilde{Z}_{\parallel,n}]/n$. In any case the threshold for critical fluctuations is also the threshold for the onset of collective instabilities which is nothing but a dramatic change in the collective phase or state of the beam, i.e. a phase transition. An increase in fluctuations of many-body systems near phase transitions at critical points is a near-universal feature and common knowledge. One can recognize that this phenomenon is not just of pure academic interest

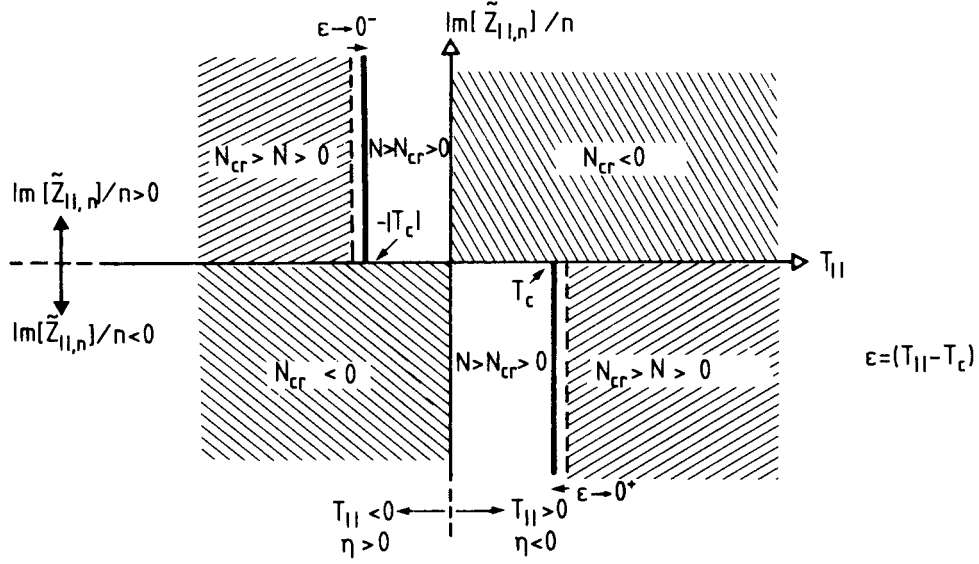

Fig. 39 Different regimes of fluctuations in the $T_{||}$ - $\text{Im}[\tilde{Z}_{||,n}]/n$ plane

for particle beams by noting that physical observation of such enhanced fluctuations in a particle beam by suitable Schottky pick-ups is always a hint at the onset of potential instabilities and a simultaneous detection of the same before they occur.

The above thermodynamic analysis based on equilibrium statistical mechanics is not entirely satisfactory. In particular the use of the Boltzman canonical distribution of equilibrium systems to particle beams is suspect. Full temperature equilibrium is never achieved in a particle beam in the time scales of our interest, where intrabeam scattering and other effects (noise) lead to slow temperature relaxation between all degrees of freedom below the transition energy of the storage ring. Above transition on the other hand, the beam is a rather funny equilibrium system characterized by a negative temperature and not at all similar to a spatially confined gas in thermal equilibrium^{7,44}). Since we know and have studied the beam fluctuations in the absence of interactions without any reference to the situation of thermal equilibrium, the relevant question to be answered is clear and precise whether an equilibrium exists or not, namely, How does the fluctuation spectral density at a given frequency Ω get modified when collective interactions characterized by an impedance $\tilde{Z}(\Omega)$ or feedback loop gain $\tilde{G}(\Omega)$ are present?

Analogous to the case of beam transfer function studied in Section 9, it is simple to visualize the modification due to collective interactions in terms of an infinite number of regeneration paths of the collectively modulated fluctuations through repeated cycles of the induced collective fields transferred subsequently by the beam transfer function to the particle trajectories, thus generating additional induced modulations in fluctuations and so on. Let us characterize the collective interaction by a lumped impedance function $\tilde{G}(\Omega)$ again as in Eq. (9.1) corresponding to local and localized interactions at a fixed azimuth $\theta = \theta_K$ in the storage ring (a resonating cavity at θ_K , for example). The mechanism then is simple: the incoherent current fluctuations $\tilde{I}_0^K(\Omega)$ at θ_K will generate induced voltage fields through $\tilde{G}(\Omega)$ given by $\tilde{G}(\Omega)\tilde{I}_0^K(\Omega)$ at θ_K , which in turn will generate modulations in beam current given by $\tilde{B}(\Omega)\tilde{G}(\Omega)\tilde{I}_0^K(\Omega)$ at θ_K and so on, where $\tilde{B}(\Omega)$ is the longitudinal beam transfer function for transfer through the whole ring to the same point $\theta = \theta_K$. Thus

$$\begin{aligned} \tilde{I}^K(\Omega) &= \tilde{I}_0^K(\Omega) + \tilde{B}(\Omega)\tilde{G}(\Omega)\tilde{I}_0^K(\Omega) + \tilde{B}(\Omega)\tilde{G}(\Omega)\tilde{B}(\Omega)\tilde{G}(\Omega)\tilde{I}_0^K(\Omega) + \dots \\ &= \left[1 + \tilde{B}(\Omega)\tilde{G}(\Omega) + \left(\tilde{B}(\Omega)\tilde{G}(\Omega) \right)^2 + \dots \right] \tilde{I}_0^K(\Omega) \end{aligned} \quad (11.18)$$

The situation is pictorially demonstrated in Fig. 40 below.

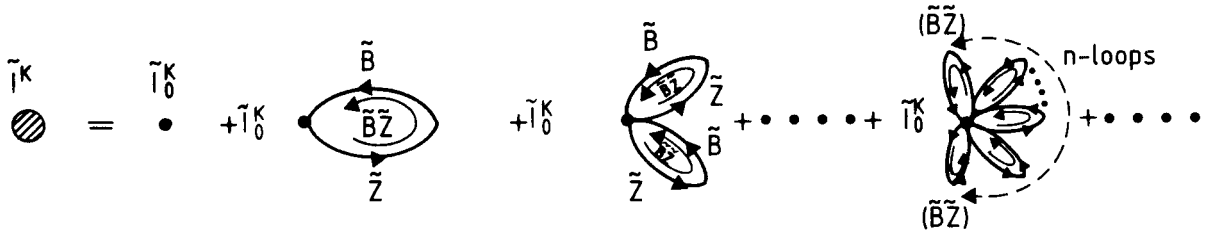

Fig. 40 The infinite series of regeneration loops leading to distortion of beam fluctuations by collective fields

The infinite series can be summed and the total collectively modulated Schottky current fluctuation is given by

$$\tilde{I}^K(\Omega) = \frac{\tilde{I}_0^K(\Omega)}{[1 - \tilde{B}(\Omega)\tilde{G}(\Omega)]} = \frac{\tilde{I}_0^K(\Omega)}{\epsilon(\Omega)}, \quad (11.19)$$

where $\epsilon(\Omega) = [1 - \tilde{B}(\Omega)\tilde{G}(\Omega)]$. Thus we may also represent the above distortion of fluctuations as a simpler closed loop feedback effect as shown in Fig. 41.

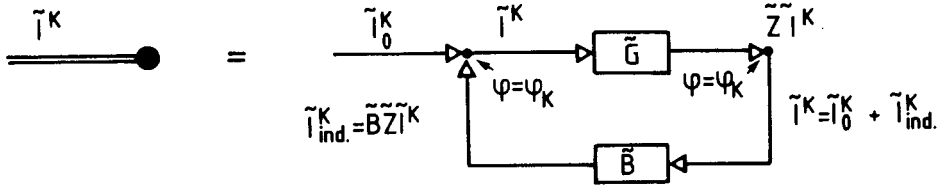

Fig. 41 Feedback flow representation of collective distortion of fluctuations

The power spectrum of current fluctuations is modified as

$$P_I^K(\Omega) = \langle \tilde{I}^K(\Omega)\tilde{I}^{K*}(\Omega) \rangle = \frac{\langle I_0^K(\Omega)\tilde{I}_0^{K*}(\Omega) \rangle}{|\epsilon(\Omega)|^2} = \frac{P_0^K(\Omega)}{|\epsilon(\Omega)|^2} = \frac{P_0^K(\Omega)}{|1 - \tilde{B}(\Omega)\tilde{G}(\Omega)|^2}. \quad (11.20)$$

The term $\chi(\Omega) = \tilde{B}(\Omega)\tilde{G}(\Omega)$ relates current to an induced current and is a pure gain function. It is called the ‘‘open loop gain’’ and $\epsilon(\Omega) = 1 - \chi(\Omega)$ the ‘closed loop signal suppression or distortion factor’. It is the same as the dispersion function $\epsilon(s = -i\Omega)$ studied in Section 10. In the context of plasma physics, where $\tilde{G}(\Omega)$ is provided by the purely internal electromagnetic interactions between charged particles within the plasma, $\chi(\Omega)$ and $\epsilon(\Omega)$ are known as the electromagnetic susceptibility and the dielectric permittivity of the plasma respectively. From (7.17) and (3.35), we can write down explicitly the total collectively modulated spectral density of longitudinal current fluctuations in a continuous coasting beam at $\theta = \theta_K$ as follows:

$$P_I^K(\Omega) = \frac{q^2 N}{2\pi} \cdot \frac{1}{|\epsilon(\Omega)|^2} \sum_{\substack{m=-\infty \\ \neq 0}}^{+\infty} \int d\omega \cdot \omega^2 \Psi_0(\omega) \delta[\Omega - m\omega] \quad (11.21)$$

$$= \frac{q^2 N}{2\pi} \sum_{\substack{m=-\infty \\ \neq 0}}^{+\infty} \frac{1}{|m|} \left(\frac{\Omega}{m} \right)^2 \frac{\Psi_0 \left(\frac{\Omega}{m} \right)}{|\varepsilon(\Omega)|^2}, \quad (11.22)$$

where

$$\varepsilon(\Omega) = 1 - \frac{Nq^2 K}{2} \tilde{G}(\Omega) \int d\omega \cdot \frac{\partial}{\partial \omega} [\omega \Psi_0(\omega)] \left[1 + i \cot \left(\frac{\pi \Omega}{\omega} \right) \right] = 1 - \sum_{n=-\infty}^{+\infty} \chi_n(\Omega) \quad (11.23)$$

and

$$\chi_n(\Omega) = -i \frac{Nq^2 K}{2\pi} \tilde{G}(\Omega) \lim_{\gamma \rightarrow 0^+} \int d\omega \cdot \omega \cdot \frac{\partial}{\partial \omega} [\omega \Psi_0(\omega)] \frac{1}{[\Omega - n\omega + i\gamma]} \quad (11.24)$$

It is easy to verify that current fluctuations at any other azimuth $\theta = \theta_P$ in the storage ring different from $\theta = \theta_K$ where the impedance is localized is given by

$$\begin{aligned} \tilde{I}^P(\Omega) &= \tilde{I}_0^P(\Omega) + \tilde{\mathcal{R}}^{PK}(\Omega) \tilde{G}(\Omega) \tilde{I}^K(\Omega) = \tilde{I}_0^P(\Omega) + \frac{\tilde{\mathcal{R}}^{PK}(\Omega) \tilde{G}(\Omega) \tilde{I}_0^K(\Omega)}{[1 - \tilde{B}(\Omega) \tilde{G}(\Omega)]} \\ &= \tilde{I}_0^P(\Omega) + \tilde{\mathcal{R}}^{PK}(\Omega) \tilde{G}(\Omega) \frac{\tilde{I}_0^K(\Omega)}{\varepsilon(\Omega)} \\ &= \tilde{I}_0^P(\Omega) + \frac{\chi^{PK}(\Omega) \tilde{I}_0^K(\Omega)}{\varepsilon(\Omega)} \end{aligned} \quad (11.25)$$

If θ_P and θ_K correspond to the locations of the pick-up and the kicker in a stochastic cooling feedback loop, then the collective fields are localized at $\theta = \theta_K$ but are derived, however, from the beam current at $\theta = \theta_P$ through an overall gain function $\tilde{G}(\Omega)$ of the loop. We thus have to replace $\tilde{I}_0^K(\Omega)$ by $\tilde{I}_0^P(\Omega)$, and $\tilde{B}(\Omega)$ by $\tilde{\mathcal{R}}^{PK}(\Omega)$. One then obtains

$$\tilde{I}^P(\Omega) = \frac{\tilde{I}_0^P(\Omega)}{[1 - \tilde{\mathcal{R}}^{PK}(\Omega) \tilde{G}(\Omega)]} = \frac{\tilde{I}_0^P(\Omega)}{\varepsilon^{PK}(\Omega)}, \quad (11.26)$$

where

$$\varepsilon^{PK}(\Omega) = 1 - \tilde{\mathcal{R}}^{PK}(\Omega) \tilde{G}(\Omega) = 1 - \chi^{PK}(\Omega) \quad (11.27)$$

For a storage-ring-beam system characterized by a local impedance which is, however, not localized but distributed around the ring, we have $\tilde{V}_{ind}(\theta, \Omega) = \tilde{G}(\Omega) \tilde{I}(\theta, \Omega)$ for all θ ; collective fields produce modulations in the beam all around the storage ring, and above considerations based on localized collective induction at a fixed azimuth are no longer valid. However, we could again consider contribution at θ to $\tilde{I}(\theta, \Omega)$ to be built up from the following series over an infinite number of regeneration paths:

$$\begin{aligned} \tilde{I}(\theta, \Omega) &= \tilde{I}_0(\theta, \Omega) + \int d\theta' \tilde{\mathcal{R}}(\theta, \theta' | \Omega) \tilde{G}(\Omega) \tilde{I}_0(\theta', \Omega) \\ &\quad + \int d\theta' \int d\theta'' \tilde{\mathcal{R}}(\theta, \theta'' | \Omega) \tilde{G}(\Omega) \tilde{\mathcal{R}}(\theta'', \theta' | \Omega) \tilde{G}(\Omega) \tilde{I}_0(\theta', \Omega) + \dots \end{aligned} \quad (11.28)$$

For a continuous beam, $\tilde{\mathcal{R}}(\theta, \theta' | \Omega) \equiv \tilde{\mathcal{R}}(\theta - \theta' | \Omega)$ is a function of $(\theta - \theta')$ alone and all the integrals above are then convolutions. It is then convenient to use a Fourier harmonic decomposition in angle θ , leading to an algebraic relation for a particular azimuthal harmonic n of the fluctuations

$$\tilde{\mathcal{I}}_n(\Omega) = \left[1 + 2\pi\tilde{\mathcal{R}}_n(\Omega)\tilde{\mathcal{G}}(\Omega) + \left(2\pi\tilde{\mathcal{R}}_n(\Omega)\tilde{\mathcal{G}}(\Omega) \right)^2 + \dots \right] \tilde{\mathcal{I}}_{0,n}(\Omega) \quad (11.29)$$

$$\tilde{\mathcal{I}}_n(\Omega) = \frac{\tilde{\mathcal{I}}_{0,n}(\Omega)}{\left[1 - 2\pi\tilde{\mathcal{R}}_n(\Omega)\tilde{\mathcal{G}}(\Omega) \right]} = \frac{\tilde{\mathcal{I}}_{0,n}(\Omega)}{\epsilon_n(\Omega)}, \quad (11.30)$$

where $\epsilon_n(\Omega) = 1 - 2\pi\tilde{\mathcal{R}}_n(\Omega)\tilde{\mathcal{G}}(\Omega) = 1 - \chi_n(\Omega)$. Fluctuations at a given azimuth θ are then

$$\tilde{\mathcal{I}}(\theta, \Omega) = \sum_{\substack{n=-\infty \\ \neq 0}}^{+\infty} \tilde{\mathcal{I}}_n(\Omega) e^{in\theta} = \sum_{n=-\infty}^{+\infty} \frac{\tilde{\mathcal{I}}_{0,n}(\Omega)}{\epsilon_n(\Omega)} e^{in\theta} \quad (11.31)$$

The power spectral densities are

$$\left[P_{\mathcal{I}} \right]_n(\Omega) = \langle |\tilde{\mathcal{I}}_n(\Omega)|^2 \rangle = \frac{|\tilde{\mathcal{I}}_{0,n}(\Omega)|^2}{|\epsilon_n(\Omega)|^2} = \frac{\left[P_{\mathcal{I}}^0 \right]_n(\Omega)}{|\epsilon_n(\Omega)|^2} \quad (11.32)$$

and

$$P_{\mathcal{I}}(\Omega) = \sum_n \left[P_{\mathcal{I}} \right]_n(\Omega) = \sum_n \frac{\left[P_{\mathcal{I}}^0 \right]_n(\Omega)}{|\epsilon_n(\Omega)|^2} \quad (11.33)$$

Finally, for both non-local and non-localized beam-storage-ring interactions, as for example for propagating structures, one simply has to replace $2\pi\tilde{\mathcal{G}}(\Omega)$ by $\tilde{\mathcal{G}}_n(\Omega)$ so that

$$\epsilon_n(\Omega) = 1 - \chi_n(\Omega) = 1 - \tilde{\mathcal{R}}_n(\Omega)\tilde{\mathcal{G}}_n(\Omega) \quad (11.34)$$

We mention here that all the above results can also be derived directly from the Vlasov equation (6.5) for collective propagation, linearized in the coherent perturbation, with the Schottky fluctuations as the inhomogeneous driving or source term. The results are exactly identical. We have adopted instead the diagrammatic demonstration scheme above with the hope that it will illustrate the basic mechanisms involved with probably more clarity.

The roots $\{\Omega_m\}$ of the equation $\epsilon(\Omega) = 0$, as we have seen before, provide the oscillation frequencies of the collective coherent modes of the beam. If the roots $\{\Omega_m\}$ have imaginary parts the modes may be unstable depending on the sign of the imaginary part (growing or decaying for negative or positive imaginary part). If they contain no imaginary part, the modes are stable with $\{\Omega_m\}$ giving the real oscillation frequency of the mode. In either case, as $\Omega \rightarrow \Omega_m$, $\epsilon(\Omega) \rightarrow 0$ and the fluctuations would have to grow to infinitely large strengths. These are the 'critical fluctuations' suggested before by the thermodynamic limit.

Let us consider now the case when $\epsilon(\Omega) \neq 0$, i.e. the beam is not in a collectively excited mode. For small relative spreads in beam angular velocities $(\Delta\omega/\omega_0) \ll 1$, i.e. $\omega \approx \omega_0$, we may write, from (11.23) and (11.24), for the longitudinal $\epsilon_n(\Omega)$:

$$\epsilon_n(\Omega) = 1 - \chi_n(\Omega) = 1 + \frac{(\Delta\Omega_n)^2}{n} \lim_{\gamma \rightarrow 0^+} \int d\omega \frac{\frac{\partial}{\partial\omega} \Psi_0(\omega)}{[\Omega - n\omega + i\gamma]}, \quad (11.35)$$

where

$$(\Delta\Omega_n)^2 = \frac{(-i)Nq^2\kappa \tilde{G}(\Omega)n\omega_0^2}{2\pi} = \frac{(-i)Nq^2\omega_0^3 \eta \tilde{G}(\Omega)n}{2\pi\beta^2 E} \quad (11.36)$$

Let us take a purely reactive impedance $\tilde{G}(\Omega) = -i\tilde{Z}_{||}(\Omega)$ [capacitive if $\tilde{Z}_{||}(\Omega)$ is positive and inductive if it is negative] and a sign of η such that $\Delta\Omega_n^2$ is always positive and given by

$$(\Delta\Omega_n)^2 = \frac{Nq^2\omega_0^3 |\eta| |\tilde{Z}_{||}(\Omega)| n}{2\pi\beta^2 E} \quad (11.37)$$

There are then no unstable collective modes; however, there may be stable modes with real frequencies Ω_n . In particular for a beam with zero spread in angular velocities $\Psi_0(\omega) = \delta(\omega - \omega_0)$, the real coherent oscillation frequencies are $\Omega_n = n\omega_0 \pm \Delta\Omega_n$. Thus $|\Delta\Omega_n| = |\Omega_n - n\omega_0|$ may be interpreted as the coherent frequency shift due to the impedance, in the absence of any frequency spread $(\Delta\omega)$ in the beam.

For a small number of particles in the beam and small $|\tilde{Z}_{||}(\Omega)|$, $\epsilon(\Omega) \approx 1$ since $\Delta\Omega_n \approx 0$. Fluctuations are relatively unaffected by collective interactions. For a Gaussian beam distribution

$$\Psi_0(\omega) = \frac{1}{\sqrt{\pi}(\Delta\omega)} \exp \left[-\frac{(\omega - \omega_0)^2}{(\Delta\omega)^2} \right] \quad (11.38)$$

we obtain for $N \ll N_{cr}$

$$\langle |\tilde{z}_n^0(\Omega)|^2 \rangle = N \int \Psi_0(\omega) \delta(\Omega - n\omega) = \frac{N}{\sqrt{\pi} |n\Delta\omega|} \exp \left[-\frac{(\Omega - n\omega_0)^2}{n^2 (\Delta\omega)^2} \right] \quad (11.39)$$

The width of the spectrum around $\Omega = n\omega_0$ is typically $n\Delta\omega$, determined by the angular velocity spread $(\Delta\omega)$ in the beam. The total fluctuation power in harmonic n is simply

$$\langle |\tilde{z}_n^0|^2 \rangle = \int_{-\infty}^{+\infty} d\Omega \langle |\tilde{z}_n^0(\Omega)|^2 \rangle = N \quad (11.40)$$

as obtained before.

If the number of particles is large enough, $N \gg N_{cr}$, $\epsilon(\Omega)$ may deviate substantially from unity. The result is either a suppression of fluctuation intensity if $|\epsilon(\Omega)| \gg 1$ or an enhancement if $|\epsilon(\Omega)| \ll 1$. Evaluating $\epsilon_n(\Omega)$ explicitly for the same Gaussian distribution one obtains

$$\epsilon_n(\Omega) \approx 1 - \frac{(\Delta\Omega_n)^2}{(\Omega - n\omega_0)^2} + i \frac{2\sqrt{\pi} (\Delta\Omega_n)^2 (\Omega - n\omega_0)}{|n\Delta\omega|^3} \exp\left[-\frac{(\Omega - n\omega_0)^2}{n^2 (\Delta\omega)^2}\right], \quad (11.41)$$

where the second term comes from the principal value integral and the third from the delta-function pole term. The spectrum $\langle |\tilde{z}_n(\Omega)|^2 \rangle = \langle |\tilde{z}_n^0(\Omega)|^2 \rangle / |\epsilon_n(\Omega)|^2$ then has two peaks at $\Omega = n\omega_0 \pm \Delta\Omega_n$ each one with a width $\delta\Omega_n$ given by

$$\delta\Omega_n = (\Delta\Omega_n) \left(\frac{\Delta\Omega_n}{n\Delta\omega}\right)^3 \exp\left[-\frac{(\Delta\Omega_n)^2}{n^2 (\Delta\omega)^2}\right] \quad (11.42)$$

The distortion of fluctuation intensity as a function of the number of particles N or equivalently $\Delta\Omega_n$ is shown in Fig. 42^{43,45}.

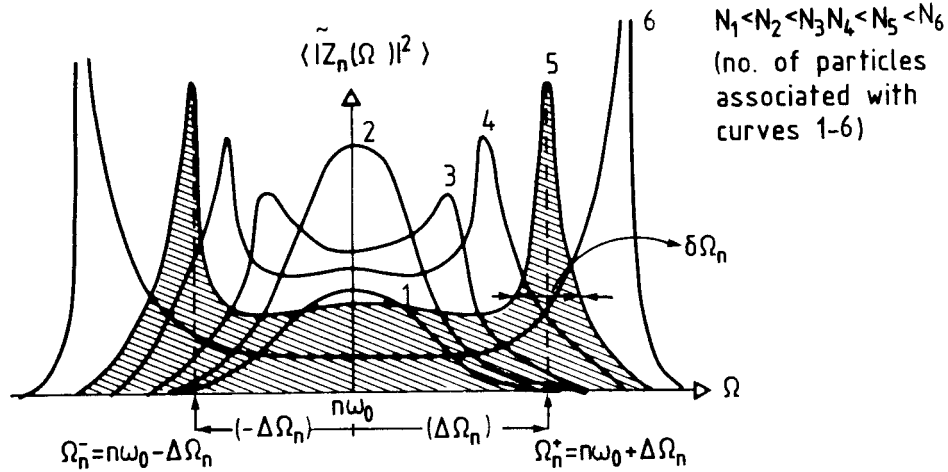

Fig. 42 Clustering of fluctuations around the coherent frequencies as a function of increasing N

The total fluctuation power in harmonic n is calculated to be

$$\begin{aligned} \langle |z_n|^2 \rangle &= \int \left[\frac{\langle |\tilde{z}_n^0(\Omega)|^2 \rangle}{|\epsilon_n(\Omega)|^2} \right] d\Omega \approx N \left(\frac{n\Delta\omega}{\Delta\Omega_n} \right)^2 = \frac{2\pi R_0 (\Delta\omega)^2}{q^2 \omega_0 \omega' (p_0)} \left(\frac{n}{\tilde{z}_{\parallel, n}} \right) \\ &= \frac{4\pi}{q^2 \omega_0} \left(\frac{n}{\tilde{z}_{\parallel, n}} \right) T_{\parallel} = |N_{cr}|, \end{aligned} \quad (11.43)$$

which agrees with Eq. (11.16), where $\tilde{Z}_{\parallel, n} = \tilde{Z}_{\parallel}(\Omega_n)$.

Thus for $(\Delta\Omega_n)^2 \ll (\Delta\omega)^2$, the spectrum remains unperturbed and close to a Gaussian. For $(\Delta\Omega_n)^2 \geq (\Delta\omega)^2$, the spectrum gets highly distorted and most of the fluctuation intensity gets concentrated near the frequencies $\Omega_n = n\omega_0 \pm \Delta\Omega_n$ while the total intensity in the harmonic n remains the same, given by $|N_{cr}|$, proportional to beam temperature.

The fluctuations peak at the harmonic of the fundamental revolution frequency $n\omega_0$ for low number of particles N due to the velocity distribution of the beam. For large N , the peaks occur at $\Omega_n = n\omega_0 \pm \Delta\Omega_n$, different from the harmonic of the fundamental, $n\omega_0$. These peaks correspond to coherent propagation of fluctuation waves, one along the beam and the other in the opposing direction in the beam frame (Fig. 43). Their phase angular velocities are $(+\Delta\Omega_n/n)$ and $(-\Delta\Omega_n/n)$

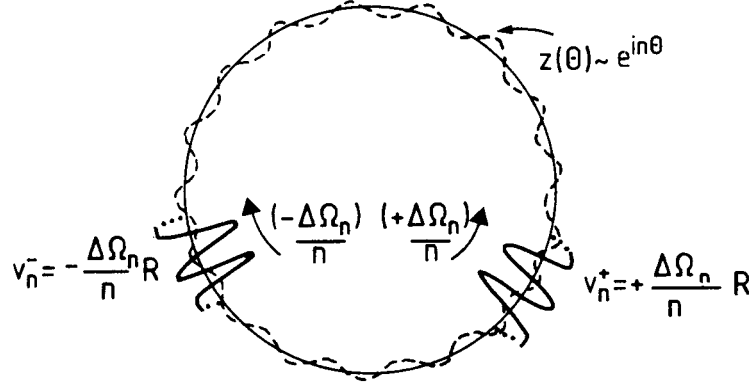

Fig. 43 Coherent propagation of fluctuation waves in the beam frame

in the beam frame and $[\omega_0 + (\Delta\Omega_n/n)]$ and $[\omega_0 - (\Delta\Omega_n/n)]$ in the laboratory frame. The linear velocities in the beam frame are $v_n^\pm = \pm(\Delta\Omega_n/n) R$. Since $\Delta\Omega_n$ depends on N , these waves move with speeds that depend on the number of particles in the beam. For $N \ll |N_{cr}|$, i.e. low intensity beams, the fluctuation waves disappear completely, with their propagation being dissipated by the thermal motion of the particles, i.e. the waves are totally Landau-damped. At large N , $(\Delta\Omega_n)^2 \gg (\Delta\omega)^2$, Landau damping is substantially lost. However, the small amount of residual Landau damping due to finite $(\Delta\omega)$ makes the large- N coherent propagation of fluctuation waves to be slowly damped (Landau damping is discussed in Section 13).

Use of the Gaussian distribution for the beam has allowed us to connect with the results obtained from thermodynamic analysis. A Gaussian distribution is reminiscent of the beam being close to thermodynamic equilibrium. However, we can make additional statements for such equilibrium states based on our general analysis which we did not obtain in the thermodynamic limit. For example comparing Eqs. (11.39), (11.41) and (11.43) we may write

$$\langle |\tilde{z}_n^0(\Omega)|^2 \rangle = \frac{N}{2\pi} \left(\frac{n\Delta\omega}{\Delta\Omega_n} \right)^2 \frac{\text{Im}[\epsilon_n(\Omega)]}{[\Omega - n\omega_0]} \quad (11.44)$$

and

$$\langle |\tilde{z}_n(\Omega)|^2 \rangle = \frac{\langle |\tilde{z}_n^0(\Omega)|^2 \rangle}{|\epsilon_n(\Omega)|^2} = \frac{N}{2\pi} \cdot \left(\frac{n\Delta\omega}{\Delta\Omega_n} \right)^2 \frac{1}{[\Omega - n\omega_0]} \frac{\text{Im}[\epsilon_n(\Omega)]}{|\epsilon_n(\Omega)|^2} \quad (11.45)$$

Here $\text{Im}[\epsilon_n(\Omega)]$ is the imaginary part or discontinuity of $\epsilon_n(\Omega)$ on the real Ω -axis. This is a specialized equilibrium version of the general Fluctuation-Dissipation relationship which we will discuss in Section 14. We will see there that the fluctuations and the dielectrical permittivity $\epsilon_n(\Omega)$ are intrinsically related [note that $\epsilon_n(\Omega)$ depends on the beam response]. They are thus not independent of each other and knowledge of one allows us to know the other.

A parallel analysis for the collective distortion of transverse fluctuation spectrum can be performed. The distortion in fluctuations would be characterized by a transverse closed loop distortion factor or dielectric permittivity function $\epsilon_{\perp}(\Omega) = [1 - q(\gamma, m)\tilde{B}_{\perp}(\Omega)\tilde{g}_{\perp}(\Omega)]$ where $\tilde{B}_{\perp}(\Omega)$ is the full-ring transverse beam transfer function relating induced dipole-moment current density to imposed transverse force and $\tilde{g}_{\perp}(\Omega)$ is related to the transverse coupling impedance of the beam-storage-ring system as $\tilde{g}_{\perp}(\Omega) = (i\omega_0^2/2\pi m\gamma, c)\tilde{Z}_{\perp}(\Omega)$. For stochastic cooling systems one would simply replace $\tilde{B}_{\perp}(\Omega)$ by $\tilde{R}_{\perp}^{PK}(\Omega)$, the transverse beam transfer function from kicker to pick-up and $q(\gamma, m)\tilde{g}_{\perp}(\Omega)$ by a general gain function $\tilde{G}(\Omega)$ relating dipole modulations at pick-up to the force fields at the kicker determined by the transfer function of the cooling feedback loop. We leave it to the reader to indulge in such an adventure for the continuous coasting beam. We only briefly discuss the transverse case for the bunched beam fluctuations instead, to sketch some of the intrinsic complications involved, as is typically the case for all collective aspects of bunched beams.

It is obvious from the nature of the beam transfer function of bunched beams that the beam feedback loop describing deformation of fluctuations by collective effects as in Fig. 41 cannot be closed at a single frequency Ω any more, but involves all the frequency translates $\Omega + k\omega_0$, $k = 0, \pm 1, \pm 2, \dots$, etc., in the loop. This is illustrated in Fig. 44a. In Fig. 44b, we show the mechanism by which a frequency $\Omega + k\omega_0$, different from Ω for $k \neq 0$, contributes through beam

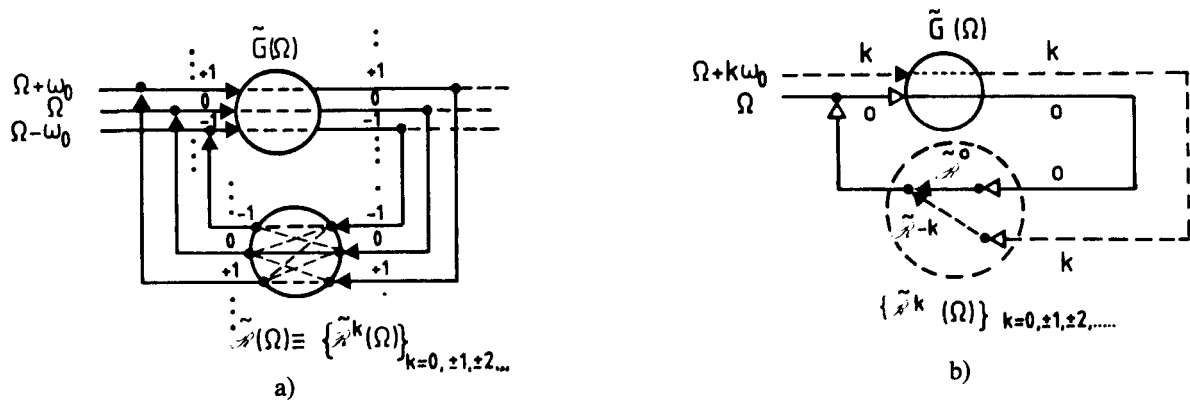

Fig. 44 Matrix feedback flow of collective distortion of bunched beam fluctuations

feedback [through $\tilde{G}(\Omega + k\omega_0)$ followed by $\tilde{\mathcal{R}}^{-k}(\Omega)$] to the deformation of fluctuation at frequency Ω . Instead of a scalar relation for fluctuation deformation at a frequency Ω , we have a matrix relation for bunched beams involving all $\Omega + k\omega_0$, $k = 0, \pm 1, \dots$ and the problem is essentially to invert the infinite matrix which is non-trivial in general⁷⁾. The deformed transverse fluctuations are obtained by inverting the coupled equations

$$\tilde{d}(\Omega) = \sum_{k=-\infty}^{+\infty} \chi_k(\Omega) \tilde{d}(\Omega + k\omega_0) + \tilde{d}_0(\Omega), \quad (11.46)$$

where

$$\chi_k(\Omega) = \tilde{G}(\Omega + k\omega_0)\tilde{\mathcal{R}}^k(\Omega) \quad (11.47)$$

Let us consider an impedance or gain $\tilde{G}(\Omega)$ which is non-zero only over one single non-overlapping betatron band $[\Omega = \Omega_m^\pm = (m \pm Q)\omega_0 + \Omega']$ where $-\Delta_m^\pm \leq \Omega' \leq +\Delta_m^\pm$, Δ_m^\pm being the half-width of the betatron band $(m \pm Q)$ and zero everywhere else. Then only the $k = 0$ term contributes in Eq. (11.46). We get from Eqs. (7.48) and (11.46) the closed loop collectively modulated transverse fluctuations to be given by

$$\tilde{d}(\Omega) = \frac{\tilde{d}_0(\Omega)}{1 - \chi_0(\Omega)} = \frac{\tilde{d}_0(\Omega)}{\epsilon_\perp(\Omega)}; \quad \Omega = \Omega_m^\pm = (m \pm Q)\omega_0 + \Omega' \quad (11.48)$$

or

$$\tilde{d}_m^\pm(\Omega') = \frac{\tilde{d}_{0,m}^\pm(\Omega')}{1 - \chi_{0,m}^\pm(\Omega')} = \frac{\tilde{d}_{0,m}^\pm(\Omega')}{\epsilon_{\perp,m}^\pm(\Omega')}, \quad (11.49)$$

where

$$\epsilon_\perp(\Omega) = \epsilon_{\perp,m}^\pm(\Omega') = 1 + \frac{q I_0 N \pi \tilde{G}(\Omega_m^\pm)}{2m_0 \gamma_r Q \omega_0} \int_0^\infty da \cdot \Psi_0(a) \cdot \frac{1}{\omega_s(a)} \times \frac{J_{\nu(a)}[(m \pm Q - Q_\eta^\xi)a] J_{-\nu(a)}[(m \pm Q - Q_\eta^\xi)a]}{\sin[\pi \nu(a)]} \quad (11.50)$$

and

$$\nu(a) = \nu_m^\pm(a) = \frac{\Omega_m^\pm - (m \pm Q)\omega_0}{\omega_s(a)} = \frac{\Omega'}{\omega_s(a)}. \quad (11.51)$$

For this non-overlapping betatron band situation, the BTF at frequency Ω will contain a contribution from the $(m \pm Q)$ band dominantly in the summation over n . The factor $\epsilon_\perp(\Omega_m^\pm) = [1 - \chi_0(\Omega_m^\pm)]$ measures the suppression or enhancement of fluctuations (see Fig. 45) due to collective interactions affecting the single betatron band $(m \pm Q)$. All other bands remain unaffected. The power spectrum in the affected band is simply $\langle |\tilde{d}(\Omega)|^2 \rangle = \langle |\tilde{d}_0(\Omega)|^2 \rangle / |\epsilon_\perp(\Omega)|^2$. The expression is valid for non-overlapping betatron bands but includes exactly the overlapping of synchrotron bands within the betatron band.

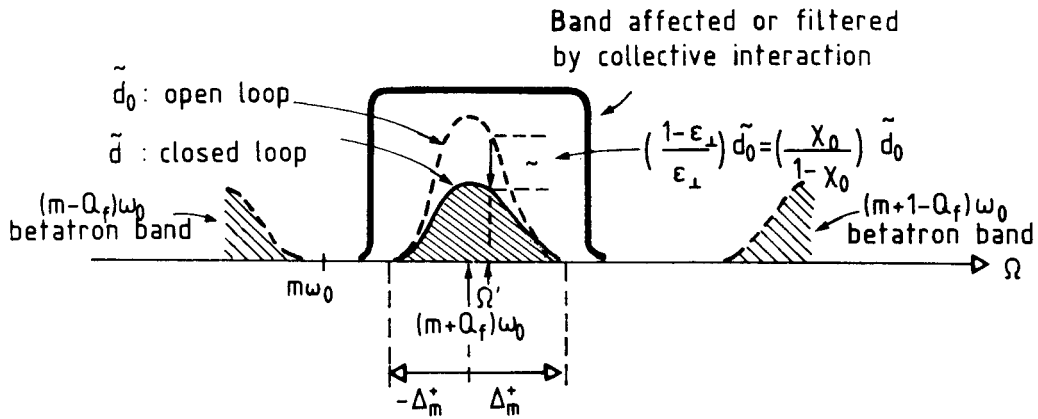

Fig. 45 Suppression of fluctuations in the band affected by impedance

If the betatron bands overlap at the frequencies of interest, but the collective interaction has a bandwidth $W \leq f_0/2$ centred around $\Omega = (m \pm Q)\omega_0$ as above, we again have an exact expression for the dielectric suppression factor within the bandwidth, i.e. for frequencies $\Omega = (m \pm Q)\omega_0 + \Omega'$ with $|\Omega'| \leq f_0/2$, but now involving a summation over all the overlapping betatron bands:

$$\begin{aligned} \epsilon_{\perp}(\Omega_m^{\pm}) = \epsilon_{\perp,m}^{\pm}(\Omega') = 1 + \frac{q I_0 N \pi}{2m_0 \gamma_r Q \omega_0} \sum_n \sum_{(\pm)} \int_0^{\infty} da \cdot \Psi_0(a) \cdot \frac{1}{\omega_s(a)} \tilde{G}(\Omega_m^{\pm}) \\ \times \frac{J_{\nu_{mn}^{\pm}}(a) [(n \pm Q - Q_{\eta}^{\xi})a] J_{-\nu_{mn}^{\pm}}(a) [(n \pm Q - Q_{\eta}^{\xi})a]}{\sin [\pi \nu_{mn}^{\pm}(a)]}, \end{aligned} \quad (11.52)$$

where

$$\nu_{mn}^{\pm}(a) = \frac{\Omega_m^{\pm} - (n \pm Q)\omega_0}{\omega_s(a)} = \frac{(m \pm Q - n \mp Q)\omega_0 + \Omega'}{\omega_s(a)} \quad (11.53)$$

We note that for zero spread in synchrotron frequencies, i.e. $\omega_s(a) = \omega_s = \text{constant}$, the fluctuations form an exact line spectrum $\Omega = (m \pm Q)\omega_0 + \mu\omega_s$ with zero widths at frequencies of interest within the betatron band. For non-overlapping bands all the possible values of ν_m^{\pm} are integers $\nu_m^{\pm} = \mu$ and for overlapping bands there are at least a few values of ν_{mn}^{\pm} which are integers, whence $\sin[\pi\mu] = 0$ and $\chi_0(\Omega_{m,\mu}^{\pm}) \rightarrow \infty$. The only consistent solution to Eq. (11.49) is $\tilde{d}(\Omega_{m,\mu}^{\pm}) = 0$. Thus for vanishing synchrotron frequency spread, the collective interaction coupled with feedback through beam response reduces the closed loop fluctuations to zero. With non-zero spread in synchrotron frequencies, the poles in $[\sin \pi \nu_{mn}^{\pm}(a)]^{-1}$ at harmonics of synchrotron frequency locally in the neighbourhood of amplitude 'a' are smeared out by the integration over the amplitude distribution and one is left with a residual non-zero strength of fluctuations even with the collective feedback loop closed.

As observed in Eqs. (7.50) to (7.53), we observe that it is possible to interpret the collective distortion of bunched beam fluctuations as corresponding to that of an equivalent continuous coasting beam with an effective distribution $\Psi_0^{n,\pm}(\omega)$ in angular revolution frequencies with half-width Δ_n^{\pm} , as far as the $(n \pm Q)$ betatron band is concerned and may be written as

$$\epsilon_{\perp}(\Omega_m^{\pm}) = 1 + \frac{q I_0 N}{2m_0 \gamma_r \omega_0 Q} \lim_{\gamma \rightarrow 0^+} \sum_n \sum_{(\pm)} \int_{-\Delta_m^{\pm}}^{+\Delta_m^{\pm}} d\omega \frac{\Psi_0^{n,\pm}(\omega)}{[\Omega_m^{\pm} - (n \pm Q)\omega + i\gamma]} \tilde{G}(\Omega_m^{\pm}) \quad (11.54)$$

If the collective interaction $\tilde{G}(\Omega)$ has a bandwidth that includes several betatron bands but much less than the bunch frequency $f_B = 1/\Delta t$ where Δt is the bunch duration at any azimuth of the storage ring, i.e. if

$$f_0 \ll W \ll f_B = (\Delta t)^{-1},$$

all the betatron harmonics within the bandwidth are now coherent (Fig. 46) and strongly coupled according to

$$\tilde{d}(\Omega) = \sum_{\Delta k = (2\pi W)/\omega_0} \chi_k(\Omega) \tilde{d}(\Omega + k\omega_0) + \tilde{d}_0(\Omega), \quad (11.55)$$

where $(m \pm Q)f_0 - W/2 \leq \Omega \leq (m \pm Q)f_0 + W/2$. For non-overlapping betatron bands, the (+) and (-) betatron bands are decoupled as they cannot be translated into each other by finite translations of multiples of ω_0 , unless the betatron tune $Q = 0.5$, which we exclude. However, the $N_\ell = n_\ell/2 = (W/f_0)$ (+)-bands and the same number of (-)-bands are strongly coupled within themselves owing to the bunched nature of the beam. However, this coupling strength is approximately the same for all k within the bandwidth, i.e. $\chi_k(\Omega) = \chi_0(\Omega)\delta_{k,0}$ where $k \in \Delta k = (2\pi W/f_0)$. To see this we set $n \pm Q - Q(\xi/\eta) = x$ and use the identity

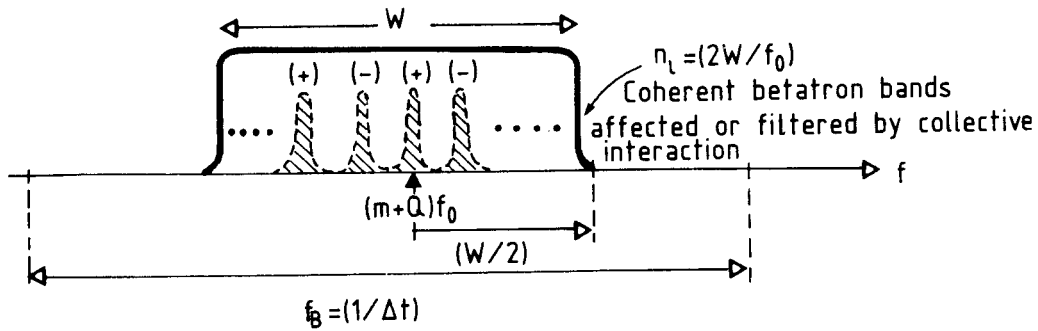

Fig. 46 Fluctuation bands affected by an impedance with bandwidth less than the bunch coherence length in frequency

$$\begin{aligned} J_\mu(xa)J_\mu[(x-k)a] &= J_\mu(xa) \sum_p J_{\mu+p}(xa)J_p(-ka) \\ &= J_\mu(xa) [J_\mu(xa)J_0(-ka) + J_{\mu+1}(xa)J_1(-ka) + \dots] \\ &= J_\mu^2(xa)J_0(-ka) + J_\mu(xa)J_{\mu+1}(xa)J_1(-ka) + \dots \end{aligned} \quad (11.56)$$

Now $ka_{\max} \sim k\omega_0\Delta t = 2\pi k(f_0/f_B)$. Since $(kf_0) \ll f_B$ for the bandwidth considered, $ka \sim 0$ and $\lim_{x \rightarrow 0} [J_\mu(x)]_{\mu \neq 0} \rightarrow 0$. Thus $J_1(ka) \sim J_2(ka) \sim J_n(ka) \approx 0$ and the coupling is expressed only by $\lim_{ka \rightarrow 0} J_0(ka) \approx J_0(0) = 1$. Thus all the betatron bands couple with equal strength and we get

$$\tilde{d}(\Omega) = \chi_0(\Omega) \sum_{k \in \Delta k = (W/f_0)} \tilde{d}(\Omega + k\omega_0) + \tilde{d}_0(\Omega) \quad (11.57)$$

The consistent solution then is given by

$$\sum_{m \in W} \tilde{d}(\Omega_m^\pm) = \frac{\sum_{m \in W} \tilde{d}_0(\Omega_m^\pm)}{[1 - N_\ell \chi_0(\Omega')]} = \frac{\sum_{m \in W} \tilde{d}_0(\Omega_m^\pm)}{\epsilon_\perp(\Omega')}; \quad \Omega_m^\pm = (m \pm Q)\omega_0 + \Omega' \quad (11.58)$$

$m \in \Delta m = (W/f_0)$

We observe that we can write Eq. (11.46) in the following matrix form

$$\tilde{d}_m(\Omega) = \sum_n \chi_{mn}(\Omega) \tilde{d}_n(\Omega) + \tilde{d}_{0,m}(\Omega) \quad (11.59)$$

or

$$\sum_n \epsilon_{mn}(\Omega) \tilde{d}_n(\Omega) = \tilde{d}_{0,m}(\Omega), \quad (11.60)$$

where

$$\tilde{d}_m(\Omega) = \tilde{d}(\Omega + m\omega_0) \quad (11.61)$$

$$\epsilon_{mn}(\Omega) = \delta_{mn} - \chi_{mn}(\Omega) \quad (11.62)$$

and

$$\chi_{mn}(\Omega) = \chi_{n-m}(\Omega + m\omega_0) \quad (11.63)$$

For $f_0 \ll W \ll f_B$, the solution obtained above then corresponds to the decomposition of the dielectric matrix $\epsilon_{mn}(\Omega)$ into a totally disconnected part δ_{mn} and a totally connected part $\chi_{mn}(\Omega)$, as shown in Fig. 47, with a manifest collective pole given by the zeros of $\epsilon_{\perp}(\Omega') = 1 - N_{\ell} \chi_0(\Omega')$ in the collectively distorted fluctuations $\sum_m \tilde{d}[(m \pm Q)\omega_0 + \Omega']$.

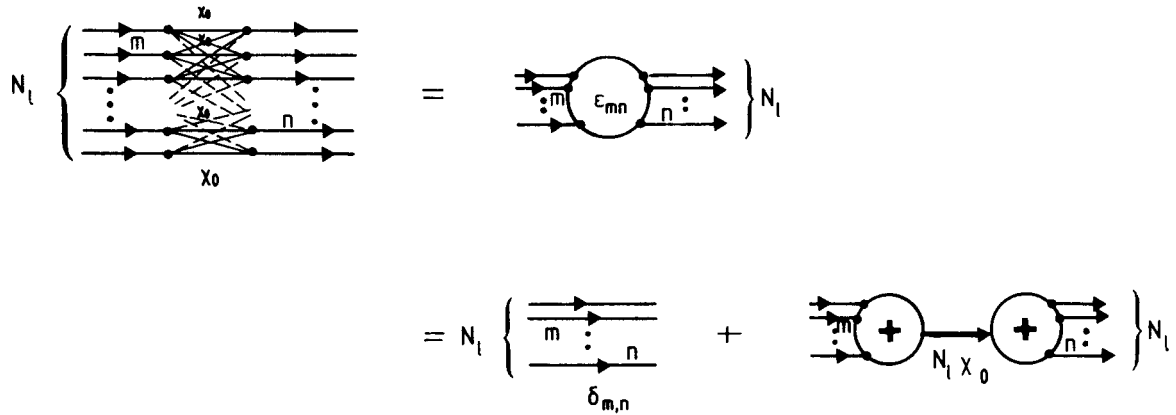

Fig. 47 Decomposition of the bunched beam dielectric matrix into totally disconnected and totally connected parts

This behaviour is expected if we remember that for bunched beams we are essentially dealing with a sampled system. For $W \ll f_B$, the impedance or collective interaction loop sees the bunch for an effective time much longer than the bunch duration each turn and internal synchrotron motion leading to unequal sampling times do not matter. Effective sampling frequency is constant for the whole bunch and equal to f_0 , and so it is the Fourier transform of the sampled dipole fluctuations $\sum_m \tilde{d}(\Omega_m^{\pm})$ that gets modified as Eqs. (11.66) above, well known from sampled feedback control systems. The impedance sees the bunch as $(\Delta t)_B = 1/W$ long and then $N_{\ell} = W/f_0 =$

$T_0/(\Delta t)_B$ is just the effective bunching factor. Thus in the above situation, the collective distortion is equivalent to a continuous coasting beam with $N_{eff} = N \cdot N_\ell$ as the effective number of particles.

Betatron bands separated from each other in frequency by a spacing more than or equal to f_B , do not couple to each other significantly since the coherence is strong between bands with spacing $\Delta f \leq f_B$ only. Each band separated by f_B from the next can be treated independently as an orthogonal component as in continuous coasting beams; however, distortion of fluctuations for frequencies within a single band having the enhancement factor N_ℓ as above. This is illustrated in Fig. 48, for the case where the collective impedance is localized into bands separated by f_B , each band containing N_ℓ coherent (+) and (-) betatron bands²⁸⁾.

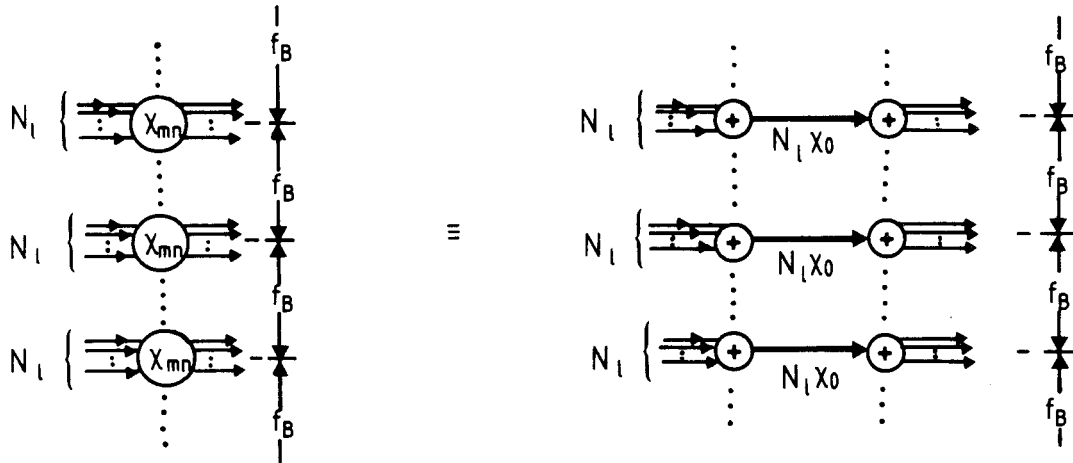

Fig. 48 Decomposition of bunched beam susceptibility for a collective impedance that is clustered and isolated at spacing f_B

If the collective impedance or gain is wide-band so that it sees a continuous band W containing several $m f_B$ lines, then $N_\ell = f_B/f_0 = T_0/\Delta t = B$ is the actual bunching factor of the (Δt) long bunches. The system rise-time is shorter than the bunch duration and it sees the bunch a (Δt) long. The distortion factors are then obtained with equivalent continuous coasting beam type dielectric suppressions but with $N_{eff} = N \cdot B$. In the situation of narrow non-overlapping synchrotron bands, one can consider signal suppression factors for each individual synchrotron fluctuation mode separately. Approximate expressions for the suppression factors ϵ_μ for the synchrotron modes ' μ ' are given in Refs. 7 and 40.

The phenomenon of deformation of fluctuations by collective interactions is most dramatic and commonly observed in stochastic cooling systems for continuous coasting beams where one observes the deformation (suppression or enhancement) of Schottky fluctuation signals at a pick-up as an immediate effect upon switching on a cooling feedback loop³¹⁾. It is known in that context as the "feedback through the beam" or "signal suppression" effect. The kicker fields in the cooling loop introduce correlations between particles. These correlations are then propagated coherently by the beam, through the collective motion of the particles described by the beam transfer function, back to the pick-up which thus sees the Schottky signals distorted away from the uncorrelated form. The modification of the fluctuation Schottky spectrum in the frequency-wave number domain is a manifestation of correlations between single-particle orbits in the time-space domain, created by the cooling-loop-induced collective interactions. In the context of stochastic

cooling, where excitation of collective modes or instabilities is carefully avoided by a proper choice of the cooling loop transfer function (e.g. gain and phase), the Schottky signal distortion by collective beam feedback is of modest degree and generally leads to a suppression of observable incoherent fluctuations^{20-22,35}). The suppression nevertheless can be large unless the gain and the phase of the cooling loop are suitably optimized for best possible cooling³⁶). For a properly matched cooling loop, the transverse Schottky signals are generally reduced in amplitude when the loop is closed. For optimum cooling, the gain and phase of the feedback should be such that the reduction is by about a factor of half²⁰). This criterion on the magnitude of closed loop signal suppression for optimal cooling can be verified theoretically and has been borne out by experiments at the CERN Antiproton Accumulator (AA) ring^{20,31}). The longitudinal momentum Schottky signals are usually decreased in amplitude also at the edges of the distribution when the loop is closed. Experimental manifestation is a higher peak value with the loop closed, which is the most noticeable effect in the AA stack core³¹). These effects are illustrated in Fig. 49.

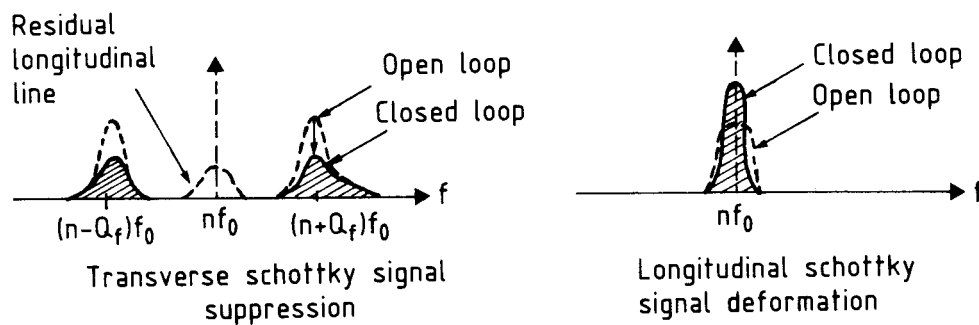

Fig. 49 Signal suppression in stochastic cooling

Note that this effect simply reflects the fact that collective correlations, propagated and fed back by the beam to the observing pick-up, limits the measure of observed signals (both amplitude and phase) only. The actual incoherent motion of the particles, responsible for the fluctuations to start with, are not significantly affected in the time scales of this collective beam feedback effect. This closed loop distortion by beam feedback is a much faster process than the essentially single particle cooling process and provides the only immediate clue to the single particle and collective aspects of the entire feedback loop as an effective cooling element. This is especially important for bunched beams, where stochastic cooling is expected to be slow and one would like to use this effect as a diagnostic tool to check and optimize the loop properties (delay, gain, phase, etc.) for best possible cooling. One only needs a spectrum analyser, a switch to open and close the loop, a few knobs to adjust the gain and delay, etc., and lots of patience to arrive at the optimum set-up.

12. CRITICAL FLUCTUATIONS

We saw in Section 11 that at the threshold of a collective mode or its transition, fluctuations in the beam may distort or enhance significantly. Such dramatic enhancement of fluctuations is often a clue to the onset of collective modes and hence collective fluctuations. They are known as ‘critical fluctuations’⁴⁵⁾.

The spectral distribution of fluctuations in the domain of frequencies having stable collective modes with small damping rates γ_k , will have sharp delta-function-like peaks at frequencies Ω_k that satisfy the dispersion relation $\epsilon(\Omega_k + i\gamma_k) = 0$. We study the fluctuation spectral distribution near these maxima or peaks, i.e. the coherent or collective fluctuation spectra. Note that while frequencies Ω for the incoherent fluctuations are the incoherent frequencies of the particles in the beam, those for the coherent fluctuations are restricted to satisfy the dispersion relation. For slowly damped stable collective modes $|\gamma_k/\Omega_k| \ll 1$ and $|\text{Im} [\epsilon(\Omega)]| \ll |\text{Re} [\epsilon(\Omega)]|$. In the vicinity of the collective modes $\Omega = \pm \Omega_k$, we may express $\epsilon(\Omega)$ as $\epsilon(\Omega) \approx [\partial \text{Re} \epsilon(\Omega)/\partial \Omega]_{\Omega = \pm \Omega_k} \cdot [\Omega \mp \Omega_k - i\gamma_k]$ so that we may write

$$\frac{1}{|\epsilon(\Omega)|^2} = - \frac{\text{Im}[\epsilon(\Omega)^{-1}]}{\text{Im} \epsilon(\Omega)} = \frac{\pi}{|\text{Im} \epsilon(\Omega)|} \delta [\text{Re} \epsilon(\Omega)] \quad (12.1)$$

where we have used the Dirac identities (5.27).

The coherent fluctuations are then given by

$$\langle |\tilde{\text{I}}(\Omega)|^2 \rangle = \frac{\langle |\tilde{\text{I}}^0(\Omega)|^2 \rangle}{|\epsilon(\Omega)|^2} = \pi \frac{\langle |\tilde{\text{I}}^0(\Omega)|^2 \rangle}{|\text{Im} \epsilon(\Omega)|} \delta [\text{Re} \epsilon(\Omega)] \quad (12.2)$$

For small γ_k , we may write

$$|\text{Im} \epsilon(\Omega_k)| = |\gamma_k| \cdot \left| \frac{\partial \text{Re} \epsilon(\Omega)}{\partial \Omega} \right|_{\Omega=\Omega_k} \quad (12.3)$$

Using

$$\delta [\text{Re} \epsilon(\Omega)] = \frac{1}{\left| \frac{\partial [\text{Re} \epsilon(\Omega)]}{\partial \Omega} \right|_{\Omega=\Omega_k}} [\delta(\Omega - \Omega_k) + \delta(\Omega + \Omega_k)] , \quad (12.4)$$

we then get:

$$\langle |\tilde{\text{I}}(\Omega)|^2 \rangle = \pi \left(\frac{\partial [\text{Re} \epsilon(\Omega)]}{\partial \Omega} \right)_{\Omega=\Omega_k}^{-2} \frac{\langle |\tilde{\text{I}}^0(\Omega)|^2 \rangle}{|\gamma_k|} [\delta(\Omega - \Omega_k) + \delta(\Omega + \Omega_k)] \quad (12.5)$$

We rewrite (12.5) as

$$\left. \langle |\tilde{\text{I}}(\Omega)|^2 \rangle \right|_{\Omega \rightarrow \pm \Omega_k} = \left. \langle |\tilde{\text{I}}(\Omega)|^2 \rangle \right|_{\Omega \rightarrow \pm \Omega_k} = \pi \text{I}_k [\delta(\Omega - \Omega_k) + \delta(\Omega + \Omega_k)] , \quad (12.6)$$

where

$$I_k = \frac{\langle |\tilde{I}^0(\Omega)|^2 \rangle}{|\gamma_k| |\epsilon'_k|^2} ; \quad \epsilon'_k = \left. \frac{\partial [\text{Re } \epsilon(\Omega)]}{\partial \Omega} \right|_{\Omega = \pm \Omega_k} \quad (12.7)$$

Another illuminating form can be obtained for the thermodynamic equilibrium case, where we observe from Eq. (11.44) that for non-overlapping bands we may write

$$\frac{\langle |\tilde{z}_n^0(\Omega)|^2 \rangle}{|\text{Im } \epsilon_n(\Omega)|} = \frac{N}{2\pi} \left(\frac{n\Delta\omega}{\Delta\Omega_n} \right)^2 \frac{1}{|\Omega_n - n\omega_0|} = \frac{2T_{\parallel}}{q^2\omega_0} \cdot \frac{n}{\text{Im}\tilde{Z}_{\parallel,n}} \frac{1}{|\Omega_n - n\omega_0|} , \quad (12.8)$$

so that from Eq. (12.2) we may also write I_n , for fluctuations in the vicinity of $\Omega_n^{\pm} = n\omega_0 \pm \Delta\Omega_n$, as

$$I_n = \frac{2\pi}{q^2\omega_0} \frac{n}{\text{Im}\tilde{Z}_{\parallel,n}} \frac{1}{\Delta\Omega_n \cdot |\epsilon'_n|} T_{\parallel} \quad (12.9)$$

for an equilibrium situation. We can then define an effective temperature $\tilde{T}_{\parallel}(\Omega_n)$ of the coherent fluctuations near $\Omega = \Omega_n$ even in the non-equilibrium situation so that

$$I_n = \frac{2\pi}{q^2\omega_0} \frac{n}{\text{Im}\tilde{Z}_{\parallel,n}} \frac{1}{\Delta\Omega_n \cdot |\epsilon'_n|} \tilde{T}_{\parallel}(\Omega_n) , \quad (12.10)$$

where

$$\tilde{T}_{\parallel}(\Omega_n) = \frac{q^2\omega_0}{2\pi} \frac{\text{Im}\tilde{Z}_{\parallel,n}}{n} \cdot \Delta\Omega_n \cdot \frac{\langle |\tilde{z}^0(\Omega_n)|^2 \rangle}{|\text{Im } \epsilon(\Omega)|_{\Omega=\Omega_n}} \quad (12.11)$$

For an equilibrium situation $\tilde{T}_{\parallel}(\Omega_n)$ is just the beam temperature T_{\parallel} as in Eq. (12.9). In the general case $\tilde{T}_{\parallel}(\Omega_n)$ may be interpreted as an effective longitudinal temperature, characterizing the mean square fluctuations in longitudinal density of the beam. Note that $\tilde{T}_{\parallel}(\Omega_n)$ may depend on whether $\Omega \rightarrow \Omega_n^+$ or $\Omega \rightarrow -\Omega_n^-$. The quantity πI_n in either case measures the strength of the coherent collective fluctuations when the beam is close to a weakly damped stable collective mode Ω_n^{\pm} driven by a general impedance $\tilde{Z}_{\parallel,n}$ of the beam-storage-ring system.

13. LANDAU DAMPING AND PHASE MIXING

The phenomenon of Landau damping is of common-place occurrence in the physics of charged particle beams in storage rings; in the context of beam stability against collective modes (Section 10) determined by the dispersion relations, one speaks about it as if through second nature. General discussions on Landau damping abound in the plasma physics literature^{25,33,45}). In the context of charged particle beams, a thorough exposition of the basic underlying mechanism has been provided in an excellent essay by Hereward⁴⁶) and any further elaboration would seem redundant. The physics of Landau damping is understood intuitively in various ways by individuals concerned with it and takes on a personal character, although the strictly mathematical justification based on a proper treatment of an initial value problem via Laplace transforms is clear and unambiguous³³). There is one aspect of Landau damping in particle beams that is particularly significant in view of the inherent relation it implies between beam stability and the collective distortion of fluctuation spectra, namely the aspect of the connection of Landau damping with phase mixing within the beam. In view of this inherent connection between the collective aspect of ‘phase coherence’ and the single-particle aspect of ‘phase mixing’ in particle beams, and its significant implications for beam stability and processes such as stochastic cooling, we discuss a few points in this non-trivial connection.

Landau damping is the process by which a large number of *lossless* resonators or oscillators, which are all the same except for their natural frequencies being spread over a range of values almost smoothly as far as our relevant time scales are concerned [i.e. for $t \ll t_r = (\delta f_r)^{-1}$ where $\delta f_r = \Delta f/N$ is the average frequency spacing between individual particles distributed with a total frequency spread of Δf], acquire *dissipative* properties when acting collectively. In fact we already had a flavour of this process when we introduced the vanishingly small positive number $\gamma \rightarrow 0^+$ in our response formalism in Section 5; for as we saw later in Section 7, it is the presence of this $i\gamma$ -term in the denominator that is responsible for producing the reactive and dissipative parts of the beam response given by its real and imaginary parts interchangeably. The dissipative part endows the beam with the capability of absorbing energy from any impressed time-varying field or wave whose frequency lies within the band of incoherent frequencies of the particles in the beam. This is beneficial for particle beams in general since the dissipative response of the beam will slowly absorb or drain away energy from any spontaneously excited coherent or collective wave which subjects the beam to a time-varying wave field. The coherent wave will therefore be slowly damped and thus it is that the process of Landau damping in particle beams may stabilize situations which would otherwise be unstable. Interestingly, the coherent waves are damped by the Landau damping process without increasing the amplitude of coherent motion of the beam particles. The mechanism of this ‘hidden energy’ has been discussed thoroughly in the essay by Hereward. There a clear picture emerges as to where this hidden energy goes, as follows.

The explanation is grounded on the time-asymmetric process of ‘switching on’ externally time-varying fields, as we discussed in Section 5. The details of the ‘switching on’ are immaterial but it is just the *asymmetry* introduced by the *initial conditions* inherent in a ‘switched on’ process that provides the physical explanation of the occurrence of an irreversible process such as Landau damping or systematic dissipation in a system whose response is based nevertheless on time-symmetric (about the origin, i.e. time-reversible) equation of flow (i.e. the Vlasov equation). By the same token, it also explains the natural occurrence of the $i\gamma$ -term via Laplace transforms, demanded by a proper treatment of the initial-value problem. Hereward shows that when subjected for a long time t to a ‘switched-on’ monochromatic field $F \sim e^{-i\Omega t}$, there is a band of

oscillator frequencies near Ω , of width of the order of $1/t$, in which the oscillators behave like on-resonance ones in that their amplitudes increase like t and their phase relation to F is resistive. The individual energies increase like t^2 while their number decreases as $1/t$ so that they make a linear increase in the stored energy. The energy increases without showing up in the amplitude of coherent motion by being increasingly concentrated into a decreasing number of oscillators.

In the linear approximation, a particle precisely in resonance with the impressed wave field, will sample the field at a constant relative phase and the resonant energy transfer is unidirectional, leading to the dissipative part of the beam response. Particles off resonance will sample the field with an oscillating relative phase and the energy transfer is bidirectional, i.e. the particles *exchange* energy with the field periodically. This is the origin of the reactive term in the beam response.

For a continuous distribution of particles in frequencies, only a vanishing number of them will be exactly resonant, i.e. will have exactly the same frequency as that of the wave field. Thus the divergence in the response integral in Eq. (6.29) at $\Omega = \vec{n} \cdot \vec{\omega}(\vec{I})$ is really absent physically. The mathematical introduction of the $i\gamma$ -term then allows us to evaluate the integral but at the cost of considering *complex frequencies* implying growing or shrinking *average* amplitude of the particles. Such an average response can be explained only by a continuous drift of the particles into or out of step with each other, i.e. *phase mixing*. For times longer than the inverse of the average frequency spacing between particles [$t \gg t_r = (\delta f_r)^{-1}$, $\delta f_r = \Delta f/N$], the distribution function can no longer be considered continuous and smooth, but has to be considered more appropriately as a series of successive step functions—it is a series of discontinuous steps separated by δf_r on the average. Self-generated coherent waves or externally applied fields will rarely have frequencies exactly coinciding with the discontinuities in frequency. Exact resonance almost never exists and so eventually for long times $t \gg t_r$, the coherent wave and the particle sharply localized at the discontinuity must *exchange* energy, leading to a reactive contribution to the beam response. For practical beams, however, this time scale is long enough for the *non-linear* contributions to the response to be significant anyway, which limits the growth of the coherent wave due to lack of Landau damping for large t .

Landau damping then is crucially dependent on the small spread in the natural frequencies of the particles causing a continual phase mixing between the phase of the impressed wave field and the phases of the wave-sampling particles in the beam. The frequency spread destroys any coherence between the particles in the beam by mixing the particle trajectories in phase space in a characteristic time scale. Landau damping of a coherent wave in the collective system of the beam particles depends on the precise phase relationship between a band of particles and the wave with which they resonate. Exchange of energy between the two leaves a memory in the particle orbits. The reverse process of particles giving up energy to the wave will not be realized with a finite frequency spread which causes the particle trajectories to phase-mix irreversibly. Under special circumstances, however, the information left in these orbits can be manifested or echoed in a reversed energy-exchange process, if conditions suitable for such a process to occur are created²⁵). The simplest such process is to reverse the particle trajectories to re-create the phase relationship that was responsible for energy exchange at a previous instant. Such reversal of particle trajectories is naturally present in a bunched beam, where the particle orbits in the longitudinal phase space, by virtue of synchrotron oscillations, periodically create suitable conditions for the direct and reversed energy-exchange processes to take place. The extent to which the phases of the particles relative to the wave are reconstructed is determined by the ‘mixing’ of the particles in phase space, which thus determines the efficiency of this information regeneration process.

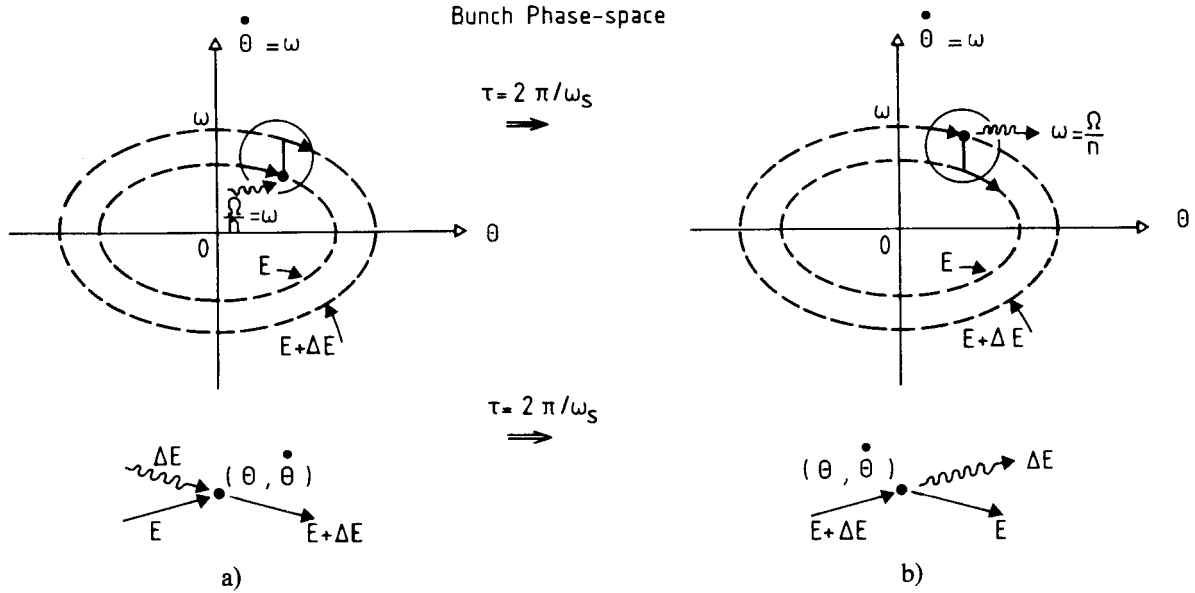

Fig. 50 Wave regeneration and echo in bunched beams leading to loss of Landau damping

As illustrated in Fig. 50a and b, if the particle synchrotron oscillation frequency is independent of oscillation energy (i.e. linear amplitude-independent synchrotron oscillations), all the resonant particles in a narrow band around $(\Theta, \dot{\Theta} = \omega)$, after undergoing a Landau damping process, will return to $(\Theta, \dot{\Theta})$ after one synchrotron period with precisely the same phase relationship and will undergo Landau anti-damping by regenerating a wavelet of the same energy as the wavelet they absorbed in the damping process before. Lack of mixing in phase space is then at the root of the fact that for linear synchrotron oscillations with no spread in frequencies, Landau damping is absent for a bunch for times much longer than a synchrotron period^{29,30}. If the beam-storage-ring impedance is phased for instability, coherent modes will grow without stabilizing themselves through Landau damping, owing to zero frequency spread. If the impedance is such that the bunch is stable without a spread in frequencies, the collective distortion of the beam fluctuations will be significantly high and in the limit of zero synchrotron-frequency spread, the feedback through the beam response will suppress the observable delta-function like Schottky fluctuation line-spectrum of the beam completely, reducing them to zero^{7,40}. However, if the synchrotron frequency is dependent on the oscillation amplitude, particles will continually slip away in phase and only a fraction of the total number of particles in the narrow band will return with approximately the same phase relationship with the wave. Hence the efficiency of wave regeneration is reduced and we will still be left with some Landau damping. The observed fluctuations will distort but never get suppressed below a finite residual level, with finite spread in synchrotron frequencies.

There is an additional mechanism of wave regeneration in bunched beams that contributes to lack of mixing and hence Landau damping. This is due to the existence of non-locally reflected waves in a bunch as mentioned in Section 3. In the closed trajectory of a particle in the bunch synchrotron phase space, shown in Fig. 51, we see that a particle of a given synchrotron oscillation amplitude, which has a velocity $\omega = \dot{\Theta}$ at Θ (at point P) has a velocity $-\omega = -\dot{\Theta}$ at $-\Theta$ (at point P'), in the beam frame. The same applies for the points Q and Q'. The time it takes a particle to traverse from P to P', which is half the synchrotron oscillation period, is the same as the time it takes to go from P' to P and more importantly, for linear synchrotron oscillations, this time is

independent of the oscillation amplitude and hence the same for all particles. Thus the phase modulation imposed by a possible coherent wave on a band of resonant particles at P will reappear at P' with reversed polarity. The same band of particles resonating with the wave at P is now capable of generating a wave at P' with a phase velocity opposite to that of the original wave at P. This is the mechanism of non-local resonant wave reflection. Similarly the wave at P' is regenerated at P again. The phenomenon is the same as that of plasma wave echo²⁵). Again the efficiency of this non-local wave regeneration is less than total for non-linear oscillations with characteristic frequency spreads, leading to finite residual phase mixing and Landau damping.

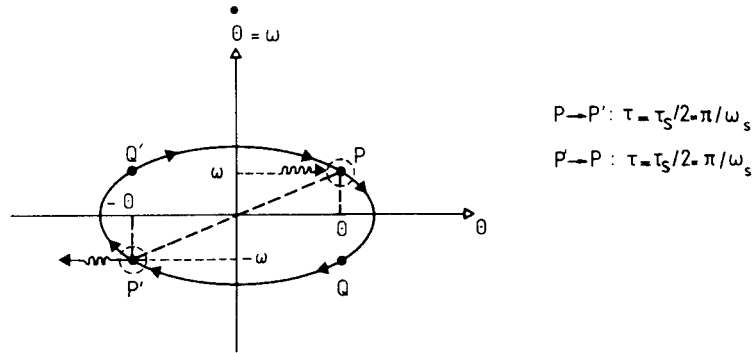

Fig. 51 Wave regeneration by non-local wave reflection in bunched beams

The information about the past, namely the fact that a particle at a phase-space point $(\Theta, \dot{\Theta})$ at time t was at the same phase-space point an indefinite number of times in the past at times $t_n = t - (2\pi n/\omega_s)$ when $n = 1, 2, \dots$ and was at the point $(-\Theta, -\dot{\Theta})$ also an indefinite number of times at $t_n = t - (2\pi [n+1/2]/\omega_s)$, where $n = 0, 1, 2, \dots$, is retained by the trajectories. This makes them resonate at all these times, if they are resonant at any one of the times. However, the relative phase of the wave and the particle is different each time and so these resonances are only local in time. Over a time scale that is long compared to the synchrotron period, these locally resonant particles will exchange energy with the wave much as the non-resonant ones do, rather than transferring energy unidirectionally. Eventually, they thus generate reactive terms rather than dissipative terms in the beam response.

Landau damping and phase mixing are thus intimately related. In the situation of 'good mixing', i.e. if the frequency spread in the beam is enough to destroy any collectively induced coherence faster than it grows, coherent instabilities are stabilized if the collective interaction characterized by the beam-storage-ring impedance or a feedback loop is phased for instability (i.e. if the beam is unstable without a frequency spread). For a properly phased feedback loop as in stochastic cooling, the beam is stable even without a frequency spread, if the loop gain determines the collective interaction dominantly. However, the closed-loop fluctuation strength would be zero without a frequency spread (the signal suppression factor $|\epsilon(\Omega)|^2$ would be infinitely large). With frequency spread sufficient for good mixing then, the collective closed-loop distortion or suppression of the Schottky fluctuations would be of modest degree only [$|\epsilon(\Omega)| \approx 1$]. In fact the required spread in frequencies in the beam to ensure Landau damping turns out to be approximately the same as that demanded by the condition for 'good mixing', i.e. modest fluctuation distortion in the stable situation. Comparing Eqs. (10.21) or (11.11) with Eq. (11.36), we observe that stabilization by Landau damping requires

$$n \Delta\omega \gtrsim \Delta\Omega_n \quad (13.1)$$

This ensures that the frequency of the coherent wave given by $\Omega = n\omega_0 \pm \Delta\Omega_n$ falls within the band of incoherent frequencies of the particles, which can then dissipate the energy. In the case of stable fluctuations ($N_{cr} < 0$) as shown in the bottom curve in Fig. 38, a reasonable condition for modest fluctuation suppression would be $N \ll |N_{cr}|$. With N_{cr} given by Eq. (11.9), this condition reduces to expression (13.1) again. Thus the criterion of Landau stability is similar to the condition of good mixing in phase space.

In the context of stochastic cooling, the collective interaction is determined predominantly by the gain of the feedback loop that detects beam fluctuations at a localized PU and applies them back with suitable amplification to the beam at a localized kicker. There is competition between the rate at which coherent modulations are generated in the beam by the feedback loop at the kicker and the rate at which the coherence is destroyed by the frequency spread in the beam through phase-mixing via the beam transfer function from the kicker back to the PU. Optimum cooling is determined by a proper combination of the feedback loop gain $\tilde{G}(\Omega)$ and the BTF from kicker to PU, $\tilde{\mathcal{R}}^{PK}(\Omega)$, both in magnitude and phase^{20,21}). Typically for low frequencies where the beam fluctuation bands are narrow and separated (i.e. in the non-overlapping region) and for negligible thermal noise of the feedback loop, optimum (i.e. best possible) cooling is achieved for a combination of \tilde{G} and $\tilde{\mathcal{R}}^{PK}$ such that³⁶)

$$|\tilde{G}(\Omega)\tilde{\mathcal{R}}^{PK}(\Omega)| = 1 \quad (13.2)$$

$$\text{Arg } \tilde{G}(\Omega) = \text{Arg } \tilde{\mathcal{R}}^{PK}(\Omega) + \pi \quad (13.3)$$

For a symmetrical distribution of particles in angular velocities, the beam response is real at the centre of the distribution. The optimum condition (13.2) and (13.3) then reduce to^{20,36})

$$\tilde{G} \tilde{\mathcal{R}}^{PK} = -1 \quad (13.4)$$

for a frequency Ω at the centre of the fluctuation band. This is true for both longitudinal and transverse optimum cooling of a continuous coasting beam only. In the diagrammatic representation similar to Fig. 34, the closed-loop condition for *optimum coherence* demanded by fastest cooling may then be represented as in Fig. 52.

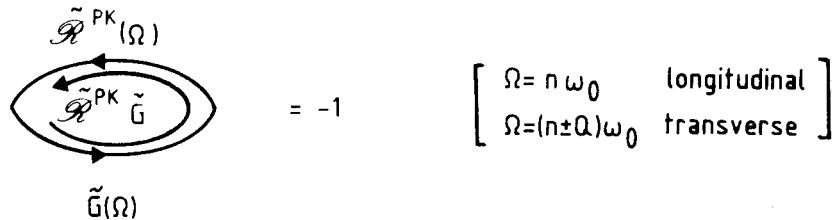

Fig. 52 Closed-loop condition of optimum coherence for the maximum stochastic cooling rate of a continuous coasting beam with symmetrical angular velocity distribution

At frequencies away from the centre of the fluctuation band, the optimum coherence pattern still demands Eq. (13.2); however, the optimum phase is quite different and $\text{Arg}(\tilde{G}\tilde{\mathcal{R}}^{PK}) \neq \pi$ as is evident from Eq. (13.3). It will depend on the phase of the BTF $\tilde{\mathcal{R}}^{PK}(\Omega)$ at that frequency.

A detailed analysis of the choice of the optimum closed-loop condition for maximum cooling rate depends on considerations of phase mixing between PU and kicker by the finite frequency spread of the particles, factor of safety from the edge of instability given by the closed loop condition of Fig. 34 at any frequency within the fluctuation band, stability of the optimum against small deviations in phases away from it, beam distribution, etc.³⁶). An optimum coherence

condition on $\tilde{\mathcal{R}}^{\text{PK}}(\Omega)$ and $\tilde{\mathcal{G}}(\Omega)$ for best possible cooling, even though it exists in principle and may be derived theoretically locally at each Ω within the band, may not be a practical one. It has been shown by S. van der Meer³⁶⁾ that a realistic choice is given by a constant, real value of $\tilde{\mathcal{G}}$ throughout the band such that the closed-loop coherence condition of Eq. (13.4) and Fig. 52 is still satisfied at the centre of the beam distribution, without much loss of cooling, when considering the whole beam and with some modest requirement on the phase shift between PU and kicker.

In view of the similarity of the two conditions (10.7) and (13.4), especially when considered for absolute values (they both reduce to $|\tilde{\mathcal{G}}||\tilde{\mathcal{R}}| = 1$), it is not surprising that the condition of Landau damping in the context of beam instability and ‘good mixing’ in the context of stochastic cooling are similar.

An absolute definition of ‘good mixing’ for the frequencies of interest is provided by the condition that the beam fluctuation bands (revolution Schottky bands for longitudinal and betatron Schottky bands for transverse) overlap in the frequency range considered, e.g. $n\Delta\omega \gtrsim \omega_0$ for longitudinal signals. In the overlapped regime, the resonant particles thoroughly phase-mix and get completely out of step with the resonating wave by distributing themselves over a full wavelength of the coherent wave in one single turn in the storage ring. The distribution of fluctuations in frequency space is more or less uniform with constant density and resembles white noise. The resonant character of the beam response is largely lost since all modulations or coherence induced in the beam by an exciting kicker are smeared out by the frequency spread before reaching the PU. For ideal mixing, the uniform and constant total particle density at any frequency Ω , for the transverse fluctuations, is simply $\Psi(\Omega) = N/(\omega_0/2) = 2N/\omega_0$ and for a stochastic cooling configuration, the real part of the transverse beam response from kicker to PU is zero, as follows from Eq. (7.40). For uniform and constant longitudinal density $\Psi(\Omega)$, it follows from Eq. (7.32) that the real part of the longitudinal response is approximately zero also.

14. FLUCTUATION-DISSIPATION RELATION

We have already seen that the beam response to electromagnetic perturbations has a reactive oscillatory part and a resistive damping part. There exists a special relationship between the dissipative part of the beam response and the incoherent Schottky fluctuations in a beam. This is not surprising since both the fluctuations and the beam response are determined by the same single particle orbits and are modified simultaneously by the presence of any collective interactions determined by relevant impedances. What is special about this relationship is that only the dissipative resistive part of the beam response enters into the relationship. In fact, this fluctuation-dissipation relationship for a particle beam is nothing but a generalization of the well-known Nyquist's formula⁴⁷⁾ for the spectral density of the fluctuating e.m.f. \mathcal{E} arising in a complex impedance $Z(\Omega)$ due to thermal agitations:

$$P_{\mathcal{E}}(\Omega) = 4kT \operatorname{Re} [Z(\Omega)] = 4kT R(\Omega) \quad (14.1)$$

or, for the current fluctuations

$$P_{\mathcal{I}}(\Omega) = \frac{P_{\mathcal{E}}(\Omega)}{|Z(\Omega)|^2} = 4kT \frac{\operatorname{Re} [Z(\Omega)]}{|Z(\Omega)|^2} = 4kT \operatorname{Re} \left[\frac{1}{Z^*(\Omega)} \right], \quad (14.2)$$

where k is the Boltzmann constant, T the temperature of the impedance in thermal equilibrium and $R(\Omega) = \operatorname{Re} [Z(\Omega)]$ the active resistance of the complex impedance $Z(\Omega) = R(\Omega) + iQ(\Omega)$. For a beam of particles, the response is just the analog of complex admittance $R(\Omega) = Y(\Omega) = [Z(\Omega)]^{-1}$ relating, say, current $\tilde{I}(\Omega)$ to the impressed voltage $\tilde{V}(\Omega)$ by the relation $\tilde{I}(\Omega) = \tilde{\mathcal{R}}_{\parallel}(\Omega)\tilde{V}(\Omega)$, for longitudinal response. We would then expect a similar relation:

$$P_{\mathcal{I}}(\Omega) = 4kT_{\parallel} \operatorname{Re} [\tilde{\mathcal{R}}_{\parallel}^*(\Omega)] = 4kT_{\parallel} \operatorname{Re} [\tilde{\mathcal{R}}_{\parallel}(\Omega)] \quad (14.3)$$

for the current fluctuations and the longitudinal response of a beam in thermodynamic equilibrium characterized by a longitudinal temperature T_{\parallel} . Note that both the beam response and the fluctuations are observed at one and the same location, $\theta = \theta_P$ say. The relationship can, however, be generalized to the spectral density of current fluctuations at two different azimuthal locations $\theta = \theta_P$ and $\theta = \theta_K$ in the ring (given by the Fourier transform in frequency Ω of the cross-correlation $\langle I(t|\theta_P)I^*(t'|\theta_K) \rangle$) and the corresponding beam response or transfer function between the same two locations, i.e. $\tilde{\mathcal{R}}(\Omega|\theta_P, \theta_K)$. Similar relationships are expected for the transverse fluctuations and transverse response as well. In fact the relationship can be generalized^{25,45)} to the spectral density of the cross-correlation between fluctuations in any two physical observables $A(t|\theta_P)$ and $B(t'|\theta_K)$ and the response function relating the two: $\tilde{\mathcal{R}}_{AB}(\Omega|\theta_P, \theta_K)$. Moreover, without any reference to the specific situation of thermodynamic equilibrium defined by a temperature T_{\parallel} , slightly modified relationships may be obtained with no temperature appearing anywhere⁴⁵⁾. The relation would then apply to any beam including non-equilibrium situations. Finally, for periodically time-varying systems, as for example for bunched beams, one can also obtain certain relationships between the Bloch components $\tilde{\mathcal{R}}_{AB}^k(\Omega|\theta_P, \theta_K)$ ($k = 0, \pm 1, \pm 2, \dots$) of the beam response and the corresponding spectral density components $[P_{AB}]_k(\Omega|\theta_P, \theta_K)$ in the Bloch decomposition of the full spectral density $P_{AB}(\Omega, \Omega'|\theta_P, \theta_K)$ of fluctuations. These Bloch components of response and fluctuations have already been introduced for bunched beams in Sections 5 and 3.

For illustration, let us begin by considering the longitudinal current fluctuations and the longitudinal response of a continuous coasting beam in a storage ring. The cross-correlation of the longitudinal current fluctuations at two different azimuths θ_P and θ_K can be written as

$$\begin{aligned} P(t, t' | \theta_K, \theta_P) &= \langle I(t | \theta_K) I^*(t' | \theta_P) \rangle = P(t - t' | \theta_K - \theta_P) \\ &= \sum_{\substack{n=-\infty \\ \neq 0}}^{+\infty} P_n(t - t') e^{in(\theta_K - \theta_P)} \end{aligned} \quad (14.4)$$

The corresponding spectral density is given by [Eq. (3.35)]:

$$\begin{aligned} P_I(\Omega | \theta_P, \theta_K) &= \sum_{\substack{n=-\infty \\ \neq 0}}^{+\infty} \tilde{P}_n(\Omega) e^{in(\theta_K - \theta_P)} \\ &= \frac{q^2 N}{2\pi} \sum_{\substack{n=-\infty \\ \neq 0}}^{+\infty} \left[\int_{-\infty}^{+\infty} d\omega \cdot \omega^2 \cdot \Psi_0(\omega) \delta(\Omega - n\omega) \right] e^{in(\theta_K - \theta_P)} \end{aligned} \quad (14.5)$$

The longitudinal beam response or transfer function from θ_K to θ_P is given by [Eq. (7.15)]:

$$\tilde{\mathcal{R}}_v(\Omega | \theta_P, \theta_K) = (-i) \frac{Nq^2 \kappa}{2\pi} \int_{-\infty}^{+\infty} d\omega \cdot \omega \cdot \frac{\partial}{\partial \omega} [\omega \Psi_0(\omega)] \lim_{\gamma \rightarrow 0^+} \sum_{n=-\infty}^{+\infty} \frac{e^{in(\theta_P - \theta_K)}}{[\Omega - n\omega + i\gamma]} \quad (14.6)$$

Denoting $(\theta_P - \theta_K)$ by θ_{PK} and differentiating $P_I(\Omega | \theta_{PK})$ with respect to θ_{PK} and Ω , we obtain

$$\begin{aligned} \frac{\partial}{\partial \Omega} \cdot \frac{\partial P_I}{\partial \theta_{PK}} &= \frac{q^2 N}{2\pi} \cdot i \sum_{n=-\infty}^{+\infty} \int_{-\infty}^{+\infty} d\omega \cdot \frac{\partial}{\partial \omega} [\omega^2 \Psi_0(\omega)] \delta[\Omega - n\omega] e^{in(\theta_P - \theta_K)} \\ &= \frac{q^2 N}{2\pi} \cdot i \sum_{n=-\infty}^{+\infty} \int_{-\infty}^{+\infty} d\omega \delta[\Omega - n\omega] \left[\omega \Psi_0(\omega) + \omega \frac{\partial}{\partial \omega} [\omega \Psi_0(\omega)] \right] e^{in(\theta_P - \theta_K)} \\ &= \frac{1}{\Omega} \frac{\partial P_I}{\partial \theta_{PK}} + \frac{q^2 N}{2\pi} i \sum_{n=-\infty}^{+\infty} \int_{-\infty}^{+\infty} d\omega \delta[\Omega - n\omega] \omega \cdot \frac{\partial}{\partial \omega} [\omega \Psi_0(\omega)] e^{in(\theta_P - \theta_K)}, \end{aligned} \quad (14.7)$$

where we have used the identity

$$\frac{\partial}{\partial \Omega} \left[\int_{-\infty}^{+\infty} d\omega \delta[\Omega - n\omega] f(\omega) \right] = \frac{1}{n} \int_{-\infty}^{+\infty} d\omega \delta[\Omega - n\omega] \frac{\partial f(\omega)}{\partial \omega} \quad (14.8)$$

in the first step. From Eq. (14.6), we immediately verify

$$\begin{aligned}\tilde{\mathcal{R}}_{PK}(\Omega) + \tilde{\mathcal{R}}_{KP}^*(\Omega) &= \tilde{\mathcal{R}}_{||}(\Omega|\theta_K, \theta_P) + \mathcal{R}_{||}^*(\Omega|\theta_P, \theta_K) \\ &= Nq^2\kappa \sum_{n=-\infty}^{+\infty} \int_{-\infty}^{+\infty} d\omega \cdot \omega \cdot \frac{\partial}{\partial\omega} [\omega\Psi_0(\omega)] \delta[\Omega-n\omega] e^{in(\theta_P-\theta_K)},\end{aligned}\quad (14.9)$$

where we have used the following representation of the delta-function

$$\frac{1}{\pi} \lim_{\gamma \rightarrow 0} \frac{\gamma}{[x^2 + \gamma^2]} = \delta(x) \quad . \quad (14.10)$$

Comparing Eqs. (14.9) and (14.7), we obtain the following general version of the fluctuation-dissipation relationship for the longitudinal dynamics of a continuous coasting beam in a storage ring:

$$\left[\frac{\partial}{\partial\Omega} - \frac{1}{\Omega} \right] \frac{\partial}{\partial\theta_{PK}} P_I(\Omega|\theta_{PK}) = \frac{i}{2\pi\kappa} [\tilde{\mathcal{R}}_{PK}(\Omega) + \tilde{\mathcal{R}}_{KP}^*(\Omega)] \quad . \quad (14.11)$$

If $\theta_P = \theta_K$, then $\tilde{\mathcal{R}}_{PK}(\Omega) = \tilde{\mathcal{R}}_{KP}(\Omega) = \tilde{\mathcal{R}}_{||}(\Omega)$ and we obtain

$$\left[\frac{\partial}{\partial\Omega} - \frac{1}{\Omega} \right] \frac{\partial P_I(\Omega|\theta_{PK})}{\partial\theta_{PK}} \Bigg|_{\theta_{PK}=0} = -\frac{i}{\pi\kappa} \text{Re} [\tilde{\mathcal{R}}_{||}(\Omega)] \quad . \quad (14.12)$$

Using the Kramers-Kronig relations for the analytic beam response function $\tilde{\mathcal{R}}(\Omega)$ [Eq. (5.30)], we obtain

$$\begin{aligned}\tilde{\mathcal{R}}_{||}(\Omega) &= \frac{i}{\pi} \lim_{\gamma \rightarrow 0^+} \int_{-\infty}^{+\infty} d\Omega' \frac{\text{Re} [\tilde{\mathcal{R}}_{||}(\Omega')]}{[\Omega - \Omega' + i\gamma]} \\ &= -\kappa \cdot \lim_{\gamma \rightarrow 0^+} \int_{-\infty}^{+\infty} d\Omega' \frac{\left[\frac{\partial}{\partial\Omega'} - \frac{1}{\Omega'} \right] \frac{\partial P_I(\Omega'|\theta_{PK})}{\partial\theta_{PK}} \Big|_{\theta_{PK}=0}}{[\Omega - \Omega' + i\gamma]}\end{aligned}\quad (14.13)$$

Thus the linear response of particle beams can be obtained from a knowledge of the incoherent fluctuation spectrum of the beam.

For relatively small spreads in revolution frequencies $\Delta\omega \ll \omega_0$, we may write

$$\frac{\partial P_I(\Omega|\theta_P, \theta_K)}{\partial\theta_{PK}} \Bigg|_{\theta_{PK}=0} \cong i \frac{q^2 N}{2\pi} \omega_0 \Omega \Psi(\Omega) \quad , \quad (14.14)$$

where

$$\Psi(\Omega) = \sum_{m=-\infty}^{+\infty} \frac{1}{|m|} \Psi_0\left(\frac{\Omega}{m}\right)$$

This follows from Eq. (14.5) with $\Delta\omega \ll \omega_0$. One then obtains from Eq. (14.12)

$$\text{Re } \tilde{\mathcal{R}}_{\parallel}(\Omega) = -\frac{N}{2} \Omega \omega_0 \frac{\partial \Psi(\Omega)}{\partial \Omega} (q^2 \kappa) . \quad (14.15)$$

With $\tilde{\mathcal{R}}_{\parallel}(\Omega) \equiv \tilde{\mathcal{B}}_{\parallel}(\Omega)$ defined as in Eq. (7.23), one then sees that Eq. (7.32) is nothing but an expression of the generalized fluctuation–dissipation relation for small frequency spreads. In fact, taking a Gaussian distribution as in Eq. (11.38) with temperature defined consistently as in Eq. (11.5), one can easily verify for non-overlapping bands that

$$P_{\mathbf{I}}(\Omega) = F(\Omega) \cdot 4kT_{\parallel} \text{Re } [\tilde{\mathcal{R}}_{\parallel}(\Omega)] , \quad (14.16)$$

where $F(\Omega)$ is a form factor depending on the location of Ω within the single non-overlapping band under consideration. For regions away from the zeros of $\tilde{\mathcal{R}}_{\parallel}(\Omega)$, it is of the order of unity. In general $F(\Omega)$ will also be a function of the beam distribution. Strictly speaking, however, a relation such as (14.16) is misleading, since it is the differential operation on $P_{\mathbf{I}}(\Omega)$, as in the left-hand side of Eq. (14.12), that is related to $\text{Re } [\tilde{\mathcal{R}}_{\parallel}(\Omega)]$ for the longitudinal case. For the transverse case, the representation (14.16) is reasonably appropriate [compare with Eq. (7.40)]. The reader is invited to discover these general fluctuation–dissipation relations for the transverse signals and for the bunched beams as well.

15. EPILOGUE

The attempt made in this report to provide a conceptual survey and exposition of the various aspects and interplay of fluctuations and coherence in charged particle beams in storage rings is meant to be more of a synthesis than analysis. Occasional diagrammatic expositions should not be mistaken as intentional avoidance of a systematic kinetic theoretical analysis. A serious reader cannot afford to ignore kinetic theory, where all the results of this essay are hidden. The effort made is to bring out the physical content of the concepts and the essence of kinetic theory more boldly, without being lost in the notational and mathematical intricacies. The idea is to see how the various aspects reflect each other, thus establishing, by association and connection, the *raison d'être* of kinetic theory in the context of charged particle beams, without getting into real technical details demanded by a thorough dissection. This synthetic nature may make this essay seem disjoint occasionally. Such gaps and discontinuities may be filled by working through the kinetic theory introduced in Appendix B (difficult task!) or by watching somebody else work through it by consulting the references. Considerations of bunched beam response have been relatively sketchy compared to those of continuous coasting beams. The topic is very specialized; the existing literature is vast and still growing. Again, the list of references should complement the gaps. Self-consistency in a topic of such a broad scope necessarily implies the boundaries between the various mosaic pieces to be fuzzy. These fuzzy zones are only invitations for future creative contributions.

Acknowledgements

While preparing the manuscript, I have enjoyed the hospitality and the *carte blanche* extended to me by the ARF Group of the SPS Division at CERN, where I have been a visitor. I have benefited from numerous discussions with D. Boussard (Group Leader), G. Dôme and T. Linnecar. From Dr. Boussard I have learnt very many things about the manipulation of bunches and the processing of signals derived from them in a storage ring and Dr. Dôme has complemented this by providing the only theoretical platform (otherwise missing from the SPS Division) on which to hold a continuous dialogue over a period of two years on those other aspects of physics which go beyond the realm of the senses. Discussions with L. Vos and W. Scandale, of the Machine Studies Team of the SPS Division, and with T. Linnecar, have contributed, in particular, to a better understanding on my part of aspects of the BTF and Schottky signal measurement and theory. A particular discussion over lunch with B. Zotter of the LEP Division has demystified certain aspects of the definition of the beam-storage-ring electromagnetic coupling impedance. Informal and spontaneous conversations, on a few occasions, with S. van der Meer of the PS Division have clarified some obscure features of the physics of coherent beam response in the region of overlapping fluctuation Schottky bands, and have unconsciously influenced my thinking. I am extremely grateful to G. Dôme and L. Evans (SPS) for their generous help in reading the manuscript in its entirety and providing valuable editorial comments, mostly on the broader aspects but occasionally on surprising details (G. Dôme). Discussions with L. Evans have also broadened my knowledge of some special features of the beam effects and the associated physics, in the $p\bar{p}$ collider at CERN, derived from his first-hand experience.

This report is a result of active encouragement from Dr. M. Month of the Brookhaven National Laboratory. I would like to thank him for presenting me with the opportunity to write on this topic by inviting me to contribute to the Proceedings of the BNL Accelerator Summer School and, more importantly, for waiting patiently for the manuscript to arrive.

Sincere thanks are due to people in the CERN Documentation (DOC) Department, in particular to Kitty Wakley and Marie-Suzy Vascotto of the Scientific Reports Editorial Section for their expert, efficient and painstaking work; to Rosmarie Meyer of the Text Processing Section (helped by Gloria Weilhammer, of the SPS Division) for rapid and accurate typing of the manuscript; and to Christiane Comby for incorporating figures and formulae into the text at a surprising speed.

APPENDIX A

GENERAL ASPECTS OF VARIOUS INTERACTIONS IN CHARGED PARTICLE BEAM-ENVIRONMENT SYSTEM

The dynamics described in Section 2 neglects all interactions except the single-particle interaction with the external electromagnetic fields $\Phi_{\text{ext}}(\vec{r}, t)$ and $\vec{A}_{\text{ext}}(\vec{r}, t)$. However, particles are charged and so they interact with each other and with the otherwise passive environment electromagnetically, with the overall effect on the beam distribution being increasingly significant with higher beam intensities.

Discrete electromagnetic interaction between pairs of charged particles within the beam manifests itself as intra-beam multiple Coulomb scattering, causing coupling and a temperature relaxation between different degrees of freedom, leading in general towards an equilibrium stationary distribution. However, under the special circumstance where the beam energy is above the transition energy of the high-energy storage ring, discrete Coulomb scattering can cause a slow diffusion or heating in phase space associated with the overall slowing of the beam^{44,48}.

There is also a coherent or collective aspect, as opposed to the discrete aspect above, of the electromagnetic interaction of the charged particle beam. Each particle in the beam moves under the additional collective electromagnetic fields of all the particles in the beam, i.e. the beam as a whole. The situation is similar to the dynamics in a non-neutral charged plasma. The collective fields, called space-charge fields in particle beams, generate correlations or coherence between particle trajectories. In addition, for high-energy beams in storage rings, the interaction of the beam as a whole with the electromagnetically susceptible external elements in the surroundings, e.g. vacuum-chamber walls, localized cavities, resonators, etc., through electromagnetic forces generated by induced currents and charge densities, is non-negligible and may even dominate over the collective fields arising from the direct electromagnetic interaction between particles. This interaction through the electromagnetic coupling impedance of the storage-ring elements, including the space-charge effect, can induce suitable phase relationships for self-sustained coherence and can thus cause various collective modes to be excited, leading to shifts in coherent and incoherent oscillation frequencies and, under unfavourable conditions, to beam collective instabilities^{29,30}.

Particles in the beam may also be subjected to noise forces arising from random deviations in time of the designed external guiding electromagnetic fields from their ideal values. They may also experience the microscopic phase-space fluctuation noise of the beam itself as in stochastic cooling^{7,20,21} where Schottky fluctuations of the beam, detected by pick-ups, are applied back to the beam. Dynamics in the presence of noise can often be described by a time-dependent random Hamiltonian or generally by random forces with certain spectral properties and leads in general to diffusion in phase space, e.g. RF noise diffusion in longitudinal phase space^{11,49,50}, Schottky noise diffusion or heating in stochastic cooling^{7,20,21}, etc. These noise phenomena will in general be categorized as single-particle incoherent phenomena.

For colliding beam storage rings, the beam particles may be subjected to the electromagnetic forces of an oppositely moving colliding beam, the so-called beam-beam forces⁵¹⁻⁵⁴. This beam-beam interaction may excite linear and non-linear resonances of a single particle in the storage ring and lead to particle losses by resonant amplitude growth, by inherent stochasticity in

the phase space of non-linear oscillations made accessible by beam-beam interaction or by the possible but yet-to-be-verified mechanism of Arnold diffusion. Periodic interaction with the forces of the opposing beam can also act as noise on the ‘sampling’ beam under consideration and lead to noise diffusion. Again, looked at from the frame of the ‘sampling’ beam, beam-beam effects are single-particle incoherent phenomena, induced nevertheless by the collective fields of the ‘sampled’ beam, except for the strong-strong situation, when collective effects due to the feedback between the ‘sampling’ and the ‘sampled’, both equally intense, beams have to be taken into account.

All the forces considered above are conservative. Particles may also be subjected to non-conservative forces as in stochastic cooling^{7,20,21)}, where a genuine dissipative self-force is imposed on a circulating particle by a properly matched feedback loop, or as in electron cooling^{55,56)}, where the kinetic collisional dynamics with a co-moving electron beam leads to a frictional drag force on the particle in the beam of interest. In addition, interaction of the particle with its own radiation electromagnetic fields (synchrotron radiation), arising from radial acceleration in a curved orbit, manifests itself as a non-conservative damping force⁵⁾. The phenomenon is called synchrotron radiation damping and leads to energy losses.

We are interested in an ordinary classical mechanical description of the dynamics of a system of charged particles in the beam arising from all these interactions with the aid of an underlying Hamiltonian or Lagrangian and possibly a few non-conservative self-forces, which all depend only on the coordinates and velocities (or canonical momenta) of these particles at one and the same time, in addition to possible explicit time dependences. The finite speed of propagation of electromagnetic interactions (retardation effect), however, intrinsically connects particle phase-space dynamical variables non-locally in time. In principle then, the exact dynamics does not allow a classical mechanical description of such a system with the aid of the instantaneous physical phase-space coordinates alone, except in the limit of infinite propagation speed of interactions (classical mechanics with instantaneous Coulomb interaction, i.e. assuming no retardation associated with the wave-propagated interaction through the vector potential, which is neglected totally) or under low-order relativistic effects only [e.g. classical Darwin Lagrangian⁵⁷⁾ up to order $(v/c)^2$]. In addition, one must consider the Lagrangian density associated with the dynamical phase-space degrees of freedom of the particles and the electromagnetic fields together for an exact description. Thus the Lagrangian will be a function of the particle phase-space variables and interacting electromagnetic field variables at each point in space-time. The dynamics is thus describable by a single Hamiltonian, but only so at the cost of introducing an infinite number of field variables.

In so far as we are interested in the classical processes, there is no difficulty in an ordinary classical mechanical description for the discrete single-particle incoherent effects. Thus for the discrete two-particle electromagnetic interaction causing intra-beam scattering, we only consider the instantaneous Coulomb interaction through the electrostatic potential, i.e. Coulomb scattering^{44,48)}. The influence of the Schottky noise in stochastic cooling can similarly be described as the instantaneous interaction of the sampling test particle in the beam, with all the other particles locally at the kicker only, periodically in time⁷⁾. The transfer function of the external cooling feedback loop at harmonics of the incoherent single-particle frequencies will enter as coefficients in the Fourier series expansion of the forces or potentials in the canonical action-angle variables. Similarly the non-conservative self-interaction in stochastic^{7,21)} and electron cooling and synchrotron radiation can be described in terms of generalized forces depending on instantaneous

particle phase-space variables together with appropriate Fourier-transformed frequency domain coupling strengths of the interaction. The beam-beam interaction also lends itself to an easy classical description through the electromagnetic fields \vec{E}_{ob} and \vec{B}_{ob} or the respective potentials of the opposing beam as a whole⁵²⁾. Finally external noise force perturbations are straightforwardly described by time-dependent Hamiltonians that depend on the phase-space coordinates of the noise-affected particle at one and the same time^{11,50)}.

The difficulty arises when describing collective effects. In the zeroth approximation of no interaction, the beam is described by a stationary distribution which can only be a function of the single-particle constants of motion (e.g. action). There is no collective field. In the presence of interactions, one has to include the variables corresponding to the collective fields, in addition to particle phase-space variables. For first-order collective effects, one can provide a Hamiltonian description by invoking the concept of self-consistent collective potential fields Φ_{sc} and \vec{A}_{sc} generated by the beam²⁵⁾. The self-consistent electromagnetic fields \vec{E}_{sc} and \vec{B}_{sc} are related to the coherent physical observables of the beam, e.g. current density, transverse dipole-moment density, etc. The constant of proportionality in this relation is described by a lumped impedance function, which is the Fourier transform of the causal Green's function for collective interaction of the beam as a whole²⁹⁾. The coherent physical observables of the beam in turn depend on the generating distribution of the beam in phase space, which follows a certain 'law of flow'. The evolving beam distribution in turn generates additional collective fields, thus modifying the original ones. These fields modify original beam distribution and so on. The dynamics is circular and hence the necessity of self-consistency. The dynamics may allow a class of collectively self-consistent equilibria for the beam. However, there may be coherent perturbations (e.g. current-density modulations, transverse-position modulations, etc.) on top of these self-consistent collective equilibria, which are again propagated collectively and self-consistently by the generating perturbations in phase space. By describing the collective interactions of the beam as a whole with itself and the surroundings by these lumped impedances, one is able to provide a Hamiltonian description of a single particle moving in these self-consistent fields in the conventional way. For the complete collective dynamics, one has to supplement such a Hamiltonian describing generation of self-consistent fields by a 'law of flow' in phase space, e.g. Vlasov equation^{25,29)}. All the physics of collective effects is then hidden in the properties of the lumped impedances, the beam-phase-space distribution and the single-particle trajectories in the absence of any interactions.

The most general equations of motion for a single particle in a beam in the presence of all these interactions may then be written as⁷⁾

$$\dot{\vec{I}}_i = \vec{G}(i,i) + \sum_{\substack{j=1 \\ \neq i}}^N \vec{G}(i,j) + \vec{G}[i, \xi_{noise}(t)] + \vec{G}[i, \{\vec{E}_{ob}, \vec{B}_{ob}\}] \quad (\text{A.1})$$

$$\dot{\vec{\psi}}_i = \vec{\omega}_i + \vec{H}(i,i) + \sum_{\substack{j=1 \\ \neq i}}^N \vec{H}(i,j) + \vec{H}[i, \xi_{noise}(t)] + \vec{H}[i, \{\vec{E}_{ob}, \vec{B}_{ob}\}] \quad , \quad (\text{A.2})$$

where the particle indices i, j , etc., as arguments of functions, represent the complete set of canonical action-angle variables $(\vec{I}_i, \vec{\psi}_i)$ corresponding to particle i in phase space. The

self-consistent collective field forces $\vec{G}[i, \{\vec{E}_{sc}, \vec{B}_{sc}\}]$ and $\vec{H}[j, \{\vec{E}_{sc}, \vec{B}_{sc}\}]$ are actually included in the $\sum_{j \neq i}^N \vec{G}(i, j)$ and $\sum_{j \neq i}^N \vec{H}(i, j)$ terms above.

Moreover, since except for the non-conservative self-forces $\vec{G}(i, i)$ and $\vec{H}(i, i)$, the dynamics is governed by an underlying conservative Hamiltonian, one has the following extra condition of Hamiltonian flow⁷⁾:

$$\frac{\partial}{\partial \vec{I}_i} \cdot [\dot{\vec{I}}_i - \vec{G}(i, i)] = - \frac{\partial}{\partial \vec{\psi}_i} \cdot [\dot{\vec{\psi}}_i - \vec{H}(i, i)] \quad . \quad (\text{A.3})$$

In terms of a general coordinate $\vec{x}_i \equiv \{\vec{I}_i, \vec{\psi}_i\}$ and generalized self-force $\vec{F}_x(i, i)$, one has

$$\frac{\partial}{\partial \vec{x}_i} \cdot [\dot{\vec{x}}_i - \vec{F}_x(i, i)] = 0 \quad . \quad (\text{A.4})$$

Since the generalized forces $\vec{G}(i, j)$ and $\vec{H}(i, j)$ are periodic in the 2π -periodic angle variables $\vec{\psi}_i, \vec{\psi}_j$, we can decompose them in a general Fourier series in the harmonics of $\vec{\psi}_{i, j}$ as follows:

$$\vec{G}(\vec{I}_i, \vec{\psi}_i; \vec{I}_j, \vec{\psi}_j) = \sum_{\vec{n}_i} \sum_{\vec{n}_j} \vec{G}_{\vec{n}_i, \vec{n}_j}(\vec{I}_i, \vec{I}_j) e^{i[\vec{n}_i \cdot \vec{\psi}_i + \vec{n}_j \cdot \vec{\psi}_j]} \quad (\text{A.5})$$

$$\vec{H}(\vec{I}_i, \vec{\psi}_i; \vec{I}_j, \vec{\psi}_j) = \sum_{\vec{n}_i} \sum_{\vec{n}_j} \vec{H}_{\vec{n}_i, \vec{n}_j}(\vec{I}_i, \vec{I}_j) e^{i[\vec{n}_i \cdot \vec{\psi}_i + \vec{n}_j \cdot \vec{\psi}_j]} \quad , \quad (\text{A.6})$$

where \vec{n}_i, \vec{n}_j are each a triplet of integers $0, \pm 1, \pm 2, \dots$

We will now make some general statements without proof. They can be derived⁷⁾ from the kinetic theory discussed in Appendix B in general, and from general noise theory⁵⁸⁾, following the references cited later.

Let us consider only the first two terms in Eq. (A.1), neglecting external noise and the effect of the other beam. These two terms include damping due to self-interaction, scattering due to close encounters between particles in the beam, and the effective collective processes due to the collective fields. If the collective effects are negligible, one can show that the first two terms lead to an evolution of the beam single-particle distribution $\Psi(\vec{I}; t)$, averaged over the angles $\vec{\psi}$ (i.e. the zeroth harmonic $\vec{n} = 0$ in $\vec{\psi}$), in the form of the following Fokker-Planck equation⁷⁾:

$$\frac{\partial \Psi(\vec{I}; t)}{\partial t} = - \frac{\partial}{\partial \vec{I}} \cdot [\vec{F}(\vec{I}) \Psi(\vec{I}; t)] + \frac{1}{2} \frac{\partial}{\partial \vec{I}} \cdot \left[\underline{\underline{D}}(\vec{I}) \cdot \frac{\partial \Psi(\vec{I}; t)}{\partial \vec{I}} \right] \quad , \quad (\text{A.7})$$

where the coefficients \vec{F} and $\underline{\underline{D}}$ of the friction vector and diffusion tensor are given by⁷⁾:

$$\vec{F}(\vec{I}) = \sum_{\vec{n}} \vec{G}_{\vec{n}, -\vec{n}}(\vec{I}, \vec{I}) \quad (\text{A.8})$$

$$\underline{D}(\vec{I}) = 2\pi N \sum_{\vec{n}} \sum_{\vec{n}'} \int d\vec{I}' [G_{-\vec{n}, \vec{n}'}(\vec{I}, \vec{I}') G_{-\vec{n}, \vec{n}'}^*(\vec{I}, \vec{I}')] \Psi_0(\vec{I}') \delta[\vec{n}' \cdot \vec{\omega}(\vec{I}') - \vec{n} \cdot \vec{\omega}(\vec{I})] \quad . \quad (\text{A.9})$$

Generally, the relaxation is slow enough for $\underline{D}(\vec{I})$ to be evaluated with instantaneous, almost time-independent, stationary distribution $\Psi_0(\vec{I})$ for the time scales of interest. In general, however, $D \equiv D\{(\vec{I}, \Psi(\vec{I}, t))\}$, and the Fokker-Planck equation is non-linear in Ψ . If the coefficients $\vec{F}(\vec{I})$ and $\underline{D}(\vec{I})$ are linear in \vec{I} and the non-linearity of the Fokker-Planck equation can be neglected, one may take moments⁷⁾ of (A.7) to get the time evolution of $\langle \vec{I} \rangle \equiv (\langle I_x \rangle, \langle I_z \rangle, \langle J \rangle)$, which are proportional to the oscillation amplitude squared in each dimension for linear oscillations.

The friction and diffusion coefficients are modified if collective interactions are important. The general effect is quite complicated. For continuous coasting beams, with collective interactions in only one degree of freedom with no coupling between various degrees of freedom and no band overlap [i.e. $\vec{n} \cdot \vec{\omega}(\vec{I}) = \vec{n}' \cdot \vec{\omega}(\vec{I}')$ is satisfied for $\vec{n} = \vec{n}'$ only], the scalar F and D coefficients in the Fokker-Planck equation are modified^{7,21)} as

$$F(\vec{I}) = \sum_{\vec{n}} \frac{G_{\vec{n}, -\vec{n}}(\vec{I}, \vec{I})}{\epsilon_{\vec{n}}(\vec{I})} \quad (\text{A.10})$$

and

$$D(\vec{I}) = 2\pi N \sum_{\vec{n}} \int d\vec{I}' \frac{|G_{-\vec{n}, \vec{n}}(\vec{I}, \vec{I}')|^2}{|\epsilon_{\vec{n}}(\vec{I})|^2} \Psi_0(\vec{I}') \delta(\vec{n} \cdot [\vec{\omega}(\vec{I}') - \vec{\omega}(\vec{I})]) \quad , \quad (\text{A.11})$$

where

$$\epsilon_{\vec{n}}(\vec{I}) = \epsilon(\Omega) \Big|_{\Omega = \vec{n} \cdot \vec{\omega}(\vec{I})}$$

and

$$\epsilon(\Omega) = 1 - iN \lim_{\gamma \rightarrow 0^+} \int d\vec{I}' \frac{G_{-\vec{n}, \vec{n}}^*(\vec{I}', \vec{I}) \frac{\partial \Psi_0(\vec{I}')}{\partial \vec{I}'}}{[\Omega - \vec{n} \cdot \vec{\omega}(\vec{I}') + i\gamma]} \quad (\text{A.12})$$

Note that the Fokker-Planck equation is now in only one dimension, namely I.

For general coupled collective interaction in all three dimensions, one would have a tensor $\underline{\epsilon}(\Omega)$, and D would modify as^{7,59)} $\underline{D} \rightarrow \underline{\epsilon}^{-1} \cdot \underline{D} \cdot (\underline{\epsilon}^{-1})^\dagger$, where $(\underline{\epsilon}^{-1})^\dagger$ is the Hermitian conjugate of $\underline{\epsilon}^{-1}$. For bunched beams, even with scalar interaction, $\epsilon(\Omega)$ is an infinite matrix⁷⁾ in general; modification of F and D is quite complicated⁷⁾. We do not enter into this discussion.

Aside from the beam evolution or relaxation in time, the collective interactions will endow the beam with a set of collective modes. These are simply obtained from the dispersion relation

$$\varepsilon(\Omega) = 0 \quad . \quad (\text{A.13})$$

The complex roots $\Omega_k = \omega_k + i\gamma_k$ of relation (A.13) determine the frequencies of the coherent collective modes, which may be stable, growing, or decaying, if $\gamma_k = 0, > 0$, or < 0 respectively.

The effect of the third term in Eq. (A.1) on the beam is usually a slow diffusion, typical of noise. The beam evolution in time is again given by a Fokker-Planck equation

$$\frac{\partial \Psi(\vec{I}; t)}{\partial t} = - \frac{\partial}{\partial \vec{I}} \cdot [\vec{F}(\vec{I}) \Psi(\vec{I}, t)] + \frac{1}{2} \frac{\partial^2}{\partial \vec{I} \partial \vec{I}} : [\underset{\approx}{D}(\vec{I}) \Psi(\vec{I}, t)] \quad . \quad (\text{A.14})$$

For noise forces describable by a Hamiltonian satisfying Eq. (A.3), as in our case, one has the extra relation^{7,11,50)}

$$\vec{F}(\vec{I}) = \frac{1}{2} \frac{\partial}{\partial \vec{I}} \cdot \underset{\approx}{D}(\vec{I}) \quad , \quad (\text{A.15})$$

so that

$$\frac{\partial \Psi(\vec{I}; t)}{\partial t} = \frac{1}{2} \frac{\partial}{\partial \vec{I}} \left[\underset{\approx}{D}(\vec{I}) \cdot \frac{\partial \Psi(\vec{I}, t)}{\partial \vec{I}} \right] \quad . \quad (\text{A.16})$$

The effect of noise is thus described by a diffusion equation. The diffusion coefficient under quite general circumstances is given by^{7,58)}

$$\underset{\approx}{D}(\vec{I}) = 2 \int_0^{\infty} d\tau \left\langle \underset{\approx}{G}_{\xi}[\vec{I}(t), \vec{\psi}(t); t] \underset{\approx}{G}_{\xi}[\vec{I}(t-\tau), \vec{\psi}(t-\tau), t-\tau] \right\rangle_{\xi} \quad , \quad (\text{A.17})$$

where $\underset{\approx}{G}_{\xi}[\vec{I}(t), \vec{\psi}(t); t] = \underset{\approx}{G}[i, \xi_{\text{noise}}(t)]$ describes the generalized noise force and the angular brackets mean an average over all the noise ensembles characterized by a random index ξ and the incoherent phases of the particles in the beam distribution. If we denote

$$\underset{\approx}{G}_{\xi}(t) = \underset{\approx}{G}_{\xi}[\vec{I}(t), \vec{\psi}(t); t] \quad (\text{A.18})$$

and

$$\underset{\approx}{R}(\tau) = \left\langle \underset{\approx}{G}_{\xi}(t) \underset{\approx}{G}_{\xi}(t-\tau) \right\rangle \quad , \quad (\text{A.19})$$

then

$$\underset{\approx}{R}(\Omega, \vec{I}) = \int_{-\infty}^{+\infty} d\tau e^{-i\Omega\tau} \underset{\approx}{R}(\tau) = \sum_{\vec{n}} \left\langle \underset{\approx}{G}_{\vec{n}}(\vec{I}) \underset{\approx}{G}_{-\vec{n}}(\vec{I}) \right\rangle_{\xi} \delta[\Omega - \vec{n} \cdot \underset{\approx}{\vec{\omega}}(\vec{I})] \quad (\text{A.20})$$

and the diffusion coefficient is simply

$$\underset{\approx}{D}(\vec{I}) = \underset{\approx}{\tilde{R}}(\Omega, \vec{I}) \Big|_{\Omega=0} \quad , \quad (\text{A.21})$$

i.e. it is given by the zero frequency ($\Omega = 0$) d.c. component of the power spectrum of the generalized noise force $\vec{G}_\xi(t)$.

Finally the effect of the last term, the beam-beam force, is special and complicated enough to be outside the scope of this report. Existing review articles are listed as Refs. 51–54.

This is all we will say about the general interactions in a particle beam-storage-ring system. We do not study further the exact form of the interactions $\vec{G}_{\vec{n}^+ \vec{n}^- j}$ (\vec{I}_i, \vec{I}_j), etc., for various interactions such as intra-beam Coulomb scattering^{44,48}), stochastic cooling⁷), RF-noise force^{11,50}), beam-beam force^{51,52}), etc., with one exception: the coherent collective force. This, we have already studied at some length in Section 8 and we have made use of it in the report.

APPENDIX B

KINETIC THEORY

In this Appendix we briefly discuss the framework of kinetic theory^{7,21,25)}, which in principle is capable of providing a complete description of the dynamics of the whole beam, including single-particle incoherent and collective coherent effects, and possible interplay between the two by taking into account all the interactions mentioned in Appendix A. We begin by writing the grand continuity equation, explicitly in action-angle variables $\{\vec{I}_i, \vec{\psi}_i\}$, for the density $D([x];t) \equiv D(\vec{I}_1, \vec{\psi}_1, \vec{I}_2, \vec{\psi}_2, \dots, \vec{I}_N, \vec{\psi}_N; t)$ in $6N$ -dimensional Γ -space.

$$\frac{\partial D}{\partial t} + \sum_{i=1}^N \left[\frac{\partial}{\partial \vec{I}_i} \cdot (\dot{\vec{I}}_i D) + \frac{\partial}{\partial \vec{\psi}_i} \cdot (\dot{\vec{\psi}}_i D) \right] = 0 \quad . \quad (\text{B.1})$$

We define reduced distributions by integrating over the variables we do not wish to care about. Thus we define a reduced one-particle distribution by

$$f_1(1; t) \equiv f_1(\vec{I}_1, \vec{\psi}_1; t) = \int_{\mathfrak{S}(N-1)} (d\vec{I}_2 d\vec{\psi}_2) \dots (d\vec{I}_N d\vec{\psi}_N) D(\vec{I}_1, \vec{\psi}_1, \dots, \vec{I}_N, \vec{\psi}_N; t) \quad (\text{B.2})$$

and similarly a two-particle distribution by

$$\begin{aligned} f_2(1, 2; t) &\equiv f_2(\vec{I}_1, \vec{\psi}_1; \vec{I}_2, \vec{\psi}_2; t) \\ &= \int_{\mathfrak{S}(N-2)} (d\vec{I}_3 d\vec{\psi}_3) \dots (d\vec{I}_N d\vec{\psi}_N) D(\vec{I}_1, \vec{\psi}_1, \dots, \vec{I}_N, \vec{\psi}_N; t) \end{aligned} \quad (\text{B.3})$$

and so on. To obtain equations for the one-particle, two-particle, etc., distributions, we start integrating Eq. (B.1) over $6(N-1)$, $6(N-2)$, etc., particle variables. Thus the one-particle equation, after integrating over particles (2, ..., N), is given by:

$$\frac{\partial f_1}{\partial t} = - \int_{\mathfrak{S}(N-1)} (d\vec{I}_2 d\vec{\psi}_2) \dots (d\vec{I}_N d\vec{\psi}_N) \left[\frac{\partial}{\partial \vec{I}_1} \cdot (\dot{\vec{I}}_1 D) + \frac{\partial}{\partial \vec{\psi}_1} \cdot (\dot{\vec{\psi}}_1 D) \right] \quad , \quad (\text{B.4})$$

where terms of the form $(\partial/\partial \vec{I}_j) \cdot (\dot{\vec{I}}_j D)$ and $(\partial/\partial \vec{\psi}_j) \cdot (\dot{\vec{\psi}}_j D)$ for $j = 2, \dots, N$ disappear after integration by parts and owing to the boundary conditions on $\vec{I}_j D([x]; t)$ and $\vec{\psi}_j D([x]; t)$, which must vanish at infinity.

Let us now take the general interaction to be of the form as given by Eqs. (A.1) and (A.2), neglecting the last two terms corresponding to the effect of external noise and the opposing colliding beam. These latter can be included trivially. The resulting equations should describe the non-conservative processes, collective processes, and the single-particle incoherent discrete processes, with all possible interconnections, completely for a single beam without external noise.

Using the Hamiltonian flow condition (A.3) and the symmetry of D under the interchange of particle indices we obtain

$$\begin{aligned} \frac{\partial f_1}{\partial t} + \vec{\omega}_1 \cdot \frac{\partial f_1}{\partial \vec{\psi}_1} + (N-1) \int (d\vec{\psi}_2 d\vec{I}_2) \left[\vec{G}(1,2) \cdot \frac{\partial f_2(1,2;t)}{\partial \vec{I}_1} + \vec{H}(1,2) \frac{\partial f_2(1,2;t)}{\partial \vec{\psi}_1} \right] \\ = - \frac{\partial}{\partial \vec{I}_1} \cdot [\vec{G}(1,1)f_1] - \frac{\partial}{\partial \vec{\psi}_1} \cdot [\vec{H}(1,1)f_1] \end{aligned} \quad (\text{B.5})$$

The terms on the right-hand side express the contribution from the dissipative non-conservative flow, aside from the Liouvillian conservative flow expressed by the left-hand side, and induce compression or rarefaction of the phase space. The integrals on the left-hand side describe interaction with other beam particles and include the self-consistent Vlasov average field and correlation effects studied in Sections 5 to 10 on collective effects. They also include discrete pair interactions or Coulomb scattering, leading to collisional diffusion previously called intra-beam scattering.

Similarly integrating Eq. (B.1), over particles (3, ..., N) and using the same dynamics and symmetry assumption for D, one obtains an equation for the two-particle distribution $f_2(1,2;t)$ in terms of the three-particle distribution $f_3(1,2,3;t)$, and so on. Thus, as expected, a hierarchy of relations between the reduced distributions may be developed, which terminates only at the flow equation for the full N-particle distribution, which is the grand continuity equation itself.

We disentangle the totally and irreducibly correlated or connected parts of the distributions by writing the following ‘cluster decomposition’:

$$\begin{aligned} f_1(1;t) &= f(1;t) \\ f_2(1,2;t) &= f(1;t)f(2;t) + g(1,2;t) \\ f_3(1,2,3;t) &= f(1;t)f(2;t)f(3;t) + [f(1;t)g(2,3;t) + \text{cyclic permutations}] + h(1,2,3;t) \\ &\cdot \\ &\cdot \\ &\cdot \\ \text{etc.} & \end{aligned} \quad (\text{B.6})$$

We may truncate the hierarchy beyond f_2 by setting $h(1,2,3;t) \approx 0$, i.e. neglecting three-body correlations as being small compared to the two-body correlations, which we retain as being non-negligible $g(1,2;t) \neq 0$. For large N, we may also assume $N \approx (N-1) \approx (N-2)$. With the strengths of the interparticle interactions G and H supposed to be given by a small parameter $\epsilon \ll 1$, we assume then the following hierarchy of correlation strengths:

$$\dots \frac{h(1,2,3;t)}{g(1,2;t)} \sim \frac{g(1,2;t)}{f(1;t)f(2;t)} \sim G, H \sim \mathcal{O}(\epsilon) \quad (\text{B.7})$$

Then $g \sim \mathcal{O}(\epsilon)$ and $h \sim \mathcal{O}(\epsilon^2)$. Accordingly we may also neglect terms of the form Gg and Hg which are $\mathcal{O}(\epsilon^2)$, the same as h, unless they are multiplied by $N \gg 1$, in which case we retain

them. Under all these hierarchical considerations for the correlations, one may then finally reduce the equations for one-body- and two-body-connected distributions f and g to the following:

$$\begin{aligned}
& \frac{\partial f(\vec{1};t)}{\partial t} + \vec{\omega}_1 \cdot \frac{\partial f(\vec{1};t)}{\partial \vec{\psi}_1} + N \frac{\partial f(\vec{1};t)}{\partial \vec{I}_1} \cdot \int (d\vec{I}_2 d\vec{\psi}_2) \vec{G}(\vec{1},2) f(\vec{2};t) + \\
& \quad + N \frac{\partial f(\vec{1};t)}{\partial \vec{\psi}_1} \cdot \int (d\vec{I}_2 d\vec{\psi}_2) \vec{H}(\vec{1},2) f(\vec{2};t) \\
& = - \frac{\partial}{\partial \vec{I}_1} \cdot [\vec{G}(\vec{1},1) f(\vec{1};t)] - \frac{\partial}{\partial \vec{\psi}_1} \cdot [\vec{H}(\vec{1},1) f(\vec{1};t)] - N \int (d\vec{I}_2 d\vec{\psi}_2) \left[\vec{G}(\vec{1},2) \frac{\partial g(\vec{1},2;t)}{\partial \vec{I}_1} \right. \\
& \quad \left. + \vec{H}(\vec{1},2) \frac{\partial g(\vec{1},2;t)}{\partial \vec{\psi}_1} \right] \tag{B.8}
\end{aligned}$$

and

$$\begin{aligned}
& \frac{\partial g(\vec{1},2;t)}{\partial t} + \vec{\omega}_1 \cdot \frac{\partial g(\vec{1},2;t)}{\partial \vec{\psi}_1} + \vec{\omega}_2 \cdot \frac{\partial g(\vec{1},2;t)}{\partial \vec{\psi}_2} + \\
& \quad + \left[\left\{ N \frac{f(\vec{1};t)}{\partial \vec{I}_1} \cdot \int (d\vec{I}_3 d\vec{\psi}_3) \vec{G}(\vec{1},3) g(\vec{2},3;t) + (1 \leftrightarrow 2) \right\} + \left(\begin{array}{c} \text{I} \rightarrow \psi \\ \text{G} \rightarrow \text{H} \end{array} \right) \right] \\
& = - \left[\left\{ N \frac{\partial g(\vec{1},2;t)}{\partial \vec{I}_1} \cdot \int (d\vec{I}_3 d\vec{\psi}_3) \vec{G}(\vec{1},3) f(\vec{3};t) + (1 \leftrightarrow 2) \right\} + \left(\begin{array}{c} \text{I} \rightarrow \psi \\ \text{G} \rightarrow \text{H} \end{array} \right) \right] \\
& \quad - \left[\left\{ \vec{G}(\vec{1},2) \cdot \frac{\partial f(\vec{1};t)}{\partial \vec{I}_1} f(\vec{2};t) + (1 \leftrightarrow 2) \right\} + \left(\begin{array}{c} \text{I} \rightarrow \psi \\ \text{G} \rightarrow \text{H} \end{array} \right) \right] . \tag{B.9}
\end{aligned}$$

Using the Fourier series representation of $f(\vec{I}, \vec{\psi}; t)$, $g(\vec{I}_1, \vec{\psi}_1; \vec{I}_2, \vec{\psi}_2; t)$ and $G(\vec{I}_1, \vec{\psi}_1; \vec{I}_2, \vec{\psi}_2)$ similar to Eqs. (A.5) and (A.6), we obtain for the angle-independent distribution $f_0(\vec{I}; t) = (1/2\pi)^3 \int_0^{2\pi} d\vec{\psi} f(\vec{I}, \vec{\psi}; t)$ the following:

$$\frac{\partial f_0(\vec{I}; t)}{\partial t} + \frac{\partial}{\partial \vec{I}} \cdot \sum_{\vec{n}} [\vec{G}_{\vec{n}, -\vec{n}}(\vec{I}, \vec{I}) f_0(\vec{I}; t)] = - \frac{\partial}{\partial \vec{I}} \cdot \left[\sum_{\vec{n}} \vec{R}_{\vec{n}\vec{n}}^*(\vec{I}, \vec{I}) \right], \tag{B.10}$$

where

$$\vec{R}_{\vec{n}_1 \vec{n}_2}(\vec{I}_1, \vec{I}_2) = N \sum_{\vec{n}_3} \int d\vec{I}_3 \vec{G}_{\vec{n}_1 \vec{n}_3}^*(\vec{I}_1, \vec{I}_3) g_{\vec{n}_2 \vec{n}_3}(\vec{I}_2, \vec{I}_3; t) \tag{B.11}$$

satisfies the integral equation

$$\begin{aligned}
\vec{R}_{\vec{n}_2 \vec{n}_1}(\vec{I}_2, \vec{I}_1) = & -\pi N \sum_{\vec{n}_3} \int d\vec{I}_3 \delta_+[\vec{n}_3 \cdot \vec{\omega}_3 - \vec{n}_1 \cdot \vec{\omega}_1] \vec{G}_{\vec{n}_2 \vec{n}_3}^*(\vec{I}_2, \vec{I}_3) \\
& \cdot \left[\vec{G}_{\vec{n}_1 \vec{n}_3}(\vec{I}_1, \vec{I}_3) \cdot \frac{\partial f_0(1; t)}{\partial \vec{I}_1} f_0(3; t) - \vec{G}_{\vec{n}_3 \vec{n}_1}^*(\vec{I}_3, \vec{I}_1) \cdot \frac{\partial f_0(3; t)}{\partial \vec{I}_3} f_0(1; t) \right. \\
& \left. + \frac{\partial f_0(1; t)}{\partial \vec{I}_1} \cdot \vec{R}_{\vec{n}_1 \vec{n}_3}^*(\vec{I}_1, \vec{I}_3) - \frac{\partial f_0(3; t)}{\partial \vec{I}_3} \cdot \vec{R}_{\vec{n}_3 \vec{n}_1}(\vec{I}_3, \vec{I}_1) \right] , \quad (\text{B.12})
\end{aligned}$$

and where

$$\pi \delta_+(x) = \pi \delta(x) - iP(1/x) = \lim_{\eta \rightarrow 0^+} \frac{1}{[\eta + ix]} . \quad (\text{B.13})$$

Note that if we neglect the non-conservative force terms on the right-hand side of Eq. (B.5) and neglect the two-body correlations $g(1,2;t) \approx 0$ so that $f_2(1,2;t) = f(1;t)f(2;t)$, Eq. (B.5) reduces to the Vlasov equation

$$\frac{\partial f_1}{\partial t} + \dot{\vec{\psi}}_1 \cdot \frac{\partial f_1}{\partial \vec{\psi}_1} + \dot{\vec{I}}_1 \cdot \frac{\partial f_1}{\partial \vec{I}_1} = 0 . \quad (\text{B.14})$$

In fact, with neglect of the non-conservative forces, the second term on the left-hand side in Eq. (B.1) is simply a classical Poisson bracket so that Eq. (B.1) may be written as

$$\frac{\partial D}{\partial t} = [\mathcal{H}^T, D] \quad (\text{B.15})$$

where \mathcal{H}^T is the total Hamiltonian of the whole beam. Equation (B.14) may then be written as

$$\frac{\partial \Psi}{\partial t} = [\mathcal{H}, \Psi] \quad (\text{B.16})$$

where $\Psi(\vec{I}, \vec{\psi}; t) \equiv f_1(\vec{I}_1, \vec{\psi}_1; t)$ and \mathcal{H} is the single-particle Hamiltonian.

The single-particle and collective aspects of the dynamics of the whole beam up to two-body correlations, are all hidden in the set of Eqs. (B.10)–(B.12). In principle, these equations are capable of describing relaxation or transport phenomena in single-particle phase space (diffusion, cooling, etc.), coherent collective effects (collective modes, beam stability, collective distortion of

fluctuations and beam response, etc.) and the feedback between the two. A complete solution to the set of equations requires solving the integral equation (B.12), which is in general a non-trivial task. It involves complicated gymnastics in the complex plane of analytic functions, such as Wiener-Hopf techniques, etc. An exact solution to the complete set of Eqs. (B.10)–(B.12) for continuous coasting beams can be obtained, in spite of the tedious manipulations required. This is sketched in Ref. 21 with a list of further helpful references. Some idea about general techniques and methods including bunched beams and arbitrary collection of charged particles (plasma) may be obtained by consulting Refs. 7, 25 and 45.

REFERENCES

- 1) H. Bruck, *Accélérateurs circulaires de particules* (Presses universitaires de France, Paris, 1966).
- 2) A.A. Kolomensky and A.N. Lebedev, *Theory of Cyclic Accelerators* (North-Holland Publishing Co., Amsterdam, 1966).
- 3) M.H. Blewett, ed., Proc. First Course Int. School on Accelerators, Erice, 1976: *Theoretical Aspects of The Behaviour of Beams in Accelerators and Storage Rings* (CERN 77-13, Geneva, 1977).
- 4) E. Courant and H. Snyder, 'Theory of Alternating Gradient Synchrotron', *Ann. Phys.* **3**, 1-48 (1958).
- 5) M.W. Sands, 'The Physics of Electron Storage Rings: An Introduction', SLAC-121 (1970).
- 6) E.J.N. Wilson, 'Proton Synchrotron Accelerator Theory', CERN 77-07 (1977).
- 7) S. Chattopadhyay, 'On Stochastic Cooling of Bunched Beams from Fluctuation and Kinetic Theory', Lawrence Berkeley Laboratory Report LBL-14826 (1982).
- 8) H. Goldstein, *Classical Mechanics* (Addison-Wesley, Cambridge, Mass., 1950).
- 9) A. Hofmann and S. Myers, 'Beam Dynamics in a Double RF System', Proc. 11th Int. Conf. on High-Energy Accelerators, Geneva, 1980 (Birkhäuser, Basle, 1980), pp. 610-614.
- 10) N.N. Bogoliubov and Y.A. Mitropolsky, *Asymptotic Methods in the Theory of Nonlinear Oscillations* (Hindustan Publishing Corp., Delhi, 1961).
- 11) G. Dôme, 'Theory of RF Acceleration and RF Noise', to be published in Proc. CERN Accelerator School: *Course on Antiprotons for Colliding Beam Facilities*, Geneva, 1983.
- 12) B.V. Chirikov, 'Universal Instability of Many-Dimensional Oscillator Systems', *Phys. Rep.* **52**, 263 (1979).
- 13) A. Papoulis, *Probability, Random Variables and Stochastic Processes* (McGraw-Hill Book Co., New York, 1965).
- 14) R. Littauer, 'Beam Instrumentation', Proc. SLAC Summer School: *Physics of High Energy Particle Accelerators*, Stanford, 1982 (AIP Conf. Proc. No. 105, New York, 1982), pp. 869-953.
- 15) J. Borer, 'Beam Diagnostics', to be published in Proc. CERN Accelerator School: *Course on Antiprotons for Colliding Beam Facilities*, Geneva, 1983.
- 16) W. Schnell, 'Statistical Phenomena—Experimental Results', Proc. First Course Int. School on Accelerators, Erice, 1976: *Theoretical Aspects of The Behaviour of Beams in Accelerators and Storage Rings* (CERN 77-13, Geneva, 1977), p. 290.
- 17) H.G. Hereward, 'Statistical Phenomena—Theory', Proc. First Course Int. School on Accelerators, Erice, 1976: *Theoretical Aspects of The Behaviour of Beams in Accelerators and Storage Rings* (CERN 77-13, Geneva, 1977), p. 281.
- 18) T. Linnecar and W. Scandale, 'A Transverse Schottky Noise Detector for Bunched Proton Beams', *IEEE Trans. Nucl. Sci.* **NS-28**, No. 3, 2147-2149 (1981).
- 19) J. Borer et al., 'Non-Destructive Diagnostics of Coasting Beams with Schottky Noise', Proc. 9th Int. Conf. on High-Energy Accelerators, Stanford, 1974 (USAEC Conf 740522, Washington, DC, 1974), pp. 53-65.
- 20) D. Möhl et al., 'Physics and Techniques of Stochastic Cooling', *Phys. Rep.* **58**, 73-119 (1980).
- 21) J. Bisognano and C. Leeman, 'Stochastic Cooling', Proc. FNAL Summer School: *Physics of High Energy Particle Accelerators*, Batavia, 1981 (AIP Conf. Proc. No. 87, New York, 1981), pp. 583-655.

- 22) F.J. Sacherer, 'Stochastic Cooling Theory', report CERN/ISR-TH/78-11 (1978).
- 23) F.E. Mills and F.J. Cole, 'Increasing the Phase-Space Density of High-Energy Particle Beams', *Ann. Rev. Nucl. Part. Sci.* **31**, 295-335 (1981).
- 24) L.R. Evans, 'Beam Effects in Hadron Colliders', preprint CERN/SPS/84-8 (DI-MST), to be published in Proc. Summer School on Physics of High-Energy Particle Accelerators, Brookhaven, 1983.
- 25) S. Ichimaru, *Basic Principles of Plasma Physics* (W.A. Benjamin, Inc., Reading, Mass., 1973).
- 26) G.N. Watson, *A Treatise on The Theory of Bessel Functions*, 2nd edition (The University Press, Cambridge, 1962).
- 27) L. Brillouin, *Science and Information Theory* (Academic Press, New York, 1956).
- 28) D. Boussard, S. Chattopadhyay, G. Dôme and T. Linnecar, 'Feasibility Study of Stochastic Cooling of Bunches in the SPS', preprint CERN/SPS/84-4 (ARF), to be published in Proc. CERN Accelerator School: *Course on Antiprotons for Colliding Beam Facilities*, Geneva, 1983.
- 29) A. Hofmann, 'Single Beam Collective Phenomena—Longitudinal', Proc. First Course Int. School on Accelerators, Erice, 1976: *Theoretical Aspects of The Behaviour of Beams in Accelerators and Storage Rings* (CERN 77-13, Geneva, 1977), p. 139.
- 30) B. Zotter and F. Sacherer, 'Transverse Instabilities of Relativistic Particle Beams in Accelerators and Storage Rings', Proc. First Course Int. School on Accelerators, Erice, 1976: *Theoretical Aspects of The Behaviour of Beams in Accelerators and Storage Rings* (CERN 77-13, Geneva, 1977), p. 175.
- 31) C.S. Taylor, 'Stochastic Cooling Hardware', preprint CERN/PS/84-8 AA, to be published in Proc. CERN Accelerator School: *Course on Antiprotons for Colliding Beam Facilities*, Geneva, 1983.
- 32) L. Brillouin, *Wave Propagation in Periodic Structures*, 2nd edition (Dover Publ., New York, 1953).
- 33) N.G. van Kampen, 'On the Theory of Stationary waves in plasmas', *Physica* **21**, 949 (1955).
- 34) J.M. Wang and C. Pellegrini, 'Single Bunch Fast Longitudinal Instability', Proc. of the 1979 Workshop on Beam Current Limitations in Storage Rings, Upton, 1979 (BNL-51236, Upton, NY, 1980), pp. 109-119.
- 35) S. van der Meer, 'A Different Formulation of the Longitudinal and Transverse Beam Response', report CERN/PS/AA/80-4 (1980).
- 36) S. van der Meer, 'Optimum Gain and Phase for Stochastic Cooling Systems', report CERN/PS/AA/83-48 (1983).
- 37) A. Hofmann and B. Zotter, 'Measurement of Beam Stability and Coupling Impedance by RF Excitation', *IEEE Trans. Nucl. Sci.* **NS-24**, No. 3, 1487-1489 (1977).
- 38) J. Borer et al., 'Information from Beam Response to Longitudinal and Transverse Excitation', *IEEE Trans. Nucl. Sci.* **NS-26**, No. 3, 3405-3408 (1979).
- 39) L. Vos and J.Y. Hemery, 'A Procedure for measuring transverse wall impedance and working line from transfer function measurements', Proc. 11th Int. Conf. on High-Energy Accelerators, Geneva, 1980 (Birkhäuser, Basle, 1980), pp. 501-505.
- 40) S. Chattopadhyay, 'Vlasov theory of signal suppression for bunched beams interacting with a stochastic cooling feedback loop', *IEEE Trans. Nucl. Sci.* **NS-30**, No. 4, 2646-2648 (1983).
- 41) M. Abramowitz and I.A. Stegun, *Handbook of Mathematical Functions*, 9th printing (National Bureau of Standards, Washington, DC, 1970).

- 42) A.W. Chao, 'Coherent Instabilities of a Relativistic Bunched Beam', Proc. SLAC Summer School: *Physics of High Energy Particle Accelerators*, Stanford, 1982 (AIP Conf. Proc. No. 105, New York, 1982), pp. 353–523.
- 43) V.V. Parkhomchuk and D.V. Pestrikov, 'Thermal noise in an intense beam in a storage ring', *Sov. Phys. Tech. Phys.* **25**(7), 818–822 (1980).
- 44) A. Piwinski, 'Intra-Beam Scattering', Proc. 9th Int. Conf. on High-Energy Accelerators, Stanford, 1974 (USAEC Conf 740522, Washington, DC, 1974), pp. 405–409.
- 45) A. Sitenko, *Fluctuations and Nonlinear waves in Plasmas* (Pergamon Press, Oxford, 1982).
- 46) H.G. Hereward, 'The Elementary Theory of Landau damping', CERN 65-20 (1965).
- 47) R.L. Stratonovich, *Topics in the Theory of Random Noise* (Gordon and Breach Science Publishers, Inc., New York, 1967, Vols. I and II).
- 48) J. Bjorken and S.K. Mtingwa, 'Intrabeam Scattering', *Part. Acc.* **13**, No. 3–4, 115–143 (1983).
- 49) D. Boussard, 'RF Techniques for $p\bar{p}$ ', to be published in Proc. CERN Accelerator School: *Course on Antiprotons for Colliding Beam Facilities*, Geneva, 1983.
- 50) J. Wang and S. Krinsky, 'Bunch Diffusion Due to RF Noise', *Part. Acc.* **12**, 107–117 (1982).
- 51) J. Tennyson, 'The Dynamics of the Beam-Beam Interaction', Proc. FNAL Summer School: *Physics of High Energy Particle Accelerators*, Batavia, 1981 (AIP Conf. Proc. No. 87, New York, 1981), pp. 345–394.
- 52) L. Evans, 'The Beam-Beam Interaction', to be published in Proc. CERN Accelerator School: *Course on Antiprotons for Colliding Beam Facilities*, Geneva, 1983.
- 53) J. Schoenfeld, 'Beam-Beam Interaction', Proc. FNAL Summer School: *Physics of High Energy Particle Accelerators*, Batavia, 1981 (AIP Conf. Proc. No. 87, New York, 1981), pp. 314–341.
- 54) E. Keil, 'Beam-Beam Interaction in p-p Storage Rings', Proc. First Course Int. School on Accelerators, Erice, 1976: *Theoretical Aspects of The Behaviour of Beams in Accelerators and Storage Rings* (CERN 77-13, Geneva, 1977), p. 314.
- 55) G.I. Budker, Proc. Int. Symp. on Electron and Positron Storage Rings, Saclay 1966 (Presses universitaires de France, Paris, 1966).
- 56) G.I. Budker et al., 'Experimental Studies of Electron Cooling', *Part Acc.* **7**, No. 4, 197–211 (1976).
- 57) J.D. Jackson, *Classical Electrodynamics*, 2nd edition (John Wiley and Sons, New York, 1975).
- 58) N.G. van Kampen, 'Stochastic Differential Equations', *Phys. Reports* **24**, 171–228 (1976).
- 59) S. Chattopadhyay, 'A Formulation of Transversely Coupled Betatron Stochastic Cooling of Coasting Beams', *IEEE Trans. Nucl. Sci.* **NS-30**, No. 4, 2652–2654 (1983).