

SSVEP by checkerboard related to grid size and board size

Arao Funase^{*†}, Kenya Wakita[‡], Akitoshi Itai[§] and Ichi Takumi^{*}

^{*} Nagoya Institute of Technology, Nagoya, JAPAN

E-mail: funase.arao@nitech.ac.jp Tel/Fax: +81-52-735-7179

[†] RIKEN, Wako, JAPAN

[‡] Tokyo Institute of Technology, Tokyo, JAPAN

[§] Chubu University, Kasugai, JAPAN

Abstract—The steady-state visual evoked potential (SSVEP) is used for input signals of brain computer interfaces (BCIs). There are two types of stimulus for SSVEP. One is flashing visual stimuli and the other is flipping checker board patterns.

We have been studying SSVEPs with checker board patterns. There are few studies described relationship between SSVEP and property of flipping checker board patterns. In this study, We pay my attention to the size of the grid squares in the checkerboard and the length on the checker board pattern.

I. INTRODUCTION

Recently, many researchers pay attention to brain computer interfaces (BCIs). BCIs are important tool for heavily hand-capped persons to communicate to another persons. Because, users on BCIs do not need movements of their body. There are some types of BCIs according to EEG signals used by inputs. Our group focus on the BCI by Steady-state visual evoked potentials (SSVEPs). The BCI by SSVEPs has some advantages comparing with another types of BCIs. The advantage is to observe SSVEPs stably, because SSVEPs is generated by visual stimuli. The other advantage is that subjects do not need training to use the BCIs based on SSVEPs.

The SSVEPs is generated by visual stimuli. We can observe the same frequency in the EEG signals as flicking frequency of visual stimuli. There are two methods to generate SSVEPs. One method is to use blinking light and other method is to use flipping checker board pattern. In this study, we focus on the SSVEP in flipping checker board pattern. The SSVEP with checker board pattern has the advantage that checker board pattern can stimulate visual cortex effectively.

In the BCIs based on the SSVEPs, there are some flicking visual stimuli which have each frequency. The each visual stimulus are assigned to each command. To use the BCIs based on the SSVEPs, subjects watch one visual stimulus. EEG signals are generated by the visual stimulus. A computer analyzes the spectrum of the SSVEPs and control a device.

It is important to know the effective visual stimuli in order to develop the BCIs based on the SSVEPs. However, there are few study on relationship between size of grid squares and size of checker board patterns. In this study, we focus on relationship between size of grid squares and size of checker board patterns.

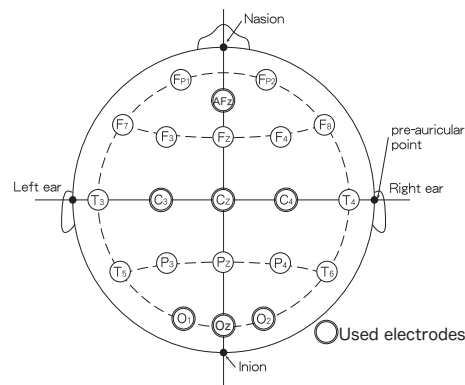

Fig. 1. International 10-20 system method.

II. EXPERIMENTAL SETTINGS

A. Subjects

The number of subjects is 5 (Age: from 21 years old to 22 years old). All subjects are right-handed males and have normal vision.

B. EEG recordings

The recordings is performed in the dark room for reducing environmental visual stimuli. A LCD Display is located on 60 [cm] away from the nation of subjects. Refresh rate of the LCD display (Prolite GB2488HSU, iiyama) is 120 [Hz].

EEG signals is recording with 6 electrodes. These location is on C3, C4, Cz, O1, O2, Oz according to the international 10-20 system method (Fig. 1). A GND electrode is located on upper position of the glabella and a reference electrode is located on AFz position.

All potentials are digitally sampled at 1KHz through the BrainAmp MR Plus (BrainProducts Co.). EEG signals make the signal processing on off-lines. A high-pass filter (cut-off frequency: 0.53Hz), a low-pass filter (cut-off frequency: 120Hz) and a notch filter (notch frequency: 60Hz) is applied to recording the EEG signals.

C. Visual stimuli

In this study, we use flipping checker board pattern to recording the SSVEP. The checker board has black and white

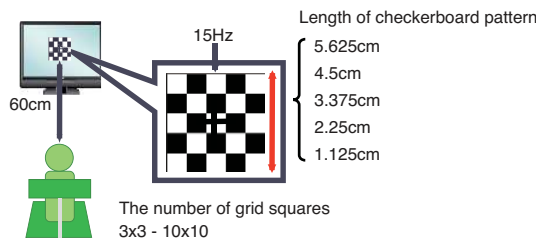

Fig. 2. Experimental settings.

squares like Fig. 2 and we flip black squares to white squares and white squares to black squares. The flickering frequency (F) is 15 [Hz] and flickering time is 90 [sec]. The length of checker board patterns is 5.625, 4.5, 3.375, 2.25 and 1.125 [cm]. The number of grid squares is 3x3, 4x4, 5x5, 6x6, 7x7, 8x8, 9x9 and 10x10. The number of total trials is 40.

D. Analysis

The SSVEPs are generated on the occipital lobe because the visual cortex is located on the occipital lobe. In this study, we analyze EEG signals located on O1, O2, Oz position. The EEG signals (Reference electrode: AFz) is calculated into EEG signals by the bipolar derivation (O1-C3, O2-C4 and Oz-Cz). The recorded EEG signals performs the Fourier Transforms with a hamming window.

There are two shapes of checker board pattern (See. Fig. 3). In the case that the number of grid squares is odd number, the center grid square is divided by fixation point like Fig. 3-Left. In the case that the number of grid squares is even number, the center grid square is not divided by fixation point like Fig. 3-Right. In this paper, we focus on optimal size of grid squares. Therefore, we make two analysis groups. First analysis group (Group Odd) is the group that the number of grid squares is odd number. Second analysis group (Group Even) is the group that the number of grid squares is even number. We analyze EEG signals in the first analysis group and the second analysis group.

We calculate the power spectrum and make normalization (the Power ratio in Eq. (1))

$$\text{Power ratio} = \frac{\text{Power spectrum in each trial}}{\text{Power spectrum in standard trial}} \quad (1)$$

In the case of “Group Odd”, the number of grid squares in the standard trial is the 5x5 and the length of checker board patterns in the standard trial is 4.5cm. In the case of “Group Even”, the number of grid squares in the standard trial is the 4x4 and the length of checker board patterns in the standard trial is 4.5cm.

We calculate mean of the power ratio and standard deviation of the power ratio in O1, O2, Oz.

III. EXPERIMENTAL RESULTS AND DISCUSSION

A. Size of grid squares

Fig. 4 is shown the power ratio in the “Group Odd”. Fig. 4-a - Fig. 4-e is results in the length of 5.625 [cm], 4.5[cm], 3.375

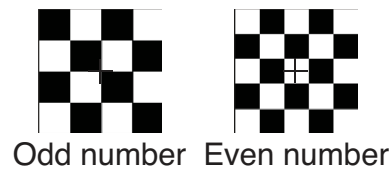

Fig. 3. checker board pattern.

[cm], 2.25 [cm] and 1.125 [cm]. Vertical axis indicates means of the power ratio and standard deviation between 5 subjects. The blue bar indicates data in O1 position and the orange bar indicates data in O2 position and the gray bar indicates data in Oz position. From Fig. 4-a - Fig. 4-e, the smaller size of grid squares is, the larger power ratio is. Therefore, when the length of checker board patterns is fix and the size of grid squares become small and the number of grid squares is large, the power ratio become big.

However, there are limitation of space resolution in human being and there are the limitation of recognition on size of grid squares. When the size of grid squares is too small, we can not recognize grid squares. In this case, the power ratio become smaller.

Fig. 5 is shown the power ratio in the “Group Even”. Fig. 5-a - Fig. 5-e is results in the length of 5.625 [cm], 4.5[cm], 3.375 [cm], 2.25 [cm] and 1.125 [cm]. Vertical axis indicates means of the power ratio and standard deviation between 5 subjects. The blue bar indicates data in O1 position and the orange bar indicates data in O2 position and the gray bar indicates data in Oz position. From Fig. 5-a - Fig. 5-d, the smaller size of grid squares is, the larger power ratio is. In Fig. 5-e, when the number of grid square is 8x8, the power ratio is the biggest.

From these results in 5-e, the size of grid squares in 6x6 is large for human being and the size of grid squares in the 10x10 is small for human being. the size of grid squares in the 8x8 is optimal size for generating power spectrum of SSVEPs. The size of grid squares in the 8x8 is 0.14 [cm]

B. Length of checker board patterns

From section III-A, we estimate the optimal size of grid squares. In this section, we focus on the optimal length of checker board patterns. To obtain the optimal length of checker board patterns, we fix the size of grid squares.

Fig. 6 is results on power ratio in the case that the size of grid squares is 0.56cm. Vertical axis indicates means of the power ratio and standard deviation between 5 subjects. The blue bar indicates data in O1 position and the orange bar indicates data in O2 position and the gray bar indicates data in Oz position.

From Fig. 6, the power ratio in the 8x8 is larger than the power ratio in the 10x10. In the 8x8, the length of checker board pattern is 4.5 cm.

Fig. 7 is results on power ratio in the case that the size of grid squares is 1.13cm. Vertical axis indicates means of the power ratio and standard deviation between 5 subjects.

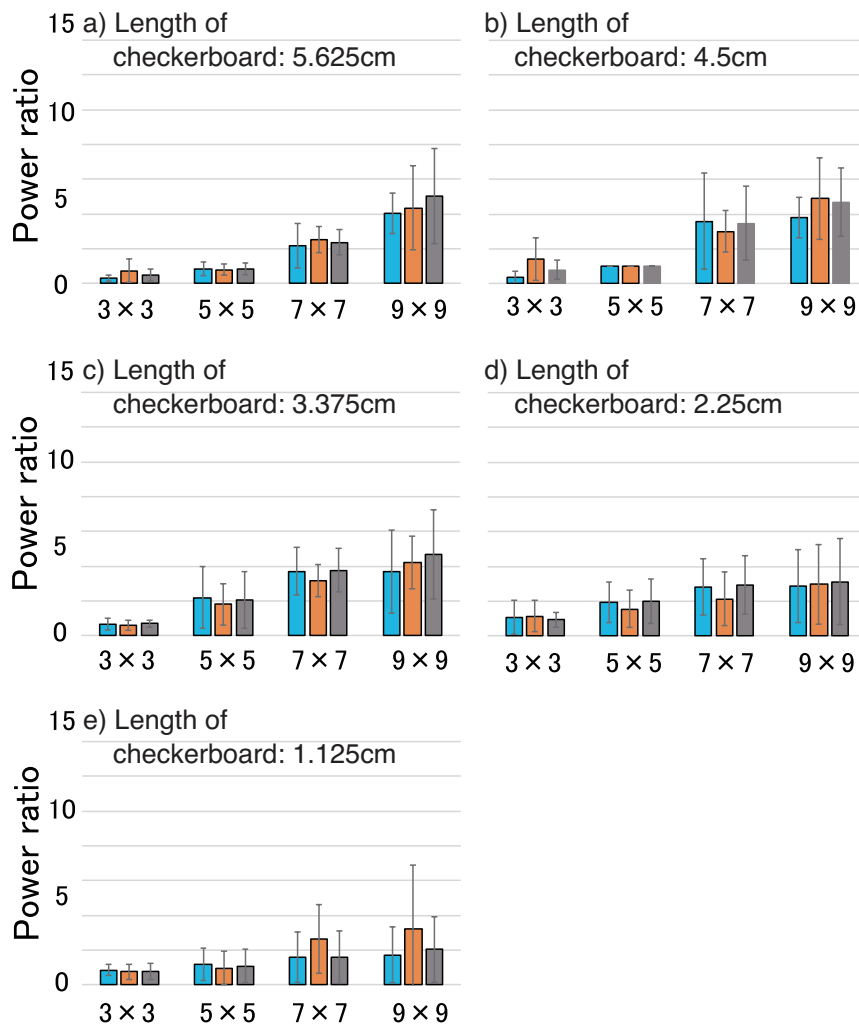

Fig. 4. Relationship between power ratio, each length of Checker board and each size of grid squares in "Group Odd".

The blue bar indicates data in O1 position and the orange bar indicates data in O2 position and the gray bar indicates data in Oz position.

In this case, Fig. 7 includes results on "odd group" and "even group". Therefore, the number of grid squares in the standard trial is the 5x5 and the length of checker board patterns in the standard trial is 4.5cm.

From Fig. 7, the power ratio in the 4x4 is larger than the power ratio in the 5x5. In the 4x4, the length of checker board pattern is 4.5 cm.

As results, when the number of grid squares is large, the power ratio dose not become large always. In the case that distance between the display and subject is 60 cm, the optimal length of checker board pattern is about 4.5 cm.

C. Estimating optimal checker board pattern

From section III-A and III-B, the optimal condition of checker board is that the size of grid squares is 0.14 cm and the length of checker board pattern is 4.5 cm. Therefore, power ratio of SSVEPs become strong in the case that the number

of grid squares is 32x32.

IV. CONCLUSIONS

In this paper, we focus on the SSVEP with checker board pattern. we estimate optimal length of checker board pattern and optimal grid squares. As results, in the case that distance between the display and subject is 60 cm, the optimal condition of checker board is that the size of grid squares is 0.14 cm and the length of checker board pattern is 4.5 cm.

ACKNOWLEDGMENT

This work was supported by JSPS KAKENHI Grant Number 15K21078 (Grant-in-Aid for Young Scientists B).

REFERENCES

- [1] F. Di Russo, A. Wolfgang, W. Teder-Salejalvi and S. A. Hillyard, "Steady-state VEP and attentional visual processing", *The Cognitive Electrophysiology of Maind and Brain*, pp. 259-274, 2002.
- [2] P. Marinez, H. Bakardjian, and A. Cichocki, "Fully Online Multicommand Brain Computer Interface with Visual Neurofeedback Using SSVEP Paradigm", *Comput. Intel. Neurotic.*, Vol. 2007, pp. 1-9, 2007

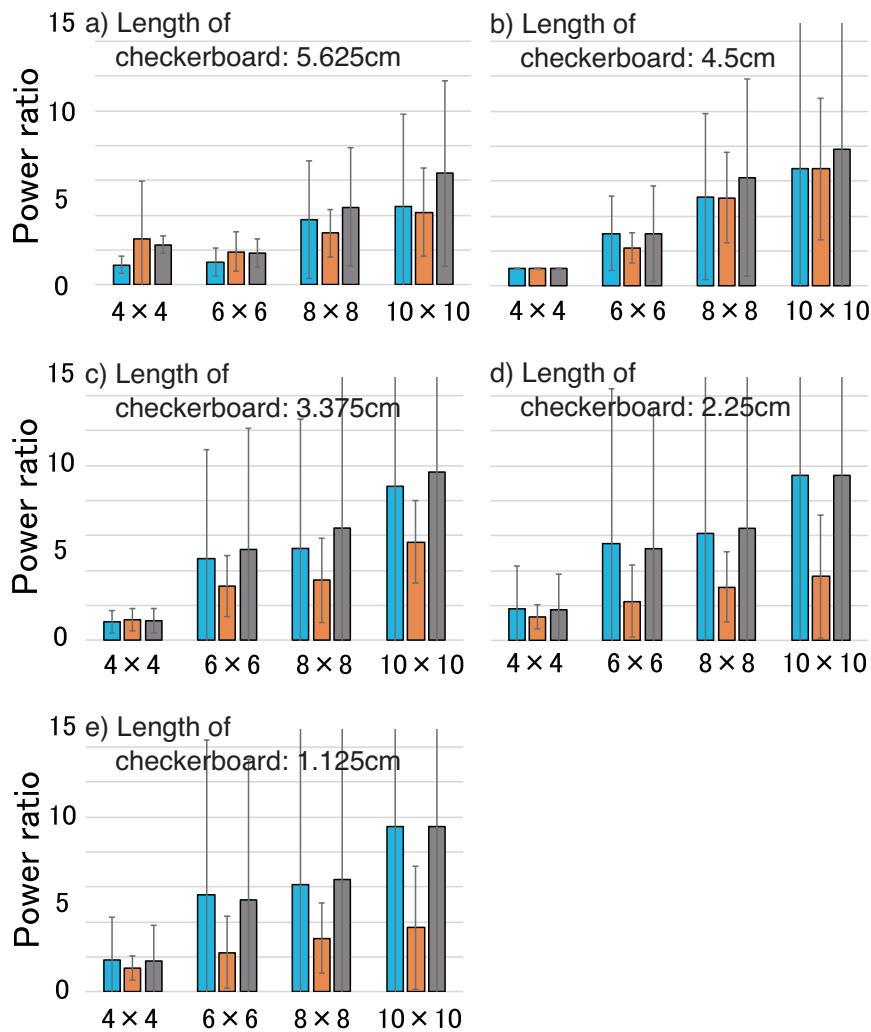

Fig. 5. Relationship between power ratio, each length of Checker board and each size of grid squares in “Group Even”.

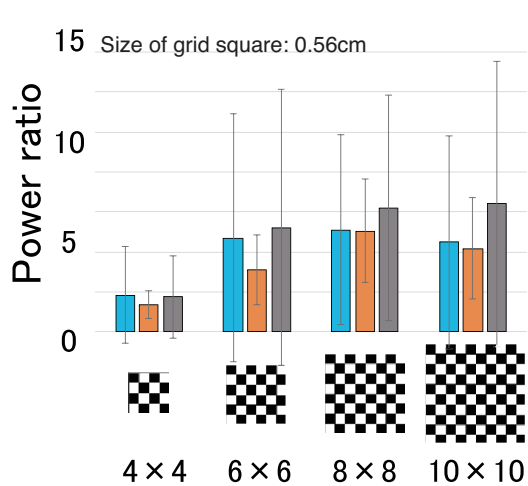

Fig. 6. Relationship between power ratio and length of checker board pattern (Size of grid squares: 0.56cm).

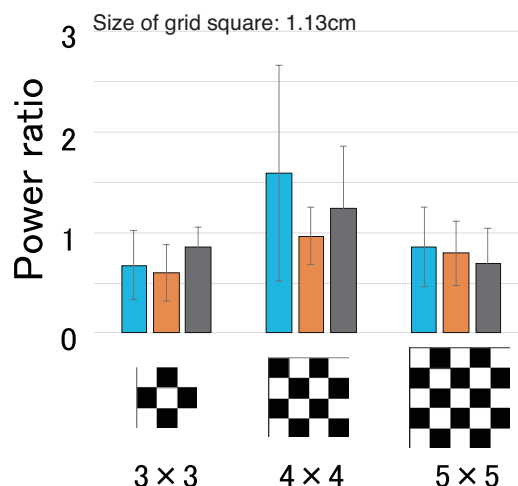

Fig. 7. Relationship between power ratio and length of checker board pattern (Size of grid squares: 1.13cm).