STARS—An Integrated General-Purpose Finite Element Structural, Aeroelastic, and Aeroservoelastic Analysis Computer Program

K.K. Gupta

(NASA-TM-101709-Rev) STARS: AN INTEGRATED
GENERAL-PURPOSE FINITE ELEMENT STRUCTURAL,
AERDELASTIC, AND AEROSERVOELASTIC ANALYSIS
COMPUTER PROGRAM (NASA) 181 p CSDL 20K

N91-21587

Unclass
0008794

63/39

January 1991



National Aeronautics and
Space Administration

2
2

2
2

Errata and addendum to
*STARS - An Integrated General-Purpose
 Finite Element Structural, Aeroelastic, and Aeroservoelastic Analysis
 Computer Program*
 NASA TM 101709 - Revised

The following corrections should be made to the manual:

Page 41 should read

ELEMENT STRESSES										
ELEMENT NO.	END1	END2	END3	END4	PX1/PX2	PY1/PY2	PZ1/PZ2	MX1/MX2	MY1/MY2	MZ1/MZ2
	END5	END6	END7	END8	SXT SXX	SYT SYY	SXYT SZZ	SXB SXY	SYB SYZ	SXYB SZX
1	1	4			0.785577E+03 -0.785577E+03	0.000000E+00 0.000000E+00	0.000000E+00 0.000000E+00	0.000000E+00 0.000000E+00	0.000000E+00 0.000000E+00	0.000000E+00 0.000000E+00
2	2	4			-0.756511E-02 0.756511E-02	0.000000E+00 0.000000E+00	0.000000E+00 0.000000E+00	0.000000E+00 0.000000E+00	0.000000E+00 0.000000E+00	0.000000E+00 0.000000E+00
3	2	5			0.464123E+03 -0.464123E+03	0.000000E+00 0.000000E+00	0.000000E+00 0.000000E+00	0.000000E+00 0.000000E+00	0.000000E+00 0.000000E+00	0.000000E+00 0.000000E+00
4	3	5			0.807432E-01 -0.807432E-01	0.000000E+00 0.000000E+00	0.000000E+00 0.000000E+00	0.000000E+00 0.000000E+00	0.000000E+00 0.000000E+00	0.000000E+00 0.000000E+00
5	3	6			-0.116939E+04 0.116939E+04	0.000000E+00 0.000000E+00	0.000000E+00 0.000000E+00	0.000000E+00 0.000000E+00	0.000000E+00 0.000000E+00	0.000000E+00 0.000000E+00
6	3	4			-0.146366E+03 0.146366E+03	0.000000E+00 0.000000E+00	0.000000E+00 0.000000E+00	0.000000E+00 0.000000E+00	0.000000E+00 0.000000E+00	0.000000E+00 0.000000E+00
7	4	5			-0.627136E-01 0.627136E-01	0.000000E+00 0.000000E+00	0.000000E+00 0.000000E+00	0.000000E+00 0.000000E+00	0.000000E+00 0.000000E+00	0.000000E+00 0.000000E+00
8	5	6			0.177002E-02 -0.177002E-02	0.000000E+00 0.000000E+00	0.000000E+00 0.000000E+00	0.000000E+00 0.000000E+00	0.000000E+00 0.000000E+00	0.000000E+00 0.000000E+00
9	6	4			0.150008E+03 -0.150008E+03	0.000000E+00 0.000000E+00	0.000000E+00 0.000000E+00	0.000000E+00 0.000000E+00	0.000000E+00 0.000000E+00	0.000000E+00 0.000000E+00
10	4	7			0.705240E+03 -0.705240E+03	0.000000E+00 0.000000E+00	0.000000E+00 0.000000E+00	0.000000E+00 0.000000E+00	0.000000E+00 0.000000E+00	0.000000E+00 0.000000E+00
11	5	7			0.452271E-01 -0.452271E-01	0.000000E+00 0.000000E+00	0.000000E+00 0.000000E+00	0.000000E+00 0.000000E+00	0.000000E+00 0.000000E+00	0.000000E+00 0.000000E+00
12	5	8			0.000000E+00 0.000000E+00	0.000000E+00 0.000000E+00	0.000000E+00 0.000000E+00	0.000000E+00 0.000000E+00	0.000000E+00 0.000000E+00	0.000000E+00 0.000000E+00
13	6	8			-0.180786E+00 0.180786E+00	0.000000E+00 0.000000E+00	0.000000E+00 0.000000E+00	0.000000E+00 0.000000E+00	0.000000E+00 0.000000E+00	0.000000E+00 0.000000E+00
14	6	9			-0.927916E+03 0.927916E+03	0.000000E+00 0.000000E+00	0.000000E+00 0.000000E+00	0.000000E+00 0.000000E+00	0.000000E+00 0.000000E+00	0.000000E+00 0.000000E+00
15	6	7			-0.321364E+03 0.321364E+03	0.000000E+00 0.000000E+00	0.000000E+00 0.000000E+00	0.000000E+00 0.000000E+00	0.000000E+00 0.000000E+00	0.000000E+00 0.000000E+00
16	7	8			0.424805E-01 -0.424805E-01	0.000000E+00 0.000000E+00	0.000000E+00 0.000000E+00	0.000000E+00 0.000000E+00	0.000000E+00 0.000000E+00	0.000000E+00 0.000000E+00
17	8	9			0.837402E-01 -0.837402E-01	0.000000E+00 0.000000E+00	0.000000E+00 0.000000E+00	0.000000E+00 0.000000E+00	0.000000E+00 0.000000E+00	0.000000E+00 0.000000E+00

18	9	7	0.000000E+00 0.000000E+00	0.000000E+00 0.000000E+00	0.000000E+00 0.000000E+00	0.000000E+00 0.000000E+00	0.000000E+00 0.000000E+00	0.000000E+00 0.000000E+00
19	7	10	0.463998E+03 -0.463998E+03	0.000000E+00 0.000000E+00	0.000000E+00 0.000000E+00	0.000000E+00 0.000000E+00	0.000000E+00 0.000000E+00	0.000000E+00 0.000000E+00
20	8	10	0.463998E+03 -0.463998E+03	0.000000E+00 0.000000E+00	0.000000E+00 0.000000E+00	0.000000E+00 0.000000E+00	0.000000E+00 0.000000E+00	0.000000E+00 0.000000E+00
21	9	10	-0.927967E+03 0.927967E+03	0.000000E+00 0.000000E+00	0.000000E+00 0.000000E+00	0.000000E+00 0.000000E+00	0.000000E+00 0.000000E+00	0.000000E+00 0.000000E+00

Table 9 on page 58 should read

Mode	Natural frequency parameter $\gamma = \omega \ell \sqrt{\frac{2}{v \rho t/D}}$			
	$\Omega_Z = 0.8 \omega \frac{1}{N}$ = 100.00 rad/sec		$\Omega_R = 100.00$ rad/sec, $\Omega_X = \Omega_Y = \Omega_Z = 57.735$ rad/sec	
	ω	γ	ω	γ
1	233.57	3.9286	146.36	2.4617
2	534.17	8.9845	494.34	8.3146
3	1268.30	21.3323	1248.60	21.0009
4	1562.00	26.2722	1543.26	25.9570
5	1784.80	30.0196	1768.80	29.7505
6	2912.50	48.9871	2898.28	48.7479

Table 12 on page 66 should read

Mode	Buckling load parameter	
	STARS solution	Exact solution
1	7012.33	7010.42

Line 6.1.2 on page 80 should read

6.1.2 ISTMN, NLVN, GR
Format (2I5, E10.4)

The first seven lines of ASE input data on page 136 should read

```
AERO TEST MODEL - ANTISYMMETRIC CASE - NCNTRL = 5
SET UP FOR ASE SOLUTION.
DIRECT SURFACE INTERPOLATION.
EIGHT ELASTIC MODES, PLUS FIVE ADDED RIGID BODY-CONTROL MODES;
REVISED RIGID BODY Y TRANSLATIONS, ROLL, YAW, PLUS ALLERON AND RUDDER MODES.
MACH NO. = 0.90      ALTITUDE: SEA LEVEL
  1  17  3  10  1  0  0  0  0  0  0
```

The k-type flutter input data on page 140-141 should read

```
AERO TEST MODEL - ANTISYMMETRIC CASE - IINIP = 1
K-FLUTTER SOLUTION
DIRECT SURFACE INTERPOLATION
STARS STRUCTURAL MODEL, BYPASS RIGID BODY MODES IN GENMASS
MACH NO. = 0.90      ALTITUDE: SEA LEVEL
////////////////////////////////////
  1  12  3  28  1  0  0  0  0  0
  1  1  0  0  0  0  0  0  0  0
  1  0  0  0  0  0  0  0  0  0
  0  0  0  0  0  0  0  99  0  0
  1
 38.89   0.90
   .350   .745   .940   1.491   1.615   1.698   1.864
  2.000   2.450   2.750   3.150   3.270   3.400   3.850
  4.150   4.551   5.250   7.000   9.000   11.110  15.000
 19.000  24.070  50.000  140.000  315.774  616.746 1200.000
```

Table 17 in chapter 7 on page 141 should read

Table 17. AERO test model: An aeroelastic antisymmetric analysis using a direct interpolation for AERO paneling.

Mode	Instability number	k - SOLN		p-k		ASE	
		Velocity, keas	Frequency, rad/sec	Velocity, keas	Frequency, rad/sec	Velocity, keas	Frequency, rad/sec
Fuselage first bending	F1	506.15	77.49	533.53	77.54	591.16	76.03
Wing first bending	F2	615.75	72.26	620.85	73.02	579.69	80.09
Fin first bending	F3	—	—	856.64	138.92	742.81	128.87

Analysis notes:

- 1) F - Flutter point
- 2) D - Divergence point
- 3) Mach = 0.90
- 4) Altitude = Sea level

Figures 30 through 32 on page 142-144 should be as on the following pages

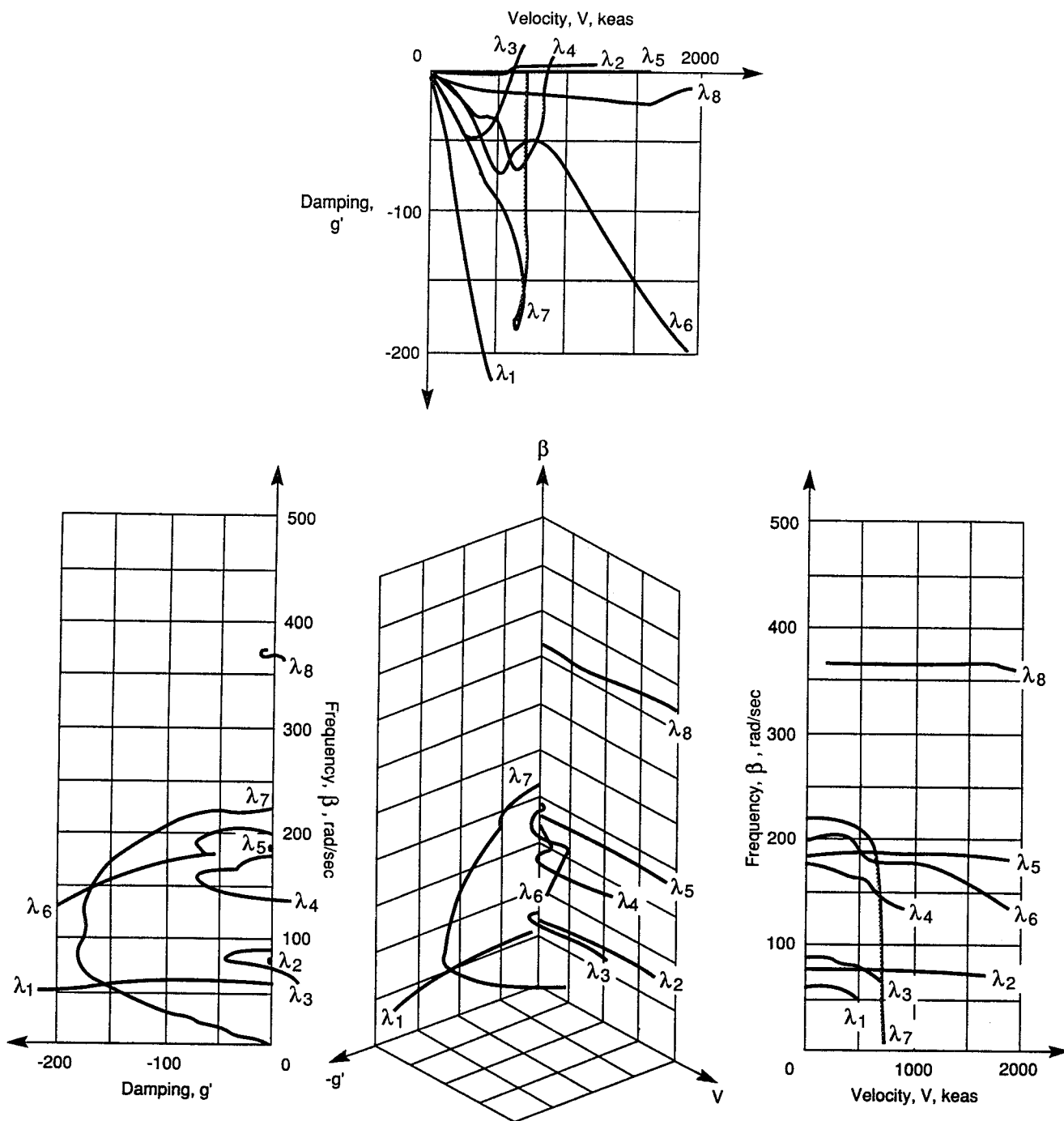

Figure 30. STARS ATM-k flutter analysis—damping (g'), frequency (β), velocity (v) plot, antisymmetric case, using direct interpolation where $g' = g \times 200$.

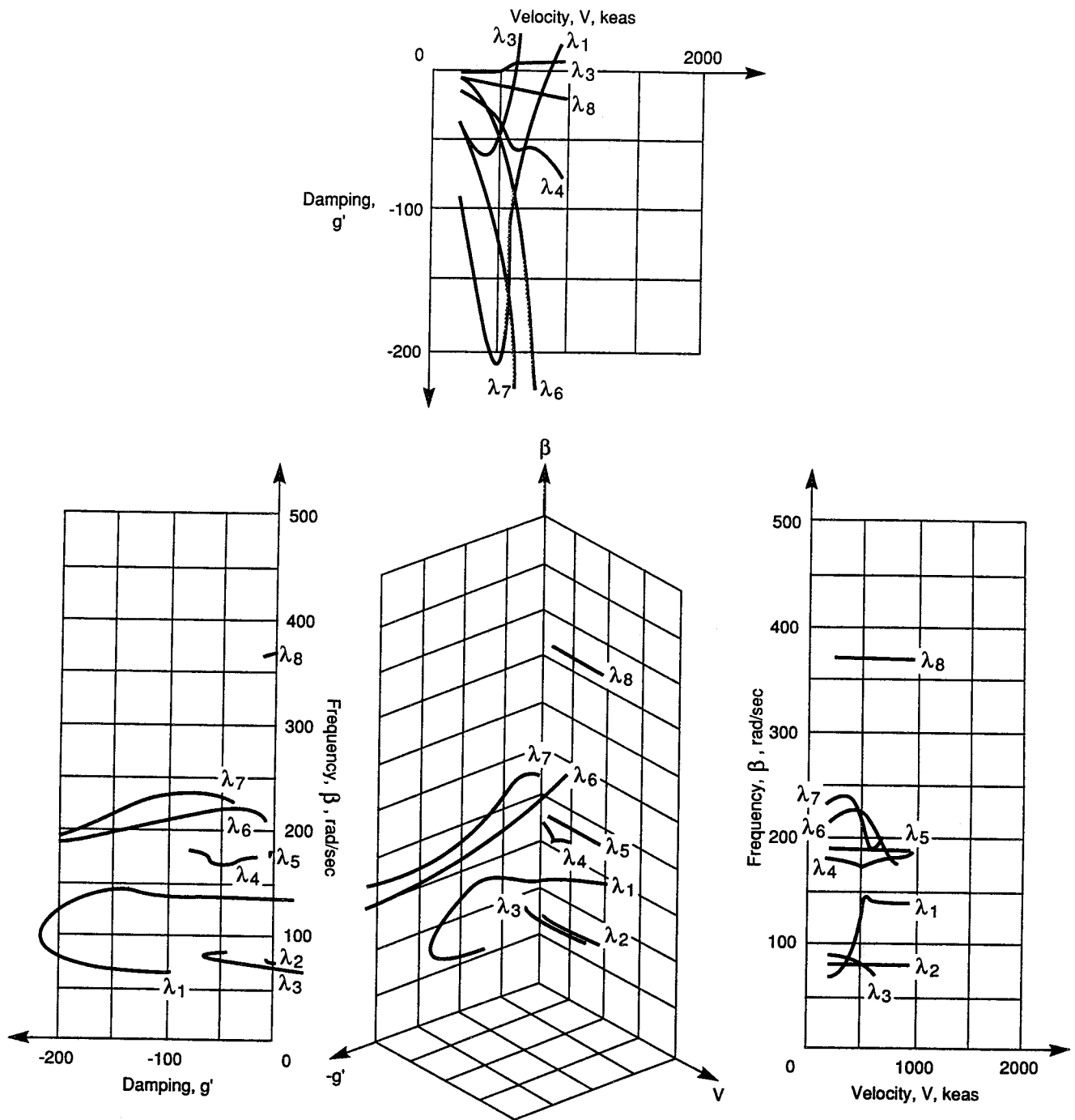

Figure 31. STARS ATM-pk flutter analysis—damping (g'), frequency (β), velocity (v) plot, antisymmetric case, using direct interpolation where $g' = g \times 200$.

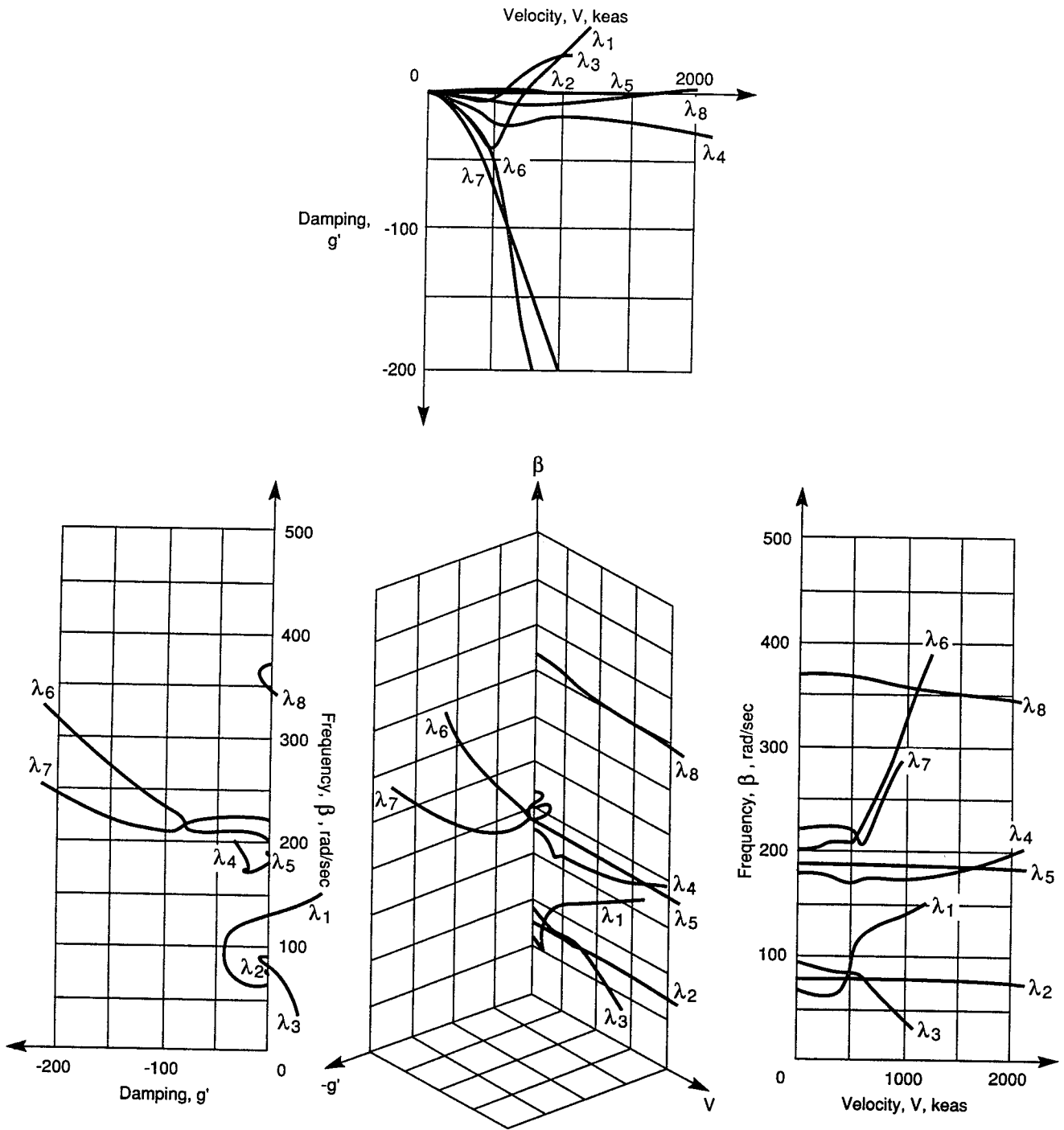

Figure 32. STARS ATM-ASE flutter analysis—damping (a), frequency (β), velocity (v) plot, antisymmetric case, using direct interpolation.

NASA Technical Memorandum 101709
Revised

STARS—An Integrated General-Purpose Finite Element Structural, Aeroelastic, and Aeroservoelastic Analysis Computer Program

K.K. Gupta
NASA Ames Research Center, Dryden Flight Research Facility, Edwards, California

1991



National Aeronautics and
Space Administration

Ames Research Center

Dryden Flight Research Facility
Edwards, California 93523-0273

CONTENTS

SUMMARY	1
1. INTRODUCTION	2
2. STARS-SOLIDS PROGRAM DESCRIPTION	6
2.1 Nodal and Element Data Generation	7
2.2 Matrix Bandwidth Minimization	7
2.3 Deflection Boundary Conditions	8
2.4 Prescribed Loads	8
2.5 Static Analysis	9
2.6 Elastic Buckling Analysis	9
2.7 Free Vibration Analysis	9
2.8 Dynamic Response Analysis	11
2.9 Shift Synthesis	12
2.10 Formulation for Nodal Centrifugal Forces in Finite Elements	13
2.11 Material Properties	13
2.12 Output of Analysis Results	14
2.13 Discussion	14
3. DATA INPUT PROCEDURE (STARS-SOLIDS)	15
3.1 Basic Data	15
3.2 Nodal Data	21
3.3 Element Data	23
3.4 Data in Global or Local-Global Coordinate System	33
3.5 Additional Basic Data	36
4. SAMPLE PROBLEMS (STARS-SOLIDS)	39
4.1 Space Truss: Static Analysis	39
4.2 Space Frame: Static Analysis	42
4.3 Plane Stress: Static Analysis	44
4.4 Plate Bending: Vibration Analysis	49
4.5 General Shell: Vibration Analysis	51
4.6 General Solid: Vibration Analysis	53
4.7 Spinning Cantilever Beam: Vibration Analysis	55
4.8 Spinning Cantilever Plate: Vibration Analysis	57
4.9 Helicopter Structure: Vibration Analysis	59
4.10 Rocket Structure: Dynamic Response Analysis	61
4.11 Plate, Beam, and Truss Structures: Buckling Analysis	64
4.12 Composite Plate Bending: Vibration Analysis	67
5. STARS-AERO AND ASE PROGRAM DESCRIPTION	70
5.1 Numerical Formulation for Aeroelastic and Aeroservoelastic Analysis	71
6. DATA INPUT PROCEDURE (STARS-AERO AND ASE)	79
6.1 GENMASS Data (STARS-AERO-GENMASS)	80
6.2 GRIDCHG Data (STARS-AERO-GRIDCHG)	81
6.3 AERO Data (STARS-AERO)	87
6.4 CONVERT Data (STARS-ASE-CONVERT)	107
6.5 ASE PADÉ Data (STARS-ASE-PADÉ)	108
6.6 ASE FRESP Data (STARS-ASE-FRESP)	112

7.	SAMPLE PROBLEMS (STARS Integrated Aero-Structural-Control Systems Analysis)	118
7.1	ATM: Free vibration analysis (STARS-SOLIDS)	118
7.2	ATM: Generalized mass analysis (STARS-AERO-GENMASS)	135
7.3	ATM: Aeroelastic analysis (STARS-AERO)	136
7.4	ATM: Aeroelastic analysis (STARS-ASE-CONVERT)	145
7.5	ATM: Aeroservoelastic analysis (STARS-ASE-PADÉ)	146
7.6	ATM: Aeroservoelastic analysis (STARS-ASE-FRESP)	148
	APPENDIX A—PREPROCESSOR MANUAL	155
	APPENDIX B—POSTPROCESSOR MANUAL	159
	APPENDIX C—SYSTEMS DESCRIPTION	162
	APPENDIX D—NONLINEAR MULTIDISCIPLINARY SIMULATION	164
	REFERENCES	165

FIGURES

Figure 1.	Structural synthesis.	3
Figure 2.	Major modules of STARS.	3
Figure 3.	STARS-SOLIDS overview.	4
Figure 4.	STARS-ASE flowchart.	5
Figure 5.	Bandwidth minimization scheme.	8
Figure 6.	STARS-SOLIDS element types.	
	(a) Line element.	26
	(b) Quadrilateral shell element.	26
	(c) Triangular shell element.	26
	(d) Hexahedral solid element.	26
	(e) Tetrahedral solid element.	26
Figure 7.	Space truss.	39
Figure 8.	Space frame structure.	42
Figure 9.	Deep beam example.	44
Figure 10.	Original and deformed shape of deep beam.	48
Figure 11.	Square cantilever plate.	49
Figure 12.	Finite element model of cylindrical shell.	51
Figure 13.	Cube discretized by hexahedral elements.	53
Figure 14.	Spinning cantilever beam.	55
Figure 15.	Coupled helicopter rotor-fuselage system.	
	(a) Discrete element model.	59
	(b) Structural mass distribution.	59
	(c) Structural stiffness distribution.	59
Figure 16.	Rocket subjected to dynamic loading.	
	(a) Rocket structure.	61
	(b) Pulse loading.	61
Figure 17.	Nodal displacement as a function of time, node 1.	63
Figure 18.	Element force as a function of time, element 4.	63
Figure 19.	Truss structure.	66
Figure 20.	Square composite plate.	67
Figure 21.	Feedback control system.	71
Figure 22.	ASE analysis data input scheme.	79
Figure 23.	ATM symmetric half finite element model with nodes.	130
Figure 24.	ATM antisymmetric case, direct-surface interpolation scheme.	131
Figure 25.	ATM antisymmetric case, elastic (Φ_E) mode shapes.	133
Figure 26.	ATM antisymmetric case, perfect rigid body (Φ_{PR}) and control (Φ_C) modes.	
	(a) Rigid body mode, X-Y plane motion.	134
	(b) Control mode, flap motion.	134
	(c) Rigid body mode, Z-rotation motion.	134
	(d) Control mode, rudder motion.	134
	(e) Rigid body mode, X-rotation motion.	134
Figure 27.	ATM antisymmetric case, half aircraft aerodynamic boxes.	139
Figure 28.	ATM antisymmetric case, aerodynamic panels.	139
Figure 29.	ATM antisymmetric case.	
	(a) Aerodynamic boxes.	140
	(b) Slender body definitions.	140

Figure 30.	STARS ATM-k flutter analysis — damping (g'), frequency (β), velocity (v) plot, antisymmetric case, using direct interpolation where $g' = g \times 200$.	142
Figure 31.	STARS ATM-pk flutter analysis — damping (g'), frequency (β), velocity (v) plot, antisymmetric case, using direct interpolation where $g' = g \times 200$.	143
Figure 32.	STARS ATM-ASE flutter analysis — damping (α), frequency (β), velocity (v) plot, antisymmetric case, using direct interpolation.	144
Figure 33.	ATM lateral mode analog control system.	151
Figure 34.	Lateral loop gains, roll mode.	
	(a) Gain.	152
	(b) Phase.	152
Figure 35.	Lateral loop gains, yaw mode.	
	(a) Gain.	153
	(b) Phase.	153
Figure 36.	Closed-loop equivalent velocity vs. damping and frequencies.	154
Figure 37.	STARS systems description.	163
Figure 38.	Nonlinear multidisciplinary simulation (modular environment).	164

TABLES

Table 1.	Arrangement of nodal data input.	21
Table 2.	Element data layout.	23
Table 3.	Element temperature data input.	31
Table 4.	Data layout for displacement boundary conditions.	34
Table 5.	Natural frequencies of a square cantilever plate.	50
Table 6.	Natural frequencies of a cylindrical cantilever shell.	53
Table 7.	Natural frequencies of a solid cube.	54
Table 8.	Spinning cantilever beam.	57
Table 9.	Natural frequency parameters of a spinning square cantilever plate.	58
Table 10.	Natural frequencies of a helicopter structure.	61
Table 11.	Critical load of a simply supported square plate.	65
Table 12.	Critical load of a cantilever beam.	66
Table 13.	Critical load of a simple truss.	67
Table 14.	Natural frequencies of a composite square cantilever plate.	69
Table 15.	AERO test model: Antisymmetric free vibration analysis results.	132
Table 16.	Rigid body and control mode generation parameters.	132
Table 17.	AERO test model: An aeroelastic antisymmetric analysis using a direct interpolation for AERO paneling.	141
Table 18.	ATM phase and gain margins.	151

SUMMARY

A unified and highly graphics-oriented analysis capability that includes structures, aerodynamics, and control disciplines has been achieved by integrating two new modules in the original STARS (S*TR*uctural Analysis Routine*S*) finite element computer program system (ref. 1). Thus, in addition to performing static, buckling, vibration, and dynamic response analyses of undamped and damped structures, including those having rotating and prestressed components, the program is also capable of performing aeroelastic (flutter and divergence) and aeroservoelastic stability analyses that may include digital or analog controller elements.

The element library in the STARS-SOLIDS module consists of one-dimensional (1-D) line elements; two-dimensional (2-D) triangular and quadrilateral shell elements; and three-dimensional (3-D) tetrahedral and hexahedral solid elements. Improved composite as well as sandwich shell elements are recent additions to this element library. These elements enable the solution of structural problems that include truss, beam, space frame, plane, plate, shell, and solid structures, or any combination thereof. Associated algebraic equations are solved by exploiting inherent matrix sparsity. Zero, finite, and interdependent deflection boundary conditions can be implemented by the program. The associated dynamic response analysis capability provides for initial deformation and velocity inputs, whereas the transient excitation may be either forces or accelerations. An effective in-core or out-of-core solution strategy is automatically employed by the program, depending on the size of the problem. Data input may be at random within a data set, and the program offers certain automatic data generation features. Input data are formatted as an optimal combination of free and fixed formats.

The STARS-AERO module enables computation of unsteady aerodynamic forces pertaining to subsonic and supersonic flow employing the doublet lattice and the constant pressure procedures, respectively. Subsequent flutter and divergence analyses are performed by utilizing the standard k and p - k methods.

Associated aeroservoelastic (ASE) analysis is performed by the STARS-ASE module that employs a Padé and least squares formulation for curve fitting the unsteady aerodynamic forces, followed by a state-space formulation that incorporates the elastic structural and aerodynamic effects. Such state-space matrices are further augmented by analog and/or digital controller elements. A hybrid formulation is adopted in the case of a digital controller. Frequency response characteristics may be calculated to yield frequency, damping, gain, and phase results for both open- and closed-loop systems.

The program, developed in modular form for easy modification, is written in standard FORTRAN to run on a variety of computers such as IBM 6000, DEC VAX 3600, Cray Y-MP, and Cray 2, among others. Extensive graphics capability exists for convenient model development as well as for postprocessing of analysis results, employing any PLOT-10 compatible terminal such as Tektronix, CIT, DEC-VT, and also the E/S PS 390 machines.

1. INTRODUCTION

The general-purpose digital computer program, STARS (*S*tructural Analysis Routine*S*), has been designed as an efficient tool for analyzing practical structures, as well as for supporting relevant research and development activities; it has also proved to be an effective teaching aid. All such activities are mutually enhancing and interrelated (fig. 1). The current version of the program, capable of solving linear elastic aero-structural-control problems (fig. 2), will be continuously updated to include other forms of analysis.

In an effort to optimize the program layout, the subroutines in the various modules have been grouped into several links. Interaction between the user and the program is effected through a display terminal with or without graphics capabilities; however, a graphics terminal is useful in the accurate preparation of data input and in visualizing structural geometry and analysis results. Thus with reference to figure 3, which pertains to the typical STARS-SOLIDS module, link 1 relates to the input phase of the program. The user may input the data directly, utilizing some limited, automated, data-generation capabilities inherent in the program; alternatively, the STARS preprocessor program, PREPROC, may be utilized effectively for complete data generation of a structure. Once the data have been entered into the system, the user may create an image of the model on the terminal display screen.

Subsequent correction or modification of the model may be easily implemented on an interactive basis. Once the model format is verified, the user may proceed to run link 2 of the program, which involves major numerical manipulation of input data relative to static, stability, and free vibration analysis of the structural model. Nodal displacements caused by static loading and the structural mode shapes pertaining to the stability and free vibration problems may then be displayed using the graphics terminal. Link 3 of the program, the response link, enables computation of structural displacements caused by dynamic loading, as well as element stresses resulting from static and dynamic loads input. The STARS postprocessor program, POSTPLOT, is used for extensive plotting of results generated by the two links.

The program can solve static and dynamic problems of nonrotating and rotating structures of general configurations with arbitrary displacement boundary conditions. For static problems, a multiple set of input data is permissible; for dynamic response problems, a single set of force or acceleration data is the usual input. The structural material may be isotropic, orthotropic, or anisotropic. Both viscous and structural damping occurring in practice may be included in the dynamic analysis. A bandwidth minimization option is available, its utilization being highly desirable to ensure economical solution of associated problems.

The free vibration and dynamic response analyses of structural systems rotating along an arbitrary axis are useful features of the STARS program. Such a structure may have a combination of nonrotating and rotating parts, and each part may have a different spin rate. Both rigid body and elastic modes may be computed by the program, and the dynamic response analysis is formulated accordingly. Relevant algebraic computations are performed in single or double precision, using either real or complex arithmetic operations.

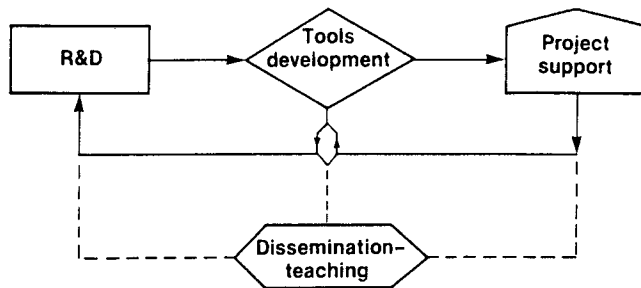

10130

Figure 1. Structural synthesis.

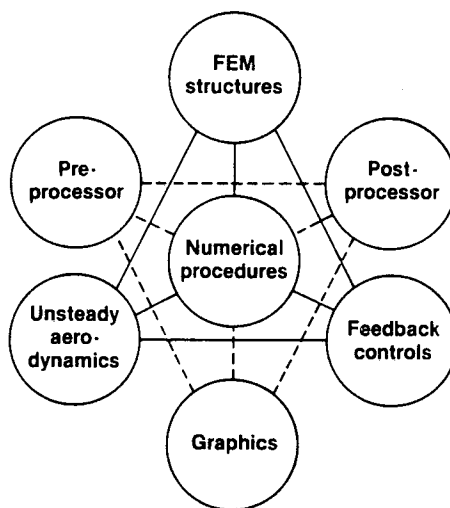

Finite element modeling
 Spinning structures
 Mechanical and thermal loading
 General and composite materials

Preprocessor – automatic FEM
 model data generation
 Postprocessor – graphical
 depiction of analysis results

Statics, buckling
 Vibration, dynamic responses

Aeroelasticity
 Flutter and divergence

Aeroservoelasticity
 Frequency responses, digital
 and analog controllers
 Damping and frequencies

Hydrodynamics

10131

Figure 2. Major modules of STARS.

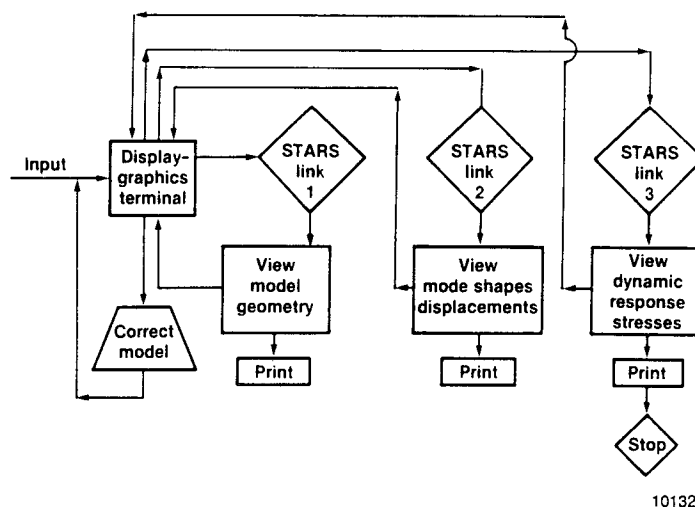

Figure 3. STARS-SOLIDS overview.

A schematic of the associated aeroelastic and aeroservoelastic (ASE) analyses is depicted in figure 4. Thus, once the frequencies and mode shapes of the structure are derived from finite element analysis employing the STARS-SOLIDS module, the STARS-AERO module is next utilized to compute the unsteady aerodynamic forces on the structure. An alternative option enables input of measured modal data in lieu of calculated data. A flutter solution is then achieved using the k and p-k methods. The user has to input details of the aerodynamic paneling to achieve the aeroelastic analysis.

Subsequent ASE analysis of the structure may be achieved by first employing the STARS-ASE-PADÉ submodule. The user provides essential data to perform a polynomial curve fitting of unsteady aerodynamic forces resulting in the state-space matrices. For an alternative open-loop flutter analysis, such data consist of information on polynomial tension coefficients, previously calculated generalized masses, and damping and modal characteristics as well as a set of velocity values. Additional data, in lieu of velocity values, relating to coordinate transformations from earth-to body-centered coordinate systems and also sensor locations, are needed for the subsequent ASE analysis for frequency response calculations and also for determination of damping and frequency values. This is achieved by the STARS-ASE-FRESP submodule when the primary data input relates to analog and/or digital controller blocks connectivity, associated transfer function polynomial descriptions, as well as gain inputs, specifications for system outputs and inputs, and also connection details between the plant and the blocks.

Section 2 provides a concise description of the STARS-SOLIDS module of the program, as well as highlights of some of its important features, and section 3 depicts the data input procedure. Section 4 provides summaries of input data and analysis results for a number of sample test cases relevant to the module. Chapter 5 describes the various features of the newly created aeroelastic (AERO) and ASE analyses capabilities, whereas chapter 6 provides data input details of various related submodules. Finally, a representative, integrated aero-structural-control sample problem is worked out in detail in chapter 7.

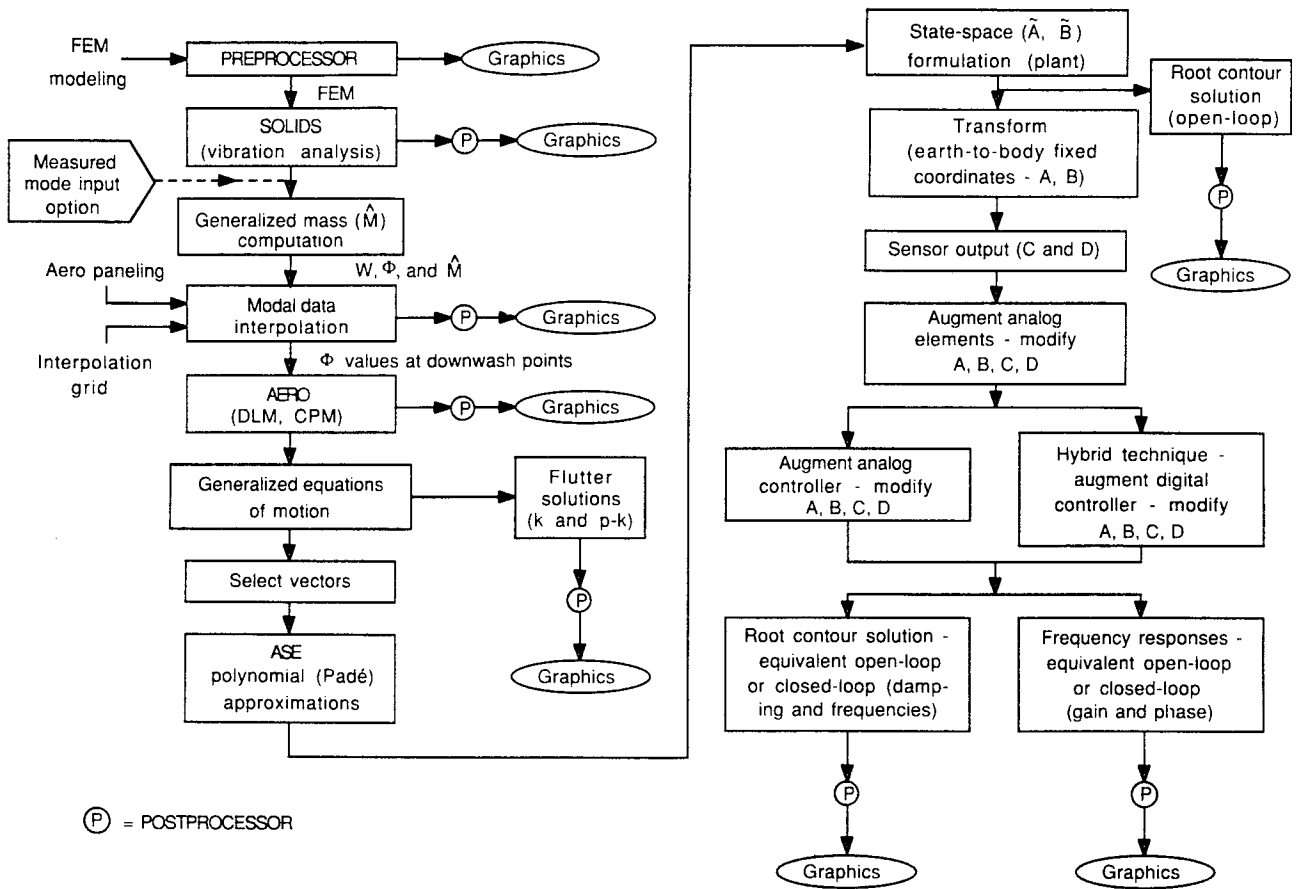

Figure 4. STARS-ASE flowchart.

10133

2. STARS-SOLIDS PROGRAM DESCRIPTION

The structure to be analyzed by STARS may be composed of any suitable combination of one-, two-, and three-dimensional (1-, 2-, and 3-D) elements. The general features of the STARS-SOLIDS module include the following:

1. A general-purpose, compact, finite element program.
2. Elements: bars, rods, beams, 3-D line elements, triangular and quadrilateral plane, plate, shells, as well as sandwich panels and composite elements, tetrahedral and hexahedral solids.
3. Geometry: any relevant structure formed by a suitable combination of the elements in (2).
4. Material: general, isotropic, orthotropic, and anisotropic material.
5. Analysis: natural frequencies and mode shapes of usual and rotating structures with or without structural damping, viscous damping, or both, including initial load (prestress) effect; stability (buckling) analysis; dynamic-response analysis of usual and rotating structures; and static analysis for multiple sets of mechanical and thermal loading.

Special features of the STARS program include the following:

1. Random data input within a subset.
2. Matrix bandwidth minimization.
3. Automatic node and element generation.
4. General nodal deflection boundary conditions.
5. Multiple sets of static load input.
6. Preprocessor and postprocessor.
7. Plot of initial geometry.
8. Plots of mode shapes, nodal deformations, and element stresses as a function of time, as required.

Structural geometry is described in terms of the global and/or the local-global coordinate system (GCS/LGCS) having a right-handed Cartesian set of X-, Y-, and Z-coordinate axes. Each structural node is assumed to have six degrees of freedom (DOF) consisting of three translations, UX, UY, UZ, and three rotations, UXR, UYR, UZR, which are the undetermined quantities in the associated solution process. Details of some important features of the program are summarized below.

2.1 Nodal and Element Data Generation

The STARS program provides simple linear interpolation schemes that enable automatic generation of nodal and element data. Generation of nodal data is dependent on the occurrence of such features as nodes lying on straight lines and common nodal displacement boundary conditions, whereas generation of element data is possible if the finite element mesh is repetitive in nature with elements possessing common basic elemental properties. The program enables input of data employing a number of rectangular local-global coordinate systems (LGCS) relevant to various substructures.

A separate preprocessor, PREPROC, has been developed for automated generation of nodal, element, and other associated input data for any continuum. The preprocessor is an interactive graphics structures modeling program. It is capable of generating complex structures through duplication, mirror imaging, and cross-sectioning of modular representative structures.

2.2 Matrix Bandwidth Minimization

This feature enables effective bandwidth minimization of the stiffness, inertia, and all other relevant system matrices by reordering input nodal numbers, taking into consideration first-order, as well as second-order, nodal connectivity conditions. With reference to figure 5, the existing nodal numbering may be modified (ref. 2) to minimize bandwidth of associated matrices. Therefore, any node with minimum first-order connectivity may be chosen as the starting node. Accordingly, any one of nodes 1, 4, 7, 10, 13, and 16, all of which have a minimum first-order nodal connectivity of two, may be selected as the first node to start the nodal numbering scheme. However, nodes 1, 4, 10, and 13 possess a higher second-order connectivity condition than do nodes 7 and 16. For example, nodes connected to node 1 (namely nodes 2 and 18) are, in turn, connected to a total of seven nodes, whereas such a connectivity number for either node 7 or 16 happens to be only six. As such, either node 7 or 16 may be chosen as the starting node for the renumbering scheme. A revised nodal numbering that minimizes matrix bandwidth is shown in parentheses in figure 5. The present minimization scheme also takes into consideration the presence of nodal interdependent displacement boundary conditions.

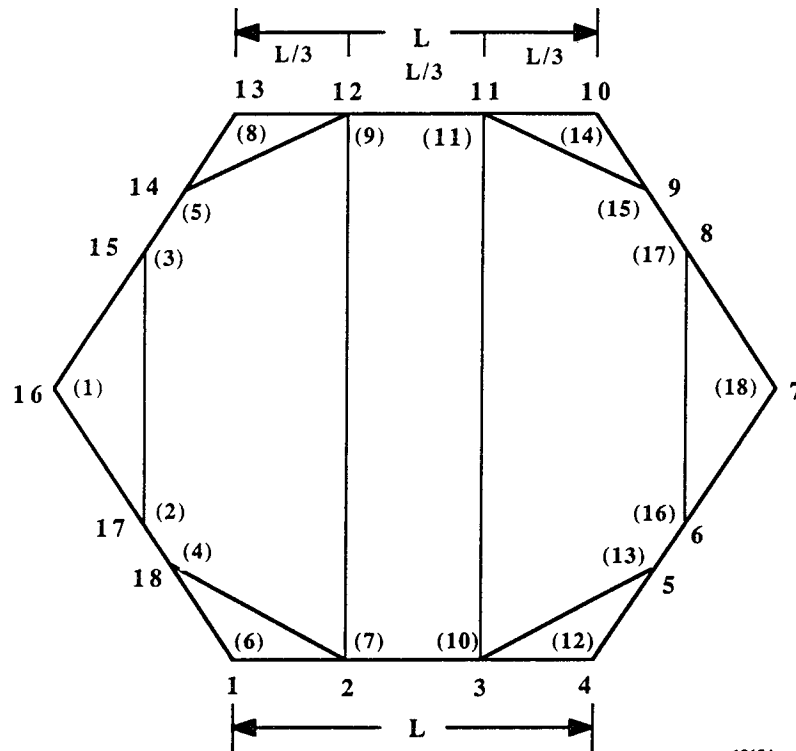

10134

Figure 5. Bandwidth minimization scheme.

2.3 Deflection Boundary Conditions

The nodal displacement relationships may be classified as zero, finite, and interdependent deflection boundary conditions (ZDBC, FDBC, and IDBC). Details of such a formulation are provided in section 3.4. Thus, in addition to prescribed zero and finite displacements, the motion of any node in a particular degree of freedom can be related in any desired manner to the motion of the same or any other combination of nodes in any set of specified directions.

2.4 Prescribed Loads

A structure may be subjected to any suitable combination of mechanical and thermal loadings. The loads in the mechanical category may be either concentrated at nodes or distributed. Thus, uniform pressure may be applied along the length of line elements acting in the direction of the local y- and z-axes. Such uniform surface loads are assumed to act in the direction of the local z-axis of the shell and solid elements, acting respectively on the shell and solid base surfaces.

The effect of thermal loading can be incorporated by the appropriate input of data pertaining to uniform element temperature increases, as well as thermal gradients.

2.5 Static Analysis

Static analysis, performed by setting the parameter $I\text{PROB} = 8$ in the input data, is effected by solving the set of linear simultaneous equations

$$\mathbf{KU} = \mathbf{P} \quad (1)$$

where

- \mathbf{K} = system elastic stiffness matrix
- \mathbf{U} = nodal displacement vector
- \mathbf{P} = external nodal load vector
- $I\text{PROB}$ = integer designating problem type (defined in section 3.1)

A multiple set of load vectors is represented by the matrix \mathbf{P} incorporating effects of both mechanical and thermal loading. The equations are solved once, initially by Gaussian elimination, and solutions pertaining to multiple nodal load cases are obtained by simple back substitution.

2.6 Elastic Buckling Analysis

A buckling analysis is performed by solving the eigenvalue problem

$$(\mathbf{K}_E + \gamma \mathbf{K}_G)\mathbf{U} = \mathbf{0} \quad (2)$$

in which \mathbf{K}_E and \mathbf{K}_G are elastic stiffness and geometric stiffness matrices, respectively; \mathbf{U} represents the buckled mode shapes and γ is the buckling load. This is achieved by setting $I\text{PROB} = 9$.

2.7 Free Vibration Analysis

The matrix equation of free vibration for the general case of a spinning structure with viscous and structural damping is expressed (ref. 3) as

$$[\mathbf{K}_E(1 + i^*g) + \mathbf{K}_G + \mathbf{K}']\mathbf{U} + (\mathbf{C}_C + \mathbf{C}_D)\dot{\mathbf{U}} + \mathbf{M}\ddot{\mathbf{U}} = \mathbf{0} \quad (3)$$

in which a dot indicates differentiation with respect to time; the previously undefined terms are described as follows:

- \mathbf{K}' = centrifugal force matrix
- \mathbf{C}_C = Coriolis matrix
- \mathbf{C}_D = viscous damping matrix

- M** = inertia matrix
g = structural damping parameter
i* = imaginary number, $\sqrt{-1}$

Such a structure may have individual nonrotating and also rotating components spinning with different spin rates along arbitrary axes.

Various reduced sets of equations pertaining to specific cases of free vibration are given as follows:

1. Free, undamped vibration of nonrotating structures (IPROB = 1):

$$\mathbf{K}_E \mathbf{U} + \mathbf{M} \ddot{\mathbf{U}} = \mathbf{0} \quad (4)$$

2. Free, undamped vibration of spinning structures (IPROB = 2):

$$\mathbf{K} \mathbf{U} + \mathbf{C}_C \dot{\mathbf{U}} + \mathbf{M} \ddot{\mathbf{U}} = \mathbf{0} \quad (5)$$

with $\mathbf{K} = \mathbf{K}_E + \mathbf{K}_G + \mathbf{K}'$.

3. Free, damped vibration of spinning structures (IPROB = 4, 5), defined by equation (3).
4. Free, damped vibration of nonspinning structures (IPROB = 6, 7):

$$\mathbf{K}_E(1 + i^* g) \mathbf{U} + \mathbf{C}_D \dot{\mathbf{U}} + \mathbf{M} \ddot{\mathbf{U}} = \mathbf{0} \quad (6)$$

The eigenvalue problem pertaining to the IPROB = 1 and 9 cases is real in nature, but the rest of the above problems involve complex-conjugate roots and vectors. In the special case of a prestressed structure, the matrix \mathbf{K}_G is automatically included in equation (6).

In addition, STARS solves the quadratic matrix eigenvalue problem (IPROB = 3) associated with a dynamic element formulation (ref. 4),

$$[\mathbf{K}_E - \lambda^2 \mathbf{M} - \lambda^4 (\mathbf{M}_2 - \mathbf{K}_4)] \mathbf{U} = \mathbf{0} \quad (7)$$

which is quadratic in terms of the eigenvalues $\chi = \lambda^2$ and where both \mathbf{M}_2 and \mathbf{K}_4 are the higher order dynamic correction matrices, λ being the natural frequencies. This option is currently being updated to include a number of elements.

Prestressed structures caused by initial loads may also be analyzed, in which case the relevant eigenvalue problem for undamped structures has the form

$$(\mathbf{K}_E + \mathbf{K}_G - \lambda^2 \mathbf{M}) \mathbf{U} = \mathbf{0} \quad (8)$$

in which the geometrical stiffness matrix K_G is a function of initial stresses; similar formulations are obtained for structures with various forms of damping.

2.8 Dynamic Response Analysis

The modal superposition method is employed for the dynamic response analysis following the computation of structural frequencies and modes. As an example, for a nonrotating, undamped structure, the associated eigenvalue problem of equation (4) is first solved to obtain the first few eigenvectors Φ and also the eigenvalues. The vectors may consist of a set of rigid body modes Φ_r and a number of elastic modes Φ_e which are next mass-orthonormalized so that the matrix product

$$\Phi^T M \Phi = [I] \quad (9)$$

is a unit matrix. A transformation relationship

$$U = \Phi \eta \quad (10)$$

is substituted in the dynamic equation

$$M \ddot{U} + K U = P(t) \quad (11)$$

and when premultiplied by Φ^T , yields a set of uncoupled equations

$$\ddot{\eta}_r = \Phi_r^T P(t) \quad (12)$$

and

$$\ddot{\eta}_e + \Omega^2 \eta_e = \Phi_e^T P(t) \quad (13)$$

incorporating rigid body and elastic mode effects, respectively; $P(t)$ is the externally applied, time-dependent forcing function, and Ω^2 is a diagonal matrix, with terms ω_i , ω_i being the natural frequencies. Solutions of equations (12) and (13) can be expressed in terms of Duhamel's integrals, which, in turn, may be evaluated by standard procedures (ref. 5). In the present analysis, the externally applied, time-dependent forcing function must be applied to the structure in appropriate small, incremental steps of rectangular pulses. The forcing function may be either load or acceleration vectors; the program also allows application of initial displacement and velocity vectors to the structure. For spinning, as well as for damped, structures identified as IPROB = 2, 4, 5, 6, and 7, Φ^T are replaced by their transjugate $\bar{\Phi}^T$ in the relevant dynamic response formulation.

2.9 Shift Synthesis

The program provides special eigenvalue switching provisions in the analysis to ensure numerical stability. Such a problem may be encountered in the analysis of aerospace structures, which are designed to be strong and lightweight. For example, the elements of the mass matrix of equation (4) may have numerical values much smaller than those of the stiffness matrix. In such cases, the effect of the mass matrix in the $(\mathbf{K} - \lambda^2\mathbf{M})\mathbf{y} = \mathbf{0}$ formulation may be insignificant. Such a problem also occurs in the presence of rigid body modes characterized by "zero" frequencies. An eigenvalue shift strategy has been developed to accommodate such situations.

Thus, the eigenvalue problem pertaining to equation (4) representing the problem defined as IPROB = 1 may be written as

$$(\mathbf{K} - \lambda^2\mathbf{M})\mathbf{y} = \mathbf{0} \quad (14)$$

in which λ is the natural frequency of free vibration, and \mathbf{y} is the eigenvector. The stiffness and mass matrices must be suitably perturbed to handle rigid body modes and to maintain numerical stability by negating effects of rounding error. Thus, equation (14) is rearranged as

$$[\mathbf{K} + 4\widehat{\mathbf{M}} - (\widetilde{\lambda} + 4)\widehat{\mathbf{M}}]\mathbf{y} = \mathbf{0} \quad (15)$$

or

$$(\widehat{\mathbf{K}} - \widehat{\lambda}\widehat{\mathbf{M}})\mathbf{y} = \mathbf{0} \quad (16)$$

in which

$$\widehat{\mathbf{K}} = \mathbf{K} + 4\widehat{\mathbf{M}} \quad (17)$$

$$\widehat{\mathbf{M}} = \mathbf{F}\mathbf{M} \quad (18)$$

$$\widetilde{\lambda} = \frac{\lambda^2}{\mathbf{F}} \quad (19)$$

$$\widehat{\lambda} = \frac{\lambda^2}{\mathbf{F}} + 4 \quad (20)$$

$$\mathbf{F} = \frac{\max\left(\left|\frac{\mathbf{K}_{i,i}}{\mathbf{M}_{i,i}}\right|\right)}{10^7} \quad (21)$$

where $|\mathbf{K}_{i,i}|$ and $|\mathbf{M}_{i,i}|$ typically denote the norms of the diagonal elements and the number 10^7 relates to the computational accuracy of the VAX 11 computer. Once the eigenvalue problem defined by equation (16) is solved, the natural frequencies are simply obtained as

$$\lambda = \sqrt{(\widehat{\lambda} - 4)\mathbf{F}} \quad (22)$$

A similar procedure is adopted for the analysis of free vibration problems defined by IPROB = 6 and 7, as well as for the buckling analysis (IPROB = 9).

In the case of spinning structures, a somewhat similar strategy is used in perturbing appropriate matrices to ensure effective computation of rigid body modes, as well as numerical stability.

2.10 Formulation for Nodal Centrifugal Forces in Finite Elements

The STARS program can perform dynamic analyses of structures with nonrotating and rotating parts having different spin rates. A general derivation for the in-plane centrifugal forces generated in various elements due to the arbitrary spin rate, along with related formulation of the associated normal components, is given in detail in reference 6. Reference 7 provides details of a block Lanczos algorithm developed for efficient, free vibration analysis of spinning structures.

Once the nodal centrifugal forces have been derived, as previously mentioned, and stored in array **P**, the element stresses in the structure caused by these forces are simply obtained by solving equation (1) (repeated here for convenience),

$$\mathbf{KU} = \mathbf{P}$$

The stresses are next utilized to derive the structural geometrical stiffness matrix \mathbf{K}_G required for solving the free vibration problems defined in section 2.7.

2.11 Material Properties

The structural material may be general in nature. Thus, the finite element material properties may be isotropic, orthotropic, or anisotropic. In the most general case of solid elements having anisotropic material properties, defined as material type 3, the stress-strain matrix is expressed as

$$\delta = \mathbf{E}\epsilon \quad (23)$$

with $E_{i,j}$ being elements of the general material matrix of order 6 by 6, defining the relationship between the stress vector δ and the strain vector ϵ . The elements of the upper symmetric half of the **E** matrix, as well as coefficients of thermal expansion and material density consisting of 28 coefficients, are the required data input for the pertinent material type. In this connection, it may be noted that the material data input is designed in such a way as to be quite general; the user may easily incorporate effects of various related features, such as varying material axes orientation, by appropriately calculating the elements of the material matrix. If the material is orthotropic, the input scheme remains the same for the anisotropic case.

Material type 2 pertains to thin shell elements displaying anisotropic or orthotropic material properties; it requires an input of 13 coefficients. For isotropic material classified as material type 1, only four coefficients constitute the required input data.

The isotropic case for sandwich shell elements is designated as material type 4, whereas type 5 pertains to the corresponding orthotropic-anisotropic case.

2.12 Output of Analysis Results

A dynamic response analysis, in general, yields an output of nodal deformations and element stresses as appropriate functions of time. Additional printouts provide summaries of maximum deformations and stresses/loads, as appropriate, as well as principal stresses and relevant angles. For line elements, member endloads and moments constitute the usual output of results. In the case of thin shell elements, the stresses σ_{xx} , σ_{yy} and σ_{xy} are calculated at the centroid of the element and at both its top and bottom surfaces. For solid elements, all six components of stresses (σ_{xx} , σ_{yy} , σ_{zz} , σ_{xy} , σ_{yz} , σ_{zx}) are computed at the center of the volume of the element. Since free vibration analysis constitutes a vital preliminary for the dynamic response analysis, the natural frequencies and associated modes are computed by the program and printed out, as desired. Similar results are obtained for elastic buckling analysis. For static problems, the nodal displacements and element stresses are computed for multiple-load cases.

Special printout options make possible a selective output of analysis results. Thus, such computed data as stiffness and inertia matrices may be printed out, as desired. Initially, the program automatically prints out the generated nodal coordinates, element data, and other relevant input data. The POSTPROCESSOR program may be effectively used for color graphics depiction of solution results.

2.13 Discussion

Additional analysis features such as finite, dynamic element discretizations, improved dynamic analysis capabilities, and various efficient numerical techniques are continuously being implemented in the program. A nonlinear analysis capability is also being developed in parallel. Improved preprocessing and postprocessing of data, using E/S PS 390, DEC-VT, CIT, Tektronix, or other graphics terminals, are being used to permit efficient modeling and analysis, as well as display, of the results pertaining to practical structural problems.

An automatic data conversion program has also been developed to convert NASTRAN (ref. 8) program data into STARS format.

3. DATA INPUT PROCEDURE

(STARS-SOLIDS)

3.1 Basic Data

3.1.1 PRIMARY JOB TITLE
Format (FREE)

3.1.1.1 ADDITIONAL JOB DETAILS
Format (A1, FREE)

1. Description: Various job-related descriptions, any number of input lines.

2. Notes:

First line input is required, and subsequent lines of input must have a C in the first column; up to 80 characters per line are accepted.

3.1.2 NN, NEL, NMAT, NMECN, NEP, NET, NLGCS, NMANGL, NSTACK, MAXLEL
Format (FREE)

1. Description: Basic data parameters (structural).

2. Notes:

NN = total number of nodes

NEL = total number of elements

NMAT = total number of element material types

NMECN = number of material elastic constants, a maximum of numbers, as follows:
= 4, for isotropic material
= 13, for orthotropic-anisotropic material for 2-D elements (shell, types 2, 3, 6, and 7)
= 10, for isotropic sandwich panel material (shell, types 2 and 3)
= 25, for orthotropic-anisotropic sandwich panel material (shell, types 2 and 3)
= 28, for orthotropic-anisotropic material for 3-D elements (solid, types 4 and 5)

NEP = total number of line element property types (element type 1)

NET = total number of shell element thickness types (element types 2 and 3)

NLGCS = total number of local-global coordinate systems (LGCS)

NMANGL = total number of material angle types

NSTACK = total number of composite shell element stack types

MAXLEL = maximum number of layers in a composite shell element

3.1.3 NTMP, NPR, NSPIN, NC, NBUN, NLSEC, NCNTRL, NOUT, NEXP
Format (FREE)

1. Description: Basic data parameters (loads and displacements).

2. Notes:

NTMP = total number of element temperature types

NPR = total number of element uniform pressure types

NSPIN = total number of different element spin types

NC = number of sets of nodal loads for IPROB = 8
= 0, for IPROB = 1 through 7
= 1, for IPROB = 9

NBUN = total number of interdependent and finite nodal displacement connectivity conditions (includes IDBC and FDBC in section 2.3, being equal to number of lines of input)

NLSEC = total number of line element special end conditions excluding commonly occurring cases of purely rigid or hinged ends

NCNTRL = total number of control surface rigid body modes used for ASE analyses; may also be utilized for generating perfect rigid body modes

NOUT = total number of output nodes where direct modal interpolation is effected; to be set to 0 for alternative interpolation scheme effected by GRIDCHG program

NEXP = total number of uniform external in-plane pressures for membranes

3.1.4 IPROB, IEIG, IDRS, IBAN, IPLUMP, IMLUMP, INMM, IINTP
Format (FREE)

1. Description: Data defining nature of required solution.

2. Notes:

IPROB = index for problem type, to be set as follows:
= 1, undamped, free vibration analysis of nonspinning structures
= 2, undamped, free vibration analysis of spinning structures
= 3, quadratic matrix eigenproblem option for DEM (dynamic element method) analysis

- = 4, free vibration analysis of spinning structures with diagonal viscous damping matrix
 - = 5, as for IPROB = 4 with structural damping
 - = 6, free vibration analysis of nonspinning structures with general viscous damping
 - = 7, as for IPROB = 6 with structural damping
 - = 8, static analysis of structures with thermal and multiple mechanical load cases
 - = 9, elastic buckling analysis
- IEIG** = integer defining eigenproblem solution type
- = 0, for solution based on a modified, combined Sturm sequence and inverse iteration method
 - = 1, for an alternative solution technique based on a block Lanczos procedure (recommended for computation of first few roots and vectors when the lower bound PL = 0 for cases IPROB = 1, 2, 3, and 9)
- IDRS** = index for dynamic response analysis
- = 0, no response analysis required
 - = 1, performs response analysis
- IBAN** = bandwidth minimization option
- = 0, performs minimization
 - = 1, minimization not required
 - = -1, option to perform minimization only and exit
- IPLUMP** = index for nodal external loads
- = 0, no load input
 - = 1, concentrated nodal load input for IPROB = 8 and 9, as well as for IPROB = 1 through 7 for prestressed structures
- IMLUMP** = index for nodal lumped scalar mass
- = 0, no lumped mass
 - = 1, lumped nodal mass input (IPROB = 1 through 7)
- INMM** = index for nodal 6 by 6 mass matrix
- = 0, no mass matrix
 - = 1, nodal mass matrix input (IPROB = 1 through 7)
- IINTP** = integer defining modal data for direct interpolation
- = 0, no interpolation required
 - = 1, performs interpolation on STARS calculated modal data
 - = 2, performs interpolation on externally supplied modal data; for example, GVS results

3. Notes:

A dynamic response analysis is achieved by specifying appropriate values for IPROB and IDRS; at end of problem solution, extensive options are available for plotting nodal defor-

mations, mode shapes, and element stresses by utilizing the postprocessor program POSTPLOT.

Initial static load (prestressing) effect: in the case of dynamic problems, the presence of nonzero values of integers IPLUMP, NPR, and/or NTMP activates computation of prestressing effect.

3.1.5 IPREC, IPLOT, IPRINT, INDATA, IERCHK
Format (FREE)

1. Description: Additional basic data.

2. Notes:

- IPREC = specification for solution precision
= 1, single precision
= 2, double precision
- IPLOT = index for graphics display
= 0, no plotting needed
= 1, performs display of input geometry; if satisfactory, a restart option enables continuation of current analysis
- IPRINT = output print option
= 0, prints final results output only
= 1, prints global stiffness (**K**), mass (**M**), damping or Coriolis (**C**) matrices, as well as detailed output on deformations, stresses, and root convergence characteristics
= 2, prints output as in IPRINT = 1, but omits **K**, **M**, and **C** matrices
= 3, output as in IPRINT = 0, but omits eigenvector printouts
- INDATA = input data option
= 0, basic matrices are automatically computed
= 1, to read upper symmetric banded half of basic matrices **K**, **M**, and **C** from user input files, row-wise
- IERCHK = integer defining level of input data-error checks required by user
= 0, usual level of error checkouts
= 1, additional extensive data checkouts

Mass matrix: nodal lumped mass matrix is added to consistent mass matrix to evolve the final mass matrix.

3.1.6 INDEX, NR, INORM, PU, PL, TOL (Required if IPROB \neq 8)
Format (FREE)

1. Description: Data specifications for eigenproblem solution.

2. Notes:

- INDEX = indicator for number of eigenvalues and vectors to be computed
= 1, computes NR smallest roots (and vectors) lying within bounds PU, PL
= 2, computes all roots (and vectors) lying within bounds PU, PL
- NR = number of roots to be computed (any arbitrary root number input for INDEX = 2)
- INORM = index for vector normalization; any desired vector row number
= 0, normalizes with respect to a scalar of displacement vector **Y** having largest modulus
= -1, normalizes with respect to a scalar of **Y** or **YD** (velocity) vector having largest modulus
- PU = upper bound of roots
- PL = lower bound of roots
- TOL = tolerance factor (eq. (21))
= 0, defaults to 25.0E + 08
= X, defaults to X (X = 1.0E + 07 may be useful for computation)

3.1.7 IUV, IDDI, NTTTS, NDELTT (Required if IDRS = 1)
Format (FREE)

1. Description: Data related to dynamic response analysis.

2. Notes:

- IUV = index for initial displacement (U) and velocity (V) input
= 0, no initial data
= 1, either initial displacement or velocity or both are nonzero vectors
- IDDI = index for dynamic data input
= 1, nodal load input
= 2, nodal acceleration input
- NTTTS = total number of sets of load or acceleration data input
- NDELTT = number of sets of uniform time increments for response calculation

3.1.8 G (Required if IPROB = 5 or 7)
Format (FREE)

1. Description: Structural damping in formulation [$\mathbf{K} = \mathbf{K}(1 + i*\mathbf{G})$].

2. Notes:

G = structural damping parameter

i* = imaginary number, $\sqrt{-1}$

K = system stiffness matrix

3.1.9 **M11** (Required if INDATA = 1)
Format (FREE)

1. Description: Half-bandwidth of **K**, **M**, or **C**.

3.1.10 ((**B**(I,J), I = 1, N), J = 1, NC) (Required if INDATA = 1 and IPROB = 8)
Format (6E10.4)

1. Description: Load matrix of order N = NN*6.

3.1.11 ((**K**(I,J), I = 1, M11), J = 1, N) (Required if INDATA = 1
and IPROB = 1 through 8)
Format (6E10.4)

1. Description: Stiffness matrix.

3.1.12 ((**M**(I,J), J = 1, M11), I = 1, N) (Required if INDATA = 1
and IPROB = 1 through 7)
Format (6E10.4)

1. Description: Mass matrix.

3.1.13 ((**C**(I,J), J = 1, M11), I = 1, N) (Required if INDATA = 1
and IPROB = 2 through 5)
Format (6E10.4)

1. Description: Coriolis (IPROB = 2, 4, 5) or dynamic correction (IPROB = 3) matrix.

3.1.14 ((**CD**(I,J), J = 1, M11), I = 1, N) (Required if INDATA = 1
and IPROB = 4 through 7)
Format (6E10.4)

1. Description: Viscous damping matrix.

2. General note:

Each set of data input in succeeding sections is preceded with a relevant comment statement having a dollar sign (\$) at the first column, followed by optional descriptive words.

3. Note:

If INDATA = 1, no further input is required.

3.2 Nodal Data

3.2.1 \$ NODAL DATA

3.2.2 IN, X, Y, Z, UX, UY, UZ, UXR, UYR, UZR, ILGCS, IZDRCS, IINC Format (I5,3E10.4,9I5)

1. Description: NN sets of nodal data input in GCS/LGCS, at random; table 1 provides a description of the input data.

Table 1. Arrangement of nodal data input.

Node number (IN)	Nodal coordinates			Nodal zero displacement boundary conditions (ZDBC)						Local-global coordinate system type (ILGCS)	ZDBC reference coordinate system (IZDRCS)	Increment (IINC)
	(X)	(Y)	(Z)	(UX)	(UY)	(UZ)	(UXR)	(UYR)	(UZR)			
*	*	*	*	1	2	3	4	5	6	*	*	*

2. Notes:

- a. A right-handed Cartesian coordinate system (X, Y, Z) is to be chosen to define the global coordinate system (GCS).
- b. The asterisk (*) indicates required data input in GCS/LGCS.
- c. Each structural node is assumed to have six degrees of freedom (DOF) consisting of three translations, UX, UY, UZ, and three rotations, UXR, UYR, UZR, usually labeled as displacement degrees of freedom 1, 2, 3, and 4, 5, 6, respectively.
- d. For nodal zero displacement boundary conditions (ZDBC) defined in coordinate system referred to as IZDRCS, set value to
= 0, for free motion,
= 1, for constrained motion.
- e. For node generation by increment, set IINC
= 0, for no increment,
= I, to increment node number of previous input by I until current node number is attained; coordinates of intermediate nodes are linearly interpolated.
- f. In automatic node generation (note (e)), all relevant data of generated intermediate nodes pertain to that of the last data set of the sequence.
- g. Third-point nodes for line elements are assumed to lie on element local x-y plane and may be chosen as any existing active node or dummy nodes with UX through UZR set to 1.
- h. Final data are automatically formed in increasing sequence of node numbers.

3. Notes:

ILGCS = integer specifying local-global coordinate system number (set to 0 if data is in GCS), defining nodal data

IZDRCS = integer defining zero displacement boundary condition reference coordinate system (set to 0 for data in GCS or an ILGCS number)

3.2.3 \$ LOCAL-GLOBAL COORDINATE SYSTEM DATA (Required if NLGCS ≠ 0)

3.2.4 ILGCS, IDMOD
Format (2I5)

3.2.5 XOR, YOR, ZOR, X2, Y2, Z2, (IDMOD = 1)
X3, Y3, Z3
or
XOR, YOR, ZOR, D11, D12, D13, (IDMOD = 2)
D21, D22, D23, D31, D32, D33
Format (2(6E10.4,/))

1. Description: NLGCS sets of local-global coordinate system (LGCS) definition data, at random.

2. Notes:

IDMOD = integer specifying nature of input data
= 1, input involves global coordinates of the origin of the LGCS (XOR, YOR, ZOR) and two data points (X2 through Z3, pertaining to two points located on LGCS X-axis and X-Y plane, respectively) in GCS
= 2, involves input of origin of LGCS (XOR, YOR, ZOR) and elements of direction cosine matrix of the LGCS

3. Special note:

If IINTP = 2, no further data input is required until 3.5.7.

3.3. Element Data

General note: Element data input may be at random within each data group.

3.3.1 \$ ELEMENT CONNECTIVITY

3.3.2 IET, IEN, ND1, ND2, ND3, ND4, ND5, ND6, ND7, ND8, IMPP, IEPP/ITHTH, ITMPP, IPRR, IST, INC
Format (16I5)

1. Description: NEL sets of element data input; definition of input data is given in table 2.

Table 2. Element data layout.

Element type (IET)	Element number (IEN)	Node number for vertices								IMPP	IEPP/ITHTH	ITMPP	IPRR	IST	INC
		1 (ND1)	2 (ND2)	3 (ND3)	4 (ND4)	5 (ND5)	6 (ND6)	7 (ND7)	8 (ND8)						
Line (bars, rods, beams, 3-D lines) 1	*	*	*	**	IEC1	IEC2	▽			*	X	*	*	*	*
Shell quadrilateral (plane, plate, shear, shell - usual and sandwich) 2	*	*	*	*	*				△	*	†	*	*	*	*
Shell triangular (plane, plate, shear, shell - usual and sandwich) 3	*	*	*	*					△	*	†	*	*	*	*
Solid hexahedron 4	*	*	*	*	*	*	*	*	*	*		*	*	*	*
Solid tetrahedron 5	*	*	*	*	*					*		*	*	*	*
Shell quadrilateral composite element (plane, plate shear, and shell) 6	*	*	*	*	*				□	*		*	*	*	*
Shell triangular composite element (plane, plate shear, and shell) 7	*	*	*	*					□	*		*	*	*	*
Rigid element (pin-ended bar, rigid body) 8	*	*	*	**	IEC1	IEC2	◇								*
Prestressed rectangular membrane 11	*	*	*	*	*				⊕	*	†	*	*	*	*

2. Notes:

- * = data as defined; under element type 8, individual rigid elements are characterized by appropriate data entry
- ** = third point node for element types 1 and 8
- IECI = integer defining line element end condition pertaining to end I
 - = 0, rigid-ended
 - = 1, pin-ended in three rotational degrees of freedom
 - = J, denoting special end condition number, to be set greater than 1; for scalar springs, set IEC1 to a negative value less than -1
- IMPP = integer defining material property type number
- IEPP(x) = integer defining line element property type
- ITHTH(†) = integer defining shell element thickness type
- ITMPP = integer defining element temperature type
- IPRR = integer defining element pressure type
- IST = integer defining element spin type
- INC = integer for element generation by increment
 - = 0, no increment
 - = J, increments' node numbers of previous elements by J until current element nodal numbers are reached
- ▽ = ILGCS, integer defining LGCS associated with a zero-length scalar spring element; defaults to GCS
- △ = IMANG, integer defining material angle type number, suitable for layered elements
- = ISTACK, stack type number, used for integrated composite elements (types 6 and 7)
- ◇ = dependent degree of freedom at ND1 to be rigidly connected to all six degrees of freedom at ND2; rules concerning interdependence of nodes and degrees of freedom are defined in section 3.4.4
 - = -1, if all six degrees of freedom at ND1 are involved
 - = 0, for pin-ended rigid bar elements
- ⊕ = integer defining prestress type

Rigid elements may be specified to span any length, including 0.

Rigid pin-ended bar elements may be simulated by setting $IEC1 = IEC2 = 1$.

In automatic element generation (see INC, above), the generated intermediate elements acquire properties the same as the last element in current sequence. Also, a special option enables repetitive use of an element with an input format (I3, I2, 15I5); the integer IET is then replaced by NELNO and IET, where NELNO is the total number of similar elements connecting the specified nodes.

Sandwich shell elements may be generated by individual inputs of membrane, bending, and transverse shear effects. Furthermore, the composite shell elements consisting of layered composites can be formed for varying stacks of materials.

For element type 8, defined by two nodes, if the first node has some ZDBC constraints, the latter should also be applied to the second node.

3. Element description:

The various elements (fig. 6) and associated degrees of freedom are depicted as follows. The global coordinate system (GCS) is represented by X, Y, Z, whereas x, y, z relates to local coordinate system (LCS).

4. Notes:

- a. A right-handed Cartesian coordinate system (x, y, z) is to be chosen to define any element local coordinate system (LCS).
- b. Any node may be chosen as the first vertex of an element, the local x-axis being along the line connecting vertices 1 and 2.
- c. For line elements, the local x-y plane is defined as the plane contained by vertices 1, 2, and the specified third-point node.
- d. The vertices of thin shell elements are usually numbered in a counterclockwise sequence when observed from any point along the local positive z-axis, being also utilized as plane and plate-bending elements, as appropriate.
- e. For solid elements, the y-axis lies in the plane formed by vertices 1-2-3 and 1-2-3-4 for the tetrahedral and hexahedral elements, respectively; the z-axis is perpendicular to the x-y-plane, heading toward the fourth node for the tetrahedron and the plane containing the other four nodes for the hexahedral element.
- f. The vertices of the solid elements are also numbered in a counterclockwise sequence when viewed from any point on the positive z-axis lying above the plane under consideration; the fifth vertex of the hexahedron is to be chosen as the node directly above vertex 1.
- g. For layered composite shell element types 6 and 7, the layering sequence starts with the layer that has maximum -z coordinate expressed in element LCS.

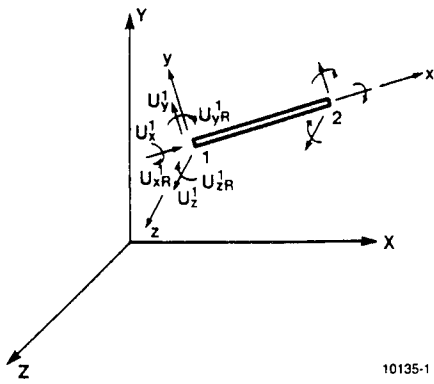

10135-1

(a) Line element.

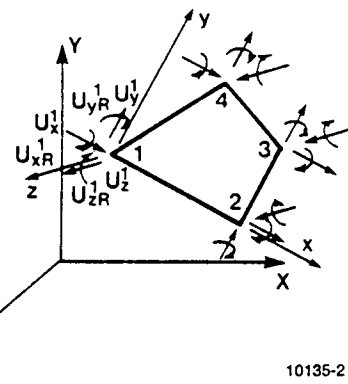

10135-2

(b) Quadrilateral shell element.

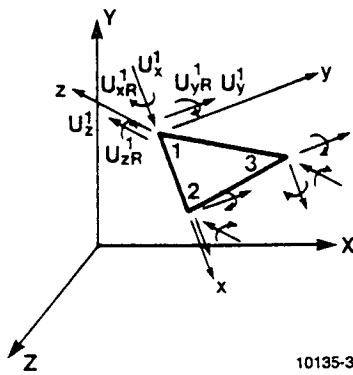

10135-3

(c) Triangular shell element.

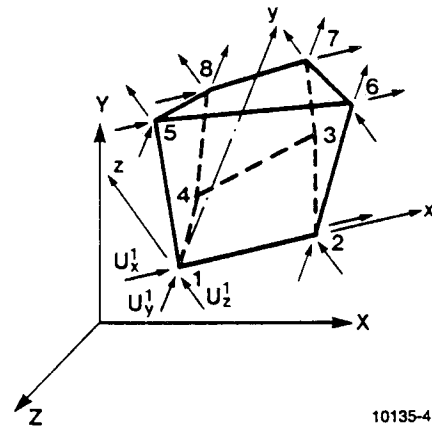

10135-4

(d) Hexahedral solid element.

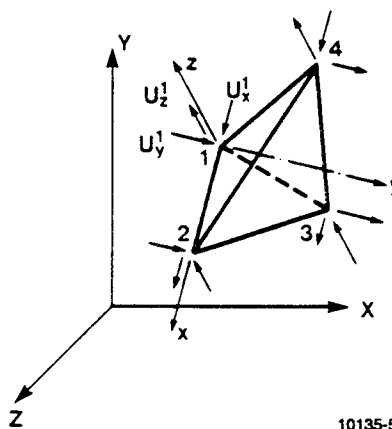

10135-5

(e) Tetrahedral solid element.

Figure 6. STARS-SOLIDS element types.

5. Structural modeling:

Since each node is assumed to possess six displacement degrees of freedom, any individual structural form may be simply represented by suppressing appropriate displacement terms. The following rules may be adopted:

Truss structures: to allow only two nodal translational deformations in the plane of the structure; to use line elements.

Plane frame: all three in-plane displacements, namely, two translations and one rotation, are retained in the formulation; to use line elements.

Plane stress/strain: displacement boundary conditions are similar to truss structures; to use shell elements.

Plate bending: only the three out-of-plane displacements consisting of one translation and two rotations are considered for the analysis; to use shell elements.

Solid structures: the three translational degrees of freedom are retained in the analysis; to use solid elements.

Shell, space frame: all six degrees of freedom are to be retained in the solution process; to use shell and line elements, respectively.

Suppression of derived nodal motion may be achieved by using zero and interdependent displacement boundary conditions (ZBDC, IDBC) defined in sections 3.2 and 3.4, respectively.

3.3.3 \$ COMPOSITE SHELL ELEMENT STACK DESCRIPTION DATA (Required for composite shell elements (types 6 and 7), and only if NSTACK \neq 0)

3.3.4 ISTACK, NLAYER
Format (2I5)

3.3.5 (IMATC(I), THCL(I), IMANGC(I), I = 1, NLAYER)
Format (I5, E10.4, I5)

1. Description: NSTACK sets of composite shell element data.

2. Notes:

ISTACK = stack number

NLAYER = number of layers in the stack

IMATC(I) = material type number for the composite layer

THCL(I) = thickness of the composite layer

IMANGC(I) = integer specifying material angle type number (IMANG)

3.3.6 \$ SPECIFICATION FOR MATERIAL AXES ORIENTATION (Required if NMANGL ≠ 0)

3.3.7 IMANG, IMAMD, ILGCS
Format (3I5)

3.3.8 D11, D12, D13, D21, D22, D23, (IMAMD = 1)
D31, D32, D33
Format (2(6E10.4,/))
or
THETA (IMAMD = 2)
Format (E10.4)

1. Description: NMANGL sets of material angle definition data.

2. Notes:

IMAMD = integer defining material angle data input mode
= 1, involves input of elements of direction cosine matrix of material axes with respect to LGCS/GCS (set ILGCS = 0 for data in GCS)
= 2, requires input of material axis angle (THETA) with shell element local x-axis

ILGCS = integer specifying local-global coordinate system number (set to 0 if data is in GCS)

THETA = material axis angle with respect to shell element local x-axis

3.3.9 \$ LINE ELEMENT BASIC PROPERTIES (Required for line elements only)

3.3.10 IEPP, A, JX, IY, IZ, SFY, SFZ
Format (I5, 6E10.4)

1. Description: NEP sets of line element basic property data in element local coordinate system (LCS).

2. Notes:

IEPP = integer denoting line element property type

A = area of cross section

JX = torsional moment of inertia about element x-axis

IY = moment of inertia about element y-axis

- IZ = moment of inertia about element z-axis
- SFY = A/ASY, shear area (ASY) factor along y-axis
- SFZ = A/ASZ, shear area (ASZ) factor along z-axis

For no shear area effect, SFY and SFZ are to be set at 0.0.

3.3.11 \$ LINE ELEMENT SPECIAL END CONDITIONS (Required for line elements only
if NLSEC \neq 0)

3.3.12 ILSEC, (k(I), I = 1, 6)
Format (I5, 6E10.4)

1. Description: NLSEC sets of line element special end conditions data in LCS.

2. Notes:

ILSEC = element end condition type (to be set greater than 1), referring to members attached to the nodes at its ends by flexible connections, or members with free end degrees of freedom in LCS (corresponds to IEC1 and IEC2)
= set to a negative value, less than -1, for scalar springs connecting two nodes (corresponds to IEC1)

k(I) = additional spring stiffness along Ith translational (x-, y-, and z-direction) degree of freedom and actual rotational Ith spring stiffness (x, y, and z rotational constraint)
= -2, for rigid rotational Ith constraint
= -1, for release of corresponding member end degree of freedom, relevant also to ILSEC value set greater than 1
= stiffness values for scalar springs associated with a negative ILSEC value less than -2

Such elements may have 0 or any finite length.

To simulate only specified end condition, set Young's modulus $E = 0$ for the corresponding material type, IMPP.

3.3.13 \$ SHELL ELEMENT THICKNESS (Required for shell elements
(types 2 and 3) only)

3.3.14 ITHTH, TM, TB, TS
Format (I5, E10.4)

1. Description: NET sets of element thickness data.

2. Notes:

ITHTH = element thickness type
 TM = membrane element thickness
 TB = bending element thickness
 TS = transverse shear element thickness

Above shell thickness pertains to sandwich elements; in the absence of data for TB and TS, the shell element thickness T is taken as TM.

For consistent mass matrix formulation, shell thickness T is taken as TM.

3.3.15 \$ ELEMENT MATERIAL PROPERTIES

3.3.16 IMPP, MT
Format (2I5)

3.3.17 E, MU, ALP, RHO (material type 1); or

E11, E12, E14, E22, E24, E44, E55,
E56, E66, ALPX, ALPY, ALPXY, RHO (material type 2); or

E11, E12, E13, E14, E15, E16, E22,
E23, E24, E25, E26, E33, E34, E35,
E36, E44, E45, E46, E55, E56, E66,
ALP1, ALP2, ALP3, ALP4, ALP5, ALP6, RHO (material type 3); or

EM, EB, ES, MUM, MUB, MUS,
ALPM, ALPB, ALPS, RHO (material type 4); or

E11M, E12M, E14M, E22M, E24M, E44M,
E11B, E12B, E14B, E22B, E24B, E44B,
E55S, E56S, E66S, ALPXM, ALPYM, ALPXYM,
ALPXB, ALPYB, ALPXYB, ALPXS, ALPYS, ALPXYS, RHO (material type 5)
Format (4(7E10.4,/))

1. Description: NMAT sets of element material property data; the individual material matrices are derived from the 6 by 6 symmetric matrix for general solid material.

2. Notes:

IMPP = material number
 MT = material type
 = 1, isotropic
 = 2, orthotropic-anisotropic, shell elements
 = 3, orthotropic-anisotropic, solid elements

- = 4, isotropic, sandwich shell elements incorporating individual membrane, bending, and transverse shear effects
- = 5, orthotropic-anisotropic sandwich shell elements with individual effects, as above

E = Young's modulus

$E_{i,j}$ = elements of material stress-strain matrix ($i = 1, 6 ; j = 1, 6$)

MU = Poisson's ratio

ALP = coefficient of thermal expansion for isotropic material

ALPX, ALPY,
ALPXY = coefficients of thermal expansion, shell elements

ALP1 through
ALP6 = coefficients of thermal expansion, solid elements

RHO = mass per unit volume

For sandwich elements (material types 4 and 5), relevant notations defining such properties utilize a postscript of M, B, or S for membrane, bending, or transverse shear stiffness, respectively.

3.3.18 \$ ELEMENT TEMPERATURE DATA (Required if NTMP \neq 0)

3.3.19 ITMPP, T, DTDY, DTDZ
Format (2(I5,3E10.4))

1. Description: NTMP number of element temperature types; table 3 shows compatible input data.

Table 3. Element temperature data input.

Element type	T	DTDY	DTDZ
1	*	*	*
2,3,6,7	*		*
4,5	*		

2. Notes:

ITMPP = element temperature increase type

- T = uniform temperature increase; relates to all elements
- DTDY = temperature gradient along element local y-axis; relates to line elements only
- DTDZ = temperature gradient along element local z-axis; relates to line and shell elements
- * = compatible input data

3.3.20 \$ ELEMENT PRESSURE DATA (Required if NPR ≠ 0)

3.3.21 IPRR, PR
Format (5(I5,E10.4))

1. Description: NPR sets of element pressure data.
2. Notes:

IPRR = element pressure type

PR = uniform pressure

Pressure directions for line elements: uniform pressure is allowed in local y- and z-direction only, and the program calculates as input both end loads and moments; while pressure corresponding to a first nodal input pertains to y-direction, a subsequent input for the same node signifies pressure acting in the z-direction.

Pressure directions for shell elements: uniform pressure is allowed in local z-direction only; the program computes nodal load input.

Pressure directions for solid elements: uniform pressure is allowed on base surfaces defined by nodes 1-2-3-4 and 1-2-3 for hexahedral and tetrahedral elements, respectively, acting in local z-direction; the program computes nodal load input data.

3.3.22 \$ PRESTRESSED RECTANGULAR MEMBRANE ELEMENT DATA
(Required if NEXP ≠ 0)

3.3.23 IIEXP, SX, SY
Format (I5,2E10.4)

1. Description: NEXP sets of prestressed membrane stress data.
2. Notes:

IIEXP = integer defining stress combination type

SX, SY = membrane stresses in the element x- and y-directions, respectively

3.4 Data in Global or Local-Global Coordinate System

General note: Data input may be at random within each data group.

3.4.1 \$ ELEMENT SPIN RATE DATA (Required if NSPIN \neq 0)

3.4.2 IST, SPX, SPY, SPZ, ILGCS
Format (I5, 3E10.4, I5)

1. Description: NSPIN sets of spin data.

2. Notes:

IST = spin type

SPX, SPY, SPZ = components of element spin rate in global/local-global X-, Y-, and Z-directions, respectively

ILGCS = local-global coordinate system number, as defined in section 3.2.2

3.4.3 \$ DISPLACEMENT BOUNDARY CONDITION DATA (Required if NBUN \neq 0)

3.4.4 INI, IDOFJ, INIP, IDOFJP, CONFCT, IDRCS, NDBCON
Format (4I5, E10.4, 2I5)

1. Description: NBUN sets of nodal interdependent displacement boundary condition (IDBC) data.

2. Notes:

INI = node number I

IDOFJ = Jth DOF associated with node I

INIP = node number I'

IDOFJP = J'th DOF associated with node I'

CONFCT = connectivity factor

IDRCS = displacement boundary condition reference coordinate system

NDBCON = integer defining displacement boundary condition increment
= 0, no increment
= an integer, to increment IDOFJ and IDOFJP by 1 until IDOFJ reaches NDBCON value

J and J' vary between 1 and 6.

3. Additional notes:

The nodal displacement boundary conditions' relationship is expressed as

$$U_{i,j} = a_{m,n} U_{m,n}$$

$$= a_{i,j} U_{i,j} + a_{i',j'} U_{i',j'} + \dots$$

The input scheme is shown in table 4.

Table 4. Data layout for displacement boundary conditions.

Node 1	DOF	Node 2	DOF	Connectivity coefficient	Terminology	Reference coordinate system	Incremental DOF value
i	j	i'	j'	$a_{i',j'}$	IDBC	IDRCS	NDBCON
i	j	i	j	$a_{i,j}$	FDBC	IDRCS	NDBCON
i	j	i	j	0	ZDBC	IDRCS	NDBCON

in which

i, i' = node numbers,

j, j' = degrees of freedom,

$a_{i,j}, a_{i',j'}$ = connectivity coefficients.

IDBC, FDBC, and ZDBC are, respectively, the interdependent, finite, and zero displacement boundary conditions. The ZDBC may also be conveniently implemented by following the rules given in table 1, which is generally recommended for such cases. It should be noted that the dependent degrees of freedom appearing in columns 1 and 2 may not appear subsequently in columns 3 and 4 as independent degrees of freedom. However, the independent degrees of freedom may be subsequently related.

3.4.5 \$ NODAL LOAD DATA (Required if IPLUMP ≠ 0)

3.4.6 IN, IDOF, P, IDOFE
Format (2I5, E10.4, I5)

1. Description: NC sets of nodal force data.

2. Notes:

IN = node number

IDOF and IDOFE are, respectively, the start and end degrees of freedom assigned with the same P value; default value for IDOFE is IDOF.

P = nodal load

Each data set is to be terminated by setting a negative value for IN.

3.4.7 \$ NODAL MASS DATA (Required if IMLUMP \neq 0)

3.4.8 IN, IDOF, M, IDOFE
Format (2I5, E10.4, I5)

1. Description: Nodal lumped mass data.

2. Notes:

M = nodal mass

Other definitions are as in section 3.4.6.

3.4.9 \$ NODAL MASS MATRIX IN LGCS/GCS (Required if INMM \neq 0)

3.4.10 IN, ILGCS
Format (2I5)

3.4.11 (VNMDAT(I), I = 1, 36)
Format (6(6E10.4,/))

1. Description: User input of 6 by 6 nodal mass matrix.

2. Notes:

The user may input data for only the upper symmetric elements; numbers in lower half may be set to zero as the program automatically symmetrizes the matrix.

For data in GCS, set LGCS = 0.

Each data set is to be terminated by setting a negative value for IN.

3.4.12 \$ NODAL INITIAL DISPLACEMENT AND VELOCITY DATA (Required if IUUV = 1
and IDRS = 1)

3.4.13 IN, IDOF, UI, VI
Format (2I5, 2E15.5)

1. Description: Initial displacements and velocities data.

2. Notes:

- IN = node number
- IDOF = degree of freedom
- UI = initial displacement value
- VI = initial velocity value

Data set is terminated if IN is read as -1.

3.4.14 \$ NODAL FORCE ACCELERATION DATA (Required if NTTS ≠ 0 and IDRS = 1)

3.4.15 TZ
Format (E15.5)

3.4.16 IN, IDOF, PZ
Format (2I5, E15.5)

1. Description: NTTS sets of dynamic nodal load (IDDI = 1) or acceleration (IDDI = 2) input data.

2. Notes:

TZ = time-duration of load application

PZ = nodal force or acceleration data

Each data set is terminated by setting IN value to -1; other definitions are as given in section 3.4.6.

3.4.17 \$ INCREMENTAL TIME DATA FOR RESPONSE CALCULATION (Required if NDEL T ≠ 0 and IDRS = 1)

3.4.18 DELT, IDELT
Format (E15.5, I5)

1. Description: NDEL T sets of uniform incremental time input data for dynamic response calculations.

2. Notes:

DELT = uniform incremental time step

IDELT = total number of uniform time steps in the data set

3.5 Additional Basic Data

3.5.1 \$ VISCOUS DAMPING DATA (Required if IPROB = 4 or 5)

3.5.2 (C(I,1), I = 1, N)
Format (6E10.4)

1. Description: User input of diagonal viscous damping matrix.

2. Notes:

C = diagonal viscous damping matrix

N = order of matrix

3.5.3 \$ COEFFICIENTS FOR PROPORTIONAL VISCOUS DAMPING (Required if IPROB = 6 or 7)

3.5.4 ALPHA, BETA
Format (2E10.4)

1. Description: Proportional viscous damping formulation $C = ALPHA * K + BETA * M$

2. Notes:

ALPHA and BETA are damping parameters.

K and M are system stiffness and mass matrices.

3.5.5 \$ USER INPUT OPTION FOR VISCOUS DAMPING MATRIX (Required if IPROB = 6 or 7 and ALPHA and BETA set to 0)

3.5.6 ((C(I,J), J = 1, M11), I = 1, 6)
Format (6E10.4)

1. Description: NN sets of user input of banded viscous damping matrix C(N,M11) in blocks of six rows of bandwidth M11, one row at a time (N = 6*NN).

2. Notes:

Data file must conform to IDBC, FDBC, and ZDBC, inherent in the problem.

3.5.7 \$ MEASURED MODAL DATA INPUT (Required if IINTP = 2)

3.5.8 (INODM(I), (DISPLM(I,J), J = 1,6), I = 1, NN)
Format (I5, 6E10.4)

1. Description: Measured modal displacement data input, NR sets of data.

2. Notes:

Each data set to be terminated by setting INODM(I) value to -1.

3.5.9 \$ OUTPUT POINTS SPECIFICATION FOR DIRECT INTERPOLATION OF MODAL DATA (Required if NOUT ≠ 0)

3.5.10 (IOUTP(I), (ICONP(I,J), J = 1, 6), I = 1, NOUT)
Format (7I5)

1. Description: To read output point and up to six connecting points

2. Notes:

IOUTP(I) = output points on AERO interpolation lines

ICONP(I,J) = STARS finite element nodes whose deflections will be averaged to calculate the deflection value at the interpolation point

3.5.11 \$ RIGID CONTROL MODES DATA INPUT (Required if NCNTRL ≠ 0)

3.5.12 INS, IDOF, DISP, INE, ININC
Format (2I5, E10.4, 2I5)

1. Description: Modal displacement data for NCNTRL number of modes.

2. Notes:

INS, INE = starting and end node numbers; default value for INE is INS

IDOF = degree of freedom, a value between 1 and 6

DISP = associated displacement

ININC = integer defining nodal incremental value; to increment INS by ININC until INE is attained

Each data set is to be terminated by setting INS value to -1.

This section provides the input data, as well as relevant outputs, of 12 typical test cases involving static, stability, free vibration, and dynamic response analyses of representative structures. The input data are prepared in accordance with the procedures described in section 3. Details of such analyses are in the descriptions that follow in which each structural geometry is described in a right-handed, rectangular coordinate system, and the associated input data are defined in consistent unit form.

4.1 Space Truss: Static Analysis

The static analysis of the space truss depicted in figure 7 (ref. 9) was performed to yield nodal deformations and element forces. A load of 300 lb acts at node 7 along the axial direction of the member connecting nodes 7 and 9; another load of 500 lb is applied at node 10 in the direction of the structural base centerline. Also, the three members in the upper tier of the structure are subjected to a uniform temperature increase of 100° . Two rigid elements are, however, introduced between nodes 5 and 8 and nodes 7 and 9.

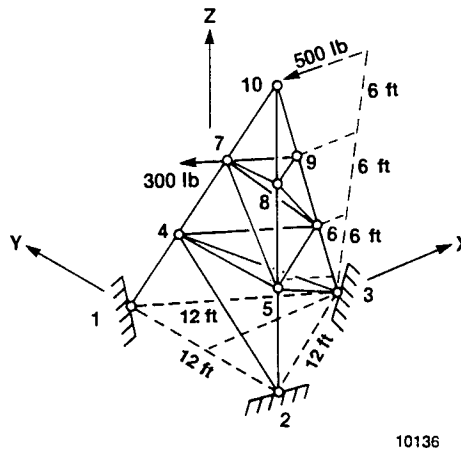

10136

Figure 7. Space truss.

Important data parameters:

Young's modulus, E	=	1.0×10^7
Poisson's ratio, μ	=	0.3
Coefficient of thermal expansion, α	=	12.5×10^{-6}

STARS input data:

SPACE TRUSS - MECHANICAL AND THERMAL LOADING - RBARS FROM NODES 5-8, 7-9

11,21,1,4,1,0,0,0,0,0

1,0,0,1,0,0,0,0,0

8,0,0,1,1,0,0,0

2,0,1,0,1

\$ NODAL DATA

1	0.0	72.0	0.0	1	1	1	0	0	0
2	0.0	-72.0	0.0	1	1	1	0	0	0
3	124.68	0.0	0.0	1	1	1	0	0	0
4	13.86	48.0	72.0						
5	13.86	-48.0	72.0						
6	96.972	0.0	72.0						
7	27.708	24.0	144.0						
8	27.708	-24.0	144.0						
9	69.276	0.0	144.0						
10	41.568	0.0	216.0						
11	144.0	36.0	0.0	1	1	1	1	1	1

\$ ELEMENT CONNECTIVITY

1	1	1	4	11	1	1	0	0	0	1	1
1	2	2	4	11	1	1				1	1
1	3	2	5	11	1	1				1	1
1	4	3	5	11	1	1				1	1
1	5	3	6	11	1	1				1	1
1	6	3	4	11	1	1				1	1
1	7	4	5	11	1	1				1	1
1	8	5	6	11	1	1				1	1
1	9	6	4	11	1	1				1	1
1	10	4	7	11	1	1				1	1
1	11	5	7	11	1	1				1	1
8	12	5	8	11			-1				
1	13	6	8	11	1	1				1	1
1	14	6	9	11	1	1				1	1
1	15	6	7	11	1	1				1	1
1	16	7	8	11	1	1				1	1
1	17	8	9	11	1	1				1	1
8	18	9	7	11	1	1					
1	19	7	10	11	1	1				1	1
1	20	8	10	11	1	1				1	1
1	21	9	10	11	1	1				1	1

\$ LINE ELEMENT BASIC PROPERTIES

1 0.01389

\$ ELEMENT MATERIAL PROPERTIES

1 1
10.0E6 0.3 12.5E-06

\$ ELEMENT TEMPERATURE DATA

1 100.0

\$ NODAL LOAD DATA

10 1 -500.0
7 1 -259.8
7 2 150.0
-1

STARS analysis results - nodal deformations and element stresses:

LOAD CASE NO. 1

NODE		X-DISPL.	Y-DISPL.	Z-DISPL.	X-ROTN.	Y-ROTN.	Z-ROTN.
EXT	INT						
1	1	0.000000E+00	0.000000E+00	0.000000E+00	0.000000E+00	0.000000E+00	0.000000E+00
2	2	0.000000E+00	0.000000E+00	0.000000E+00	0.000000E+00	0.000000E+00	0.000000E+00
3	3	0.000000E+00	0.000000E+00	0.000000E+00	0.000000E+00	0.000000E+00	0.000000E+00
4	4	-0.302075E+00	0.233780E+00	-0.331469E+00	0.000000E+00	0.000000E+00	0.000000E+00
5	5	-0.294402E+00	0.233737E+00	-0.297469E+00	-0.533925E-01	-0.976475E-01	-0.252952E+00
6	6	-0.358100E+00	0.344029E+00	0.558126E+00	0.000000E+00	0.000000E+00	0.000000E+00
7	7	-0.161162E+01	0.575101E+00	-0.385535E+00	0.000000E+00	0.000000E+00	0.000000E+00
8	8	-0.125416E+01	0.575116E+00	-0.226667E+00	-0.533925E-01	-0.976475E-01	-0.252952E+00
9	9	-0.143291E+01	0.884640E+00	0.696849E+00	0.000000E+00	0.000000E+00	0.000000E+00
10	10	-0.460499E+01	0.916627E+00	0.131711E+00	0.000000E+00	0.000000E+00	0.000000E+00
11	11	0.000000E+00	0.000000E+00	0.000000E+00	0.000000E+00	0.000000E+00	0.000000E+00
12	12	0.000000E+00	0.000000E+00	0.000000E+00	0.000000E+00	0.000000E+00	0.000000E+00

ELEMENT STRESSES

ELEMENT NO.	END1	END2	END3	END4	PX1/PX2		PY1/PY2		PZ1/PZ2		MX1/MX2		MY1/MY2		MZ1/MZ2	
					SXT	SXX	SYT	SYX	SXT	SZY	SXB	SXY	SYB	SYZ	SXYB	SZY
1	1	4			0.785575E+03	-0.785575E+03	0.000000E+00	0.000000E+00	0.000000E+00	0.000000E+00	0.000000E+00	0.000000E+00	0.000000E+00	0.000000E+00	0.000000E+00	0.000000E+00
2	2	4			-0.756511E-02	0.756511E-02	0.000000E+00	0.000000E+00	0.000000E+00	0.000000E+00	0.000000E+00	0.000000E+00	0.000000E+00	0.000000E+00	0.000000E+00	0.000000E+00
3	2	5			0.464123E+03	-0.464123E+03	0.000000E+00	0.000000E+00	0.000000E+00	0.000000E+00	0.000000E+00	0.000000E+00	0.000000E+00	0.000000E+00	0.000000E+00	0.000000E+00
4	3	5			0.807432E-01	-0.807432E-01	0.000000E+00	0.000000E+00	0.000000E+00	0.000000E+00	0.000000E+00	0.000000E+00	0.000000E+00	0.000000E+00	0.000000E+00	0.000000E+00
5	3	6			-0.116939E+04	0.116939E+04	0.000000E+00	0.000000E+00	0.000000E+00	0.000000E+00	0.000000E+00	0.000000E+00	0.000000E+00	0.000000E+00	0.000000E+00	0.000000E+00
6	3	4			-0.146366E+03	0.146366E+03	0.000000E+00	0.000000E+00	0.000000E+00	0.000000E+00	0.000000E+00	0.000000E+00	0.000000E+00	0.000000E+00	0.000000E+00	0.000000E+00
7	4	5			-0.627136E-01	0.627136E-01	0.000000E+00	0.000000E+00	0.000000E+00	0.000000E+00	0.000000E+00	0.000000E+00	0.000000E+00	0.000000E+00	0.000000E+00	0.000000E+00
8	5	6			0.177002E-02	-0.177002E-02	0.000000E+00	0.000000E+00	0.000000E+00	0.000000E+00	0.000000E+00	0.000000E+00	0.000000E+00	0.000000E+00	0.000000E+00	0.000000E+00
9	6	4			0.150008E+03	-0.150008E+03	0.000000E+00	0.000000E+00	0.000000E+00	0.000000E+00	0.000000E+00	0.000000E+00	0.000000E+00	0.000000E+00	0.000000E+00	0.000000E+00
10	4	7			0.705240E+03	-0.705240E+03	0.000000E+00	0.000000E+00	0.000000E+00	0.000000E+00	0.000000E+00	0.000000E+00	0.000000E+00	0.000000E+00	0.000000E+00	0.000000E+00
11	5	7			0.452271E-01	-0.452271E-01	0.000000E+00	0.000000E+00	0.000000E+00	0.000000E+00	0.000000E+00	0.000000E+00	0.000000E+00	0.000000E+00	0.000000E+00	0.000000E+00
12	5	8			0.000000E+00	0.000000E+00	0.000000E+00	0.000000E+00	0.000000E+00	0.000000E+00	0.000000E+00	0.000000E+00	0.000000E+00	0.000000E+00	0.000000E+00	0.000000E+00
13	6	8			-0.180786E+00	0.180786E+00	0.000000E+00	0.000000E+00	0.000000E+00	0.000000E+00	0.000000E+00	0.000000E+00	0.000000E+00	0.000000E+00	0.000000E+00	0.000000E+00
14	6	9			-0.927916E+03	0.927916E+03	0.000000E+00	0.000000E+00	0.000000E+00	0.000000E+00	0.000000E+00	0.000000E+00	0.000000E+00	0.000000E+00	0.000000E+00	0.000000E+00
15	6	7			-0.321364E+03	0.321364E+03	0.000000E+00	0.000000E+00	0.000000E+00	0.000000E+00	0.000000E+00	0.000000E+00	0.000000E+00	0.000000E+00	0.000000E+00	0.000000E+00
16	7	8			0.424805E-01	-0.424805E-01	0.000000E+00	0.000000E+00	0.000000E+00	0.000000E+00	0.000000E+00	0.000000E+00	0.000000E+00	0.000000E+00	0.000000E+00	0.000000E+00
17	8	9			0.837402E-01	-0.837402E-01	0.000000E+00	0.000000E+00	0.000000E+00	0.000000E+00	0.000000E+00	0.000000E+00	0.000000E+00	0.000000E+00	0.000000E+00	0.000000E+00
18	9	7			0.000000E+00	0.000000E+00	0.000000E+00	0.000000E+00	0.000000E+00	0.000000E+00	0.000000E+00	0.000000E+00	0.000000E+00	0.000000E+00	0.000000E+00	0.000000E+00
19	7	10			0.290373E+03	-0.290373E+03	0.000000E+00	0.000000E+00	0.000000E+00	0.000000E+00	0.000000E+00	0.000000E+00	0.000000E+00	0.000000E+00	0.000000E+00	0.000000E+00
20	8	10			0.290373E+03	-0.290373E+03	0.000000E+00	0.000000E+00	0.000000E+00	0.000000E+00	0.000000E+00	0.000000E+00	0.000000E+00	0.000000E+00	0.000000E+00	0.000000E+00
21	9	10			-0.110159E+04	0.110159E+04	0.000000E+00	0.000000E+00	0.000000E+00	0.000000E+00	0.000000E+00	0.000000E+00	0.000000E+00	0.000000E+00	0.000000E+00	0.000000E+00

4.2 Space Frame: Static Analysis

A space frame with rigid connections, shown in figure 8 (ref. 10), is subjected to nodal forces and moments. Results of such analysis are presented below.

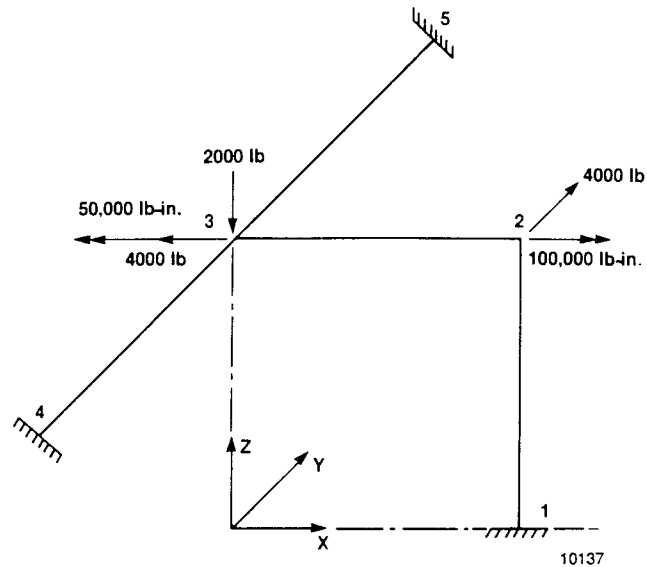

Figure 8. Space frame structure.

Important data parameters:

Young's modulus, E	$= 30.24 \times 10^6$
Poisson's ratio, μ	$= 0.2273$
Cross-sectional area, A	$= 25.13$
Member length, ℓ	$= 120$

STARS input data:

```

SPACE FRAME CASE
6,4,1,4,1,0,0,0,0,0
0,0,0,1,0,0,0,0,0
8,0,0,1,1,0,0,0
2,0,1,0,1
$ NODAL DATA
  1 120.0    0.0    0.0    1  1  1  1  1  1
  2 120.0    0.0   120.0    0  0  0  0  0  0
  3    0.0    0.0   120.0    0  0  0  0  0  0
  4    0.0   -120.0  120.0    1  1  1  1  1  1
  5    0.0   120.0   120.0    1  1  1  1  1  1
  6   10.0   10.0    0.0    1  1  1  1  1  1
$ ELEMENT CONNECTIVITY
  1  1  1  2  6  0  0          1  1
  1  2  2  3  6  0  0          1  1
  1  3  3  4  6  0  0          1  1
  1  4  3  5  6  0  0          1  1
$ LINE ELEMENT BASIC PROPERTIES
  1  25.13  125.7  62.83
$ ELEMENT MATERIAL PROPERTIES
  1  1
  30.24E06  0.2273
$ NODAL LOAD DATA
  2  4  100000.0
  2  2  4000.0
  3  1  -4000.0
  3  3  -2000.0
  3  4  -50000.0
-1

```

STARS analysis results:

LOAD CASE NO. 1

NODE							
EXT	INT	X-DISPL.	Y-DISPL.	Z-DISPL.	X-ROTN.	Y-ROTN.	Z-ROTN.
1	1	0.000000E+00	0.000000E+00	0.000000E+00	0.000000E+00	0.000000E+00	0.000000E+00
2	2	-0.125288E+00	0.347953E+00	0.196027E-04	-0.239969E-02	-0.121545E-02	0.323397E-02
3	3	-0.125397E+00	0.103330E-03	-0.804946E-01	-0.580122E-03	-0.283265E-03	0.910380E-03
4	4	0.000000E+00	0.000000E+00	0.000000E+00	0.000000E+00	0.000000E+00	0.000000E+00
5	5	0.000000E+00	0.000000E+00	0.000000E+00	0.000000E+00	0.000000E+00	0.000000E+00
6	6	0.000000E+00	0.000000E+00	0.000000E+00	0.000000E+00	0.000000E+00	0.000000E+00

ELEMENT STRESSES

ELEMENT NO.	END1	END2	END3	END4	PX1/PX2		PY1/PY2		PZ1/PZ2		MX1/MX2		MY1/MY2		MZ1/MZ2	
					SXT	SYT	SXT	SYT	SXT	SYT	SXB	SYB	SXB	SYB	SXZ	SYZ
1	1	2			-0.124139E+03	0.124139E+03	-0.931688E+03	0.931688E+03	0.261767E+04	-0.261767E+04	-0.417341E+05	0.417341E+05	-0.193156E+06	0.120964E+06	-0.785065E+05	-0.332961E+05
2	2	3			-0.690813E+03	0.690813E+03	0.232395E+03	-0.232395E+03	-0.129390E+04	0.129390E+04	0.234814E+05	-0.234814E+05	0.397457E+05	0.115522E+06	0.255969E+05	0.229051E+04
3	3	4			-0.654366E+03	0.654366E+03	0.523179E+03	-0.523179E+03	-0.980653E+03	0.980653E+03	0.365551E+04	-0.365551E+04	0.437120E+05	0.739664E+05	0.234344E+05	0.393472E+05
4	3	5			0.654366E+03	-0.654366E+03	0.131882E+04	-0.131882E+04	0.249337E+04	-0.249337E+04	-0.365551E+04	0.365551E+04	-0.164730E+06	-0.134475E+06	0.870856E+05	0.711728E+05

4.3 Plane Stress: Static Analysis

Figure 9 (ref. 11) depicts the finite element model of the symmetric half of a deep beam subjected to a concentrated load. Figure 10 shows the deformed shape of the structure.

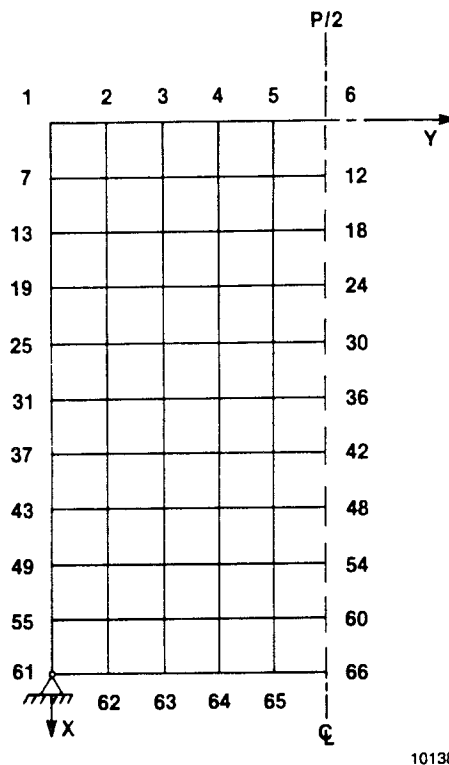

Figure 9. Deep beam example.

Important data parameters:

Young's modulus, E	$= 30 \times 10^6$
Poisson's ratio, μ	$= 0.2$
Nodal load, P	$= 10,000$
Beam side length, ℓ	$= 20$

STARS input data:

PLANE STRESS CASE - TEZCAN

66,50,1,4,0,1,0,0,0,0

0,0,0,1,0,0,0,0,0

8,0,0,1,1,0,0,0

2,0,2,0,1

\$ NODAL DATA

1	0.	0.	0.	0	0	1	1	1	0										
55	18.	0.	0.	0	0	1	1	1	0	0	0	6							
61	20.	0.	0.	1	1	1	1	1	1										
2	0.	2.	0.	0	0	1	1	1	0										
62	20.	2.	0.	0	0	1	1	1	0	0	0	6							
3	0.	4.	0.	0	0	1	1	1	0										
63	20.	4.	0.	0	0	1	1	1	0	0	0	6							
4	0.	6.	0.	0	0	1	1	1	0										
64	20.	6.	0.	0	0	1	1	1	0	0	0	6							
5	0.	8.	0.	0	0	1	1	1	0										
65	20.	8.	0.	0	0	1	1	1	0	0	0	6							
6	0.	10.	0.	0	1	1	1	1	1										
66	20.	10.	0.	0	1	1	1	1	1	0	0	6							

\$ ELEMENT CONNECTIVITY

2	1	1	7	8	2	0	0	0	0	1	1								
2	10	55	61	62	56					1	1	0	0	0	6				
2	11	2	8	9	3					1	1								
2	20	56	62	63	57					1	1			6					
2	21	3	9	10	4					1	1								
2	30	57	63	64	58					1	1			6					
2	31	4	10	11	5					1	1								
2	40	58	64	65	59					1	1			6					
2	41	5	11	12	6					1	1								
2	50	59	65	66	60					1	1			6					

\$ SHELL ELEMENT THICKNESS

1 0.1 0.1 0.1

\$ ELEMENT MATERIAL PROPERTIES

1 1
30.0E6 0.2

\$ NODAL LOAD DATA

6 1 5000.

-1

STARS analysis results:

LOAD CASE NO. 1

NODE								
EXT	INT	X-DISPL.	Y-DISPL.	Z-DISPL.	X-ROTN.	Y-ROTN.	Z-ROTN.	
1	1	0.643004E-02	0.784168E-03	0.000000E+00	0.000000E+00	0.000000E+00	0.000000E+00	
2	2	0.686331E-02	0.806537E-03	0.000000E+00	0.000000E+00	0.000000E+00	0.000000E+00	
3	3	0.736951E-02	0.882648E-03	0.000000E+00	0.000000E+00	0.000000E+00	0.000000E+00	
4	4	0.814826E-02	0.991451E-03	0.000000E+00	0.000000E+00	0.000000E+00	0.000000E+00	
5	5	0.942354E-02	0.984274E-03	0.000000E+00	0.000000E+00	0.000000E+00	0.000000E+00	
6	6	0.135581E-01	0.000000E+00	0.000000E+00	0.000000E+00	0.000000E+00	0.000000E+00	
7	7	0.645125E-02	0.339509E-03	0.000000E+00	0.000000E+00	0.000000E+00	0.000000E+00	
8	8	0.685836E-02	0.327585E-03	0.000000E+00	0.000000E+00	0.000000E+00	0.000000E+00	
9	9	0.735772E-02	0.281376E-03	0.000000E+00	0.000000E+00	0.000000E+00	0.000000E+00	
10	10	0.810701E-02	0.135669E-03	0.000000E+00	0.000000E+00	0.000000E+00	0.000000E+00	
11	11	0.944763E-02	-0.202705E-03	0.000000E+00	0.000000E+00	0.000000E+00	0.000000E+00	
12	12	0.106295E-01	0.000000E+00	0.000000E+00	0.000000E+00	0.000000E+00	0.000000E+00	
13	13	0.650795E-02	-0.353817E-04	0.000000E+00	0.000000E+00	0.000000E+00	0.000000E+00	
14	14	0.683854E-02	-0.546589E-04	0.000000E+00	0.000000E+00	0.000000E+00	0.000000E+00	
15	15	0.730059E-02	-0.111159E-03	0.000000E+00	0.000000E+00	0.000000E+00	0.000000E+00	
16	16	0.797687E-02	-0.215918E-03	0.000000E+00	0.000000E+00	0.000000E+00	0.000000E+00	
17	17	0.877384E-02	-0.212967E-03	0.000000E+00	0.000000E+00	0.000000E+00	0.000000E+00	
18	18	0.919536E-02	0.000000E+00	0.000000E+00	0.000000E+00	0.000000E+00	0.000000E+00	
19	19	0.654701E-02	-0.242513E-03	0.000000E+00	0.000000E+00	0.000000E+00	0.000000E+00	
20	20	0.675883E-02	-0.242862E-03	0.000000E+00	0.000000E+00	0.000000E+00	0.000000E+00	
21	21	0.714184E-02	-0.252697E-03	0.000000E+00	0.000000E+00	0.000000E+00	0.000000E+00	
22	22	0.764636E-02	-0.249769E-03	0.000000E+00	0.000000E+00	0.000000E+00	0.000000E+00	
23	23	0.812575E-02	-0.171392E-03	0.000000E+00	0.000000E+00	0.000000E+00	0.000000E+00	
24	24	0.833486E-02	0.000000E+00	0.000000E+00	0.000000E+00	0.000000E+00	0.000000E+00	
25	25	0.649748E-02	-0.274906E-03	0.000000E+00	0.000000E+00	0.000000E+00	0.000000E+00	
26	26	0.659352E-02	-0.248456E-03	0.000000E+00	0.000000E+00	0.000000E+00	0.000000E+00	
27	27	0.688814E-02	-0.219499E-03	0.000000E+00	0.000000E+00	0.000000E+00	0.000000E+00	

16	32	38	39	33	-0.530784E+04	-0.532538E+03	0.288429E+04	-0.530784E+04	-0.532538E+03	0.288429E+04
17	38	44	45	39	-0.625965E+04	-0.109058E+04	0.356589E+04	-0.625965E+04	-0.109058E+04	0.356589E+04
18	44	50	51	45	-0.691433E+04	-0.217278E+04	0.466161E+04	-0.691433E+04	-0.217278E+04	0.466161E+04
19	50	56	57	51	-0.621450E+04	-0.470548E+04	0.572053E+04	-0.621450E+04	-0.470548E+04	0.572053E+04
20	56	62	63	57	-0.425137E+03	-0.198628E+04	0.149334E+04	-0.425137E+03	-0.198628E+04	0.149334E+04
21	3	9	10	4	-0.472056E+03	-0.371184E+03	0.221830E+03	-0.472056E+03	-0.371184E+03	0.221830E+03
22	9	15	16	10	-0.185435E+04	-0.224936E+04	0.212951E+04	-0.185435E+04	-0.224936E+04	0.212951E+04
23	15	21	22	16	-0.398151E+04	-0.156003E+04	0.314191E+04	-0.398151E+04	-0.156003E+04	0.314191E+04
24	21	27	28	22	-0.485999E+04	-0.662377E+03	0.308726E+04	-0.485999E+04	-0.662377E+03	0.308726E+04
25	27	33	34	28	-0.506124E+04	-0.531419E+03	0.303415E+04	-0.506124E+04	-0.531419E+03	0.303415E+04
26	33	39	40	34	-0.492160E+04	-0.933600E+03	0.320350E+04	-0.492160E+04	-0.933600E+03	0.320350E+04
27	39	45	46	40	-0.445751E+04	-0.169963E+04	0.354638E+04	-0.445751E+04	-0.169963E+04	0.354638E+04
28	45	51	52	46	-0.340814E+04	-0.270233E+04	0.371169E+04	-0.340814E+04	-0.270233E+04	0.371169E+04
29	51	57	58	52	-0.136223E+04	-0.268085E+04	0.255089E+04	-0.136223E+04	-0.268085E+04	0.255089E+04
30	57	63	64	58	-0.304189E+03	0.448786E+03	0.372647E+03	-0.304189E+03	0.448786E+03	0.372647E+03
31	4	10	11	5	-0.673925E+03	-0.272642E+04	0.179106E+04	-0.673925E+03	-0.272642E+04	0.179106E+04
32	10	16	17	11	-0.680483E+04	-0.387664E+04	0.554921E+04	-0.680483E+04	-0.387664E+04	0.554921E+04
33	16	22	23	17	-0.751821E+04	-0.893684E+03	0.401277E+04	-0.751821E+04	-0.893684E+03	0.401277E+04
34	22	28	29	23	-0.683326E+04	-0.234739E+03	0.293327E+04	-0.683326E+04	-0.234739E+03	0.293327E+04
35	28	34	35	29	-0.583750E+04	-0.432099E+03	0.248987E+04	-0.583750E+04	-0.432099E+03	0.248987E+04
36	34	40	41	35	-0.470407E+04	-0.105916E+04	0.240206E+04	-0.470407E+04	-0.105916E+04	0.240206E+04
37	40	46	47	41	-0.339649E+04	-0.179718E+04	0.239540E+04	-0.339649E+04	-0.179718E+04	0.239540E+04
38	46	52	53	47	-0.189864E+04	-0.213440E+04	0.207308E+04	-0.189864E+04	-0.213440E+04	0.207308E+04
39	52	58	59	53	-0.625687E+03	-0.124948E+04	0.118445E+04	-0.625687E+03	-0.124948E+04	0.118445E+04
40	58	64	65	59	-0.316120E+02	0.146181E+04	0.168679E+03	-0.316120E+02	0.146181E+04	0.168679E+03
41	5	11	12	6	-0.239134E+05	-0.106444E+05	0.129045E+05	-0.239134E+05	-0.106444E+05	0.129045E+05
42	11	17	18	12	-0.158184E+05	-0.461364E+02	0.497835E+04	-0.158184E+05	-0.461364E+02	0.497835E+04
43	17	23	24	18	-0.111853E+05	0.645631E+03	0.210061E+04	-0.111853E+05	0.645631E+03	0.210061E+04
44	23	29	30	24	-0.842533E+04	0.414872E+03	0.125923E+04	-0.842533E+04	0.414872E+03	0.125923E+04
45	29	35	36	30	-0.642358E+04	-0.220669E+03	0.969578E+03	-0.642358E+04	-0.220669E+03	0.969578E+03
46	35	41	42	36	-0.468073E+04	-0.101786E+04	0.883437E+03	-0.468073E+04	-0.101786E+04	0.883437E+03
47	41	47	48	42	-0.301527E+04	-0.167224E+04	0.826096E+03	-0.301527E+04	-0.167224E+04	0.826096E+03
48	47	53	54	48	-0.151628E+04	-0.170116E+04	0.664179E+03	-0.151628E+04	-0.170116E+04	0.664179E+03
49	53	59	60	54	-0.461703E+03	-0.571000E+03	0.355763E+03	-0.461703E+03	-0.571000E+03	0.355763E+03
50	59	65	66	60	-0.459945E+02	0.187102E+04	0.581728E+02	-0.459945E+02	0.187102E+04	0.581728E+02

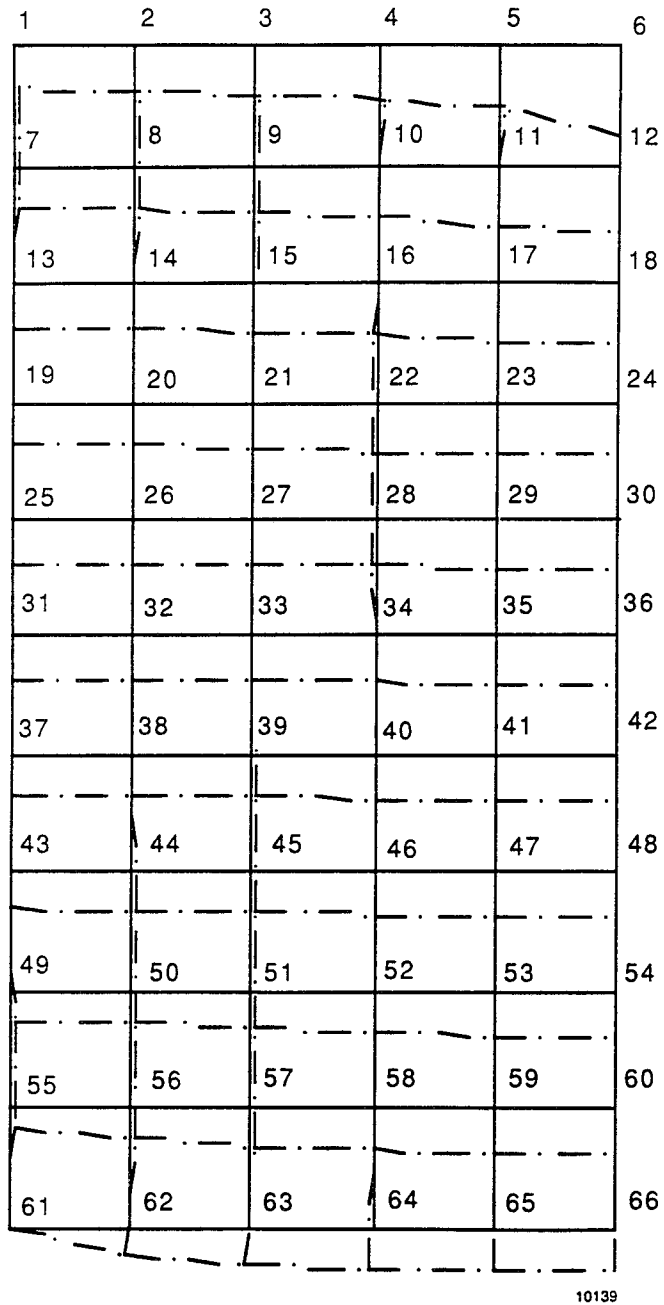

Figure 10. Original and deformed shape of deep beam.

4.4 Plate Bending: Vibration Analysis

A square cantilever plate was analyzed to yield the natural frequencies and associated mode shapes. Figure 11 depicts the plate with a 4 by 4 finite element mesh, the bottom edge along the x-axis being clamped.

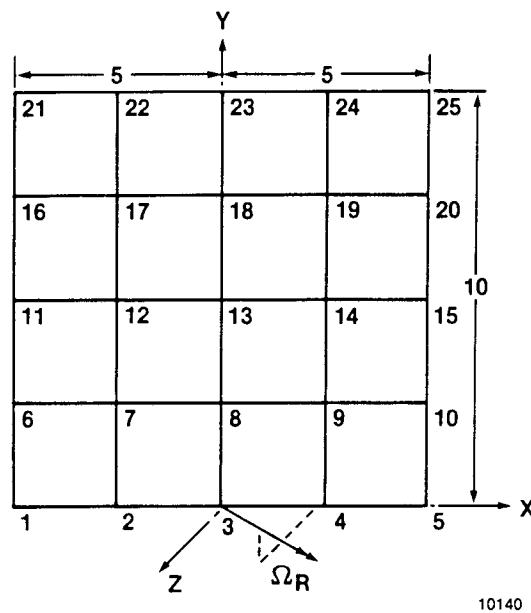

Figure 11. Square cantilever plate.

Important data parameters:

- Young's modulus, $E = 10 \times 10^6$
- Side length, $\ell = 10$
- Plate thickness, $t = 0.1$
- Poisson's ratio, $\mu = 0.3$
- Mass density, $\rho = 0.259 \times 10^{-3}$

STARS input data:

```

SQUARE 4 BY 4 PLATE    NONSPINNING STRUCTURE
25, 16, 1, 4, 0, 1, 0, 0, 0, 0
0, 0, 0, 1, 0, 0, 0, 0, 0
1, 1, 0, 1, 0, 0, 0, 0, 0
2, 0, 2, 0, 1
1, 6, 0, 6000.0, 0.0, 0, 0.0
$ NODAL DATA
1      -5.0      0.0      0.0      1      1      1      1      1      1      0      0      0
5       5.0      0.0      0.0      1      1      1      1      1      1      0      0      1
6      -5.0      2.5      0.0      0      0      0      0      0      0      0      0      0
10     5.0      2.5      0.0      0      0      0      0      0      0      0      0      1
11    -5.0      5.0      0.0      0      0      0      0      0      0      0      0      0
15     5.0      5.0      0.0      0      0      0      0      0      0      0      0      1
16    -5.0      7.5      0.0      0      0      0      0      0      0      0      0      0
20     5.0      7.5      0.0      0      0      0      0      0      0      0      0      1
21    -5.0      10.0     0.0      0      0      0      0      0      0      0      0      0
25     5.0      10.0     0.0      0      0      0      0      0      0      0      0      1
$ ELEMENT CONNECTIVITY
2  1  1  2  7  6  0  0  0  0  1  1  0  0  0
2  4  4  5  10 9  0  0  0  0  1  1  0  0  1
2  5  6  7  12 11 0  0  0  0  1  1  0  0  0
2  8  9  10 15 14 0  0  0  0  1  1  0  0  1
2  9  11 12 17 16 0  0  0  0  1  1  0  0  0
2  12 14 15 20 19 0  0  0  0  1  1  0  0  1
2  13 16 17 22 21 0  0  0  0  1  1  0  0  0
2  16 19 20 25 24 0  0  0  0  1  1  0  0  1
$ SHELL ELEMENT THICKNESSES
1      0.1
$ ELEMENT MATERIAL PROPERTIES
1      1
1.0E+07      0.30      0.0 0.259E-3
    
```

STARS output summary - The output summary is presented in table 5.

Table 5. Natural frequencies of a square cantilever plate.

Mode	Natural frequency ω , rad/sec	Nondimensional parameter $\gamma = \omega^2 \sqrt{\rho t/D}$
1	214.02	3.60
2	506.62	8.52
3	1248.40	20.99
4	1538.29	25.87
5	1765.53	29.69

Note: D = plate flexural rigidity
 $= Et^3/12(1 - \mu^2)$

4.5 General Shell: Vibration Analysis

A cantilevered circular cylindrical shell is shown in figure 12 in which quadrilateral shell elements are used for structural discretization to perform a free vibration analysis.

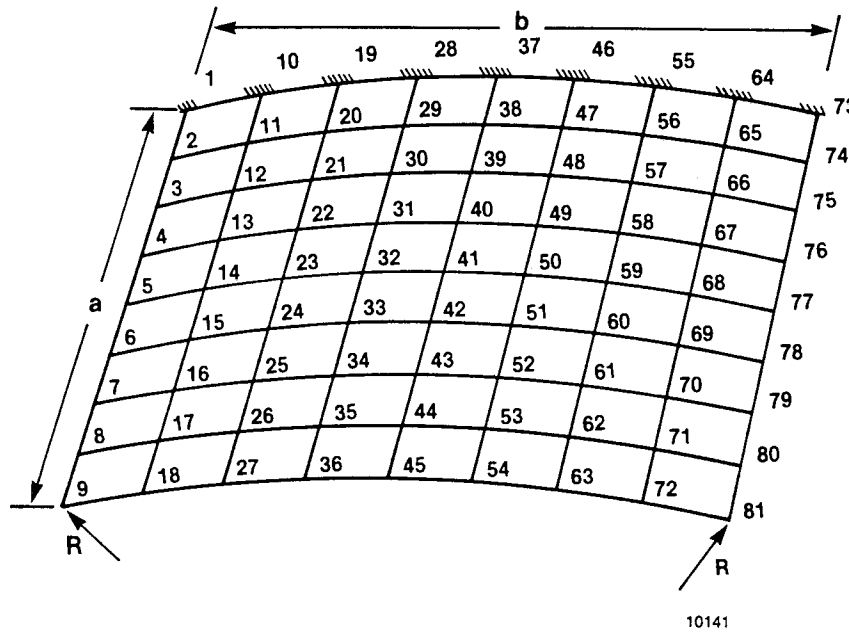

Figure 12. Finite element model of cylindrical shell.

Important data parameters:

Side length, a, b	= 10
Radius, r	= 20
Thickness, t	= 0.1
Young's modulus, E	= 29.5×10^6
Poisson's ratio, μ	= 0.3
Mass density, ρ	= 0.733×10^{-3}

STARS input data:

SHELL ELEMENT 8 BY 8 CURVED SHELL FREE VIBRATION ANALYSIS

81, 64, 1, 4, 0, 1, 0, 0, 0, 0
 0, 0, 0, 1, 0, 0, 0, 0, 0
 1, 1, 0, 1, 0, 0, 0, 0, 0
 2, 0, 2, 0, 1
 1, 6, 0, 90000.0, 0.0, 0.0

\$ NODAL DATA

1	0.0	0.0	0.0	1	1	1	1	1	1	0	0	0
2	1.25	0.0	0.0	0	0	0	0	0	0	0	0	0
9	10.0	0.0	0.0	0	0	0	0	0	0	0	0	1
10	0.0	1.25	0.2803754	1	1	1	1	1	1	0	0	0
11	1.25	1.25	0.2803754	0	0	0	0	0	0	0	0	0
18	10.0	1.25	0.2803754	0	0	0	0	0	0	0	0	1
19	0.0	2.5	0.478218	1	1	1	1	1	1	0	0	0
20	1.25	2.5	0.478218	0	0	0	0	0	0	0	0	0
27	10.0	2.5	0.478218	0	0	0	0	0	0	0	0	1
28	0.0	3.75	0.5959826	1	1	1	1	1	1	0	0	0
29	1.25	3.75	0.5959826	0	0	0	0	0	0	0	0	0
36	10.0	3.75	0.5959826	0	0	0	0	0	0	0	0	1
37	0.0	5.0	0.6350833	1	1	1	1	1	1	0	0	0
38	1.25	5.0	0.6350833	0	0	0	0	0	0	0	0	0
45	10.0	5.0	0.6350833	0	0	0	0	0	0	0	0	1
46	0.0	6.25	0.5959826	1	1	1	1	1	1	0	0	0
47	1.25	6.25	0.5959826	0	0	0	0	0	0	0	0	0
54	10.0	6.25	0.5959826	0	0	0	0	0	0	0	0	1
55	0.0	7.5	0.478218	1	1	1	1	1	1	0	0	0
56	1.25	7.5	0.478218	0	0	0	0	0	0	0	0	0
63	10.0	7.5	0.478218	0	0	0	0	0	0	0	0	1
64	0.0	8.75	0.2803754	1	1	1	1	1	1	0	0	0
65	1.25	8.75	0.2803754	0	0	0	0	0	0	0	0	0
72	10.0	8.75	0.2803754	0	0	0	0	0	0	0	0	1
73	0.0	10.0	0.0	1	1	1	1	1	1	0	0	0
74	1.25	10.0	0.0	0	0	0	0	0	0	0	0	0
81	10.0	10.0	0.0	0	0	0	0	0	0	0	0	1

\$ ELEMENT CONNECTIVITY

2	1	1	2	11	10	0	0	0	0	1	1	
2	8	8	9	18	17	0	0	0	0	1	1	0
2	9	10	11	20	19	0	0	0	0	1	1	0
2	16	17	18	27	26	0	0	0	0	1	1	0
2	17	19	20	29	28	0	0	0	0	1	1	0
2	24	26	27	36	35	0	0	0	0	1	1	0
2	25	28	29	38	37	0	0	0	0	1	1	0
2	32	35	36	45	44	0	0	0	0	1	1	0
2	33	37	38	47	46	0	0	0	0	1	1	0
2	40	44	45	54	53	0	0	0	0	1	1	0
2	41	46	47	56	55	0	0	0	0	1	1	0
2	48	53	54	63	62	0	0	0	0	1	1	0
2	49	55	56	65	64	0	0	0	0	1	1	0
2	56	62	63	72	71	0	0	0	0	1	1	0
2	57	64	65	74	73	0	0	0	0	1	1	0
2	64	71	72	81	80	0	0	0	0	1	1	0

\$ SHELL ELEMENT THICKNESSES

1 0.1

\$ ELEMENT MATERIAL PROPERTIES

1 1

0.2950E+080.3000E+000.0000E+000.7332E-03

STARS output summary - The output summary is presented in table 6.

Table 6. Natural frequencies of a cylindrical cantilever shell.

Mode	Natural frequency ω , rad/sec	Nondimensional parameter $\gamma = \omega a^2 \sqrt{\rho t/D}$
1	686.0745	11.30
2	1108.5908	18.26
3	1918.0797	31.60
4	2703.7155	44.54
5	2962.7536	48.81
6	3904.4432	64.32

4.6 General Solid: Vibration Analysis

A cube idealized by hexahedral solid elements is shown in figure 13. The nodes lying in the X-Y plane are assumed to be fixed. Details of the natural frequency analysis of the cube are presented herein.

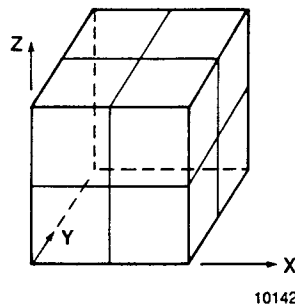

Figure 13. Cube discretized by hexahedral elements.

Important data parameters:

- Side length, ℓ = 10
- Young's modulus, E = 10×10^6
- Poisson's ratio, μ = 0.3
- Mass density, ρ = 2.349×10^{-4}

STARS input data:

```

HEXAHEDRON CASE - 2 BY 2
27,8,1,4,0,0,0,0,0,0
0,0,0,1,0,0,0,0,0
1,1,0,1,0,0,0,0,0
2,0,2,0,1
1,6,0,150000.0,0.0,0.0
$ NODAL DATA
 1  00.0  00.0  00.0  1  1  1  1  1  1  1
 2  5.0  00.0  00.0  1  1  1  1  1  1  1
 3  10.0  00.0  00.0  1  1  1  1  1  1  1
 4  10.0  5.0  00.0  1  1  1  1  1  1  1
 5  10.0  10.0  00.0  1  1  1  1  1  1  1
 6  5.0  10.0  00.0  1  1  1  1  1  1  1
 7  00.0  10.0  00.0  1  1  1  1  1  1  1
 8  00.0  5.0  00.0  1  1  1  1  1  1  1
 9  5.0  5.0  00.0  1  1  1  1  1  1  1
10  00.0  00.0  5.0  1  1  1  1  1  1  1
11  5.0  00.0  5.0  1  1  1  1  1  1  1
12  10.0  00.0  5.0  1  1  1  1  1  1  1
13  10.0  5.0  5.0  1  1  1  1  1  1  1
14  10.0  10.0  5.0  1  1  1  1  1  1  1
15  5.0  10.0  5.0  1  1  1  1  1  1  1
16  00.0  10.0  5.0  1  1  1  1  1  1  1
17  00.0  5.0  5.0  1  1  1  1  1  1  1
18  5.0  5.0  5.0  1  1  1  1  1  1  1
19  00.0  00.0  10.0  1  1  1  1  1  1  1
20  5.0  00.0  10.0  1  1  1  1  1  1  1
21  10.0  00.0  10.0  1  1  1  1  1  1  1
22  10.0  5.0  10.0  1  1  1  1  1  1  1
23  10.0  10.0  10.0  1  1  1  1  1  1  1
24  5.0  10.0  10.0  1  1  1  1  1  1  1
25  00.0  10.0  10.0  1  1  1  1  1  1  1
26  00.0  5.0  10.0  1  1  1  1  1  1  1
27  5.0  5.0  10.0  1  1  1  1  1  1  1
$ ELEMENT CONNECTIVITY
 4  1  1  2  9  8  10  11  18  17  1
 4  2  2  3  4  9  11  12  13  18  1
 4  3  9  4  5  6  18  13  14  15  1
 4  4  8  9  6  7  17  18  15  16  1
 4  5  10  11  18  17  19  20  27  26  1
 4  6  11  12  13  18  20  21  22  27  1
 4  7  18  13  14  15  27  22  23  24  1
 4  8  17  18  15  16  26  27  24  25  1
$ ELEMENT MATERIAL PROPERTIES
 1  1
 1.0E+7  0.3  0.0  2.349E-4

```

STARS output summary - The output summary is presented in table 7.

Table 7. Natural frequencies of a solid cube.

Mode	Natural frequency parameter $\hat{\omega} = \omega \sqrt{(E/\rho)}$, rad/sec			Exact solution $\hat{\omega}$
	Mesh size			
	2 by 2	4 by 4	6 by 6	
1	0.07975	0.07195	0.06958	0.06801
2	0.07975	0.07195	0.06958	0.06801
3	0.1315	0.1043	0.09762	0.09288
4	0.1720	0.1645	0.1623	0.1611
5	0.2280	0.1933	0.1850	0.1819
6	0.2280	0.1933	0.1850	0.1819

4.7 Spinning Cantilever Beam: Vibration Analysis

A cantilever beam spinning about the Y-axis is shown in figure 14.

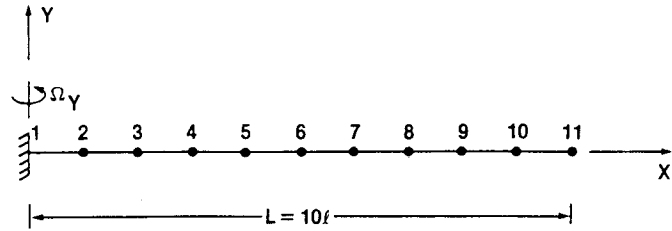

10143

Figure 14. Spinning cantilever beam.

Important data parameters - The structure is assumed to possess both viscous and structural damping.

Young's modulus, E	= 30×10^6
Cross-sectional area, A	= 1.0
Moment of inertia:	
About Y-axis	= 1/12
About Z-axis	= 1/24
Element length, ℓ	= 6
Nodal translational mass	= 1
Nodal mass moment of inertia	= 1/35
Scalar viscous damping	= 0.628318
Structural damping coefficient	= 0.01
Spin rate, Hz	= 0.1

STARS input data:

SPINNING CANTILEVER BEAM - 10-ELEMENT IDEALIZATION - VISC AND STRUCT DAMPING

12,10,1,4,1,0,0,0,0,0
 0,0,1,1,0,0,0,0,0
 5,0,0,0,0,1,0,0
 2,0,2,0,1
 1,6,0,500.0,0.0,0.0
 0.01

\$ NODAL DATA

1	0.0	0.0	0.0	1	1	1	1	1	1
2	6.0	0.0	0.0	0	0	0	0	0	0
3	12.0	0.0	0.0	0	0	0	0	0	0
4	18.0	0.0	0.0	0	0	0	0	0	0
5	24.0	0.0	0.0	0	0	0	0	0	0
6	30.0	0.0	0.0	0	0	0	0	0	0
7	36.0	0.0	0.0	0	0	0	0	0	0
8	42.0	0.0	0.0	0	0	0	0	0	0
9	48.0	0.0	0.0	0	0	0	0	0	0
10	54.0	0.0	0.0	0	0	0	0	0	0
11	60.0	0.0	0.0	0	0	0	0	0	0
12	25.0	15.0	0.0	1	1	1	1	1	1

\$ ELEMENT CONNECTIVITY

1	1	1	2	12	0	0	0	0	0	1	1	0	0	1	0
1	10	10	11	12	0	0	0	0	0	1	1	0	0	1	1

\$ LINE ELEMENT BASIC PROPERTIES

1 1.0 0.125000,083333330,04166667

\$ ELEMENT MATERIAL PROPERTIES

1 1
 30.0E+06 0.30

\$ ELEMENT SPIN RATE DATA

1 0.0 0.628318 0.0

\$ NODAL MASS DATA

2	1	1.0	3
3	1	1.0	3
4	1	1.0	3
5	1	1.0	3
6	1	1.0	3
7	1	1.0	3
8	1	1.0	3
9	1	1.0	3
10	1	1.0	3
11	1	1.0	3
2	4	0.0285714	6
3	4	0.0285714	6
4	4	0.0285714	6
5	4	0.0285714	6
6	4	0.0285714	6
7	4	0.0285714	6
8	4	0.0285714	6
9	4	0.0285714	6
10	4	0.0285714	6
11	4	0.0285714	6

\$ VISCOUS DAMPING DATA

0.0000E+000,0000E+000,0000E+000,0000E+000,0000E+000,0000E+000,0000E+000
 0.628318000,628318000,628318000,628318000,628318000,628318000,628318000
 0.628318000,628318000,628318000,628318000,628318000,628318000,628318000
 0.628318000,628318000,628318000,628318000,628318000,628318000,628318000
 0.628318000,628318000,628318000,628318000,628318000,628318000,628318000
 0.628318000,628318000,628318000,628318000,628318000,628318000,628318000
 0.628318000,628318000,628318000,628318000,628318000,628318000,628318000
 0.628318000,628318000,628318000,628318000,628318000,628318000,628318000
 0.628318000,628318000,628318000,628318000,628318000,628318000,628318000
 0.0000E+000,0000E+000,0000E+000,0000E+000,0000E+000,0000E+000,0000E+000

STARS output summary - The output summary is presented in table 8.

Table 8. Spinning cantilever beam.

Mode	Structure without damping, IPROB = 2	Structure with viscous damping, IPROB = 4	Structure with viscous and structural damping, IPROB = 5
1	2.5263	-.3107 ± 2.4886i*	-.3195 ± 2.4820i*
2	3.4481	-.3116 ± 3.4200i*	-.3255 ± 3.4123i*
3	15.3964	-.3169 ± 15.3865i*	-.3930 ± 15.3831i*
4	21.7055	-.3166 ± 21.7002i*	-.4243 ± 21.6912i*
5	43.1614	-.3202 ± 43.1398i*	-.4848 ± 43.0627i*
6	60.9511	-.3202 ± 60.9491i*	-.6246 ± 60.9390i*

Note: Natural frequencies for various problem types are due to a spin rate $\Omega = 0.1$ Hz (0.6283 rad/sec) ($i^* = \sqrt{-1}$).

4.8 Spinning Cantilever Plate: Vibration Analysis

The cantilever plate model described in section 4.4 is chosen for this sample problem. The plate is spun along the Z-axis with a uniform spin rate $\Omega_Z = 0.8 \cdot \omega_n^1$, ω_n^1 being the first natural frequency of vibration of the nonrotating plate. Table 9 provides the first few natural frequencies of the plate in nondimensional form, ω being the natural frequencies. Also presented in the table are the results of the free vibration analysis of the plate rotating along an arbitrary axis, the spin rate being $\Omega_R \approx 0.8 \times \omega_n^1$, with components $\Omega_X = \Omega_Y = \Omega_Z \approx 0.8 \omega_n^1 / \sqrt{3}$.

STARS input data:

```

SQUARE 4 BY 4 PLATE   SPINNING STRUCTURE
25,16,1,4,0,1,0,0,0,0
0,0,1,1,0,0,0,0,0
2,0,0,1,0,0,0,0
2,0,2,0,1
1,6,0,6000.0,0.0,0.0
$ NODAL DATA
  1   -5.0    0.0    0.0    1    1    1    1    1    1    0    0    0
  5    5.0    0.0    0.0    1    1    1    1    1    1    0    0    1
  6   -5.0    2.5    0.0    0    0    0    0    0    0    0    0    0
 10    5.0    2.5    0.0    0    0    0    0    0    0    0    0    1
 11   -5.0    5.0    0.0    0    0    0    0    0    0    0    0    0
 15    5.0    5.0    0.0    0    0    0    0    0    0    0    0    1
 16   -5.0    7.5    0.0    0    0    0    0    0    0    0    0    0
 20    5.0    7.5    0.0    0    0    0    0    0    0    0    0    1
 21   -5.0   10.0    0.0    0    0    0    0    0    0    0    0    0
 25    5.0   10.0    0.0    0    0    0    0    0    0    0    0    1
$ ELEMENT CONNECTIVITY
  2  1  1  2  7  6  0  0  0  0  1  1  0  0  1
  2  4  4  5 10  9  0  0  0  0  1  1  0  0  1  1
  2  5  6  7 12 11  0  0  0  0  1  1  0  0  1
  2  8  9 10 15 14  0  0  0  0  1  1  0  0  1  1
  2  9 11 12 17 16  0  0  0  0  1  1  0  0  1
  2 12 14 15 20 19  0  0  0  0  1  1  0  0  1  1
  2 13 16 17 22 21  0  0  0  0  1  1  0  0  1
  2 16 19 20 25 24  0  0  0  0  1  1  0  0  1  1
$ SHELL ELEMENT THICKNESSES
  1  0.1
$ ELEMENT MATERIAL PROPERTIES
  1  1
  1.0E+07  0.30  0.0  0.259E-3
$ ELEMENT SPIN RATE DATA
  1  0.  0.  170.86

```

STARS output summary - The output is presented in table 9.

Table 9. Natural frequency parameters of a spinning square cantilever plate.

Mode	Natural frequency parameter $\gamma = \omega \ell^2 \sqrt{\rho t/D}$			
	$\Omega_Z = 0.8\omega \frac{1}{N}$ = 100.00 rad/sec		$\Omega_R = 170.86$ rad/sec, $\Omega_X = \Omega_Y = \Omega_Z = 57.735$ rad/sec	
	ω	γ	ω	γ
1	233.57	3.9286	146.36	2.4617
2	534.17	8.9845	494.34	8.3146
3	1268.30	21.3323	1248.60	21.0009
4	1562.00	26.2722	1543.26	25.9570
5	1784.80	30.0196	1768.80	29.7505
6	2912.50	48.9871	2898.28	48.7479

4.9 Helicopter Structure: Vibration Analysis

A coupled helicopter rotor-fuselage system is shown in figure 15 (ref. 12) along with relevant stiffness and mass distributions, which are suitably approximated for the discrete element modeling of the structure. Numerical free vibration analysis was performed for the structure with the rotor spinning at 10 rad/sec ($\Omega \gamma = 10$); such results are presented in table 10, along with the results for the corresponding nonspinning case.

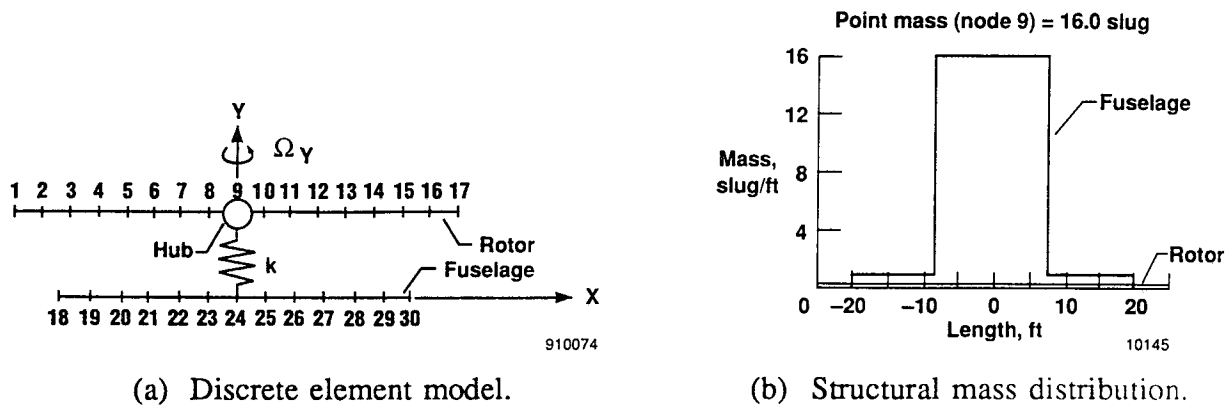

Figure 15. Coupled helicopter rotor-fuselage system.

STARS input data:

HELICOPTER STRUCTURE, JOURNAL CASE, SPIN = 10.0 (FIXED UZ, UXR, UYR)

31,29,7,4,2,0,0,0,0,0

0,0,1,0,0,0,0,0,0

2,0,0,1,0,1,0,0

2,0,2,0,1

1,12,0,53,15,0,0,0,0

\$ NODAL DATA

1	-25.00000	1.0	0.0	0	0	1	1	1	0	0		
8	-3.12500	1.0	0.0	0	0	1	1	1	0	0	0	1
9	0.00000	1.0	0.0	0	0	1	1	1	0	0		
10	3.12500	1.0	0.0	0	0	1	1	1	0	0		
17	25.00000	1.0	0.0	0	0	1	1	1	0	0	0	1
18	-20.00000	0.0	0.0	0	0	1	1	1	0	0		
23	-3.33333	0.0	0.0	0	0	1	1	1	0	0	0	1
24	0.00000	0.0	0.0	0	0	1	1	1	0	0		
25	3.33333	0.0	0.0	0	0	1	1	1	0	0		
30	20.00000	0.0	0.0	0	0	1	1	1	0	0	0	1
31	10.00000	0.5	0.0	1	1	1	1	1	1	0		

\$ ELEMENT CONNECTIVITY

1	1	1	2	24			1	1	0	0	1	0
1	16	16	17	24			1	1	0	0	1	1
1	17	18	19	9			2	1				
1	18	19	20	9			2	1				
1	19	20	21	9			3	1				
1	20	21	22	9			4	1				
1	21	22	23	9			5	1				
1	22	23	24	9			6	1				
1	23	24	25	9			6	1				
1	24	25	26	9			5	1				
1	25	26	27	9			4	1				
1	26	27	28	9			3	1				
1	27	28	29	9			2	1				
1	28	29	30	9			2	1				
1	29	9	24	31			7	2				

\$ LINE ELEMENT BASIC PROPERTIES

1	1.	1.	1.	1.	1.
2	100.	1.	1.	1.	1.

\$ ELEMENT MATERIAL PROPERTIES

1	1				
2	1	2.0E05	0.3	0.	0.3
3	1	1.53E06	0.3	0.	1.23
4	1	2.E06	0.3	0.	1.23
5	1	4.8E06	0.3	0.	8.6
6	1	7.8E06	0.3	0.	16.
7	1	11.E06	0.3	0.	16.
8	1	1.E08	0.3	0.	0.

\$ ELEMENT SPIN RATE DATA

1	0.0	10.0	0.0
---	-----	------	-----

\$ NODAL MASS DATA

9	1	16.	3
---	---	-----	---

-1

STARS output summary - The output summary is presented in table 10.

Table 10. Natural frequencies of a helicopter structure.

Mode number	Natural frequencies, spin rates		Mode shape
	$\Omega_{Y=0}$	$\Omega_{Y=10}$	
1,2,3	0	0	Rigid body
4	4.642	11.789	Rotor 1st symmetric bending
5	5.041	11.793	Rotor 1st antisymmetric bending
6	22.138	22.229	Fuselage 1st bending
7	27.892	36.199	Rotor 2nd antisymmetric bending
8	28.278	37.800	Rotor 2nd symmetric bending
9	37.176	38.478	Rotor 3rd antisymmetric bending

4.10 Rocket Structure: Dynamic Response Analysis

A rocket is simply idealized by four line elements, as shown in figure 16 (ref. 4), which is subjected to a pulse loading function at the base. Results of the dynamic response analysis are shown in figures 17 and 18.

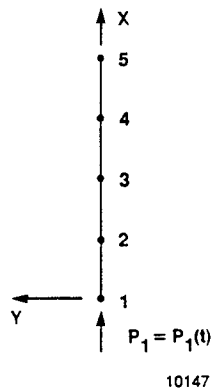

(a) Rocket structure.

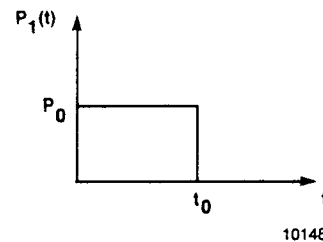

(b) Pulse loading.

Figure 16. Rocket subjected to dynamic loading.

Important data parameters - Arbitrary element and material properties data are assumed for the analysis to correlate results with available ones expressed in parametric form.

Young's modulus, E = 100
 Poisson's ratio, μ = 0.3
 Cross-sectional area, A = 1.0
 Mass density, ρ = 1.0

Length of an element, ℓ = 2.5
 Pulse load intensity, P_0 = 10.0
 Duration of load, sec = 1.0
 Total time period for response evaluation = 2.0

STARS input data:

```

DYNAMIC RESPONSE CASE - PRZEMIENIECKI
6,4,1,4,1,0,0,0,0,0
0,0,0,0,0,0,0,0,0,0
1,0,1,1,0,0,0,0,0
2,0,2,0,1
1,3,0,20,0,0,0,0,0
0,1,1,2
$ NODAL DATA
  1      0.0      0.0      0.0  0  1  1  1  1  1
  5     10.0      0.0      0.0  0  1  1  1  1  1  0  0  1
  6      5.0      5.0      0.0  1  1  1  1  1  1
$ ELEMENT CONNECTIVITY
  1  1  1  2  6  0  0          1  1
  1  4  4  5  6  0  0          1  1  0  0  0  1
$ LINE ELEMENT BASIC PROPERTIES
  1      1.0      0.0      0.0      0.0
$ ELEMENT MATERIAL PROPERTIES
  1  1
    100.0      0.3      0.0      1.0
$ DYNAMIC NODAL FORCE DATA
    1.0
  1  1      10.0
  -1
$ INCREMENTAL TIME DATA FOR DYNAMIC RESPONSE ANALYSIS
    0.10  10
    0.20   5
  
```

STARS analysis results at a typical time step:

DYNAMIC RESPONSE AT TIME = 0.7000E+00

NODE		X-DISPL.	Y-DISPL.	Z-DISPL.	X-ROTN.	Y-ROTN.	Z-ROTN.
EXT	INT						
1	1	0.646322E+00	0.000000E+00	0.000000E+00	0.000000E+00	0.000000E+00	0.000000E+00
2	2	0.490999E+00	0.000000E+00	0.000000E+00	0.000000E+00	0.000000E+00	0.000000E+00
3	3	0.191562E+00	0.000000E+00	0.000000E+00	0.000000E+00	0.000000E+00	0.000000E+00
4	4	-0.102987E-02	0.000000E+00	0.000000E+00	0.000000E+00	0.000000E+00	0.000000E+00
5	5	-0.495080E-01	0.000000E+00	0.000000E+00	0.000000E+00	0.000000E+00	0.000000E+00
6	6	0.000000E+00	0.000000E+00	0.000000E+00	0.000000E+00	0.000000E+00	0.000000E+00

ELEMENT STRESSES

ELEMENT NO.	END1	END2	END3	END4	PX1/PX2		PY1/PY2		PZ1/PZ2		MX1/MX2		MY1/MY2		MZ1/MZ2	
					SXT	SXX	SYT	SYX	SZT	SZZ	SXB	SXY	SYB	SYZ	SXB	SXY
1	1	2			-0.196400E+02	0.000000E+00	0.000000E+00	0.000000E+00	0.000000E+00	0.000000E+00	0.000000E+00	0.000000E+00	0.000000E+00	0.000000E+00	0.000000E+00	0.000000E+00
			END5	END6	END7	END8	0.196400E+02	0.000000E+00	0.000000E+00	0.000000E+00	0.000000E+00	0.000000E+00	0.000000E+00	0.000000E+00	0.000000E+00	0.000000E+00
2	2	3			0.119775E+02	0.000000E+00	0.000000E+00	0.000000E+00	0.000000E+00	0.000000E+00	0.000000E+00	0.000000E+00	0.000000E+00	0.000000E+00	0.000000E+00	
			END5	END6	END7	END8	-0.119775E+02	0.000000E+00	0.000000E+00	0.000000E+00	0.000000E+00	0.000000E+00	0.000000E+00	0.000000E+00	0.000000E+00	0.000000E+00
3	3	4			0.770366E+01	0.000000E+00	0.000000E+00	0.000000E+00	0.000000E+00	0.000000E+00	0.000000E+00	0.000000E+00	0.000000E+00	0.000000E+00	0.000000E+00	
			END5	END6	END7	END8	-0.770366E+01	0.000000E+00	0.000000E+00	0.000000E+00	0.000000E+00	0.000000E+00	0.000000E+00	0.000000E+00	0.000000E+00	0.000000E+00
4	4	5			0.193913E+01	0.000000E+00	0.000000E+00	0.000000E+00	0.000000E+00	0.000000E+00	0.000000E+00	0.000000E+00	0.000000E+00	0.000000E+00	0.000000E+00	
			END5	END6	END7	END8	-0.193913E+01	0.000000E+00	0.000000E+00	0.000000E+00	0.000000E+00	0.000000E+00	0.000000E+00	0.000000E+00	0.000000E+00	0.000000E+00

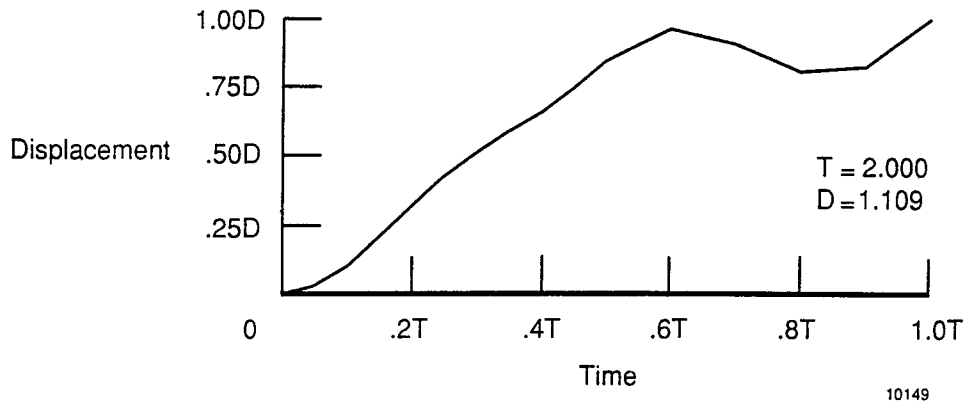

Figure 17. Nodal displacement as a function of time, node 1.

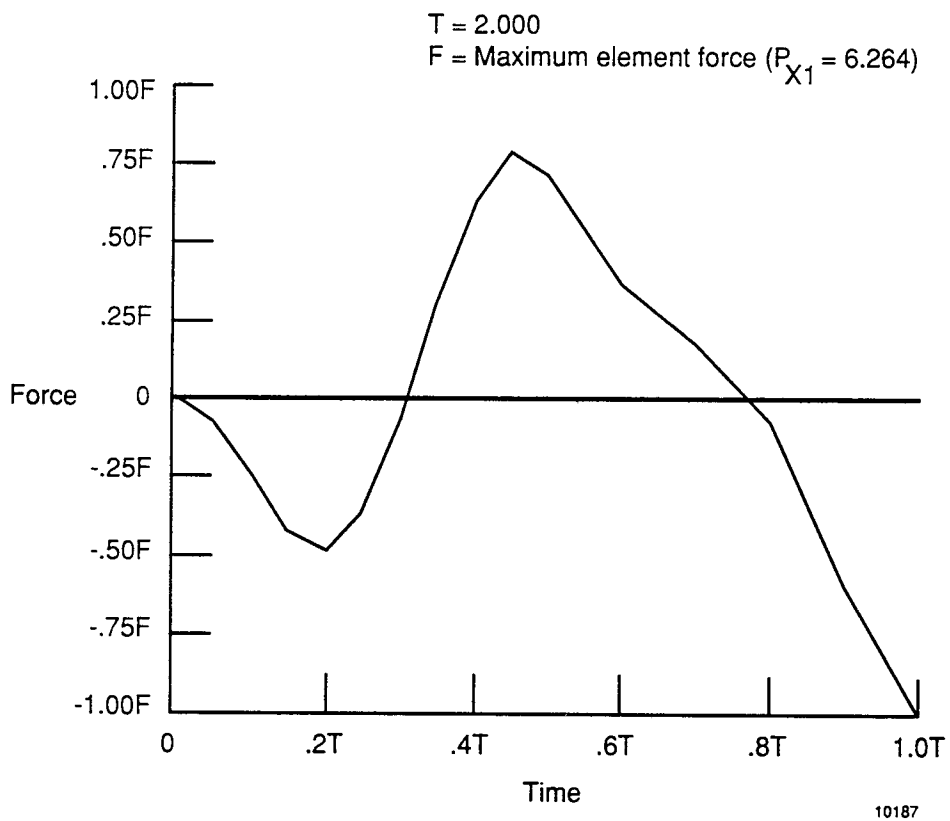

Figure 18. Element force as a function of time, element 4.

4.11 Plate, Beam, and Truss Structures: Buckling Analysis

A buckling analysis was performed for a simply supported square plate model, described in section 4.4, subjected to a uniform unit stress acting along the two edges parallel to the y-axis; relevant input data and analysis results are as follows.

STARS input data:

```

SQUARE 4 BY 4 PLATE,BC W=0, midline x=0,Y(13)=0, BUCKLING ANALYSIS
25,16,1,4,0,1,0,0,0,0
0,0,0,1,0,0,0,0,0
9,1,0,1,1,0,0,0
2,0,2,0,1
1,1,0,20000.0,0,0,0,0
$ NODAL DATA
  1  -5.00  0.0  0.0  0  0  0  1  0  0  1  0  0  0  0
  2  -2.50  0.0  0.0  0  0  0  1  0  0  1  0  0  0  0
  3   0.0  0.0  0.0  0  1  0  1  0  0  1  0  0  0  0
  4   2.50  0.0  0.0  0  0  0  1  0  0  1  0  0  0  0
  5   5.00  0.0  0.0  0  0  0  1  0  0  1  0  0  0  0
  6  -5.00  2.50  0.0  0  0  0  1  0  0  1  0  0  0  0
  7  -2.50  2.50  0.0  0  0  0  0  0  0  1  0  0  0  0
  8   0.0  2.5  0.0  1  0  0  0  0  0  1  0  0  0  0
  9   2.50  2.50  0.0  0  0  0  0  0  0  1  0  0  0  0
 10   5.00  2.50  0.0  0  0  0  1  0  0  1  0  0  0  0
 11  -5.00  5.00  0.0  0  0  0  1  0  0  1  0  0  0  0
 12  -2.50  5.00  0.0  0  0  0  0  0  0  1  0  0  0  0
 13   0.0  5.00  0.0  1  1  0  0  0  0  1  0  0  0  0
 14   2.50  5.00  0.0  0  0  0  0  0  0  1  0  0  0  0
 15   5.00  5.00  0.0  0  0  0  1  0  0  1  0  0  0  0
 16  -5.00  7.50  0.0  0  0  0  1  0  0  1  0  0  0  0
 17  -2.50  7.50  0.0  0  0  0  0  0  0  1  0  0  0  0
 18   0.0  7.5  0.0  1  0  0  0  0  0  1  0  0  0  0
 19   2.50  7.50  0.0  0  0  0  0  0  0  1  0  0  0  0
 20   5.00  7.50  0.0  0  0  0  1  0  0  1  0  0  0  0
 21  -5.00 10.00  0.0  0  0  0  1  0  0  1  0  0  0  0
 22  -2.50 10.00  0.0  0  0  0  1  0  0  1  0  0  0  0
 23   0.0 10.0  0.0  1  0  1  0  0  0  1  0  0  0  0
 24   2.50 10.00  0.0  0  0  0  1  0  0  1  0  0  0  0
 25   5.00 10.00  0.0  0  0  0  1  0  0  1  0  0  0  0
$ ELEMENT CONNECTIVITY
  2  1  1  2  7  6  0  0  0  0  1  1  0  0  0
  2  4  4  5 10  9  0  0  0  0  1  1  0  0  0  1
  2  5  6  7 12 11  0  0  0  0  1  1  0  0  0
  2  8  9 10 15 14  0  0  0  0  1  1  0  0  0  1
  2  9 11 12 17 16  0  0  0  0  1  1  0  0  0
  2 12 14 15 20 19  0  0  0  0  1  1  0  0  0  1
  2 13 16 17 22 21  0  0  0  0  1  1  0  0  0
  2 16 19 20 25 24  0  0  0  0  1  1  0  0  0  1
$ SHELL ELEMENT THICKNESSES
  1  0.1
$ ELEMENT MATERIAL PROPERTIES
  1  1
  1.0E+07  0.30
$ NODAL LOAD DATA
  1  1  .125
  6  1  .250
 11  1  .250
 16  1  .250
 21  1  .125
  5  1  -.125
 10  1  -.250
 15  1  -.250
 20  1  -.250
 25  1  -.125
-1

```

STARS analytical results - The analytical results pertaining to the buckling load are presented in table 11.

Table 11. Critical load of a simply supported square plate.

Buckling load parameter for Mode 1			
STARS solution			Exact solution
4 by 4	8 by 8	14 by 14	
3552.892	3562.814	3575.978	3615.240

The cantilever beam defined in section 4.7 is the subject of the buckling analysis; the relevant details are given below.

STARS input data:

```

CANTILEVER BEAM - 10-ELEMENT IDEALIZATION - BUCKLING ANALYSIS
C
C TEMPERATURE LOADING ADDED
C
12,10,1,4,1,0,0,0,0,0
1,0,0,1,0,0,0,0,0,0
9,1,0,1,1,0,0,0,0
2,0,2,0,1
1,1,0,12000.0,0,0,0,0,0
$ NODAL DATA
  1   0.0   0.0   0.0   1   1   1   1   1   1
  2   6.0   0.0   0.0   0   0   1   1   1   0
  3  12.0   0.0   0.0   0   0   1   1   1   0
  4  18.0   0.0   0.0   0   0   1   1   1   0
  5  24.0   0.0   0.0   0   0   1   1   1   0
  6  30.0   0.0   0.0   0   0   1   1   1   0
  7  36.0   0.0   0.0   0   0   1   1   1   0
  8  42.0   0.0   0.0   0   0   1   1   1   0
  9  48.0   0.0   0.0   0   0   1   1   1   0
 10  54.0   0.0   0.0   0   0   1   1   1   0
 11  60.0   0.0   0.0   0   1   1   1   1   0
 12  25.0  15.0   0.0   1   1   1   1   1   1
$ ELEMENT CONNECTIVITY
  1   1   1   2  12   0   0   0   0   1   1   1   0   0   0
  1  10  10  11  12   0   0   0   0   1   1   1   0   0   1
$ LINE ELEMENT BASIC PROPERTIES
  1   1.0   0.125 0.083333 0.041667
$ ELEMENT MATERIAL PROPERTIES
  1   1
 30.0E+06   0.30  6.6E-06
$ ELEMENT TEMPERATURE DATA
  1   -1.0
$ NODAL LOAD DATA
 11   1   -1.0
-1

```

STARS analytical results - The analytical results are presented in table 12.

Table 12. Critical load of a cantilever beam.

Mode	Buckling load parameter	
	STARS solution	Exact solution
1	35.2320	35.2282

The simple truss of figure 19 (ref. 4) is also analyzed to determine the critical loads. The associated input data and analytical results are given below.

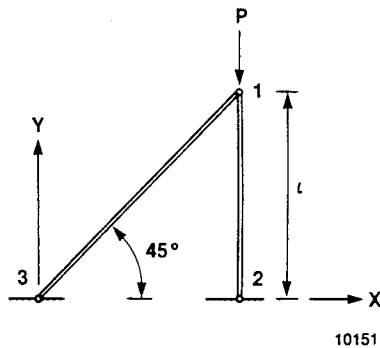

Figure 19. Truss structure.

STARS input data:

```

PRZ - TRUSS BUCKLING ANALYSIS
4,2,1,4,1,0,0,0,0,0
0,0,0,1,0,0,0,0,0
9,0,0,1,1,0,0,0
2,0,2,0,1
1,2,0,20000.0,0,0,0,0,0
$ NODAL DATA
  1  100.0  100.0  0.0  0  0  1  1  1  1
  2  100.0   0.0  0.0  1  1  1  1  1  1
  3   0.0   0.0  0.0  1  1  1  1  1  1
  4   0.0   50.0  0.0  1  1  1  1  1  1
$ ELEMENT CONNECTIVITY
  1  1  3  1  4  1  1  0  0  0  1  1
  1  2  2  1  4  1  1  0  0  0  1  1
$ LINE ELEMENT BASIC PROPERTIES
  1  0.1
$ ELEMENT MATERIAL PROPERTIES
  1  1
  10.0E03  0.2
$ NODAL LOAD DATA
  1  2  -1.0
-1
    
```

STARS analytical results - The analytical results are presented in table 13.

Table 13. Critical load of a simple truss.

Mode	Buckling load parameter	
	STARS solution	Exact solution
1	261.20388	261.20387

4.12 Composite Plate Bending: Vibration Analysis

To illustrate the multiple material angle (as in layered elements), the diverse coordinate system capabilities, and thermal effects, a composite plate problem (fig. 20) similar to that in section 4.4 is considered for vibration analysis.

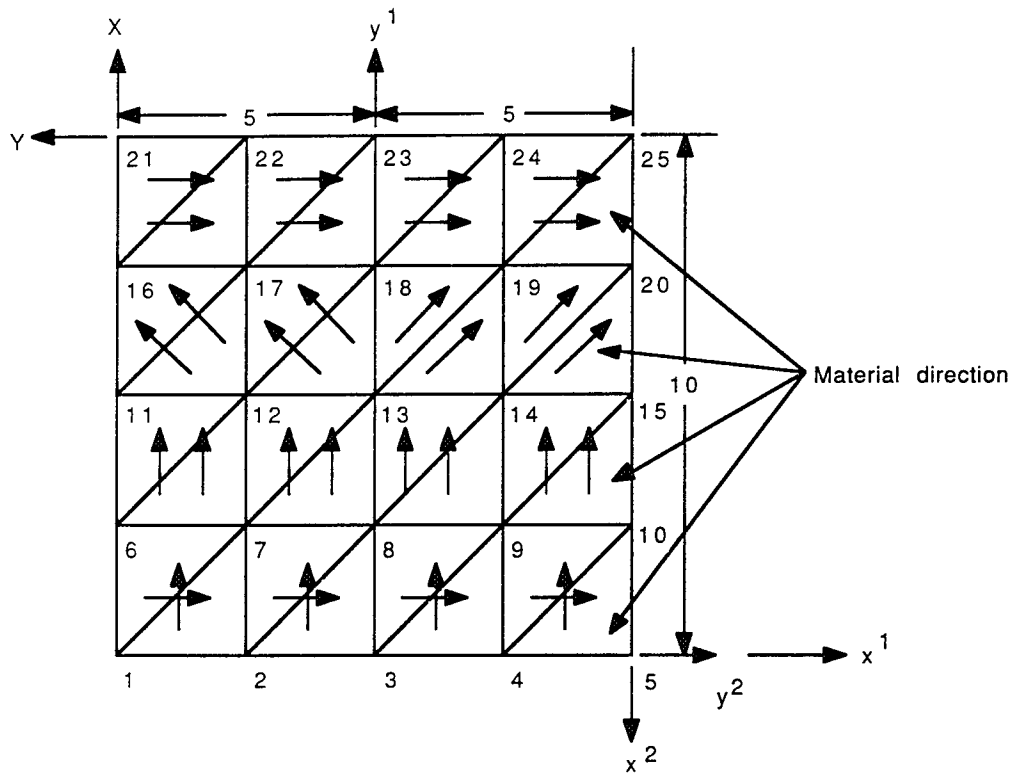

10152

Figure 20. Square composite plate.

Important data parameters:

- Side length, ℓ = 10
- Plate thickness, t = 0.063
- Mass density, ρ = 0.259×10^{-3}
- Material properties - anisotropic, as shown in input data.

STARS input data:

TRIANGULAR 4 BY 4 PLATE / COMPOSITE LAYERS / ILGCS TEST CASE / NMANGL TEST CASE

25, 32, 1, 13, 0, 0, 2, 8, 10, 2

1, 0, 0, 0, 0, 0, 0, 0, 0

1, 1, 0, 1, 0, 0, 0, 0, 0

2, 0, 2, 0, 1

1, 10, 0, 6000.0, 0.0, 0.0

\$ NODAL DATA

1	-5.0	0.0	0.0	1	1	1	1	1	1	1	0	0
5	5.0	0.0	0.0	1	1	1	1	1	1	1	0	1
6	-2.5	-10.0	0.0	0	0	0	0	0	0	2	0	0
10	-2.5	0.0	0.0	0	0	0	0	0	0	2	0	1
11	-5.0	5.0	0.0	0	0	0	0	0	0	1	0	0
15	5.0	5.0	0.0	0	0	0	0	0	0	1	0	1
16	-2.5	0.0	0.0	0	0	0	0	0	0	0	0	0
20	-2.5	-10.0	0.0	0	0	0	0	0	0	0	0	1
21	-5.0	10.0	0.0	1	1	1	1	1	1	1	0	0
25	5.0	10.0	0.0	1	1	1	1	1	1	1	0	1

\$ LOCAL-GLOBAL COORDINATE SYSTEM DATA

1	2											
		-10.0	-5.0	0.0	0.0	-1.0	0.0					
		1.0	0.0	0.0	0.0	0.0	1.0					
2	1											
		-10.0	-10.0	0.0	-15.0	-10.0	0.0					
		-15.0	-15.0	0.0								

\$ ELEMENT CONNECTIVITY

7	1	1	2	7	0	0	0	0	1	1	0	1	0	0	
7	4	4	5	10	0	0	0	0	1	1	0	1	0	0	1
7	5	6	7	12	0	0	0	0	2	1	0	1	0	0	
7	8	9	10	15	0	0	0	0	2	1	0	1	0	0	1
7	9	11	12	17	0	0	0	0	3	1	0	1	0	0	
7	10	12	13	18	0	0	0	0	3	1	0	1	0	0	
7	11	13	14	19	0	0	0	0	4	1	0	1	0	0	
7	12	14	15	20	0	0	0	0	4	1	0	1	0	0	
7	13	16	17	22	0	0	0	0	5	1	0	1	0	0	
7	16	19	20	25	0	0	0	0	5	1	0	1	0	0	1
7	17	7	6	1	0	0	0	0	6	1	0	1	0	0	
7	20	10	9	4	0	0	0	0	6	1	0	1	0	0	1
7	21	12	11	6	0	0	0	0	7	1	0	1	0	0	
7	24	15	14	9	0	0	0	0	7	1	0	1	0	0	1
7	25	17	16	11	0	0	0	0	8	1	0	1	0	0	
7	26	18	17	12	0	0	0	0	8	1	0	1	0	0	
7	27	19	18	13	0	0	0	0	9	1	0	1	0	0	
7	28	20	19	14	0	0	0	0	9	1	0	1	0	0	
7	29	22	21	16	0	0	0	0	10	1	0	1	0	0	
7	32	25	24	19	0	0	0	0	10	1	0	1	0	0	1

\$ COMPOSITE SHELL ELEMENT STACK DESCRIPTION DATA

1	2														
1		.0315	3												
1		.0315	1												
2	2														
1		.0315	3												
1		.0315	3												
3	2														
1		.0315	4												
1		.0315	4												
4	2														
1		.0315	2												
1		.0315	2												
5	2														
1		.0315	1												
1		.0315	1												
6	2														
1		.0315	6												
1		.0315	5												
7	2														
1		.0315	6												
1		.0315	6												
8	2														
1		.0315	7												
1		.0315	7												
9	2														
1		.0315	8												
1		.0315	8												
10	2														
1		.0315	5												
1		.0315	5												

\$ SPECIFICATION FOR MATERIAL AXIS ORIENTATION

```

1 2 0
0.0
2 2 0
0.7854
3 2 0
1.5708
4 2 0
2.3562
5 2 0
3.1416
6 2 9
4.7120
7 2 0
5.4980
8 2 0
3.9260
$ ELEMENT MATERIAL PROPERTIES
1 2
.7966E+07 .6638E+06 0.0 .2566E+07 0.0 0.125E+7 .1042E+7
0.0 .1042E+07 .35e-5 .114e-4 0.0 0.259E-3
$ ELEMENT TEMPERATURE DATA
1 10.

```

STARS output summary - The results are printed in table 14.

Table 14. Natural frequencies of a composite square cantilever plate.

Mode	Natural frequency ω , rad/sec	
	T = 0	T = 10
1	505.41	373.38
2	611.98	486.79
3	967.78	851.04
4	1434.66	1275.96
5	1523.71	1361.70
6	1765.22	1643.97

5. STARS-AERO AND ASE PROGRAM DESCRIPTION

The aeroelastic and aeroservoelastic modules (fig. 2) are recent additions to the original STARS program (ref. 1) that are capable of predicting related stability of such structures as aircraft and spacecraft. Thus, once the vibration analysis is performed utilizing the STARS-SOLIDS module, the program continues to determine flutter and divergence characteristics as well as open- and closed-loop stability analyses, as desired. In this connection, a typical feedback control system is shown in figure 21, whereas figure 22 presents a flowchart depicting the ASE analysis methodology. References 13 and 14 provide some details of the current analysis techniques.

Detailed numerical formulation in connection with the present aero-structural-control analysis is given in section 5.1. The unsteady aerodynamic forces for supersonic flow are computed by a constant pressure method (CPM) (ref. 15), whereas the doublet lattice method (DLM) (refs. 16,17) is utilized for the subsonic case. Both k and p-k stability (flutter and divergence) solution procedures are available to the user.

For the ASE analysis, the aerostructural problem is recast in the Laplace domain when the generalized aerodynamic forces are curve-fitted using Padé and least squares approximations, thereby yielding the state-space matrices. Such matrices can then be augmented by analog elements such as actuators, sensors, prefilters, and notch filters, and also the analog controller. Associated equivalent open-loop (loop-gain) or open-loop transfer function is obtained by standard procedure, whereas the closed-loop formulation is derived similarly by appropriately taking into account the feedback equation. The system frequency responses are simply obtained from the appropriate transfer matrices. Associated modal damping and frequency values may also be derived by solving the eigenvalue problem of the augmented state-space plant dynamics matrix.

In the case of a digital controller, a hybrid equivalent open-loop or closed-loop transfer function is achieved by suitably combining the controller, the open-loop transfer function of the original analog system of the plant, and other analog elements; frequency responses are then obtained in a routine manner. The modal damping and frequency values are obtained by first transferring the augmented analog state-space plant dynamics matrix from its usual Laplace (s) to the digital z-plane, adding the same to the corresponding matrix for the controller, and finally solving the associated eigenvalue problem.

Furthermore, the open-loop stability analyses (flutter and divergence) may also be effected with or without the controller (analog or digital). This is achieved by solving eigenvalue problems of the appropriately augmented and transformed, as the case may be, plant dynamics matrix for a number of reduced frequency values and noting the change in sign of the real part of the eigenvalues. Such a solution without a controller can be compared with the aeroelastic analysis using the k and p-k methods, whereas the relevant solution in the presence of a controller proves to be useful for comparing relevant flight test results of modern, high-performance, unstable aircraft.

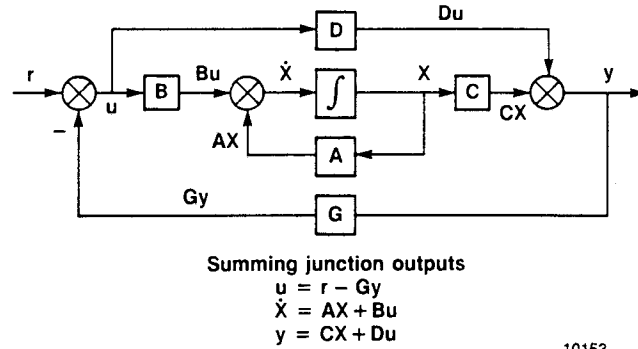

10153

Figure 21. Feedback control system.

5.1 Numerical Formulation for Aeroelastic and Aeroservoelastic Analysis

In the numerical formulation presented here, structural discretization is based on the finite element method, whereas the panel methods are adopted for computation of unsteady aerodynamic forces. The more specialized matrix equation of motion of such structures relevant to the current analysis has the form

$$\mathbf{M}\ddot{\mathbf{q}} + \mathbf{C}\dot{\mathbf{q}} + \mathbf{K}\mathbf{q} + \bar{q}\mathbf{A}_e(k)\mathbf{q} = \mathbf{P}(t) \quad (24)$$

in which relevant terms are defined as follows:

- M** inertia matrix,
- C** damping matrix,
- K** elastic stiffness matrix,
- \bar{q} dynamic pressure $1/2\rho V^2$, ρ and V being the air density and true airspeed, respectively,
- k reduced frequency $\omega b/V$, ω and b being the natural frequency and wing semichord length, respectively,
- $\mathbf{A}_e(k)$ aerodynamic influence coefficient matrix for a given Mach number M_∞ and set of k_j values,
- \mathbf{q} displacement vector,
- $\mathbf{P}(t)$ external forcing function, and
- s Laplace variable ($= i^*\omega$, i^* being $\sqrt{-1}$).

A solution (ref. 1) of the related free vibration problem

$$\mathbf{M}\ddot{\mathbf{q}} + \mathbf{k}\mathbf{q} = \mathbf{0} \quad (25)$$

yields the desired roots ω and vectors Φ . Next, applying a transformation

$$\mathbf{q} = \Phi\eta \quad (26)$$

to equation (24) and premultiplying both sides by Φ^T , the generalized equation of motion is derived as

$$\widehat{\mathbf{M}}\ddot{\boldsymbol{\eta}} + \widehat{\mathbf{C}}\dot{\boldsymbol{\eta}} + \widehat{\mathbf{K}}\boldsymbol{\eta} + \bar{q} \mathbf{Q}(k)\boldsymbol{\eta} = \widehat{\mathbf{P}}(t) \quad (27)$$

in which $\widehat{\mathbf{M}} = \Phi^T \mathbf{M} \Phi$, etc., the modal matrix $\Phi = [\Phi_r \ \Phi_e \ \Phi_\delta]$, and the generalized coordinate $\boldsymbol{\eta} = [\eta_r \ \eta_e \ \eta_\delta]$ incorporates rigid body, elastic, and control surface motions, respectively.

Expressing the generalized aerodynamic force matrix $\mathbf{Q}(k)$ as Padé polynomials (ref. 4) in i^*k ($=i^*\omega b/V = sb/V$) results in

$$\mathbf{Q}(k) = \mathbf{A}_0 + i^*k\mathbf{A}_1 + (i^*k)^2\mathbf{A}_2 + \frac{i^*k}{i^*k+\beta_1}\mathbf{A}_3 + \frac{i^*k}{i^*k+\beta_2}\mathbf{A}_4 + \dots \quad (28)$$

where β_j are the aerodynamic lag terms (assuming $j = 1, 2$), and

$$\frac{i^*k}{i^*k+\beta_j} = \frac{k^2}{k^2+\beta_j^2} + \frac{i^*k\beta_j}{k^2+\beta_j^2} \quad (28a)$$

Further, separating the real and imaginary parts in equation (28) yields

$$\begin{aligned} \widehat{\mathbf{Q}}_R(k) &= (\mathbf{Q}_R(k) - \mathbf{A}_0) \\ &= \begin{bmatrix} -k^2\mathbf{I} & \frac{k^2}{k^2+\beta_1^2}\mathbf{I} & \frac{k^2}{k^2+\beta_2^2}\mathbf{I} \end{bmatrix} \begin{bmatrix} \mathbf{A}_2 \\ \mathbf{A}_3 \\ \mathbf{A}_4 \end{bmatrix} \end{aligned} \quad (29)$$

$$= \mathbf{S}_R(k) \tilde{\mathbf{A}}$$

$$\begin{aligned} \tilde{\mathbf{Q}}_I(k) &= \mathbf{Q}_I(k)/k - \mathbf{A}_1 \\ &= \begin{bmatrix} 0 & \frac{\beta_1}{k^2+\beta_1^2}\mathbf{I} & \frac{\beta_2}{k^2+\beta_2^2}\mathbf{I} \end{bmatrix} \begin{bmatrix} \mathbf{A}_2 \\ \mathbf{A}_3 \\ \mathbf{A}_4 \end{bmatrix} \end{aligned} \quad (29a)$$

$$= \mathbf{S}_I(k) \tilde{\mathbf{A}}$$

in which for a small value of $k = k_1$, the coefficients assume the following form:

$$\mathbf{A}_0 = \mathbf{Q}_R(k_1) \quad (30)$$

$$\mathbf{A}_1 = \frac{\mathbf{Q}_I(k_1)}{k_1} - \frac{\mathbf{A}_3}{\beta_1} - \frac{\mathbf{A}_4}{\beta_2} \quad (30a)$$

Substituting equation (30a) in equation (29a), the unknown coefficients \mathbf{A}_3 and \mathbf{A}_4 can be determined. However, the resulting solution is sensitive to the choice of β_j . On the other hand, if the elements of the

A_1 matrix are replaced by measured damping coefficients without any lag terms, then the solution is insensitive to the β_j values.

Equations (29) and (29a), computed for an NF number of values of reduced frequencies k_i , may be combined as

$$\begin{bmatrix} \tilde{Q}_R(k_2) \\ \tilde{Q}_I(k_2) \\ \vdots \\ \tilde{Q}_R(k_{NF-1}) \\ \tilde{Q}_I(k_{NF-1}) \end{bmatrix} = \begin{bmatrix} S_R(k_2) \\ S_I(k_2) \\ \vdots \\ S_R(k_{NF-1}) \\ S_I(k_{NF-1}) \end{bmatrix} \begin{bmatrix} A_2 \\ A_3 \\ A_4 \end{bmatrix} \quad (31)$$

or

$$\tilde{\mathbf{Q}} = \mathbf{S}\tilde{\mathbf{A}} \quad (32)$$

and a least square solution

$$\tilde{\mathbf{A}} = [\mathbf{S}^T\mathbf{S}]^{-1}\mathbf{S}^T\tilde{\mathbf{Q}} \quad (33)$$

yields the required coefficients A_2 , A_3 , and A_4 . This procedure may be easily extended for a larger number of lag terms, if desired. Equation (27) may be rewritten as

$$\widehat{\mathbf{M}}\ddot{\eta} + \widehat{\mathbf{C}}\dot{\eta} + \widehat{\mathbf{K}}\eta + \bar{q} \left[\mathbf{A}_0\eta + \mathbf{A}_1 \left(\frac{sb}{V} \right) \eta + \mathbf{A}_2 \left(\frac{sb}{V} \right)^2 \eta + \mathbf{A}_3\mathbf{X}_1 + \mathbf{A}_4\mathbf{X}_2 + \dots \right] = \mathbf{0} \quad (34)$$

and collecting like terms gives

$$\left(\widehat{\mathbf{K}} + \bar{q} \mathbf{A}_0 \right) \eta + \left[\widehat{\mathbf{C}} + \bar{q} \left(\frac{b}{V} \right) \mathbf{A}_1 \right] \dot{\eta} + \left[\widehat{\mathbf{M}} + \bar{q} \left(\frac{b}{V} \right)^2 \mathbf{A}_2 \right] \ddot{\eta} + \bar{q} \mathbf{A}_3 \mathbf{X}_1 + \bar{q} \mathbf{A}_4 \mathbf{X}_2 + \dots = \mathbf{0} \quad (35)$$

or

$$\widehat{\widehat{\mathbf{K}}}\eta + \widehat{\widehat{\mathbf{C}}}\dot{\eta} + \widehat{\widehat{\mathbf{M}}}\ddot{\eta} + \bar{q} \mathbf{A}_3 \mathbf{X}_1 + \bar{q} \mathbf{A}_4 \mathbf{X}_2 + \dots = \mathbf{0} \quad (36)$$

Also

$$\mathbf{X}_j = \frac{s\eta}{\left[s + \left(\frac{V}{b} \right) \beta_j \right]} \quad (37)$$

from which

$$\dot{\mathbf{X}}_j + \left(\frac{V}{b} \right) \beta_j \mathbf{X}_j = \dot{\eta} \quad (38)$$

Equations (36), (37), and (38) can be rewritten as one set of matrix equations

$$\begin{bmatrix} \mathbf{I} & & & \\ & \widehat{\mathbf{M}} & & \\ & & \mathbf{I} & \\ & & & \mathbf{I} \end{bmatrix} \begin{bmatrix} \dot{\eta} \\ \ddot{\eta} \\ \dot{\mathbf{X}}_1 \\ \dot{\mathbf{X}}_2 \end{bmatrix} = \begin{bmatrix} 0 & \mathbf{I} & 0 & 0 \\ -\widehat{\mathbf{K}} & -\widehat{\mathbf{C}} & -\bar{q}\mathbf{A}_3 & -\bar{q}\mathbf{A}_4 \\ 0 & \mathbf{I} & -\frac{\mathbf{V}}{b}\beta_1\mathbf{I} & 0 \\ 0 & \mathbf{I} & 0 & -\frac{\mathbf{V}}{b}\beta_2\mathbf{I} \end{bmatrix} \begin{bmatrix} \eta \\ \dot{\eta} \\ \mathbf{X}_1 \\ \mathbf{X}_2 \end{bmatrix} \quad (39)$$

or

$$\mathbf{M}'\dot{\mathbf{X}}' = \mathbf{K}'\mathbf{X}' \quad (40)$$

from which

$$\begin{aligned} \dot{\mathbf{X}}' &= (\mathbf{M}')^{-1}\mathbf{K}'\mathbf{X}' \\ &= \mathbf{R}\mathbf{X}' \end{aligned} \quad (41)$$

Also, the state-space vector \mathbf{X}' may be rearranged as

$$\begin{aligned} \mathbf{X}' &= [(\eta_r \ \eta_e \ \dot{\eta}_r \ \dot{\eta}_e \ \mathbf{X}_1 \ \mathbf{X}_2) \ (\eta_\delta \ \dot{\eta}_\delta)] \\ &= [\widehat{\mathbf{X}} \ \mathbf{u}] \end{aligned} \quad (42)$$

and equation (41) partitioned as

$$\begin{bmatrix} \dot{\widehat{\mathbf{X}}} \\ \dot{\mathbf{u}} \end{bmatrix} = \begin{bmatrix} \mathbf{R}_{I,I} & \mathbf{R}_{I,II} \\ \mathbf{R}_{II,I} & \mathbf{R}_{II,II} \end{bmatrix} \begin{bmatrix} \widehat{\mathbf{X}} \\ \mathbf{u} \end{bmatrix} \quad (43)$$

where the first set of matrix equations denotes the plant dynamics, and the second set represents the dynamics of control modes. In the case of plant dynamics, the state-space equations become

$$\dot{\widehat{\mathbf{X}}} = \widehat{\mathbf{A}}\widehat{\mathbf{X}} + \widehat{\mathbf{B}}\mathbf{u} \quad (44)$$

the relevant matrices and vectors being defined as

$\widehat{\mathbf{A}}$ plant dynamics matrix

$\widehat{\mathbf{B}}$ control surface influence matrix

$\hat{\mathbf{X}}$ generalized coordinates in inertial frame

\mathbf{u} control surface motion input into plant

and in which the terms $\hat{\mathbf{A}}\hat{\mathbf{X}}$ and $\hat{\mathbf{B}}\mathbf{u}$ represent for an aircraft, for example, the airplane dynamics and forcing function on airplane due to control surface motion, respectively.

Coordinate Transformation

To incorporate control laws and feedback, it is necessary to transform equation (44) from the earth-fixed (inertial) to the body-fixed coordinate system. Since no transformations are applied to elastic and aerodynamic lag state vectors, a transformation of the form

$$\begin{aligned}\dot{\mathbf{X}} &= \tilde{\mathbf{T}}_2^{-1}(\hat{\mathbf{A}}\tilde{\mathbf{T}}_1 - \tilde{\mathbf{T}}_3)\mathbf{X} + \tilde{\mathbf{T}}_2^{-1}\hat{\mathbf{B}}\mathbf{u} \\ &= \mathbf{A}\mathbf{X} + \mathbf{B}\mathbf{u}\end{aligned}\quad (45)$$

in which

$$\tilde{\mathbf{T}}_1 = \begin{bmatrix} \mathbf{T}_1 & \mathbf{0} \\ \mathbf{0} & \mathbf{I} \end{bmatrix}$$

and so forth, \mathbf{T}_1 being the 12 by 12 coordinate transformation matrix, yields the required state-space equation in the body coordinate system.

Determination of Sensor Outputs

The structural nodal displacements are related to the generalized coordinates by equation (26), and the related sensor motion can be expressed as

$$\begin{aligned}\mathbf{q}_s &= \mathbf{T}_s\Phi\eta \\ &= \mathbf{C}_0\mathbf{X}\end{aligned}\quad (46)$$

where $\mathbf{C}_0 = [\mathbf{T}_s\Phi \ \mathbf{0} \ \mathbf{0} \ \mathbf{0}]$, and in which \mathbf{T}_s is an interpolation matrix. Similar relations may be derived for sensor velocities and acceleration as

$$\begin{aligned}\begin{bmatrix} \dot{\mathbf{q}}_s \\ \ddot{\mathbf{q}}_s \end{bmatrix} &= \begin{bmatrix} \mathbf{T}_s\Phi\dot{\eta} \\ \mathbf{T}_s\Phi\ddot{\eta} \end{bmatrix} \\ &= \mathbf{C}_1\dot{\mathbf{X}}\end{aligned}\quad (47)$$

where

$$\mathbf{C}_1 = \begin{bmatrix} \mathbf{T}_s\Phi & \mathbf{0} & \mathbf{0} & \mathbf{0} \\ \mathbf{0} & \mathbf{T}_s\Phi & \mathbf{0} & \mathbf{0} \end{bmatrix}$$

Equation (45) is next premultiplied by C_1 to yield

$$\begin{aligned} C_1 \dot{\mathbf{X}} &= C_1 \mathbf{A} \mathbf{X} + C_1 \mathbf{B} \mathbf{u} \\ &= C_2 \mathbf{X} + D_2 \mathbf{u} \end{aligned} \quad (48)$$

and adjoining equations (46) and (48), the following expression is obtained

$$\mathbf{y} = \begin{bmatrix} \mathbf{q}_s \\ \dot{\mathbf{q}}_s \\ \ddot{\mathbf{q}}_s \end{bmatrix} = \begin{bmatrix} C_0 \\ C_2 \end{bmatrix} \mathbf{X} + \begin{bmatrix} 0 \\ D_2 \end{bmatrix} \mathbf{u}$$

or

$$\mathbf{y} = \mathbf{C} \mathbf{X} + \mathbf{D} \mathbf{u} \quad (49)$$

which is the required sensor output relationship, the matrices \mathbf{C} and \mathbf{D} signifying output at sensor due to body and control surface motions, respectively.

Augmentation of Analog Elements and Controller

The complete state-space formulation for an aircraft incorporating structural and aeroelastic effects is represented by equations (45) and (49), derived earlier. To conduct an aeroservoelastic analysis, it is essential to augment such a formulation with associated analog elements like actuators, sensors, notch filters, and prefilters along with the controller. Thus denoting the state-space equations of one such element as

$$\dot{\mathbf{X}}^{(i)} = \mathbf{A}^{(i)} \mathbf{X}^{(i)} + \mathbf{B}^{(i)} \mathbf{u}^{(i)} \quad (50)$$

$$\mathbf{y}^{(i)} = \mathbf{C}^{(i)} \mathbf{X}^{(i)} + \mathbf{D}^{(i)} \mathbf{u}^{(i)} \quad (51)$$

these can be augmented to such original equations (45) and (49) as appropriate; thus, typically, for the case of a connection from plant output to the external input, the relevant formulation is as follows:

$$\begin{bmatrix} \dot{\mathbf{X}} \\ \dot{\mathbf{X}}^{(i)} \end{bmatrix} = \begin{bmatrix} \mathbf{A} & 0 \\ \mathbf{B}^{(i)} \mathbf{C} & \mathbf{A}^{(i)} \end{bmatrix} \begin{bmatrix} \mathbf{X} \\ \mathbf{X}^{(i)} \end{bmatrix} + \begin{bmatrix} \mathbf{B} \\ \mathbf{B}^{(i)} \mathbf{D} \end{bmatrix} [\mathbf{u}] \quad (52)$$

or

$$\dot{\mathbf{X}}_{(i)} = \mathbf{A}_{(i)} \mathbf{X}_{(i)} + \mathbf{B}_{(i)} \mathbf{u} \quad (53)$$

noting that $\mathbf{u}^{(1)} = \mathbf{y}$. Also

$$\begin{bmatrix} \mathbf{y} \\ \mathbf{y}^{(i)} \end{bmatrix} = \begin{bmatrix} \mathbf{C} & \mathbf{0} \\ \mathbf{D}^{(i)}\mathbf{C} & \mathbf{C}^{(i)} \end{bmatrix} \begin{bmatrix} \mathbf{X} \\ \mathbf{X}^{(i)} \end{bmatrix} + \begin{bmatrix} \mathbf{D} \\ \mathbf{D}^{(i)}\mathbf{D} \end{bmatrix} [\mathbf{u}]$$

or

$$\mathbf{y}^{(i)} = \mathbf{C}^{(i)}\mathbf{X}^{(i)} + \mathbf{D}^{(i)}\mathbf{u} \quad (54)$$

becomes the new sensor output expression.

Any analog element, including a controller, can be augmented in a similar manner. Figure 21 shows a typical feedback control system. For such a system, the three sets of relevant matrix equations are

$$\dot{\mathbf{X}} = \mathbf{A}\mathbf{X} + \mathbf{B}\mathbf{u} \quad (55)$$

$$\mathbf{y} = \mathbf{C}\mathbf{X} + \mathbf{D}\mathbf{u} \quad (55a)$$

$$\mathbf{u} = \mathbf{r} - \mathbf{G}\mathbf{y} \quad (55b)$$

where equation (55b) is the feedback equation. By applying Laplace transformations to equation (55), the following relationship is obtained:

$$s\mathbf{X}(s) = \mathbf{A}\mathbf{X}(s) + \mathbf{B}\mathbf{u}(s) \quad (56)$$

$$\mathbf{y}(s) = \mathbf{C}\mathbf{X}(s) + \mathbf{D}\mathbf{u}(s) \quad (56a)$$

$$\mathbf{u}(s) = \mathbf{r}(s) - \mathbf{G}(s)\mathbf{y}(s) \quad (56b)$$

Further, from equation (56)

$$\mathbf{X}(s) = [s\mathbf{I} - \mathbf{A}]^{-1}\mathbf{B}\mathbf{u}(s) \quad (57)$$

and substitution of equation (57) into equation (56a) yields the required open-loop frequency response relationship

$$\begin{aligned} \mathbf{y}(s) &= [\mathbf{C}(s\mathbf{I} - \mathbf{A})^{-1}\mathbf{B} + \mathbf{D}]\mathbf{u}(s) \\ &= \mathbf{H}(s)\mathbf{u}(s) \end{aligned} \quad (58)$$

$\mathbf{H}(s)$ being the equivalent open-loop (loop-gain) transfer function with the analog controller or the open-loop transfer function without the controller. To obtain the closed-loop frequency response relationship, equation (58) is first substituted in equation (56b), resulting in

$$\mathbf{u}(s) = \mathbf{r}(s) - \mathbf{G}(s)\mathbf{H}(s)\mathbf{u}(s) \quad (59)$$

or

$$\mathbf{u}(s) = [\mathbf{I} + \mathbf{G}(s)\mathbf{H}(s)]^{-1}\mathbf{r}(s) \quad (59a)$$

and again substitution of equation (58) yields

$$\mathbf{y}(s) = (\mathbf{H}(s)[\mathbf{I} + \mathbf{G}(s)\mathbf{H}(s)]^{-1})\mathbf{r}(s) \quad (59b)$$

$$= \widehat{\mathbf{H}}(s) \mathbf{r}(s) \quad (60)$$

in which $\widehat{\mathbf{H}}(s)$ is the desired closed-loop transfer function. The frequency responses plots can be simply obtained from the transfer matrices $\mathbf{H}(s)$ or $\widehat{\mathbf{H}}(s)$, as the case may be. Associated damping and frequency values for the system, for the loop-gain or open-loop case, may also be calculated by solving the eigenvalue problem of the relevant \mathbf{A} matrix for various k_i values and observing the changes in sign of the real part of an eigenvalue.

In the presence of a digital controller, a hybrid approach (ref. 6) is adopted for the frequency response solution. Thus, if \mathbf{A}' , \mathbf{B}' , \mathbf{C}' , and \mathbf{D}' are the state-space matrices associated with the controller, the related transfer function is simply given by

$$\mathbf{G}(z) = \mathbf{C}'[z\mathbf{I} - \mathbf{A}']^{-1}\mathbf{B}' + \mathbf{D}' \quad (61)$$

and the frequency response relationship for the hybrid analog/digital system can be written as

$$\mathbf{y}(s) = \mathbf{G}(z) \left[\text{at } z = e^{sT} \right] \left\{ \frac{\mathbf{H}(s) [\text{ZOH}]}{\mathbf{T}} \right\} \mathbf{u}(s) \quad (62)$$

$$= \mathbf{H}^*(s)\mathbf{u}(s) \quad (62a)$$

in which

$\mathbf{H}(s)$ is the open-loop transfer function for the plant and other analog elements

$[\text{ZOH}]$ is the zero order hold complex expression $\left(= e^{-s\tau} \left(\frac{1 - e^{-sT}}{s} \right) \right)$

and where $\mathbf{H}^*(s)$ is now the equivalent open-loop (loop-gain) transfer function of the hybrid system. The closed-loop frequency response relationship may be obtained as before by using equations (62a) and (56b)

$$\begin{aligned} \mathbf{y}(s) &= \left\{ \mathbf{H}(s) [\mathbf{I} + \mathbf{G}(s) \mathbf{H}(s)]^{-1} \right\} \mathbf{r}(s) \\ &= \widehat{\mathbf{H}}^*(s)\mathbf{r}(s) \end{aligned} \quad (63)$$

To compute the damping and frequencies, the analog plant dynamics matrix \mathbf{A} is first transformed into the z-plane by the standard discretization procedure which is next augmented to the \mathbf{A}' matrix. The appropriate eigenproblem solution of the final matrix yields the required results, as before.

The STARS program has been extended to include capabilities representative of formulations presented in this section.

Figure 22 depicts the data input strategy for the entire ASE analysis procedure; such input for the solids module is described in section 3. In the following, the data pertaining to the other related analyses are given in the appropriate order, in which AERO module data input is compatible with the program described in reference 16.

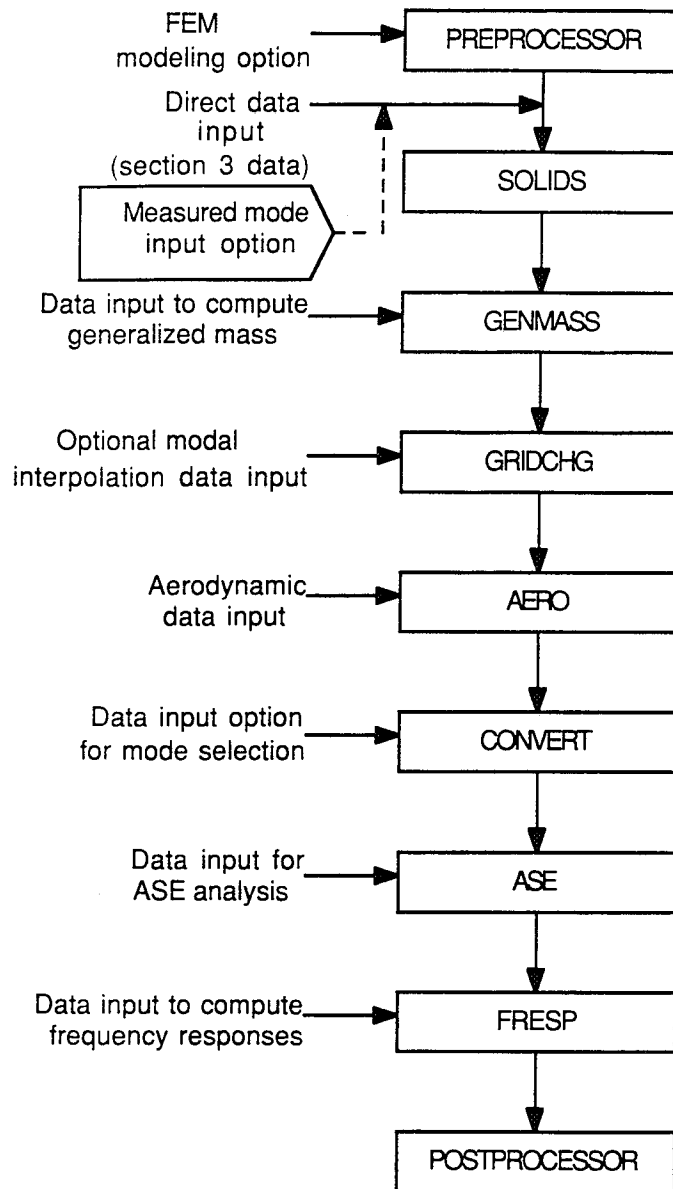

10154

Figure 22. ASE analysis data input scheme.

6.1.1 \$ JOB DESCRIPTION
Format (FREE)

6.1.2 ISTMN, NLVN, GR
Format (3I5)

1. Description: Generalized mass matrix and modal interpretation generation data.
2. Notes:

ISTMN = integer specifying starting mode number

NLVN = number of laterally vibrating nodes

GR = gravitational constant

6.1.3 \$ LATERALLY MOVING NODAL NUMBERS DATA
Format (FREE)

(Required if NLVN > 0)

6.1.3.1 (LN(I), I = 1, NLVN)
Format (I5)

1. Description: NLVN number of nodes input data.
2. Notes:

Input of a GR value is needed to convert generalized mass data into generalized weight acceptable to AERO module.

If GRIDCHG is used, then the LN refers to STARS nodes (that is, the input vector, as defined in section 3.2.2 of the STARS manual).

If direct STARS interpolation is used, then the LN refers to nodes as defined in STARS (that is, the output vector, as defined in section 3.5.10 of the STARS manual).

3. Note:

The data is to be stored in the file GENMASS.DAT.

6.2.1.1 \$ JOB TITLE
Format (FREE)

6.2.1.2 NELN, NLINES, NOSURF
Format (3I5)

6.2.1.3 IDELE, NMOD
Format (2I5)

6.2.1.4 NBLOCK, IRPEAT
Format (2I5)

1. Description: General input data.

2. Notes:

NELN = number of eliminated nodes from input vector

NLINES = number of output vector interpolation lines
 $0 < \text{NLINES} \leq 20$

NOSURF = number of sets of input vector coordinates to be translated

IDELE = flag for deletion of interpolation elements
= 0, for no elimination of interpolation element(s)
= 1, to eliminate interpolation element(s)

NMOD = number of output points whose values are to be changed to a user-specified value (for all modes)

NBLOCK = number of blocks of added deflections

IRPEAT = flag for reuse of deflections for different modes
= 0, for user to input all blocks for all output modes
= 1, to repeat first subset of block data for all subsequent modes

6.2.2.1 \$ ELIMINATED INPUT NODES
Format (FREE)

(Required if NELN \neq 0)

6.2.2.2 (NODEL(I), I = 1, NELN)
Format (I5)

1. Description: NELN indices of nodes in input vector whose deflections are not used in interpolation.

2. Notes:

NODEL(I) = node in input data that is not to be used in interpolation.

6.2.3.1 \$ NUMBER OF POINTS ON OUTPUT VECTOR LINES

Format (FREE)

6.2.3.2 (NGP(I), I = 1, NLINES)

Format (I5)

1. Description: NLINES sets of numbers of output points. Each set makes up part of the output vector.

2. Notes:

NGP(I) = number of points that will be interpolated to on each line
 $0 < \text{NGP}(I) \leq 12$

6.2.4.1 \$ ENDPPOINTS OF OUTPUT VECTOR LINES

Format (FREE)

6.2.4.2 ((XTERM1(I), YTERM1(I), XTERM2(I), YTERM2(I), XT(I), YT(I)), I = 1, NLINES)

Format (6E10.4)

1. Description: NLINES sets of endpoints for output vector interpolation lines and optional translations.

2. Notes:

XTERM1(I), YTERM1(I) = inboard coordinates of line I

XTERM2(I), YTERM2(I) = outboard coordinates of line I

XT(I), YT(I) = optional translations to be applied to line data in X- and Y-directions

6.2.5.1 \$ SPANWISE COORDINATES OF POINTS ON OUTPUT VECTOR LINES

Format (FREE)

6.2.5.2 ((YGP(J,I), J = 1, NGP(I)), I = 1, NLINES)

Format (7E10.4)

1. Description: NLINES sets of spanwise coordinate of desired point in output vector.

2. Notes:

YGP(J,I) = spanwise coordinate of a point desired on an interpolation line, before any translation; translation, as defined in section 4.1, will automatically be applied

6.2.6.1 \$ TRANSLATION DATA FOR INPUT VECTOR POINTS (Required if NOSURF ≠ 0)
Format (FREE)

6.2.6.2 XTRAN, YTRAN, ZTRAN
Format (3E10.4)

6.2.6.3 NODNUM
Format (I5)

1. Description: NOSURF subsets of input vector nodal data.

2. Notes:

XTRAN = value to be added to X-coordinate of input vector in set

YTRAN = value to be added to Y-coordinate of input vector in set

ZTRAN = value to be added to Z-coordinate of input vector in set

NODNUM = index of node to be translated

A data set is terminated if NODNUM is read as -1; a node should not be referenced more than once.

6.2.7.1 \$ INTERPOLATION ELEMENT DATA
Format (FREE)

6.2.7.2 NXPT
Format (I5)

6.2.7.2.1 (XMESH(I), I = 1, NXPT)
Format (7E10.4)

6.2.7.3 NYPT
Format (I5)

6.2.7.3.1 (YMESH(I), I = 1, NYPT)
Format (7E10.4)

1. Description: Streamwise and spanwise finite element interpolation boundaries.

2. Notes:

NXPT = number of stations in X-direction for interpolation grid
 $2 \leq NXPT \leq 20$

XMESH(I) = actual X-coordinates of streamwise stations in interpolation grid, in ascending order

NYPT = number of stations in Y-direction for interpolation grid
 $2 \leq NYPT \leq 20$

YMESH(I) = actual Y-coordinates of spanwise stations in interpolation grid, in ascending order

6.2.8.1 \$ INTERPOLATION ELEMENT DELETION DATA (Required if IDELE > 0)
Format (FREE)

6.2.8.2 IOPT
Format (I5)

6.2.8.3 NCOL, NROW (Required if IOPT = 1); or
NCOL (Required if IOPT = 2); or
NROW (Required if IOPT = 3)
Format (2I5)

1. Description: Data for elimination of finite element interpolation elements.

2. Notes:

IOPT = type of elimination
= 0, to proceed to next set to be eliminated
= 1, to eliminate following element(s)
= 2, to eliminate following row of elements
= 3, to eliminate following column of elements
= 4, to quit all eliminations

NCOL = column of interpolation element(s)

NROW = row of interpolation element(s)

6.2.9.1 \$ OUTPUT VECTOR MODIFICATION DATA (Required if NMOD > 0)
Format (FREE)

6.2.9.2 (NODE(I), DEFL(NODE(I)), I = 1, NMOD)
Format (I5, E10.4)

1. Description: Sets a deflection to a user input value (for all output modes), where number of output modes $NTOTAL = NR + NCNTRL - ISTMN + 1$.

2. Notes:

- NODE(I) = output point index
- DEFL(NODE(I)) = new deflection value
- NR = analytically calculated number of roots (from section 3.1.6 of the STARS manual)
- NCNTRL = number of rigid body control modes (from section 3.1.3 of the STARS manual)
- ISTMN = integer specifying starting mode numbers

6.2.10.1 \$ BLOCK SPECIFICATION OF ADDITIONAL DEFLECTION DATA (Required if NBLOCK > 0)
Format (FREE)

6.2.10.2 ((IBLOCK(I), NADD(I), IBF0RE(I)), I = 1, NBLOCK)
Format (3I5)

1. Description: NBLOCK sets of description of additional deflections to be added to output vector.

2. Notes:

- IBLOCK(I) = user's identification number of an added output block of output points
- NADD(I) = number of points in block
- IBFORE(I) = index of existing point in front of which block is to be inserted
- Succeeding values of IBF0RE should be greater than the previous ones.

6.2.11.1 \$ DEFLECTION DATA SPECIFICATION FOR BLOCKS (Required if NBLOCK > 0)
Format (FREE)

6.2.11.2 ((NNODE(J), DADD(J)), J = 1, NADD(I))
Format (I5, E10.4)

1. Description: Added deflection data for each block.

2. Notes:

- NNODE(J) = index of added point in set
- DADD(J) = deflection of added point in set
- This is repeated for NTOTAL modes.

If IRPEAT = 1, the same deflections are reused for all modes.

6.2.12.1 \$ EIGENVALUE SPECIFICATION FOR CONTROL MODES (Required if NCNTRL > 0)
Format (FREE)

6.2.12.2 (EIGADD(I), I = 1, NCNTRL)
Format (E10.4)

1. Description: Eigenvalues for rigid body control modes from STARS.
2. Notes:

EIGADD(I) = user-input eigenvalues, in rad/sec, for rigid body control modes

6.2.13 NOTES ON PROGRAM USAGE

GRIDCHG is a versatile interpolation program that may be used as an alternative to the preferred direct interpolation option defined in section 3.1.4 of the STARS-SOLIDS module. It is utilized to interpolate deflections, obtained by a finite element code or ground vibration survey, into the straight line input points required by the aerodynamic module. Options for separate interpolation of different surfaces and for modification by the user of both the input and output vectors exist.

Input vector: The input vector is a calculated or measured vector with six degrees of freedom read from the file FOR096 (if bandwidth minimization is used) or from FOR048 (if bandwidth minimization is not used). Both files are STARS binary files. GRIDCHG normally uses only the Z component of the vector for the interpolation. However, GRIDCHG does read the input file for the GENMASS program as part of its input, and if the variable NLVN is nonzero in that file, then it reads from the file those nodes of the input vector for which the Y deflection is to be used (that is, a vertical surface). The GENMASS.DAT file must always be present for GRIDCHG to run, even if NLVN is zero.

Discrete element interpolation: The user defines a set of rectangular elements used for the interpolation. Each element uses the deflections within its boundaries for a surface fit, with the added stipulation that adjacent elements have identical displacements and slopes at edges. The achievable quality of interpolation is a function of number and distribution of input nodes. The output vector is obtained using a surface fit within a particular element. Separate surfaces need to be individually interpolated, and this is accomplished by letting the value of a row or column of interpolation elements or columns between the surfaces to be set to zero. If the projection of the surfaces in the X-Y plane overlap, the user has the option of temporarily modifying the coordinates of input and output vectors to separate them, thereby allowing their individual interpolation.

Output vector: The output vector occasionally needs to be modified and/or have data added to it. This can be implemented as required.

Eigenvalues: The STARS-SOLIDS module contains an option which allows additions of user input eigenvectors to those analytically calculated. The eigenvalues for those modes are added here.

6.3.1.1 JOB TITLE - 1:6 (six lines of title cards)
Format (FREE)

6.3.2.1 (LC(I), I = 1, 40)
Format (10I5)

1. Description: Basic data parameters.

2. Notes:

- LC(1) = integer defining flutter and divergence solution algorithm
 = -1, p-k type of solution
 = 0, pressure calculations only
 = 1, k and state-space solutions
 = 2, divergence analysis
- LC(2) = maximum number of vibration modes to be used in analysis
 $0 \leq LC(2) \leq 20$
- LC(3) = number of lifting surfaces
 $0 \leq LC(3) \leq 30$, for doublet lattice method (DLM) or constant pressure method (CPM)
- LC(4) = number of reduced velocities, VBO, used in analysis
 If LC(1) = -1, set LC(4) = 6
 If LC(1) = 0 or 1, set $1 \leq LC(4) \leq 30$
 If LC(1) = 2, set LC(4) = 1
 LC(4) and LC(13) apply to the reduced velocities described in section 6.3.4.2 and section 6.3.4.4
- LC(5) = number of air densities at which flutter and divergence solutions are to be found
 $0 \leq LC(5) \leq 10$
 If LC(1) = 0, set LC(5) = 0
- LC(6) = print option for tested aerodynamic forces used to check aerodynamic force interpolation
 = 1, print
 = 0, no print
- LC(7) = print option for aerodynamic pressures
 = 1, print data
 = 0, no print
- LC(8) = print option for lift and moment coefficients
 = 1, print data
 = 0, no print

- LC(9) = input frequency-independent additions to the aerodynamic matrix QBAR
= 1, make additions
= 0, no additions
- LC(10) = print option for full set of interpolated generalized forces when used in k solutions
= 1, print data
= 0, no print
- LC(11) = index of mode whose frequency is to be used in normalizing flutter determinant
Frequency chosen must be nonzero
Suggested index is 1
- LC(12) = index defining flutter determinant formulation
= 1, for nonzero frequencies [$\mathbf{D} = \mathbf{K}^{-1} (\mathbf{M} + \mathbf{A}_E)$]
= 0, in presence of zero frequencies [$\mathbf{D} = (\mathbf{M} + \mathbf{A}_E)^{-1} \mathbf{K}$]
 \mathbf{K} = generalized stiffness matrix
 \mathbf{M} = generalized mass matrix
 \mathbf{A}_E = aerodynamic force matrix
If LC(1) = 0, set LC(12) = 0
- LC(13) = index defining interpolation of aerodynamic forces
= 0, no interpolation, to compute at each input VBO
= 1, to compute directly at only 6 VBOs, interpolate to others
If LC(1) = -1, set LC(13) = 1
If LC(1) = 0 or 2, set LC(13) = 0
If LC(1) = 1, set LC(13) = 0 or 1, as desired
- LC(14) = not used. Set = 0
- LC(15) = index defining velocity scale in flutter solution output
= 1, use true airspeed, TAS
= 0, use equivalent airspeed, EAS
- LC(16) = index defining addition of structural damping to complex stiffness matrix
= 1, add a single damping value to all modes
= -1, add an individual damping value to each mode
= 0, no damping added
- LC(17) = print option to display number of iterations required to find each root in a p-k solution
= 1, print
= 0, no print
- LC(18) = option for root extrapolation in a p-k solution
= 1, use root values at two previous velocities for initial estimation of a root
= 0, use root value at previous velocity as root estimate

- If $LC(1) \neq -1$, set $LC(18) = 0$
- LC(19) = option for ordering of roots after a p-k solution
 = 1, to perform ordering
 = 0, no ordering required
 If $LC(1) \neq -1$, set $LC(19) = 0$
- LC(20) = print option for iterated roots in p-k analysis or intermediate results in k analysis
 = 1, print
 = 0, no print
- LC(21) = index for aerodynamics
 = 1, use doublet lattice method or constant pressure method (subsonic and supersonic Mach numbers, respectively)
- LC(22) = index defining generation and storage of aerodynamic influence coefficients matrix
 = 0, compute and save
 = 1, read precomputed values from a file
- LC(23) = print option for input modal vector
 = 1, print
 = 0, no print
- LC(24) = print option for interpolated deflections and slopes of aerodynamic elements
 = 1, print
 = 0, no print
- LC(25) = number of modal elimination cycles
 $0 \leq LC(25) \leq 25$
- LC(26) = index defining additional flutter analysis
 = 0, no additional cycles
 > 0, perform additional flutter analysis cycles with stiffness variations applied to a mode
 $0 \leq LC(26) \leq 20$
- LC(27) = index of mode whose frequency and stiffness is to be varied for the LC(26) cycles
 If $LC(26) = 0$, set $LC(27) = 0$
- LC(28) = print option for modal eigenvectors
 = 1, print
 = 0, no print
 If $LC(1) = -1$, the eigenvectors for the critical flutter root in a user-chosen velocity interval are displayed
 If $LC(1) = 0$ or 2, set $LC(28) = 0$

If LC(1) = 1, the eigenvectors for all roots between user chosen reduced velocities, VBO, and real frequencies are displayed

- LC(29) = print option for physical vectors corresponding to modal eigenvectors
= 1, print
= 0, no print
- LC(30) = print option for k solution flutter determinant matrix analysis
= 1, print
= 0, no print
If LC(1) = -1 or 0, set LC(30) = 0
- LC(31) = index defining revisions to generalized mass matrix and modal frequencies
= 1, revise
= 0, no change
- LC(32) = index defining revisions to generalized stiffness matrix
= 1, revise
= 0, no change
- LC(33) = index defining type of aerodynamics
= 1, steady state
= 0, oscillatory
If LC(1) = 2, set LC(33) = 1
- LC(34) = not used. Set = 0
- LC(35) = not used. Set = 0
- LC(36) = not used. Set = 0
- LC(37) = print option for aerodynamic element geometric data associated with doublet lattice and constant pressure methods
= 1, print
= 0, no print
If LC(21) \neq 1, set LC(37) = 0
- LC(38) = tape unit for ASCII printout of generalized forces and associated information.
Suggest LC(38) = 99
- LC(39) = not used. Set = 0
- LC(40) = not used. Set = 0

6.3.3.1 INV Format (I5)

1. Description: Input vibration data location flag.

2. Notes:

INV = integer defining location of input vectors, modal frequencies, and generalized masses
= 1, STARS binary file
= 2, this input file

6.3.3.1.1 NMDOF (Required if INV = 2)
Format (I5)

1. Description: Input vector degrees of freedom.

2. Notes:

NMDOF = total number of modal degrees of freedom used to define an input mode shape
 $0 \leq \text{NMDOF} \leq 200$

6.3.3.1.2 (QZ(I), I = 1, NMDOF) (Required if INV = 2)
Format (7E10.0)

1. Description: LC(2) sets of NMDOF input deflections.

2. Notes:

QZ(I) = principal out-of-plane deflection at point I of input vector

6.3.3.1.3 NCARD (Required if INV = 2)
Format (I5)

1. Description: Mass matrix specifications.

2. Notes:

NCARD = Number of nonzero generalized mass matrix elements

6.3.3.1.4 I, J, WW(I,J) (Required if INV = 2)
Format (2I5, E10.0)

1. Description: NCARD sets of data specifying nonzero generalized mass matrix elements.

2. Notes:

I = row index of generalized mass matrix
J = column index of generalized mass matrix
WW(I,J) = generalized mass (weight) matrix value, lbw

6.3.3.1.5 (OMG(I), I = LC(2)) (Required if INV = 2)
Format (7E10.0)

1. Description: LC(2) modal frequencies.

2. Notes:

OMG(I) = modal frequency in proper order, Hz

6.3.4.1 BR, FMACH
Format (2E10.4)

1. Description: Reference values for aerodynamics.

2. Notes:

BR = reference semichord, in.

FMACH = reference freestream Mach number
If FMACH < 1.0, doublet lattice method is used
If FMACH ≥ 1.0, constant pressure method is used

6.3.4.2 (VBO(I), I = 1, LC(4)) (Required if LC(1) = 1)
Format (7F10.4)

1. Description: LC(4) reduced velocities.

2. Notes:

VBO(I) = reduced velocity ($V/b\omega$) for flutter-divergence analysis

If aerodynamic interpolation is chosen, then aerodynamic forces will be interpolated at each of these VBO(I) values, using the values for RVBO input in section 6.3.4.4; if direct calculation is used, the aerodynamic forces will be calculated at each of these reduced velocities.
 $0 \leq LC(4) \leq 30$

6.3.4.3 NV, V1, DV (Required if LC(1) = -1)
Format (I5, 2F10.0)

1. Description: Airspeed velocity specification for p-k analysis.

2. Notes:

NV = number of velocities used in initial analysis, knots
 $1 < NV \leq 20$

V1 = lowest velocity from which to start analysis, knots
 $V1 \geq 200$, suggested

DV = velocity increment to be summed to V1 during initial analysis, knots
 $DV \geq 250$, suggested

6.3.4.4 TOLI, (RVBO(I), I = 1, 6)
Format (7E10.0)

(Required if LC(1) = -1 or LC(13) = 1)

1. Description: Aerodynamic forces interpolation data.

2. Notes:

TOLI = tolerance value used for testing the interpolation fit; a nominal value of 1.0E-03 is recommended

RVBO(I) = reduced velocity at which aerodynamic forces will be computed, to be used as part of the basis in interpolating forces at other reduced velocities

If aerodynamic interpolation is used, the RVBOs should span the entire range of VBOs of section 6.3.4.2.

For LC(1) = -1, use the following approximations:

1. $RVBO(1) \leq 1.69 * 12.0 * V1 / (BR * WMAX)$, where WMAX = maximum modal frequency, rad/sec.
2. $RVBO(6) \geq 1.69 * 12.0 * VMAX / (BR * WMIN)$, where VMAX = $V1 + (NV - 1) * DV$, and WMIN = minimum modal frequency, rad/sec.

6.3.5.1 MADD, IADD, MSYM
Format (3I5)

(Required if LC(31) = 1)

1. Description: Specifications for changes to mass matrix and modal frequencies.

2. Notes:

MADD = number of changes to mass matrix

IADD = number of changes to modal frequencies

MSYM = integer specifying symmetry of mass matrix modifications
= 0, changes are symmetric
= 1, changes are nonsymmetric

6.3.5.1.1 I, J, WW(I, J)
Format (2I5, F10.0)

(Required if MADD > 0)

1. Description: MADD changes to the mass matrix.

2. Notes:

I = row index of mass matrix element

J = column index of mass matrix element

WW(I,J) = value to be substituted for existing element in mass matrix, lb

If MSYM = 0, specify only changes to upper triangular elements.

6.3.5.1.2 I, OMG(I) (Required if IADD > 0)
Format (I5, F10.0)

1. Description: IADD changes to modal frequencies.

2. Notes:

I = index of mode to be changed

OMG(I) = new frequency to be substituted for old, Hz

6.3.5.2 GDD (Required if LC(16) = 1)
Format (E10.4)

1. Description: General structural damping factor.

2. Notes:

GDD = A single value for hysteretic damping to be applied to all modes; the imaginary term on the diagonal of the complex stiffness matrix will be multiplied by the term GDD

6.3.5.3 NCD (Required if LC(16) = -1)
Format (I5)

1. Description: Integer specifying individual structural damping.

2. Notes:

NCD = number of individual modes for which hysteretic damping will be specified

6.3.5.3.1 (I, GDP(I)) (Required if LC(16) = -1 and NCD ≠ 0)
Format (I5, E10.0)

1. Description: NCD individual structural damping values.

2. Notes:

I = mode index

GDP(I) = hysteretic damping applied to mode I, as in section 6.3.5.3

6.3.6.1 GMAX, GMIN, VMAX, FMAX
Format (4F10.0)

(Required if LC(1) ≠ 2)

1. Description: Maximum and minimum scales for V-g, V-f print plots.

2. Notes:

GMAX = maximum value of damping scales for V-g plots

GMIN = minimum value of damping scale for V-g plots

VMAX = maximum value of velocity scale for V-g and V-f plots, knots

FMAX = minimum value of frequency scale for V-f plots, Hz

6.3.7.1 (RHOR(I), I = 1, LC(5))
Format (7F10.0)

(Required if LC(1) ≠ 0)

1. Description: LC(5) values of air density ratios.

2. Notes:

RHOR(I) = density ratio with respect to sea level
 $0 < \text{RHOR}(I) \leq 10$

A separate flutter and/or divergence analysis is performed at each density ratio in which the aerodynamic force matrix is multiplied by the square root of the density ratio.

6.3.8.1 NADDF, NSYM
Format (2I5)

(Required if LC(9) = 1)

1. Description: Specifications for frequency-independent additions to aerodynamic matrix.

2. Notes:

NADDF = number of following additions to the flutter-determinant aerodynamic matrix

NSYM = index defining symmetry of additions
= 0, additions are symmetric. Input only upper triangular elements
= 1, additions are not symmetric

6.3.8.1.1 I, J, DETAD(I, J)
Format (2I5, 2E10.0)

(Required if LC(9) = 1)

1. Description: NADDF frequency-independent additions to aerodynamic matrix.

2. Notes:

I = row index of additions

J = column index of additions

DETAD(I, J) = value of addition. DETAD(I,J) is a complex value

Additions to the aerodynamic matrix QBAR are done in the following manner:

$$QBAR = QBAR + \frac{DETADREAL}{k^2} + i * \frac{DETADIMAG}{k},$$

where k is the reduced frequency.

6.3.8.2 NADDS, NSYM
Format (2I5)

(Required if LC(32) = 1)

1. Description: Specifications for changes to generalized stiffness matrix.
2. Notes:

NADDS = number of following changes to the stiffness matrix

NSYM = index specifying symmetry of changes
= 0, changes are symmetric ($B(I,J) = B(J,I)$)
= 1, changes are not symmetric

6.3.8.2.1 I, J, B(I, J)
Format (2I5, 2E10.0)

(Required if LC(32) = 1)

1. Description: NADDS changes to stiffness matrix.
2. Notes:

I = row index of changes

J = column index of changes

B(I, J) = new value of complex stiffness matrix element

If NSYM = 0, only the upper triangular elements are input.

6.3.8.3 RATOM(I)
Format (7E10.0)

(Required if LC(26) > 0)

1. Description: LC(26) values of stiffness variations for an input mode.
2. Notes:

RATOM(I) = ratio of modal frequency with respect to the original input value, OMG(I)

6.3.8.3.1 NOTIR, (NINZ(J), J=1, NOTIR)
Format (10I5)

(Required if LC(25) ≠ 0)

1. Description: LC(25) sets of modal elimination specification for flutter and divergence analysis.

2. Notes:

NOTIR = number of deleted modes in a given modal elimination cycle

NINZ = index of individual deleted mode for a given cycle

It should be noted that the aero module always does an initial analysis without modal deletions before doing any modal elimination analyses as defined in this section.

6.3.9.1 VA, VB
Format (2E10.0)

(Required if LC(28) = 1 and LC(1) ≠ 2)

1. Description: Eigenvector calculation range.

2. Notes:

VA = lower bound of the range over which the eigenvectors are to be calculated

VB = upper bound of the range over which the eigenvectors are to be calculated

If LC(1) = -1, the range is over velocity, V, knots

If LC(1) = 1, the range is over reduced velocity, $\frac{V}{B\omega}$

6.3.9.2 FLO, FHI
Format (2E10.0)

(Required if LC(28) = 1 and LC(1) = 1)

1. Description: Eigenvector display range.

2. Notes:

FLO = lower bound of the frequency range over which the eigenvectors are to be displayed, Hz

FHI = upper bound of the frequency range over which the eigenvectors are to be displayed, Hz

6.3.10.1 FL, ACAP
Format (2F10.0)

1. Description: Reference length and area.

2. Notes:

FL = reference chord of model, in. ($2.0 * BR$, normally)

ACAP = reference area of the model, in²

6.3.10.2 NDEL, NP, NB, NCORE, N3, N4, N7

Format (7I5)

1. Description: Doublet lattice and constant pressure methods geometrical paneling data.

2. Notes:

NDEL = index defining aerodynamic symmetry
= 1, aerodynamics are symmetrical about $Y = 0$
= -1, aerodynamics are antisymmetrical about $Y = 0$
= 0, no symmetry about $Y = 0$ (single surface only)

NP = total number of "panels" on all lifting surfaces

NB = body identification flag
= 0, no bodies of any kind
> 0, number of slender bodies used for doublet lattice analysis
= -1, constant pressure method body elements exist
 $0 \leq NB \leq 20$ for doublet lattice method

NCORE = problem size, $N * M$, where
N = total number of aerodynamic elements, and
M = number of modes

N3 = print option for pressure influence coefficients
= 1, print
= 0, no print

N4 = print option for influence coefficients relating downwash on lifting surfaces to
body element pressures
= 1, print
= 0, no print

N7 = index specifying calculation of pressures and generalized forces
= 1, calculate
= 0, cease computations after influence coefficients are determined
If $LC(1) = -1$ or 1 , set $N7 = 1$

6.3.11.1 IBOD1, IBOD2

(Required if $NB = -1$)

Format (2I5)

1. Description: Aerodynamic elements defining contiguous panels which describe a supersonic body for the constant pressure method.

2. Notes:

IBOD1 = first aerodynamic element on first panel (lowest index)

IBOD2 = last aerodynamic element on last panel (highest index)

6.3.12.1 6.3.12.1.1 to 6.3.12.1.5 are repeated for NP sets of surface paneling data.

6.3.12.1.1 XO, YO, ZO, GGMAS
Format (4F10.0)

6.3.12.1.2 X1, X2, X3, X4, Y1, Y2
Format (6F10.0)

6.3.12.1.3 Z1, Z2, NEBS, NEBC, COEFF
Format (2F10.0, 1X, 2I3, 3X, F10.0)

6.3.12.1.4 (TH(I), I = 1, NEBC)
Format (6F10.0)

6.3.12.1.5 (TAU(I), I = 1, NEBS)
Format (6F10.0)

1. Description: NP sets of data defining aerodynamic panels and their component aerodynamic elements. Section 6.3.12.1.1 translates and rotates panels. Such coordinates are in the global (aircraft) system indicating position of the origin of the LCS for each panel. Section 6.3.12.1.2 contains coordinates of points defining an aerodynamic panel, while section 6.3.12.1.3 defines boundaries of "aerodynamic elements" in the panel. The panel is divided into a number of smaller trapezoids, called "aerodynamic elements," by lines of constant percent panel chord and of constant percent panel span. Section 6.3.12.1.4 defines chordwise panel stations, and 6.3.12.1.5 defines spanwise panel stations.

2. Notes:

XO = translational value to be applied to x-coordinates, in.

YO = translational value to be applied to y-coordinates, in.

ZO = translational value to be applied to z-coordinates, in.

GGMAS = panel dihedral or rotation, deg, about global x-axis

GGMAS is in a right-handed coordinate system; an upright panel would require a positive rotation of 90°.

X1 = x-coordinate of panel inboard leading edge, in.

X2 = x-coordinate of panel inboard trailing edge, in.
 X3 = x-coordinate of panel outboard leading edge, in.
 X4 = x-coordinate of panel outboard trailing edge, in.
 Y1 = y-coordinate of panel inboard edge, in.
 Y2 = y-coordinate of panel outboard edge, in.
 Z1 = z-coordinate of panel inboard edge, in.
 Z2 = z-coordinate of panel outboard edge, in.

Coordinates are in the local coordinate system.

NEBS = number of element boundaries in the spanwise direction
 $2 \leq \text{NEBS} \leq 50$
 NEBS must be set = 2 for each body interference panel

NEBC = number of element boundaries in the chordwise direction
 $2 \leq \text{NEBC} \leq 50$

COEFF = entered as zero

TH(I) = chordwise element boundaries for the panel in fraction of chord
 $0.0 \leq \text{TH} \leq 1.0$
 (TH(1) = 0.0, TH(NEBC) = 1.0)

TAU(I) = spanwise element boundaries for the panel in fraction of span
 $0.0 \leq \text{TAU} \leq 1.0$
 (TAU(1) = 0.0, TAU(NEBS) = 1.0)

The data is to be repeated NP times in the following sequence:

1. Vertical panels or plane of symmetry ($y = 0$).
2. Panels on other surfaces.
3. Body interference panels. These panels must be one element wide (that is, NEBS = 2).

There are $(\text{NEBS} - 1) * (\text{NEBC} - 1)$ aerodynamic elements on a primary or control surface.

Indices for aerodynamic elements start at the inboard leading edge element, increase while traveling aft down a strip, then outward strip by strip, ending at the outboard trailing edge element.

The sum of all elements for all panels and bodies must not exceed 400.

The total number of strips must not exceed 150.

6.3.13.1 The following is repeated for NB sets of slender body data. (Required if NB > 0)

6.3.13.1.1 XBO, YBO, ZBO
Format (3F10.0)

6.3.13.1.2 ZSC, YSC, NF, NZ, NY, COEFF, MRK1, MRK2
Format (2F10.0, 1X, 3I2, 3X, 1F10.0, 2I3)

6.3.13.1.3 (F(I), I = 1, NF)
Format (6F10.0)

6.3.13.1.4 (RAD(I), I = 1, NF)
Format (6F10.0)

1. Description: NB sets of data defining subsonic slender bodies and their component elements. Section 6.3.13.1.1 defines X, Y, and Z global reference coordinates, and section 6.3.13.1.2 defines slender body origin, elements, and any related interference panels. Section 6.3.13.1.3 defines slender body element stations, while section 6.3.13.1.4 defines slender body radii.

2. Notes:

XBO = translational value to be added to X-coordinate, in.

YBO = translational value to be added to Y-coordinate, in.

ZBO = translational value to be added to Z-coordinate, in.

ZSC = local z-coordinate of the body axis, in.

YSC = local y-coordinate of the body axis, in.

NF = number of slender body element boundaries along its axis
 $2 \leq NF \leq 50$

NZ = flag for body vibration in z-direction
= 1, body vibrating
= 0, body not vibrating

NY = flag for body vibration in y-direction
= 1, body vibrating
= 0, body not vibrating

COEFF = entered as 0.0

MRK1 = index of the first aerodynamic element on the first interference panel associated with this slender body

- MRK2 = index of the last aerodynamic element on the first interference panel associated with this slender body
- F(I) = x-coordinate of body station defining a slender body element in local coordinates, in starting with body nose and proceeding aft
- RAD(I) = radii of body elements at the stations F(J), in.

NZ must never equal NY.

Vertically vibrating bodies should be input before laterally vibrating ones; if both vertical and lateral body vibrations are desired in a single body, two bodies are input at the same location with corresponding NZ and NY.

A slender body, as defined here, is a frustum of a right angle cone; there are (NF - 1) slender body elements.

6.3.14.1 NSTRIP, NPR1, JSPECS, NSV, NBV, NYAW Format (6I5)

1. Description: General aerodynamics data.

2. Notes:

- NSTRIP = number of chordwise strips of panel elements on all panels.
For LC(8) = 0, set NSTRIP = 1
Printouts of lift and moment coefficients for the strips occur for NSTRIP > 1
Never set NSTRIP = 0
- NPR1 = print option for pressures in subroutines QUAS or FUTSOL. Use only for debugging
= 1, print
= 0, no print
- JSPECS = index describing plane's aerodynamic symmetry about Z = 0
= 1, antisymmetrical aerodynamics about Z = 0 (biplane or jet effect)
= -1, symmetrical about Z = 0 (ground effect)
= 0, no symmetry about plane Z = 0
- NSV = number of strips lying on all vertical panels on the symmetric plane Y = 0
- NBV = number of elements on all vertical panels lying on the plane Y = 0
- NYAW = symmetry flag
= 0, if NDELTA = 1 (symmetric about Y = 0)
= 1, if NDELTA = -1 (antisymmetric about Y = 0)
= 0 or 1, if NDELTA = 0 (asymmetric about Y = 0)

The total number of strips, summed over all panels, may not exceed 150 regardless of the value of NSTRIP.

6.3.14.1.1 (LIM(I,1), LIM(I,2), LIM(I,3), I = 1, NSTRIP)
Format (3I3)

1. Description: NSTRIP sets of data defining chordwise strips for aerodynamic coefficient calculations.

2. Notes:

LIM(I,1) = index of first element on each chordwise strip

LIM(I,2) = index of last element on each chordwise strip

LIM(I,3) = 0

For NSTRIP = 1, a blank card is used.

6.3.15.1 6.3.15.1.1 to 6.3.15.1.2 are repeated for LC(3) sets of primary surface data.

6.3.15.1.1 KSURF, NBOXS, NCS
Format (1L5, 2I5)

6.3.15.1.2 NLINES, NELAXS, NICH, NISP
Format (4I5)

6.3.15.2 6.3.15.2.1 and 6.3.15.2.2 are repeated for NLINES subsets of data.

6.3.15.2.1 NGP, XTERM1, YTERM1, XTERM2, YTERM2
Format (I5, 4E10.0)

6.3.15.2.2 (YGP(I), I = 1, NGP)
Format (8E10.0)

6.3.15.3.1 DIST (Required if NELAXS = 1)
Format (E10.0)

6.3.15.3.2 (X1(I), Y1(I), X2(I), Y2(I), I = 1, NCS) (Required if KSURF = T)
Format (4E10.0)

6.3.15.3.3 NLINES, NELAXS, NICH, NISP (Required if KSURF = T)
Format (4I5)

6.3.15.4 6.3.15.4.1 and 6.3.15.4.2 are repeated for NLINES subsets of data. (Required if KSURF = T)

6.3.15.4.1 NGP, XTERM1, YTERM1, XTERM2, YTERM2
Format (I5, 4E10.0)

6.3.15.4.2 (YGP(I), I = 1, NGP)
Format (8E10.0)

6.3.15.5 DIST (Required if NELAXS = 1 and KSURF = T)
Format (E10.0)

1. Description: LC(3) sets of input modal vector data to be applied to interpolation of deflections for primary and control surface aerodynamic elements.

2. Notes:

- KSURF = flag indicating control surfaces on a primary surface
= T, this surface has one or more control surfaces with forward hinge lines
= F, this surface has no control surfaces
- NBOXS = number of elements on this surface, including those on control surfaces
- NCS = number of control surfaces on primary surface
 $0 \leq NCS \leq 5$
- NLINES = number of lines along which input modal vector data are prescribed
 $1 \leq NLINES \leq 20$
- NELAXS = index defining input vector components
= 1, translation and pitch rotation are prescribed at each input point
= 0, only translation is prescribed
- NICH = index defining chordwise interpolation-extrapolation from input vector to aerodynamic elements
= 0, linear
= 1, quadratic
= 2, cubic
- NISP = index defining spanwise interpolation-extrapolation from input vector to aerodynamic elements
= 0, linear
= 1, quadratic
= 2, cubic
- NGP = number of points on an input vector line
 $2 \leq NGP \leq 12$
- XTERM1 = X-coordinate specifying the inboard end of an input vector line in the local coordinate system
- YTERM1 = Y-coordinate specifying the inboard end of an input vector line in the local coordinate system

- XTERM2 = X-coordinate specifying the outboard end of an input vector line in the local coordinate system
- YTERM2 = Y-coordinate specifying the outboard end of an input vector line in the local coordinate system
- YGP(I) = spanwise coordinate of a point along an input vector line, going inboard to outboard in the local coordinate system
- X1(I) = X-coordinate of the inboard terminus of the Ith control surface leading edge in LCS
- Y1(I) = Y-coordinate of the inboard terminus of the Ith control surface leading edge in LCS
- X2(I) = X-coordinate of the outboard terminus of the Ith control surface leading edge in LCS
- Y2(I) = Y-coordinate of the outboard terminus of the Ith control surface leading edge in LCS
- DIST = displacement reference distance

6.3.16.1 The following sets of data are repeated NB times. (Required if NB > 0)

6.3.16.1.1 NGP, NSTRIP, IPANEL
Format (3I5)

6.3.16.1.2 (XGP(I), I = 1, NGP)
Format (6F10.0)

1. Description: NB sets of data describing input modal vector to be applied to slender body aerodynamic elements deflection.

2. Notes:

NGP = number of points on a slender body axis at which input vector data are prescribed
 $2 \leq \text{NGP} \leq 20$

NSTRIP = number of interference panels (or strips) associated with a slender body

IPANEL = index of the first such interference panel associated with a slender body

XGP(I) = streamwise coordinate of each point at which input modal data are prescribed, in LCS

This data is not to be input for a constant pressure method model

6.3.17.1 KLUGLB Format (I5)

1. Description: Print option for global geometry.
2. Notes:

KLUGLB = print option for aerodynamic elements in global coordinate system
= 1, print
= 0, no print

6.3.18 NOTES ON PROGRAM USAGE

Aerodynamic Modules

The STARS aerodynamic module consists of two unsteady, linear, inviscid, aerodynamic codes: the doublet lattice method (DLM) for subsonic analyses, and the constant pressure method (CPM) (ref. 14) for supersonic analyses. Flutter and divergence solutions may be obtained by k, p-k, or state-space methods.

Aerodynamic Modeling

The aerodynamic elements on lifting and interfering surfaces consist of trapezoidal elements parallel to the free stream. The aspect ratio of an element should ideally be on the order of unity or less.

The number of elements required for accurate analysis varies with the model and the reduced frequency values. Increasing the number of elements will increase the computational time. Higher reduced frequencies require smaller and, therefore, more elements. A guide for element size in the streamwise direction is

$$\Delta x k \leq 0.04,$$

where k is reduced frequency, and Δx is element length.

Elements should be concentrated near wing tips, leading and trailing edges, control surface hinges, and so forth. As a guide, a cosine distribution of elements over the wing's chord and full span may be adopted.

The total number of aerodynamic elements, including any slender body elements, may not exceed 400. Similarly, the total number of strips is limited to 150, whereas the number of modes in the analysis may not exceed 20.

The surface element may be thought of as having an unsteady horseshoe vortex bound along the quarter chord of the element and trailing aft to infinity. The downwash from the unsteady vortices are calculated at a control point located at the three-quarter chord of an element's centerline. Since the induced downwash at the center of a vortex is infinite, no control point should ever lie on any vortex line, such as along the extension of any element edge, either upstream or downstream.

Purpose: Prepare CONVERT.DAT data file; selection of desired modes.

Description: Enables selection of desired modes.

6.4.1 \$ JOB TITLE
Format (FREE)

6.4.2 NM
Format (I5)

1. Description: General data.

2. Notes:

NM = total number of desired modes to form reduced generalized matrices

6.4.3 \$ MODAL SELECTION AND ORDERING
Format (FREE)

6.4.3.1 IOLD, INEW
Format (2I5)

1. Description: Orders the modes to be used for ASE analysis, NM sets of data.

2. Notes:

IOLD = old modal number

INEW = new modal number

3. Notes:

Output is the reduced generalized force matrix and is stored in PD.DAT file for subsequent input into the ASE module.

Purpose: Prepare PADE.DAT data file.

Description: Performs Padé curve fitting of unsteady aerodynamic forces and state-space matrix formulation.

6.5.1 \$ JOB TITLE
Format (FREE)

6.5.2 NRM, NEM, NCM, NG, NS, NK, NA, RHOR, VEL, CREF, IWNDT, NQD
Format (FREE)

1. Description: General input data.

2. Notes:

NRM = number of rigid body modes

NEM = number of elastic modes

NCM = number of control modes

NG = number of gusts

NS = number of sensors

NK = number of sets of input data at discrete reduced frequencies

NA = order of Padé equation
 $0 \leq NA \leq 4$

RHOR = relative aerodynamic density with respect to sea level

VEL = true airspeed, ft/sec

CREF = reference chord, ft

IWNDT = wind tunnel correction index
= 0, uses formulation as in reference 13
= 1, uses wind tunnel data to modify aerodynamic generalized force matrix as in reference 13

NQD = number of velocities for flutter and divergence analysis, to be set to 0 for ASE analysis as in reference 13

6.5.3 \$ TENSION COEFFICIENTS
Format (FREE)

6.5.3.1 (BETA(I), I = 1, NA)
Format (FREE)

1. Description: Padé approximate's data.

2. Notes:

BETA(I) = tension coefficients

6.5.4 \$ GENERALIZED MASSES
Format (FREE)

6.5.4.1 ((GMASS(I, J), J = I, NM), I = 1, NM)
Format (FREE)

1. Description: Generalized mass data, upper symmetric half, starting with diagonal element.

2. Notes:

NM = total number of modes
= NRM + NEM + NCM

GMASS(I) = generalized mass of mode I, slugs

6.5.5 \$ GENERALIZED DAMPING
Format (FREE)

6.5.5.1 (DAMP(I), I = 1, NM)
Format (FREE)

1. Description: Generalized damping data.

2. Notes:

DAMP(I) = generalized damping applied to mode I

6.5.6 \$ NATURAL FREQUENCIES
Format (FREE)

6.5.6.1 (OMEGA(I), I = 1, NM)
Format (FREE)

1. Description: Modal frequency data.

2. Notes:

OMEGA(I) = natural frequency of mode I, rad/sec

6.5.7 \$ VELOCITIES FOR FLUTTER AND DIVERGENCE ANALYSIS (Required if NQD > 1)
Format (FREE)

6.5.7.1 (VEL(I), I = 1, NQD) (Required if NQD > 0)
Format (FREE)

1. Description: True airspeed data for flutter and divergence analysis, ft/sec.
2. Notes:

VEL(I) = airspeed at which to solve a matrix for frequency and damping

6.5.8 \$ AIRCRAFT ANGLES, DEGREES OF FREEDOM (Required if NQD = 0)
Format (FREE)

6.5.8.1 PHI, THETA, PSI, US, VS, WS, PS, QS, RS, PHID, THAD, PSID, NDOF (Required if NQD = 0)
Format (FREE)

1. Description: Data for transformation of earth- to body-centered coordinate systems.
2. Notes:

PHI = roll angle, deg

THETA = pitch angle, deg

PSI = yaw angle, deg

US, VS, WS = body axes velocities

PS, QS, RS = angular rates

PHID, THAD, PSID = Euler angle rates

NDOF = number of aircraft degrees of freedom; a negative sign indicates antisymmetric case

6.5.9 \$ SENSOR DATA (Required if NQD = 0 and NS > 0)
Format (FREE)

6.5.9.1 IFLSI
Format (FREE)

1. Description: Flag for identification of sensor interpolation points in presence of GVS data only.
2. Notes:

IFLSI = 1, for antisymmetric case

= -1, for symmetric case
= 0, for non-GVS case

6.5.9.2 XS, YS, ZS
Format (FREE)

(Required if NQD = 0 and NS > 0)

LX, MY, NZ, THX, THY, THZ
Format (FREE)

1. Description: Sensor location and orientation; NS sets of data.
2. Notes:

XS = X-coordinate of sensor
YS = Y-coordinate of sensor
ZS = Z-coordinate of sensor
LX = direction cosine for accelerometer normal in X
MY = direction cosine for accelerometer normal in Y
NZ = direction cosine for accelerometer normal in Z
THX = direction cosine for pitch axis about X
THY = direction cosine for pitch axis about Y
THZ = direction cosine for pitch axis about Z

3. Notes:

For the case IFLSI \neq 0, the user must modify file VEC_AND_COORDS.DAT by defining appropriate sensor location. This is done by setting the fourth column of the relevant nodes in the nodal coordinates section of the data file to the appropriate value of IFLSI.

Purpose: Prepare frequency response analysis data file.

6.6.1 \$ JOB TITLE
Format (FREE)

6.6.2 NX, NY, NU, NV, NXC, DELTAT, TDELAY, MAXBC, MAXPO
Format (FREE)

1. Description: System parameters.

2. Notes:

NX = number of states in the plant
= $[2*(NRM + NEM) + NA*(NRM + NEM + NCM)]$ (Refer to section 6.5)

NY = number of outputs from the plant
= (number of rows of C matrix)
= $(2*NS*3)$

NU = number of inputs to the plant
= $(2*NCM)$

NV = number of external inputs to the system

NXC = total number of continuous states (plant plus analog elements)

DELTAT = sample time for digital elements

TDELAY = system time delay

MAXBC = maximum number of block connectivity

MAXPO = maximum polynomial order plus one

6.6.3 NB, NYBTUV, IADDRA, IADDCB, IADDRC, NLST, NDRESP, IRP, ITRP
Format (FREE)

1. Notes:

NB = number of analog and digital elements in the system including the summing elements and excluding the plant

NYBTUV = NYTOV + NBTOU (See section 6.6.10.2 for definitions.)

IADDRA = additional rows of A due augmentation of control elements. Appropriate summation of orders of polynomial of all analog elements for open- as well as closed-loop solutions to be derived from block connectivity input.

- IADDCB = additional columns of B due augmentation of control elements
- IADDRC = additional rows of C due augmentation of control elements, equal to the number of connecting links into block/connecting junction
- NLST = total number of frequency range specifications for frequency response computations
- NDRESP = number of times the loops are broken for open-loop response evaluation
- IRP = frequency response problem number to be evaluated
- ITRP = total number of frequency response cases

6.6.4.1 \$ BLOCK CONNECTIVITY

Format (FREE)

1. Note:

Analog blocks to precede digital blocks

6.6.4.2 IBN, ICN1, ICN2, ICN3, IEXI, ISLPCL, IELPCL

Format (7I5)

1. Notes:

- IBN = integer defining block number
- ICN1, ICN2, ICN3 = connecting block numbers, up to 3
- IEXI = integer defining external input number
- ISLPCL = integer defining starting block of the closed-loop system
- IELPCL = integer defining closing block of the closed-loop system

2. Notes:

A symbolic gain block indicating closing of loop is identified by presence of starting and closing blocks.

6.6.5.1 \$ TRANSFER FUNCTION DESCRIPTION, AS ORDER OF POLYNOMIALS, FOR EACH BLOCK

Format (FREE)

1. Notes:

The polynomial descriptions pertain to either analog or digital elements, as appropriate.

6.6.5.2 IBN, ICNP, ICDP
Format (3I5)

1. Notes:

ICNP = integer defining number of coefficients in the numerator polynomial

ICDP = integer defining number of coefficients in the denominator polynomial

6.6.6.1 \$ LISTING OF POLYNOMIAL COEFFICIENTS
Format (FREE)

6.6.6.2 IBN, (POLCON(I), I=1, MAXPO)
Format (I5, < MAXPO > (E10.4))
IBN, (POLCOD(I), I=1, MAXPO)
Format (I5, <MAXPO > (E10.4))

1. Notes:

1. The coefficients are to be listed in increasing order of polynomials.
2. The numerator coefficients (POLCON) are placed in one row followed by the denominator (POLCOD) ones in the next row, for each block, one block at a time.
3. Data to be prepared for each block, NB sets of data being the input.

6.6.7.1 \$ GAIN INPUTS FOR EACH BLOCK
Format (FREE)

6.6.7.2 IBN, GAIN
Format (5(I5, E10.4))

1. Notes:

Gains may alternatively be the input as multiplier of polynomial coefficients in the numerator. NB sets of data are the input.

6.6.8.1 \$ SPECIFICATION FOR SYSTEM OUTPUTS, NYB = NY + NB NUMBER OF DATA
Format (FREE)

6.6.8.2 ISO1, ISO2, . . . , ISONYB
Format (16I5)

1. Description: This data is needed for closed-loop frequency response analysis only.

2. Notes:

1. Plant output are numbered 1 through NY.
2. Each block output is numbered as NY + IBN.

3. Notes:

ISOI = desired output from any sensor (corresponding row of **C** matrix for the plant) and any control element (augmented thereafter)

6.6.9.1 \$ SPECIFICATION FOR SYSTEM INPUTS, NUV = NU + NV NUMBER OF DATA
Format (FREE)

6.6.9.2 ISI1, ISI2, . . . , ISINUV
Format (16I5)

1. Notes:

1. Plant input are numbered 1 through NU.
2. Each block input is numbered as NU + IEXI.

2. Notes:

ISII = plant input (corresponding column of **B** matrix for the plant) and external input

6.6.10.1 \$ CONNECTION DETAILS FROM PLANT TO BLOCKS
Format (FREE)

6.6.10.2 NYTOV, NBTOU, NB TOK
Format (3I5)

1. Notes:

NYTOV = number of connections from plant outputs to external inputs

NBTOU = number of block outputs connected to plant inputs

NB TOK = number of digital element outputs connected to analog element inputs

6.6.10.3 IYTOV1, IYTOV2
Format (2I5)

1. Notes:

IYTOV1 = row number of **C** matrix corresponding to output from plant to feedback control system

IYTOV2 = external input number which describes connection of plant output to control system

2. Notes:

Repeat NYTOV times, ISO to IEXI.

6.6.10.4 IBTOU1, IBTOU2
Format (2I5)

1. Notes:

IBTOU1 = block number to be connected to plant input

IBTOU2 = column of **B** matrix to which block is connected

2. Notes:

Output NBTOU times, IBN to ISI.

6.6.10.5 IBTOK1, IBTOK2
Format (2I5)

1. Notes:

Output NB TOK times, IBN (ANALOG) to IBN (DIGITAL).

6.6.11.1 \$ FREQUENCY RANGE SPECIFICATION
Format (FREE)

(Required if NLST \neq 0)

6.6.11.2 FREQI, FREQF, NFREQ
Format (3I5)

1. Notes:

FREQI = initial frequency

FREQF = final frequency

NFREQ = number of frequencies within range, logarithmically spaced

NFREQ = number of frequencies within range, logarithmically spaced

2. Notes:

Data to be repeated NLST times

6.6.12.1 \$ LOOP DEFINITIONS
Format (FREE)

6.6.12.2 ILOOP, IPRINT
Format (FREE)

6.6.12.3 NBRAK1, NBRAK2
Format (2I5)

(Required if ILOOP = 1)

1. Notes:

ILOOP = integer defining loop type
= 0, for closed loop case
= 1, for open loop case

IPRINT = eigensolution print option for closed loop case
= 0, prints eigenvalues only
= 1, prints eigenvalues and vectors

NBRAK1 = block having the output signal

NBRAK2 = block having the input signal

2. Notes:

This data is needed for ILOOP = 1 case, only.
Data of 6.6.12.3 to be repeated NDRESP times.

7. SAMPLE PROBLEMS (STARS Integrated Aero-Structural-Control Systems Analysis)

A simplified aircraft test model (ATM) is selected as a standard problem for the full spectrum of ASE analyses. In this section, the relevant data (fig. 22) for associated SOLIDS, AERO, and ASE modules are presented in detail. Each such data set is also followed by relevant output of results. The input data are prepared in accordance with procedures described in section 6.

Three perfect rigid body modes (Y-translation, X-rotation roll, and Z-rotation yaw about center of gravity - Φ_{PR}) and two rigid control modes (aileron and rudder deflections - Φ_C) are generated in this module along with eight elastic (Φ_E) and three usual rigid body modes (Φ_R), of which the latter are excluded from consideration as GENMASS data input. The perfect rigid body modes Φ_{PR} are moved in the front through convert data input for subsequent ASE analysis ($\Phi = \Phi_{PR} + \Phi_E + \Phi_C$).

7.1 ATM: Free Vibration Analysis (STARS-SOLIDS)

These input data pertain to the free vibration analysis of the finite element model. The direct modal interpolation option is used for subsequent flutter and ASE analyses.

The finite element model (fig. 23) of the symmetric half of the aircraft is utilized for the vibration analysis; only the typical antisymmetric case is presented here. Figure 24 shows a direct interpolation scheme for subsequent aeroelastic and aeroservoelastic analyses.

STARS-SOLIDS input data:

```

AERO TEST MODEL
C
C ANTISYMMETRIC HALF MODEL
C IINTP = 1, DIRECT INTERPOLATION OF MODAL DATA
C
C NCONTAL = 5, FIRST THREE TO GENERATE PERFECT RIGID BODY MODES
C Y TRANSLATION, ROLL AND YAW, PLUS AILERONS AND RUDDER CONTROL
C MODES.
C ////////////////////////////////////////////////////////////////////
74, 149, 1, 4, 22, 5, 0, 0, 0, 0
0, 0, 0, 0, 0, 0, 5, 132, 0
1, 1, 0, 0, 0, 1, 0, 1
2, 0, 2, 0, 1
1, 15, 0, 0.7500E+03, 0.0000E+00, 0.0
$ MODAL DATA
1 300.0000 200.0000 0.0000 0 0 0 0 0 0 0 0
2 312.5000 200.0000 0.0000 0 0 0 0 0 0 0 0
3 325.0000 200.0000 0.0000 0 0 0 0 0 0 0 0
4 337.5000 200.0000 0.0000 0 0 0 0 0 0 0 0
5 350.0000 200.0000 0.0000 0 0 0 0 0 0 0 0
6 287.5000 150.0000 0.0000 0 0 0 0 0 0 0 0
7 303.1250 150.0000 0.0000 0 0 0 0 0 0 0 0
8 318.7500 150.0000 0.0000 0 0 0 0 0 0 0 0
9 334.3750 150.0000 0.0000 0 0 0 0 0 0 0 0
10 350.0000 150.0000 0.0000 0 0 0 0 0 0 0 0
11 335.3750 149.0000 0.0000 0 0 0 0 0 0 0 0
12 350.0000 149.0000 0.0000 0 0 0 0 0 0 0 0
13 275.0000 100.0000 0.0000 0 0 0 0 0 0 0 0
14 293.7500 100.0000 0.0000 0 0 0 0 0 0 0 0
15 312.5000 100.0000 0.0000 0 0 0 0 0 0 0 0
16 331.2500 100.0000 0.0000 0 0 0 0 0 0 0 0
17 332.2500 100.0000 0.0000 0 0 0 0 0 0 0 0
18 350.0000 100.0000 0.0000 0 0 0 0 0 0 0 0
19 262.5000 50.0000 0.0000 0 0 0 0 0 0 0 0
20 284.3750 50.0000 0.0000 0 0 0 0 0 0 0 0
21 306.2500 50.0000 0.0000 0 0 0 0 0 0 0 0

```

22	328.1250	50.0000	0.0000	0	0	0	0	0	0	0	0	0	0
23	329.1250	51.0000	0.0000	0	0	0	0	0	0	0	0	0	0
24	350.0000	51.0000	0.0000	0	0	0	0	0	0	0	0	0	0
25	350.0000	50.0000	0.0000	0	0	0	0	0	0	0	0	0	0
26	250.0000	0.0000	0.0000	1	0	1	0	1	0	0	0	0	0
27	275.0000	0.0000	0.0000	1	0	1	0	1	0	0	0	0	0
28	300.0000	0.0000	0.0000	1	0	1	0	1	0	0	0	0	0
29	325.0000	0.0000	0.0000	1	0	1	0	1	0	0	0	0	0
30	350.0000	0.0000	0.0000	1	0	1	0	1	0	0	0	0	0
31	200.0000	0.0000	0.0000	1	0	1	0	1	0	0	0	0	0
32	400.0000	0.0000	0.0000	1	0	1	0	1	0	0	0	0	0
33	150.0000	0.0000	0.0000	1	0	1	0	1	0	0	0	0	0
34	450.0000	0.0000	0.0000	1	0	1	0	1	0	0	0	0	0
35	100.0000	0.0000	0.0000	1	0	1	0	1	0	0	0	0	0
36	500.0000	0.0000	0.0000	1	0	1	0	1	0	0	0	0	0
37	50.0000	0.0000	0.0000	1	0	1	0	1	0	0	0	0	0
38	560.0000	0.0000	0.0000	1	0	1	0	1	0	0	0	0	0
39	0.0000	0.0000	0.0000	1	0	1	0	1	0	0	0	0	0
40	600.0000	0.0000	0.0000	1	0	1	0	1	0	0	0	0	0
41	520.0000	0.0000	50.0000	1	0	1	0	1	0	0	0	0	0
42	580.0000	100.0000	0.0000	0	0	0	0	0	0	0	0	0	0
43	555.0000	0.0000	50.0000	1	0	1	0	1	0	0	0	0	0
44	520.0000	20.0000	0.0000	0	0	0	0	0	0	0	0	0	0
45	580.0000	0.0000	20.0000	1	0	1	0	1	0	0	0	0	0
46	560.0000	20.0000	0.0000	0	0	0	0	0	0	0	0	0	0
47	600.0000	0.0000	20.0000	1	0	1	0	1	0	0	0	0	0
48	600.0000	20.0000	0.0000	0	0	0	0	0	0	0	0	0	0
49	540.0000	0.0000	100.0000	1	0	1	0	1	0	0	0	0	0
50	526.6666	46.6667	0.0000	0	0	0	0	0	0	0	0	0	0
51	580.0000	0.0000	50.0000	1	0	1	0	1	0	0	0	0	0
52	560.0000	46.6667	0.0000	0	0	0	0	0	0	0	0	0	0
53	581.0000	0.0000	21.0000	1	0	1	0	1	0	0	0	0	0
54	600.0000	46.6667	0.0000	0	0	0	0	0	0	0	0	0	0
55	600.0000	0.0000	21.0000	1	0	1	0	1	0	0	0	0	0
56	533.3331	73.3333	0.0000	0	0	0	0	0	0	0	0	0	0
57	565.0000	0.0000	100.0000	1	0	1	0	1	0	0	0	0	0
58	560.0000	73.3333	0.0000	0	0	0	0	0	0	0	0	0	0
59	580.0000	0.0000	80.0000	1	0	1	0	1	0	0	0	0	0
60	600.0000	73.3333	0.0000	0	0	0	0	0	0	0	0	0	0
61	581.0000	0.0000	79.0000	1	0	1	0	1	0	0	0	0	0
62	540.0000	100.0000	0.0000	0	0	0	0	0	0	0	0	0	0
63	600.0000	0.0000	79.0000	1	0	1	0	1	0	0	0	0	0
64	560.0000	100.0000	0.0000	0	0	0	0	0	0	0	0	0	0
65	600.0000	0.0000	100.0000	1	0	1	0	1	0	0	0	0	0
66	600.0000	100.0000	0.0000	0	0	0	0	0	0	0	0	0	0
67	600.0000	0.0000	80.0000	1	0	1	0	1	0	0	0	0	0
68	580.0000	73.3333	0.0000	0	0	0	0	0	0	0	0	0	0
69	580.0000	46.6667	0.0000	0	0	0	0	0	0	0	0	0	0
70	580.0000	20.0000	0.0000	0	0	0	0	0	0	0	0	0	0
71	581.0000	100.0000	0.0000	0	0	0	0	0	0	0	0	0	0
72	581.0000	73.3333	0.0000	0	0	0	0	0	0	0	0	0	0
73	581.0000	46.6667	0.0000	0	0	0	0	0	0	0	0	0	0
74	581.0000	20.0000	0.0000	0	0	0	0	0	0	0	0	0	0

\$ ELEMENT CONNECTIVITY CONDITIONS

2	1	6	7	2	1	0	0	0	0	1	1	0	0	0	0
2	2	7	8	3	2	0	0	0	0	1	1	0	0	0	0
2	3	8	9	4	3	0	0	0	0	1	1	0	0	0	0
2	4	9	10	5	4	0	0	0	0	1	1	0	0	0	0
2	5	13	14	7	6	0	0	0	0	1	1	0	0	0	0
2	6	14	15	8	7	0	0	0	0	1	1	0	0	0	0
2	7	15	16	9	8	0	0	0	0	1	1	0	0	0	0
2	8	19	20	14	13	0	0	0	0	1	1	0	0	0	0
2	9	20	21	15	14	0	0	0	0	1	1	0	0	0	0
2	10	21	22	16	15	0	0	0	0	1	1	0	0	0	0
2	11	26	27	20	19	0	0	0	0	1	1	0	0	0	0
2	12	27	28	21	20	0	0	0	0	1	1	0	0	0	0
2	13	28	29	22	21	0	0	0	0	1	1	0	0	0	0
2	14	29	30	25	22	0	0	0	0	1	1	0	0	0	0
2	15	17	18	12	11	0	0	0	0	1	2	0	0	0	0
2	16	23	24	18	17	0	0	0	0	1	2	0	0	0	0
1	17	1	2	39	0	0	0	0	0	1	11	0	0	0	0
1	18	2	3	39	0	0	0	0	0	1	11	0	0	0	0
1	19	3	4	39	0	0	0	0	0	1	1	0	0	0	0
1	20	4	5	39	0	0	0	0	0	1	1	0	0	0	0
1	21	6	7	39	0	0	0	0	0	1	11	0	0	0	0
1	22	7	8	39	0	0	0	0	0	1	11	0	0	0	0
1	23	8	9	39	0	0	0	0	0	1	1	0	0	0	0
1	24	9	10	39	0	0	0	0	0	1	1	0	0	0	0
1	25	6	1	39	0	0	0	0	0	1	11	0	0	0	0
1	26	7	2	39	0	0	0	0	0	1	11	0	0	0	0
1	27	8	3	39	0	0	0	0	0	1	1	0	0	0	0

1	28	9	4	39	0	0	0	0	0	1	1	0	0	0	0
1	29	10	5	39	0	0	0	0	0	1	1	0	0	0	0
1	30	13	14	39	0	0	0	0	0	1	11	0	0	0	0
1	31	14	15	39	0	0	0	0	0	1	11	0	0	0	0
1	32	15	16	39	0	0	0	0	0	1	1	0	0	0	0
1	33	13	6	39	0	0	0	0	0	1	11	0	0	0	0
1	34	14	7	39	0	0	0	0	0	1	11	0	0	0	0
1	35	15	8	39	0	0	0	0	0	1	1	0	0	0	0
1	36	16	9	39	0	0	0	0	0	1	1	0	0	0	0
1	37	19	20	1	0	0	0	0	0	1	11	0	0	0	0
1	38	20	21	1	0	0	0	0	0	1	11	0	0	0	0
1	39	21	22	1	0	0	0	0	0	1	1	0	0	0	0
1	40	22	25	1	0	0	0	0	0	1	1	0	0	0	0
1	41	19	13	39	0	0	0	0	0	1	11	0	0	0	0
1	42	20	14	39	0	0	0	0	0	1	11	0	0	0	0
1	43	21	15	39	0	0	0	0	0	1	1	0	0	0	0
1	44	22	16	39	0	0	0	0	0	1	1	0	0	0	0
1	45	26	27	1	0	0	0	0	0	1	11	0	0	0	0
1	46	27	28	1	0	0	0	0	0	1	11	0	0	0	0
1	47	28	29	1	0	0	0	0	0	1	1	0	0	0	0
1	48	29	30	1	0	0	0	0	0	1	1	0	0	0	0
1	49	26	19	39	0	0	0	0	0	1	11	0	0	0	0
1	50	27	20	39	0	0	0	0	0	1	11	0	0	0	0
1	51	28	21	39	0	0	0	0	0	1	1	0	0	0	0
1	52	29	22	39	0	0	0	0	0	1	1	0	0	0	0
1	53	30	25	39	0	0	0	0	0	1	1	0	0	0	0
1	54	11	12	39	0	0	0	0	0	1	2	0	0	0	0
1	55	17	18	39	0	0	0	0	0	1	2	0	0	0	0
1	56	23	24	39	0	0	0	0	0	1	2	0	0	0	0
1	57	23	17	39	0	0	0	0	0	1	2	0	0	0	0
1	58	17	11	39	0	0	0	0	0	1	2	0	0	0	0
1	59	24	18	39	0	0	0	0	0	1	2	0	0	0	0
1	60	18	12	39	0	0	0	0	0	1	2	0	0	0	0
1	61	11	9	39	0	0	0	0	0	1	5	0	0	0	0
1	62	16	17	39	0	0	0	0	0	1	5	0	0	0	0
1	63	22	23	1	0	0	0	0	0	1	5	0	0	0	0
2	64	56	58	64	62	0	0	0	0	1	3	0	0	0	0
2	65	58	68	42	64	0	0	0	0	1	3	0	0	0	0
2	66	50	52	58	56	0	0	0	0	1	3	0	0	0	0
2	67	52	69	68	58	0	0	0	0	1	3	0	0	0	0
2	68	44	46	52	50	0	0	0	0	1	3	0	0	0	0
2	69	46	70	69	52	0	0	0	0	1	3	0	0	0	0
1	70	62	64	1	0	0	0	0	0	1	3	0	0	0	0
1	71	64	42	1	0	0	0	0	0	1	3	0	0	0	0
1	72	56	58	1	0	0	0	0	0	1	3	0	0	0	0
1	73	58	68	1	0	0	0	0	0	1	3	0	0	0	0
1	74	56	62	1	0	0	0	0	0	1	3	0	0	0	0
1	75	58	64	1	0	0	0	0	0	1	3	0	0	0	0
1	76	60	66	1	0	0	0	0	0	1	2	0	0	0	0
1	77	50	52	1	0	0	0	0	0	1	3	0	0	0	0
1	78	52	69	1	0	0	0	0	0	1	3	0	0	0	0
1	79	50	56	1	0	0	0	0	0	1	3	0	0	0	0
1	80	52	58	1	0	0	0	0	0	1	3	0	0	0	0
1	81	54	60	1	0	0	0	0	0	1	2	0	0	0	0
1	82	44	46	1	0	0	0	0	0	1	3	0	0	0	0
1	83	46	70	1	0	0	0	0	0	1	3	0	0	0	0
1	84	44	50	1	0	0	0	0	0	1	3	0	0	0	0
1	85	46	52	1	0	0	0	0	0	1	3	0	0	0	0
1	86	48	54	1	0	0	0	0	0	1	2	0	0	0	0
3	87	36	38	43	0	0	0	0	0	1	4	0	0	0	0
3	88	36	43	41	0	0	0	0	0	1	4	0	0	0	0
2	89	41	43	57	49	0	0	0	0	1	4	0	0	0	0
2	90	38	45	51	43	0	0	0	0	1	4	0	0	0	0
2	91	43	51	59	57	0	0	0	0	1	4	0	0	0	0
2	92	38	40	47	45	0	0	0	0	1	4	0	0	0	0
2	93	59	67	65	57	0	0	0	0	1	4	0	0	0	0
2	94	53	55	63	61	0	0	0	0	1	5	0	0	0	0
1	95	36	41	1	0	0	0	0	0	1	4	0	0	0	0
1	96	41	49	1	0	0	0	0	0	1	4	0	0	0	0
1	97	36	43	1	0	0	0	0	0	1	4	0	0	0	0
1	98	43	57	1	0	0	0	0	0	1	4	0	0	0	0
1	99	49	57	1	0	0	0	0	0	1	4	0	0	0	0
1	100	38	43	1	0	0	0	0	0	1	4	0	0	0	0
1	101	38	45	1	0	0	0	0	0	1	4	0	0	0	0
1	102	45	51	1	0	0	0	0	0	1	4	0	0	0	0
1	103	41	43	1	0	0	0	0	0	1	4	0	0	0	0
1	104	43	51	1	0	0	0	0	0	1	4	0	0	0	0
1	105	51	59	1	0	0	0	0	0	1	4	0	0	0	0
1	106	59	57	1	0	0	0	0	0	1	4	0	0	0	0
1	107	59	67	1	0	0	0	0	0	1	4	0	0	0	0
1	108	57	65	1	0	0	0	0	0	1	4	0	0	0	0

1	109	67	65	1	0	0	0	0	0	1	4	0	0	0	0
1	110	40	47	1	0	0	0	0	0	1	4	0	0	0	0
1	111	45	47	1	0	0	0	0	0	1	4	0	0	0	0
1	112	53	55	1	0	0	0	0	0	1	9	0	0	0	0
1	113	53	61	1	0	0	0	0	0	1	9	0	0	0	0
1	114	55	63	1	0	0	0	0	0	1	9	0	0	0	0
1	115	61	63	1	0	0	0	0	0	1	9	0	0	0	0
1	116	45	53	1	0	0	0	0	0	1	10	0	0	0	0
1	117	61	59	1	0	0	0	0	0	1	10	0	0	0	0
1	118	38	46	1	0	0	0	0	0	1	8	0	0	0	0
1	119	36	44	1	0	0	0	0	0	1	8	0	0	0	0
1	120	39	37	1	0	0	0	0	0	1	120	0	0	0	0
1	121	37	35	1	0	0	0	0	0	1	121	0	0	0	0
1	122	35	33	1	0	0	0	0	0	1	122	0	0	0	0
1	123	33	31	1	0	0	0	0	0	1	123	0	0	0	0
1	124	31	26	1	0	0	0	0	0	1	124	0	0	0	0
1	125	26	28	1	0	0	0	0	0	1	125	0	0	0	0
1	126	28	30	1	0	0	0	0	0	1	126	0	0	0	0
1	127	30	32	1	0	0	0	0	0	1	127	0	0	0	0
1	128	32	34	1	0	0	0	0	0	1	128	0	0	0	0
1	129	34	36	1	0	0	0	0	0	1	129	0	0	0	0
1	130	36	38	1	0	0	0	0	0	1	130	0	0	0	0
1	131	38	40	1	0	0	0	0	0	1	131	0	0	0	0
2	132	72	60	66	71	0	0	0	0	1	2	0	0	0	0
2	133	73	54	60	72	0	0	0	0	1	2	0	0	0	0
2	134	74	48	54	73	0	0	0	0	1	2	0	0	0	0
1	135	42	71	1	0	0	0	0	0	1	5	0	0	0	0
1	136	68	72	1	0	0	0	0	0	1	5	0	0	0	0
1	137	69	73	1	0	0	0	0	0	1	5	0	0	0	0
1	138	70	74	1	0	0	0	0	0	1	5	0	0	0	0
1	139	74	73	1	0	0	0	0	0	1	2	0	0	0	0
1	140	73	72	1	0	0	0	0	0	1	2	0	0	0	0
1	141	72	71	1	0	0	0	0	0	1	2	0	0	0	0
1	142	70	69	1	0	0	0	0	0	1	3	0	0	0	0
1	143	69	68	1	0	0	0	0	0	1	3	0	0	0	0
1	144	68	42	1	0	0	0	0	0	1	3	0	0	0	0
1	145	71	66	65	0	0	0	0	0	1	2	0	0	0	0
1	146	72	60	65	0	0	0	0	0	1	2	0	0	0	0
1	147	73	54	65	0	0	0	0	0	1	2	0	0	0	0
1	148	74	48	65	0	0	0	0	0	1	2	0	0	0	0
1	149	40	70	65	0	0	0	0	0	1	8	0	0	0	0

\$ LINE ELEMENT BASIC PROPERTIES

1	1.5000	37.5000	18.8000	18.8000
2	0.5300	3.8000	1.9000	1.9000
3	0.7500	19.0000	9.0000	9.0000
4	0.0600	1.5000	0.7500	0.7500
5	0.4000	1.5000	0.7500	0.7500
6	19.0000	750.0000	375.0000	375.0000
8	3.7500	1500.0000	750.0000	750.0000
9	0.0300	0.8000	0.4000	0.4000
10	0.0100	0.4000	0.2000	0.2000
11	1.1250	28.1250	14.0600	14.0600
120	11.2500	675.0	338.0	338.0
121	18.7500	900.0	900.0	900.0
122	18.7500	1050.0	1575.0	1575.0
123	18.7500	1200.0	2250.0	2250.0
124	18.7500	1650.0	2625.0	2625.0
125	18.7500	1875.0	1875.0	1875.0
126	18.7500	2250.0	1125.0	1125.0
127	18.7500	3000.0	1275.0	1275.0
128	18.7500	3000.0	1275.0	1275.0
129	18.7500	3000.0	1275.0	1275.0
130	16.5000	2250.0	975.0	975.0
131	15.0000	1500.0	675.0	675.0

\$ SHELL ELEMENT THICKNESSES

1	0.1130
2	0.0530
3	0.0900
4	0.0400
5	0.0100

\$ MATERIAL PROPERTIES

1	1			
1	1.E+07	0.30	0.	.259E-03

\$ NODAL MASS DATA

39	1	0.0195	3
37	1	0.0389	3
35	1	0.0584	3
33	1	0.0972	3
31	1	0.1943	3
26	1	0.2915	3
28	1	0.2915	3

30	1	0.2915	3
32	1	0.2915	3
34	1	0.2915	3
36	1	0.2915	3
38	1	0.2915	3
40	1	0.1943	3

-1

\$ OUTPUT POINT SPECIFICATION FOR DIRECT INTERPOLATION OF MODAL DATA

1	36		
2	36	41	
3	36	41	
4	41		
5	41	49	
6	41	49	
7	49		
8	36	38	
9	38	43	
10	38	43	
11	43		
12	43	57	
13	43	57	
14	57		
15	38	40	
16	45		
17	45	51	
18	51		
19	51	59	
20	59		
21	57	65	
22	67		
23	65		
24	53		
25	61		
26	55		
27	63		
28	26		
29	19	26	
30	19		
31	13	19	
32	13		
33	13		
34	6	13	
35	6		
36	1	6	
37	1	6	
38	1		
39	27		
40	20	27	
41	20		
42	14	20	
43	14		
44	14		
45	7	14	
46	7		
47	2	7	
48	2	7	
49	2		
50	28		
51	21	28	
52	21		
53	15	21	
54	15		
55	15		
56	8	15	
57	8		
58	3	8	
59	3	8	
60	3		
61	29		
62	22	29	
63	22		
64	16	22	
65	16		
66	16		
67	9	16	
68	9		
69	4	9	
70	4	9	
71	4		
72	30		
73	25	30	

74 25
 75 10
 76 5 10
 77 5 10
 78 5
 79 23
 80 17 23
 81 17
 82 17
 83 11 17
 84 11
 85 24
 86 18 24
 87 18
 88 18
 89 12 18
 90 12
 91 44
 92 50
 93 50 56
 94 56
 95 56 62
 96 62
 97 46
 98 52
 99 52 58
 100 58
 101 58 64
 102 64
 103 70
 104 69
 105 68 69
 106 68
 107 42 68
 108 42
 109 74
 110 73
 111 72 73
 112 72
 113 71 72
 114 71
 115 48
 116 54
 117 54 60
 118 60
 119 60 66
 120 66
 121 39
 122 35
 123 33
 124 31
 125 26
 126 28
 127 30
 128 32
 129 34
 130 36
 131 38
 132 40

\$ RIGID BODY CONTROL MODE DATA

1	2	-1.0	74	1	<--- RIGID BODY Y TRANSLATION
1	2	-0.6908			<--- RIGID BODY X ROTATION (ROLL)
1	3	16.6089			
1	4	1.0000			
2	2	-0.6908			
2	3	16.6089			
2	4	1.0000			
3	2	-0.6908			
3	3	16.6089			
3	4	1.0000			
4	2	-0.6908			
4	3	16.6089			
4	4	1.0000			
5	2	-0.6908			
5	3	16.6089			
5	4	1.0000			
6	2	-0.5181			
6	3	12.4567			
6	4	1.0000			
7	2	-0.5181			

7	3	12.4567
7	4	1.0000
8	2	-0.5181
8	3	12.4567
8	4	1.0000
9	2	-0.5181
9	3	12.4567
9	4	1.0000
10	2	-0.5181
10	3	12.4567
10	4	1.0000
11	2	-0.5147
11	3	12.3737
11	4	1.0000
12	2	-0.5147
12	3	12.3737
12	4	1.0000
13	2	-0.3454
13	3	8.3045
13	4	1.0000
14	2	-0.3454
14	3	8.3045
14	4	1.0000
15	2	-0.3454
15	3	8.3045
15	4	1.0000
16	2	-0.3454
16	3	8.3045
16	4	1.0000
17	2	-0.3454
17	3	8.3045
17	4	1.0000
18	2	-0.3454
18	3	8.3045
18	4	1.0000
19	2	-0.1727
19	3	4.1522
19	4	1.0000
20	2	-0.1727
20	3	4.1522
20	4	1.0000
21	2	-0.1727
21	3	4.1522
21	4	1.0000
22	2	-0.1727
22	3	4.1522
22	4	1.0000
23	2	-0.1762
23	3	4.2353
23	4	1.0000
24	2	-0.1762
24	3	4.2353
24	4	1.0000
25	2	-0.1727
25	3	4.1522
25	4	1.0000
26	4	1.0000
27	4	1.0000
28	4	1.0000
29	4	1.0000
30	4	1.0000
31	4	1.0000
32	4	1.0000
33	4	1.0000
34	4	1.0000
35	4	1.0000
36	4	1.0000
37	4	1.0000
38	4	1.0000
39	4	1.0000
40	4	1.0000
41	2	-4.1522
41	3	-0.1727
41	4	1.0000
42	2	-0.3454
42	3	8.3045
42	4	1.0000
43	2	-4.1522
43	3	-0.1727
43	4	1.0000
44	2	-0.0691

44	3	1.6609
44	4	1.0000
45	2	-1.6609
45	3	-0.0691
45	4	1.0000
46	2	-0.0691
46	3	1.6609
46	4	1.0000
47	2	-1.6609
47	3	-0.0691
47	4	1.0000
48	2	-0.0691
48	3	1.6609
48	4	1.0000
49	2	-8.3045
49	3	-0.3454
49	4	1.0000
50	2	-0.1612
50	3	3.8754
50	4	1.0000
51	2	-4.1522
51	3	-0.1727
51	4	1.0000
52	2	-0.1612
52	3	3.8754
52	4	1.0000
53	2	-1.7439
53	3	-0.0725
53	4	1.0000
54	2	-0.1612
54	3	3.8754
54	4	1.0000
55	2	-1.7439
55	3	-0.0725
55	4	1.0000
56	2	-0.2533
56	3	6.0899
56	4	1.0000
57	2	-8.3045
57	3	-0.3454
57	4	1.0000
58	2	-0.2533
58	3	6.0899
58	4	1.0000
59	2	-6.6436
59	3	-0.2763
59	4	1.0000
60	2	-0.2533
60	3	6.0899
60	4	1.0000
61	2	-6.5605
61	3	-0.2729
61	4	1.0000
62	2	-0.3454
62	3	8.3045
62	4	1.0000
63	2	-6.5605
63	3	-0.2729
63	4	1.0000
64	2	-0.3454
64	3	8.3045
64	4	1.0000
65	2	-8.3045
65	3	-0.3454
65	4	1.0000
66	2	-0.3454
66	3	8.3045
66	4	1.0000
67	2	-6.6436
67	3	-0.2763
67	4	1.0000
68	2	-0.2533
68	3	6.0899
68	4	1.0000
69	2	-0.1612
69	3	3.8754
69	4	1.0000
70	2	-0.0691
70	3	1.6609
70	4	1.0000
71	2	-0.3454

71	3	8.3045
71	4	1.0000
72	2	-0.2533
72	3	6.0899
72	4	1.0000
73	2	-0.1612
73	3	3.8754
73	4	1.0000
74	2	-0.0691
74	3	1.6609
74	4	1.0000

-1

1	1	16.5227
1	2	-2.7670
1	6	1.0000
2	1	16.4795
2	2	-3.8050
2	6	1.0000
3	1	16.4364
3	2	-4.8431
3	6	1.0000
4	1	16.3932
4	2	-5.8812
4	6	1.0000
5	1	16.3500
5	2	-6.9192
5	6	1.0000
6	1	12.4137
6	2	-1.5562
6	6	1.0000
7	1	12.3596
7	2	-2.8538
7	6	1.0000
8	1	12.3057
8	2	-4.1514
8	6	1.0000
9	1	12.2517
9	2	-5.4489
9	6	1.0000
10	1	12.1978
10	2	-6.7465
10	6	1.0000
11	1	12.1652
11	2	-5.5285
11	6	1.0000
12	1	12.1147
12	2	-6.7431
12	6	1.0000
13	1	8.3045
13	2	-0.3454
13	6	1.0000
14	1	8.2398
14	2	-1.9025
14	6	1.0000
15	1	8.1750
15	2	-3.4596
15	6	1.0000
16	1	8.1102
16	2	-5.0167
16	6	1.0000
17	1	8.1068
17	2	-5.0998
17	6	1.0000
18	1	8.0455
18	2	-6.5738
18	6	1.0000
19	1	4.1955
19	2	0.8654
19	6	1.0000
20	1	4.1199
20	2	-0.9512
20	6	1.0000
21	1	4.0443
21	2	-2.7679
21	6	1.0000
22	1	3.9688
22	2	-4.5845
22	6	1.0000
23	1	4.0483
23	2	-4.6710
23	6	1.0000

<--- RIGID BODY Z ROTATION (YAW) at 275 in.

24	1	3.9763
24	2	-6.4046
24	6	1.0000
25	1	3.8932
25	2	-6.4011
25	6	1.0000
26	1	0.0863
26	2	2.0761
26	6	1.0000
27	1	0.0000
27	2	0.0000
27	6	1.0000
28	1	-0.0864
28	2	-2.0761
28	6	1.0000
29	1	-0.1727
29	2	-4.1523
29	6	1.0000
30	1	-0.2591
30	2	-6.2284
30	6	1.0000
31	1	0.2591
31	2	6.2284
31	6	1.0000
32	1	-0.4318
32	2	-10.3807
32	6	1.0000
33	1	0.4318
33	2	10.3807
33	6	1.0000
34	1	-0.6045
34	2	-14.5330
34	6	1.0000
35	1	0.6045
35	2	14.5330
35	6	1.0000
36	1	-0.7772
36	2	-18.6852
36	6	1.0000
37	1	0.7772
37	2	18.6852
37	6	1.0000
38	1	-0.9845
38	2	-23.6680
38	6	1.0000
39	1	0.9499
39	2	22.8375
39	6	1.0000
40	1	-1.1227
40	2	-26.9898
40	6	1.0000
41	1	-0.8463
41	2	-20.3461
41	6	1.0000
42	1	7.2510
42	2	-25.6743
42	6	1.0000
43	1	-0.9672
43	2	-23.2527
43	6	1.0000
44	1	0.8146
44	2	-20.4152
44	6	1.0000
45	1	-1.0536
45	2	-25.3289
45	6	1.0000
46	1	0.6765
46	2	-23.7371
46	6	1.0000
47	1	-1.1227
47	2	-26.9898
47	6	1.0000
48	1	0.5383
48	2	-27.0589
48	6	1.0000
49	1	-0.9154
49	2	-22.0071
49	6	1.0000
50	1	3.0061
50	2	-21.0610
50	6	1.0000

51	1	-1.0536
51	2	-25.3289
51	6	1.0000
52	1	2.8910
52	2	-23.8291
52	6	1.0000
53	1	-1.0570
53	2	-25.4119
53	6	1.0000
54	1	2.7528
54	2	-27.1510
54	6	1.0000
55	1	-1.1227
55	2	-26.9898
55	6	1.0000
56	1	5.1977
56	2	-21.7067
56	6	1.0000
57	1	-1.0017
57	2	-24.0832
57	6	1.0000
58	1	5.1056
58	2	-23.9212
58	6	1.0000
59	1	-1.0536
59	2	-25.3289
59	6	1.0000
60	1	4.9674
60	2	-27.2431
60	6	1.0000
61	1	-1.0570
61	2	-25.4119
61	6	1.0000
62	1	7.3892
62	2	-22.3525
62	6	1.0000
63	1	-1.1227
63	2	-26.9898
63	6	1.0000
64	1	7.3201
64	2	-24.0134
64	6	1.0000
65	1	-1.1227
65	2	-26.9898
65	6	1.0000
66	1	7.1819
66	2	-27.3352
66	6	1.0000
67	1	-1.1227
67	2	-26.9898
67	6	1.0000
68	1	5.0365
68	2	-25.5822
68	6	1.0000
69	1	2.8219
69	2	-25.4901
69	6	1.0000
70	1	0.6074
70	2	-25.3980
70	6	1.0000
71	1	7.2475
71	2	-25.7573
71	6	1.0000
72	1	5.0330
72	2	-25.6652
72	6	1.0000
73	1	2.8185
73	2	-25.5731
73	6	1.0000
74	1	0.6039
74	2	-25.4810
74	6	1.0000
-1		
11	3	0.0833
17	3	0.0833
23	3	0.0833
24	3	1.8229
18	3	1.5625
12	3	1.3020
11	5	1.0
17	5	1.0

<--- AILERON DEFLECTION, T.E. UP

23 5 1.0
24 5 1.0
18 5 1.0
12 5 1.0
-1
53 2 -.08333
53 6 1.00000
61 2 -.08333
61 6 1.00000
55 2 -1.66667
55 6 1.00000
63 2 -1.66667
63 6 1.00000
-1

<--- RUDDER DEFLECTION, T.E. NEGATIVE

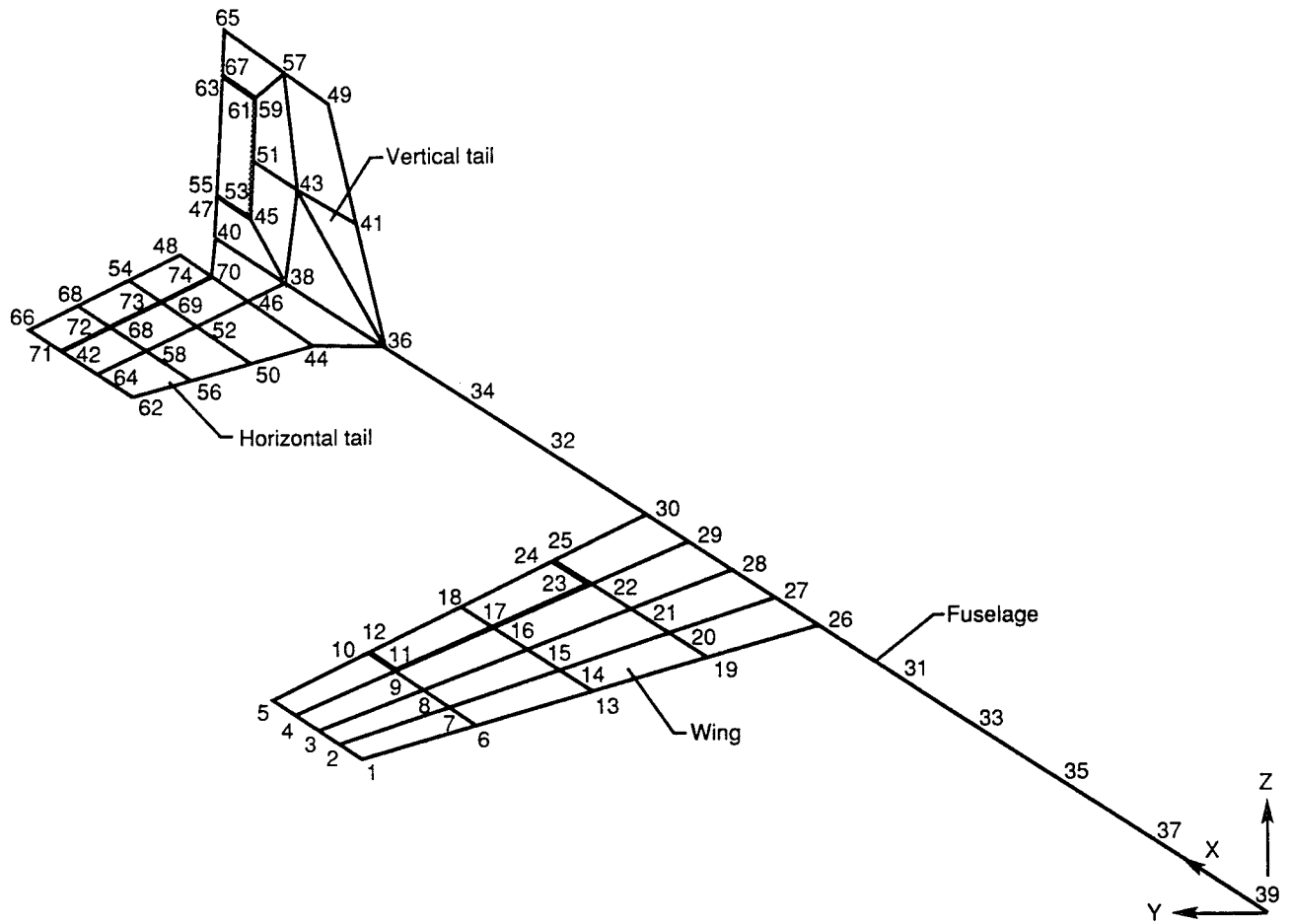

10155

Figure 23. ATM symmetric half finite element model with nodes.

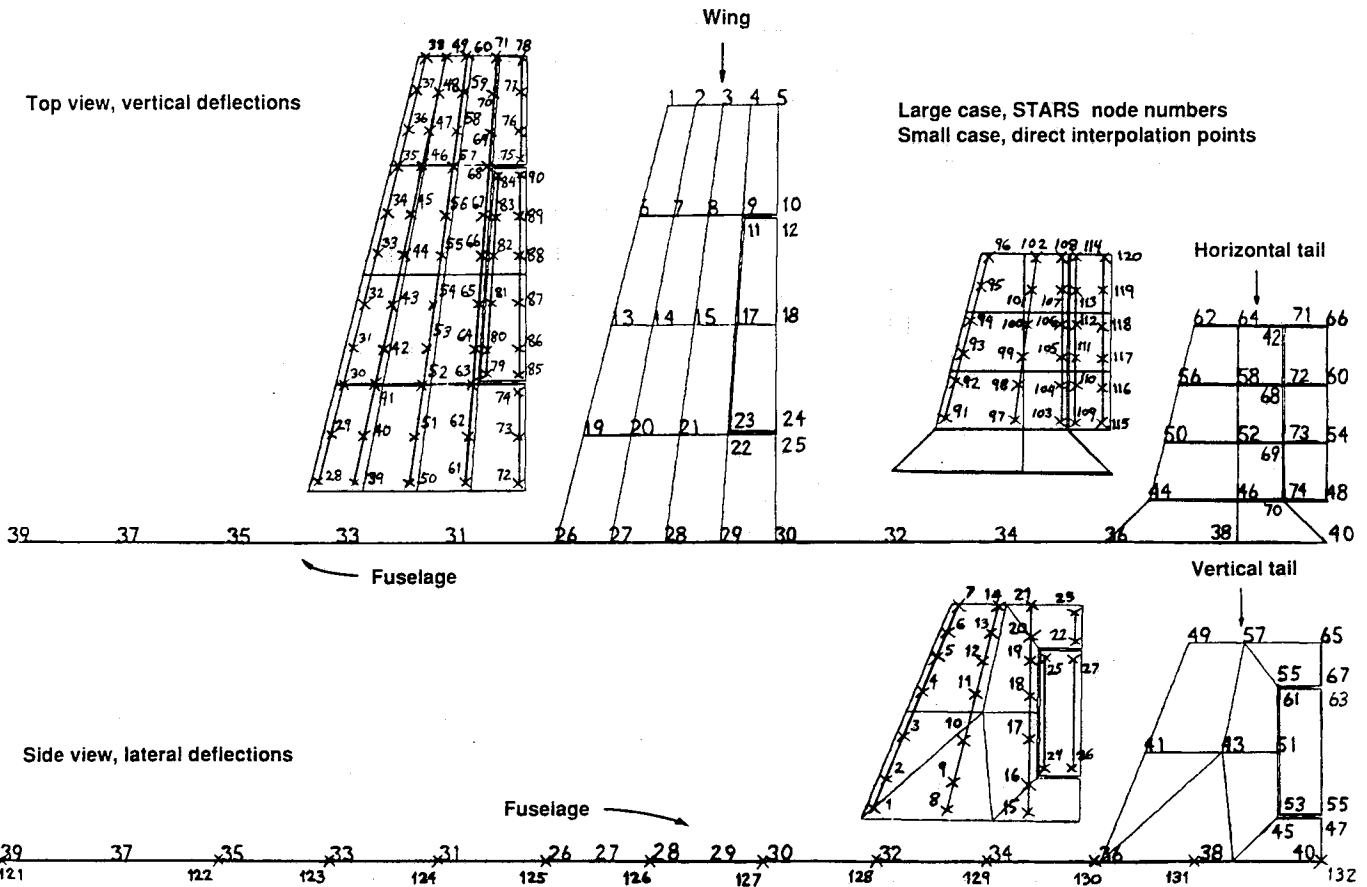

10156

Figure 24. ATM antisymmetric case, direct-surface interpolation scheme.

ORIGINAL PAGE IS
OF POOR QUALITY

STARS-SOLIDS analysis results:

Table 15 depicts the results of the free vibration analysis. Figure 25 shows the eight elastic mode shapes, whereas the three perfect rigid body and the two control modes are shown in figure 26. In order to effect correct response from the controllers, the perfect rigid body and control modes need to be defined in the fashion shown in table 16.

Table 15. AERO test model: Antisymmetric free vibration analysis results.

Mode shape		Eigenvalue		Generalized mass, lb	Mode shape
SOLIDS	AERO-ASE	Hz	rad/sec		
1	---	---	---	113.8	Rigid body X-rotation
2	---	---	---	2,384	Rigid body Y-translation
3	---	---	---	111.6	Rigid body Z-rotation
4	1	10.175	63.931	8.2	Vertical fin first bending
5	2	12.449	78.217	235.1	Fuselage first bending
6	3	14.632	91.934	44.62	Wing first bending
7	4	28.741	180.584	60.53	Wing second bending
8	5	29.810	187.301	204.3	Fuselage second bending
9	6	32.450	203.890	47.87	Wing first torsion
10	7	35.815	225.030	3.233	Fin first torsion
11	8	59.664	374.880	21.84	Wing third bending
12	9	---	---	2,534	Rigid body Y-translation
13	10	---	---	151,200	Rigid body roll
14	11	---	---	589,000	Rigid body yaw at 275 in.
15	12	---	---	128.60	Flap deflection
16	13	---	---	14.22	Rudder deflection

Table 16. Rigid body and control mode generation parameters.

Motion	Symmetric analysis	Antisymmetric analysis
X-translation	1.0 in X	
Y-translation		1.0 in Y
Z-translation	-1.0 in Z	
X-rotation		-Δ in Z
Y-rotation	-Δ in Z	
Z-rotation		-Δ in Y
Flap	-Δ in Z	
Aileron		+Δ in Z
Elevator	-Δ in Z	
Rudder		-Δ in Y

In the table, the term Δ is defined as

$$\Delta = \frac{d_N - d_A}{12}$$

where d_N and d_A represent the coordinates of the node under consideration and the axis of rotation, respectively.

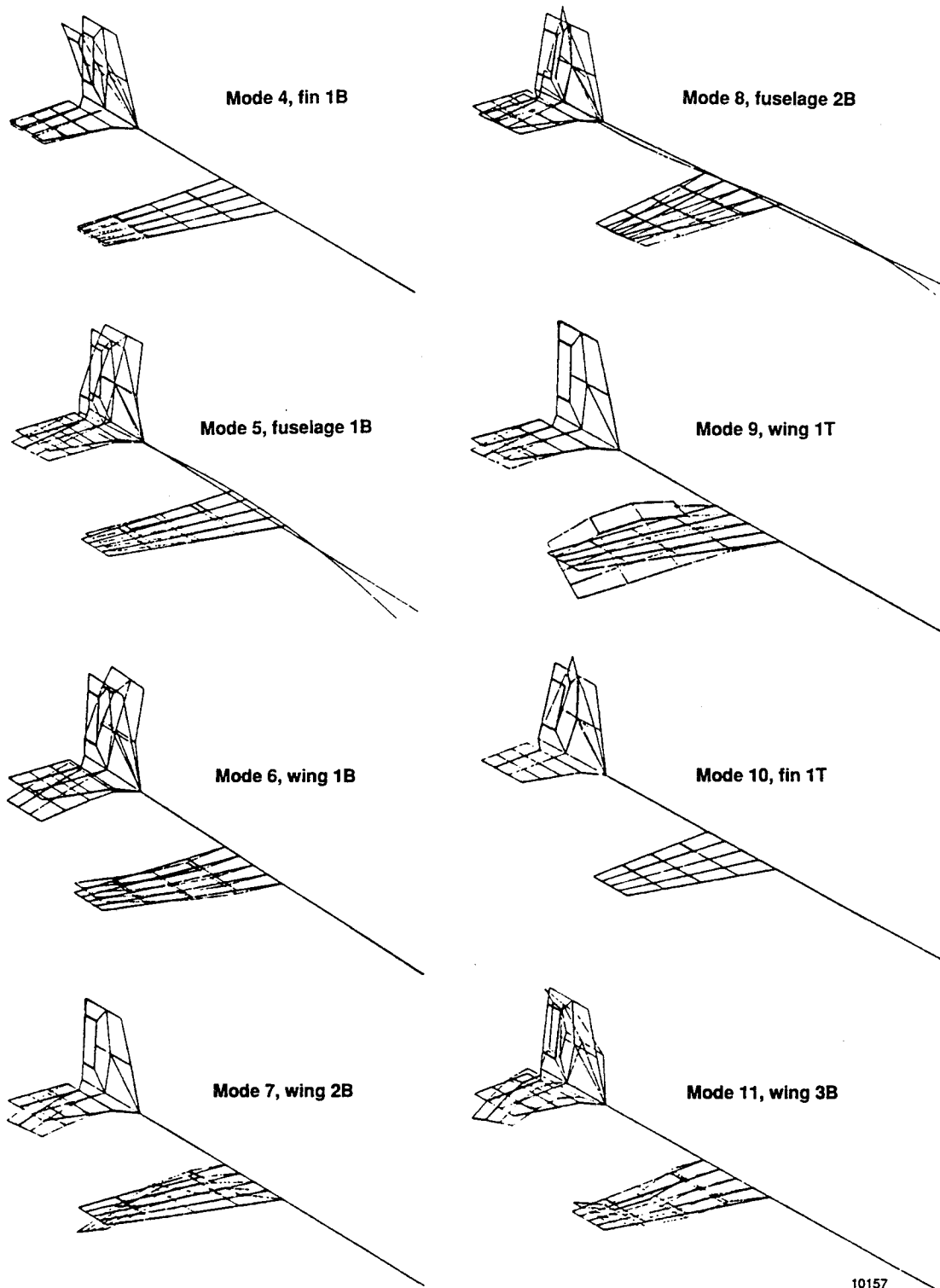
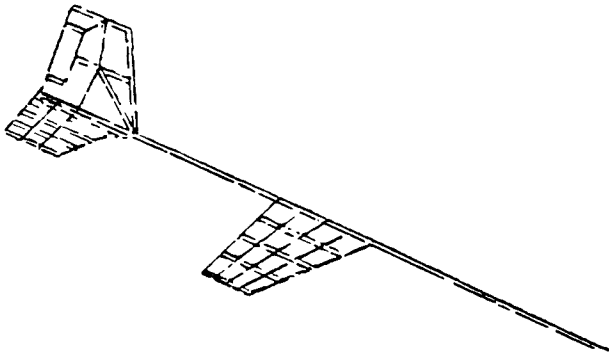
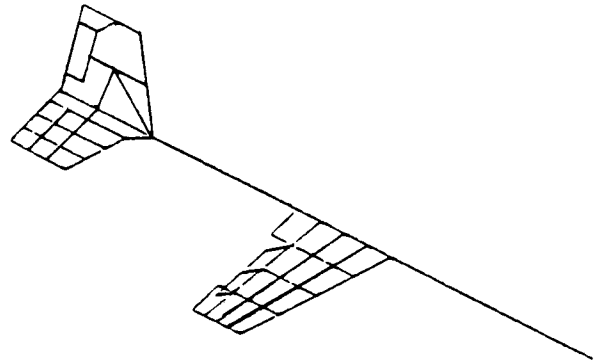

Figure 25. ATM antisymmetric case, elastic (Φ_E) mode shapes.



(a) Rigid body mode, X-Y plane motion.



(b) Control mode, flap motion.

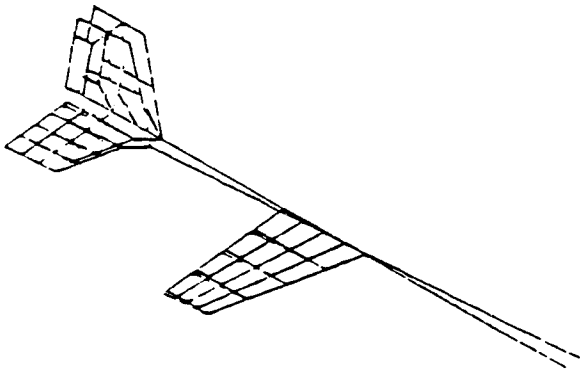

(c) Rigid body mode, Z-rotation motion.

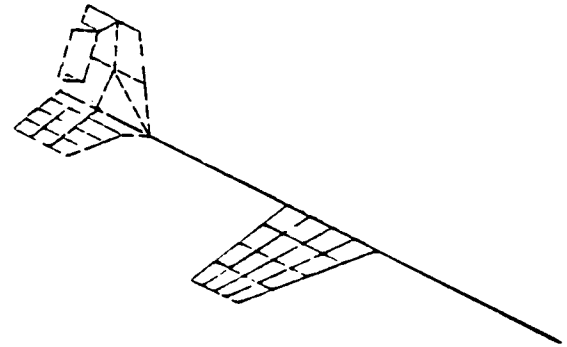

(d) Control mode, rudder motion.

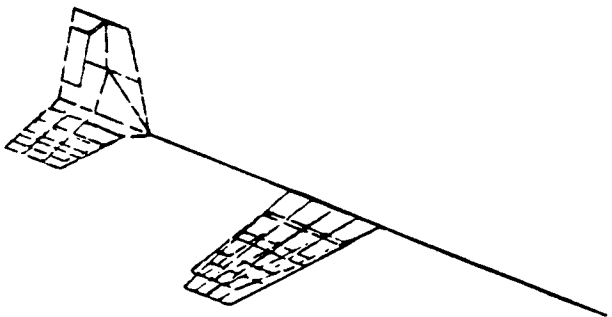

(e) Rigid body mode, X-rotation motion.

10158

Figure 26. ATM antisymmetric case, perfect rigid body (Φ_{PR}) and control (Φ_C) modes.

7.2 ATM: Generalized mass analysis (STARS-AERO-GENMASS)

This run is made by deleting the first three rigid body modes so that

$$\Phi = \Phi_E + \Phi_{PR} + \Phi_C$$

STARS-AERO-GENMASS input data:

```
$ AERO TEST MODES, ANTISYMMETRIC VERSION
  4 39 386.088
$ LATERALLY MOVING direct interpolation output NODE NUMBERS
  1
  2
  3
  4
  5
  6
  7
  8
  9
 10
 11
 12
 13
 14
 15
 16
 17
 18
 19
 20
 21
 22
 23
 24
 25
 26
 27
121
122
123
124
125
126
127
128
129
130
131
132
```

The calculated generalized mass is depicted in table 15.

The input data used for eventual ASE response analysis are given in this section. These data also enable flutter and divergence analysis of the aircraft. For a k or p-k method of flutter solution, the number of reduced frequencies in the data is increased from 10 to 28, and rigid body and control modes are eliminated. Figures 27 through 29 show the ATM relevant aerodynamic element arrangements.

STARS-AERO input data - ASE analysis:

```

AERO TEST MODEL - ANTISYMMETRIC CASE - NCNTAL = 5
SET UP FOR ASE SOLUTION.
DIRECT SURFACE INTERPOLATION.
EIGHT ELASTIC MODES, PLUS FIVE ADDED RIGID BODY-CONTROL MODES;
REVISED RIGID BODY Y TRANSLATIONS, ROLL, YAW, PLUS AILERON AND RUDDER MODES.
MACH NO. = 0.90          ALTITUDE: SEA LEVEL
  1  15  3  10  1  0  0  0  0  0  0
  1  0  0  0  0  0  0  0  0  0  0
  1  0  0  0  0  0  0  0  0  0  0
  0  0  0  0  0  0  0  99  0  0  0
  1
  38.89   0.90
11000.0  1000.0  100.0  50.0  10.0  5.0  1.0
  0.667   0.500   0.25
   .10   -.40  1400.  80.0
   1.0
  77.78  15000.
-1  15  1  1200  0  0  1
          90.0
  508.0   580.0   532.0   580.0   20.0   80.0
   0.0     0.0   4  4     0.0
   0.0   0.3333  0.6666   1.0
   0.0   0.3333  0.6666   1.0
          90.0
  532.0   600.0   540.0   600.0   80.0  100.0
   0.0     0.0   2  5     0.0
   0.0   0.2353  0.4705  0.7059   1.0
   0.0     1.0
          90.0
  580.0   600.0   580.0   600.0   20.0   80.0
   0.0     0.0   4  2     0.0
   0.0     1.0
   0.0   0.3333  0.6666   1.0

  255.0   350.0   262.5   350.0   20.0   50.0
   0.0     0.0   3  5     0.0
   0.0   0.25   0.50   0.75   1.0
   0.0     0.5   1.0

  262.5  328.125   275.0   331.25   50.0  100.0
   0.0     0.0   4  4     0.0
   0.0   0.3333  0.6666   1.0
   0.0   0.34   0.66   1.0

  275.0   331.25   287.5   334.375  100.0  150.0
   0.0     0.0   4  4     0.0
   0.0   0.3333  0.6666   1.0
   0.0   0.34   0.66   1.0

  287.5   350.0   300.0   350.0   150.0  200.0
   0.0     0.0   4  5     0.0
   0.0   0.25   0.50   0.75   1.0
   0.0   0.34   0.66   1.0

  328.125  350.0   331.25   350.0   50.0  100.0
   0.0     0.0   4  2     0.0
   0.0     1.0
   0.0   0.34   0.66   1.0

  331.25   350.0   334.375  350.0  100.0  150.0
   0.0     0.0   4  2     0.0
   0.0     1.0
   0.0   0.34   0.66   1.0

```

520.0	580.0	527.5	580.0	20.0	50.0				
0.0	0.0	3 3	0.0						
0.0	0.4167	1.0							
0.0	0.5	1.0							
527.5	580.0	540.0	580.0	50.0	100.0				
0.0	0.0	4 3	0.0						
0.0	0.4167	1.0							
0.0	0.34	0.66	1.0						
580.0	600.0	580.0	600.0	20.0	50.0				
0.0	0.0	3 2	0.0						
0.0	1.0								
0.0	0.5	1.0							
580.0	600.0	580.0	600.0	50.0	100.0				
0.0	0.0	4 2	0.0						
0.0	1.0								
0.0	0.34	0.66	1.0						
-5.0	600.0	-5.0	600.0	0.0	20.0				
-20.0	0.0	2 11	0.0						
0.0	0.1074	0.2149	0.3223	0.4298	0.5083				
0.5868	0.6777	0.7769	0.8678	1.0000					
0.0	1.0								
-5.0	600.0	-5.0	600.0	20.0	0.0				
0.0	20.0	2 11	0.0						
0.0	0.1074	0.2149	0.3223	0.4298	0.5083				
0.5868	0.6777	0.7769	0.8678	1.0000					
0.0	1.0								
0.0	0.0	14 0 1	0.0	76 95					
-15.000	25.000	85.000	145.000	205.000	245.000				
295.000	335.000	365.000	425.000	485.000	565.000				
605.000	645.000								
0.0	10.0	20.0	20.0	20.0	40.0				
40.0	40.0	40.0	30.0	30.0	20.0				
20.0	15.0								
1	0	0 2 16 1							
T	16	1							
4	0	1 1							
7	502.0	2.0	542.0	100.0					
2.0	20.0	40.0	55.0	70.0	85.0	100.0			
7	542.0	2.0	560.0	100.0					
2.0	20.0	40.0	55.0	70.0	85.0	100.0			
7	578.0	2.0	578.0	100.0					
2.0	20.0	40.0	55.0	70.0	85.0	100.0			
2	598.0	82.0	598.0	100.0					
82.0	100.0								
580.0	20.0	580.0	80.0						
2	0	1 1							
2	582.0	22.0	582.0	78.0					
22.0	78.0								
2	598.0	22.0	598.0	78.0					
22.0	78.0								
T	44	1							
6	0	1 1							
11	252.0	2.0	302.0	200.0					
2.0	25.0	50.0	70.0	90.0	110.0	130.0			
150.0	170.0	185.0	200.0						
11	270.0	2.0	313.0	200.0					
2.0	25.0	50.0	70.0	90.0	110.0	130.0			
150.0	170.0	185.0	200.0						
11	298.0	2.0	324.0	200.0					
2.0	25.0	50.0	70.0	90.0	110.0	130.0			
150.0	170.0	185.0	200.0						
11	323.0	2.0	336.0	200.0					
2.0	25.0	50.0	70.0	90.0	110.0	130.0			
150.0	170.0	185.0	200.0						
3	348.0	2.0	348.0	48.0					
2.0	25.0	48.0							
4	348.0	152.0	348.0	200.0					
152.0	170.0	185.0	200.0						
328.125	50.0	334.375	150.0						
2	0	1 1							
6	330.0	52.0	336.0	148.0					
52.0	70.0	90.0	110.0	130.0	148.0				
6	348.0	52.0	348.0	148.0					
52.0	70.0	90.0	110.0	130.0	148.0				

T	15	1						
3	0	1	1					
6	522.0		20.0	542.0	100.0			
	20.0	40.0		55.0	70.0	85.0	100.0	
6	550.0		20.0	562.0	100.0			
	20.0	40.0		55.0	70.0	85.0	100.0	
6	578.0		20.0	578.0	100.0			
	20.0	40.0		55.0	70.0	85.0	100.0	
	580.0	20.0		580.0	100.0			
2	0	1	1					
6	582.0		20.0	582.0	100.0			
	20.0	40.0		55.0	70.0	85.0	100.0	
6	598.0		20.0	598.0	100.0			
	20.0	40.0		55.0	70.0	85.0	100.0	
12	2	14						
	0.0	100.0		150.0	200.0	250.0	300.0	
	350.0	400.0		450.0	500.0	560.0	600.0	
0								

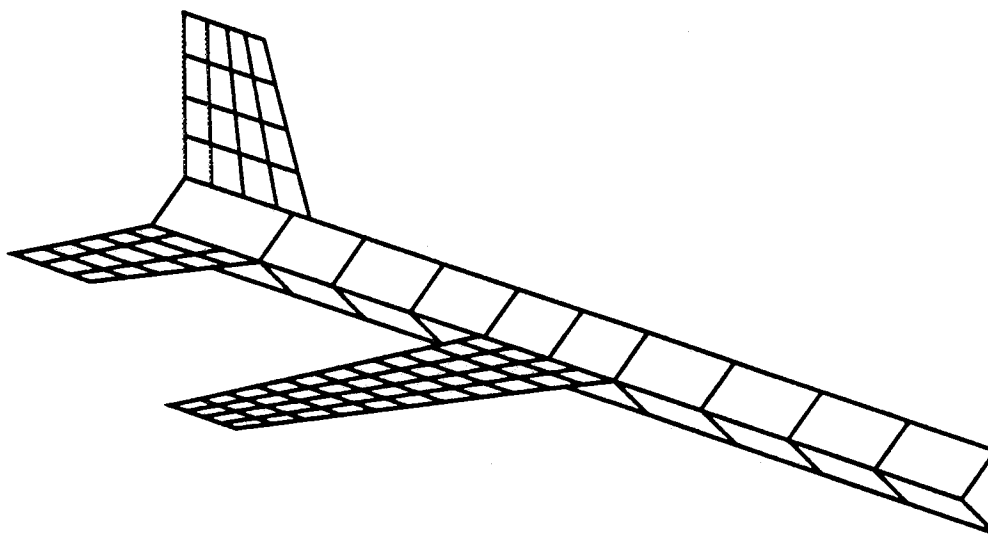

10159

Figure 27. ATM antisymmetric case, half aircraft aerodynamic boxes.

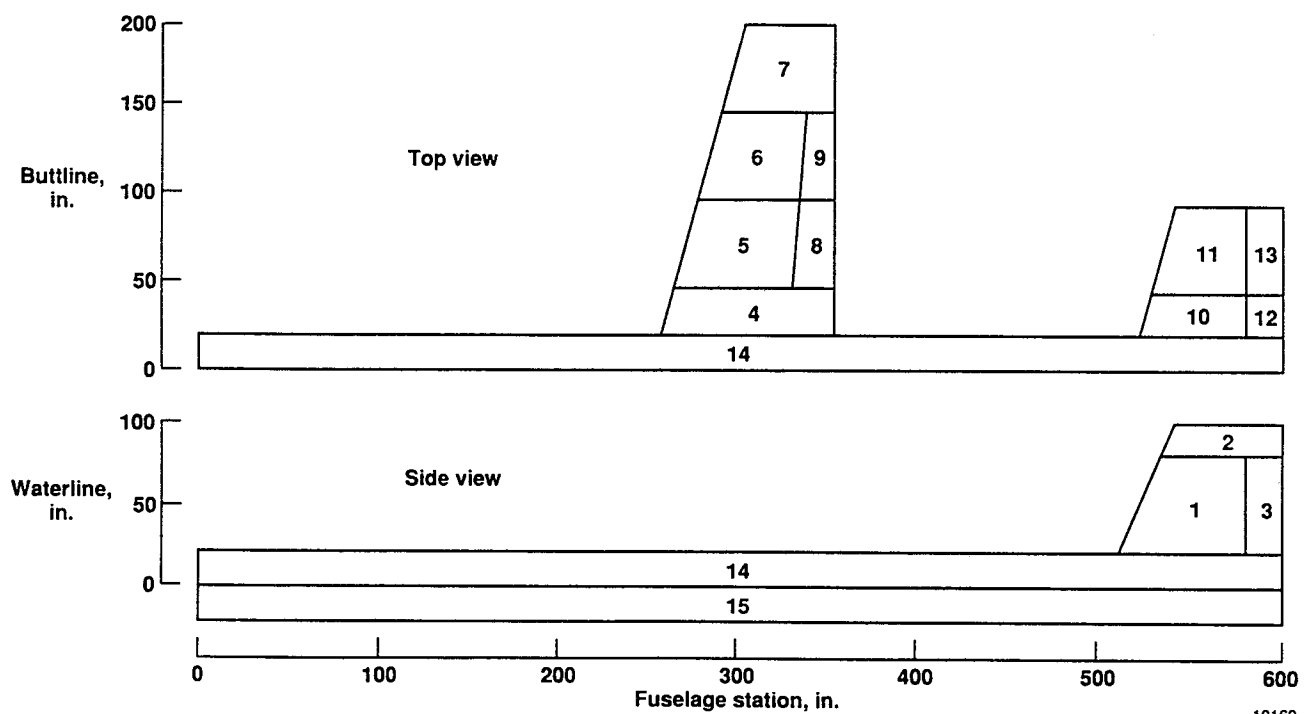

10160

Figure 28. ATM antisymmetric case, aerodynamic panels.

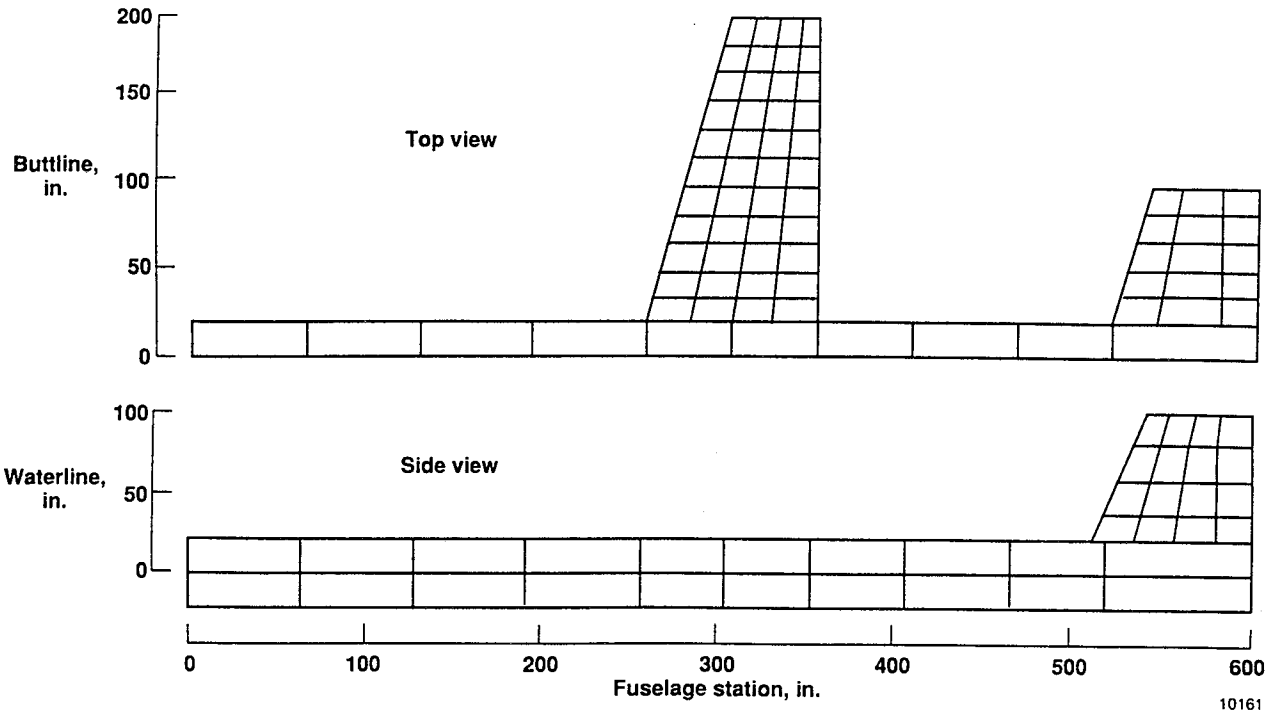

(a) Aerodynamic boxes.

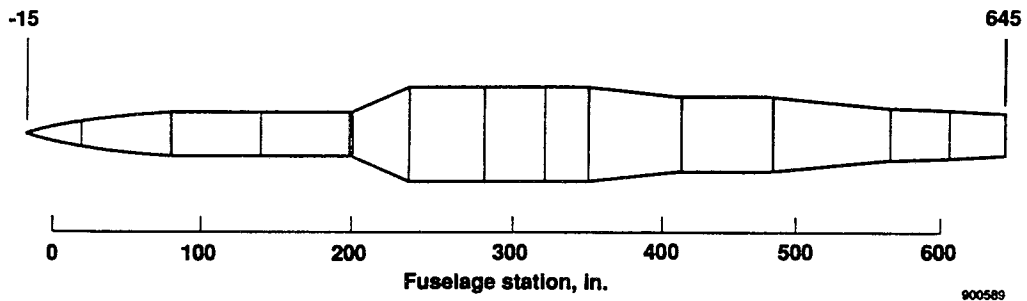

(b) Slender body definitions.

Figure 29. ATM antisymmetric case.

STARS-AERO input data – k-type flutter analysis:

These data pertain only to changes required in the corresponding ASE analysis case and occur within the first 16 lines; such data are presented next.

```

AERO TEST MODEL - ANTISYMMETRIC CASE - IINTP = 1
K-FLUTTER SOLUTION
DIRECT SURFACE INTERPOLATION
STARS STRUCTURAL MODEL, BYPASS RIGID BODY MODES IN GENMASS
MACH NO. = 0.90 ALTITUDE: SEA LEVEL
////////////////////////////////////
1 10 3 28 1 0 0 0 0 0
1 1 0 0 0 0 0 0 0 0
1 0 0 0 0 0 0 0 0 0
0 0 0 0 0 0 0 99 0 0
1

```

38.89	0.90						
.350	.745	.940	1.491	1.615	1.698	1.864	
2.000	2.450	2.750	3.150	3.270	3.400	3.850	
4.150	4.551	5.250	7.000	9.000	11.110	15.000	
19.000	24.070	50.000	140.000	315.774	616.746	1200.000	

STARS-AERO analysis results:

Table 17 provides the results of flutter analysis by various procedures using direct interpolation of modal data. The flutter solution based on the ASE method utilizing state-space formulation employs a data file as in section 6.5. Figures 30 through 32 depict the pattern of root location as a function of velocity for the k, p-k, and ASE methods. In this connection it may be noted that only the elastic modes are considered in these analyses. In the ASE method, the real (a) and imaginary (b) parts of the eigenvalues, termed as damping and frequencies, of the state-space plant dynamics matrix (A) are plotted against the air speed. In the k and p-k methods, the damping term is expressed as $g' = 2\alpha\omega_d/\omega_n^2$, where ω_n is the relevant natural frequency [$\omega_d = (\alpha^2 + \beta^2)^{1/2}$]

Table 17. AERO test model: An aeroelastic antisymmetric analysis using a direct interpolation for AERO paneling.

Mode	Instability number	k - SOLN		p-k		ASE	
		Velocity, keas	Frequency, rad/sec	Velocity, keas	Frequency, rad/sec	Velocity, keas	Frequency, rad/sec
Fuselage first bending	F1	626.9	74.3	632	73.7	597	79.8
Wing first bending	F2	---	---	---	---	820	101.9
Fin first bending	D1	795	0	---	---	780	0

Analysis notes:

- 1) F - Flutter point
- 2) D - Divergence point
- 3) Mach = 0.90
- 4) Altitude = Sea level

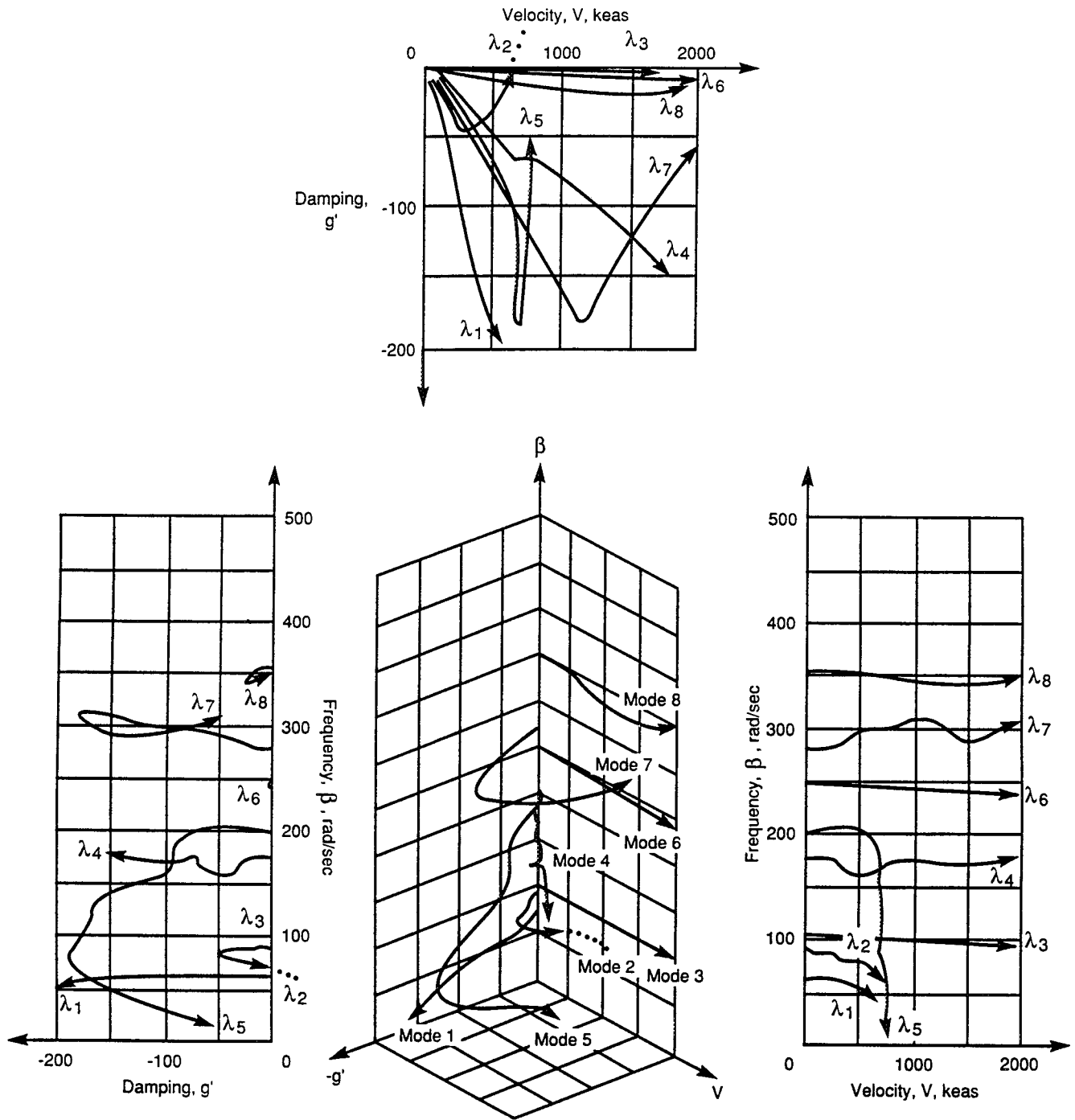

10162

Figure 30. STARS ATM-k flutter analysis — damping (g'), frequency (β), velocity (v) plot, antisymmetric case, using direct interpolation where $g' = g \times 200$.

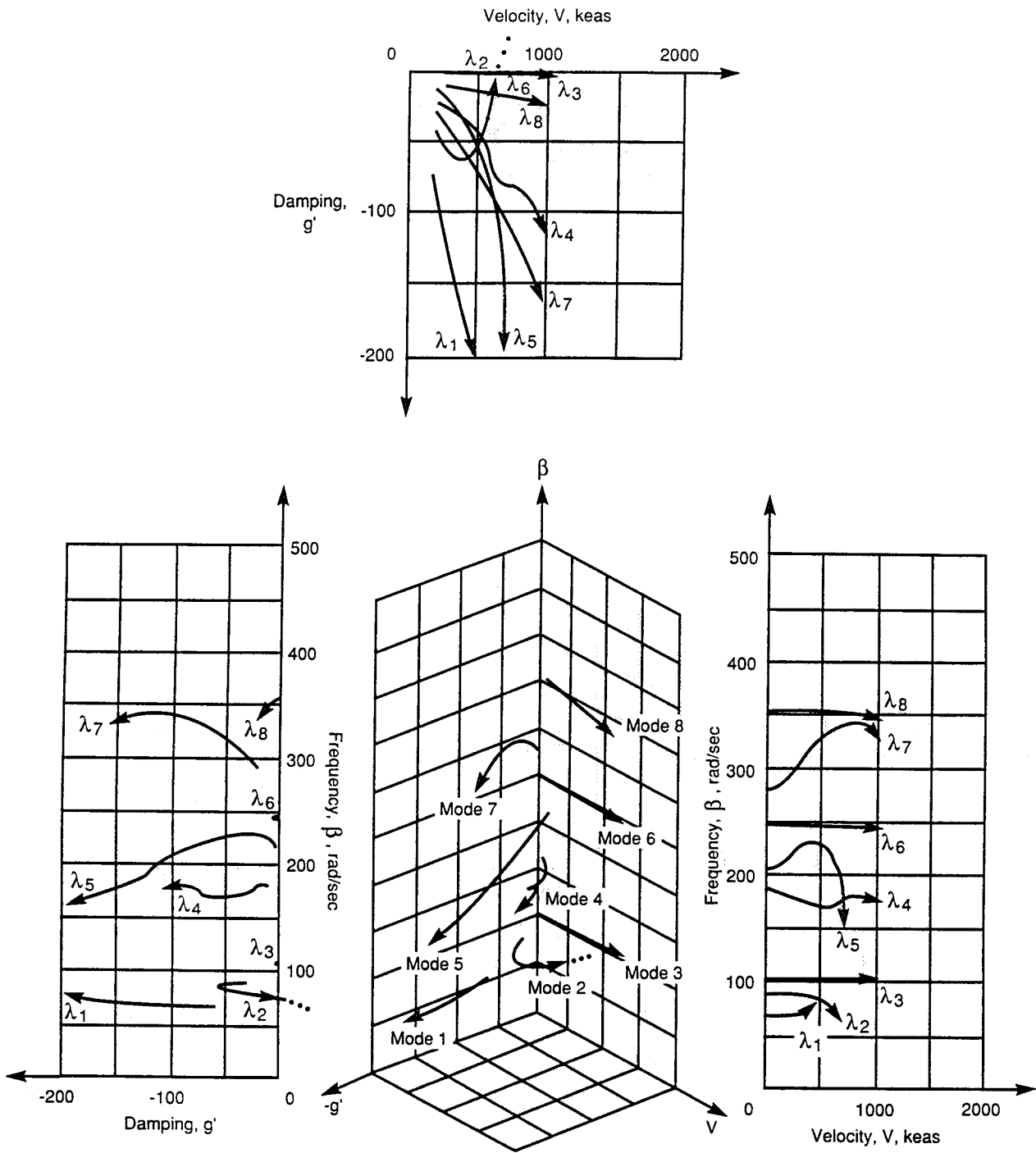

10163

Figure 31. STARS ATM-pk flutter analysis — damping (g'), frequency (β), velocity (v) plot, antisymmetric case, using direct interpolation where $g' = g \times 200$.

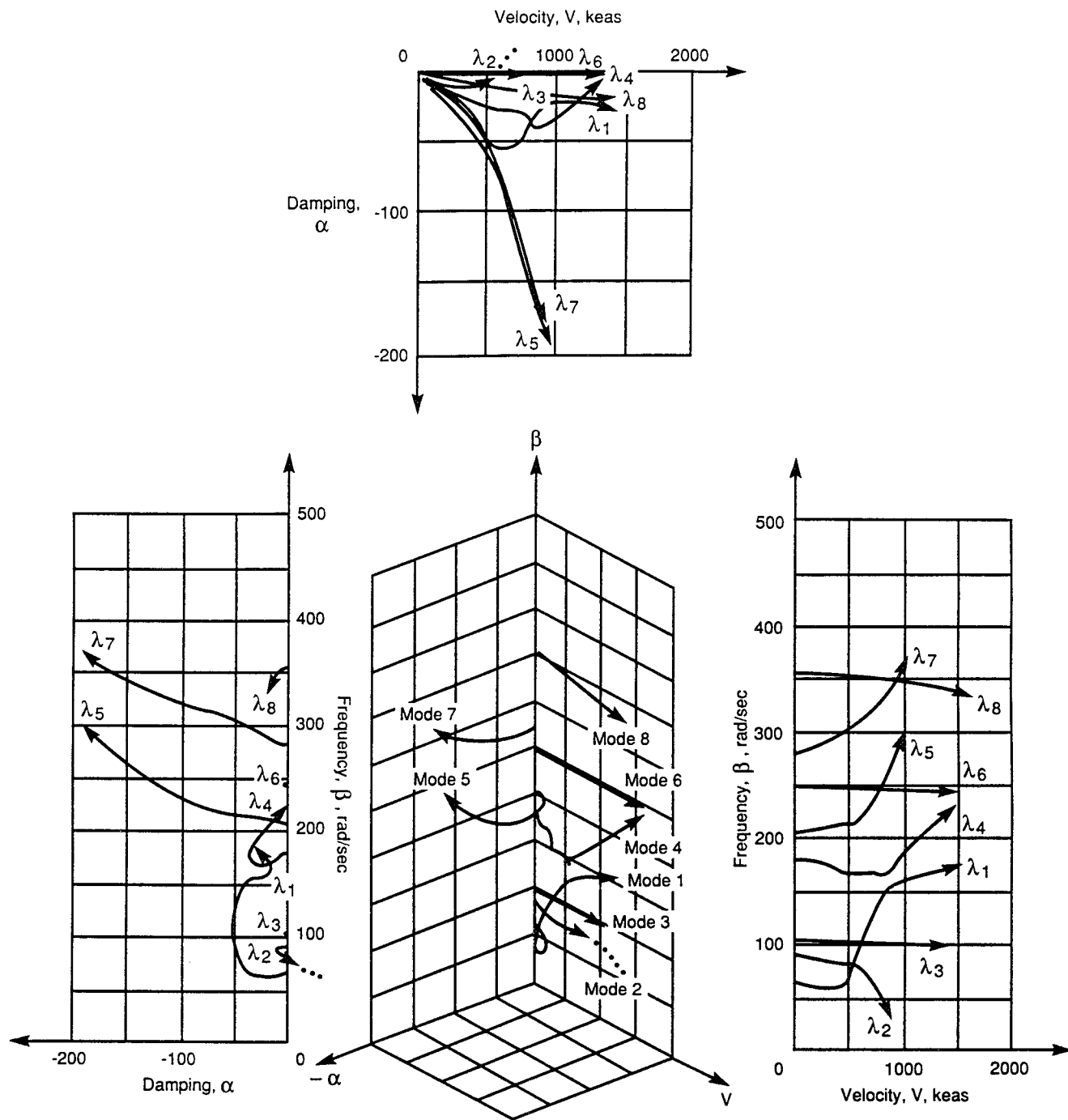

10164

Figure 32. STARS ATM-ASE flutter analysis — damping (α), frequency (β), velocity (v) plot, antisymmetric case, using direct interpolation.

These input data enable appropriate reordering of generalized matrices. Thus, the three perfect rigid body modes (Φ_{PR}) are placed in the front, followed by eight elastic modes (Φ_E) and two rigid control modes (Φ_C) for the ASE solution. For the flutter analysis, only the eight elastic modes (Φ_E) are used for the solution.

STARS-ASE-CONVERT input data:

```
$ CONVERT FILE FOR ASE SOLUTION
```

```
13
```

```
$ MODAL SELECTION AND ORDERING
```

```
13,1
```

```
14,2
```

```
15,3
```

```
1,4
```

```
2,5
```

```
3,6
```

```
4,7
```

```
5,8
```

```
6,9
```

```
7,10
```

```
10,11
```

```
16,12
```

```
17,13
```

```
$ CONVERT FILE FOR ASE FLUTTER AND DIVERGENCE SOLUTION
```

```
8
```

```
$ MODAL SELECTION AND ORDERING
```

```
1,1
```

```
2,2
```

```
3,3
```

```
4,4
```

```
5,5
```

```
6,6
```

```
7,7
```

```
10,8
```

These input data effect curve fitting of unsteady aerodynamic forces employing Padé polynomials. The state-space matrices are also formed in this module. Version I of the input file pertains to the ASE flutter solution, whereas version II corresponds to the subsequent ASE frequency response and damping solution.

STARS-ASE-PADÉ input data:

```

$ ATM ASE FLUTTER ANALYSIS, 0.9 MACH AT SEA LEVEL - VERSION I DATA
      0, 8, 0, 0, 0, 0, 10, 2, 1.0, 871.0, 3.2, 0, 53
$ TENSION COEFFICIENTS
      0.4      0.2
$ GENERALIZED MASS
0.2570E+00 0.0 0.0 0.0 0.0 0.0 0.0 0.0 0.0
0.7309E+01 0.0 0.0 0.0 0.0 0.0 0.0 0.0
0.1387E+01 0.0 0.0 0.0 0.0 0.0 0.0
0.1882E+01 0.0 0.0 0.0 0.0
0.6351E+01 0.0 0.0 0.0
0.1488E+01 0.0 0.0
0.1005E+00 0.0
0.6790E+00
$ GENERALIZED DAMPING
0.0000000E+00 0.0000000E+00 0.0000000E+00 0.0000000E+00
0.0000000E+00 0.0000000E+00 0.0000000E+00 0.0000000E+00
$ NATURAL FREQUENCIES
0.63931008E+02 0.78216623E+02 0.91934026E+02 0.18058442E+03
0.18730141E+03 0.20388896E+03 0.22502991E+03 0.37488010E+03
$ VELOCITIES FOR FLUTTER AND DIVERGENCE ANALYSIS
1.0
100.0
200.0
300.0
400.0
500.0
600.0
700.0
800.0
900.0
1000.0
1100.0
1200.0
1210.0
1220.0
1230.0
1240.0
1250.0
1260.0
1270.0
1280.0
1290.0
1300.0
1400.0
1500.0
1600.0
1700.0
1800.0
1900.0
2000.0
2050.0
2100.0
2150.0
2200.0
2250.0
2300.0
2350.0
2400.0
2450.0
2500.0
2550.0
2600.0
2650.0
2700.0
2750.0
2800.0

```

2850.0
 2900.0
 2950.0
 3000.0
 3200.0
 3400.0
 3600.0

\$ ATM ASE ANALYSIS, 0.9 MACH AT 40K FEET - VERSION II DATA
 3, 8, 2, 0, 2, 10, 2, 0.247, 871.0, 3.2, 0, 0

\$ TENSION COEFFICIENTS
 0.4 0.2

\$ GENERALIZED MASS

0.7878E+02 0.0 0.0 0.0 0.0 0.0 0.0 0.0 0.0 0.0 0.0 0.0 0.0
 0.4701E+04 0.0 0.0 0.0 0.0 0.0 0.0 0.0 0.0 0.0 0.0 0.0 0.0
 0.1831E+05 0.0 0.0 0.0 0.0 0.0 0.0 0.0 0.0 0.0 0.0 0.0 0.0
 0.2570E+00 0.0 0.0 0.0 0.0 0.0 0.0 0.0 0.0 0.0 0.0 0.0 0.0
 0.7309E+01 0.0 0.0 0.0 0.0 0.0 0.0 0.0 0.0 0.0 0.0 0.0 0.0
 0.1387E+01 0.0 0.0 0.0 0.0 0.0 0.0 0.0 0.0 0.0 0.0 0.0 0.0
 0.1882E+01 0.0 0.0 0.0 0.0 0.0 0.0 0.0 0.0 0.0 0.0 0.0 0.0
 0.6351E+01 0.0 0.0 0.0 0.0 0.0 0.0 0.0 0.0 0.0 0.0 0.0 0.0
 0.1488E+01 0.0 0.0 0.0 0.0 0.0 0.0 0.0 0.0 0.0 0.0 0.0 0.0
 0.1005E+00 0.0 0.0 0.0 0.0 0.0 0.0 0.0 0.0 0.0 0.0 0.0 0.0
 0.6790E+00 0.0 0.0 0.0 0.0 0.0 0.0 0.0 0.0 0.0 0.0 0.0 0.0
 0.3998E+01 0.0 0.0 0.0 0.0 0.0 0.0 0.0 0.0 0.0 0.0 0.0 0.0
 0.4419E+00 0.0 0.0 0.0 0.0 0.0 0.0 0.0 0.0 0.0 0.0 0.0 0.0

\$ GENERALIZED DAMPING

0.0000000E+00 0.0000000E+00 0.0000000E+00 0.0000000E+00 0.0000000E+00
 0.0000000E+00 0.0000000E+00 0.0000000E+00 0.0000000E+00 0.0000000E+00
 0.0000000E+00 0.0000000E+00 0.0000000E+00 0.0000000E+00 0.0000000E+00
 0.0000000E+00 0.0000000E+00 0.0000000E+00 0.0000000E+00 0.0000000E+00

\$ Natural Frequencies (radians)

0.0 0.0 0.0 0.63931008E+02
 0.78216623E+02 0.91934026E+02 0.18058442E+03 0.18730141E+03
 0.20388996E+03 0.22502991E+03 0.37488010E+03 0.0
 0.0

\$ PHI, THETA, PSI, US, US, US, PS, QS, RS, PHID, THAD, PSID, NDOF
 0.0, 0.0, 0.0, 871.0, 0.0, 0.0, 0.0, 0.0, 0.0, 0.0, 0.0, 0.0, 0.0, 0.0, 0.0, -3

\$ SENSOR DATA

0
 300.00 0.0 50.0
 0.0 0.0 0.0 1.0 0.0 0.0
 300.00 0.0 50.0
 0.0 0.0 0.0 0.0 0.0 1.0

STARS-ASE-PADÉ analysis results:

The state-space matrices generated in this module by the Version I data file are utilized for the flutter solution, the results of which are given in table 17. Results derived through utilization of Version II data are used for subsequent ASE frequency response and damping analysis in the next section.

Input data presented herein pertain to the frequency response analysis of the ATM at Mach 0.9 and 40,000 ft altitude. Thus, phase and gain margins for the equivalent open-loop case as well as damping and frequency values for the closed-loop configuration are generated from this module. Figure 33 shows the block diagram for the ATM lateral mode analog control system.

STARS-ASE-FRESP input data:
Open-loop case –

```

$ ATH ANTISYMMETRIC THREE RIGID, EIGHT ELASTIC, AND TWO CONTROL MODES
48, 12, 4, 4, 58, 0.0, 0.0
10 4 10 6 10 4 2 1 1
$ BLOCK CONNECTIVITY
1 3 0 0 0
2 10 0 0 0
3 7 0 0 0
4 6 0 0 0
5 0 0 0 1
6 0 0 0 2
7 0 0 0 3
8 0 0 0 4
9 5 0 0 0
10 8 0 0 0
$ TRANSFER FUNCTION DESCRIPTIONS
1 1 2
2 1 2
3 2 2
4 2 2
5 1 3
6 1 3
7 1 1
8 1 1
9 1 3
10 1 1
$ LISTING OF POLYNOMIAL COEFFICIENTS
1 .2000E+02 .0000E+00 .0000E+00
0 .2000E+02 .1000E+01 .0000E+00
2 .2000E+02 .0000E+00 .0000E+00
0 .2000E+02 .1000E+01 .0000E+00
3 .5000E+01 .1000E+00 .0000E+00
0 .0000E+00 .1000E+01 .0000E+00
4 .0000E+00 .1000E+01 .0000E+00
0 .1000E+00 .1000E+01 .0000E+00
5 .1877E+05 .0000E+00 .0000E+00
0 .1877E+05 .1930E+03 .1000E+01
6 .1877E+05 .0000E+00 .0000E+00
0 .1877E+05 .1930E+03 .1000E+01
7 .1000E+01 .0000E+00 .0000E+00
0 .1000E+01 .0000E+00 .0000E+00
8 .1000E+01 .0000E+00 .0000E+00
0 .1000E+01 .0000E+00 .0000E+00
9 .1000E+00 .0000E+00 .0000E+00
0 .1000E+02 .1100E+02 .1000E+01
10 .1000E+01 .0000E+00 .0000E+00
0 .1000E+01 .0000E+00 .0000E+00
$ GAIN INPUTS FOR EACH BLOCK
1 .1000E+01 2 .1000E+01 3 .1000E+01 4 .1000E+00 5 .1000E+01
6 .1000E+01 7 .1000E+01 8 .1000E+01 9 .1000E+01 10 .1000E+01
$ SPECIFICATION FOR SYSTEM OUTPUTS
7 8 0 0 0 0 0 0 0 0 0 0 0 0 0
0 0 0 0 0 0 0
$ SPECIFICATION FOR SYSTEM INPUTS
7 8 0 0 0 0 0 0
$ CONNECTION DETAILS FROM PLANT TO BLOCKS
2 2 0
7 1
8 2
1 1
2 2
$ FREQUENCY RANGE SPECIFICATIONS
0.1, .9, 200
1.0, 9, 200
10. 90. 200

```

100. 500. 100
\$ LOOP DEFINITIONS
1 0
4 8
9 7

STARS-ASE-FRESP input data:
Closed-loop case -

```

$ ATH ANTI-SYMMETRIC-THE ROLL AND YAW CLOSED LOOP CASE
48, 12, 4, 4, 53, 0.0, 0.0, 3, 3
12 4 10 6 10 0 0 1 1
$ BLOCK CONNECTIVITY
1 3 0 0 0 0 0
9 5 0 0 0 0 0
11 0 0 0 0 0 3 9
3 7 0 0 0 0 0
5 0 0 0 1 0 0
7 0 0 0 3 0 0
2 10 0 0 0 0 0
4 6 0 0 0 0 0
12 0 0 0 0 10 4
6 0 0 0 0 2 0 0
8 0 0 0 4 0 0
10 8 0 0 0 0 0
$ TRANSFER FUNCTION DESCRIPTIONS
1 1 2
2 1 2
3 2 2
4 2 2
5 1 3
6 1 3
7 1 1
8 1 1
9 1 3
10 1 1
11 1 1
12 1 1
$ LISTING OF POLYNOMIAL COEFFICIENTS
1 .2000E+02 .0000E+00 .0000E+00
0 .2000E+02 .1000E+01 .0000E+00
2 .2000E+02 .0000E+00 .0000E+00
0 .2000E+02 .1000E+01 .0000E+00
3 .5000E+01 .1000E+00 .0000E+00
0 .0000E+00 .1000E+01 .0000E+00
4 .0000E+00 .1000E+01 .0000E+00
0 .1000E+00 .1000E+01 .0000E+00
5 .1877E+05 .0000E+00 .0000E+00
0 .1877E+05 .1930E+03 .1000E+01
6 .1877E+05 .0000E+00 .0000E+00
0 .1877E+05 .1930E+03 .1000E+01
7 .1000E+01 .0000E+00 .0000E+00
0 .1000E+01 .0000E+00 .0000E+00
8 .1000E+01 .0000E+00 .0000E+00
0 .1000E+01 .0000E+00 .0000E+00
9 .1000E+00 .0000E+00 .0000E+00
0 .1000E+02 .1100E+02 .1000E+01
10 .1000E+01 .0000E+00 .0000E+00
0 .1000E+01 .0000E+00 .0000E+00
11 .1000E+01 .0000E+00 .0000E+00
0 .1000E+01 .0000E+00 .0000E+00
12 .1000E+01 .0000E+00 .0000E+00
0 .1000E+01 .0000E+00 .0000E+00
$ GAIN INPUTS FOR EACH BLOCK
1 .1000E+01 2 .1000E+01 3 .1000E+01 4 .1000E+00 5 .1000E+01
6 .1000E+01 7 .1000E+01 8 .1000E+01 9 .1000E+01 10 .1000E+01
11 -.100E+01 12 -.100E+01
$ SPECIFICATION FOR SYSTEM OUTPUTS
7 8 0 0 0 0 0 0 0 0 0 0 0 0 0 0
0 0 0 0 0 0 0 0 0
$ SPECIFICATION FOR SYSTEM INPUTS
7 8 0 0 0 0 0 0 0
$ CONNECTION DETAILS FROM PLANT TO BLOCKS
2 2 0
7 1
8 2
1 1
2 2
$ LOOP DEFINITIONS
0 0

```

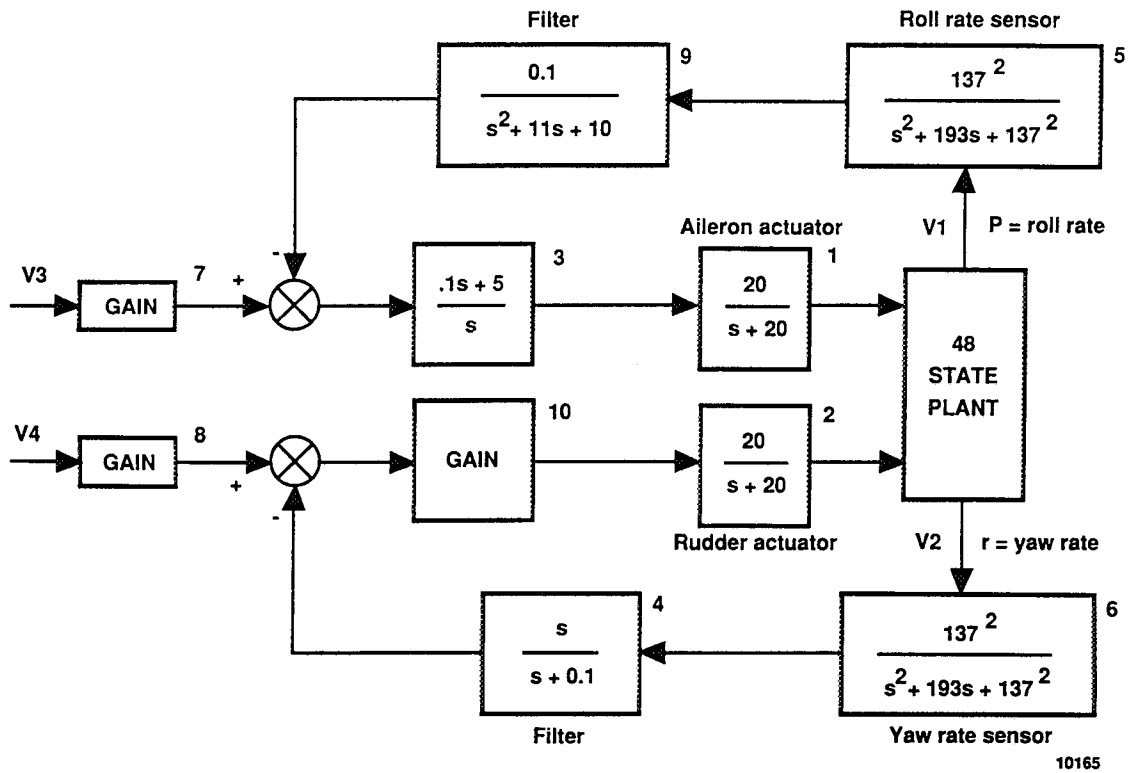



Figure 33. ATM lateral mode analog control system.

STARS-ASE-PADÉ analysis results:

Figures 34 and 35 depict the lateral loop gains for the roll and yaw modes, respectively. The gain margins are tabulated in table 18.

Table 18. ATM phase and gain margins.

Mode	Phase crossover, rad	Gain margin, dB
Roll	19.88	79.59
Yaw	2.80	-4.62

The closed loop damping and frequency plots are shown in figure 36.

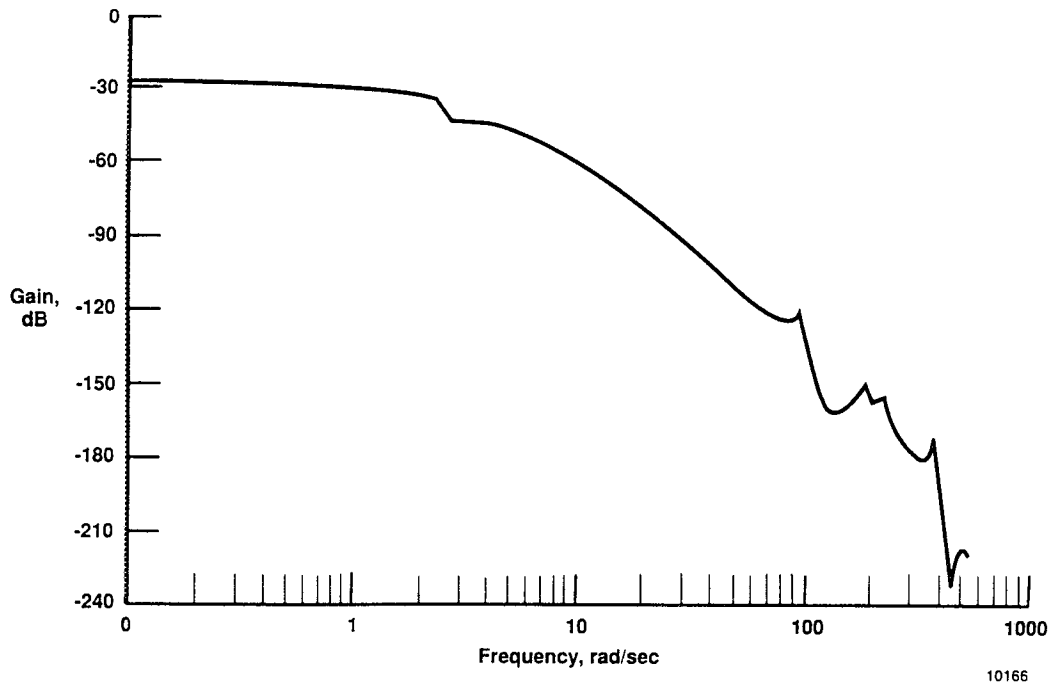

(a) Gain.

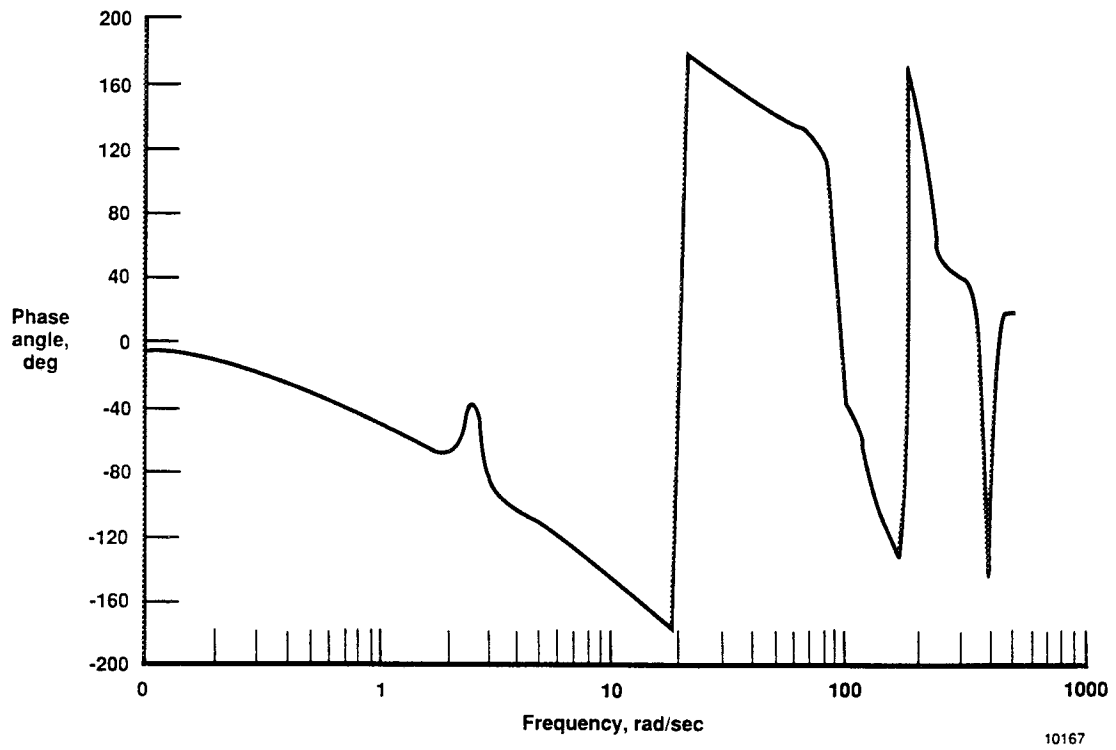

(b) Phase.

Figure 34. Lateral loop gains, roll mode.

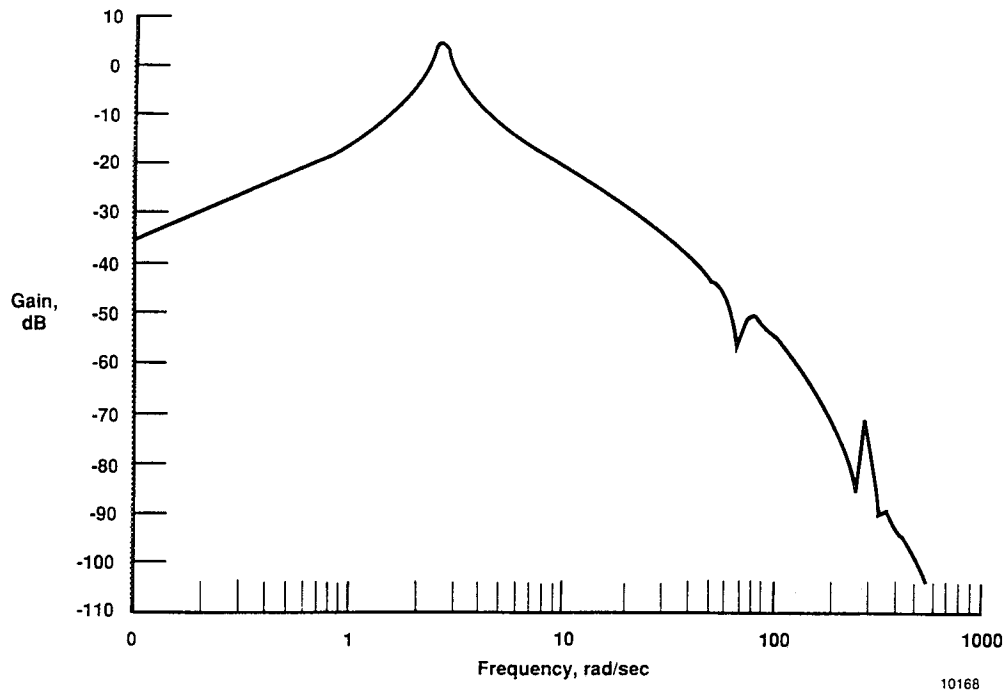

(a) Gain.

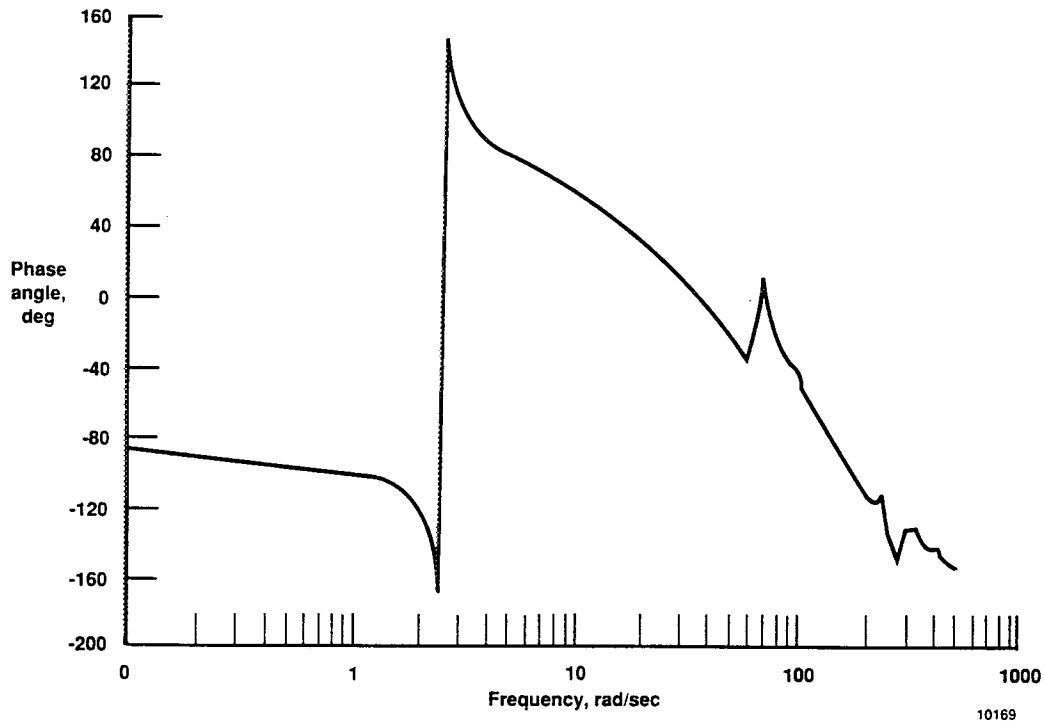

(b) Phase.

Figure 35. Lateral loop gains, yaw mode.

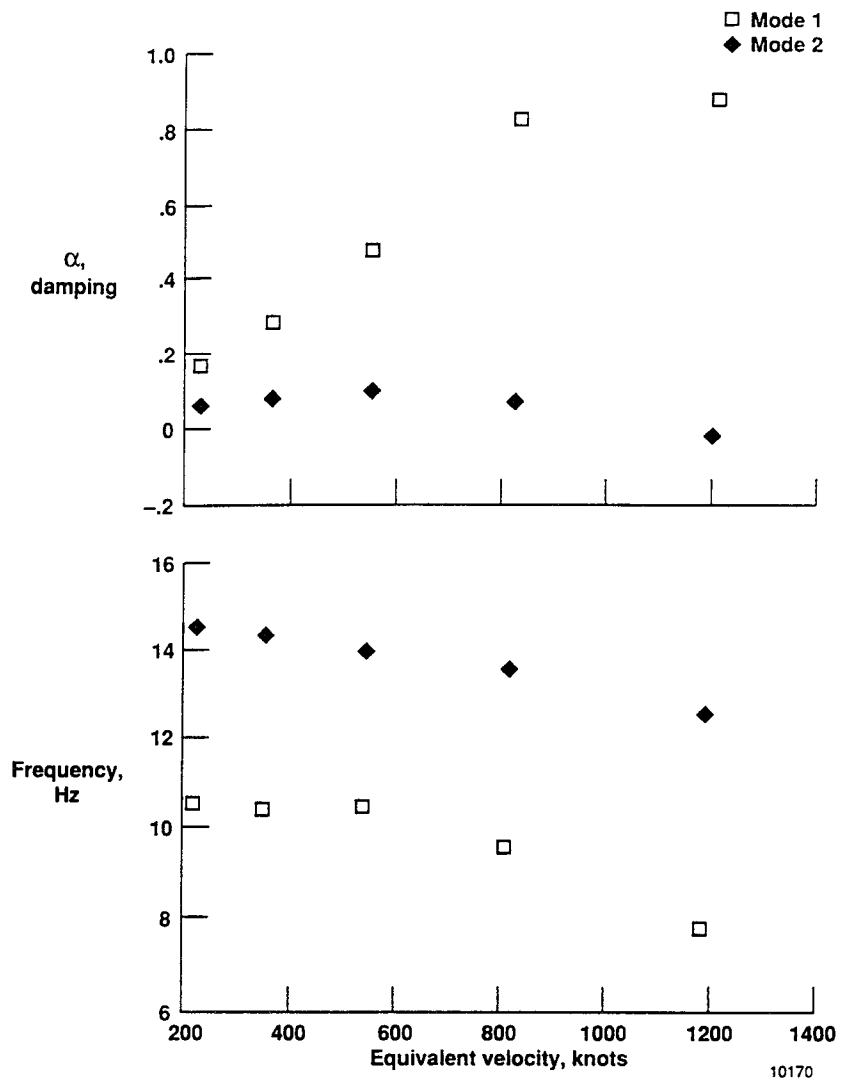

Figure 36. Closed-loop equivalent velocity vs. damping and frequencies.

Ames Research Center
 Dryden Flight Research Facility
 National Aeronautics and Space Administration
 Edwards, California, September 28, 1990

APPENDIX A — PREPROCESSOR MANUAL

The preprocessor program PREPROC forms an integral part of the set of routines that compose the STARS program. It has been developed to automate generation of finite element models and corresponding data files. Instead of defining a complete structure by independently describing each node and element, the preprocessor allows the formation of such data automatically for a structure. The preprocessor minimizes the information required from the user and eliminates the time-consuming task of data editing, enhancing the efficiency of the STARS program.

To run the preprocessor, the user may type the command GRUN followed by the command PREPROC, and immediately after this the program will prompt with a list of different terminals. The user may then choose the type of terminal to be used, namely E/S PS390, Tektronix, and various compatible terminals. Next, the user will be prompted with menu options in a progressive fashion. At any level of the menu, the user can exit by entering Control-Z.

Only a brief description of the primary menu is given next since, because of the interactive nature of the program, the user is automatically exposed to more extensive details.

PREPROC MENU

MENU OPTIONS:

- 0 **STOP**
stop the program
- 1 **COMPUTER-AIDED DESIGN**
generate graphics objects
- 2 **PROPERTIES AND ANALYSIS**
specify STARS data
- 3 **READ**
read STARS data file
- 4 **WRITE**
write STARS data file
- 5 **DELETE**
delete the current structure

1 COMPUTER-AIDED DESIGN

DESIGN OPTIONS:

- 0 **QUIT**
quit this menu
- 1 **LINES**
generate line segments
- 2 **SURFACES**
generate surface segments
- 3 **SOLIDS**
generate solid segments
- 4 **SYNTHESIS**
generate surfaces from existing line segments
- 5 **REPRODUCE**
generate new segments using existing ones
- 6 **DRAW**
plot the current structure
- 7 **EDITOR**
modify existing data

1.1 LINES

- 0 QUIT
quit this menu
- 1 STRAIGHT LINE
generate straight line segment
- 2 PARABOLIC
generate parabolic line segment
- 3 CIRCULAR CURVE
generate circular line segment
- 4 ELLIPTIC CURVE
generate elliptical line segment

1.2 SURFACES

- 0 QUIT
quit this menu
- 1 SIMPLE SURFACE
generate four node surface segment
- 2 COMPLEX SURFACE
generate nine node surface segment
- 3 ELLIPTICAL SURFACE
generate elliptical surface segment

1.3 SOLIDS

- 0 QUIT
quit this menu
- 1 8-POINT SOLID
generate eight node segment
- 2 ELLIPTICAL SOLID
generate solid cylinder
- 3 4-POINT SOLID
generate four node segment
- 4 6-POINT SOLID PRISM
generate six node segment

1.4 SYNTHESIS

- 0 QUIT
quit this menu
- 1 ARC: LINE SEGMENT --> SURFACE
generate surface segments by moving a line segment along a curve
- 2 GLIDE: 2 LINE SEGMENT --> SURFACE
generate surface segments using two line segments

1.5 REPRODUCE

- 0 QUIT
quit this menu
- 1 COPY
reproduce by method of direct copying
- 2 MIRROR
produce a mirror image
- 3 ROTATE
reproduce by rotating the original about an axis

1.6 DRAW

The preprocessor will draw the generated structure on a standard terminal with multiple options.

2 PROPERTIES AND ANALYSIS

This option enables automatic generation of a complete STARS data set for a structure in which the user is prompted for appropriate data.

APPENDIX B — POSTPROCESSOR MANUAL

The POSTPLOT program is designed to provide graphic depiction of analysis results pertaining to the three major modules, namely SOLIDS, AEROS, and CONTROLS. This is effected by the main command GRUN, followed by the POSTPLOT command. The program runs on a variety of terminals such as E/S PS390, Tektronix, and other PLOT10/PHIGS-compatible machines.

- 1.0 Basic Menu
 - 1.1 On-off switches
 - 1.2 Load Database
 - 1.3 Delete Database
 - 1.4 Miscellaneous
 - 1.5 Exit

- 1.1 On-off switches
 - 1.1.1 Original structure
 - 1.1.2 Deformed structure
 - 1.1.3 Dynamic response
 - 1.1.4 Displacement as a function of time
 - 1.1.5 Stress as a function of time
 - 1.1.6 Node number
 - 1.1.7 Element number
 - 1.1.8 Element group
 - 1.1.9 Depth clipping

- 1.2 Load Database
 - 1.2.1 Deformed or mode shape
 - 1.2.2 Rendering deformed or mode shape
 - 1.2.3 Dynamic response
 - 1.2.4 Rendering stress
 - 1.2.5 Rendering deformation
 - 1.2.6 Displacement as a function of time
 - 1.2.7 Stress as a function of time

- 1.2.8 Node numbers
- 1.2.9 Element numbers
- 1.2.10 Numerical renumbering
- 1.2.11 Aerodynamic paneling plots
- 1.2.12 Interpolated mode shape for aerodynamic loads calculations
- 1.2.13 Aerodynamic pressure distribution
- 1.2.14 Frequency-damping-velocity plots, k, p-k, and ASE solutions
- 1.2.15 Phase and gain plots as a function of frequency for analog and digital systems
- 1.2.16 ASE damping and frequency plots as a function of velocity

1.3 Delete Database

Essentially any one of the loaded databases, given above.

1.4 Miscellaneous

A host of additional options.

APPENDIX C — SYSTEMS DESCRIPTION

The STARS computer program is set up using a main directory and many subdirectories. The setup described in this section uses the directory names employed on the DEC VAX computer system at NASA. The top-level directories are shown in figure 37. The [KGUPTA.STARS] is the main directory which contains the five major subdirectories named COMMANDS, SOURCES, OBJECTS, EXECUTIONS, and TESTCASES. The COMMANDS subdirectory contains the command files which are used to guide the user in running the STARS program system. The SOURCES subdirectory contains the source elements for the program. It is further subdivided into the SOLIDS, AERODYNAMICS, CONTROLS, and GRAPHICS subdirectories. The OBJECTS subdirectory contains the object elements required for creating the execution elements. The object elements have been combined into various object libraries to ease the linking process. The EXECUTIONS subdirectory contains the execution elements used to run the program. The TESTCASES subdirectory contains a variety of representative example problems that facilitate the learning and debugging of the program.

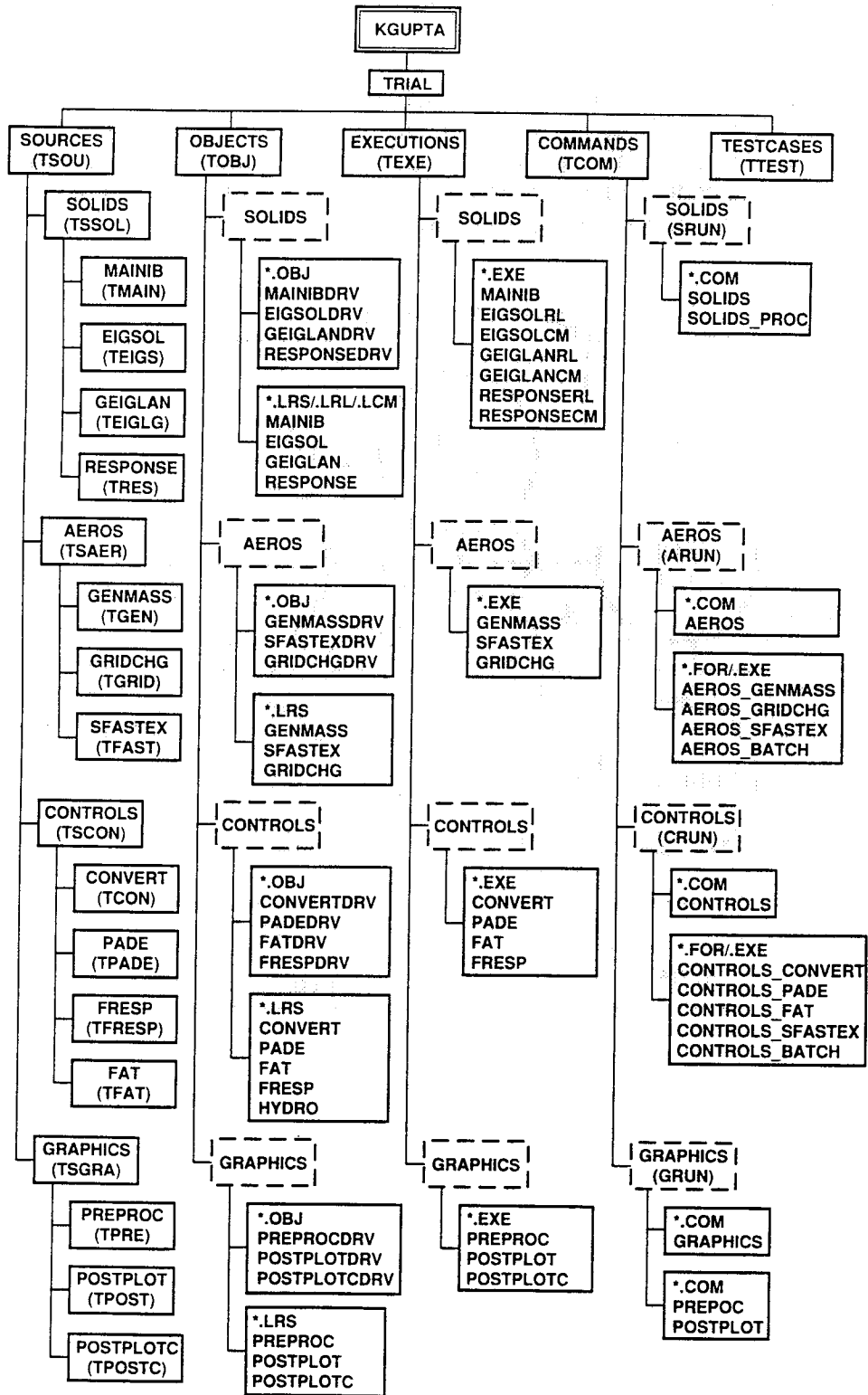

10171

Figure 37. STARS systems description.

APPENDIX D—NONLINEAR MULTIDISCIPLINARY SIMULATION

Present effort is directed towards generating a number of additional analysis modules for effective simulation of nonlinear systems. These current developments include efficient fluids unstructured grid generation, and finite element CFD and heat transfer capabilities. Figure 38 provides details of the various modules of the emerging code, which is currently being utilized (ref. 18) for simulation of highly nonlinear systems such as the national aero-space plane (NASP).

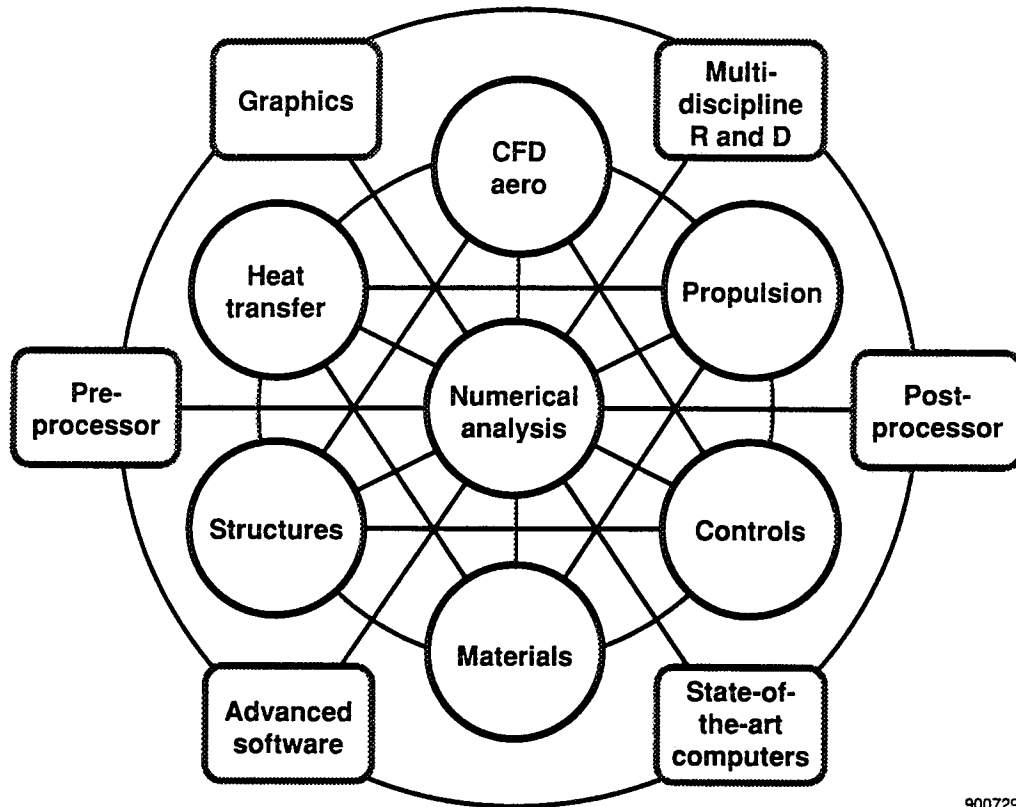

900729

Figure 38. Nonlinear multidisciplinary simulation (modular environment).

REFERENCES

1. Gupta, K.K., *STARS—A General-Purpose Finite Element Computer Program for Analysis of Engineering Structures*, NASA RP-1129, 1984.
2. Collins, R.J., "Bandwidth Reduction by Automatic Renumbering," *Inter. J. Numer. Methods Eng.*, vol. 6, 1973, pp. 345-356.
3. Gupta, K.K., "Development of a Unified Numerical Procedure for Free Vibration Analysis of Structures," *Inter. J. Numer. Methods Eng.*, vol. 17, 1981, pp. 187-198.
4. Gupta, K.K., "On a Finite Dynamic Element Method for Free Vibration Analysis of Structures," *Comput. Methods Appl. Mech. Eng.*, vol. 9, 1976, pp. 105-120.
5. Przemieniecki, J.S., *Theory of Matrix Structural Analysis*, McGraw-Hill, New York, 1968.
6. Gupta, K.K., "Formulation of Numerical Procedures for Dynamic Analysis of Spinning Structures," *Inter. J. Numer. Methods Eng.*, vol. 23, 1986, pp. 2347-2357.
7. Gupta, K.K., and C.L. Lawson, "Development of a Block Lanczos Algorithm for Free Vibration Analysis of Spinning Structures," *Inter. J. Numer. Methods Eng.*, vol. 26, 1988, pp. 1029-1037.
8. *The NASTRAN Theoretical Manual*, NASA SP-221(06), 1981.
9. Meriam, L., *Statics*, 2d ed., John Wiley and Sons, New York, 1971.
10. Ross, C.T.F., *Computer Methods in Engineering*, Elis Howard Publishers, United Kingdom, 1982.
11. Tezcan, S.S., *Application of Matrix Algebra to Problems of Plane Stress, Plane Strain, Bending of Plates and Cylindrical Shells*, Wiss. Z. Hochsch. Architek. Bauw, Weimar, Germany, 1965.
12. Rutkowski, M.J., *The Vibration Characteristics of a Coupled Helicopter Rotor-Fuselage by a Finite Element Analysis*, NASA TP-2118, 1983.
13. Gupta, K.K., M.J. Brenner, and L.S. Voelker, "Integrated Aeroservoelastic Analysis Capability with X-29A Comparisons," *J. Aircraft*, vol. 26, no. 1, 1989, pp. 84-90.
14. Abel, I., *An Analytical Technique for Predicting the Characteristics of a Flexible Wing Equipped With an Active Flutter-Suppression System and Comparison With Wind-Tunnel Data*, NASA TP-1367, 1979.
15. Appa, K., "Constant Pressure Panel Method for Supersonic Unsteady Airload Analysis," *J. Aircraft*, vol. 24, no. 10, 1987, pp. 696-702.
16. Taylor, R.F., K.L. Miller, and R.A. Brockman, *A Procedure for Flutter Analysis of FASTOP-3 Compatible Mathematical Models, Vol. 1—Theory and Application*, Air Force Wright Aeronautical Labs., TR81-3063, June 1981.

17. Geising, J.P., T.P. Kalman, and W.P. Rodden, *Subsonic Unsteady Aerodynamics for General Configurations, vols. 1 and 2*, AFFDL-TR-71-5, rev. Oct. 1977.
18. Gupta, K.K., and C.L. Lawson, "Multidisciplinary Modeling and Dynamic Response Analysis for Hypersonic Vehicles," paper no. 188, 9th National Aero-Space Plane Technology Symposium, Orlando, Florida, Nov. 1-2, 1990.



Report Documentation Page

1. Report No. NASA TM-101709 (Revised)		2. Government Accession No.		3. Recipient's Catalog No.	
4. Title and Subtitle STARS---An Integrated General-Purpose Finite Element Structural, Aeroelastic, and Aeroservoelastic Analysis Computer Program			5. Report Date January 1991		
			6. Performing Organization Code		
7. Author(s) K.K. Gupta			8. Performing Organization Report No. H-1582		
			10. Work Unit No. RTOP 505-66-71		
9. Performing Organization Name and Address Dryden Flight Research Facility P.O. Box 273, Edwards, California 93523-0273			11. Contract or Grant No.		
			13. Type of Report and Period Covered Technical Memorandum		
12. Sponsoring Agency Name and Address National Aeronautics and Space Administration Washington, DC 20546-3191			14. Sponsoring Agency Code		
			15. Supplementary Notes		
16. Abstract <p>This report presents the details of an integrated general-purpose finite element structural analysis computer program which is also capable of solving complex multidisciplinary problems. Thus, the SOLIDS module of the program possesses an extensive finite element library suitable for modeling most practical problems and is capable of solving statics, vibration, buckling, and dynamic response problems of complex structures, including spinning ones. The aerodynamic module, AERO, enables computation of unsteady aerodynamic forces for both subsonic and supersonic flow for subsequent flutter and divergence analysis of the structure. The associated aeroservoelastic analysis module, ASE, effects aero-structural-control stability analysis yielding frequency responses as well as damping characteristics of the structure. The program is written in standard FORTRAN to run on a wide variety of computers. Extensive graphics, preprocessing, and postprocessing routines are also available pertaining to a number of terminals.</p>					
17. Key Words (Suggested by Author(s)) Finite elements; Structural analysis; Aeroelasticity; Aeroservoelasticity; Graphics			18. Distribution Statement Unclassified-Unlimited Subject category 39		
19. Security Classif. (of this report) Unclassified		20. Security Classif. (of this page) Unclassified		21. No. of Pages 174	22. Price A08

