This is an electronic reprint of the original article.
This reprint may differ from the original in pagination and typographic detail.

Puvi, Verner; Lehtonen, Matti

Stochastic Assessment of Voltage Unbalance Mitigation by Home Battery System in Low Voltage Grid with Single-Phase Solar Power Generation

Published in:

Proceedings of the 2018 IEEE PES Innovative Smart Grid Technologies Conference Europe, ISGT-Europe 2018

DOI:

[10.1109/ISGTEurope.2018.8571860](https://doi.org/10.1109/ISGTEurope.2018.8571860)

Published: 10/12/2018

Document Version

Peer reviewed version

Please cite the original version:

Puvi, V., & Lehtonen, M. (2018). Stochastic Assessment of Voltage Unbalance Mitigation by Home Battery System in Low Voltage Grid with Single-Phase Solar Power Generation. In *Proceedings of the 2018 IEEE PES Innovative Smart Grid Technologies Conference Europe, ISGT-Europe 2018* [8571860] (IEEE PES Innovative Smart Grid Technologies Conference Europe). IEEE. <https://doi.org/10.1109/ISGTEurope.2018.8571860>

This material is protected by copyright and other intellectual property rights, and duplication or sale of all or part of any of the repository collections is not permitted, except that material may be duplicated by you for your research use or educational purposes in electronic or print form. You must obtain permission for any other use. Electronic or print copies may not be offered, whether for sale or otherwise to anyone who is not an authorised user.

This is the accepted version of the original article published by IEEE.

© 2018 IEEE. Personal use of this material is permitted. Permission from IEEE must be obtained for all other uses, in any current or future media, including reprinting/republishing this material for advertising or promotional purposes, creating new collective works, for resale or redistribution to servers or lists, or reuse of any copyrighted component of this work in other works.

Stochastic Assessment of Voltage Unbalance Mitigation by Home Battery System in Low Voltage Grid with Single-Phase Solar Power Generation

Verner Püvi and Matti Lehtonen

School of Electrical Engineering
Aalto University
Otakaari 1 B, 02150 Espoo, Finland
verner.puvi@aalto.fi, matti.lehtonen@aalto.fi

Abstract—Modern electrical power system is evolving to a smarter and agile system, which will support society’s sustainable development. The low voltage grid should be capable of withstanding new challenges such as reverse power flows and voltage unbalance (VU) caused by distributed generation. In this paper, the mitigation possibilities of the VU caused by single-phase-connected photovoltaics (PV) are analysed with Tesla Powerwall 2 battery energy storage systems (BESS) added to the grid. Three different BESS phase connection strategies are modelled and the VU is assessed with Monte Carlo Simulation (MCS). A low voltage distribution grid in Sweden is considered with different PV and BESS penetration levels and the applied method for VU assessment is validated. Simulation results reveal the effectiveness of VU mitigation by connecting PV and BESS to the same phase.

I. INTRODUCTION

The successful development of humanity requires a reliable and cost effective power system. Similarly to labour and capital, energy is an essential part of the development process and the power system is playing a key role in the energy infrastructure. However, the modern power system is rather not suited for sustainable development of a modern society. It is heavily based on fossil fuels [1], which are depleting. Fortunately, society is accepting the challenge of transferring to a more sustainable power system, which was recently enforced by the 2015 Paris Climate Action Agreement [2].

Power systems should be reorganised to be capable of hosting renewable energy sources and be able to tackle the problems caused by high penetration of distributed renewable energy generation [3]. One of the adverse impacts of the renewables, such as single-phase solar, is voltage unbalance in a low voltage grid [4]. In this paper, the possibilities of mitigating the voltage unbalance (VU) by introducing a battery energy storage system (BESS) to a low voltage grid with single-phase photovoltaic (PV) solar power generation is analysed and a stochastic framework for evaluating VU is developed.

Introducing a BESS to the low voltage grid has an opportunity to mitigate the VU caused by PVs. BESS charging can increase the level of VU, similarly to PV generation. On the other hand, VU can be reduced by choosing the right phase connection strategy. In this paper, three different strategies of BESS phase connection will be analysed:

- 1) BESS connected to a random phase.
- 2) BESS connected to the same phase as PV.
- 3) BESS connected to phase with highest voltage level.

The BESS considered in this paper is Tesla Powerwall 2. It is Tesla’s second generation home battery system with robust environmental specifications and relatively low lifetime cost [5], which makes it a viable option for BESS. The charging power of the BESS is assumed to be 5 kW [6]. PV arrays considered in this paper are assumed to be all single-phase-connected and the nominal power output of a single PV array is set at 6 kW. A low voltage grid is considered in this paper which is based on an existing grid in Sweden and is the same as presented in [7].

The VU is assessed with Monte Carlo Simulation (MCS) approach. The MCS covers 1000 iterations for every possible number of PVs. VU is calculated at every iteration and probabilistic VU distribution per every number of PVs is shown in the results. A MATLAB code was developed to model the stochastic MCS algorithm.

II. VOLTAGE UNBALANCE

Voltage unbalance is a phenomenon in a polyphase electrical system when phase voltages have different values and angles between phases are not equal. The causes for VU are non-symmetrical loads, non-transposed distribution grid and non-symmetrical generation. Voltage unbalance can cause problems in grid operation, such as increased losses [8], the higher utilisation factor of network components [9] and risk damaging electrical machines [10]. This makes VU an important power quality aspect, which should be taken into account in network planning.

In the three-phase electrical system, VU can be found by means of symmetrical components. The three voltage phasors are split into three components: positive ($v^{(1)}$), negative ($v^{(2)}$) and zero sequence component ($v^{(0)}$). Symmetrical components are calculated as shown in Equation 1 [11], where operator $a = 1 \cdot \angle 120^\circ$. The same formula can be applied to current phasors.

$$\begin{bmatrix} v^{(0)} \\ v^{(1)} \\ v^{(2)} \end{bmatrix} = \frac{1}{3} \begin{bmatrix} 1 & 1 & 1 \\ 1 & a & a^2 \\ 1 & a^2 & a \end{bmatrix} \cdot \begin{bmatrix} v_a \\ v_b \\ v_c \end{bmatrix} \quad (1)$$

Voltage unbalance was calculated using symmetrical components and it is defined as the ratio of the negative sequence component and the positive sequence component, as shown in Equation 2. The voltage unbalance should not exceed the limit of 2% in a low voltage grid [12].

$$VU = \frac{v^{(2)}}{v^{(1)}} \quad (2)$$

III. THE GRID

The grid used in this paper is based on the grid from [7]. The grid has a typical topology for a rural North European area and has 16 busbars, 6 of which are end busbars. Single line diagram of the grid is shown in Fig. 1.

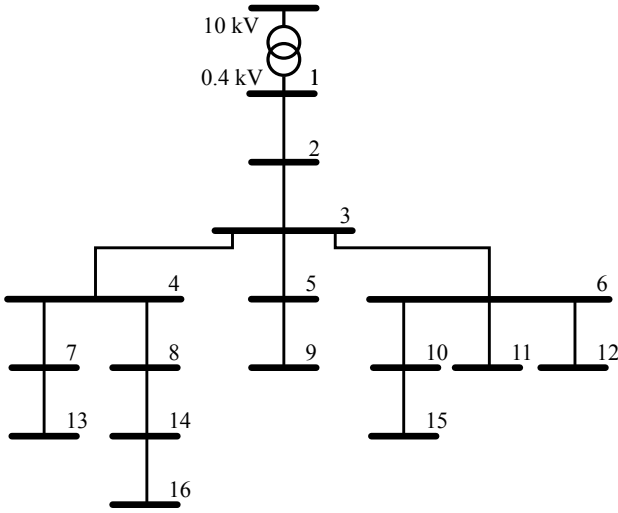

Fig. 1. The considered grid [7]

As it can be seen in Fig. 1, the end busbars are: 13, 16, 9, 15, 11 and 12. The VU is assessed at the end busbars only, because it is assumed, that customers are connected to the feeder ends. The maximum number of PVs is equal to the quantity of end busbars in the grid, because it was assumed that PVs and BESSs are connected only to the customers. The feeder and transformer (XFMR) data can be seen in Table I.

TABLE I
FEEDER AND TRANSFORMER DATA [7]

Line	R(mΩ)	X(mΩ)	Line	R(mΩ)	X(mΩ)
1-2	8.97	1.06	3-5	29.49	3.47
2-3	69.23	8.14	5-9	56.73	2.82
3-4	17.24	2.03	3-6	2.28	0.15
4-7	26.41	3.11	6-10	99.55	4.44
7-13	75.95	3.78	10-15	75.58	3.76
4-8	0.06	0.01	6-11	16.29	0.81
8-14	0.12	0.01	6-12	145.49	6.50
14-16	31.11	1.55	XFMR		64.00

IV. TRANSFER IMPEDANCE

Transfer impedance is a grid impedance model which consists of a n -by- n square matrix of impedances, where n is number of busbars [11]. Each matrix element represents the impedance between the slack bus and the point of common coupling for two busses. A MATLAB code was developed based on the algorithm described in Table II.

TABLE II
TRANSFER IMPEDANCE CALCULATION [7]

1	Connect PV/BESS at busbar m .
2	Calculate negative sequence current $i_m^{(2)}$ at busbar m .
3	Calculate negative sequence voltage $v_n^{(2)}$ at busbar n .
4	Find a ratio of voltage at busbar n and current at busbar m , which will be a nm element of transfer impedance matrix Z_{nm} .
5	Repeat steps 3 and 4 for all busbars.
6	Repeat steps 1 to 5 for all busbars.

In this paper, the negative sequence voltage column vector was calculated by multiplying the transfer impedance square matrix by the column vector of injected negative sequence currents at every busbar, as shown in Equation 3.

$$v_n^{(2)} = Z_{nm} \cdot i_m^{(2)} \quad (3)$$

Negative sequence current was obtained with Equation 1 and equals to one third of the phase current. It was assumed that negative sequence impedance is equal to positive sequence impedance [13], thus no impedance modifications were made.

V. STRATEGY DESCRIPTION

Three different BESS phase connection strategies are analysed in this paper. The high penetration of PV generation in a low voltage distribution grid can cause severe VU levels due to the high injection of negative sequence current component [14] and imbalanced current can be compensated by the single-phase equipment. In order to mitigate the VU, the BESS connection phase can be chosen among the three-phases feeding the residential households. The aim is to assess the impact of every strategy on the VU and evaluate which strategy has the best VU mitigating potential. The strategies are listed below.

- Strategy 1 - Random phase
The first strategy has chosen phase for the BESS connection randomly. The PV and BESS were connected to grid without phase coordination, leading to random phase for both.
- Strategy 2 - Same phase as PV
In the second strategy, the BESS was connected to the same phase as the PV. Wires have dedicated colour for each phase and PV phase can be tracked down.
- Strategy 3 - The phase with highest voltage level
During the third strategy, the BESS was connected to a phase which has the highest voltage level. This strategy requires phase voltage measurements and could require coordination with distribution system operator (DSO).

VI. MONTE CARLO SIMULATION

In this paper, VU was evaluated with a MCS method. In [7], [15] and [16], the same approach was chosen to assess the VU. This method is appropriate for stochastic assessment of VU during network planning, because DSOs have a little information about the penetration and location of PV production and BESS charging in real time. In the future, low voltage grids will host more of the smaller scale single-phase generation and storage devices, connection parameters of which are hard to coordinate.

In order to simplify the model, constant current models were assumed for both the PV and BESS. The current drawn was equal to the maximum current, which corresponds to the maximum power. The flowchart of the stochastic VU assessment can be seen in Fig. 2.

The quantity, location and phase connection were generated with a uniform distribution. In other words, there is equal probability, e.g. for that a PV was connected to phase *a*, *b* or *c*.

The VU assessment algorithm was divided into two parts. During the first part, the PV location and phase connection were randomly chosen. The PV quantity was incremented from one to maximum possible number of PVs by one after the 1000 iteration runs were over. The maximum possible number of PVs is equal to the number of end busbars, which, in the case of the considered grid, is six.

In the second part, the quantity and location of BESS were randomly sampled within the values of PV. Phase connection was determined by the chosen strategy (discussed in Section V). The number of BESS was lower or equal to the number of PVs and they were located at the same busbars. It was assumed that only customers with PV arrays can have a BESS installed. For every number of PVs, the algorithm ran for 1000 times and VU was assessed at every iteration.

VII. RESULTS

The results are divided into two parts. During the first part, the VU values of the PV-only case are presented. In the second part, BESS was introduced to the model and the results of the three different BESS phase connection strategies are presented. Different colours refer to different end busbars.

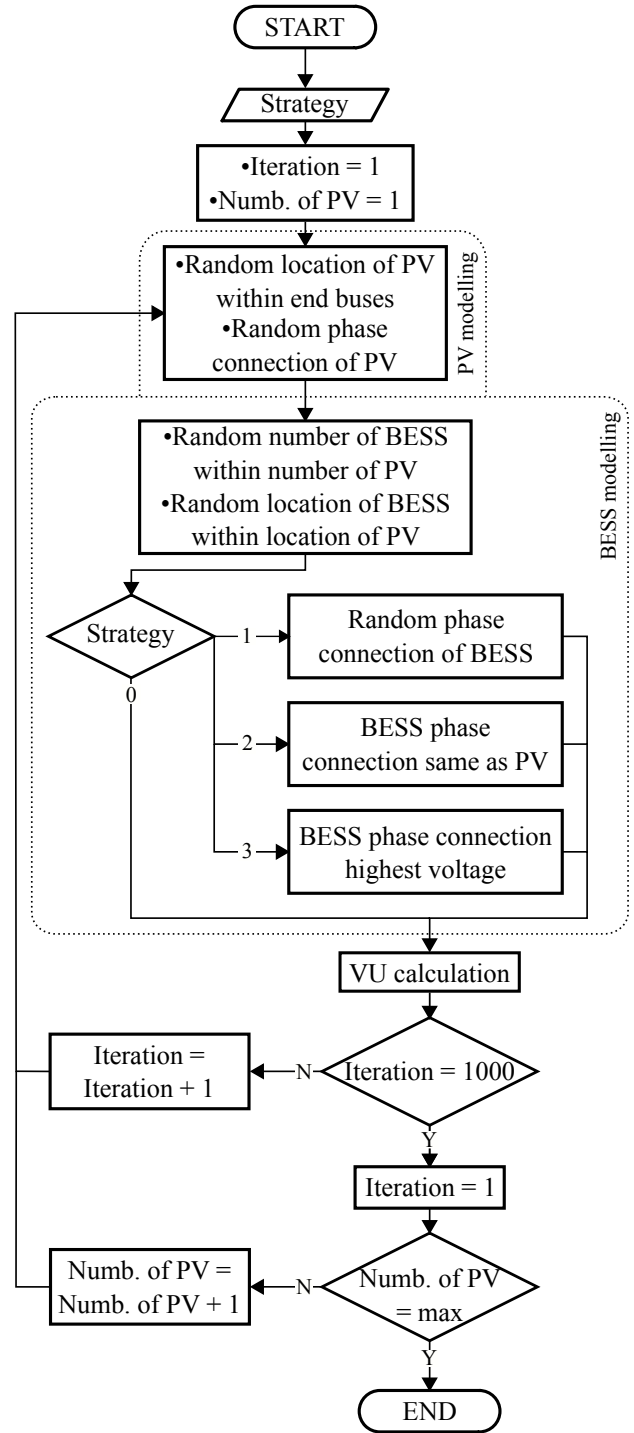

Fig. 2. Flowchart of MCS-based stochastic VU assessment

A. PV only - method validation

In this subsection, the VU caused only by PV penetration was assessed. BESS penetration was equal to zero. The results were compared with the ones in [7] to validate the VU assessment method was. The VU probability distribution functions in the case of three and five PVs are shown in Fig. 3 and Fig. 4.

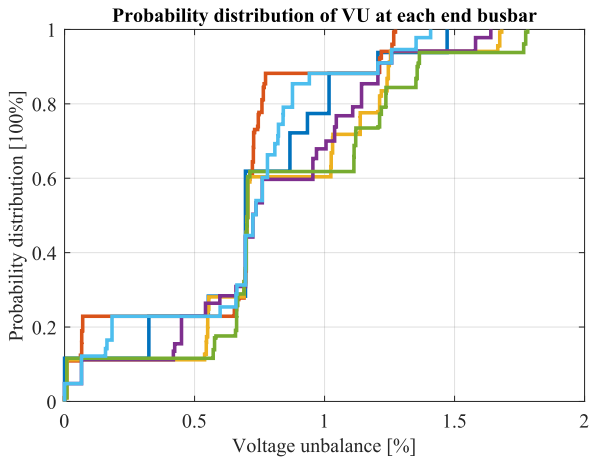

Fig. 3. Probability distribution of VU in the case of three PVs

The obtained results demonstrate that with three PVs the VU of 1% has nonoccurrence probability of approximately 60% to 90% and VU higher than 1.8% is unlikely to occur. The limit of 2% is not exceeded. Obtained results match results presented in [7] with reasonable accuracy by visual inspection.

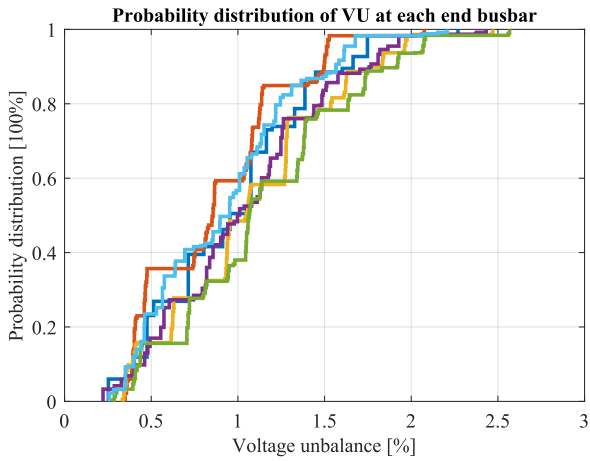

Fig. 4. Probability distribution of VU in the case of five PVs

With five PVs connected to the grid, the results show that VU of 1% has a probability of around 50% and VU is less than 2% with 95% to 100% probability. Results match the ones in [7].

Fig. 5 presents a deeper analysis of the VU dependency from number of PVs. The $VU_{exp, mean}$ denotes the mean value of the VU that is expected to occur in the grid. The $VU_{95\%, mean}$ denotes the mean value over all end busbars of the 95th percentile of the VU. The 95th percentile value is favourable in stochastic network planning, because the probability that the value is exceeded is sufficiently small and it is unnecessary to consider the worst case scenario [14]. The $VU_{95\%, max}$ denotes the maximum value of the 95th percentile. Unlike the $VU_{95\%, mean}$, the $VU_{95\%, max}$ designate the maximum value of a single busbar.

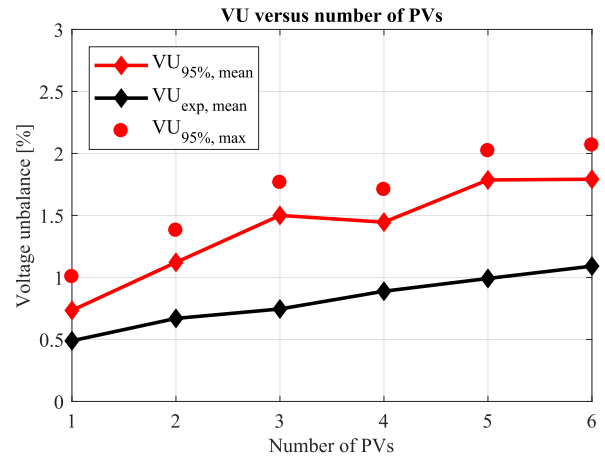

Fig. 5. VU dependency on the number of PVs in the grid

By increasing the number of PVs in the grid, the $VU_{exp, mean}$ value is increased from 0.5% to around 1.1%. The $VU_{95\%, mean}$ increases from 0.75% to 1.9%. All the values are lower than the VU limit of 2%. Nevertheless, the $VU_{95\%, max}$ critically approaches the limit at five PVs and in the case of six PVs - the VU limit is exceeded. This means that 95th percentile value is within the limit on a grid scale, but it can be exceeded on a single busbar scale.

The 95th percentile values are slightly decreased at four PVs, compared to the grid with three PVs. The reason for this is that with more single-phase PVs in a grid, the less is the probability having them all in one phase [14]. Results shown in Fig. 5 match with the ones presented in [7].

The developed VU assessment method can be considered valid as the obtained results match the reference results.

B. Strategy 1 - PV with BESS in Random Phase

VU was assessed with BESS connected to random phases. The results with five PVs connected can be seen in Fig. 6 and VU dependency on the number of PVs can be seen in Fig. 7.

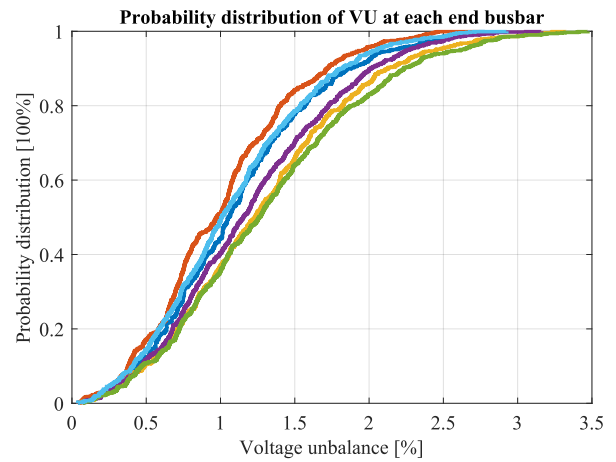

Fig. 6. Probability distribution of VU in the case of five PVs and BESS connected to random phases

After BESS were added to random phases in the grid, the VU levels have risen (Fig. 6). In case of five PVs the charging of BESS caused higher VU, reaching 45% to 65% probability of 1% VU and up to 19% probability of exceeding 2% VU.

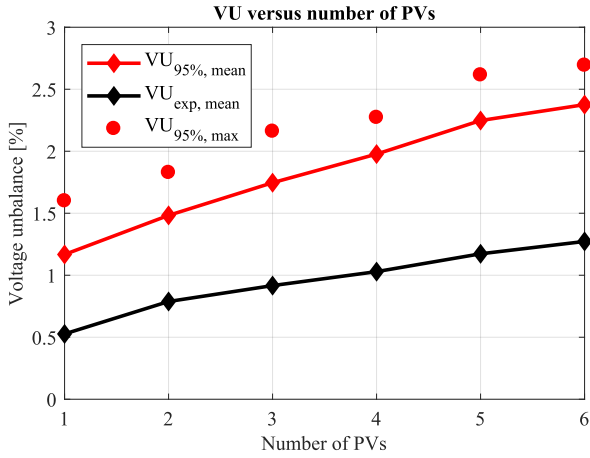

Fig. 7. VU dependency on the number of PVs in the grid with BESS connected to random phases

Fig. 7 gives a better illustration of the VU trend. The $VU_{exp, mean}$ has a higher value within the range of PV penetration. The expected VU in the grid can now reach 1.25%, which is still within the limit. On the other hand, the $VU_{95%, mean}$ value exceeds the limit at four PVs and can be exceeded on some single busbars already at three PVs.

The results imply that connecting BESS to random phase will have a negative effect on the VU level and is not an appropriate strategy for mitigating the VU in low voltage grid with single-phase solar power generation.

C. Strategy 2 - PV with BESS in the same phase

In this strategy, the BESS was connected to the same phase as the PV. The VU probability distribution function and VU versus number of PVs can be seen in Fig. 8 and Fig. 9.

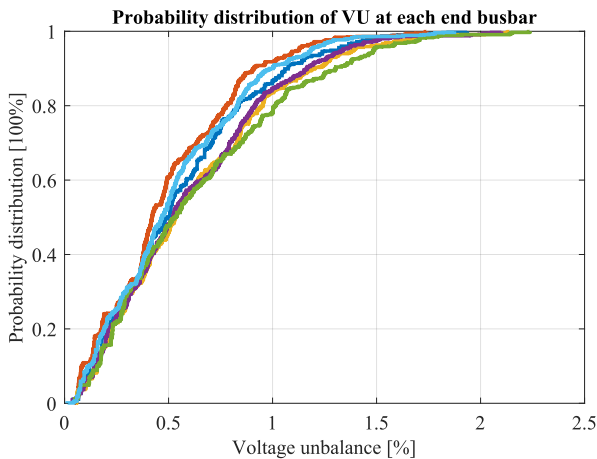

Fig. 8. Probability distribution of VU in the case of five PVs and BESS connected to same phase as PV

Connecting the BESS to the same phase with the PV has positive result (Fig. 8). The VU has decreased compared to the system without BESS. The VU of 1% has a nonoccurrence probability of 75% to 90% and exceeding the 2% of VU is possible in end busbars in 0-2% of cases.

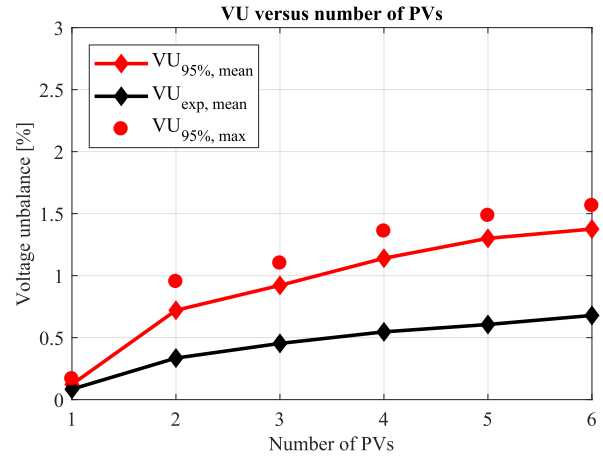

Fig. 9. VU dependency on the number of PVs in the grid with the BESS connected to same phase

In Fig. 9, the $VU_{exp, mean}$ has a lower value compared to the grid without BESS, and ranges from 0.1% to 0.7%. The 95th percentile values are very low in the case of one PV, staying approximately at 0.1% of VU. However, it can reach values around 1.5% of VU in case of six PVs. All the values are below the VU limit. The strategy of connecting the BESS to the same phase as the PV has good results in VU mitigation.

D. Strategy 3 - PV with BESS in phase with highest voltage

In this strategy, the BESS was connected to a phase with the highest voltage level. The results can be seen in Fig. 10 and Fig. 11.

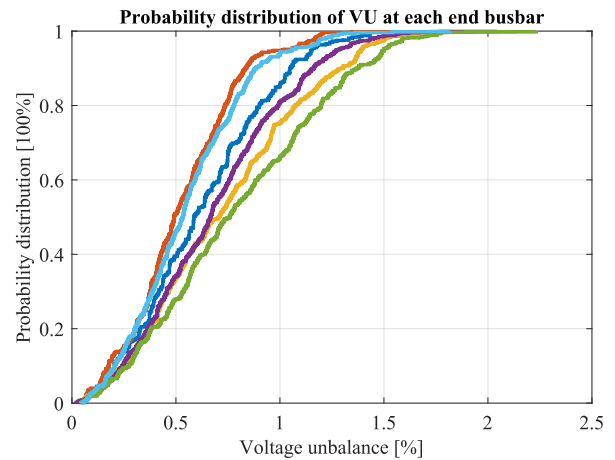

Fig. 10. Probability distribution of VU in the case of five PVs and BESS connected to the phase with highest voltage level

In the case of five PVs connected to the grid (Fig. 10), the 1% VU has a probability from 65% to 95% on different busbars. The probability of occurrence of 2% VU or higher is less than 5%.

A more comprehensive analysis of the VU dependency from the number of PVs can be seen in Fig. 11. The VU slope in the beginning of the graph is steeper than in the end of it, meaning that the number of PVs has a higher impact on the VU with low number of PVs. This can be seen in the case of 1-3 PVs, when VU levels rises significantly. On the other hand, the VU increases slowly but surely at higher number of PVs. Starting from 4 PVs, the VU increases with relatively consistent rate. The $VU_{exp, mean}$ levels in the case of Strategy 3 reach 0.75% of VU with the maximum number of PVs. The 95th percentile mean and maximum values stay around 1.5%.

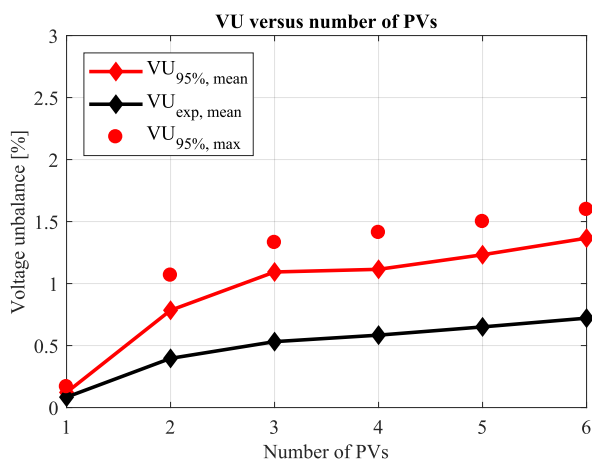

Fig. 11. VU dependency on the number of PVs in the grid with BESS connected to the phase with highest voltage

Strategy 3 has a positive outcome on VU mitigation and the results are similar to Strategy 2.

VIII. CONCLUSION

A stochastic method based on MCS was used to estimate the VU mitigation possibilities by introducing a BESS in a low voltage distribution grid with single-phase PV generation. The method was developed in MATLAB and the results were validated with research work that has utilised the same approach.

Three different BESS connection strategies were modelled and VU mitigating possibilities of each were analysed. Simulation results show that connecting BESS to random phases had a negative effect and increased the VU levels in a system. Connecting the BESS to the same phase as the PV had a positive effect and VU levels decreased. Connecting the BESS to the phase with the highest voltage level had a positive effect on the VU mitigation as well.

ACKNOWLEDGMENT

The author would like to extend his gratitude towards Toni Tukia for discerning review of the paper and Prof. Matti Lehtonen for his continuous, unconditional support and benevolently critical comments.

REFERENCES

- [1] R. Fouquet, *Path dependence in energy systems and economic development*, Nature Energy, Vol. 1, 1-5, 2016, DOI: 10.1038/nenergy.2016.98 [Online]. Available: <https://www.nature.com/articles/nenergy201698>.
- [2] European Commission, "Directive 2009/28/EC of the European Parliament and of the Council of 23 April 2009 on the promotion of the use of energy from renewable sources and amending and subsequently repealing Directives 2001/77/EC and 2003/30/EC." Official Journal, L 140/16, 2009. [Online]. Available: <http://eur-lex.europa.eu/legal-content/EN/TXT/PDF/?uri=CELEX:32009L0028&from=EN>.
- [3] H. Farhangi, *The path of the smart grid*, IEEE Power and Energy Magazine, Vol. 8, Issue: 1, 18-28, 2010, DOI: 10.1109/MPE.2009.934876 [Online]. Available: <http://ieeexplore.ieee.org/document/5357331/>.
- [4] F. Katiraei, K. Mauch and L. Dignard-Bailey, *Integration of Photovoltaic Power Systems in High-Penetration Clusters for Distribution Networks and Mini-Grids*, International Journal of Distributed Energy Resources, Vol. 3, 2007, [Online]. Available: https://www.researchgate.net/publication/228348973_Integration_of_Photovoltaic_Power_Systems_in_High-Penetration_Clusters_for_Distribution_Networks_and_Mini-Grids.
- [5] M.J.M. Davis, and P. Hiralal, *Batteries as a Service: A New Look at Electricity Peak Demand Management for Houses in the UK*, Procedia Engineering, Vol. 145, 1448-1455, 2016, DOI: 10.1016/j.proeng.2016.04.182 [Online]. Available: <http://www.sciencedirect.com/science/article/pii/S187705816301898>.
- [6] *Tesla Powerwall 2 AC Datasheet*, TESLA, INC, USA, 2016. [Online]. Available: <http://www.energymatters.com.au/wp-content/uploads/2016/11/tesla-powerwall-2-datasheet.pdf>.
- [7] D. Schwanz, F. Möller, S.K. Rönnberg, J. Meyer, and M.H.J. Bollen, *Stochastic assessment of voltage unbalance due to single-phase-connected solar power*, Belo Horizonte, Minas Gerais, Brazil, 2016, 95-103, DOI: 10.1109/ICHQP.2016.7783353 [Online]. Available: <http://ieeexplore.ieee.org/document/7783353/>.
- [8] L.F. Ochoa, R.M. Ciric, A. Padilha-Feltrin, and G.P. Harrison, *Evaluation of distribution system losses due to load unbalance*, Liège, Belgium, 2005, [Online]. Available: https://www.researchgate.net/publication/241310835_Evaluation_of_distribution_system_losses_due_to_load_unbalance.
- [9] K. Ma, R. Li, and F. Li, *Quantification of Additional Asset Reinforcement Cost From 3-Phase Imbalance*, IEEE Transactions on Power Systems, Vol. 31, Issue: 4, 2885 - 2891, 2015, DOI: 10.1109/TPWRS.2015.2481078 [Online]. Available: <http://ieeexplore.ieee.org/document/7279212/>.
- [10] D.H. Harrison, *Voltage unbalance on rural systems*, Power Engineering Journal, Vol. 1, Issue: 3, 149 - 153, 1987, DOI: 10.1049/pe:19870028 [Online]. Available: <http://ieeexplore.ieee.org/document/4807735/>.
- [11] J.J. Grainger and W.D. Stevenson, Jr, *Power System Analysis* Singapore: McGraw-Hill Book, Co, 1994.
- [12] *Voltage characteristics of electricity supplied by public electricity networks*, SFS-EN 50160, 2010.
- [13] J.L. Blackburn and T.J. Domin, *Protective Relaying. Principles and Applications*, 3rd ed. Boca Raton, FL, USA: CRC Press, 2006.
- [14] M. Bollen and F. Hassan, *Integration of Distributed Generation in the Power System*, 3rd ed. Hoboken, NJ, USA: John Wiley & Sons, Inc, 2011.
- [15] N. Safitri, F. Shahnia, and M.A.S. Masoum, *Stochastic analysis results for coordination of single-phase rooftop PVs in unbalanced residential feeders*, Brisbane, QLD, Australia, 2015, 1-5, DOI: 10.1109/APPEEC.2015.7381053 [Online]. Available: <http://ieeexplore.ieee.org/document/7381053/>.
- [16] F.J. Ruiz-Rodriguez, J.C. Hernández, and F. Jurado, *Voltage unbalance assessment in secondary radial distribution networks with single-phase photovoltaic systems*, International Journal of Electrical Power & Energy Systems, Vol. 64, 646-654, 2015, DOI: 10.1016/j.ijepes.2014.07.071 [Online]. Available: <http://www.sciencedirect.com/science/article/pii/S0142061514005158>.