



AALBORG UNIVERSITY
DENMARK

Aalborg Universitet

Stochastic Optimization of Economic Dispatch for Microgrid Based on Approximate Dynamic Programming

Shuai , Hang; Fang, Jiakun; Ai, Xiaomeng; Tang, Yufei; Wen, Jinyu; He, Haibo

Published in:

I E E Transactions on Smart Grid

DOI (link to publication from Publisher):

[10.1109/TSG.2018.2798039](https://doi.org/10.1109/TSG.2018.2798039)

Publication date:

2019

Document Version

Accepted author manuscript, peer reviewed version

[Link to publication from Aalborg University](#)

Citation for published version (APA):

Shuai , H., Fang, J., Ai, X., Tang, Y., Wen, J., & He, H. (2019). Stochastic Optimization of Economic Dispatch for Microgrid Based on Approximate Dynamic Programming. *I E E Transactions on Smart Grid*, 10(3), 2440 - 2452. [8269410]. <https://doi.org/10.1109/TSG.2018.2798039>

General rights

Copyright and moral rights for the publications made accessible in the public portal are retained by the authors and/or other copyright owners and it is a condition of accessing publications that users recognise and abide by the legal requirements associated with these rights.

- Users may download and print one copy of any publication from the public portal for the purpose of private study or research.
- You may not further distribute the material or use it for any profit-making activity or commercial gain
- You may freely distribute the URL identifying the publication in the public portal -

Take down policy

If you believe that this document breaches copyright please contact us at vbn@aub.aau.dk providing details, and we will remove access to the work immediately and investigate your claim.

Stochastic Optimization of Economic Dispatch for Microgrid Based on Approximate Dynamic Programming

Hang Shuai, *Student Member, IEEE*, Jiakun Fang, *Member, IEEE*, Xiaomeng Ai, *Member, IEEE*, Yufei Tang, *Member, IEEE*, Jinyu Wen, *Member, IEEE*, and Haibo He, *Fellow, IEEE*

Abstract—This paper proposes an approximate dynamic programming (ADP) based approach for the economic dispatch (ED) of microgrid with distributed generations (DGs). The time-variant renewable generation, electricity price and the power demand are considered as stochastic variables in this work. An ADP based ED (ADPED) algorithm is proposed to optimally operate the microgrid under these uncertainties. To deal with the uncertainties, Monte Carlo (MC) method is adopted to sample the training scenarios to give empirical knowledge to ADPED. The piecewise linear function (PLF) approximation with improved slope updating strategy is employed for the proposed method. With sufficient information extracted from these scenarios and embedded in the PLF function, the proposed ADPED algorithm can not only be used in day-ahead scheduling but also the intra-day optimization process. The algorithm can make full use of historical prediction error distribution to reduce the influence of inaccurate forecast on the system operation. Numerical simulations demonstrate the effectiveness of the proposed approach. The near-optimal decision obtained by ADPED is very close to the global optimality. And it can be adaptive to both day-ahead and intra-day operation under uncertainty.

Index Terms—Microgrid, approximate dynamic programming (ADP), stochastic optimization, economic dispatch (ED).

I. NOMENCLATURE

Abbreviations

<i>ADP</i>	Approximate dynamic programming.
<i>ADPED</i>	Approximate dynamic programming based economic dispatch.
<i>DG</i>	Distributed generation.
<i>ED</i>	Economic dispatch.
<i>EMS</i>	Energy management system.
<i>FC</i>	Fuel cell.

This work was supported in part by the National Key R&D Program of China (2016YFB0900400, 2016YFB0900403), and in part by the National Natural Science Foundation of China (51529701). (*Corresponding author: Jiakun Fang.*)

H. Shuai, J. K. Fang, X. M. Ai and J. Y. Wen, are with State Key Laboratory of Advanced Electromagnetic Engineering and Technology, School of Electrical and Electronic Engineering, Huazhong University of Science and Technology, Wuhan, 430074, China. J. K. Fang is also with the Aalborg University, Aalborg, Denmark. (email: hangshuai@hust.edu.cn; jiakun.fang@gmail.com; xiaomengai@hust.edu.cn; jinyu.wen@hust.edu.cn)

Y. F. Tang, Department of Computer and Electrical Engineering and Computer Science (CECS), Florida Atlantic University (FAU), Glades Road, FL, 33431, USA. (email: tangy@fau.edu)

H. He, is with the Department of Electrical, Computer and Biomedical Engineering, University of Rhode Island, Kingston, RI, 02881, USA. (e-mail: he@ele.uri.edu.)

<i>GG</i>	Gas generator.
<i>MC</i>	Monte Carlo.
<i>MDP</i>	Markov Decision Process.
<i>MILP</i>	Mixed integer linear programming.
<i>O&M</i>	Operation and maintenance.
<i>PV</i>	Photovoltaic panel.
<i>PLF</i>	Piecewise linear function.
<i>SOC</i>	State of charge.
<i>VFA</i>	Value function approximation.
<i>WT</i>	Wind turbine.
Sets	
\mathcal{G}	Set of power sources, {GG, FC, PV, WT, battery, upper-level grid}.
$\bar{\mathcal{G}}$	Set of generators, including {GG, FC, PV, WT, battery}.
\mathcal{I}	Set of nodes, {1,...,I}, the number of nodes is I .
\mathcal{L}	Set of nodes connected with load, {1,...,L}, where $\mathcal{L} \subset \mathcal{I}$. The total number of nodes connected with load is L .
\mathcal{T}	Set of time periods, $\{\Delta t, 2\Delta t \dots, T\}$.

Indices

a	Segment index of piecewise linear function, $a \in \{1, 2, \dots, N_t\}$.
g	Generator type index, $g \in \mathcal{G}$.
i, j	Node index.
n	Iteration/scenario index.
t	Time period indices.

Parameters

B, G	The imaginary and real part of admittance matrix.
B'	The imaginary part of admittance matrix without shunt elements.
c^{wt}, c^{pv}, c^{load}	The cost of wind power curtailment, solar power curtailment, and load shedding.
$E_{bat}^{min}, E_{bat}^{max}$	Capacity limits of battery.
k_g, l_g	Fuel cost and O & M cost coefficient of generator g .
N	Maximum iteration number.
N_t	Total number of segments for PLF \bar{V}_t .

$P_{bat}^{c,max}, P_{bat}^{d,max}$	Maximum charge/discharge power for battery.	$P_{grid,t}$	Active power exchange between microgrid and external grid at time t .
$P_{ij}^{min}, P_{ij}^{max}$	Minimum/maximum power flow limit from bus i to bus j .	$\hat{P}_{WT,t}, \hat{P}_{PV,t}$	Forecast error of the wind and solar power.
P_g^{min}, P_g^{max}	Minimum/maximum active power generation for generator g .	$P_{WT,t}^a, P_{PV,t}^a$	Available wind and solar power at time t .
Q_g^{min}, Q_g^{max}	Minimum/maximum reactive power generation for generator g .	$P_{WT,t}, P_{PV,t}$	Dispatched wind and solar power at time t .
P_g^{down}, P_g^{up}	Maximum ramping down/up rate for generator g .	p_t	Electricity price of the real-time electricity market at time t .
T	Optimization horizon.	\hat{p}_t	Forecast error of the electricity price.
$T_{i,g}$	Element in the generator-node incidence matrix. When generator g connected to node i , $T_{i,g} = 1$.	Q_t	Reactive load of the system at time t .
Δt	Time step.	$Q_{g,t}$	Reactive power output of generator g . $g \in \mathcal{G}$
η^d, η^c	Discharge/charge efficiency of battery.	$r_{t,a}$	Battery coordinate variable for segment a at time t .
γ	Discount factor.	S_t, S_t^x	State variable and post-decision state variable at time t .
Variables		SOC_t	State of charge of the battery at time t .
$C_t(S_t, x_t)$	Immediate reward, i.e. operation cost of microgrid in time period t , when system being in state S_t and take the decision x_t .	$U_{bat,t}^c, U_{bat,t}^d$	Charge and discharge mode of battery at time t , $U_{bat,t}^c$ and $U_{bat,t}^d \in \{0, 1\}$.
$C_{f,t}, C_{m,t}$	Fuel cost and O & M cost of microgrid at time t .	v	Initial slopes for unimproved ADP algorithm.
$C_{p,t}$	Cost to purchase electricity from grid at time t .	W_t	Exogenous information at time t .
$C_{cur,t}$	Renewable energy curtailment and load shedding cost at time t .	x_t	Decision variable at time t .
D_t	Active load of the system at time t .	α^n	The step size of ADP algorithm in iteration n .
\hat{D}_t	Forecast error of the active load.	χ_t	Feasible region of decision variable at time t .
$d_{t,a}^n$	Slope for segment a of PLF at time t .	ε_t	The predict error of day ahead forecast information at time t .
$\hat{d}_{t,a}^n$	Sample observation of the update slope at time t coordinate to segment a in iteration n .		
F_{ADPED}^m	Intra-day optimization error of the ADPED for a particular scenario m .		
F	Total operation cost of microgrid over the optimization horizon.		
$F_{ADPED}^{m,n}$	Near-optimal value for the objective function of the test scenario m calculated by the ADPED using the PLFs obtained in the n th iteration.		
F_B^m	Optimal value of objective function for test scenario m obtained by MILP.		
I_t^f, I_t^r	Day ahead forecast value and actual value at time t .		
$V_{i,t}, \theta_{i,t}$	Magnitude and phase angle of node i at time t .		
$V_t(\cdot)$	Cost-to-go function at time t .		
$\bar{V}_t^x(\cdot)$	Approximated value function at time t .		
$P_{bat,t}^c, P_{bat,t}^d$	Charge and discharge power of battery at time t .		
$P_{i,t}^{cur}$	The load curtailment of node i at time t .		
$P_{g,t}$	Active power output of generator g at time t .		

II. INTRODUCTION

The world is seeing a tremendous growth in a variety of distributed energy sources due to the increasing concerns on the environment, public awareness of the depletion of fossil resources, advances in technology, reduction in costs, and incentives [1], [2]. Microgrid with different kinds of distributed generations (DGs) and energy storage devices, is a popular way of utilizing renewable energy. Operating in parallel with or independently from the main power grid, the microgrid ensures local, reliable, and affordable energy for urban and rural communities. Benefits that extend to utilities and the communities at large include lowering greenhouse gas emissions, enhancing the grid resilience [3], [4] and helping mitigate disturbances.

Similar to the economic dispatch (ED) in power system, the optimal operation of the microgrid can be formulated as a multi-time period optimization problem. To operate the microgrid economically and reliably, the day-ahead scheduling and intra-day online optimization are both critical for microgrid operation.

For the day-ahead scheduling of microgrid, some literature have modeled the ED of microgrid as a deterministic optimization problem [5]–[8]. Yet DGs such as WT and PV are intermittent power sources and hence become non-dispatchable. To accommodate the stochastic renewable energy in a microgrid, stochastic optimization approaches have been used to make the decision feasible and near-optimal for a number of selected

scenarios [9]–[12]. Besides, the scenario tree method [11] and chance constrained optimization techniques [12] are usually used to cope with the uncertainty.

The inaccurate forecast may lead to the infeasibility of the day-ahead scheduling when applied to the intra-day operation. So the pre-determined scheduling needs to be adjusted or even re-dispatched according to the real-time situations. For the intra-day optimization of a microgrid, to make sure power balance and economical operation of the microgrid, the system operator needs to change the output of the controllable generators according to the difference between day ahead forecast and latest prediction. Several heuristic algorithms [5] and online optimization algorithms [9] have been developed. For example, if the difference between the day-ahead and hour-ahead forecast exceeds the online power reserve (e.g. 10%), an adjustment algorithm is required to compensate the unbalance power [5]. In [9], an online model predictive control (MPC) algorithm has been used to counteract the forecast error in the photovoltaic plants integrated power market.

The day-ahead scheduling and intra-day optimization for optimal operation are usually executed by the energy management system (EMS) in the microgrid [5], [11], [13]. To obtain an optimal day-ahead scheduling, the EMS prefers the day ahead forecast information to be as accurate as possible. In the intra-day operation, the latest forecast for the next few hours will be updated, and hence the day-ahead scheduling is adjusted accordingly [11], [13]. However, the empirical knowledge embedded in the historical forecast data of the system haven't been adequately used in these work. And the economics of microgrid operation is dependent on the forecast accuracy of renewable generation, load, etc. Besides, the power dispatch when intra-day updated forecast information is missing has not been studied. When the system operator cannot obtain the updated forecast information, the effect of conventional methods for intra-day optimization may deregulate greatly.

This paper proposes a new ADP based energy management algorithm which can overcome the above deficiencies. The characteristic of the algorithm sets apart the work in this paper from previous efforts.

ADP is a modeling and algorithmic framework for stochastic optimization problems [14]. In this framework, the multi-time period optimization is viewed as Markov decision process (MDP). Following the basic idea of dynamic programming (DP), *Bellman's* equation is used to decompose the temporal dependency so that the large-scale optimization is divided into small sub-problems and solved iteratively. However, high-dimensional decision space usually brings the theoretical challenges named “the curse of dimensionality” to DP methodologies. To address these challenges, approximate dynamic programming (ADP) has been developed [15], which has drawn broad interest in recent years [16]–[19]. In the operational research field, ADP can be categorized into value function approximation (VFA), policy function approximation (PFA), policies based on value function approximations and some hybrid methods. These approaches have been demonstrated to be effective to solve many stochastic optimization problems such as resource allocation problems and demand management [15]. In the arsenal for ADP, value function approximation

is one of the most powerful tools. Different approximation methods such as neural network [20]–[24], analytic functions [25]–[27] (linear function, PLF, etc.), lookup tables [19], [31], [32], etc. are used.

Because ADP can deal with uncertainties, scholars have made some efforts to apply ADP in energy storage operation problem [25], [26], [28], energy policy and investment planning [27], [29], smart home management [30], and electricity market [19]. These works have shown that ADP performs very well in many real-world practices. So this work develops an ADP based economic dispatch (ADPED) algorithm for the optimal operation of the microgrid. As piece-wise linear function (PLF) approximation method is suitable for storage problem [25], PLF is adopted to approximate the value functions. The major contributions of this paper are as follows:

- 1) An ADP based economic dispatch (ADPED) algorithm for microgrid operation is proposed. The ADPED embeds empirical knowledge obtained from historical data to make near-optimal decisions. And the near-optimal policy determined by the ADPED is adaptive to stochasticity.
- 2) A new method to calculate the sample observation of marginal value of the energy stored in the battery is proposed in this work, which can be used to update the slope of the PLF. The new method can speed up the convergence rate of PLF based ADP.

The advantage of the ADPED algorithm is that it can decrease the impact of the uncertainty introduced by renewable power generation, load, and electricity price on the operation of the microgrid. With the empirical knowledge embedded, ADPED superior existing deterministic algorithm when the forecast information is inaccurate or even missing.

The remainder of this paper is organized as follows. Section III contains the formulation of the mathematical model of the microgrid. Then the ADPED algorithm is proposed in section IV. Numerical simulations are designed to demonstrate the validity of the proposed ADPED algorithm in section V. Conclusions are summarized in section VI.

III. MATHEMATICAL MODEL OF ECONOMIC DISPATCH FOR MICROGRID

The power sources in the microgrid can be categorized into two classes: wind turbines (WT) and photovoltaic panel (PV) are non-dispatchable sources, while gas generator (GG), fuel cell (FC), and energy storage device are dispatchable sources. The schematic diagram of the microgrid system is illustrated in Fig. 1. This paper assumes that the centralized EMS controls the operation of the microgrid. The EMS unit collects two kinds of information to support the decision-making. The first category is the forecast value of wind power, solar power, electricity price, and demand. The second is the real-time monitoring of the system states including the SOC of the battery and the output of the dispatchable sources. Based on this information, the EMS unit controls the power flow to achieve the best economics while at the same time ensures the security of energy supply. The charging and discharging losses in the battery system are considered. In grid-connected

operation mode, the microgrid can purchase or sell electricity to the upper-level grid according to the electricity price, total demand, and available generation capacity. In this section, the ED of the microgrid is mathematically formulated as the *Markov* decision process.

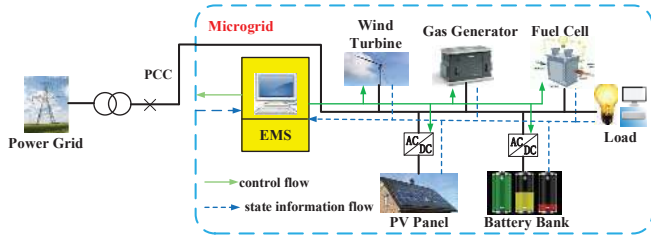

Fig. 1. The schematic diagram of a microgrid system.

A. State Variables and Decision Variables

Considering the dispatch of the microgrid over a finite time horizon T , and the time step is Δt , let $\mathcal{T} = \{\Delta t, 2\Delta t \dots, T\}$. In this paper, set $\Delta t = 1h$. In the MDP modeling framework, there are two classes of variables, namely state variables and decision variables. The state variables reflects the current state of the system which are collected by the EMS and used to make operational decisions. The state variable S_t is defined by (1).

$$S_t = \{P_{GG,t-\Delta t}, P_{FC,t-\Delta t}, SOC_t, P_{WT,t}^a, P_{PV,t}^a, D_t, p_t\} \quad (1)$$

Some past system decisions are also included in S_t , e.g. $P_{GG,t-\Delta t}$ and $P_{FC,t-\Delta t}$, because ramping constraints are considered here. Under these constraints, the feasible power output range is limited by the output power in the previous time period.

The decision variables include: the active/reactive power output of all power sources, charge/discharge power of the storage devices, and the load curtailment power. Although, the wind and solar are non-dispatchable sources, their curtailment can be determined so as to maintain the power balance. In addition, node voltages and phase angles are also considered. Hence, the vector x_t consisting of decision variables is given by:

$$x_t = \left\{ P_{g,t}, Q_{g,t}, P_{grid,t}, P_{bat,t}^c, P_{bat,t}^d, U_{bat,t}^c, U_{bat,t}^d, P_{i,t}^{cur}, V_{i,t}, \theta_{i,t} \right\} \quad (2)$$

where, $g \in \{GG, FC, WT, PV\}$. The dispatched renewable power, e.g. $P_{WT,t}$ and $P_{PV,t}$, equals to the available minus the curtailed. From (1) and (2), it can be found that the decision variables $P_{WT,t-\Delta t}$ and $P_{PV,t-\Delta t}$ in $x_{t-\Delta t}$ become elements of the state variable S_t .

In addition to the system states and decision variables, the vector W_t consisting of the exogenous information process is given by

$$W_t = \{\hat{P}_{WT,t}, \hat{P}_{PV,t}, \hat{D}_t, \hat{p}_t\} \quad (3)$$

The exogenous information W_t is used to represent the stochastic factors in the system (see [15][Chapter 5]). In this work, W_t are the day-ahead forecast error of electricity price, demand,

and renewable energy. In the decision sequence, the exogenous information arrives after the previous time $t - \Delta t$ and before the current decision is made at t . Hence, the whole decision process evolves as $(S_t, x_t, W_{t+\Delta t}, S_{t+\Delta t}, x_{t+\Delta t}, W_{t+2\Delta t}, \dots)$.

According to S_t , x_t and $W_{t+\Delta t}$, the state at time $t + \Delta t$ can be calculated by the transition function $S_{t+\Delta t} = S^M(S_t, x_t, W_{t+\Delta t})$. The function can be written as follows

$$S_{t+\Delta t}(1) = x_t(1) \quad (4)$$

$$S_{t+\Delta t}(2) = x_t(2) \quad (5)$$

$$S_{t+\Delta t}(3) = S_t(3) + (x_t(3)\eta^c - \frac{x_t(4)}{\eta^d})\Delta t \quad (6)$$

$$S_{t+\Delta t}(k) = P_{t+\Delta t}^F(k-3) + W_{t+\Delta t}(k-3), k \in \{4, 5, 6, 7\} \quad (7)$$

where, $P_{t+\Delta t}^F = \{P_{WT,t+\Delta t}^F, P_{PV,t+\Delta t}^F, D_{t+\Delta t}^F, p_{t+\Delta t}^F\}$ represents the day-ahead forecast information.

B. Objective Function

Based on the system states S_t , decision variables x_t and the exogenous information $W_{t+\Delta t}$, the objective functions can be built. The overall objective across the time horizon of interest (i.e. 24 hour in this work) is to minimize the total operation cost of the microgrid. In time period t , the operation cost is denoted by C_t which is given by (8), including fuel cost $C_{f,t}$, the operation and maintenance (O&M) cost $C_{m,t}$, cost to purchase electricity from grid $C_{p,t}$, and the penalties on the curtailment of renewable energy and load shedding $C_{cur,t}$.

$$C_t(S_t, x_t) = C_{f,t}(S_t, x_t) + C_{m,t}(S_t, x_t) + C_{p,t}(S_t, x_t) + C_{cur,t}(S_t, x_t) \quad (8)$$

Assuming that the fuel cost and the O & M cost [33], [34] are proportional to the active power generation of the power sources, these costs can be calculated by (9) - (10).

$$C_{f,t}(S_t, x_t) = f_1^{GG}(P_{GG,t}) + f_1^{FC}(P_{FC,t}) = [k_{GG} \cdot P_{GG,t} + k_{FC} \cdot P_{FC,t}] \cdot \Delta t \quad (9)$$

$$C_{m,t}(S_t, x_t) = \sum_{g \in \mathcal{G}} f_2^g(P_{g,t}) = [l_{GG} \cdot P_{GG,t} + l_{FC} \cdot P_{FC,t} + l_{WT} \cdot P_{WT,t} + l_{PV} \cdot P_{PV,t} + l_{bat} \cdot (P_{bat,t}^c + P_{bat,t}^d)] \cdot \Delta t \quad (10)$$

The cost to purchase electricity from the connected distribution network is

$$C_{p,t}(S_t, x_t) = f_3^{grid}(P_{grid,t}) = -p_t \cdot P_{grid,t} \cdot \Delta t \quad (11)$$

when $P_{grid,t}$ is positive, it means that the microgrid sells surplus energy to the external grid. Otherwise, if the microgrid needs to purchase electricity, $P_{grid,t}$ is negative.

When the renewable energy is sufficient enough to not only meet the power consumption of the microgrid, but also reach the maximum energy sale limit to distribution network, the surplus renewable energy will be curtailed. Similarly, when there are power shortage, the load shedding will occur. The

penalties on wind/solar energy curtailment and load shedding are given by

$$\begin{aligned} C_{cur,t}(S_t, x_t) &= f_4^{WT} (P_{WT,t}) + f_4^{PV} (P_{PV,t}) + f_4^{load} (P_{i,t}^{cur}) \\ &= \left[c^{wt} \cdot (P_{WT,t}^a - P_{WT,t}) + c^{pv} \cdot (P_{PV,t}^a - P_{PV,t}) + \sum_{i \in \mathcal{L}} c^{load} \cdot P_{i,t}^{cur} \right] \cdot \Delta t \end{aligned} \quad (12)$$

To sum the operational cost in each time period, the cost of the microgrid over the optimization horizon can be expressed by

$$F = \min \mathbb{E} \left\{ \sum_{t=0}^T C_t(S_t, x_t) \right\} \quad (13)$$

From (13), the key to minimize the expected sum of operation cost over the optimization horizon is to find the optimal decision policy .

C. Constraints

The objective function is subjected to the following constraints:

$$\sum_{g \in \mathcal{G}} T_{i,g} P_{g,t} - (D_{i,t} - P_{i,t}^{cur}) = \sum_{j=1}^I G_{ij} V_{j,t} - \sum_{j=1}^I B'_{ij} \theta_{j,t}, \quad i \in \mathcal{I} \quad (14)$$

$$\sum_{g \in \mathcal{G}} T_{i,g} Q_{g,t} - Q_{i,t} = - \sum_{j=1}^I B_{ij} V_{j,t} - \sum_{j=1}^I G_{ij} \theta_{j,t}, \quad i \in \mathcal{I} \quad (15)$$

$$\begin{aligned} P_{GG}^{min} &\leq P_{GG,t} \leq P_{GG}^{max} \\ P_{FC}^{min} &\leq P_{FC,t} \leq P_{FC}^{max} \end{aligned} \quad (16)$$

$$\begin{aligned} P_{GG}^{down} \cdot \Delta t &\leq P_{GG,t} - P_{GG,t-\Delta t} \leq P_{GG}^{up} \cdot \Delta t \\ P_{FC}^{down} \cdot \Delta t &\leq P_{FC,t} - P_{FC,t-\Delta t} \leq P_{FC}^{up} \cdot \Delta t \end{aligned} \quad (17)$$

$$P_{grid}^{min} \leq P_{grid,t} \leq P_{grid}^{max} \quad (18)$$

$$0 \leq P_{WT,t} \leq P_{WT,t}^a \quad (19)$$

$$0 \leq P_{PV,t} \leq P_{PV,t}^a \quad (20)$$

$$\begin{aligned} 0 &\leq P_{bat,t}^c \leq U_{bat}^c \cdot P_{bat}^{c,max} \\ 0 &\leq P_{bat,t}^d \leq U_{bat}^d \cdot P_{bat}^{d,max} \end{aligned} \quad (21)$$

$$U_{bat,t}^c + U_{bat,t}^d \leq 1, \quad U_{bat,t}^c, U_{bat,t}^d \in \{0, 1\} \quad (22)$$

$$SOC_t = SOC_{t-\Delta t} + \left(\eta^c P_{bat,t}^c - \frac{P_{bat,t}^d}{\eta^d} \right) \Delta t \quad (23)$$

$$E_{bat}^{min} \leq SOC_t \leq E_{bat}^{max} \quad (24)$$

$$Q_g^{min} \leq Q_{g,t} \leq Q_g^{max}, \quad g \in \mathcal{G} \quad (25)$$

$$V_i^{min} \leq V_{i,t} \leq V_i^{max}, \quad i \in \mathcal{I} \quad (26)$$

$$P_{ij}^{min} \leq g_{ij}(V_{i,t} - V_{j,t}) - b_{ij}(\theta_{i,t} - \theta_{j,t}) \leq P_{ij}^{max}, \quad i, j \in \mathcal{I} \quad (27)$$

$$0 \leq P_{i,t}^{cur} \leq D_{i,t}, \quad i \in \mathcal{L} \quad (28)$$

where (14) and (15) are the decoupled linearized power flow (DLPF) constraints from [35]. Different from DC power flow

model, DLPF can consider both active and reactive power, as well as the voltage magnitude and phase angle. The literature has demonstrated the good approximation of the linearized power flow to the traditional AC power flow. The active power generated from GG and FC are limited by their upper and lower boundaries P_{GG}^{max} , P_{FC}^{max} , P_{GG}^{min} , P_{FC}^{min} , as indicated by (16). While the ramp rate of the units is limited by (17). The active power purchased from the external grid is limited by P_{grid}^{min} and P_{grid}^{max} , as defined by (18) and $P_{grid}^{min} = -P_{grid}^{max}$. The dispatched wind and solar power at time period t are limited by the available energy which are shown in (19) and (20). $P_{bat,t}^d$ and $P_{bat,t}^c$ are constrained by (21) using the charge/discharge states and the maximum charge/discharge power limits together. In (14), the active power injected to the node which connected to the battery can be calculated by $P_{bat,t} = P_{bat,t}^d - P_{bat,t}^c$. (22) ensures that the battery is not allowed to charge and discharge at the same time. The battery SOC is defined by (23) and the range of SOC is limited by (24); The efficiency of the battery is indicated by η^c and η^d . The constraints for reactive power and nodal voltage are shown in (25) and (26), respectively. (27) is the transmission capacity limits of all the power cables in the microgrid. The load curtailment is limited by (28). All the above constraints should be satisfied for time $t \in \mathcal{T}$.

D. Solution Techniques

For the stochastic optimization problems expressed in (13), subjecting to the constraints in the previous subsection, the optimal solution can be obtained by recursively solving Bellman's equation [15]:

$$\begin{aligned} V_t(S_t) &= \min_{x_t \in \mathcal{X}_t} \mathbb{E} \left\{ \sum_{t'=t}^T \gamma^{t'} C_{t'}(S_{t'}, x_{t'}) \right\} \\ &= \min_{x_t \in \mathcal{X}_t} \left(C_t(S_t, x_t) + \gamma \mathbb{E}[V_{t+\Delta t}(S_{t+\Delta t}) | S_t, x_t] \right) \end{aligned} \quad (29)$$

where $C_t(S_t, x_t)$ represents the operation cost of microgrid incurred at time period t ; $V_t(S_t)$ is the total operation costs of the microgrid, which is accumulated from time t to T . γ is the discount factor which is equal to 1 in this work. \mathcal{X}_t is the feasible region for x_t constrained by (14)-(28). $S_{t+\Delta t}$ can be calculated according to (4) - (7). The conditional expectation is taken over the random exogenous information $W_{t+\Delta t}$.

The re-formulated optimization problem (29) is a multi-time period problem which can be solved by DP. However, suffering from the curse of dimensionality, it is computationally intractable for the DP algorithm to enumerate the whole solution space. For example in this work, there are seven state variables and tens of decision variables in every time step. If every state variable is discretized into 10 different values, there could be a total of 10^7 candidate combinations which constitute the state space at time t . Thus it needs to loop over (29) 10^7 times to compute $V_t(S_t)$ for all possible S_t . And for each state S_t , it needs to compute the expectation in (29) firstly before computing $V_t(S_t)$. This expectation has to be computed for each possible decision x_t . Although the constraints can reduce the size of the feasible decision space, the computational burden is still large. To overcome the curse

of dimensionality, ADP algorithm is applied to solve economic dispatch for the microgrid. An ADP based method is proposed in the following section.

IV. ADP BASED ECONOMIC DISPATCH ALGORITHM FOR MICROGRID

ADP offers a powerful set of mathematical tools to handle the curse of dimensionality. Compared with DP, it makes a tradeoff between the optimality and the computational time. So the solution obtained by ADP is near-optimal. But less computational time is needed with decomposition from time horizon perspective, especially for large-scale multi-time period optimization [27]. For the ADP algorithm in this paper, PLFs are adopted to approximate value functions. In this section, PLF based ADP (Section IV-A) and the training process (Section IV-B) are introduced. And a modified slope updating method (Section IV-C) is proposed for the approximated piecewise linear function to speed up the convergence rate. Then, ADPED is developed in Section IV-D. Finally, the method to evaluate the performance of the algorithm is introduced in Section IV-E.

A. Piecewise Linear Function Approximation Based ADP

As computing the expectation within the min operator in (29) is difficult, the value function around the post-decision state S_t^x is introduced to avoid the step of calculating the expectation [15]. Post-decision state is the state of the microgrid soon after making the decisions but before any random information is received. The relationship between S_t , x_t , W_t , and S_t^x is shown in Fig. 2. Using a post-decision function to replace the expectation in (29), the *Bellman's* equation can be rewritten as:

$$V_t(S_t) = \min_{x_t \in \mathcal{X}_t} (C_t(S_t, x_t) + \gamma V_t^x(S_t^x)) \quad (30)$$

The relationship between the post-decision function $V_t^x(S_t^x)$ and the expectation is given by (31).

$$V_t^x(S_t^x) = \mathbb{E}[V_{t+\Delta t}(S_{t+\Delta t}) | S_t, x_t] \quad (31)$$

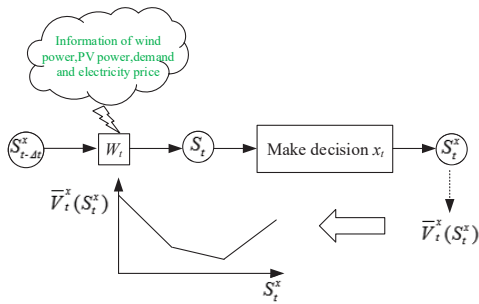

Fig. 2. The relationship between S_t , x_t , W_t , and S_t^x .

Solving (30) requires to use the value function $V_t^x(S_t^x)$ for every state. However, this function is unknown and it is computationally intractable in this paper as the state variable is multidimensional and continuous. Thus, it is very important

for the VFA based ADP to properly approximate the value function so that the optimal decision for each time step could lead to the optimality over the whole time horizon [15], [25], [36], [37]. According to [25], using a concave/convex piecewise linear function to estimate the value of resources in storage can avoid any need for explicit exploration policies and can improve the quality of the solution. In this paper, a convex and piecewise linear function around the SOC of the battery, denoted by $\bar{V}_t^x(S_t^x)$, is used to approximate $V_t^x(S_t^x)$, as indicated by (32).

$$\bar{V}_t^x(S_t^x) = \bar{V}_t^x(SOC_t^x) = \sum_{a=1}^{N_t} d_{t,a} r_{t,a}, \quad a \in \{1, 2, \dots, N_t\} \quad (32)$$

The slopes of the function $\bar{V}_t^x(S_t^x)$ should be monotonically increasing, i.e. $d_{t,a} \leq d_{t,a+1}$. The function $\bar{V}_t^x(\cdot)$ is divided into N_t segments on average, thus

$$0 \leq r_{t,a} \leq (E_{bat}^{max} - E_{bat}^{min})/N_t \quad (33)$$

Assume the SOC of the battery at time t before and after the decision has been made are represented by SOC_t and SOC_t^x respectively, it can be found that

$$SOC_t^x = \sum_{a=1}^{N_t} r_{t,a} \quad (34)$$

$$SOC_t = SOC_t^x + \left(\frac{P_{bat,t}^d}{\eta^d} - \eta^c P_{bat,t}^c \right) \Delta t \quad (35)$$

Substitute (32) in the *Bellman's* function (30), the optimal decision at time t is determined by solving (36):

$$x_t = \arg \min_{x_t \in \mathcal{X}_t, r_{t,a} \in \mathfrak{R}_t} \left(C_t(S_t, x_t) + \gamma \sum_{a=1}^{N_t} d_{t,a} r_{t,a} \right) \quad (36)$$

where $\arg \min(\cdot)$ means that the optimal decision x_t is chosen to minimize the objective function. \mathfrak{R}_t is the feasible set for $r_{t,a}$ determined by (33) - (35).

B. The Training Process of the PLF Approximation Based ADP

ADP algorithm steps forward in time to solve (36) iteratively subject to the constraints (14)-(28) and (33)-(35). For example, assume the n th iteration is going to be started. After the $(n-1)$ th iteration, the PLFs $\bar{V}_t^{x,n-1}(S_t^x)$ for each time period t can be obtained. So these approximated functions can be used to make decisions in the n th iteration. That is to say, for time step t , the optimal decision in the n th iteration x_t^n is determined by solving (36) using the approximated PLFs from the previous iteration, given by

$$x_t^n = \arg \min_{x_t^n \in \mathcal{X}_t^n, r_{t,a}^n \in \mathfrak{R}_t^n} \left(C_t(S_t^n, x_t^n) + \gamma \sum_{a=1}^{N_t} d_{t,a}^{n-1} r_{t,a}^n \right) \quad (37)$$

where the superscript n denotes the decision variable or state variable in the n th iteration.

When the number of segments for PLF is fixed to a constant value, the quality of the solution obtained by (37) is determined by the slopes of the approximated function. In

order to obtain a good decision policy, these slopes must be updated iteratively. To update the slopes of piecewise function, in the n th iteration, a sample observation of the marginal value of energy in the storage device $\hat{d}_{t-\Delta t,a}^n(SOC_{t-\Delta t}^{x,n})$ needs to be calculated. Several methods can be employed, for example, according to [25]:

$$\hat{d}_{t-\Delta t,a}^n(SOC_{t-\Delta t}^{x,n}) = \hat{d}_{t,a'}^n(SOC_t^n) \quad (38)$$

$$\hat{d}_{t,a'}^n(SOC_t^n) = \frac{\partial \min_{x_t^n \in \mathcal{X}_t} (C(S_t^n, x_t^n) + \bar{V}_t^{x,n-1}(S_t^{x,n}))}{\partial SOC_t^n} \quad (39)$$

Equations (38) and (39) indicate the observation of the marginal value at S_t^n can be used to update the slope of the approximated post-decision function. Then the slopes of the PLF $\bar{V}_{t-\Delta t}^{x,n}(SOC_{t-\Delta t}^{x,n})$ can be updated by:

$$d_{t-\Delta t,a}^n(SOC_{t-\Delta t}^{x,n}) = \alpha^{n-1} \hat{d}_{t,a'}^n(SOC_t^n) + (1 - \alpha^{n-1}) d_{t-\Delta t,a}^{n-1}(SOC_{t-\Delta t}^{x,n}) \quad (40)$$

where α^{n-1} is the step size to smooth the estimated slope. $d_{t-\Delta t,a}^{n-1}(SOC_{t-\Delta t}^{x,n})$ is the slope of the PLF corresponding to the a th segment in the $(n-1)$ th iteration. $SOC_{t-\Delta t}^{x,n}$ is located in the a th segment of the PLF $\bar{V}_{t-\Delta t}^{x,n}(SOC_{t-\Delta t}^{x,n})$.

Note that (40) just updates the slope for the a th segment of the function $\bar{V}_{t-\Delta t}^{x,n}(SOC_{t-\Delta t}^{x,n})$. The new slope $d_{t-\Delta t,a}^n$ may lead the PLF $\bar{V}_{t-\Delta t}^{x,n}(\cdot)$ no longer satisfies the monotonicity property. To ensure the monotonicity property of the updated approximation, the leveling algorithm from [15] is applied:

$$d_{t-\Delta t,u}^n = \begin{cases} \max \left\{ d_{t-\Delta t,u}^{n-1}, \alpha^{n-1} \hat{d}_{t,a'}^n + (1 - \alpha^{n-1}) d_{t-\Delta t,a}^{n-1} \right\}, u > a \\ \alpha^{n-1} \hat{d}_{t,a'}^n + (1 - \alpha^{n-1}) d_{t-\Delta t,a}^{n-1}, u = a \\ \min \left\{ d_{t-\Delta t,u}^{n-1}, \alpha^{n-1} \hat{d}_{t,a'}^n + (1 - \alpha^{n-1}) d_{t-\Delta t,a}^{n-1} \right\}, u < a \end{cases} \quad (41)$$

Equation (41) ensures the slopes of the function are monotonically increasing. However, the disadvantage of the above method to obtain $\hat{d}_{t,a'}^n(SOC_t^n)$ is that the convergence rate of the algorithm is slow. This is because, for the above optimization problem, it will need at least T iterations before the updated information about the last time period begins to back propagate to the approximated PLF for the first time period. Besides, the step size discounted the back propagate effect which further reduced the convergence rate of the algorithm.

C. Proposed Value Function Update Strategy

To overcome the above disadvantages, inspired by the work in [38], a new method to calculate the sample observation of the slope $\hat{d}_{t,a'}^n(SOC_t^n)$ is proposed in this work. According to the definition, slope $d_{t,a}^n$ is the derivation of the value function $\bar{V}_t^{x,n}(S_t^{x,n})$ corresponding to segment a . This means the slope indicates the marginal value of energy stored in the battery. So the sample observation of slope can be calculated by the following method.

In the n th iteration, $\forall t \in \mathcal{T}$, the cost to provide per kWh electricity to the microgrid at time t is represented by c_t^n (\$/kWh). Set the most costly time period after time $t - \Delta t$ for the microgrid operation is τ , i.e. $c_\tau^n = \max\{c_t^n, c_{t+\Delta t}^n, \dots, c_T^n\}$. Suppose there is an increment in SOC of the battery at time t

which means the stored energy in battery at time t is $SOC_t^n + 1$. To obtain the maximum revenue for the whole system, namely, the system operation cost is minimum, the incremental per kWh energy in the battery should be discharged at time τ . Considering operation efficiency of the battery, the marginal value of energy stored in the battery at time t will be $c_\tau^n \cdot \eta^d$. Thus, the sample observation of the slope at time t in iteration n can be calculated by:

$$\hat{d}_{t,a'}^n(SOC_t^n) = \max\{c_t^n, c_{t+\Delta t}^n, \dots, c_T^n\} \cdot \eta^d \quad (42)$$

The cost to provide 1kWh electricity to the microgrid at time t' ($c_{t'}^n$) can be calculated by (43):

$$c_{t'}^n = \partial C_t'(S_{t'}^n, x_{t'}^n) / \partial D_{t'}^n, \quad t' \in \{t, t + \Delta t, \dots, T\} \quad (43)$$

where a' is the segment in which SOC_t^n is located, so $(a' - 1) \times (E_{bat}^{max} - E_{bat}^{min}) / N_t \leq SOC_t^n \leq a' \times (E_{bat}^{max} - E_{bat}^{min}) / N_t$. $x_{t'}^n$ can be obtained by (37).

Adopting the proposed value function update strategy, the proposed ADPED algorithm is outlined in Algorithm 1.

Algorithm 1 The ADPED algorithm for day-ahead optimization.

- 1: Initialize the slope of all PLFs, segments N_t , and maximum iteration number N . Set iteration number $n = 1$ and $\Delta t = 1$. $t \in \{1, 2, \dots, T\}$
 - 2: Generate a scenario by Monte Carlo method according to day-ahead forecast.
 - 3: **for** $t = 1, 2, \dots, T$ **do**
 - 1) Obtain the decision x_t^n by solving (37) subject to the constraints (14) - (28) and (33) - (35);
 - 2) Calculate the cost to provide 1kWh electricity for the microgrid at time t according to (43);
 - 3) Store the cost to provide 1kWh electricity for the microgrid at time t ;
 - 4) If $t < T$, compute the next state $S_{t+\Delta t}^n$ by (4) - (7);
 - 4: **end for**
 - 5: **for** $t = 1, 2, \dots, T$ **do**
 - 1) Compute the sample observation value according to (42);
 - 2) Update the slopes of the PLF according to (40) and (41);
 - 6: **end for**
 - 7: Let $n = n + 1$. If $n \leq N$, go to Step 2;
 - 8: Return the PLFs in the last iteration.
 - 9: Calculate the expected operation cost of the microgrid and calculate the day-ahead plan according to the forecast information.
-

D. ADPED Based Energy Management System

The schematic diagram of the ADPED based EMS is shown in Fig. 3. The day ahead scheduling is planned using Algorithm 1. After the slopes of the PLFs are fully updated in Algorithm 1, the ADPED algorithm has been embedded empirical knowledge and able to make near-optimal decisions. Thus, for the intra-day operation of the microgrid, use the pre-trained PLFs to optimize the system and the EMS can obtain

a near-optimal solution even if the updated intra-day forecast information is unavailable. The intra-day optimization process is shown in Algorithm 2.

Algorithm 2 The ADPED algorithm for intra-day online optimization.

- 1: For every time period t , set the initial value function be the corresponding well trained piecewise linear function obtained by Algorithm 1.
- 2: **for** $t = 1, 2, \dots, T$ **do**
 - 1) Input the real time information about renewable power generation, power demand, and electricity price at time t ;
 - 2) Obtain the optimal decision x_t by solving (36) subject to the constraints (14) - (28) and (33) - (35);
 - 3) If $t < T$, compute the next state $S_{t+\Delta t}$ by (4) - (7);
- 3: **end for**

E. Method to Evaluate the Performance of ADPED

Considering the forecast error of stochastic variables, the relationship between real value I_t^r and forecast information I_t^f at time t can be expressed as:

$$I_t^r = I_t^f + \varepsilon_t \quad (44)$$

In Algorithm 1, different scenarios are generated in step 2 using MC for every iteration. So, for convenience, n is used to indicate both iteration index and scenario index. For deterministic cases, Step 2 in Algorithm 1 can be skipped since single scenario is taken into account.

To evaluate the performance of the ADPED algorithm in day-ahead optimization, M_1 test scenarios are generated. Using the PLFs obtained in the n th iteration, an estimate of the mean operation cost of the microgrid using ADPED, i.e. \bar{F}_{ADPED}^n , can be calculated by:

$$\bar{F}_{ADPED}^n = \frac{1}{M_1} \sum_{m=1}^{M_1} F_{ADPED}^{m,n} \quad m \in \{1, 2, \dots, M_1\} \quad (45)$$

$F_{ADPED}^{m,n}$ is the value of the near-optimal objective function of test scenario m calculated by ADPED using the PLFs obtained in the n th iteration.

To evaluate the performance of the ADPED algorithm in intra-day optimization, M_2 test scenarios are generated and MILP is adopted to calculate the corresponding optimal solution. It is worth to note that MILP method needs to know the exact forecast information over the optimization horizon. Then, the optimal solution can be calculated as a single gain optimization problem over the whole time period. But this method is hard to applied in the online optimization as the uncertainties from wind and solar power, etc. To test the performance of ADPED algorithm, it is assumed that MILP can "see" all the future information. For a particular scenario m , the intra-day optimization error of the ADPED is given by:

$$E_{ADPED}^m = \frac{F_{ADPED}^{m,N} - F_B^m}{F_B^m} \quad m \in \{1, 2, \dots, M_2\} \quad (46)$$

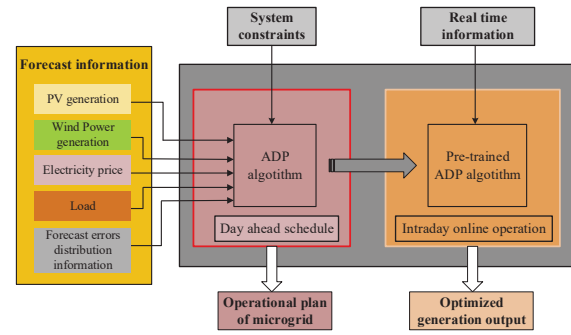

Fig. 3. ADPED based Energy management system for the microgrid.

V. NUMERICAL ANALYSIS

In this section, the performance of the ADPED algorithm is examined by numerical experiments on a microgrid system. Firstly, a deterministic case is designed to test the quality of the solution obtained by the ADPED algorithm. Then stochastic cases are simulated to show that the algorithm can deal with the uncertainties. All the simulations assume that the microgrid operated in a grid-connected mode. But simply limit the active/reactive power exchange between upper-level grid and microgrid to be zero turns the microgrid to be islanded and this does not change the proposed algorithmic flow.

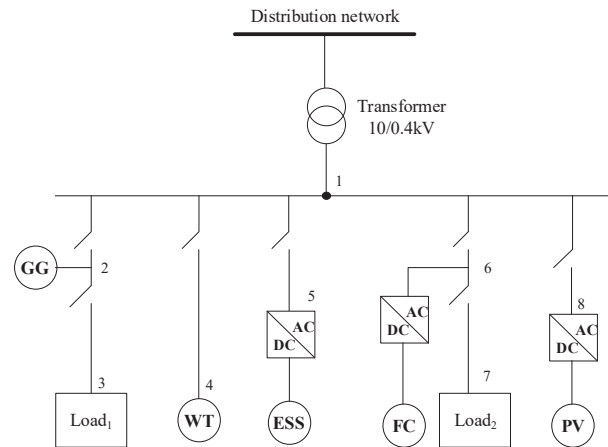

Fig. 4. Structure of the microgrid.

The structure of the microgrid is shown in Fig. 4. The model of the facilities and their associated constraints are available in Section III. The capacity of the installed wind generators and PV are 160kW and 60kW, respectively. The power exchange limit between the microgrid and the distribution network is set as 60kW. The parameters of the microgrid are shown in Table I to Table III. The initial energy stored in the battery is set to 75 kWh and the cycled efficiency is 0.90. The day ahead predicted wind power generation, solar power generation, and load data are shown in Fig. 5. The day-ahead prediction for market electricity price is shown in Fig. 6. In the following simulations, the wind power and solar power curtailment cost are all set to be 0.2 \$/kWh. The load shedding punishment is set to be 0.15 \$/kWh.

TABLE I
PARAMETERS OF THE GENERATORS

Generator type	P_{max} (kW)	P_{min} (kW)	Ramp Rate (kW/h)	k (\$/kWh)	l (\$/kWh)
GG	80	10	80	0.056	0.0042
FC	70	8	70	0.065	0.0048
WT	160	0	-	0	0.0019
PV	60	0	-	0	0.0023

TABLE II
PARAMETERS OF THE BATTERY

Parameters	P_{max} (kW)	P_{min} (kW)	E_{max} (kW)	E_{min} (kW)	l (\$/kWh)
Battery	30	-30	150	15	0.0040

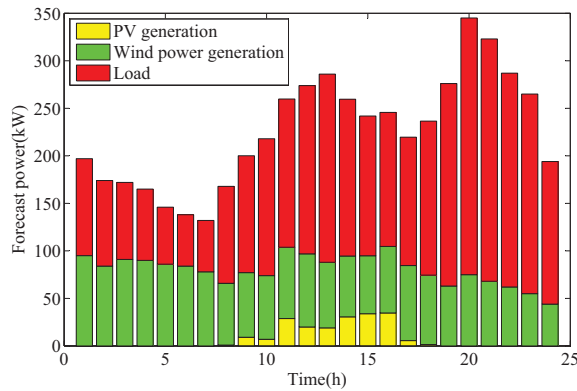

Fig. 5. The predicted generation of PV,WT, and load.

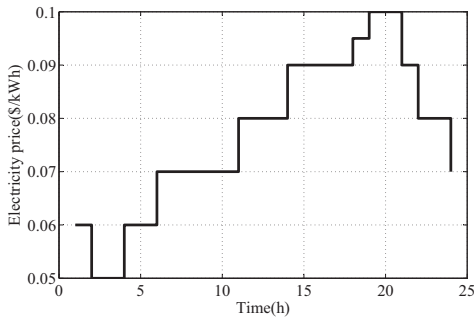

Fig. 6. The predicted electricity price.

The value functions are approximated by a series of PLFs with initial slopes $d_{t,a}^0 = 0$ for $t \in \mathcal{T}$. The step size α^n is set to be $\frac{b}{b+n}$, where b is a tunable parameter. For day ahead economic dispatch, T equals to 24 in this paper. All numerical simulations are coded in MATLAB 2012, and the simulations are conducted on an Intel Core i3 3.40 GHz Windows based

TABLE III
PARAMETERS OF POWER CABLES OF THE MICROGRID

Line	From node	To node	R (Ω)	X (Ω)
L1	1	2	0.106	0.264
L2	1	4	0.208	0.518
L3	1	5	0.097	0.242
L4	1	6	0.106	0.264
L5	1	8	0.173	0.432
L6	2	3	0.057	0.143
L7	6	7	0.057	0.143

PC with 4GB RAM.

A. Deterministic Case

The deterministic case assumes accurate forecast for the wind and solar power, as well as the demand and electricity price for day-ahead scheduling. Thus, Step 2 in Algorithm 1 can be skipped for the deterministic case.

The near-optimal solution obtained from the ADPED algorithm is shown in Fig. 7 to Fig. 10. The convergence process of the ADPED algorithm and the one proposed in [25] are compared in Fig. 7. The same initial slope of PLFs and step size are set for the above two kinds of ADP algorithms. It can be seen from Fig. 7 that the ADPED algorithm converges in less than 10 iterations, while, the unimproved ADP from [25] takes more than 20 iterations.

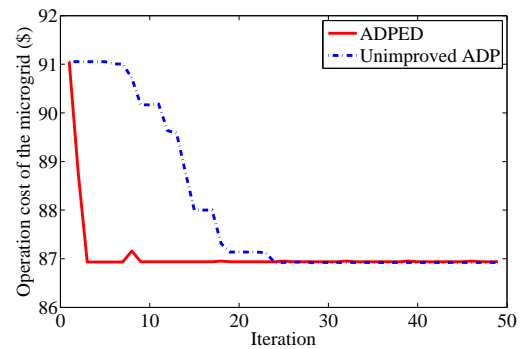

Fig. 7. The convergence curve of ADP algorithm for operation costs of the microgrid.

The generation output of the GG, FC, battery and the power exchange between the microgrid and the upper-level grid are shown in Fig. 8. Because GG is cheaper than the FC, the electricity demand is firstly provided by GG. It can be observed that the microgrid purchases electricity from the upper-level grid when $t = 2h$ as the electricity price in the market is low, and in the time period $t = 20 - 22h$ because the power generation within the microgrid is insufficient. There are no wind and solar power curtailment, and the load shedding does not occur.

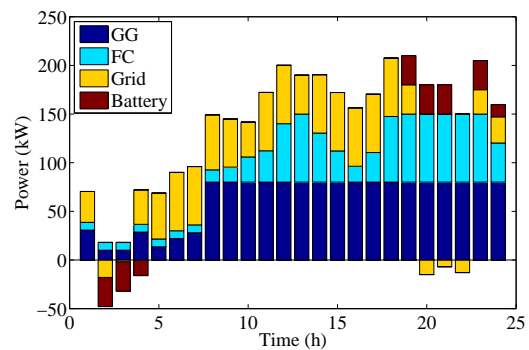

Fig. 8. The power generation of gas generators, fuel cells and power grid.

The charge/discharge power of the battery is shown in Fig. 8 associated with its SOC shown in Fig. 9. It shows that the

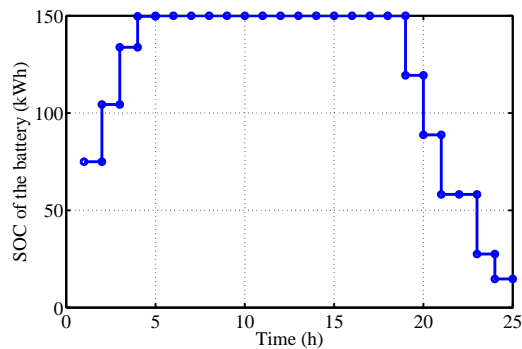

Fig. 9. The charging/discharging process of the battery.

TABLE IV
EXPERIMENT RESULTS OF THE DETERMINISTIC CASE

Methods	Operation cost (\$)	Average computing time (second)
Myopic	91.06	0.320
MPC	88.39	0.123
ADPED	86.94	5.40
MILP	86.79	0.0852

battery stores energy between time period $t = 2 - 4$ h. In time period $t = 2 - 4$ h the wind power is sufficient while demand is relatively low. In time period $t = 5 - 18$ h the SOC of the battery reaches 150 kWh, which is sufficient to balance the load during the peak hours. After the peak hours in the evening between $t = 19 - 20$ h, the battery discharges part of stored energy to get ready to store wind energy in the midnight.

The Point of Common Coupling (PCC) is a very important node in the microgrid. The voltage of the PCC and reactive power injected from the upper-level grid are shown in Fig. 10. Limited by the constraint (23), it can be found that the voltage of the PCC is always in the normal range.

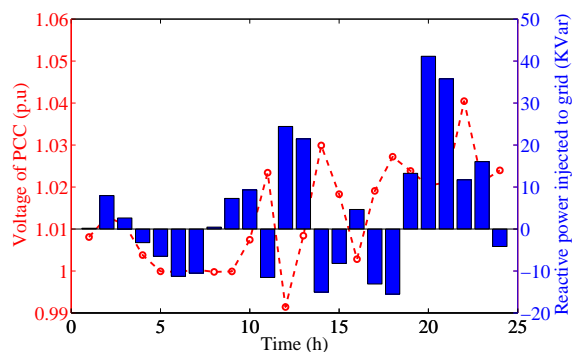

Fig. 10. The voltage and reactive power of the PCC

To demonstrate the effectiveness of the proposed algorithm, myopic optimization method [15] and model predictive control (MPC) are used as the comparative methods. The simulation results are shown in Table IV. The solution obtained by the proposed algorithm reaches better optimality than myopic method and MPC algorithm, with longer yet acceptable computational time. This is because ADPED aims to find a global, near-optimal solution over the entire time horizon by itera-

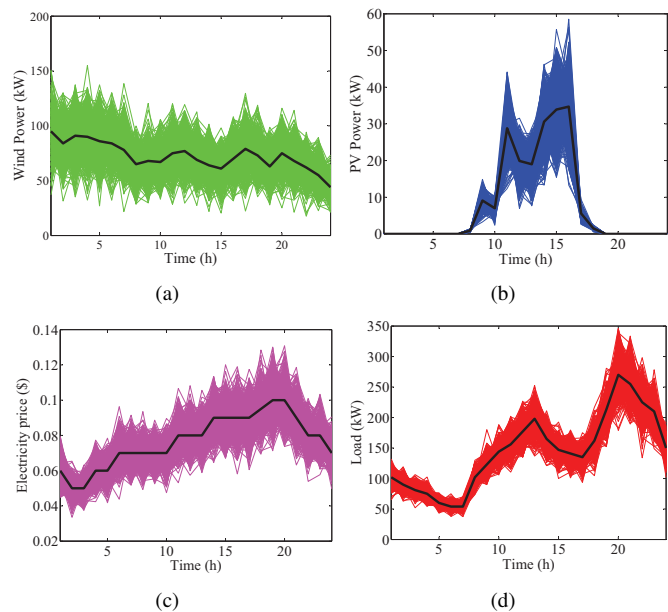

Fig. 11. (a) The sampled wind power generation data. (b) The sampled solar power generation data. (c) The sampled electricity price data. (d) The sampled demand data.

tively approximating future operating cost. While MPC and myopic optimization utilize predicted information or current information to determine the optimal solution for the near-future time horizon or the current time.

To test the quality of near-optimal solution obtained by ADPED, classical mixed integer linear programming (MILP) algorithm is also used as the baseline of optimality. The optimal solution is shown in Table IV. The gap between ADPED and optimality is 0.17%. It can be found that the ADPED can solve the problem within a small fraction of a percentage error. Though little computational time and optimality are sacrificed, ADPED superiors in dealing with uncertainty which will be demonstrated by the following simulations.

B. Stochastic Case: Day-ahead Optimization

The day ahead forecast information include renewable generation, electricity demand, and electricity price information. Due to the inaccurate forecast, the operator needs to adjust the generation plan in the intra-day operation process. The proposed ADPED algorithm in this paper can be used to calculate the expected operating costs according to the day ahead forecast information and the prediction error distribution.

Assume the renewable power generation forecast error ϵ_t^w and ϵ_t^{pv} , load forecast error ϵ_t^{load} and electricity price forecast error ϵ_t^p obey Gaussian distribution [39]–[42]. Set $\epsilon_t^w \sim N(0, 0.2^2)$, $\epsilon_t^{pv} \sim N(0, 0.2^2)$, $\epsilon_t^{load} \sim N(0, 0.1^2)$, $\epsilon_t^p \sim N(0, 0.1^2)$. Simulation is carried out on the same system as the previous subsection. MC sampling is used to produce 2500 set of training scenarios and 200 set of test scenarios, i.e. $M_1 = 200$. The forecast and the generated training scenarios are shown in Fig. 11.

Using Algorithm 1, the ADPED is trained by 2500 scenarios, i.e., $N = 2500$. According to (42), \bar{F}_{ADPED}^n can be calculated and the training processes for ADP algorithms are

shown in Fig. 12. The ADPED algorithm performs not very well in the first several iterations as the training is not enough. With the training proceeding, the objective function of the ADPED algorithm decreased rapidly and converged in about 200 iterations. Similarly, the near-optimal solution also can be obtained by the unimproved ADP. It can be observed that the ADPED algorithm has a faster convergence rate than the unimproved ADP and the two algorithms converged to almost the same value. The training process is not time-consuming. The total computational time for the 2500 scenarios is 201.4s. Thus, the average computational time for one scenario is 0.081s.

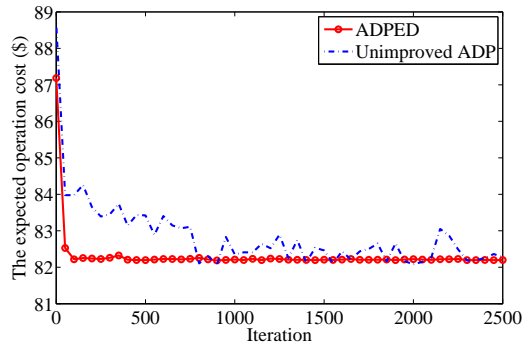

Fig. 12. The convergence process of the ADPED and unimproved ADP algorithm

C. Stochastic Case: Intra-day Online Optimization

Using Algorithm 1, the expectation of the operation cost for the microgrid can be computed in day-ahead scheduling. Meanwhile, the set of PLFs which have been well trained in Algorithm 1 contains the information about the operation cost in the future for the microgrid. This means, these PLFs can evaluate the impact of the current decision on the future according to the current state. This is particularly useful when the intra-day forecast information, for example, the forecast for the next several hours is unavailable. As in this circumstance, the system operator may need to make the decision blindly just according to the presently available information, similar to the myopic strategy. Thus, in the intra-day operation process, these PLFs can be used to make a globally optimal decision.

In every time step, the ADPED algorithm solves the *Bellman's* equation to obtain the optimal decision for the current time. So for the intra-day optimization of the microgrid, the system operator can re-dispatch the microgrid online just according to these PLFs and the updated information about the renewable generation power, load, and electricity price. To illustrate the effectiveness of the ADPED algorithm in intra-day optimization, MC method is adopted to generate 500 new sets of test data, i.e. $M_2 = 500$. The forecast error distribution of the test data is the same with the training data. Then Algorithm 2 is used to optimize the operation cost under these scenarios. It is assumed that the updated forecast information for the following few hours is unavailable. So the intra-day optimization problem just can be solved by the myopic method.

To test the performance of ADPED algorithm, it is assumed that the system operator can "see" the future information of the microgrid. Thus the optimal solution of all the test scenarios can be calculated by MILP. It is worth to note that MILP method needs the exact information over the optimization horizon. So MILP is hard to applied in online optimization process. Using the solution obtained from MILP as the baseline, we can evaluate the online optimization performance of the ADPED using (46). Similarly, the performance of the myopic method can also be evaluated. The optimization error distribution of the ADPED and the myopic method are shown in Fig. 13.

It can be found that the optimization error of this two approaches obeys normal distribution, because the forecast error of the stochastic variables obey the normal distribution. The mean value of the optimization errors of the ADPED algorithm and myopic method are 0.56% and 6.80%, respectively. The standard deviation of the optimization errors of the ADPED algorithm and myopic method are 0.0038 and 0.0117, respectively. The ADPED algorithm obtains more optimal solution than myopic method. It can be found that even if the forecast error of the renewable power generation and electricity price reaches 20% and 10%, respectively, the ADPED algorithm can reach good performance in intra-day online optimization. Thus the ADPED algorithm can mitigate the negative impact from the uncertainties in the microgrid.

For the 500 test scenarios, the total computational time is 27.72s. So the computational time for one test scenario is 0.055s. For every scenario, there are 24 time steps which mean the equation (31) needs to be solved 24 times. Thus, the computational time to obtain the optimal decision in every time step is negligible. So the proposed algorithm is suitable for online use.

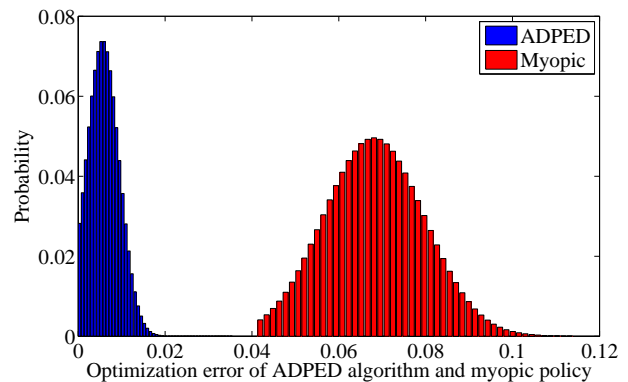

Fig. 13. The probability distribution of the optimization errors of the ADPED and myopic algorithm in all scenarios

VI. CONCLUSION

This paper proposes an ADPED algorithm for the stochastic optimization of the microgrid. A modified value function update strategy is included in the proposed method. To demonstrate the performance of the proposed algorithm, a deterministic case is designed to compare the ADPED algorithm with the myopic method and MPC algorithm. Simulation results show

that the ADPED algorithm can reach better solution than myopic method and MPC algorithm. A series of stochastic cases are designed to test the performance and demonstrate that the proposed ADPED can deal with the stochastic optimization problem. For all the simulations, the ADPED algorithm has a faster convergence rate than the unimproved ADP.

With the empirical knowledge embedded, the well trained ADPED algorithm can be used in intra-day optimization of the microgrid. Especially, when the intra-day forecast information is inaccurate or even missing, the algorithm is still able to provide a high-quality decision. This will especially useful when the intra-day forecast information is unavailable such as forecast module is in fault.

Future work in this area will include the coordinate optimization of the multi-microgrid system. On the other hand, a detailed battery model will be considered.

REFERENCES

- [1] B. Obama, "The irreversible momentum of clean energy," *Science.*, pp. 1-4, Jan. 2017.
- [2] J. Fang, Q. Zeng, X. Ai, Z. Chen and J. Wen, "Dynamic Optimal Energy Flow in the Integrated Natural Gas and Electrical Power Systems," *IEEE Transactions on Sustainable Energy*, vol. PP, no. 99, pp. 1-10, 2017, in press.
- [3] X. Liu, M. Shahidehpour, Z. Li, X. Liu, Y. Cao and Z. Bie, "Microgrids for Enhancing the Power Grid Resilience in Extreme Conditions," *IEEE Transactions on Smart Grid*, vol. 8, no. 2, pp. 589-597, Mar. 2017.
- [4] Z. Wang, and J. Wang, "Self-Healing Resilient Distribution Systems Based on Sectionalization Into Microgrids," *IEEE Transactions on Power System*, vol. 30, no. 6, pp. 3139-3149, Nov. 2015.
- [5] H. Kanchev, F. Colas, V. Lazarow, and B. Francois, "Emission Reduction and Economical Optimization of an Urban Microgrid Operation Including Dispatched PV-Based Active Generators," *IEEE Transactions on Sustainable Energy*, vol. 5, no. 4, pp. 1397-1405, Oct. 2014.
- [6] P. Shamsi, H. Xie, A. Longe, and J. Y. Joo, "Economic Dispatch for an Agent-Based Community Microgrid," *IEEE Transactions on Smart Grid*, vol. 7, no. 5, pp. 2317-2324, Sep. 2016.
- [7] T. A. Nguyen, and M. L. Crow, "Optimization in Energy and Power Management for Renewable-Diesel Microgrids Using Dynamic Programming Algorithm," *Proceedings of the 2012 IEEE International Conference on Cyber Technology in Automation, Control and Intelligent Systems*, 2012.
- [8] L. X. Ping, D. Ming, H. Pingping, and P. Yali, "Dynamic Economic Dispatch for Microgrids Including Battery Energy Storage," in *Proc. 2nd IEEE Int Power Electronics for Distributed Generation Systems (PEDG) symp.*, 2010.
- [9] A. Saez-de-Ibarra, A. Milo, H. Gaztanaga, V. Debusschere, and S. Bacha, "Co-Optimization of Storage System Sizing and Control Strategy for Intelligent Photovoltaic Power Plants Market Integration," *IEEE Transactions on Sustainable Energy*, vol. 7, no. 4, pp. 1749-1761, Oct. 2016.
- [10] P. Li, D. Xu, Z. Zhou, W. J. Lee, and B. Zhao, "Stochastic optimal operation of microgrid based on chaotic binary particle swarm optimization," *IEEE Transactions on Smart Grid*, vol. 7, no. 1, pp. 66-73, Jan. 2016.
- [11] G. Liu, Y. Xu, and K. Tomsovic, "Bidding Strategy for Microgrid in Day-Ahead Market Based on Hybrid Stochastic/Robust Optimization," *IEEE Transactions on Smart Grid*, vol. 7, no. 1, pp. 227-237, Jan. 2016.
- [12] M. Gulin, J. Matusko, and M. Vasak, "Stochastic Model Predictive Control for Optimal Economic Operation of a Residential DC Microgrid," in *Proceedings of the 2015 IEEE International Conference on Industrial Technology, ICIT 2015Seville, Spain.*, 2015.
- [13] A. Saez-de-Ibarra, V. I. Herrera, A. Milo, H. Gaztanaga, I. Etxeberria-Otadui, S. Bacha, and A. Padros, "Management Strategy for Market Participation of Photovoltaic Power Plants Including Storage Systems," *IEEE Transactions on Industry Applications*, vol. 52, no. 5, pp. 4292-4303, Sep. 2016.
- [14] W. B. Powell, "Approximate Dynamic Programming I : Modeling," *Wiley Encyclopedia of Operations Research and Management Science*, pp. 1-11, 2010.
- [15] W. Powell, *Approximate Dynamic Programming: Solving the Curses of Dimensionality*. Hoboken, NJ, USA: Wiley, 2007.
- [16] J. Liu, J. Y. Wen, W. Yao, and Y. Long, "Solution to short-term frequency response of wind farms by using energy storage systems," *IET Renewable Power Generation*, vol. 10, issue. 5, pp. 669-678, 2016.
- [17] B. Yang, L. Jiang, L. Wang, W. Yao, and Q. H. Wu, "Nonlinear maximum power point tracking control and modal analysis of DFIG based wind turbine," *International Journal of Electrical Power & Energy Systems*, vol. 74, pp. 429-436, 2016.
- [18] Y. Shen, W. Yao, J. Y. Wen, and H. B. He, "Adaptive wide-area power oscillation damper design for photovoltaic plant considering delay compensation," *IET Generation, Transmission & Distribution*, vol. 11, issue. 18, pp. 4511-4519, 2017.
- [19] D. R. Jiang, and W. B. Powell, "Optimal Hour-Ahead Bidding in the Real-Time Electricity Market with Battery Storage using Approximate Dynamic Programming," *INFORMS Journal on Computing*, vol. 27, issue. 3, pp. 525-543, 2015.
- [20] M. Boaro, D. Fuselli, F. D. Angelis, D. R. Liu, and F. Piazza, "A self-learning scheme for residential energy system control and management," *Neural Computing & Applications.*, vol. 22, issue. 2, pp. 259-269, Feb. 2013.
- [21] H. Ting, and D. R. Liu, "Adaptive Dynamic Programming Algorithm for Renewable Energy Scheduling and Battery Management," *Cognitive Computation.*, vol. 5, issue. 2, pp. 264-277, Jun. 2013.
- [22] Q. L. Wei, D. R. Liu, and G. Shi, "A Novel Dual Iterative Q-Learning Method for Optimal Battery Management in Smart Residential Environments," *IEEE Transactions on Industrial Electronics*, vol. 62, no. 4, pp. 2509-2518, Apr. 2015.
- [23] Q. L. Wei, D. R. Liu, G. Shi, and Y. Liu, "Multibattery Optimal Coordination Control for Home Energy Management Systems via Distributed Iterative Adaptive Dynamic Programming," *IEEE Transactions on Industrial Electronics*, vol. 62, no. 7, pp. 4203-4214, Jul. 2015.
- [24] Z. Ni, H. He, J. Y. Wen, and X. Xu, "Goal Representation Heuristic Dynamic Programming on Maze Navigation," *IEEE Transactions on Neural Networks and Learning Systems*, vol. 24, no. 12, pp. 2038-2050, Dec. 2013.
- [25] J. Nascimento, and W. B. Powell, "An Optimal Approximate Dynamic Programming Algorithm for Concave, Scalar Storage Problems With Vector-Valued Controls," *IEEE Transactions on Automatic Control*, vol. 58, no. 12, pp. 2995-3010, Dec. 2013.
- [26] D. R. Jiang, T. V. Pham, W. B. Powell, D. F. Salas, and W. R. Scott, "A Comparison of Approximate Dynamic Programming Techniques on Benchmark Energy Storage Problems: Does Anything Work?," in *Adaptive Dynamic Programming and Reinforcement Learning (AD-PRL), 2014 IEEE Symposium on.*, 2014.
- [27] W. B. Powell, and H. P. Simao, "SMART: A Stochastic Multiscale Model for the Analysis of Energy Resources, Technology, and Policy," *Informis Journal on Computing.*, vol. 24, issue. 4, pp. 665-682, Oct. 2012.
- [28] W. B. Powell, and S. Meisel, "Tutorial on Stochastic Optimization in Energy - Part II: An Energy Storage Illustration," *IEEE Transactions on Power System*, vol. 31, no. 2, pp. 1468-1475, Mar. 2016.
- [29] Z. Chen, L. Wu, and M. Shahidehpour, "Effective Load Carrying Capability Evaluation of Renewable Energy via Stochastic Long-Term Hourly Based SCUC," *IEEE Transactions on Sustainable Energy*, vol. 6, no. 1, pp. 188-197, Jan. 2015.
- [30] C. Keerthisinghe, G. Verbic, and A. C. Chapman, "A Fast Technique for Smart Home Management : ADP with Temporal Difference Learning," *IEEE Transactions on Smart Grid*, vol. PP, no. 99, pp. 1-12, Nov. 2016.
- [31] Y. F. Tang, H. B. He, Z. Ni, and J. Y. Wen, "Optimal Operation for Energy Storage with Wind Power Generation Using Adaptive Dynamic Programming," in *Proceedings of the 2015 IEEE Power & Energy Society General Meeting*, 2015.
- [32] M. Strrelec, and J. Berka, "Microgrid energy management based on approximate dynamic programming," in *Innovative Smart Grid Technologies Europe (ISGT EUROPE), 2013 4th IEEE/PES*, 2013.
- [33] N. Fueyo, Y. Sanz, M. Rodrigues, C. Montañés and C. Dopazo, "The use of cost-generation curves for the analysis of wind electricity costs in Spain," *Applied Energy*, vol. 88, pp. 733-740, 2011.
- [34] S. Ramabhotla, S. Bayne, and M. Giesselmann, "Economic Dispatch Optimization of Microgrid in Islanded Mode," *International Energy and Sustainability Conference (IESC)*, 2014, Farmingdale, USA.
- [35] J. Yang, N. Zhang, C. Kang, and Q. Xia, "A State-Independent Linear Power Flow Model with Accurate Estimation of Voltage Magnitude," *IEEE Transactions on Power Systems*, vol. PP, no. 99, pp. 1-12, 2017.
- [36] Puterman. M. L, *Markov Decision Processes*. John Wiley and Sons, New York, 1994.

- [37] Bertsekas. D. and Tsitsiklis. J, *Neuro-Dynamic Programming*. Athena Scientific, 1 edition, 1996.
- [38] J. Xiao, "Grid integration and smart grid implementation of emerging technologies in electric power systems through approximate dynamic programming," *Ph.D dissertation, Dept. Chemical Eng., Purdue Univ., West Lafayette, Indiana*, 2013.
- [39] N. Chen, Z. Qian, I. T. Nabney, and X. Meng, "Wind Power Forecasts Using Gaussian Processes and Numerical Weather Prediction," *IEEE Transactions on Power System*, vol. 29, no. 2, pp. 656-665, Mar. 2014.
- [40] A. Motamedi, H. Zareipour and W. D. Rosehart, "Electricity Price and Demand Forecasting in Smart Grids," *IEEE Transactions on Smart Grid*, vol. 3, no. 2, pp. 664-674, Jun. 2012.
- [41] C. Wang, J. Zhao, Y. Song, Z. Xu, J. Lin and Z. Hu, "Photovoltaic and Solar Power Forecasting for Smart Grid Energy Management," *CSEE Journal of Power and Energy Systems*, vol. 1, no. 4, pp. 38-46, Dec. 2015.
- [42] N. Amjady, A. Daraeepour, and F. Keynia, "Day-ahead electricity price forecasting by modified relief algorithm and hybrid neural network," *IET Generation, Transmission & Distribution*, vol. 4, no. 3, pp. 432-444, 2010.



Hang Shuai (S'17) received the B.Eng. degree from Wuhan Institute of Technology (WIT), China, in 2013. He is currently working toward the Ph.D. degree in electrical engineering at the Huazhong University of Science and Technology (HUST), Wuhan, China.

His research interests include power systems operation and economics, stochastic optimization, and integrated energy system.

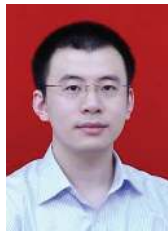

Jiakun Fang (S'10, M'13) received the B.Sc. and Ph.D. degrees from Huazhong University of Science and Technology (HUST), China, in 2007 and 2012, respectively.

He was with Huazhong University of Science and Technology (HUST), Wuhan, China. Currently he is an Assistant Professor with the Department of Energy Technology, Aalborg University, Aalborg, Denmark. His research interests include power system dynamic stability control, power grid complexity analysis and integrated energy system.



Xiaomeng Ai (M'17) received the B.Eng degree in mathematics and applied mathematics and Ph.D. in electrical engineering in 2008 and 2014, respectively, both from Huazhong University of Science and Technology (HUST), Wuhan, China. Currently he is a research fellow at HUST.

His research interests include robust optimization theory in power system and renewable energy integration.



Yufei Tang (M'16) received the B.Eng. and M.Sci. degrees from Hohai University, Nanjing, China, in 2008 and 2011, respectively, and the Ph.D. degree in electrical engineering from the Department of Electrical, Computer, and Biomedical Engineering, University of Rhode Island, Kingston, RI, USA, in 2016.

He is currently an Assistant Professor with the Department of Electrical, Computer, and Biomedical Engineering, and a Faculty Fellow with the Institute for Sensing and Embedded Network Systems Engineering, Florida Atlantic University, Boca Raton, FL, USA. His research interests include power systems stability and control, smart grid security, computational intelligence, and cyber-physical energy systems.



Jinyu Wen (M'10) received the B.Eng. and Ph.D. degrees all in electrical engineering from Huazhong University of Science and Technology (HUST), Wuhan, China, in 1992 and 1998, respectively. He was a visiting student from 1996 to 1997 and research fellow from 2002 to 2003 all at the University of Liverpool, UK, and a senior visiting researcher at the University of Texas at Arlington, USA in 2010. From 1998 to 2002 he was a director engineer in XJ Electric Co. Ltd. in China. In 2003 he joined the HUST and now is a professor at HUST.

His current research interests include renewable energy integration, energy storage application, DC grid, and power system operation and control.



Haibo He (SM'11, F'17) received the B.S. and M.S. degrees in electrical engineering from Huazhong University of Science and Technology, Wuhan, China, in 1999 and 2002, respectively, and the Ph.D. degree in electrical engineering from Ohio University, Athens, OH, USA, in 2006.

From 2006 to 2009, he was an Assistant Professor in the Department of Electrical and Computer Engineering, Stevens Institute of Technology. He is currently the Robert Haas Endowed Chair Professor in the Department of Electrical, Computer, and Biomedical Engineering, University of Rhode Island, Kingston, RI, USA. His research interests include adaptive dynamic programming, computational intelligence, machine learning and data mining, and various applications.

Prof. He served as the General Chair of the IEEE Symposium Series on Computational Intelligence. He received the IEEE International Conference on Communications Best Paper Award in 2014, IEEE Computational Intelligence Society Outstanding Early Career Award in 2014, National Science Foundation CAREER Award in 2011, and Providence Business News "Rising Star Innovator Award" in 2011. He is currently the Editor-in-Chief of the IEEE TRANSACTIONS ON NEURAL NETWORKS AND LEARNING SYSTEMS.