

2012

Storyspace: a Story-Driven Approach for Creating Museum Narratives

Annika Wolff

Knowledge Media Institute, The Open University

Paul Mulholland

Knowledge Media Institute, The Open University

Tevor Collins

Knowledge Media Institute, The Open University

Follow this and additional works at: <https://arrow.tudublin.ie/decipart>



Part of the [Arts and Humanities Commons](#), and the [Computer Sciences Commons](#)

Recommended Citation

Wolff, Annika; Mulholland, Paul and Collins, Trevor (2012). Storyspace: a story-driven approach for creating museum narratives. In: *Hypertext 2012: 23rd ACM Conference on Hypertext and Social Media*, 25 - 28 June 2012, Milwaukee, WI, USA.

This Article is brought to you for free and open access by the Decipher at ARROW@TU Dublin. It has been accepted for inclusion in Publications by an authorized administrator of ARROW@TU Dublin. For more information, please contact arrow.admin@tudublin.ie, aisling.coyne@tudublin.ie.



This work is licensed under a [Creative Commons Attribution-NonCommercial-Share Alike 4.0 License](#)
Funder: European Commission

Storyspace: a Story-driven Approach for Creating Museum Narratives

Annika Wolff
Knowledge Media Institute
The Open University
Milton Keynes, MK7 6AA
+44 (0)1908 659462
a.l.wolff@open.ac.uk

Paul Mulholland
Knowledge Media Institute
The Open University
Milton Keynes, MK7 6AA
+44 (0)1908 654506
p.mulholland@open.ac.uk

Trevor Collins
Knowledge Media Institute
The Open University
Milton Keynes, MK7 6AA
+44 (0)1908 655731
t.d.collins@open.ac.uk

ABSTRACT

In a curated exhibition of a museum or art gallery, a selection of heritage objects and associated information is presented to a visitor for the purpose of telling a story about them. The same underlying story can be presented in a number of different ways. This paper describes techniques for creating multiple alternative narrative structures from a single underlying story, by selecting different organising principles for the events and plot structures of the story. These authorial decisions can produce different dramatic effects. Storyspace is a web interface to an ontology for describing curatorial narratives. We describe how the narrative component of the Storyspace software can produce multiple narratives from the underlying stories and plots of curated exhibitions. Based on the curator's choice, the narrative module suggests a coherent ordering for the events of a story and its associated heritage objects. Narratives constructed through Storyspace can be tailored to suit different audiences and can be presented in different forms, such as physical exhibitions, museum tours, leaflets and catalogues, or as online experiences.

Categories and Subject Descriptors

H.5.4 [Information Systems]:Hypertext/Hypermedia – architectures, theory, user issues

General Terms

Algorithms, Design

Keywords

Narrative, story, plot, events, museum, heritage objects, hypertext

1. INTRODUCTION

Current metadata-based schemes for describing cultural content are designed for describing individual heritage objects within a cultural collection, not for describing the stories that span objects. They do not tap into the rich, additional context provided through the knowledge and research efforts of curators as they construct exhibitions. By including these stories along with the standard metadata it becomes possible to create better ways for publishing exhibitions online, providing narratively meaningful links to related content that was not available in the physical space and allowing the user to better explore the underlying stories and plots that link objects to one another. The curate ontology (<http://decipher.open.ac.uk/curate>) represents an approach to modelling heritage content by capturing the underlying stories of both the individual heritage objects and the curated exhibits as a whole. It has been developed to address the limitations of current metadata-based schemes.

The structure of the ontology is reflected in Storyspace, a web based environment for authoring curatorial stories. In Storyspace, curators can add content and information about an exhibition. Both the ontology and software tool have been developed through collaboration with two large Irish heritage institutions, the Irish Museum of Modern Art (IMMA) and the National Gallery of Ireland (NGI). These institutions are currently using the tool to describe two recent exhibitions, one on Gabriel Metsu and one on Irish Modernism. Storyspace [1] assists a curator in constructing stories, plots and narratives. Using timeline visualisations, the curator can explore and plot the story from multiple different angles, using facets that they have defined as being central to the current curatorial story. This in turn leads to richer narrative construction.

This paper will outline how Storyspace can be used to describe stories that span museum objects. Narrative presentations can be created from a specified story and plot, using the described narrative organization methods. We will first look at related work in the field of narrative, museum hypertexts and current approaches to organising and presenting museum content online. Next we will briefly introduce the Curate ontology and the Storyspace web environment including events, plot and facets. The core of the paper will explore in detail the narrative module of Storyspace and the different types of narrative presentations that can be produced.

2. RELATED WORK

2.1 Narrative, plot and drama

The work described in this paper is founded on the principle that far from being a special type of narrative, the curatorial narrative as found in a museum exhibition, is founded on the same principles as other forms of narrative, including the dramatic plot-based narratives found in many fictional books and films. We subscribe to a structuralist view [2, 3] whereby the events of the story are distinct from the telling of it (the narrative). In between lies the plot [4], organising and relating the events of the story according to a particular perspective. The plot identifies a purpose for all the events that it contains, selecting only those which advance the plot in some way [5]. The intensity of the narrative can vary according to the plot selected for that telling of the story. The most basic narrative form omits the plot altogether, thus imposing no view on the story and merely relating events. In a plotless narrative, where there are no relationships defined between events, it is usually assumed – unless indicated otherwise by some linguistic device – that events are presented chronologically [6]. If an ordering principle other than time is

used, then this needs to be indicated to the reader of the narrative otherwise it could lead to a loss of coherence [7]. Plots introduce the ability to add drama to a narrative. The dramatic impact of a plot can be manipulated by choosing when to introduce conflict, when to escalate tension and when to introduce a resolution [8]. When constructing narratives from visual content, coherence is improved by identifying and using themes for content selection, which then provide a sub-text to the narrative presentation [9, 10].

2.2 Narrative, hypertext and the museum

Each heritage objects tells a story about why it is significant, what it shows, where it came from, and how it relates to other items in the collection and elsewhere [11]. For example, a mass-produced clothing item can become interesting when we know that someone famous has worn it. It is the story, as much as the item itself, which captures the imagination. The impact of the story intensifies the more the clothing item is linked to other objects or stories from the person's life. From all of this related information, curatorial narratives are made. Peponis et al. [12], in an analysis of museum exhibitions, used the term narrative to refer to an arrangement of exhibits and their associated information into a sequence that yields more complex insights than could be derived from exhibits individually. They use narrative to refer to the manner in which the contents of the exhibits can be conceptually related. Rowe et al. [13] distinguish between the "big" narrative of the exhibition and the small vernacular narratives associated with it. These small narratives may originate from the visitor, triggered by something in the exhibition. For example, the visitor recalling a personal experience related to an object or event of the exhibition. Museums may also use small narratives themselves to help visitors to relate to the bigger narrative. For example, presenting the (possibly fictional) story of a character who lived at a certain time in order to bring it to life.

In the physical space, some interconnections between objects may be afforded by the layout of the space. Conversely, some items that evidence a story may be separated by distance. In such cases, notes and signs may be used to indicate the linking of such items, to allow the visitor access to that part of the narrative. But unless the visitor is willing to walk backwards and forwards some items are inevitably encountered 'out of sequence' of the intended narrative, as the visitor must follow a linear path through the museum.

The web has long since been offering new ways of exploring curatorial narratives [14]. An early use of hypertext in the museum was Hyperties [15], which provided contextual information about museum objects from a museum's database, linked through a hypertext menu system. Content included both text and pictures and users could easily navigate the topics of their interest. As well as addressing the needs of the end-user, Hyperties aimed at making the authoring process relatively simple. The Iperctene hypertext [16] aimed to connect objects in a Florence museum to each other, or to people involved in the objects narratives. More recent work moves away from the traditional complex linked hypertexts and examines issues related to helping users to orient themselves within a hypertext and to find information that is targeted towards both their interests and their level of understanding. These offer the facility to present the same story and plot but in different narrative forms (e.g. [17]). ILEX [18] generates dynamic hypertexts, tracking a user's path

through online museum content and using this to create hyperlinks for the next stage of exploration which are coherent with respect to the users past navigational choices.

2.3 Tools for sequencing museum content

Many initiatives exist for making cultural content, and related information, available online using a standard, easily searchable metadata description. In addition to the content coming directly from museums, some sites such as Europeana [19], Freebase [20], and the People's Network [21] aggregate large quantities of cultural data. The bigger challenge is how to turn all of this content into a valuable and coherent user experience, one that reflects the types of curatorial narratives that can be found in a professionally curated exhibition. Systems that focus on the metadata tend to produce narratives that sequence items according to common attributes, such as being produced by the same artist, in the same time period, or in the same medium. The CHIP project [22, 23] merges user preferences with metadata to suggest personalized tours through online cultural content. Agora [24] seeks to enrich heritage object metadata by automatically creating a linked thesaurus of related historic events that can connect objects in different collections and allow navigation according to topics and event properties, such as location and person, in addition to the indexed metadata. This increases the potential set of relationships that can be used for connecting content. Culture Sampo [25, 26] annotates content by events, which can be organized into stories that link content. As a user browses the annotated content, the event data is used to suggest semantically related information, e.g. according to people or places described in the events. It has been demonstrated through systems related to the production of ceramics and the typical seasonal farming processes. Similarly, Bletchley Park Text [27] links historical stories based on common properties of their events.

The use of events to describe objects clearly better supports the sequencing of content, for example by time, and location of related items than is possible from metadata matching alone. However, without a representation of plot it is only possible to build certain types of narrative, such as chronicles that simply list events by time. Plot introduces the drama and the tension and imposes a specific viewpoint across the story.

3. STORYSPACE

The following sections contain brief descriptions of the Storyspace components that are used in narrative construction. Figure 1 shows a screenshot of the interface. Storyspace supports curators in creating exhibitions from selections of heritage objects and the stories that link them. The main constituents of Storyspace are as follows.

- 1) Story layer – this consists of the events of the story. Facets, visualisations (of story events and plots) and references can all be added to a story. This layer contains both heritage object stories (about individual objects) and curatorial stories (containing multiple heritage objects and the events that link them). Stories can be broken into components.
- 2) Plot layer – describing relationships between the events that move the story forwards.
- 3) Narrative layer – ordering events and plots for a narrative presentation.

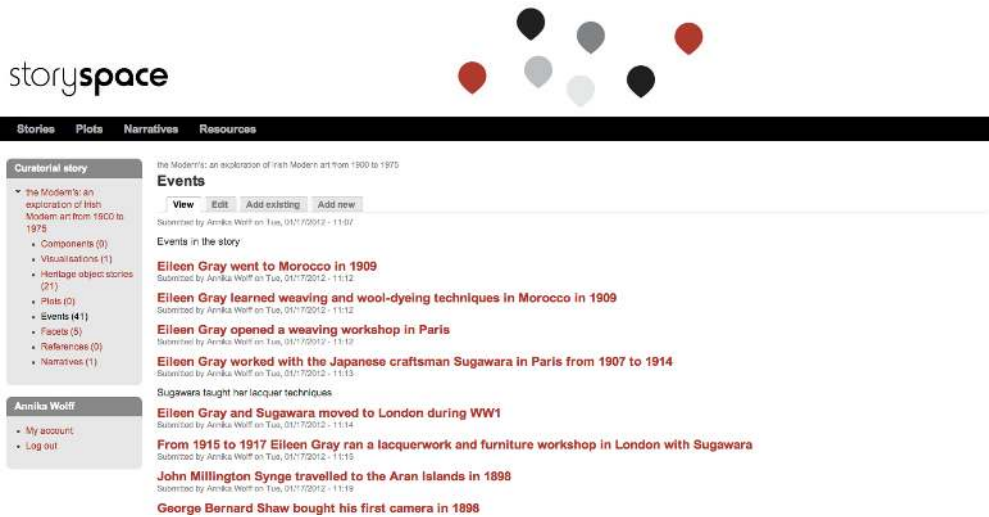

Figure 1. The Storyspace software.

- 4) Heritage objects - information about heritage objects can be entered into Storyspace, along with uploaded images or links to online sources. The objects can be both those which can be used within a physical exhibition and also external objects that the curator does not have physical access to, but is able to use within online narratives. Heritage objects are used within Heritage Object Stories. When a Heritage Object story (and its associated object) is brought into a Curatorial Story, all of its events become part of the Curatorial Story and are then available for plotment.

The underlying curate ontology was developed with input from the project's museum partners and by analysis of the two focal exhibitions, Metsu and the Moderns. For a fuller explanation of the underlying curate ontology please see [1]. Two workshops were held in Dublin with curators and other museum professionals, to validate the assumptions of the model. Sessions included talks by the curators of the exhibitions, as well as question and answer sessions with the curators, educators, archivists and other museum staff. Finally, there were break out sessions aimed at gathering feedback on possible use-cases using paper-mockups, which also served to validate parts of the model which would have been hard to present out of context. Staff in both institutions have been using an online version of the tool for inputting exhibition content. Feedback has been elicited via structured questionnaire, which has further informed design decisions for both the ontology and the software.

The examples used in the remainder of the paper are taken from the Modern's exhibition that was held by IMMA.

3.1 Defining story events

A curatorial story contains of a set of events. Events come from two sources. The first source is from the heritage object stories relating to the heritage objects that are chosen for the curated exhibition. As an example, these stories might describe when and where an object was created, circumstances that have inspired its creation, or what has happened to it in its lifetime. The second source are the events that relate not to a single object but to a set, or subset, of the exhibited objects. These provide additional context. Some example events - some from heritage object stories and others more general - can be seen in Table 1. The events can be added by a curator or can be pulled in from external sources.

The same event can belong to multiple different stories. An event can be described in different ways for different stories, using facets. Facets are described next.

Table 1. Example events from a story about the Irish Modernist artist Eileen Gray.

Eileen Gray worked with the Japanese craftsman Sugawara
Eileen Gray went to Morocco
Eileen Gray learned weaving and wool-dyeing techniques in Morocco
Eileen Gray opened a weaving workshop in Paris
Eileen Gray ran a lacquerwork and furniture workshop in London with Sugawara
Eileen Gray and Sugawara moved to London during WW1
Eileen Grey designed the St. Tropez rug

3.2 facets

Facets can be defined which describe an important property of a curatorial story. Examples include time, location and theme. Example of facet values are shown in Table 2.

Table 2. Example facets from the Moderns

	Facet name	Values
F1	Theme	Irish women modernists, Early photography/film
F2	Time	value range = 1898-1950
F3	Location	Aran Islands, England, Morocco, France, Peru, Ireland



Figure 2. Annotating an event with some facet values.

Events that belong to a curatorial story are annotated according to the defined story facets. (Figure 2) Facets can be used first for interpreting and describing events and then for filtering and colour-coding those events on the timeline visualization, for identifying groups of events that belong together and to identify possible components of the story. Facets are also used in the generation of narratives.

3.3 Emplotting events

Emplotment involves identifying relationships between events, or groups of events. A plot is divided into *plot descriptions*. Each plot description specifies a relationship between some events within the story. Some example plot descriptions are shown in Table 3.

Table 3. Example plot descriptions from the Moderns

	Plot Description	
P1	Eileen grey was influenced by studying and working with Sugawara	
	influential	Eileen Gray worked with the Japanese craftsman Sugawara in 1907 Eileen Gray ran a lacquerwork and furniture workshop with Sugawara in 1915 Eileen Gray and Sugawara moved to London during WW1 in 1918
	influenced-by	Eileen Gray designed Green Japanese Style Carpet Template in 1919 Eileen Gray created lacquer boxes 1 and 2 in 1920
P2	Eileen Grey was influenced by her travels in Morocco	
P3	Eileen Grey was influenced by her travels to America on an ocean liner	
P4	Donegal carpets were influenced by Eileen Grey	
P5	Roger Casement's revolutionary activities were influenced by his photography in Peru	
P6	George Bernard Shaw was a keen photographer	

When creating a plot description, the curator first selects the type of plot they want to create. We refer to this as the *plot type*. A plot type determines the nature of the relationship that is being specified. Examples include *influenced-by*, *reacted-against*, or the less committal *related-to*. These are structurally similar, but conceptually different plot types. Each plot type has one or more plot elements, which contains the event or events that are being related. These events provide some evidence for the plot relation. For example, in the *influenced-by* plot type, one plot element identifies the event, or set of events, that are influential and the other plot element identifies the event, or set of events, that are influenced. When authoring a plot, the author can decide how to describe the plot type within the plot description, giving the possibility for the curator to select more nuanced terms. Figure 3 shows an example of viewing events on a timeline visualization during emplotment of part of the Moderns story.

3.4 heritage objects

Data pertaining to heritage objects can be entered into Storyspace. Images of objects can either be uploaded, or else linked to via specifying a url. Table 4 shows some examples of objects from the Modern's exhibition. Each object has a linked creation event in its associated heritage object story.

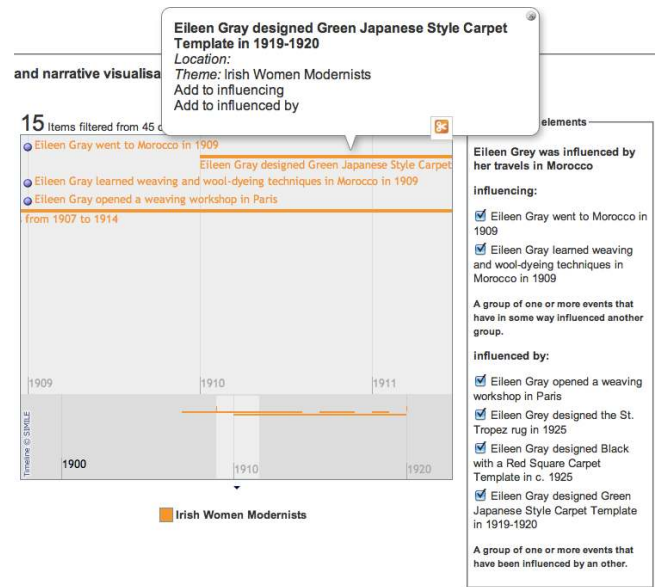





Figure 3. Making a plot on a timeline visualisation.

Table 4. Some heritage objects from the Moderns

	Object description and creation date	Object
o1	Eileen Green Japanese Carpet (1919)	
o2, o3	Eileen Gray lacquer boxes 1 and 2 (1920)	
o4	Eileen Gray designed Black with a Red Square Carpet Template (1925)	
o5	Eileen Grey designed the St. Tropez rug (1925)	
o6	George Bernard Shaw photo of unknown woman (1900)	
o7	George Bernard Shaw photo of ship rigging (1900)	
o8	George Bernard Shaw photo of Bridge (1904)	
o9	George Bernard Shaw photo of Trees (1904)	
o10	Casement and Sealy photo negro overseer (1910)	
o11	Roger Casement photo Group of Putumayo girls (1910)	

o12	Roger Casement Putumayo girl (1910)	
o13	Roger Casement Putumayo man (1910)	
o14	George Bernard Shaw handprint (1920)	

4. NARRATIVE ORGANISATION METHODS

A narrative presents a story for an intended audience and through a chosen medium. Thus, the same story can be presented through both multiple plots and multiple narratives. As previously discussed in section 2.1, the choice of narrative presentation of a story can affect both the coherence and the dramatic impact. As an example, a temporally coherent presentation of an artist’s life work would present the work in chronological order. However, the dramatic impact of this ordering is completely different if the artist died at the peak of their career, or if their peak occurred some time earlier.

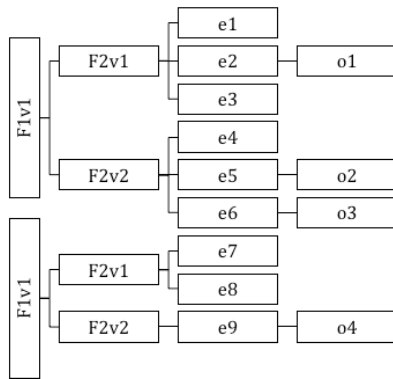

Figure 4. A generic narrative structure.

The rest of the paper focuses on the narrative module of Storyspace and how the curator can alter the effect of a narrative by altering the principles used for organising its elements. The narrative is output as an ordered set of story events and related heritage objects. The ordering is determined according to some stated preference of the curator: a narrative can be created from facet only, from plot only, or a combination of both (facet then plot, or plot then facet). These cases are explored in detail below.

4.1 Create narrative from facet

A narrative can be created from Storyspace by specifying the important facet, or facets, to be used for organising and ordering events. For a selected facet, the events are grouped according to their value for that facet. If multiple facets are selected, then the author also chooses the order in which the facets are used. Some events within the curatorial story will be heritage object story events, which in turn are linked to heritage objects. This association is used to propose an ordering of the heritage objects associated with the story. Figure 4 shows a generic narrative structure. Figure 5 shows the narrative structure instantiated with content from the Moderns example. In this case, the plot is unused, so there is no interpretation of events, or how they relate. The events are provided simply as a list of what has happened. The coherence of the output and the general look and feel of the narrative is manipulated through the choice of facet ordering.

Changing the primary facet will usually have quite a significant effect, whereas the effect of swapping facets further down the ordering is much more subtle and nuanced. This type of narrative is most useful for grouping objects into categories and to be effective, the facets must be properly defined. These narratives are conceptually similar to the ones produced by the tools described in section 2.3.

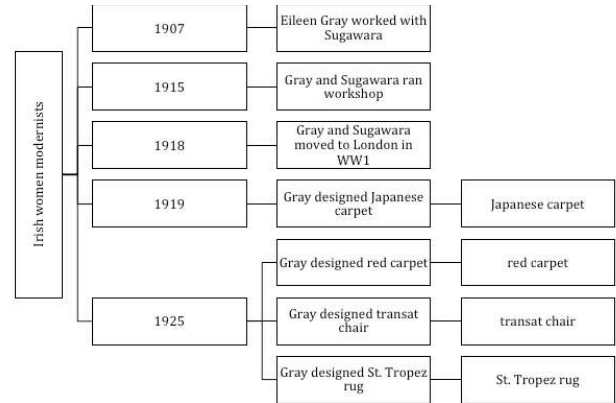

Figure 5. A narrative structure using Irish women Modernists as the primary organisational facet, followed by time.

Figure 6 explores how this output might look when viewed through the heritage objects associated with the curatorial story. The data in Table 4 offers insight into how the narrative ordering of the objects is generated within Storyspace, with the facet ordering *theme* and then *time*. The objects are in the order as given in the table, i.e the first item is ‘o1: Japanese style artist template’ and the last item is ‘o14: photograph of handprint’. Objects 1-5 belong to the theme ‘Irish women Modernists’ and 6-14 belong to ‘Early photography/film’. It can be seen from this order that the last item in the sequence, the photograph by George Bernard Shaw, is not grouped with his other photographs but appears at the end of a series of photos taken by Roger Casement. In this case, the curator has two options if they wish to group works of the same artist together. They could make a small adjustment to the narrative output, or they could change the underlying story that generates it (e.g. create a facet for ‘people’ to use as an organising facet). Further options, using plot, are explored next.



Figure 6. Objects ordering by the facets *theme* and *time*.

4.2 Create narrative from plot

As mentioned previously, a plot is used to provide a specific interpretation of events. The narrative presentation of a plot can alter the effect it has towards an audience. Aristotle describes a dramatic arc [5] where the plot is narrated to provide a rising action, a crisis that reaches a climax whereupon the tension falls, before the narrative is brought to a satisfactory conclusion. This same pattern may repeat over several acts of a story, each climax getting higher and higher. The effect of the narrative can be manipulated by changing the order of plot elements, for example by presenting a story outcome before the story unfolds (such as

showing an arrest for a crime, before discovering what the crime was and how/why it took place), or narratives that deliberately play with temporal ordering by going backwards and forwards between time periods, or visiting key story components in complete reverse order. In Storyspace, there are three different ways to create a narrative from a plot. The choice depends on the desired effect towards the audience. Figure 7 shows two plot descriptions, of the plot type ‘influenced-by’. This plot type contains two plot elements, one contains ‘influencing events’ (indicated by the *i*) and a set of influenced events (indicated by the letter *ib*). This example is used in the following sections to illustrate the different organising principles for plot-based narratives.

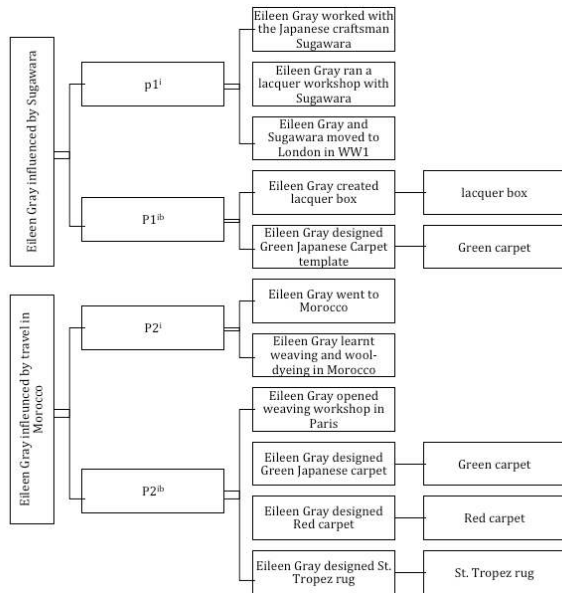

Figure 7. Two plot descriptions, of plot type ‘influenced-by’ each divided into influencing and influenced by events.

4.2.1.1 Order by plot description (minimize tension)

Using this organising principle, events are organized according to their inclusion in plot descriptions. Each individual plot description is treated as a separate entity. This minimizes the number of plot descriptions that are in progress at any one time when reading through the events. The ordering of the individual plot descriptions is determined by the curator. In terms of a dramatic arc, tension is minimized by completing a plot description as soon as possible (Figure 8). For example, in an ‘influenced-by’ plot, all causes of influence are introduced and then immediately the outcome is presented, before moving on to the next plot description.

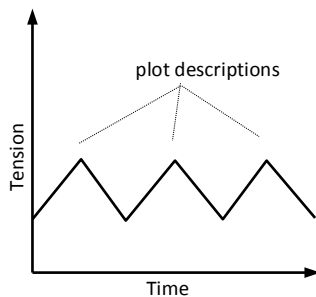

Figure 8. Minimizing tension in a plot-based narrative.

Looking at the Figure 7 example, first the plot description *Eileen Gray was influenced by Sugawara* is introduced in its entirety, before the next plot description *Eileen Gray was influenced by her travel in Morocco* can start. Figure 9 demonstrates how plot-based ordering can change the ordering of heritage objects. In the first example, one photo by George Bernard Shaw was mixed with those by Roger Casement. Using plot as an organising principle, George Bernard Shaw’s photographs are now grouped together, as are Roger Casement’s. This is because they have each been described in the same plot description.

In some cases, a conflict must be resolved where the same object appears in two plot descriptions. One possibility is that the item can be placed to act as a bridge between two different plots. An example of this is shown in the top row of Figure 9 where the green carpet is used to transition between one plot and the next. If this is not possible, or not desirable, and the exhibition is online then the heritage object can if desired appear in both plots, or else a hyperlink might provide a link from one plot to another. In a physical space, the indication of an alternative plot for an object might be given by text on a wall plaque next to the object, or a comment in an audio guide or tour guide’s speech.



Figure 9. Objects ordered according to plot descriptions.

4.2.1.2 Order by plot elements (maximize tension)

This narrative style can be used to maximize tension by leaving the plot descriptions unresolved for as long as possible (Figure 10). In the Figure 7 example, this would entail presenting all of the events of $p1^i$ and $P2^i$ before moving onto the events of $P1^{ib}$ and $P2^{ib}$. This creates suspense where the reader must await the outcome. In a gallery setting, this plot type is fairly common. As an example, the influencing factors for several, often interrelated, plots are explained by way of a wall plaque that the visitor might view before looking at the objects on display. These objects are provided as evidence of the stated influences.

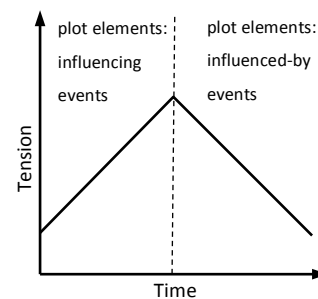

Figure 10. Maximising tension in a plot-based narrative

4.2.1.3 Order by plot type

In this case, the author specifies which types of plot they want to show first, for example to show all examples of related-to, then all examples of influenced-by. The nature of the plot relationship defined affects the dramatic arc. Plot descriptions that demonstrate a ‘related-to’ relation could be seen to be less dramatic than an ‘influenced-by’ relation. This plot style might be used to increase tension over a period of time (Figure 11) or to

decrease it. A narrative of this type might be used to show how certain plot types tend to repeat, such as showing multiple examples of art being produced in reaction to an important world event.

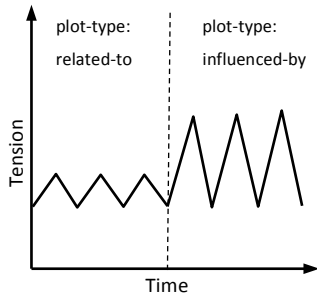

Figure 11. Escalating the tension.

4.3 Create narrative from plot, then facet

In this case, common to many art and museum exhibitions, the elements within an overarching plot are ordered according to the selected facets. For example, an art exhibition might have an overarching plot about an artist's life works, exploring how their experiences have influenced their career and painting. Within this main plot, the exhibition could be organized to show the different time periods in their career, or explore how their work changed as they moved from one location to another. The Modern's exhibition, which explored the development of Modern art in Ireland as the overarching narrative, used themes (such as Irish women modernists) within broad temporal categories to show a progression in style across the span of the exhibition (Figure 12).

Grand Narrative: The development of modernity in Ireland through the visual arts in the period 1900 to 1975

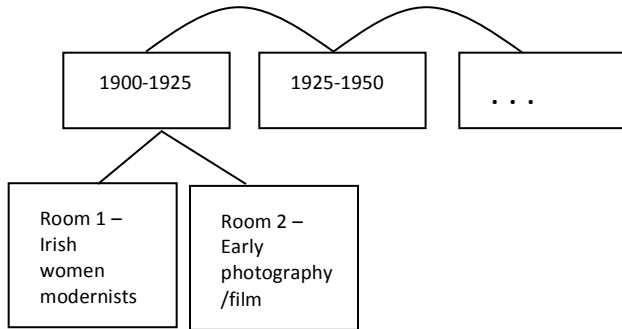

Figure 12. Overarching plot and some themes of the Moderns.

4.4 Create narrative from facet, then plot

Whereas the previous example viewed works organized by theme within an over-arching plot, this organizational principle focuses on the vernacular narratives, within a smaller thematic category. The events are first organized according to the chosen facet, with associated plot structures being secondary. Figure 13 shows an example where events are related in plot structures under the

thematic headings *Irish women modernists* and *Early photography/film*. Some plots may relate several objects together, others might be plots of individual heritage object stories. This organizational principle is suitable when the plots are, to a large extent, self-contained within the thematic grouping.

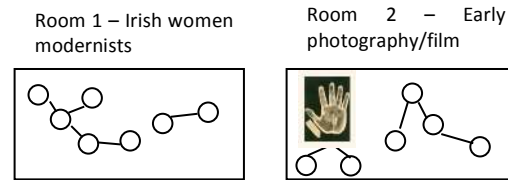

Figure 13. Thematic groupings with plots.

As discussed in section 2.2, most museum narratives use a combination of the grand narrative with some thematic organization (the case discussed in 4.3) and within the themes are smaller vernacular narratives (the case discussed in 4.4). The vernacular narratives collectively help the visitor to see the bigger narrative and to relate on a more personal level to the objects in the exhibition [13].

5. Storyspace narrative interface

Social curation tools are designed to allow authors to quickly and easily select, organize and edit social content into personalized narratives. In particular, Storify [28] and Bagtheweb [29] both offer intuitive and easy interfaces for ordering narrative components, editing and adding text and for viewing the completed narratives. These features, such as drag and drop ordering and node adding and editing, have informed the design of the Storyspace narrative interface.

A new narrative is added by selecting a story, and therefore the events, facets and plots, from which to create the narrative. The curator then chooses the organising principle, e.g. facet, or plot. Currently the curator must also select the ordering within this initial grouping (see Figure 14). So, if organising by facets, then they must select the primary facet to group by, then the second and so forth. Figure 15 shows a view of a narrative when it is first output. This narrative has been output in plot order and the events that influenced Roger Casement are introduced first, followed by the heritage objects. The narrative is output as in a linear path from which more complex structures can be built.

Within the *edit elements* view of the narrative, the curator can drag and drop items to reorder objects and events. For presenting the narrative, the story events may be replaced by more free-flowing text, or rewritten for a younger audience. This is achieved by inserting a new text node, or by editing existing event text. (see Figure 16). It is important to note that this does not alter the original event only how it is presented in that specific narrative.

Add Narrative

[View](#) [Add new](#)

Narrative title:
 The Modernism for secondary school children

→ [Menu settings](#)

Description:
 This narrative explores the lives of the people involved in Irish Modernism between 1900-1975. In the early 20th century, Eileen Gray, May Gurness, Mairé Jollet, and Mary Swanzy studied in Paris and were influenced by the Modernist movement they witnessed there. Roger Casement was a humanitarian campaigner and an Irish revolutionary. George Bernard Shaw was an Irish playwright. Both were also heavily influenced with their careers by their photography.

Choose ordering principle:
 Facet

Order first by:
 People

Figure 14. Creating a narrative from a curatorial story.

Irish Photography/Film

[View](#) [Edit elements](#) [Edit narrative](#)

Narrative

Roger Casement was sent to Peru with his camera in 1910

Roger Casement investigated alleged humanitarian abuses against tribes in Putumayo in 1910

Tribes in Putumayo were assisting rubber traders and the automobile industry in 1910

Roger Casement took photographs of the tribes in Putumayo in 1910

Roger Casement - Young man on riverboat Putumayo region of Peru / Colombia, 1910

Roger Casement - Putumayo man with ceremonial headdress Putumayo region of Peru / Colombia, 1910

In 1910, Roger Casement was sent by the British government to investigate alleged humanitarian abuses against tribes in the Putumayo region of Peru who worked to service the needs of the local rubber traders and the automobile industries in the West.



Figure 15. Viewing a narrative constructed from events and related objects of the Irish Photography/Film facet.

Narrative





-  **Transat chair**
 Inspired by deck-chairs Gray saw on an ocean liner while travelling to America, her Transat Chair (1925–30) was named after the Compagnie Générale Transatlantique (the French Line). [Edit](#)
-  **Saint-Tropez rug**
 Although Gray originally designed Saint-Tropez Rug in 1925, this hand-tufted rug was commissioned by her niece Prunella Clough in the 1970s and made by Donegal Carpets [Edit](#)
-  **Black with a Red Square**
Black with a Red Square Carpet Template [Close](#)
 Black with a Red Square Carpet Template [Edit](#)
Description:
 Having travelled to Morocco to learn wool techniques, Eileen Gray's interest in carpets and carpet design began
-  **Green Japanese Style**
 URI:
 File attachments:
 Save Preview [Edit](#)
-  **Lacquer box 2** [Edit](#)

Figure 16. Editing a node within a narrative template. The drag handles allow reordering of content.

In addition to the overall organization of the exhibition, the curator must take into account other factors when developing the final narrative. The presentation of objects in terms of the setting (the room, the online canvas), the proximity to other pieces, or to other features of the space such as lifts, cafeteria, interface navigation items etc., can all affect the viewers' interpretation of the pieces. Other curatorial choices include:

- Where to place objects in a physical space to achieve a desired dramatic effect. Placing the exhibition 'highlights' in prominent locations can lead to visitors going straight to them and missing more subtle and less well-known, but no less interesting, pieces.
- How and where to place objects in an online space. Issues include the sizing of objects, e.g. showing pictures in relative sizing or making them all appear the same size, zooming in on detail-views of objects more relevant to a narrative or showing always the whole piece, or the choice of perspective on a 3 dimensional object, such as a sculpture, where 3D views are not an option.
- The extent to which underlying story and plot is revealed to a visitor. Some curators choose to show only the heritage objects as a prompt to visitors to construct the story for themselves, giving the objects the role of sources of evidence for the narrative. This is seen as being consistent with constructivist approaches to learning [30]. Alternatively, stories related to an individual heritage object might be presented alongside it. Stories that link collections might be written as a block of text on the wall close to the set of exhibits it describes.
- How to present the narrative. Who is it for? audio guides, themed tours, or the language used to present the story for children, adults, art professionals. Another important consideration is how to make the most of online technologies when presenting the exhibition online.
- How to handle constraints. In a physical space, constraints might include not having access to desired objects that form part of the narrative, not being able to put story-related items close to each other due to, for example, the nature of the pieces (they need different lighting conditions), the nature of the physical space (they won't both fit), or the necessity to follow the instructions of an artist (they want their piece displayed on its own). In an online space, constraints might include copyright restrictions, or broken links.
- How to use narrative markers to links parts of a story. Narrative markers can be arrows, directions via the audio, text on a wall plaque indicating a relationship between objects, or hyperlinks in an online gallery.
- Similarly, how to inform about the organising principles used for constructing the narrative to ensure that the narrative is coherent to the viewer. In a physical space, the exhibition spaces are often clearly marked with some indicators as to the theme or plot. In an online presentation, where user's have freedom to move beyond the linear presentation, it is equally important that the user is still made aware of the theme.

These issues can if desired be incorporated into a narrative output. For example, if a curator is creating a template for a physical exhibition they may want to include notes about curatorial choices of placement related to their space, or mention an artist's specific instructions for installing a piece.

Storyspace creates linear narratives from which more complex interconnected narrative structures can be built. A Storyspace narrative can be turned into a handout, or an audio guide. It can be used in the process of authoring the curatorial narrative for a physical exhibition, or as a record of the layout and presented information of a physical exhibition. This in turn could be used for recording how a travelling exhibition differs between locations. Finally, the narrative can be used as the basis for create an online exhibition, giving the user flexibility to explore the story plot and narrative for themselves as well as providing access to additional content that may be unavailable in the physical space. The narrative ontology component is compatible with outputting the narrative structure and object descriptions in a METS (Metadata Encoding and Transmission Standard) compatible form, although the export is not yet implemented.

5.1 Technical architecture of storyspace

Storyspace is written in Drupal and uses an SQL database. In addition, content is written to a Sesame triple store according to the associated curate ontology. Custom Drupal modules have been developed to provide the core functions of Storyspace, these modules replicate the underlying curate ontology. Exhibit/Simile [31] are used for creating the visualisations, additional custom functionality has been written to allow plot structures to be entered and edited directly from a timeline view.

6. Future Work

Future work will focus on the inclusion of heuristics to suggest which organizational principle to use, based on how the events of the story have been annotated by facets or grouped into plots. Heuristics will aim at suggesting an organising principle based on minimizing plot disruption and maintaining temporal ordering. The interface for creating narratives will be extended to allow the curator to combine facet ordering, with plot ordering on multiple levels to create more complex narratives, as described in section 4.6.

Work will also look at flagging possible conflicts to curators, for example where an object appears in more than one plot, and suggest ways to solve the conflict, such as using the object to transition between plots, or to add a hyperlink or marker depending on whether the narrative is intended for an online or physical space. The narrative module will be extended to allow the output of the narrative framework as a METS description for to allow online browsing of the narrative structure. Further evaluation is scheduled in which curation teams will each select a topic of interest and author stories plots and narratives using Storyspace. Initial support will be given during a workshop, followed by a period of supported working at a distance, where the curation teams will keep user diaries of their issues and progress. Support will be via email and telephone contact. A workshop will be held after this period to elicit further feedback. In the second phase, student groups, supported by their regular teachers, will explore the stories created by the curation teams in the first evaluation stage and use these to construct their own narratives.

7. Conclusions

This paper presents an approach for creating narratives from the stories and plots of museum exhibitions. Authors can influence the shape and impact of a narrative by selecting different organising principles for the events within a story. On the story level, events are organized by facets, such as time or theme. The introduction of plot allows authors to add and alter the dramatic impact of a narrative, by choosing when to introduce and when to resolve plots. Storyspace supports a curator in describing the objects and stories of an exhibition from which they can select the parameters to create a narrative structure. The narrative elements within the structure are re-orderable and editable, new narrative Drupal nodes can be easily added. Therefore, the narrative is fully customizable towards the intended audience or narrative output medium. The narrative module can be used to create multiple curatorial narratives from an exhibition, for catalogues and handouts, for online viewing or within a museum space, for different audiences from school children to art professionals, and in different forms such as audio guides, text presentation or heritage objects only.

8. ACKNOWLEDGMENTS

This work is being conducted as part of DECIPHER, an EU Framework Programme 7 project in the area of Digital Libraries and Digital Preservation.

9. REFERENCES

- [1] Mulholland, P., Wolff, A., Collins, T., and Zdrahal, Z. 2011. An event-based approach to describing and understanding museum narratives. In: *Detection, Representation, and Exploitation of Events in the Semantic Web*. Workshop in conjunction with the International Semantic Web Conference.
- [2] Chatman, S. 1980. *Story and Discourse: Narrative structure in fiction and film*. Cornell U.
- [3] Polkinghorne, D. 1988. *Narrative knowing and the human sciences*. State Univ. NY Press.
- [4] Hazel, P. 2008. Narrative and New Media. In: *Narrative in Interactive Learning Environments*.
- [5] Aristotle. 1996. *Poetics*. Penguin Classics.
- [6] Berman, R. A., and Slobin, D. I. 2003. *Relating events in narrative: Typological and Contextual Perspectives*. Psychology Press.
- [7] Walker, J. 1999. Piecing together and tearing apart: finding the story in afternoon. *Hypertext 1999*, Darmstadt, Germany.
- [8] Szlias, N. 1999. Interactive drama on the computer: beyond linear narrative. *AAAI Fall Symposium on Narrative Intelligence*, Technical Report FS-99-01, AAAI Press.
- [9] Hargood, C., Millard, D., and Weal, M. 2010. A Semiotic Approach for the Generation of Themed Photo Narratives. *Hypertext 2010*, Toronto, Canada.
- [10] Wolff, A., Mulholland, P., Zdrahal, Z. and Joiner, R. 2007. Re-using digital narrative content in interactive games. *International Journal of Human-Computer Studies*, 65, 3, pp. 244-272.
- [11] Pearce, S. M. 1995. *On collecting: An investigation into collecting in the European tradition*. Routledge: London.
- [12] Peponis, J., Dalton, R., Wineman, J., and Dalton, N. 2003. Path, theme and narrative in open plan exhibition settings, *International Space Syntax Symposium*.
- [13] Rowe, S., Wertsch, J., and Tatyana, K. 2002. Linking Little Narratives to Big Ones: Narrative and Public Memory in History Museums. *Culture and Psychology*, 16 (2), pp. 96-112.
- [14] Nilsson, T. 1997. The Interface of a Museum: Text, Context and Hypertext in Performance Setting. *Archives and Museum Informatics*, Le Louvre, Paris, France.
- [15] Shneiderman, B. 1987. User interface design for the Hyperties electronic encyclopedia. *Hypertext '87 Workshop*, Raleigh, North Carolina, 199-204.
- [16] Fresta, G., and Signore O. 1993. A hypertext for an interactive visit to a science and technology museum. (Lees, Diane, Ed.). *Museums and Interactive Multimedia: Selected papers from the second International Conference on Hypermedia and Interactivity in Museums*.
- [17] MacKenzie, D. 1996. Beyond Hypertext: Adaptive Interfaces for Virtual Museums, *Proceedings of EVA'96*, Vasari Enterprises.
- [18] O'Donnell, M., Mellish, C. Oberlander, J., and Knott, A. 2001. "ILEX: An architecture for a dynamic hypertext generation system". *Natural Language Engineering* 7, 225—250.
- [19] <http://www.europeana.eu/portal/>
- [20] <http://www.freebase.com/>
- [21] <http://www.peoplesnetwork.gov.uk/discover/simple>
- [22] Wang, Y., Aroyo, L. and Stash, N. 2007. Interactive User Modeling for Personalized Access to Museum Collections: The Rijksmuseum Case Study. In: *User Modeling*.
- [23] Wang, Y., Aroyo, L. and Stash, N. 2009. Cultivating Personalized Museum Tours Online and On-site. In: *Interdisciplinary Science Reviews*, 32 (2), pp. 141-156.
- [24] van den Akker, C., Legêne, S. van Erp, M., Aroyo, L. Segers, R. van der Meij, L., van Ossenbruggen, J. Schreiber, G., Wielinga, B., Oomen, J., and Jacobs, G. 2011. Digital hermeneutics: Agora and the online understanding of cultural heritage. In *ACM Web Science Conference '11*, Koblenz.
- [25] Hyvönen, E., Makela, E., and Kauppinen, T. 2009. CultureSampo: A national publication system of cultural heritage on the semantic Web 2.0. In: *ESWC*.
- [26] Hyvönen, E., Palonen, T., and Takala, J. 2010. Narrative semantic web - Case National Finnish Epic Kalevala. In: *7th Extended Semantic Web Conference*.
- [27] Mulholland, P., Collins, T. and Zdrahal, Z. 2005. Bletchley Park Text. In: *Journal of Interactive Media in Education*, <http://jime.open.ac.uk/2005/24>.
- [28] <http://storify.com/>
- [29] <http://bagtheweb.com/bagstream>
- [30] Hooper-Greenhill, E. 2000. *Museums and the Interpretation of Visual Culture*. London: Routledge.
- [31] <http://simile.mit.edu/wiki/Exhibit>