



TITLE:

<Preliminary>Strength and Deformation of Semi-Rigid Timber Frames Depending on the Embedment Resistance of Timber

AUTHOR(S):

KATO, Yasuyo; KOMATSU, Kohei

CITATION:

KATO, Yasuyo ...[et al]. <Preliminary>Strength and Deformation of Semi-Rigid Timber Frames Depending on the Embedment Resistance of Timber. Wood research : bulletin of the Wood Research Institute Kyoto University 2000, 87: 39-41

ISSUE DATE:

2000-09-30

URL:

<http://hdl.handle.net/2433/53151>

RIGHT:

Strength and Deformation of Semi-Rigid Timber Frames Depending on the Embedment Resistance of Timber

Yasuyo KATO*^{1,*2} and Kohei KOMATSU*²

(Received May 31, 2000)

Keywords : timber wedges, static push-pull cyclic loading test, embedment

Introduction

Our traditional timber structures are sorts of “moment-resisting frame structures”. Strength and rigidity of such timber frames mainly depend on the embedment resistance and the shear resistance of timber which come out from wood to wood contact at column-beam (“Nuki”) joints.

The role of wedges in such column-beam (“Nuki”) joints, however, has not been clear up to date. Optimum angle of wedges, optimum insert-depth of wedges, and optimum mechanical properties of wedges have been depending on the experiences and traditions of carpenters or/and instructors.

In this study, we intended to make the role of wedges in column-beam (“Nuki”) joints more clear based on the concept in modern timber engineering. As for the first step, embedment tests for the triangle wedge specimens were done in Part-I¹⁾, the push-pull static cyclic loading tests for column-beam (“Nuki”) cross specimens were done in Part-II²⁾ for verifying our assumption proposed in Part-I.

Materials and Methods

Part-I : the dimensions of the triangle wedge specimens (Hinoki/Keyaki/Moabi) were 30 mm width, 60 mm length and the angle of inclination is 5°/10°/15°, respectively. Table 1 shows basic physical properties of wedge materials used in the test of Part-I.

The embedment tests on several kinds of timber wedges were done by using the jig made of the steel which presumed the 120×120 mm column. “Bearing constant k_e ” and “embedment stress σ ” were derived from these test as shown in Fig. 1.

By using the embedment characteristics obtained from the embedment test mentioned above, the optimum insert-depths of wedges was estimated mathematically as follows : Fig.2 shows both initial stage of column-beam (“Nuki”) joint where wedge is inserted by the amount of d at first then it was inserted further by D as the optimum amount.

From Fig. 2, following relationships are obtained.

$$d = \frac{h_0 - t_1}{\tan \theta} \quad (1)$$

$$D = \frac{h_0 - t_1 + e_0}{\tan \theta} \quad (2)$$

*¹ Present address : POLUS R & D Center of Life-Style Inc.

*² Laboratory of Structural Function.

Table 1. Basic physical properties of wedge materials used in the test of Part-I.

	MOE [GPa]	TD [kg/m ³]	MC [%]
HINOKI			
Ave.	9.01	511	10.7
Stdev	1.83	27	0.7
Cv	1.62	23	0.7
No. of data	113	113	98
KEYAKI			
Ave.	9.91	668	10.0
Stdes	1.76	79	1.1
Cv	17.74	12	11.1
No. of data	114	114	111
MOABI			
Ave.	12.80	760	11.2
Stdes	0.56	14	0.3
Cv	0.57	14	0.3
No. of data	98	98	98

MOE : Modulus of elasticity by 3-points bedding. TD : Timber density in the corresponding MC. MC : Moisture content by oven dry method.

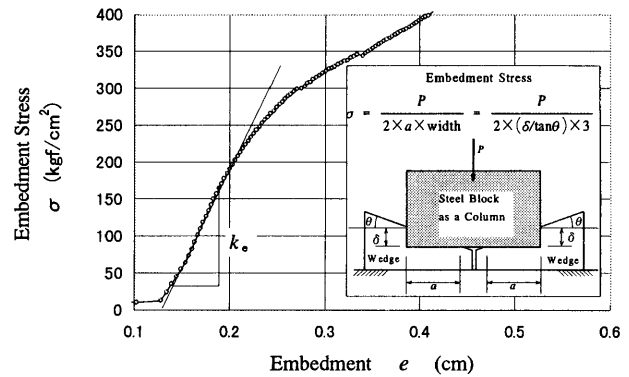

Fig. 1. An example of embedment stress σ and embedment e relationship.

From equations (1), (2), we get (3)

$$a = D - d = \frac{e_0}{\tan \theta} \quad (3)$$

Here, we assumed that the mean contact stress σ_c between column and wedge (Fig. 2) should not be exceeded the proportional limit σ_{e0} measured in the embedment tests so as to be kept in elastic range, if so wedge might be able to

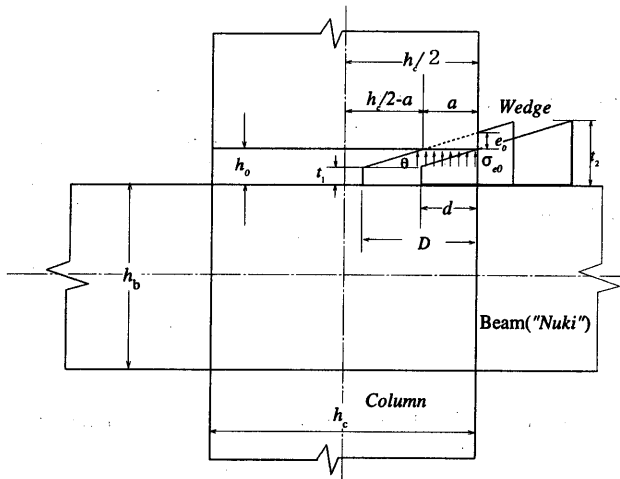

Fig. 2. Estimation of the optimum insert-depth of wedge.

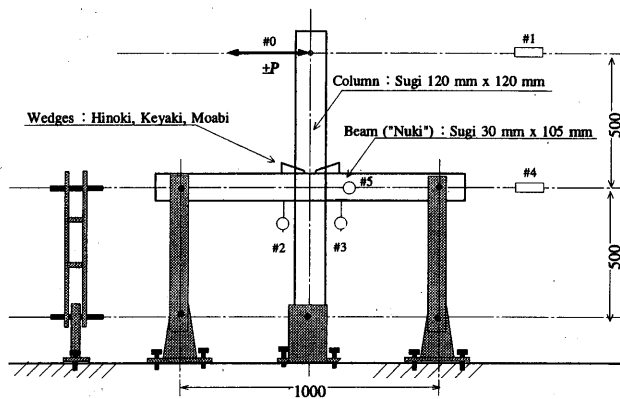

Fig. 3. Column-beam (“Nuki”) cross specimens.

be used again without any fatal plastic deformation. From this assumption, we obtained the initial optimum contact length “a” as (4)

$$a = \frac{\sigma_{e0}}{k_e \tan \theta} \quad (4)$$

$$\therefore \sigma_{e0} = k_e e_0, \quad e_0 = a \tan \theta$$

By putting (3)=(4), we could get the optimum insert-depth D as (5)

$$D = \left\{ \left[\frac{\sigma_{e0}}{k_e} \right] + (h_0 - t_1) \right\} \frac{1}{\tan \theta} \quad (5)$$

Part-II: column-beam (“Nuki”) cross specimens was made by using the 120×120×1,200 mm column (Sugi), the 30×105×1,200 mm beam (Sugi) and the wedge material in the same as Part-I as shown in Fig. 3.

Table 2 shows basic physical properties of materials used for beam-column cross test specimens in the Part-II.

A static push and pull cyclic loading test was done to evaluate how the optimum insert-depths of wedges affect on the structural performance of the column-beam joint. The insert-depth of wedges assigned in the experiment were as follows; optimum one (B), 1/2 times of the optimum one (05B) and 2 times of the optimum (2B).

Table 2. Basic physical properties of materials used for beam-column cross test specimens in the Part-II.

	E_f [GPa]	TD [kg/m ³]	MC [%]
COLUMN (SUGI)			
Ave.	7.66	532	32.4
Stdev	1.37	112	11.7
Cv	17.88	21	35.9
No. of data	81	81	81
NUKI (SUGI)			
Ave.	7.56	434	24.9
Stdev	1.26	44	9.4
Cv	16.68	10	37.8
No. of data	81	81	81
WEDGE (HINOKI)			
Ave.	13.11	552	13.9
Stdev	0.80	9	3.7
Cv	0.61	0.2	2.7
No. of data	54	54	54
WEDGE (KEYAKI)			
Ave.	12.87	648	3.8
Stdev	0.34	14	1.4
Cv	0.26	0.2	3.7
No. of data	54	54	54
WEDGE(MOABI)			
Ave.	15.92	688	4.8
Stdev	0.27	18	—
Cv	0.17	0.3	—
No. of data	54	54	1

E_f : Young’s modulus by Tapping method. MC: Moisture content by an electric MC meter.

Result and Discussion

Fig. 4 shows a typical example of moment at joint M and rotational angle θ relationship at column-beam (“Nuki”) joint. From this figure, it is obvious that the hysteresis loop of “Nuki” joint shows so-called “origin oriented shape” which means moment-rotation relationship tends to pass the origin always.

Fig. 5 shows an example how the wedge species affect on M- θ relationship of the column-beam joint.

Keyaki and Moabi wedges showed better performance not only in stiffness but also for the ultimate moment capacity compared with Hinoki wedge. It means that

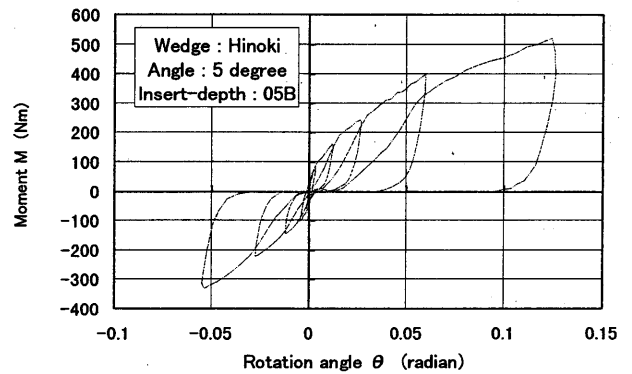

Fig. 4. Typical M- θ relationship of cross specimen.

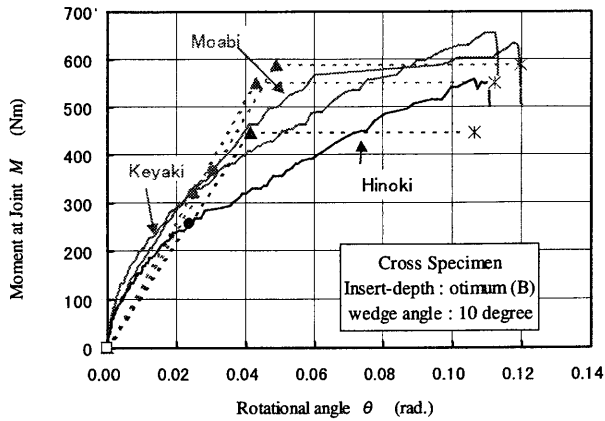

Fig. 5. Different $M-\theta$ relationship depending on the wedge species.

hardwood wedge has an advantage for wedge material than softwood one.

Fig. 6 shows the effect of insert-depth on $M-\theta$ relationship in the case of Hinoki wedge with angle of 5 degree.

Fig. 6 shows that in the case of Hinoki wedge of 5 degree angle, higher ultimate moment were obtained when the optimum insert-depth was assigned, and this example proved that our assumption mentioned above was right.

This trend was held good in case of 5 and 10 degree angle for all wedge species, while in the case of 15 degree, inverse result was obtained.

This is probably because, when the angle of wedges becomes higher (high rise), the optimum insert-depth of wedges becomes smaller thus wedges tend to rotate and behave unstable when cyclic deformation becomes larger.

On the other hand, when the angle of wedges is lower, thus the optimum insert-depth of wedges becomes larger, so that stable fit among wedges, beam and column could be obtained.

Fig. 7 shows an example of the relationship between

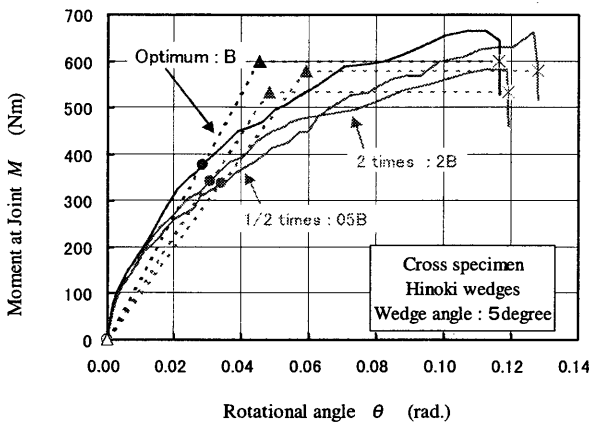

Fig. 6. Effect of insert-depth on $M-\theta$ relationship.

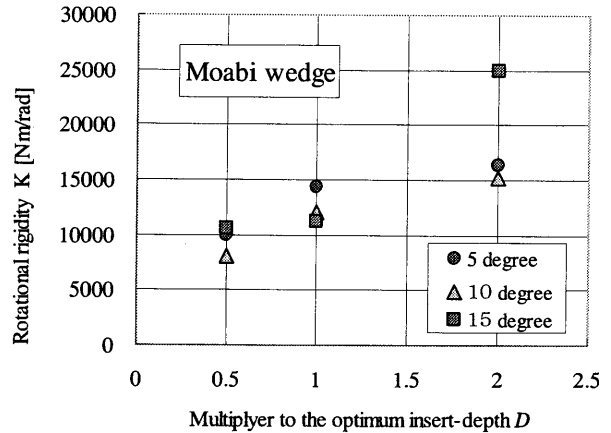

Fig. 7. Example of relationship between initial rotational rigidity $K (=M/\theta)$ and amount of insert-depth D .

initial rotational rigidity $K (=M/\theta)$ and amount of the insert-depth D in the case of Moabi wedge.

Fig. 7 shows that the initial rotational rigidity K is proportional to the insert-depth D . Therefore if it is desired to get only higher initial stiffness for column-beam (“Nuki”) joint, you may insert wedges as deeply as two times of the optimum value, but such tight contact might bring unfeasible result for ultimate moment capacity as shown in the result of Fig. 6.

In all specimen tested, real maximum load (means collapse load) couldn’t be obtained because of the limitation of the oil jack stroke. Therefore, a consideration couldn’t be done about the ductility of the joints which was thought to be the most characteristic aspect of traditional column-beam (Nuki) joint.

Conclusion

Test results on column-beam (“Nuki”) joints showed that the highest ultimate moment capacity was obtained in the case where the optimum insert-depth with relatively low rise wedges were used. While, higher initial stiffness was observed in the joints where insert-depth was doubled and also in the case of hard wood wedges were used. High rise wedge tends to turn off as the rotation angle becomes large, thus relatively low rise wedges (5 to 10 degree) were thought to be suitable for getting higher moment capacity and sufficient ductility because such combination can ensure more stable contact among wedges, column and beam (“Nuki”).

References

- 1) Y. KATO and K. KOMATSU: p. 235, Abstracts of the 49th Annual Meeting of the Japan Wood Research Society, Tokyo (1999).
- 2) Y. KATO and K. KOMATSU: p. 351–352, Summaries of Technical Papers of Annual Meeting Architectural Institute of Japan, C-1, Structure III, Tohoku, (September) (2000).