

Quelle:

Organotin compounds

Topics in current chemistry 104

1982

## Structure and Reactivity of Monomeric, Molecular Tin(II) Compounds

Michael Veith and Otmar Recktenwald

Institut für Anorganische Chemie der Technischen Universität, Braunschweig, FRG

### Table of Contents

|  |    |
|--|----|
| <b>1 Introduction</b> . . . . .  | 3  |
| <b>2 General Aspects of Low-Valency Elements</b> . . . . .                           | 3  |
| 2.1 The "Inert s-Pair Effect" . . . . .  | 3  |
| 2.2 Carbenes and Carbene Analogs . . . . .   | 5  |
| 2.3 Stabilization of Carbene Analogs . . . . .                                       | 6  |
| <b>3 General Structural Aspects of Tin(II) Chemistry</b> . . . . .                   | 7  |
| 3.1 Comparison between Structures of Sn(II) and Sn(IV) Compounds . . . . .           | 7  |
| 3.2 The Stereochemical Effect of the Lone Electron Pair at Tin(II) . . . . .         | 8  |
| 3.2.1 Coordination Polyhedra . . . . .   | 9  |
| 3.2.2 Correlation between Tin-Ligand Distances and<br>Coordination Numbers . . . . . | 13 |
| <b>4 Syntheses and Structures of Molecular Tin(II) Compounds</b> . . . . .           | 16 |
| 4.1 Synthetic Routes to Molecular Tin(II) Compounds . . . . .                        | 16 |
| 4.2 Structures of Molecular Tin(II) Compounds . . . . .                              | 18 |
| <b>5 Conclusions from Chapters 3 and 4</b> . . . . .                                 | 25 |
| <b>6 Reactions of Stannylenes SnX<sub>2</sub></b> . . . . .                          | 27 |
| 6.1 SnX <sub>2</sub> Reacting as a Lewis Acid . . . . .                              | 28 |
| 6.1.1 Formation of Simple Adducts . . . . .  | 28 |
| 6.1.2 Displacement Reactions . . . . .   | 29 |
| 6.2 SnX <sub>2</sub> Reacting as a Lewis Base . . . . .                              | 30 |
| 6.2.1 Formation of Adducts with Main-Group Acids . . . . .                           | 30 |
| 6.2.2 Coordination with Transition Metals . . . . .                                  | 31 |
| 6.3 Insertion Reactions of Stannylenes (Oxidative Addition) . . . . .                | 34 |
| 6.3.1 Addition to Single Bonds . . . . .   | 34 |
| 6.3.2 Addition to Double Bonds . . . . .   | 37 |

|   |    |
|---|----|
| 6.4 Reactions of Stannylenes with Participation of Ligands . . . . .                | 39 |
| 6.4.1 $\text{SnX}_2$ Displaying Dihapto-Ligand Properties . . . . .                 | 39 |
| 6.4.2 Ligand-Exchange Reactions . . . . .   | 40 |
| 6.4.3 Ligand Substitution . . . . .   | 41 |
| 6.5 Reactions with Stannylenes $\text{SnX}_2$ Displaying Trihapto-Ligand Properties | 43 |
| 6.5.1 Formation of Adducts . . . . .  | 43 |
| 6.5.2 Synthesis of Iminostannylenes and Related Compounds . . . . .                 | 46 |
| 6.6 Interaction of Stannylenes with Light . . . . .                                 | 50 |
| 7 References . . . . .  | 51 |

## 1 Introduction

As it is well-known, the element tin is often used as a hetero-atom in organic chemistry as well as in organo-metallic or molecular inorganic chemistry. Many reactions can be performed with the assistance of this element as described in W. P. Neumann's classical book <sup>1)</sup>. While inorganic chemists have been familiar from the very beginning with the two possible stable oxidation states of tin (+II and +IV), the main activity in molecular chemistry has for a long time been focused on the oxidation state +IV. Only in the last decade has considerable attention been paid to molecular tin(II) compounds and extensive progress has been performed in this field. This fact is also well illustrated in review articles: fifteen years ago only a small number of them were known, the most relevant being those of O. M. Nefedov and M. N. Manakov <sup>2)</sup> and especially of J. D. Donaldson <sup>3)</sup>. In the meantime, new results of studies on the structure of tin compounds have been collected and discussed by P. G. Harrison <sup>4)</sup>, J. A. Zubieta and J. J. Zuckerman <sup>5)</sup>; a bibliography on the structures has been published by P. A. Cusack et al. <sup>6)</sup>, and the syntheses and reactions of some organic derivatives of tin(II) have been compared by W. P. Neumann <sup>7)</sup> and J. W. Connolly and C. Hoff <sup>8)</sup>. The electronic properties of carbene analogs have been analyzed by O. M. Nefedov et al. <sup>9)</sup> while ring and cage compounds have been described by M. Veith <sup>10)</sup>.

This article is an attempt at evaluating new important features of tin(II) chemistry: the central point is the interrelationship between molecular structure and reactivity of molecular tin(II) compounds. To define these compounds more closely, only those are discussed which are stable, monomeric in solvents and which may be classified as carbene analogs <sup>2)</sup>. Thus, not a complete survey of tin(II) chemistry is given but stress is laid on the structures and reactions of selected compounds. A general introduction to the subject precedes the main chapters. For comparison, also solid-state tin(II) chemistry is included to demonstrate the great resemblance with molecular tin(II) chemistry. Tin(II) compounds, which are either generated as intermediates or only under definite conditions such as temperature or pressure, are not described in detail.

## 2 General Aspects of Low-Valency Elements

### 2.1 The "Inert s-Pair Effect"

In books on inorganic chemistry, the marked increase in the stability of the lower oxidation state (by two units) of heavier elements descending the main groups of the periodic Table is often explained by the "inert s-pair effect" (see J. E. Huheey <sup>11)</sup>). For example, elements like In and Sn may use only 1 or 2 electrons for the formation of bonds instead of 3 or 4 (group number), leaving one electron pair in the outer valence shell "inert". The electron pair is assumed to occupy an s-orbital. This classification does not very much contribute to the understanding of bonding; first

Table 1. Ionization energies (eV) of s electrons <sup>11)</sup>

| Element | IE <sub>2</sub> + IE <sub>3</sub> | Element | IE <sub>3</sub> + IE <sub>4</sub> |
|---------|-----------------------------------|---------|-----------------------------------|
| B       | 63.1                              | C       | 112.1                             |
| Al      | 47.2                              | Si      | 78.6                              |
| Ga      | 51.2                              | Ge      | 79.9                              |
| In      | 46.9                              | Sn      | 71.2                              |
| Tl      | 50.2                              | Pb      | 74.2                              |

of all, it is not certain whether the non-bonding electron pair really occupies a pure s-orbital (see also in Chapter 3). Secondly, when comparing the ionization energies of group III and IV elements (Table 1), there is no marked increase in the stability of s-electrons with rising atomic weight; a slight effect may be noticed with the elements Tl and Pb.

J. E. Huheey <sup>11)</sup> has proposed another explanation following the reasoning of R. S. Drago <sup>12)</sup>. If the enthalpies of the reaction

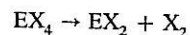

are compared using some halides of group IV elements (Table 2), it is quite obvious that the reaction proceeds more easily with heavier elements (enthalpies becoming less positive!). This effect is reflected by a gain of bond energy when the element passes from the higher oxidation state to the lower one (Table 3). This, of course, means that the halogen atoms are more strongly bound to the metal atom in the low-valence state. Disregarding the different electronegativities in the two oxidation states, two reasons may account for an extra stabilization of the bonds at lower oxidation number of the group IV element:

- 1) in the higher valence state the promotion energy  $s^2p^2 \rightarrow sp^3$  must be compensated;
- 2) heavier elements suffer from inner electron repulsions, which may weaken the bonds.

When changes in electronegativity are taken into account (the element passing from the higher oxidation number to the lower one) another stabilization effect should be added to the two already mentioned. As can be seen in Chapter 3, the element in the lower oxidation state is always more electropositive: the covalent bond between the central atom and the usually more electronegative ligand will become more polar and will therefore be reinforced by a superimposed ionic component. On the other side, the bond lengths in comparable compounds are longer for lower oxidation states!

Table 2. Enthalpies (kJ/mol) of the reaction:  $\text{EX}_2 \rightarrow \text{EX}_4 + \text{X}_2$  <sup>11)</sup>

| X=        | F    | Cl   | Br   | I    |
|-----------|------|------|------|------|
| Element E |      |      |      |      |
| Ge        | +695 | +381 | +260 | +167 |
| Sn        | +544 | +276 | +243 | +142 |
| Pb        | +385 | +121 | +88  | +17  |

Table 3. Bond energies (kJ/mol) of  $\text{EX}_2$  and  $\text{EX}_4$  <sup>11)</sup>

| Compound  | EF <sub>2</sub> | EF <sub>4</sub> | ECl <sub>2</sub> | ECl <sub>4</sub> |
|-----------|-----------------|-----------------|------------------|------------------|
| Element E |                 |                 |                  |                  |
| Ge        | 481             | 452             | 385              | 354              |
| Sn        | 481             | 414             | 386              | 323              |
| Pb        | 394             | 331             | 325              | 243              |

To sum up, it is clear that heavier elements tend to achieve an oxidation number which is by two units lower than the group number. On the other side, a straightforward explanation for this phenomenon is hard to find.

## 2.2 Carbenes and Carbene Analogs

A very useful class of intermediates in synthetic organic chemistry are carbenes ( $\text{CX}_2$  (X = H, R, F, Cl, Br etc.) <sup>13)</sup>). These molecules are typical representatives of molecular, monomeric, highly reactive and electronically unsaturated compounds. Their main characteristics are the following:

- 1) there are only six electrons in the valence shell;
- 2) one electron pair is non-bonding.

The non-bonding electron pair may occupy one orbital with antiparallel spins (singlet,  $^1\sigma^2$ ), or two different orbitals with antiparallel (singlet,  $^1\sigma p$ ) or parallel spins (triplet,  $^3\sigma p$ ).

It has become common to classify all *molecular* compounds, which fulfill the above characteristics, as carbene analogs <sup>9,13)</sup>. As a consequence, compounds of divalent silicon, germanium, tin, and lead may be regarded as carbene-like and are therefore called silylenes, germynes, stannylenes, and plumbylenes. In contrast to carbenes they have one property in common: the energetically most favorable electronic state is the singlet  $^1\sigma^2$  found by experiments and calculations <sup>9)</sup>.

There are two possibilities to describe the structure of these singlet carbene analogs:

- 1) The non-bonding electron pair occupies an s-orbital, the bonding electrons occupy p-orbitals, while the third p-orbital remains empty. The bonding angle should be strictly 90° (geometry A).
- 2) Both non-bonding and bonding electron pairs occupy  $sp^2$ -hybrid orbitals while again a p-orbital is unoccupied. In this case, the bonding angle should be 120° (geometry B).

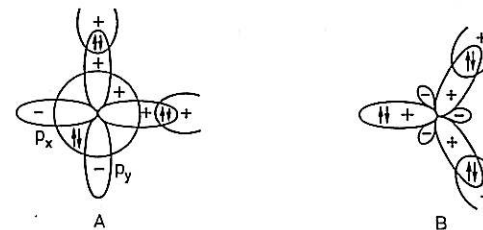

Table 4. Bond angles ( $^{\circ}$ ) in  $EX_2$  <sup>9)</sup>

| Compound          | Angle X—E—X | Compound          | Angle X—E—X |
|-------------------|-------------|-------------------|-------------|
| SiF <sub>2</sub>  | 100–101     | SnF <sub>2</sub>  | 92–95       |
| SiCl <sub>2</sub> | 104–105     | SnCl <sub>2</sub> | 95          |
| GeF <sub>2</sub>  | 94–97       | PbF <sub>2</sub>  | 90–95       |
| GeCl <sub>2</sub> | 95–107      | PbCl <sub>2</sub> | 95          |

When experimentally determined bond angles of carbene analogs are compared, the values are found to be in between these two possibilities; Table 4 lists the bond angles of some halides in the vapor phase as determined mostly from electron diffraction or vibrational and rotational spectra. With increasing atomic number of the central atom, the angles seem to approach  $90^{\circ}$ . This may be explained by either a steric effect or the more pronounced hybridization in lighter elements. Referring to the theoretical angles of models A and B the deviation found is often accounted for by repulsion forces between the ligands (model A) or repulsion between the lone pair and the ligands in model B <sup>14)</sup>. For heavy elements model A seems to be more important, and we should expect divalent tin compounds to have this geometry. As can be seen in Chapter 4, this is the case for all tin compounds known so far. At the same time, it should be concluded that the non-bonding electron pair at the central tin atom exhibits no stereochemical activity because it is located in a radially distributed s-orbital. Structures of solid tin(II) compounds clearly demonstrate the contrary (see Chapter 3). We must therefore assume that the s-orbital must be mixed with energetically favorable orbitals, allowing a deviation from a spherical shape <sup>15,16)</sup>.

It should be clear by the definition given so far that the carbene-analogous state is limited to molecular species. The oligomer of  $EX_2$  ( $EX_2$ )<sub>n</sub> is, of course, much more stable than  $|EX_2$  in every respect. It should nevertheless be noted that also the oxidation number does not change in going from the monomer to the polymer the chemical, structural, and electronic properties of these species are completely different.

### 2.3 Stabilization of Carbene Analogs

The stability of molecules depends in the first place on limiting conditions. Small, mostly triatomic silylenes and germylenes have been synthesized successfully at high temperatures and low pressures <sup>17,18)</sup>. Their reactions can be studied by warming up the frozen cocondensates with an appropriate reactant, whereas their structures are determined by matrix techniques <sup>17,18)</sup>. In addition, reactions in the gas phase or electron diffraction are valuable tools for elucidating the structures and properties of these compounds. In synthetic chemistry, adequate precursors are often used to produce intermediates which spontaneously react with trapping reagents <sup>7)</sup>. The analysis of the products is then utilized to define more accurately the structure of the intermediate.

Neither of these two methods can be employed for the synthesis of stable carbene analogs at ambient temperature. Thus, the only possibility of preparing stable

molecules is to modify the properties of the carbene analogs by substitution at the central atom. Two general aspects seem to be important for all electron-deficient compounds:

- 1) lack of electrons at the central atom has to be compensated by electron-releasing groups;
- 2) the substituent should be as bulky as possible to prevent polymerization.

The second point is certainly the most important as seen in the case of the stannylenes (Chapter 4) while the first point needs some further discussion. The electron-releasing substituent may act via a simple inductive  $\sigma$ -effect (A) or via a mesomeric  $\pi$ -effect (B), or via both effects.

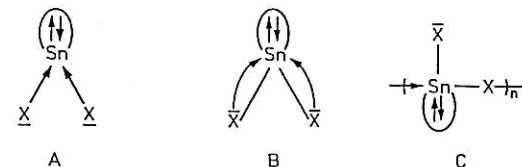

The intramolecular Lewis acid-base interaction of type B is of course always in competition with an intermolecular interaction, as indicated by formula C. Again, a bulky group in  $\alpha$ -position to X can favor the formation of monomer B.

## 3 General Structural Aspects of Tin(II) Chemistry

### 3.1 Comparison between Structures of Sn(II) and Sn(IV) Compounds

The major difference between structures of tin(II) and tin(IV) compounds (which may be ionic or covalent) can be seen in the coordination sphere of the tin atom. While tin(II) compounds are mostly bent, pyramidal or otherwise distorted, tin(IV) compounds adopt regular geometries as tetrahedra, bipyramides or octahedra, depending on the coordination number. The reason for this phenomenon may readily be explained by the different electronic states: while in tin(IV) compounds all outer electrons of the tin atom are engaged in bonding, tin(II) compounds have one electron pair that does not participate in bonding (see Chapter 2) and displays stereochemical activity. We can consider this electron pair as a further ligand in the coordination sphere of the tin atom. There are only few tin compounds where the lone pair is not stereochemically active. For example, in the cubic form of SnSe and in SnTe the tin atom is situated in the middle of a regular octahedron <sup>19)</sup>. It is remarkable that in these cases the cation is surrounded by easily polarizable anions.

According to Table 5, the electronegativity of tin changes with its oxidation number, the lower oxidation state being connected with a more electropositive character. It may be concluded that tin(II) compounds are more ionic than the

corresponding tin(IV) derivatives or — from another point of view — more electrophilic and thus more tightly coordinated by surrounding nucleophilic ligands.

While the covalent radius of Sn(IV) can easily be derived from grey tin ( $r(\text{Sn(IV)}) = 140 \text{ pm}$ ), it is much more difficult to evaluate the radius  $r(\text{Sn(II)})$ . R. E. Rundle and D. H. Olson<sup>20)</sup> proposed a value which is by 15–20 pm larger than that of tetravalent tin on the basis of solid tin(II) compounds. Since it is difficult to estimate the crystal effect in solid-state structures, we have compiled bond lengths of the corresponding tin compounds in Table 6 which have been determined, with the exception of one case, by electron diffraction measurements in the gas phase. Thus, the covalent radius of Sn(II)  $r(\text{Sn(II)})$ , can roughly be evaluated as  $150 \pm 3 \text{ pm}$  from this comparison. The larger  $r(\text{Sn(II)})$  radius as compared with  $r(\text{Sn(IV)})$  can be explained either by a repulsion effect of the lone electron pair at the tin atom or by a weaker  $\sigma$ -bond compared with tin(IV), the tin(II) atom utilizing exclusively p-orbitals for bonding.

Table 5. Comparison of electronegativities (EN)<sup>11)</sup>

| Oxidation State | EN (Pauling) | EN (Sanderson) |
|-----------------|--------------|----------------|
| Sn (II)         | 1.80         | 1.58           |
| Sn (IV)         | 1.96         | 2.02           |

Table 6. Bond distances Sn—X (pm) of molecules  $\text{SnX}_2$  and  $\text{SnX}_4$  in the gas phase

| Molecule $\text{SnX}_2$ | Sn—X      | Molecule $\text{SnX}_4$ | Sn—X      | Ref.            |
|-------------------------|-----------|-------------------------|-----------|-----------------|
| $\text{SnR}_2$ *)       | 2.28      | $\text{SnR}_4$ *)       | 2.17      | 21)             |
| $\text{SnCl}_2$         | 2.42–2.43 | $\text{SnCl}_4$         | 2.28–2.31 | 22, 23, 24, 25) |
| $\text{SnBr}_2$         | 2.55      | $\text{SnBr}_4$         | 2.44      | 22, 23, 26)     |
| $\text{SnI}_2$          | 2.73–2.78 | $\text{SnI}_4$          | 2.64      | 22, 23, 26)     |

\* R = organic ligand in the crystal

### 3.2 The Stereochemical Effect of the Lone Electron Pair at Tin(II)

In the preceding chapter it was shown that the coordination sphere around the tin atom is of paramount importance for the structure of tin(II) compounds. J. D. Donaldson<sup>3)</sup> was the first to convincingly demonstrate that the coordination polyhedra adopted by the tin atom are almost the same for a definite coordination number of the central atom despite the nature of the ligands attached to the latter. This means that a tin compound which might be classified as ionic displays a structure similar to a compound containing almost covalent bonds as far as the coordination geometry around the tin atom is concerned. We can illustrate this phenomenon with some exemplary compounds of opposite bonding type. At the same time we will generalize this approach and demonstrate the dependence of the bond length Sn—L on the coordination number n for almost any molecular or solid-state  $\text{SnL}_n$  compound.

#### 3.2.1 Coordination Polyhedra

In Fig. 1 are assembled the most important coordination polyhedra of tin(II) compounds omitting high coordination numbers which are difficult to illustrate. In Table 7 the corresponding bond angles characterizing the deviation from ideal

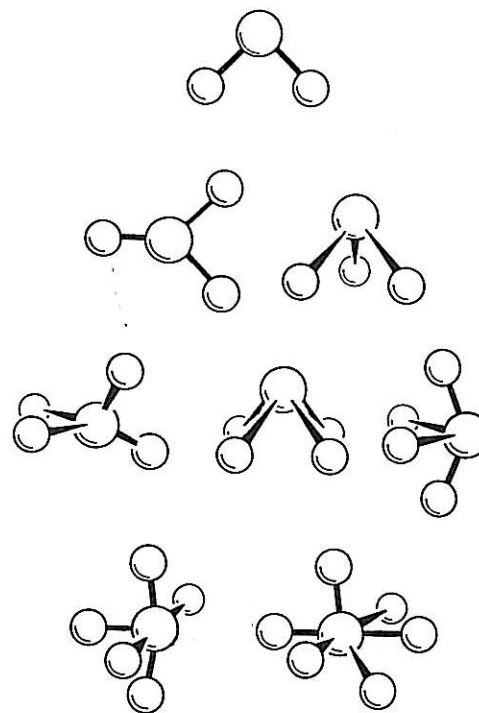

Fig. 1. Coordination polyhedra of the tin(II) atom for coordination numbers  $n = 2-6$ . The large circles represent tin atoms, while the smaller ones denote ligands (see also Table 7)

Table 7. Coordination numbers of important tin(II)-ligand arrangements

| c.n. | Coordination number          | Angles found (°)   | Most probable angles (°) |
|------|------------------------------|--------------------|--------------------------|
| 2    | $\psi$ -trigonal planar      | 73–96              | 90–95                    |
| 3    | trigonal planar              | $\Sigma = 360$     | 95; $2 \times 132.5$     |
|      | trigonal pyramidal           | 75–95              | 80–85                    |
| 4    | tetrahedral (distorted)      | 95–114             | 109                      |
|      | tetragonal pyramidal         | 70–90              | 75                       |
|      | $\psi$ -trigonal bipyramidal | 130–165;           | 157                      |
|      |                              | 80–95;             | 90                       |
| 5    | $\psi$ -octahedral           | $4 \times (60-86)$ | $4 \times 82$            |
|      | distorted octahedral         |                    |                          |

geometry or defining the pyramide are listed. The values have been taken from structures compiled in Tables 8-11.

The lowest possible coordination number 2 can only be realized in the case of tin(II) compounds which have bulky substituents preventing aggregation in the

Table 8. Mean Sn—N distances for different coordination numbers

| c.n. | Sn—N (pm) | c. Sphere and mean angle (°) | Compound   | Ref. |
|------|-----------|------------------------------|--|------|
| 2    | 209       | bent; 73.2 (cycle!)          | Sn(NCMe <sub>3</sub> ) <sub>2</sub> SiMe <sub>2</sub>                  | 27)  |
| 2    | 209       | bent; 96                     | Sn[N(SiMe <sub>3</sub> ) <sub>2</sub> ] <sub>2</sub>                   | 38)  |
| 3    | 220       | trigon. pyram., 81.3         | [Sn(NSiMe <sub>3</sub> ) <sub>2</sub> BMMe] <sub>2</sub>               | 39)  |
| 3    | 222       | trig. pyram., 80.5           | (Me <sub>3</sub> CN) <sub>3</sub> (Me <sub>3</sub> AlO)Sn <sub>4</sub> | 32)  |
| 3    | 223       | trig. pyram., 81.3           | Sn <sub>3</sub> (NCMe <sub>3</sub> ) <sub>4</sub> H <sub>2</sub>       | 40)  |
| 3    | 224       | trig. pyram., 86.5           | [Sn(NCMe <sub>3</sub> ) <sub>2</sub> SiMe <sub>2</sub> ] <sub>2</sub>  | 27)  |
| 4    | 225       | squa. pyram., 76             | phthalocyaninetin(II)  | 35)  |

Table 9. Mean Sn—O distances for different coordination numbers

| c.n. | Sn—O (pm) | c. Sphere and mean angle (°) | Compound   | Ref.    |
|------|-----------|------------------------------|--|---------|
| 2    | 200       | bent; 80.8                   | Sn[O—C <sub>6</sub> H <sub>2</sub> (CMe <sub>3</sub> ) <sub>2</sub> Me] <sub>2</sub>   | 28)     |
| 3    | 213       | trig. pyram., 89.6           | Sn <sub>3</sub> O(OH) <sub>2</sub> SO <sub>4</sub>   | 41)     |
| 3    | 214       | " 83.5                       | Ca[Sn(O <sub>2</sub> CMe) <sub>3</sub> ] <sub>2</sub>  | 42)     |
| 3    | 214       | " 86.3                       | Sn <sub>2</sub> (OH)PO <sub>4</sub>  | 43)     |
| 3    | 215       | " 86.1                       | Sn <sub>3</sub> (PO <sub>4</sub> ) <sub>2</sub>  | 44)     |
| 3    | 215       | " 90                         | SnFPO <sub>3</sub>   | 45)     |
| 3    | 216       | " 92                         | Sn <sub>10</sub> W <sub>16</sub> O <sub>46</sub>   | 46)     |
| 3    | 217       | " 84.4                       | SnHPO <sub>3</sub>   | 47)     |
| 3    | 217       | " 83.3                       | KSn(O <sub>2</sub> CCH <sub>2</sub> Cl) <sub>3</sub>   | 48)     |
| 4    | 221       | squa. pyram., 75             | SnO  | 3)      |
| 4    | 221       | ψ-trig. bipyram.             | Sn[OC(Ph)CHC(Me)O] <sub>2</sub>  | 37)     |
| 4    | 223       | "                            | Sn[OCH(Ph)CH <sub>2</sub> CH(Ph)O] <sub>2</sub>  | 49)     |
| 4    | 223       | squa. pyram., 76             | Sn <sub>6</sub> O <sub>4</sub> (OMe) <sub>4</sub>  | 50)     |
| 4    | 224       | ψ-trig. bipyram.             | Sn <sub>10</sub> W <sub>16</sub> O <sub>46</sub>   | 46)     |
| 4    | 224       | squa. pyram., 76             | K <sub>2</sub> Sn(C <sub>2</sub> O <sub>4</sub> ) · H <sub>2</sub> O   | 51)     |
| 4    | 227       | ψ-trig. bipyram.             | Sn(O <sub>2</sub> CH <sub>2</sub> ) <sub>2</sub>   | 52)     |
| 4    | 227       | "                            | Sn <sub>2</sub> O(OH) <sub>2</sub> SO <sub>4</sub>   | 41)     |
| 4    | 228       | "                            | α-SnWO <sub>4</sub>  | 36)     |
| 6    | 244       | "                            | [Sn <sup>IV</sup> Sn <sup>IV</sup> (O <sub>2</sub> CC <sub>6</sub> H <sub>4</sub> NO <sub>2</sub> ) <sub>4</sub> ] <sub>2</sub> · THF <sub>2</sub> | 53)     |
| 6    | 251       | dist. octahedr.              | β-SnWO <sub>4</sub>  | 54)     |
| 7    | 266       | —                            | Sn <sub>2</sub> (EDTA) · 2 H <sub>2</sub> O  | 55)     |
| 8    | 269       | —                            | Sn(H <sub>2</sub> PO <sub>4</sub> ) <sub>2</sub>   | 56)     |
| 8    | 272       | —                            | SnHPO <sub>4</sub>   | 47, 57) |
| 12   | 293       | —                            | SnSO <sub>4</sub>  | 58)     |

Table 10. Mean Sn—F distance for different coordination numbers

| c.n. | Sn—F (pm) | c. Sphere and mean angle (°) | Compound   | Ref. |
|------|-----------|------------------------------|--|------|
| 2    | 191       | bent, 94                     | SnF <sub>2</sub> (gas)                             | 59)  |
| 3    | 208       | trig. pyram. 82.4            | NH <sub>2</sub> SnF <sub>3</sub>                   | 31)  |
| 3    | 211       | " 83.3                       | SnF <sub>2</sub> (monoclinic)                      | 60)  |
| 3    | 215       | " 80.3                       | Sn <sub>2</sub> F <sub>3</sub> Cl                  | 61)  |
| 3    | 215       | " 81                         | Sn <sub>3</sub> F <sub>5</sub> Br                  | 62)  |
| 4    | 215       | ψ-trig. bipyram.             | KSnF <sub>3</sub> · $\frac{1}{2}$ H <sub>2</sub> O | 63)  |
| 4    | 217       | "                            | Na <sub>4</sub> Sn <sub>3</sub> F <sub>10</sub>    | 64)  |
| 4    | 218       | "                            | Sn <sub>2</sub> F <sub>6</sub> Br <sub>4</sub>     | 65)  |
| 4    | 223       | "                            | NaSn <sub>2</sub> F <sub>5</sub>                   | 66)  |
| 5    | 228       | —                            | SnF <sub>2</sub> (orthorhombic)                    | 67)  |

Table 11. Mean Sn—S distances for different coordination numbers

| c.n. | Sn—S (pm) | c. Sphere and mean angle (°) | Compound   | Ref.    |
|------|-----------|------------------------------|--|---------|
| 3    | 257       | trig. pyram., 95             | BaSnS <sub>2</sub>   | 68)     |
| 3    | 266       | " 90.7                       | SnS  | 20)     |
| 3    | 267       | " 86                         | Sn <sup>IV</sup> Sn <sup>IV</sup> S <sub>3</sub>                                 | 69)     |
| 4    | 269       | ψ-trig. bipyram.             | Sn(S <sub>2</sub> C—NEt <sub>2</sub> ) <sub>2</sub>                              | 70, 71) |
| 4    | 271       | "                            | Sn(S <sub>2</sub> C—OMe) <sub>2</sub>  | 72)     |
| 5    | 291       | —                            | Sn[S <sub>2</sub> P(OC <sub>6</sub> H <sub>5</sub> ) <sub>2</sub> ] <sub>2</sub> | 73, 74) |
| 7    | 302       | —                            | Sn <sub>2</sub> P <sub>2</sub> S <sub>6</sub>                                    | 75)     |
| 8    | 309       | —                            | Sn <sub>2</sub> P <sub>2</sub> S <sub>6</sub>                                    | 75)     |
| 8    | 311       | —                            | Sn <sub>4</sub> Sn <sup>IV</sup> Sb <sub>2</sub> S <sub>9</sub>                  | 76)     |

crystal. Actually, only two compounds are known to display this geometry in the solid state<sup>27, 28)</sup>:

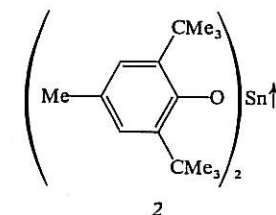
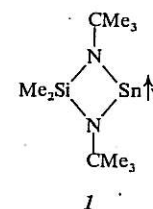

The structure of these typical stannylenes 1 and 2 are discussed in Chapter 4 as well as that of bis(pentamethylcyclopentadienyl)tin(II) (3) which does not aggregate either but contains two η<sup>5</sup>-bonded cyclopentadienyl ligands<sup>29)</sup>, the coordination number being difficult to establish.

For the coordination number 3, two different environments of tin(II) can be distinguished. One is the trigonal planar arrangement which is realized when the non-bonding electron pair at the tin atom is engaged in bonding, with tin acting as a Lewis base. The first example of this kind characterized by X-ray structural analysis is compound 4<sup>30)</sup> (for the structure see also Chapter 5).

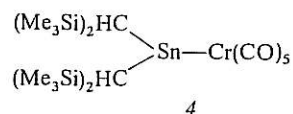

No ionic species with this special ligand arrangement around the tin atom has been reported so far.

Most tin(II) compounds display structures with a trigonal pyramidal coordination. This is of course to be expected as the tin atom is in the first place electrophilic in order to complete its outer electron configuration (cf. Chapter 5 and 6). To illustrate the resemblance of this geometry between ionic and molecular compounds, the structure of  $\text{NH}_4\text{SnF}_3$  (5)<sup>31)</sup> is compared with that of the cage compound  $(\text{Me}_3\text{CN})_3(\text{Me}_3\text{AlO})\text{Sn}_4$  (6)<sup>32)</sup>. The coordination sphere of the tin atom is the same in 5 and 6 (for the complete structure of 6 see Sect. 6.5):

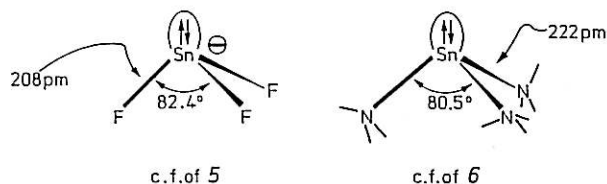

(c.f. stands for coordination fig.)

For the coordination number 4 three types of polyhedra have to be considered: a tetrahedron (distorted), a tetragonal pyramid, and a closely related  $\Psi$ -trigonal bipyramide.

The first coordination sphere is a special case. It can be generated from the trigonal planar arrangement by adding a further ligand, resulting a tin atom which simultaneously acts as an acid and a base. An illustrative example for this kind of bonding is compound 7<sup>33)</sup> in which the tin atom receives electrons from pyridine and transfers electrons to the chromium atom (see also Chapter 6).

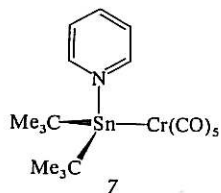

When in compounds of type 7 no discrimination can be made between acceptor and donor, one is confronted with molecules which may still possess tin atoms of the formal oxidation state +2 but which are structurally more related to tin(IV) compounds. Classical examples are polystannylenes  $(\text{SnR}_2)_n$  which may form six-membered rings as in  $(\text{Ph}_2\text{Sn})_6$  (8)<sup>34)</sup> (see also Chapter 4).

The square-pyramidal arrangement may be illustrated by two chemically very different compounds:  $\text{SnO}$  (9)<sup>3)</sup> and phthalocyaninetin(II) (10)<sup>35)</sup>:

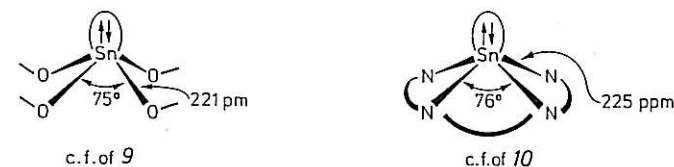

The resemblance of the coordination polyhedra in 9 and 10 is really amazing. The same is true for two  $\Psi$ -trigonal bipyramidal arrangements as a comparison of the ionic compound  $\alpha\text{-SnWO}_4$  (11)<sup>36)</sup> and the chemically completely different molecular complex  $\text{Sn}(-\text{OC}(\text{Ph})\text{CHC}(\text{Me})=\text{O})_2$  (12)<sup>37)</sup>, which contains two chelating acetylacetonato ligands, reveals.

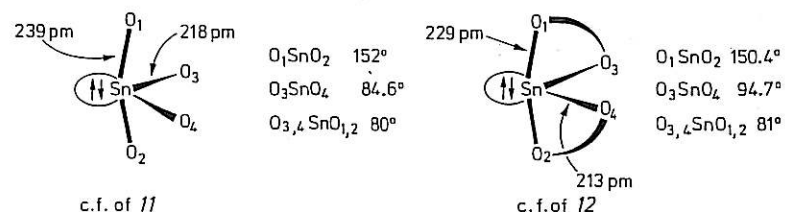

It may be noted that, as expected, the equatorial distances are shorter than the axial. There is, of course, a close relationship between the square-pyramidal and the  $\Psi$ -trigonal bipyramidal coordination sphere which are often difficult to discriminate when the tin-ligand bond distances in equatorial and axial positions do not differ significantly.

Some examples of higher coordination numbers of tin are cited in Tables 8–11. Since they are of minor importance in molecular tin(II) chemistry (except<sup>77, 78)</sup> they are not discussed here in detail (for a further description see also<sup>3–5)</sup>).

### 3.2.2 Correlation between Tin-Ligand Distances and Coordination Numbers

In Section 3.2.1 we have deduced the dependence of the geometries of tin-ligand arrangements on the coordination number. We will now study the distances between the tin(II) atom and the ligand when the coordination number is changed. In Tables 8–11 the mean distances between the central tin atom and four different "ligands" (N, O, F and S) are listed. As expected, these distances increase with rising

coordination number which is graphically illustrated in Fig. 2. Molecular as well as ionic compounds, with the same atom in  $\alpha$ -position to the tin atom, show similar tin-ligand distances.

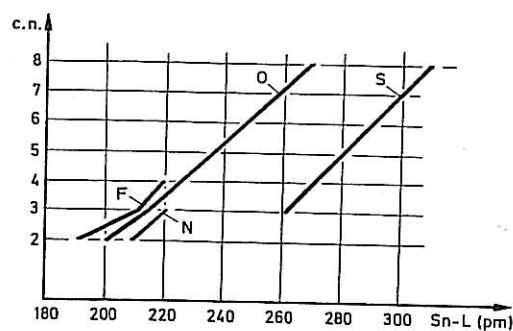

Fig. 2. Correlation between bond lengths and coordination numbers (c.n.). A mean value for each c.n. has been calculated from Tables 8-11; single value (except for c.n. = 2) have been omitted

The following points are important:

1) Tables 8-11 and Fig. 2 may be used to evaluate the coordination number in any tin(II) compound. It is well known that the correct coordination sphere of the structures of solid tin compounds is often difficult to determine. Not in every compound can a distinct difference in the tin-ligand distances around the central atom separating the first coordination sphere from the second one be found. Most of the compounds compiled in the tables have been selected with respect to a deviation of about 30% from the mean distance, according to the first coordination sphere. From Table 12 it follows that distances which are at the extremes of one coordination number (with respect to the mean value) can often be better reclassified by a different coordination number. For example,  $\text{SnSO}_4$ , a compound which is often described by a tin atom surrounded only by three oxygen atoms<sup>58)</sup> can be better represented by a coordination of 12 on the tin atom, according to Table 9. Another example is the recently synthesized  $\text{K}_2\text{Sn}_2\text{O}_3$  containing two tin atoms, each surrounded by three very narrow oxygen atoms ( $\text{Sn}(1)-\text{O} = 196 \text{ pm}$ ;  $\text{Sn}(2)-\text{O} = 209 \text{ pm}$ )<sup>79)</sup>; it follows from Table 9 that this compound cannot be classified in the usual way; the K cations seem to influence the Sn-O bonds considerably;

2) Taking the curves of oxygen, sulfur and fluorine in Fig. 2 as a reference it seems that a linear correlation can be established between the c.n. and the bond distances (c.n. running from 3 to 8). A rise of the c.n. by one unit increases the mean Sn-ligand distance by about 10 pm;

3) The stannylenes  $\text{SnF}_2$ ,  $\text{Sn}(\text{OX})_2$  and  $\text{Sn}(\text{NX}_2)_2$  have a remarkably smaller Sn-ligand distance than that resulting from a linear extrapolation of higher coordination numbers (crack in the linear curves of Fig. 2). This effect decreases in the order  $\text{F} > \text{O} > \text{N}$ . The differences in the tin-ligand distances between c.n. 2 and 3 are for F:  $\Delta = 20 \text{ pm}$ , for O:  $\Delta = 15 \text{ pm}$ , and for N:  $\Delta = 13 \text{ pm}$ . As the electronegativities decrease in the same order,  $\text{F} > \text{O} > \text{N}$ , it seems reasonable to explain this phenomenon by extra ionic components in the bonding of stannylenes.

Table 12. Synthetic routes to molecular tin(II) compounds

| $\text{X}_2\text{Sn}$  | Method according to Scheme 1 | Reactant  | Ref.        |
|--|------------------------------|---|-------------|
| $(\text{C}_2\text{H}_5)_2\text{Sn}$ , 13   | a                            | $2 \text{XNa} + \text{SnCl}_2$  | 82)         |
| $(\text{Me}_3\text{C}_2)_2\text{Sn}$ , 3   | a                            | $2 \text{XLi} + \text{SnCl}_2$  | 83)         |
| $[(\text{Me}_3\text{Si})_2\text{CH}]_2\text{Sn}$ , 14  | a                            | $2 \text{XLi} + \text{SnCl}_2$  | 84)         |
|  Sn, 15   | a                            | $2 \text{XLi} + \text{SnCl}_2$  | 85, 8)      |
| $[(\text{Me}_3\text{Si})_2\text{N}]_2\text{Sn}$ , 16   | a                            | $2 \text{XLi} + \text{SnCl}_2$  | 86, 87)     |
| $\text{Me}_2\text{Si}(\text{Me}_3\text{CN})_2\text{Sn}$ , 1                                  | a                            | $\text{XLi}_2 + \text{SnCl}_2$  | 88)         |
|  Sn, 17   | a                            | $2 \text{XLi} + \text{SnCl}_2$  | 89)         |
|  Sn, 2    | a                            | $2 \text{XLi} + \text{SnCl}_2$  | 28)         |
| $[(\text{Me}_3\text{C})_2\text{P}]_2\text{Sn}$ , 18  | a                            | $2 \text{XK} + \text{SnCl}_2$   | 90)         |
| $(\text{Et}_2\text{NCS}_2)_2\text{Sn}$ , 19  | a                            | $2 \text{XK} + \text{SnCl}_2$   | 91)         |
| $(\text{Me}_3\text{C})_2\text{As}(\text{Cl})\text{Sn}$ , 20                                  | a                            | $\text{XSiMe}_3 + \text{SnCl}_2$  | 92)         |
| $(\text{C}_2\text{H}_5)_2\text{ClSn}$ , 21   | b                            | $1/2 (\text{C}_2\text{H}_5)_2\text{Sn} + 1/2 \text{SnCl}_2$   | 93, 94)     |
| $[(\text{Me}_3\text{Si})_2\text{N}]\text{ClSn}$ , 22   | b                            | $1/2 [(\text{Me}_3\text{Si})_2\text{N}]_2\text{Sn} + 1/2 \text{SnCl}_2$                             | 86)         |
| $(\text{RC}(\text{O})\text{CHCR}'\text{O})_2\text{Sn}$                                       | c                            | $(\text{MeC}_2\text{H}_4)_2\text{Sn} + 2 \text{RC}(\text{O})\text{CH}_2\text{C}(\text{O})\text{R}'$ | 95, 96, 97) |
| $(\text{RCOO})_2\text{Sn}$   | c                            | $(\text{MeO})_2\text{Sn} + 2 \text{HOOCR}$  | 98)         |
| $\text{RN}(\text{CH}_2\text{CH}_2\text{O})_2\text{Sn}$                                       | c                            | $(\text{MeO})_2\text{Sn} + (\text{HOCH}_2\text{CH}_2)_2\text{NR}$                                   | 99)         |
|  Sn, 23 | c                            | $(\text{MeO})_2\text{Sn} + \text{HE}-\text{CH}_2\text{CH}_2-\text{EH}$<br>(E = O, S)                | 100)        |
| $(\text{Me}_2\text{Si})_3(\text{NMe})_3\text{Sn}_2$ , 23                                     | c                            | $3 \text{Me}_2\text{Si}(\text{Me}_3\text{CN})_2\text{Sn} + 3 (\text{HMeN})_2\text{SiMe}_2$          | 101)        |



Table 12 (continued)

| $X_2Sn$  | Method according to Scheme 1 | Reactant   | Ref. |
|--|------------------------------|--|------|
|  24 | d                            |  + $SnCl_2$ | 102) |
|  25 | d                            |  + $SnCl_2$ | 102) |
| $MeB(NSiMe_3)_2Sn$ , 26  | e                            | $2 LiN(SiMe_3)BMe_2 + SnCl_2$  | 39)  |
|  27 | e                            | $1/2 [(Me_2N)_2Sn]_2 + Fe(CO)_5$   | 103) |

Although the results obtained by comparison of bond lengths and coordination numbers are illustrative they should be used with care. Since this approach does not take into account the nature of the ligands it is only a very rough one. It is nevertheless remarkable, that solid and molecular tin(II) compounds (which differ also chemically) possess similar geometries and distances around the tin atom.

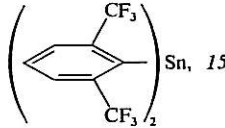
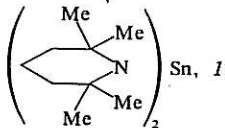
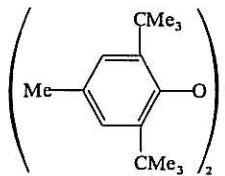
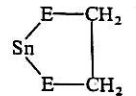
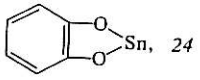
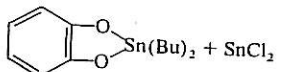
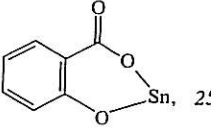
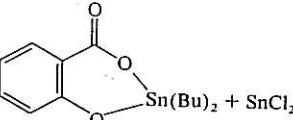
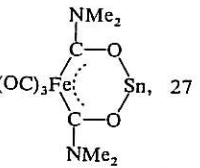
## 4 Syntheses and Structures of Molecular Tin(II) Compounds

### 4.1 Synthetic Routes to Molecular Tin(II) Compounds

The classical route to synthesize organic tin(II) compounds is the thermolysis or photolysis of tetravalent tin compounds. The driving force of these reactions may be either weak tin-tin bonds or the formation of stable compounds besides the desired

stannylenes which all polymerize. Some examples taken from the latest studies of W. P. Neumann and coworkers<sup>7,80,81)</sup> are illustrated by Eqs. (1–3).

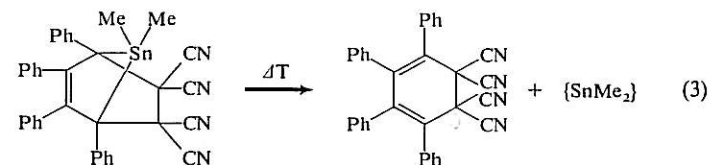
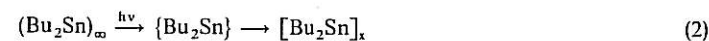
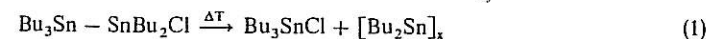

Until now, none of these reactions has ever lead to stable monomolecular stannylenes. Nevertheless, trapping reactions have confirmed the presence of intermediate Sn(II) species<sup>7,80,81)</sup>.

Stable stannylenes can be synthesized via routes which are combined in Scheme 1 whereas typical examples for these reactions are listed in Table 12.

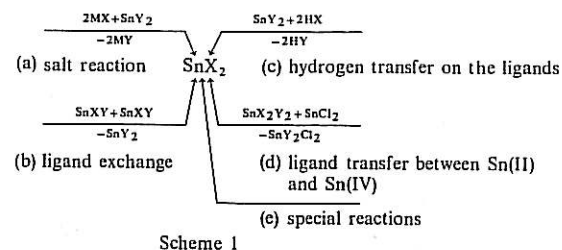

By far the most important reaction is the salt elimination reaction (a). Most of the known monomeric stannylenes have been synthesized via this route which is unaffected by the bulkiness of the substituent. In all cases, tin(II) chloride is taken as the tin component, because it dissolves quite well in ethers. The yields of the stannylenes are relatively high and may attain 95%.

Process (b), which should normally be written



is important in tincyclopentadienyl chemistry as well as in other special cases<sup>86,94,98)</sup>. The ligand exchange can be considered as an equilibrium reaction which is shifted to  $SnXY$  because of the low solubility of the compound,  $SnY_2$  corresponding to  $SnCl_2$  in nearly all cases.

The hydrogen-transfer reaction (c) from one ligand X to the other ligand Y is often utilized when chelating ligands have to be bonded to tin. The leaving group HY

may be cyclopentadiene, methanol, or a simple amine such as dimethylamine. The entering ligand is often more acidic. The coordination sphere at the tin atom is at least 3, but may also be 4 or higher.

Ligand transfer from tin(IV) to tin(II) compounds with appropriate ligands such as chlorine (d) has been used infrequently in the synthesis of stannylenes. The only reactions reported so far have been performed with oxygen as substituents at tin (see also Sect. 6.4.3).

Under "special reactions" (e) two procedures are combined which are unique and can be used for further preparations.

In the synthesis of the boron-containing four-membered cycle 26 the reaction is started by a salt elimination of type (a) followed by an intramolecular condensation

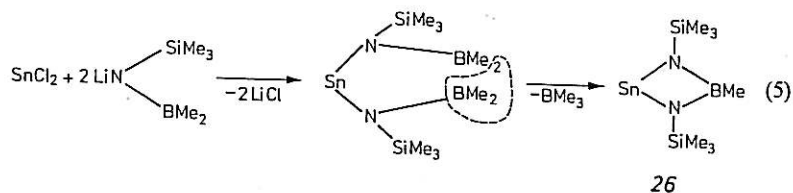

with elimination of trimethylboron<sup>39)</sup>. In the second example of Table 12 an addition of the Sn—N bond to the carbonyl groups is thought to result in the formation of the six-membered ring 27 which is believed to be stabilized by mesomerism<sup>102)</sup>.

## 4.2 Structures of Molecular Tin(II) Compounds

As previously pointed out in Chapter 2, monomeric stannylene can be in equilibrium with oligomeric species which are formed by tin-tin or tin-substituent intermolecular interactions. The tendency for the formation of the oligomers increases the more the molecules approach one another. Thus, when passing from the vapor to the liquid phase and finally to the solid state, the molecules usually exhibit quite different structures. In Table 13 examples of the corresponding structural changes are given.

Before studying some examples more closely, let us consider some cases which are not listed in Table 13. There are numerous compounds  $\text{SnX}_2$  which are definitely monomeric but are nevertheless no carbene analogs since their valence electron number at the tin atom is at least eight. These compounds contain chelating ligands which can stabilize the carbenoid tin atom due to intramolecular Lewis acid-base interactions as shown by structure A and B (see also Chapter 3).

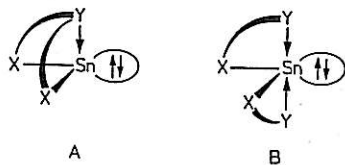

Table 13. Dependence of the structure of monomeric tin(II) compounds on the substituents and the phase

| Compound  | Vapor     | Solution or melt                      | Solid phase                      | Ref.           |
|---|-----------|---------------------------------------|----------------------------------|----------------|
| $(\text{C}_6\text{H}_5)_2\text{Sn}$ , 8   | —         | polymeric                             | polymeric and cyclic             | 34)            |
|  $\text{Sn}$ , 15  | —         | monomeric                             | unknown                          | 8, 85)         |
| $(\text{C}_5\text{H}_5)_2\text{Sn}$ , 13  | monomeric | monomeric, polymerizes on standing    | polymeric                        | 104, 105, 106) |
| $(\text{C}_5\text{H}_5)\text{ClSn}$ , 21  | monomeric | monomeric only in coordinat. solvents | polymeric, one-dimensional       | 93, 94, 107)   |
| $\text{Cl}_2\text{Sn}$ , 28   | monomeric | ionized or strongly coordinated       | polymeric                        | 20)            |
| $(\text{Me}_3\text{C}_2)_2\text{Sn}$ , 3  | monomeric | monomeric                             | monomeric                        | 29, 83)        |
| $[(\text{Me}_3\text{Si})_2\text{CH}]_2\text{Sn}$ , 14   | monomeric | monomeric                             | discrete dimers at least dimeric | 21, 108)       |
| $[(\text{Me}_3\text{Si})_2\text{N}]_2\text{Sn}$ , 16  | monomeric | monomeric                             | polymeric                        | 38, 109)       |
| $[(\text{Me}_3\text{Si})_2\text{N}]\text{ClSn}$ , 22  | —         | polymeric                             | polymeric                        | 86)            |
| $(\text{Me}_2\text{N})_2\text{Sn}$ , 29   | monomeric | dimeric                               | unknown                          | 110)           |
|  $\text{Sn}$ , 17 | monomeric | monomeric                             | unknown <sup>a</sup>             | 89)            |
| $[(\text{Me}_3\text{C})_2\text{N}]_2\text{Sn}$ , 30   | —         | monomeric                             | unknown                          | 89)            |
| $[(\text{Me}_3\text{C})_2\text{P}]_2\text{Sn}$ , 18   | —         | dimeric                               | unknown                          | 90)            |
| $[(\text{Me}_3\text{C})_2\text{P}]\text{ClSn}$ , 31   | —         | polymeric                             | unknown                          | 111)           |
| $[(\text{Me}_3\text{C})_2\text{As}]\text{ClSn}$ , 20  | —         | polymeric                             | unknown                          | 92)            |
| $\text{Me}_2\text{Si}(\text{Me}_2\text{HCN})_2\text{Sn}$ , 32   | monomeric | dimeric                               | dimeric                          | 112)           |
| $\text{Me}_2\text{Si}(\text{Me}_3\text{CN})_2\text{Sn}$ , 1   | monomeric | monomeric                             | monomeric <sup>b</sup>           | 27, 88, 112)   |
| $(\text{Me}_3\text{C})_2\text{Sn}(\text{Me}_3\text{CN})_2\text{Sn}$ , 33                              | —         | monomeric                             | unknown                          | 113)           |
| $\text{MeB}(\text{Me}_3\text{SiN})_2\text{Sn}$ , 26   | —         | dimeric                               | dimeric                          | 39)            |
| $(\text{CH}_2)_x(\text{Me}_3\text{SiN})_2\text{Sn}$ , 34 a, b, c                                      | monomeric | dimeric or polymeric                  | unknown                          | 114)           |
| $x = 2, 3, 4$   |           |                                       |                                  |                |

Table 13 (continued)

| Compound  | Vapor            | Solution or melt         | Solid phase | Ref.      |
|---|------------------|--------------------------|-------------|-----------|
| (MeO) <sub>2</sub> Sn, 35   | at least dimeric | polymeric or coordinated | polymeric   | 115, 116) |
|  | monomeric        | monomeric                | monomeric   | 28)       |
|  |                  | monomeric                | unknown     | 103)      |

<sup>a</sup> the corresponding Ge compound has a monomeric structure in the solid phase

<sup>b</sup> two solid modifications are known: in the triclinic phase only dimers are present while in the monoclinic phase four dimeric and four monomeric units are present simultaneously

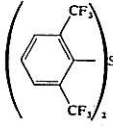
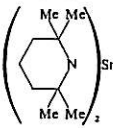
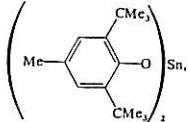
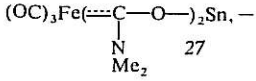
Atoms X and Y can either be different or identical. While for type B several examples are known (e.g. bis- $\beta$ -oxoenolates<sup>95-97</sup>), bis-carboxylates<sup>98</sup>), bis-sulfonates<sup>98</sup>), bis-dithiocarbonates<sup>91</sup>), only few compounds of type A have been synthesized and characterized up to now<sup>99, 117</sup>).

While diphenyltin (8) is polymeric (due to its crystal structure it can be isolated as a six-membered ring compound, Fig. 3), the corresponding compound 15 is monomeric in solution<sup>85</sup>). The effect of the two CF<sub>3</sub>-groups in ortho-position is believed to be predominantly of steric nature. Dicyclopentadienyltin(II) was the first organometallic tin compound whose structure has been established to be monomeric and bent in the vapor<sup>104-106</sup>). It polymerizes slowly in solution and presumably exhibits a two-dimensional polymeric structure as a solid<sup>106</sup>). If one cyclopentadienyl ligand, which is pseudo  $\pi$ -bound to the central atom, is replaced by chlorine, the resulting compound is not longer soluble in non-polar solvents but only in coordinating solvents such as tetrahydrofuran<sup>94</sup>). Solid (C<sub>5</sub>H<sub>5</sub>)ClSn is also polymeric<sup>107</sup>), and the molecules

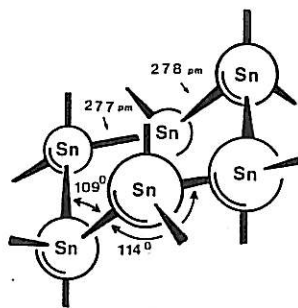

Fig. 3. Sn<sub>6</sub>-skeleton of the ring compound (SnPh<sub>2</sub>)<sub>6</sub> (8)<sup>34)</sup>

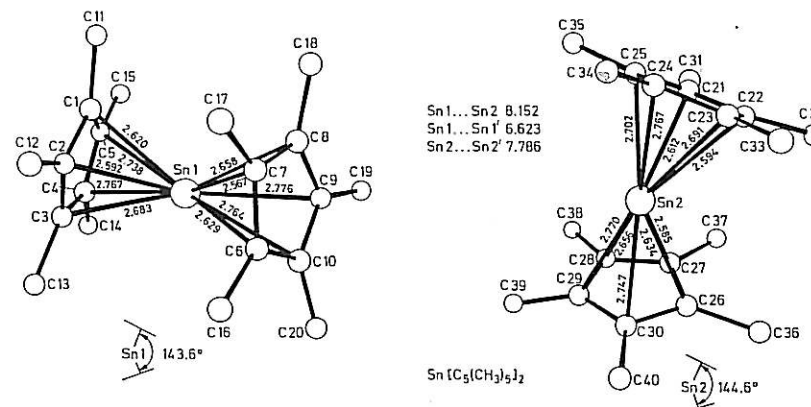

Fig. 4. Crystal structure of bis(pentamethylcyclopentadienyl)-tin(II) (3). Reprinted with permission from Chem. Ber. 113, 760 (1980). Copyright by Verlag Chemie

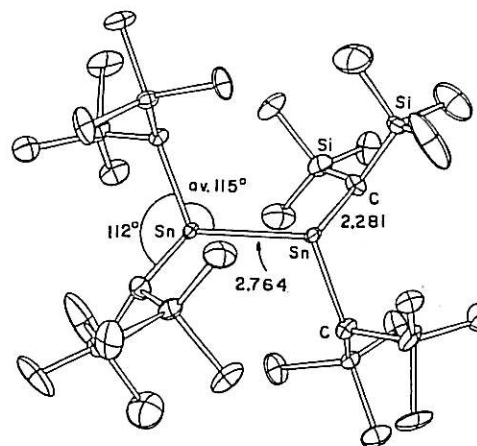
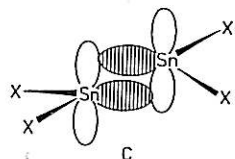

Fig. 5. Crystal structure of bis[di(trimethylsilyl)methyl]tin(II) (14). Reprinted with permission from J. Chem. Soc., Chem. Commun. 1976, 261. Copyright by The Chemical Society

interact via Cl-Sn bonds. If the steric requirement of the cyclopentadienyl groups is drastically raised by substitution of the hydrogen atoms by methyl groups the resulting compound, (Me<sub>5</sub>C<sub>5</sub>)<sub>2</sub>Sn, is found to be monomeric in all phases<sup>83</sup>) as demonstrated in Fig. 4.

The structure of the organometallic tin(II) compound 14, which was the first stable bivalent tin compound in non-polar organic solvents<sup>84</sup>), is changed when passing from the solution to the solid state<sup>21, 108</sup>). In the crystal discrete dimers are present (Fig. 5). Since the tin atom is pyramidal and the Sn-Sn distance quite large (276 pm), no normal  $\sigma$ ,  $\pi$ -double bond can be responsible for this geometry.

M. F. Lappert has therefore proposed a double Lewis acid-base interaction of type C<sup>108, 118</sup>.



The substituent  $\text{CH}(\text{SiMe}_3)_2$  is very suitable for the stabilization of tin(II) compounds: in addition to its large steric requirements it should be a strong  $\sigma$ -donor, trimethylsilyl groups being located in  $\beta$ -position to the tin atom. It is not astonishing that the isoelectronic bis(trimethylamino) group stabilizes monomeric stannylenes as well, but nothing is known about the structure of the solid *16*. In the vapor phase the molecule is bent at the tin atom by an angle of  $96^\circ$ , the nitrogen atoms being strictly trigonal planar and the whole molecule adopting  $C_{2v}$ -symmetry (Fig. 6)<sup>38)</sup>. Again, substitution of one bis(trimethylsilyl)amino group of *16* by chlorine leads to polymerization (molecule *22*).

A very interesting sequence of compounds is listed in Table 13 beginning with compound *29* up to *20*. While bis(dimethylamino)tin(II) is dimeric in solution, the molecule with the much more bulky substituent *17* is monomeric. In addition, substitution of the methyl groups by tert-butyl groups in *29* reduces aggregation (compound *30*). The corresponding phosphorus compound *18* is again dimeric, indicating the stronger Lewis-base property and the larger covalent radius of phosphorus. Substitution of one bis(tert-butyl)phosphinyl and bis(tert-butyl)arsinyl group by chlorine leads to polymeric *31* and *20*.

Some cyclic nitrogen-containing stannylenes are listed in Table 13. While the 1,3-diisopropyl-1,3-diazastannetidine *32* is dimeric in solution and in the solid state, the corresponding 1,3-di-tert-butyl derivative is strictly monomeric in the vapor phase and in solution. Two solid phases can be prepared: when a pentane solution of *1* is allowed to crystallize, a monoclinic phase forms with a 1:1 mixture of monomers and dimers. If the melt is crystallized, only dimeric units are found in the triclinic crystal lattice (see Figs. 7 and 8). These experiments clearly show that the degree of aggregation of the molecules directly depends on the degree of "dilution" of the compounds in the "solvents".

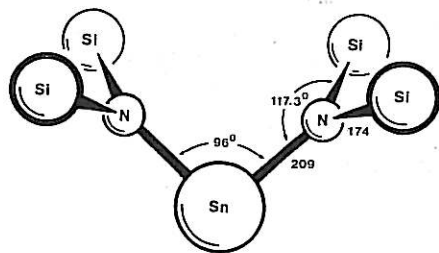

Fig. 6. Structure of  $[(\text{Me}_3\text{Si})_2\text{N}]_2\text{Sn}$  (*16*) in the vapor<sup>38)</sup>

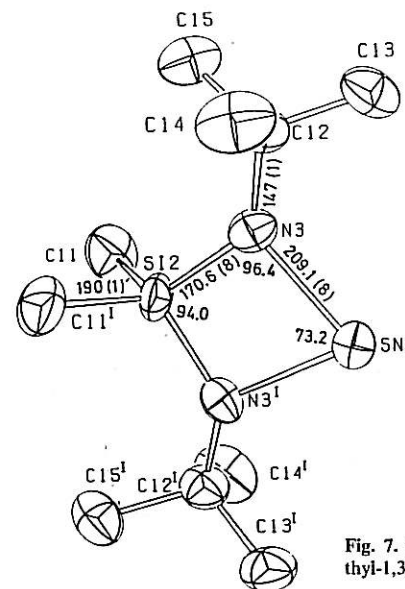

Fig. 7. Structure of monomeric 1,3-di-tert-butyl-2,2-dimethyl-1,3,2,4 $\lambda^2$ -diazasilastannetidine (*1*) in the crystal<sup>27)</sup>

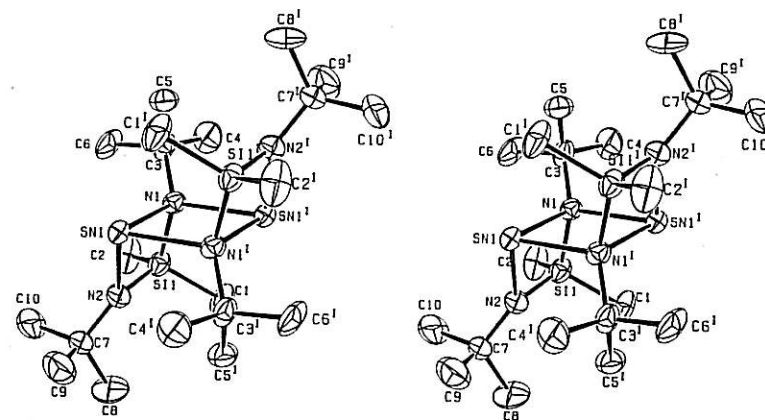

Fig. 8. A stereographic view of the corresponding dimeric unit of Fig. 7. Reprinted with permission from *Z. Naturforsch.* 33b, 11 (1978). Copyright by Verlag Zeitschr. für Naturforsch.

Substitution of the dimethylsilyl group by bis(tert-butyl)-stannyl does not change the structure in solution, e.g. *33* is found to be monomeric. A very interesting dimer is *26*. In contrast to the centrosymmetrical dimer of *1* ( $C_i$ -Symmetry), *26* has a twofold axis ( $C_2$ , see Fig. 9). This special structure may be due to intramolecular Lewis acid-base interactions between the boron and nitrogen atoms<sup>39)</sup>. Nevertheless,

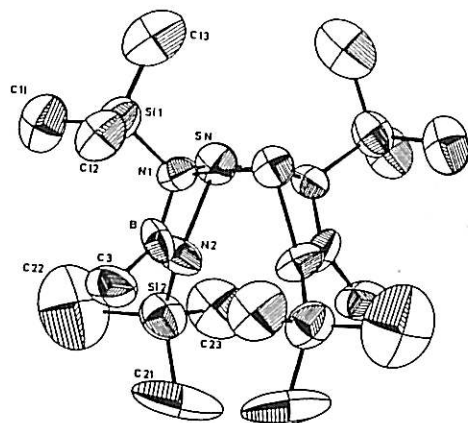

Fig. 9. Crystal structure of dimeric  $\text{MeB}(\text{Me}_2\text{SiN})_2\text{Sn}$  (26). Reprinted with permission from Chem. Ber. 112, 3677 (1979). Copyright by Verlag Chemie

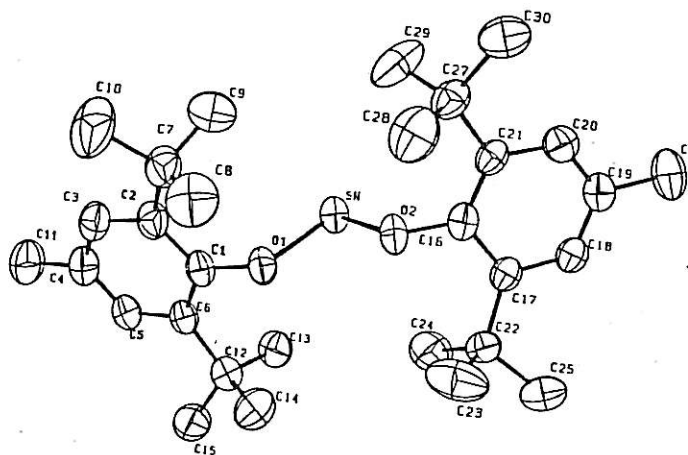

Fig. 10. Crystal structure of  $(\text{Me}-\text{C}_6\text{H}_2(\text{CMe}_3)_2-\text{O})_2\text{Sn}$

(2). Reprinted with permission from J. Amer. Chem. Soc. 102, 2088 (1980). Copyright by the American Chemical Society

it demonstrates very well that the trimethylsilyl group at the  $\alpha$ -nitrogen atoms is not so efficient in stabilizing monomeric stannylenes as the tert-butyl ligand. This can also be deduced from the structures of the compounds 34a, b, c.

There are numerous examples of tin(II)-oxygen compounds which demonstrate the high aggregation tendency of this type of compounds<sup>119, 120</sup>. A typical

representative is dimethoxystannylene (Table 13) which is oligomeric in all three phases. Only very recently have M. F. Lappert and coworkers shown that oxygen-containing ligands can also be considered as substituents in strictly divalent stannylenes. Besides 1 and 3, 2 is the only known example of a stannylene which is monomeric in the vapor phase, in the melt and as a solid (Fig. 10). Compound 27 is the first cyclic stannylene bridged by oxygen atoms and thus not coordinated in non-polar solvents. Unfortunately, no direct structural proof has been given for this molecule at the moment.

## 5 Conclusions from Chapters 3 and 4

Apart from the determination of the structures of stannylenes by diffraction methods (X-ray or electron diffraction) many other physico-chemical techniques can be employed to characterize these compounds more completely. Besides the classical methods such as IR-, Raman-, PE-, UV- and NMR-spectroscopy, Mößbauer-119 m-tin spectroscopy is widely used for the determination of the oxidation states of tin atoms and of their coordination<sup>100, 102, 114, 118, 120-123</sup>. It is not in the scope of this report to study the dependence of Mößbauer constants such as isomer shift and quadrupole splitting on structural parameters. Instead, we want to concentrate on one question: Which information can we deduce from the structure of stannylenes to evaluate their reactivity?

The following points are of general relevance:

1) Molecular compounds of bivalent tin are in all cases bent molecules, the angle between the substituents approaching  $90^\circ$ . Only the  $\pi$ -pseudo-bound cyclopentadienyl derivatives deviate considerably from this angle ( $120$  and  $144^\circ$ , respectively);

2) Bulky substituents are necessary for the stabilization of stannylenes which may have different structures in solution and in the solid state. The substituents envelope the tin atom from the back side, thus restricting its reactivity. Reactions should therefore occur predominantly from the front side;

3) The bond lengths between tin(II) and atoms with lone electron pairs like nitrogen or oxygen are quite small (200 and 209 pm compared with 208 and 215 pm as expected (see Chapter 3)) suggesting intramolecular electron compensation of the  $\pi$ -type:

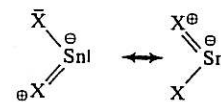

This interaction cannot be very important, as may easily be deduced comparison of compounds 1 and 16 (see also Figs. 6 and 7): Whereas in 1 the two filled  $\pi$ -orbitals of the  $sp^2$ -hybridized nitrogen atoms are equiplanar to the  $p_z$ -orbital of the tin atom, they are orthogonal in molecule 16, the bond distances being rigorously equal;

4) Stannylenes are in the first place Lewis acids (electron acceptors) as can be easily derived from the structures of the solids (Chapter 3). When no Lewis bases (electron donors) are present, they may also act as Lewis bases via their non-bonding electron pair (see polymerization of organic stannylenes).

A quantitative evaluation of the acid properties is quite difficult. One example is nevertheless quite instructive: in 1,3-di-tert-butyl-2,2-dimethyl-1,3,2,4 $\lambda^2$ -diazasilastannetidine (*I*) the tin atom can be replaced by the much smaller aluminium-methyl group <sup>124</sup>. While *I* is monomeric in benzene, *36* is dimeric:

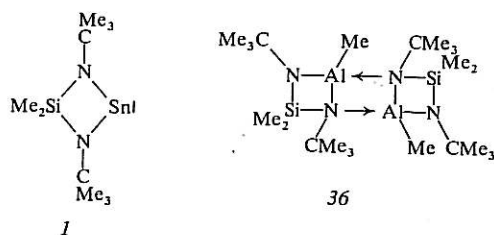

5) When stannylenes are allowed to react with nucleophiles *Y* the attack of the electron donor proceeds stereospecifically and orthogonal to the SnXX'-plane. This can be demonstrated by the Lewis base-adducts of the stannylenes which exclusively exhibit structures of type A or B, depending on the number of nucleophiles present.

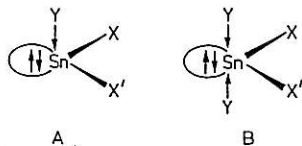

If  $X \neq X' \neq Y$  compounds of structure A have a center of chirality and the R- and S-enantiomers should be optically active. Since in Lewis acid-base reactions exchange equilibria are often expected to be formed via transition state B, it seems quite difficult to synthesize one pure enantiomeric form;

6) Stannylenes should be easily oxidized to molecular tin(IV) compounds as reflected by their low ionization potentials. In alkyl-substituted stannylenes the ionization energy is 7.42 eV while in stannylenamide it is 8.38 eV <sup>125</sup>. In any case, the tin atom is sterically easily accessible by reagents (see also point 2);

7) While the acidic behavior of the tin atom in stannylenes can be foreseen uncontestedly, its Lewis-base properties are much more difficult to evaluate. Taking the angle  $X_2Sn$  as a reference, the basicity should increase at angles larger than  $90^\circ$  as in the case of the cyclopentadienyltin, compounds where the orbital of the lone electron pair acquires more p- than s-character <sup>8</sup>). This picture is surely too simple: with few exceptions all tin(II) compounds show a high degree of stereochemical activity of the lone electron pair whether the ligands are bound nearly orthogonal to one another or not.

## 6 Reactions of Stannylenes $SnX_2$

In contrast to carbenes the singlet electron configuration in stannylenes  $SnX_2$  is much more stable; this implies that the non-bonding electron pair <sup>27</sup> can remain unchanged during a reaction. Consequently, this reaction center and other centers must be considered in a reaction pathway multiplying the reaction possibilities compared with the isoelectronic carbenes.

Following the ideas exposed in Chapter 4 different reactive centers can be distinguished in stannylenes:

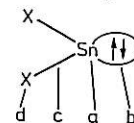

- the low-valent unsaturated tin atom,
- the non-bonding electron pair,
- the heteropolar Sn—X bond, and
- the Lewis-base properties of substituents X.

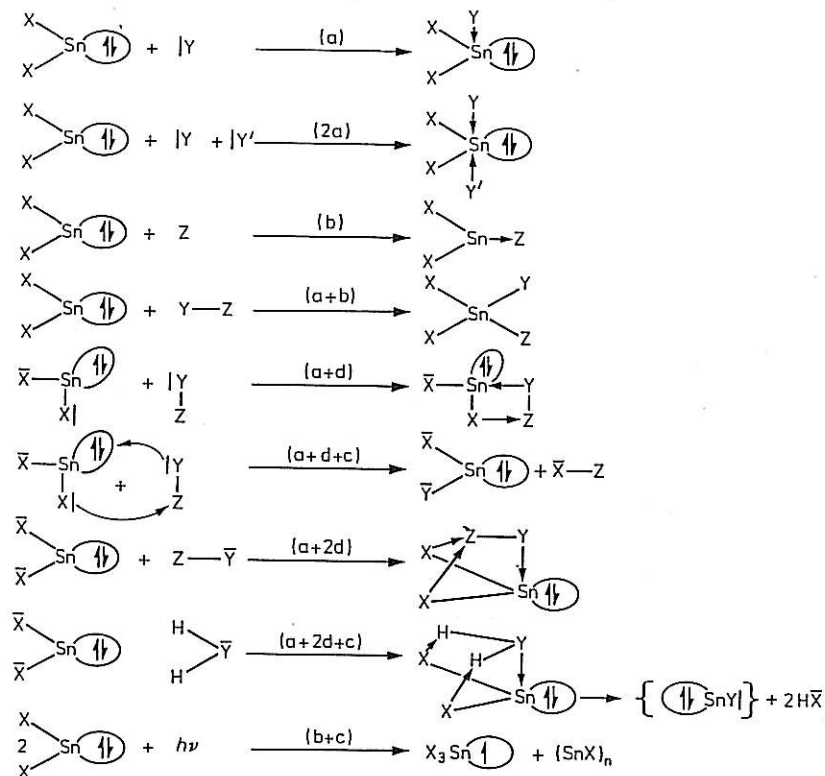

Scheme 2

Which of the different centers (a)–(d) will enter in a reaction depends of course on the reactant. Either only one or more centers may be attacked simultaneously. In Scheme 2 several possibilities are compiled, the details being discussed in the following chapters. The letters above the arrows in this scheme refer to the different centers involved in the reaction.

## 6.1 SnX<sub>2</sub> Reacting as a Lewis Acid

### 6.1.1 Formation of Simple Adducts

It has been known for a long time that nearly any tin(II) compound can form stable adducts with bases<sup>126)</sup>. For example, the halides SnHal<sub>2</sub>, which do not form stable bivalent tin compounds in solution, can nevertheless be stabilized by the addition of bases:



As base B several electron donors can be employed, e.g. amines<sup>127)</sup>, hydrazines<sup>128)</sup>, amine oxides<sup>129)</sup>, ethers<sup>126)</sup>, phosphanes<sup>130,131)</sup>, and even charged ligands such as halogen anions<sup>126)</sup> and many others<sup>126)</sup>. There may be formed either 1:1 or 1:2 adducts as in Eq. (7), an equilibrium being assumed to be established between these two adducts:



C. C. Hsu and R. A. Geanangel<sup>132)</sup> have studied the properties of these adducts for all tin(II) halides being coordinated with one or two trimethylamine molecules. As in the case of the trimethylamine-borontrihalide adducts the acceptor strength of the halides with respect to the amine decreases in the order: SnF<sub>2</sub> > SnCl<sub>2</sub> > SnBr<sub>2</sub> > SnJ<sub>2</sub>. On the other hand, the dissociation according to Eq. (9) is highest for SnF<sub>2</sub>, the SnJ<sub>2</sub> · (Me<sub>3</sub>N)<sub>2</sub> adduct being much more stable than SnF<sub>2</sub> · (Me<sub>3</sub>N)<sub>2</sub>.

Whereas adducts of instable stannylenes with bases are stable, easily isolatable compounds, stable stannylenes form adducts which are difficult to handle and to characterize. Taking [(Me<sub>3</sub>Si)<sub>2</sub>CH]<sub>2</sub>Sn (14) and Me<sub>2</sub>Si(NCMe<sub>3</sub>)<sub>2</sub>Sn (I) as examples<sup>133,134)</sup>, it is found that these two compounds can be coordinated with a base like pyridine (and also with other bases, see Ref.<sup>133)</sup>). However, the 1:1 adduct is only stable at -30 °C and decomposes at room temperature. The base attached to the stannylene can easily be removed in a vacuum at reduced pressure. When allowed to recondensate, it again forms a complex with stannylene<sup>134)</sup>. The equilibrium formulated by Eq. (10) can thus be shifted to the desired side.



Taking into consideration the findings with tert-butylamine in Section 6.6.1 it may be assumed that in solution the equilibrium of these reactions (Eq. (10)) is mostly shifted to the left side, involving however a rapid exchange of base molecules within the adduct. The equilibrium may depend on temperature and the molarity of B.

Generally speaking, the Lewis acidity of the tin atom and, as a consequence, the stability of the formed base adduct can easily be deduced from the structure of the stannylene under consideration. If it is stable and monomolecular in non-polar solvent, it will form weak adducts. If it is not, it will form strong and stable adducts.

### 6.1.2 Displacement Reactions

The displacement of one base coordinated to a stannylene SnX<sub>2</sub> by another base can easily be achieved if the entering molecule is more basic than the leaving one. If an ether solution of I is allowed to react with pyridine, the weak ether adduct is converted to a pyridine adduct at -30 °C<sup>112,134)</sup>:

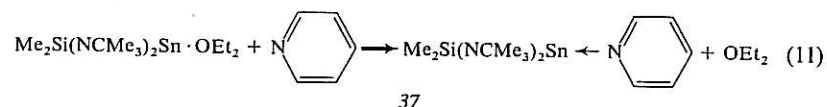

Another illustrative example is described by Eq. (12)<sup>135)</sup> which demonstrates that the adduct needs not necessarily contain only a tri-coordinated tin atom.

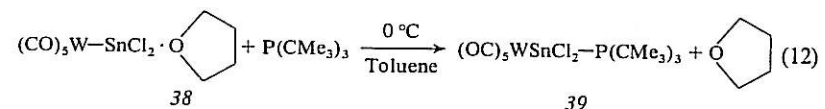

As in Cl<sub>2</sub>Sn—P(CMe<sub>3</sub>)<sub>3</sub> the metal-coordinated 39 may be interpreted as an ylide-type compound. Reactions and physicochemical measurements indicate that the phosphane acts as a simple donor<sup>130)</sup>.

These displacement experiments can be utilized to evaluate different base properties of ligands which are attached to the tin atom as illustrated by Eqs. (13)<sup>112)</sup> and (14)<sup>94)</sup>.

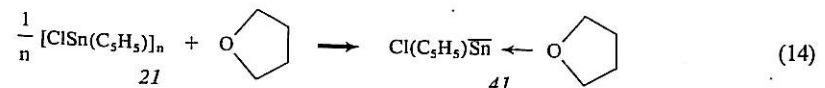
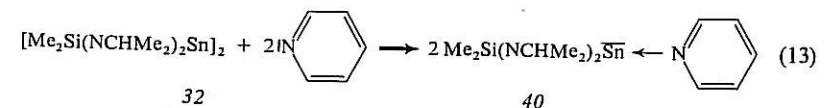

While in the first case (Eq. (13)) the dimeric unit, which is formed due to nitrogen-tin interactions (Chapter 4), is converted to the simple adduct *40* by the stronger base pyridine, the second case illustrates that the polymer *21* can be dissolved in a coordinating solvent.

## 6.2 SnX<sub>2</sub> Reacting as a Lewis Base

### 6.2.1 Formation of Adducts with Main-Group Acids

In 1970 Harrison and Zuckerman<sup>136)</sup> reported for the first time the existence of a stable adduct of a stannylene (dicyclopentadienylnit(II)) with a Lewis acid (trifluoroborane). In the meantime, P. G. Harrison was able to demonstrate that these Lewis-acid base interactions can be extended to a variety of main group acids<sup>137, 138)</sup> (Eqs. (15) and (16)).

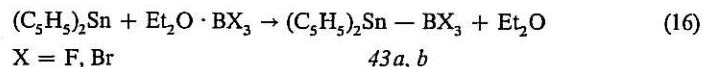
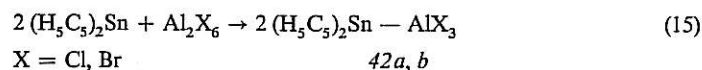

With BCl<sub>3</sub>-etherate ligand-exchange reactions occur, resulting in tin(II) chloride as the main product. The structures of the adducts *42* and *43* have been established mainly on the basis of IR- and Mößbauer data; unfortunately, no direct structural determination has been performed. Mostly from IR data it is believed that the cyclopentadienyl ligands are centrally σ(pseudo π-) bonded the angular geometry

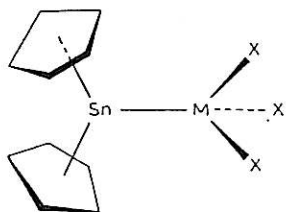
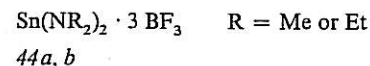

Fig. 11. Proposed structure for (C<sub>5</sub>H<sub>5</sub>)<sub>2</sub>Sn-MX<sub>3</sub> complexes (M = B, Al). Reprinted with permission from J. Organomet. Chem. 108, 38 (1976). Copyright by Elsevier Sequoia S.A.

of the free stannylene being retained and MX<sub>3</sub> being coordinated with the lone electron pair of the tin atom (Fig. 11).

It is very astonishing that this Lewis acid-base reaction cannot be transferred to other stable stannylenes<sup>133, 134)</sup>. M. F. Lappert et al., as well as our group, could not find any evidence for such adducts: neither Sn[CH(SiMe<sub>3</sub>)<sub>2</sub>]<sub>2</sub> (*14*) reacted with BF<sub>3</sub> nor Me<sub>2</sub>Si(NCMe<sub>3</sub>)<sub>2</sub>Sn (*1*) with Al<sub>2</sub>Cl<sub>6</sub>, the components of the reaction mixture being recovered unchanged. On the other hand, C. C. Hsu and R. A. Geanangel

have recently reported an 1:3 adduct formed between bis(dialkylamino)tin(II) and trifluoroborane (*44*)<sup>139)</sup>.



Multinuclear NMR experiments showed two different types of BF<sub>3</sub> groups, one BF<sub>3</sub> group being coordinated with the tin atom and two equivalent ones with the nitrogen atoms. Further studies led to the conclusion that BF<sub>3</sub> is initially bound to the tin atom at low molar ratios of BF<sub>3</sub> to Sn(NR<sub>2</sub>)<sub>2</sub>. The same authors were able to demonstrate that even base-stabilized SnCl<sub>2</sub> can be bound to BF<sub>3</sub>. Thus, in F<sub>3</sub>B · SnCl<sub>2</sub> · NMe<sub>3</sub> e.g. a base and a Lewis acid are simultaneously coordinated with the tin atom<sup>140)</sup>.

### 6.2.2 Coordination with Transition Metals

As heavier analogs of carbenes<sup>141)</sup> stannylenes can be used as ligands in transition-metal chemistry. The stability of carbene complexes is often explained by a synergetic σ, π-effect: σ-donation from the lone electron pair of the carbon atom to the metal is compensated by a π-backdonation from filled orbitals of the metal to the empty p-orbital of the carbon atom. This concept cannot be transferred to stannylene complexes. Stannylenes are poor p-π-acceptors: no base-stabilized stannylene (SnX<sub>2</sub> · B, B = electron donor) has ever been found to lose its base when coordinated with a transition metal (M ← SnX<sub>2</sub> · B). Up to now, stannylene complexes of transition metals were only synthesized starting from stable monomolecular stannylenes. Divalent tin compounds are nevertheless efficient σ-donors as may be deduced from the displacement reactions (17)–(20) which open convenient routes to stannylene complexes.

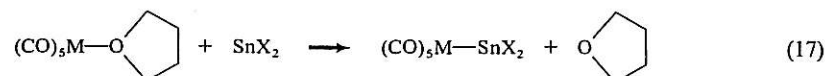

M = Cr, Mo, (W)

*45a, b, c, d*

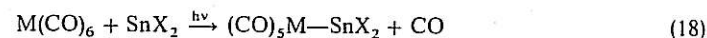
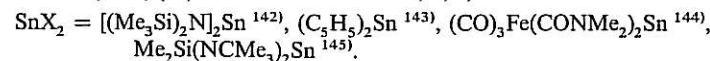

M = Cr, Mo

*45e, d*

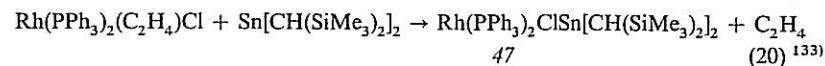
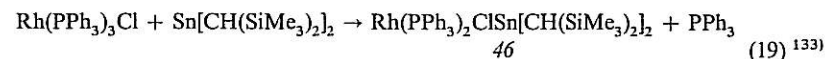
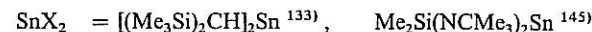



In addition to these monostannylene complexes, distannylene-metal complexes have also been prepared, either in competition with monosubstituted species (Eq. (21)) or by direct synthesis (Eq. (22)).

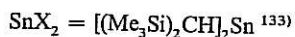
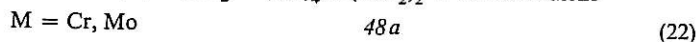
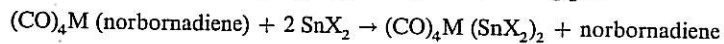
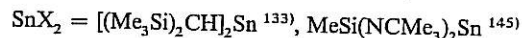
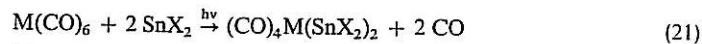

While the disubstituted compounds with the diorganylstannane 48a exhibit exclusively trans structure, the cyclic diazastannane preferably displays cis conformation as deduced from the IR-spectra of 48b.

The structures of these stannylene complexes closely resemble those of carbene complexes. In Fig. 12 the crystal structure of the stannylene complex 4 is displayed; the tin atom, the two carbon and the chromium atoms are equiplanar<sup>30</sup>.

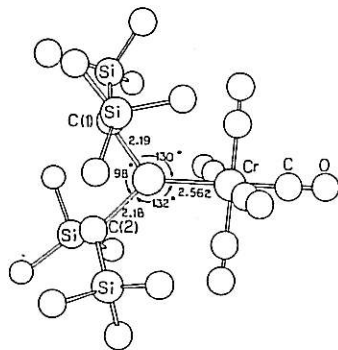
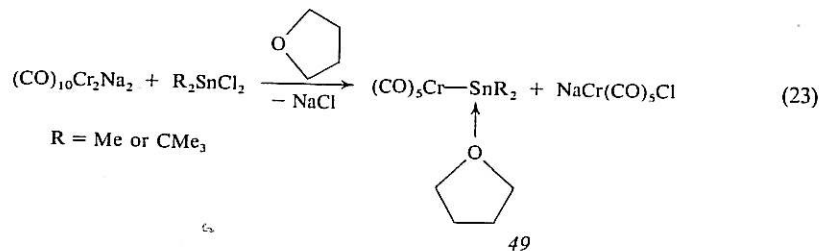
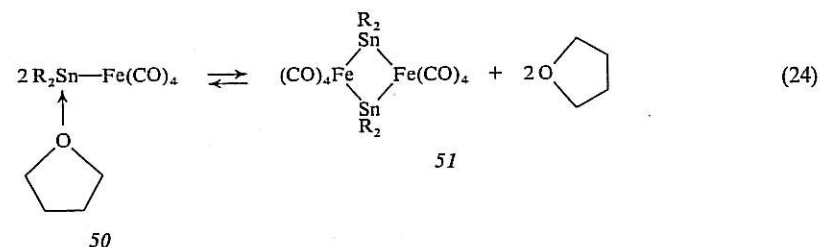

Fig. 12. Crystal structure of  $[(\text{Me}_3\text{Si})_2\text{CH}]_2\text{Sn}-\text{Cr}(\text{CO})_5$  (45). Reprinted with permission from J. Chem. Soc., Chem. Commun. 1974, 893. Copyright by The Chemical Society

Base-stabilized stannylenes have been known to form complexes with transition metals before stable stannylenes were detected. They are synthesized by a reaction similar to process (17) or by reduction of Sn(IV) compounds according to Eq (23)<sup>146</sup>.



Often, even equilibria between  $\mu\text{-SnR}_2$ -bound species and base-stabilized adducts occur:<sup>147</sup>



Some further selected examples of base-stabilized stannylene-metal complexes are listed in the following:

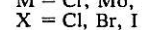
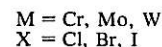
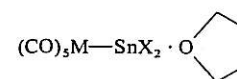

52

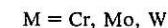
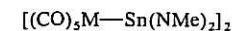

54

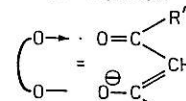
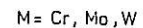
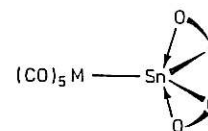

53

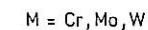
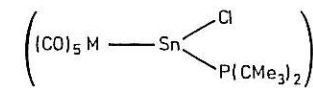
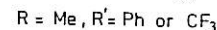

55

While 52 stands for simple base-stabilized complexes<sup>148</sup>, 53 is an example of a chelated base-stabilized stannylene coordinated with a transition metal<sup>149</sup>. 54<sup>144</sup> and 55<sup>150</sup> illustrate that the aggregation state of the stannylene remains unchanged in the complexes.

An X-ray structural analysis of  $(\text{CO})_5\text{CrSn}(\text{CMe}_3)_2(\text{NC}_5\text{H}_5)$  confirms<sup>33</sup> that the tin atom (tetrahedrally distorted) forms four bonds with neighboring atoms, the Sn-Cr bond length (265.4(3) pm) being larger than in the base-free complex 4

(256.2 pm<sup>30</sup>). Besides the examples cited so far, the charged SnX<sub>3</sub><sup>-</sup>-ligand has attracted considerable attention in transition metal chemistry. (For more details see Ref. <sup>151</sup>.)

### 6.3 Insertion Reactions of Stannylenes (Oxidative Addition)

Bivalent tin compounds can easily be transformed to fourvalent tin compounds by oxidizing agents. Mechanistically, this reaction can be understood as an insertion of a six-electron system into a two-electron bond, resulting in a tetrahedrally tetra-coordinated tin atom. This process is often also regarded as an oxidative addition, a distinction being made between additions to  $\sigma$ -bonds and to  $\pi$ -bonds.

#### 6.3.1 Addition to Single Bonds

Stable stannylenes, base-stabilized stannylenes and unstable stannylenes are known to react easily with two-electron bonds, e.g. with molecule Y—Z:

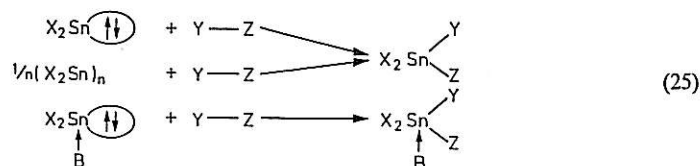

Atoms Y and Z may be identical as in halogens <sup>133, 152, 153</sup>, in disulfanes <sup>154</sup>, elemental sulfur <sup>155</sup>, and polynuclear transition metal compounds <sup>143, 156-158</sup>. They can be different as in organic halides <sup>86, 133, 159-163</sup>, hydrogen halides <sup>133</sup>, transition metal halides <sup>133, 157</sup>, transition metal hydrides <sup>133, 164, 165</sup>, transition metal alkyls <sup>133, 157</sup> or in Grignard reagents <sup>166</sup>. Some representative compounds, which have been obtained by reactions (25) are listed below, illustrate that the substituent X bonded to the original stannylene can be varied within a great range:

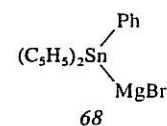
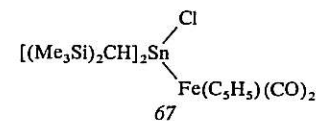
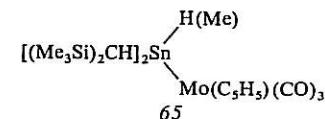
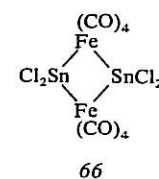
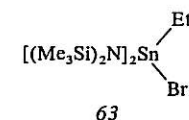
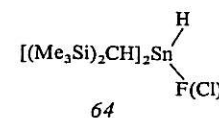
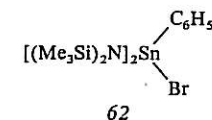
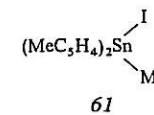
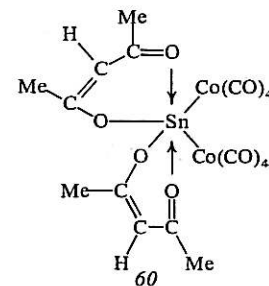
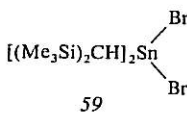
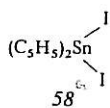
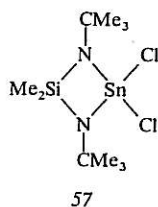
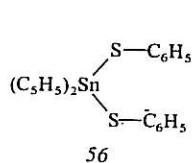

The reaction of the cyclic diazastannylene *1* with sulfur (S<sub>8</sub>) in benzene yields the dispiro compound (69) <sup>155</sup>:

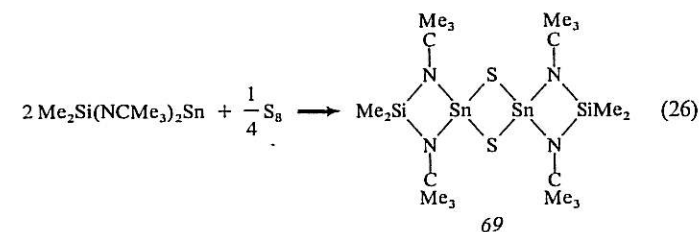

Another very interesting reaction involving insertion of dicyclopentadienylstannylene into metal-hydrogen bond with displacement of its ligands has been described by J. G. Noltes et al.<sup>165</sup>. The resulting product was identified by X-ray structural analysis.

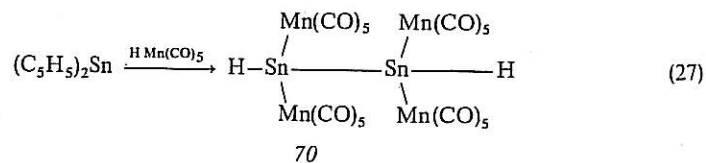

Insertion reactions of stannylenes, even of unstable ones, into metal-metal bonds have attracted considerable attention<sup>156-158</sup>. In this context, it is very astonishing that the reaction (28) between the alkyl-substituted stannylene 14 and  $Fe_2(CO)_9$  does not lead to a product of type 66 ( $X_2Sn Fe(CO)_4$ )<sub>2</sub> (an X-ray structural analysis indicates an  $Sn_2Fe_2$ -ring<sup>167</sup>) but to a three-membered ring, as determined by elemental analysis and from IR-spectral data<sup>133</sup>.

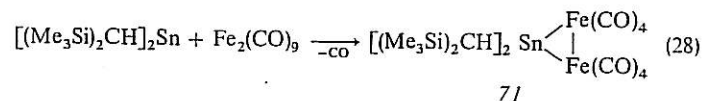

This reaction can also be regarded as a substitution of  $\mu$ -bound carbonyl by stannylene.

Many of these reactions are of great synthetic importance as they all provide facile routes to functionally substituted tin(IV) compounds. One procedure, which is of great industrial interest, is the intermediate addition of HCl to  $SnCl_2$  forming  $HSnCl_3$  which reacts with  $C=C$  bonds. This type of reaction is exemplified by Eq. (29)<sup>168</sup>:

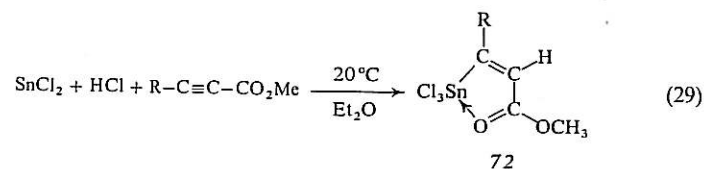

Nevertheless, not every  $\sigma$ -bond reacts with any stannylene. In principle, the Y-Z bond in Eq. (25) should be rather polar or, if it is not, the elements involved in bonding should be rather heavy (high polarizability). Up to now, no reactions involving a  $\sigma$ -C-C- or -N-N-bond have been reported.

Mechanistical studies on the reaction of stable stannylenes with organic halides have been performed by M. F. Lappert and his group<sup>161-163</sup>. On the basis of ESR spectroscopic data they proposed a radicalic pathway for this reaction. Initially, one electron of the stannylene is transferred to the organic halide the

halogen of which is then added to the tin atom according to Eq. (30) (Y = halogen, X = bulky organic group).

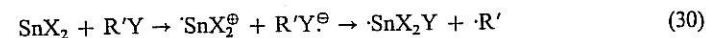

### 6.3.2 Addition to Double Bonds

In contrast to the numerous reactions involving single bonds, interactions of stannylenes with double bonds have not extensively been studied. There are only two cases known where addition of a monomolecular stable stannylene to a double bond system takes place (Eqs. (31)<sup>154</sup> and (32)<sup>133</sup>; see also Ref.<sup>169</sup>)

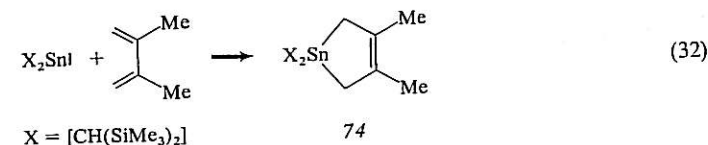
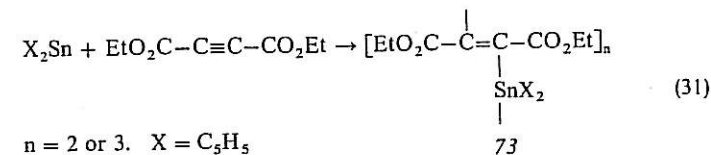

It should be noted that dicyclopentadienyltin does not give any detectable reaction with 2,3-dimethyl-1,3-butadiene, in contrast to the dialkyltin compound<sup>154</sup>. According to Eq. (31) 6- or 9-membered ring compounds are formed. The dicyclopentadienyl compound in Eq. (31) can also be replaced by the unstable stannylenes<sup>154</sup>.

More studies have been concentrated on the reaction of stannylenes with molecular oxygen (which is of course a limiting-case with respect to the classification as a double bond). Eq. (33) reflects the data of a variety of experiments<sup>86,87,93,133,153</sup>.

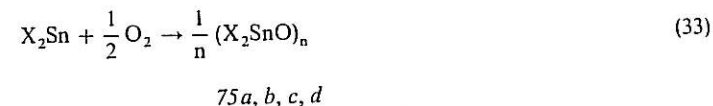

For any ligand X of Eq. (33) a polymer 75 of definite composition but of completely unknown structure is formed. The cyclic diazastannylene 1 reacts differently. Besides the tetraazastannane 76 a crystalline solid is formed the structure of which has been

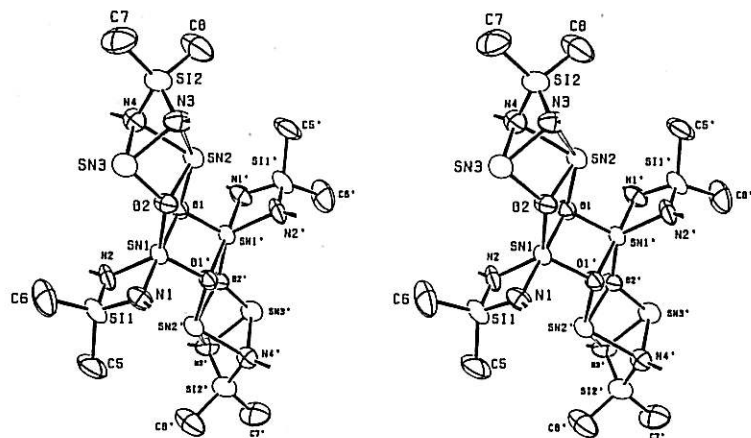
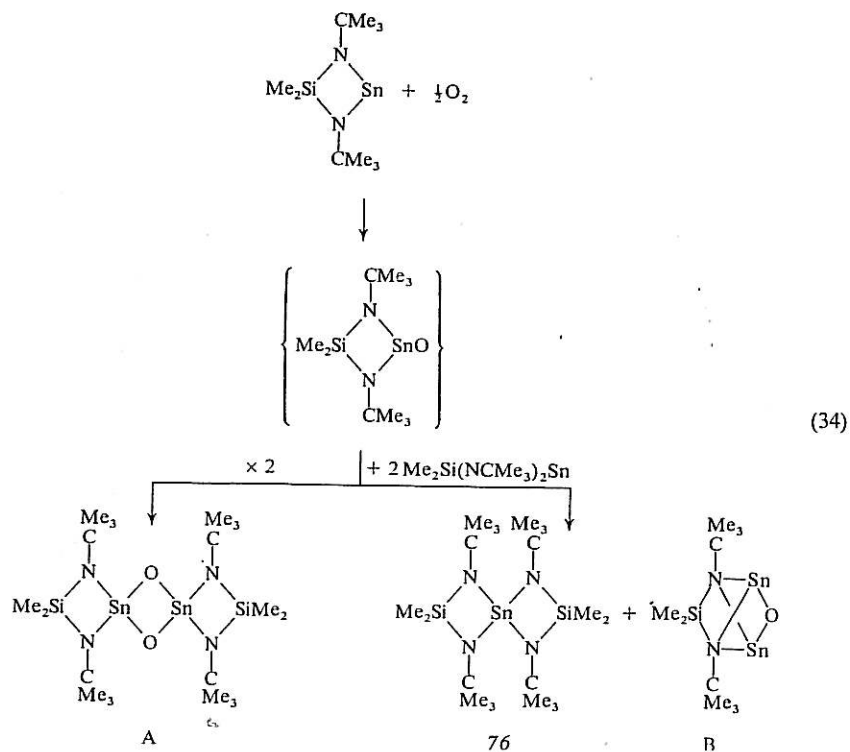

Fig. 13. A stereographic view of the crystal structure of  $[\text{Me}_2\text{Si}(\text{NCMe}_3)_2\text{Sn}_2\text{O}_2] \cdot [\text{Me}_2\text{Si}(\text{NCMe}_3)_2\text{SnO}_2]$  (77). Reprinted with permission from *Z. Anorg. Allg. Chem.* 459, 211 (1979). Copyright by J. A. Barth Verlag



determined by X-ray structural analysis (Fig. 13). The reaction route is described by the scheme above (Eq. (34))<sup>170)</sup>.

The dispiro compound A reacts with 2 cage molecules B to form the complex molecule 77 displayed in Fig. 13. The intermediate in brackets cannot be isolated. In contrast to the reaction of the same stannylene with sulfur (Eq. (26)) the dispiro compound A cannot be isolated separately. The mechanism of reaction (34) may of course be more complicated. The cage molecule B is discussed in more detail in Section 6.5. It should be noted that in 77 six tin atoms of two different oxidation states are combined.

## 6.4 Reactions of Stannylenes with Participation of Ligands

### 6.4.1 $\text{SnX}_2$ Displaying Dihapto-Ligand Properties

In Chapter 4 a variety of stannylenes have been assembled which are characterized by a coordination of type A or B.



The dimeric structure, which is common to the compounds 18, 26, 29, 32, can be attributed to a double intermolecular Lewis acid-base interaction, one of the substituents at the tin atom displaying base properties. The second substituent, which exhibits the same chemical properties as the first one, is not engaged in the formation of the dimer. In the case of compound type B,  $(\text{C}_3\text{H}_5)\text{ClSn}$  being an illustrative representative<sup>107)</sup>, the substituent X disposes of several electron pairs and hence acts as a bifunctional base, while Y is again a terminal group. In structures A and B the stannylene displays dihapto-ligand properties, the tin atom acting as an acid and the substituent as a base.

Besides these intermolecular adducts an example for an intramolecular adduct has recently been reported. Thus, a ten-membered ring 78, which contains two stannylene units, has been synthesized<sup>101)</sup> (Eq. (35)).

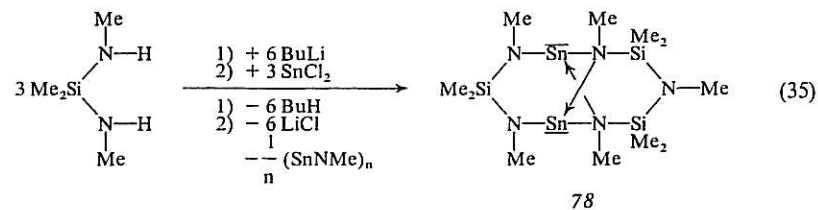

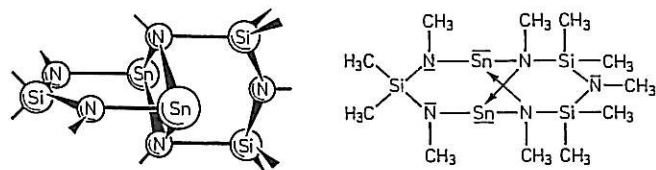
Fig. 14. Molecular structure of  $(\text{Me}_3\text{Si})_3(\text{NMe})_2\text{Sn}_2$  (78) <sup>101</sup>

Each of these tin atoms acts as a Lewis acid, with two neighboring nitrogen atoms functioning as electron donors. The ten-membered ring folds up to generate a four-membered cycle bridged at the 1,3- and 2,4-positions. The structure, which can easily be deduced from high-resolution NMR spectra, is displayed in Fig. 14.

Up to now, no stable adducts of type A where one of the bridging atoms X is replaced by a chemically different base or the tin atom by another Lewis acid have been synthesized. Nevertheless, this type of adduct is believed to play an important part in ligand exchange or substitution reactions.

#### 6.4.2 Ligand-Exchange Reactions

The synthesis of asymmetrically substituted stannylenes is most efficiently achieved by ligand exchange reactions between two stannylenes,  $\text{SnX}_2$  and  $\text{SnY}_2$  (see Chapter 4). For example, the stannylenes  $[(\text{Me}_3\text{Si})_2\text{N}]\text{ClSn}$  and  $(\text{C}_5\text{H}_5)\text{ClSn}$  can be synthesized according to Eqs. (36) and (37) <sup>86, 93, 94</sup>.

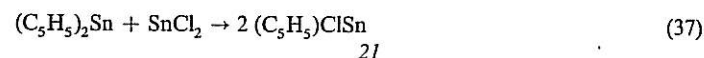
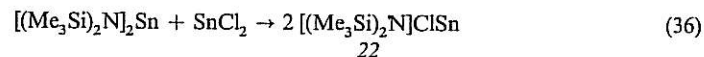

In both examples the reaction is shifted to the right side, because the unsymmetrical compound is highly associated and poorly soluble. If the diazastannylenes and dicyclopentadienyltin are mixed in 1:1 ratio, an adduct is formed which is unstable and thus cannot be isolated; it decomposes to the original stannylenes (Eq. (38)) <sup>87</sup>.

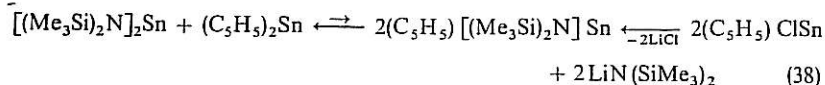

These findings may be explained by the general reaction sequence (39).

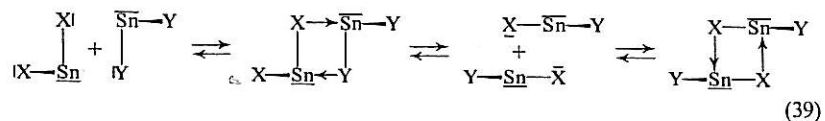

An exchange of ligands in  $\text{SnX}_2$  and  $\text{SnY}_2$  will occur if X is markedly more basic than Y, thus favoring the formation of an adduct formulated at the right side of reaction (39). If the basic properties of X and Y are very similar, the first equilibrium in the reaction sequence predominates and no ligand transfer is observed. Referring to our examples, reactions (36) and (37) are shifted to the right side because chlorine is a stronger donor than  $[(\text{Me}_3\text{Si})_2\text{N}]$  or cyclopentadienyl, while in Eq. (38) the two different substituents display the same basicity (the nitrogen atom in  $[(\text{Me}_3\text{Si})_2\text{N}]$  is not basic; the trimethylsilyl groups are known to reduce the basic properties considerably).

#### 6.4.3 Ligand Substitution

As already pointed out in Chapter 4 certain stannylenes can be prepared by replacing cyclopentadienyl, dimethylamido or dimethoxy ligands by more acidic groups. In all cases, the entering ligand displaces a hydrogen atom which is transferred to the original substituent. It can be assumed (cf. also Sect. 6.5) that some of these reactions proceed via an unstable adduct in which the stannylenes again acts as a dihapto ligand (Eq. (40)).

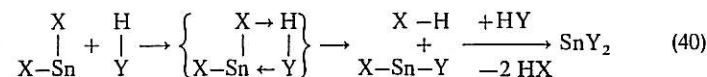

Zuckerman et al. have extensively utilized this method in heterocyclic tin(II) chemistry <sup>100</sup>. In some cases, this synthesis may also be performed with tin(II) chloride, the starting hydrochloride being coordinated by the addition of an amine <sup>120</sup>. Free <sup>171</sup> and metal-bound tin(II) chloride <sup>172</sup> have been treated analogously with trimethyltin hydroxide to yield amorphous powders of the composition  $\text{Sn}(\text{OH})_2$  and  $(\text{CO})_5\text{MSn}(\text{OH})_2$  (M = Cr, W) and  $\text{ClSnMe}_3$ . Unfortunately, no direct information on the structure of these compounds is available.

Jutzi et al. have studied reactions of bis(pentamethylcyclopentadienyl)tin with very strong acids such as  $\text{HBF}_4$ ,  $\text{HAlCl}_4$  or the methyl esters of  $\text{CF}_3\text{COOH}$  and  $\text{CCl}_3\text{COOH}$  <sup>173, 174</sup>. In these reactions only one pentamethylcyclopentadienyl group is surprisingly replaced and a very stable cationic species  $(\text{Me}_5\text{C}_5)\text{Sn}^+$  is formed:

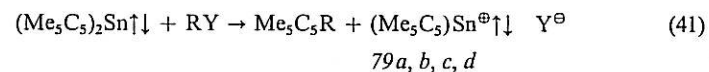

R = H or Me

$\text{Y}^{\ominus} = \text{BF}_4^{\ominus}, \text{AlCl}_4^{\ominus}, \text{Cl}_3\text{CCOO}^{\ominus}, \text{F}_3\text{CCOO}^{\ominus}$

This outstanding behavior of bis(pentamethylcyclopentadienyl)stannylenes has been explained by the energetically favorable formation of the ionic compound 79 which contains the 6-membered cluster  $\text{C}_5\text{Sn}$  <sup>174</sup>. The structure of the boron tetrafluoride compound is illustrated in Fig. 15: the tin atom in the cation is located at the apex of a pentagonal pyramid <sup>173</sup>.

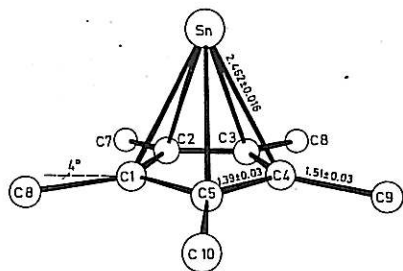
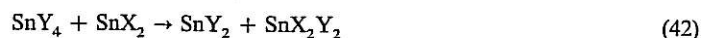
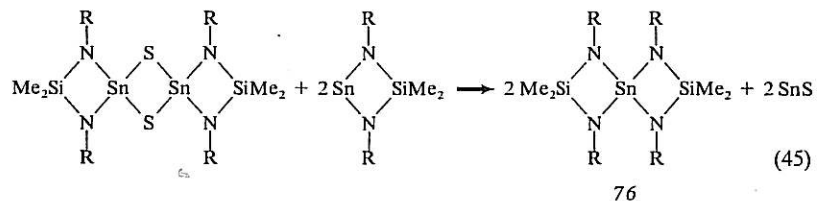
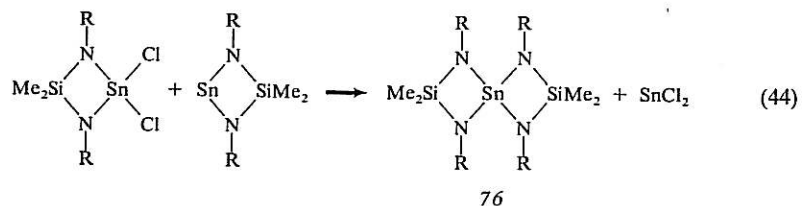
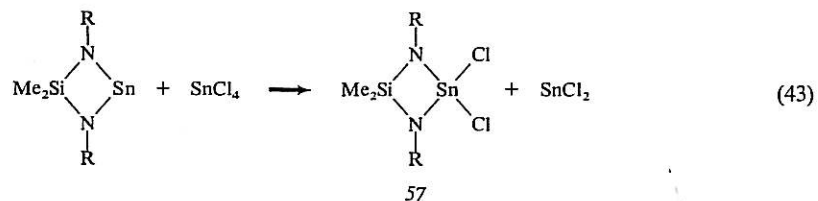

Fig. 15. Structure of the  $(\text{Me}_3\text{C}_2)\text{Sn}^+$  cation in  $(\text{Me}_3\text{C}_2)\text{Sn}^+\text{BF}_4^-$  (79a). Reprinted with permission from Chem. Ber. 113, 761 (1980). Copyright by Verlag Chemie

Equation (42) combines the general features of ligand transfer reactions between tin(II) and tin(IV) compounds.



The cyclic diazastannylene *1* has been found to be very suitable for this type of reaction<sup>155</sup> (cf. also Sect. 4.1). In Eqs. (43) and (44) the chlorine atoms of the Lewis acids are transferred to the divalent tin atom resulting in the formation of 57 and 76 and tin(II) chloride, the latter being insoluble in benzene. In (45) the solubility of the produced compounds is again important because SnS precipitates from the solution; thus, the equilibrium is shifted to the right (in Eqs. (43)–(45) R denotes tert-butyl).



The rate-determining step in reaction (45) is second order, illustrating that Lewis acid-base interactions are involved in this process. Eqs. (43)–(45) are similar to reactions (36) and (37): since the tin(II) compounds formed are highly associated (tin(II) chloride and tin(II) sulfide can be isolated as pure and large crystals), the equilibrium is shifted to the right side.

## 6.5 Reactions with Stannylenes $\text{SnX}_2$ Displaying Trihapto-Ligand Properties

From a general point of view, it seems quite unlikely that a stannylene such as  $\text{SnX}_2$  acts simultaneously via the Lewis acidic Sn atom and the two Lewis basic ligands X as a trihapto ligand since X and Sn should first be in an appropriate position (there is free rotation around the Sn–X bonds). On the other hand, this situation must be taken into account when the ligands and the tin atom are held in a sterically fixed geometry as in cyclic derivatives of bivalent tin. Considering the cyclic diazastannylene *1* (see Sect. 4.2), the two filled p-orbitals of the nitrogen atoms as well as the empty p-orbital of the tin atom are all oriented in the same direction:

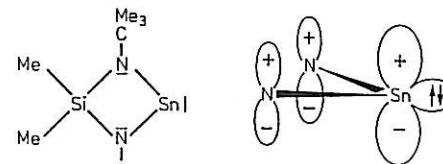

In this Section we will demonstrate that stable “adducts” of this “ligand” can be prepared and that they play an important part as intermediates. They can also be regarded as key molecules to a variety of cages.

### 6.5.1 Formation of Adducts

Two different “adducts” of the diazastannylene *1* acting as a trihapto ligand can be differentiated. One has the composition  $\text{Me}_2\text{Si}(\text{NCMe}_3)_2\text{Sn} \cdot \text{SnY}$  and forms a stable cage molecule while the other has the general formula  $\text{Me}_2\text{Si}(\text{NCMe}_3)_2\text{Sn} \cdot \text{YH}_2$  (Y in the two cases means O or N–R) and is very instable. The first adduct can be prepared according to Eqs. (46) and (47) when *1* is allowed to react with bases like  $\text{H}_2\text{O}$  or amines  $\text{H}_2\text{N–R}$ <sup>175, 176</sup>.

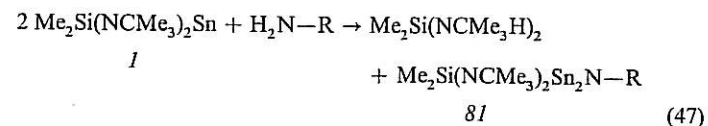
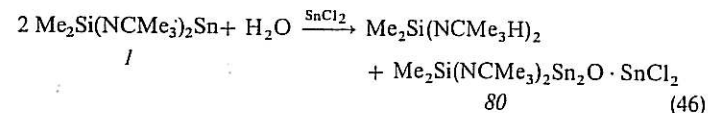

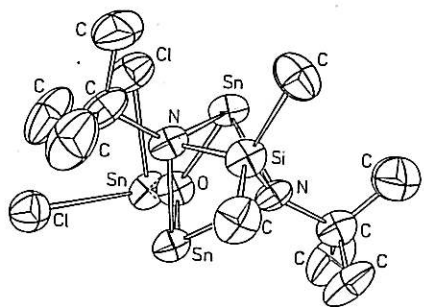
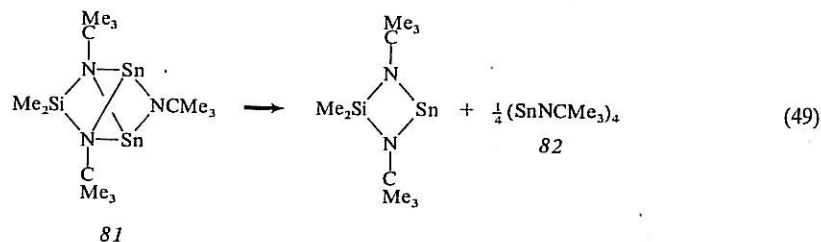
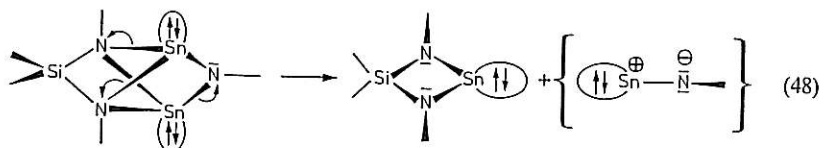

Fig. 16. The molecular structure of  $\text{Me}_2\text{Si}(\text{NCMe}_3)_2\text{Sn}_2\text{O} \cdot \text{SnCl}_2$  (80) <sup>175)</sup>

The second adduct is formed as an intermediate in these reactions as may be seen below. As shown by Eqs. (46) and (47) the tin atom in *1* has been replaced by two hydrogen atoms and the resulting species "SnO" resp. "SnN-R" has been trapped by a second stannylene molecule. Figure 16 describes the structure of one of the products <sup>175)</sup>. Evidently, the cage is highly symmetrical ( $\text{mm}(\text{C}_2)$  symmetry), the four Sn-N bonds being equal (the  $\text{SnCl}_2$  moiety of the molecule is necessary for crystallizing the compound). From a structural point of view it seems rather dubious to consider molecules of type *80* or *81* as adducts; nevertheless, it can be shown chemically. When *81* is heated in benzene solution to  $>200^\circ\text{C}$ , it decomposes according to 48 <sup>176)</sup>.



In addition to the oligomer of  $\text{SnNCMe}_3$ , the original stannylene is formed again in quantitative yield. As the rate-determining step of this reaction is of first order <sup>176)</sup>, the following mechanism may be formulated:



The intermediate in brackets is highly unstable and forms an oligomer as explained below. Equation (49) nicely illustrates the trihapto function of the cyclic diazastannylene opposite to the intermediate. The latter has a twofold electrophilic center at tin and a highly nucleophilic center at nitrogen.

The use of the second type of compound, in which the cyclic stannylene *1* can be considered as trihapto-coordinating, results in the same reaction 47. We have studied the mechanism of this reaction and found that the primary step is an acid-base interaction between the stannylene and the amine (Eq. (50)). It is very difficult to prove that the adduct *83* is formed in solution because of very rapid exchange of base molecules at the tin atom. We succeeded in preparing the adduct at low temperature ( $-70^\circ\text{C}$ ) <sup>177)</sup>.

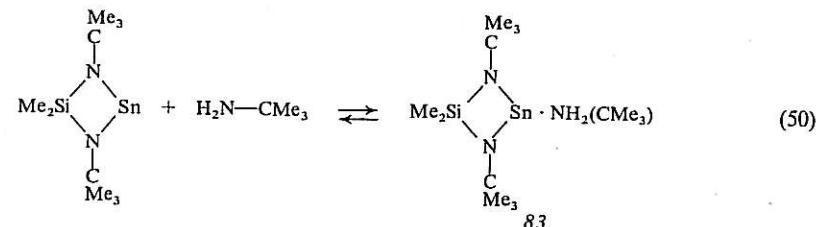

The structure of this adduct is displayed in Fig. 17 <sup>177)</sup>. As should be expected (see Chapters 3 and 4) the nitrogen atom of *t*-butylamine is coordinated with the tin atom at nearly right angles with respect to the four-membered ring.

The rather long Sn-N distance of 246 pm as well as the nearly unchanged distances within the ring (with respect to the free stannylene) indicate that the Lewis acid-base interaction in the adduct is not very important. This parallels the findings discussed in Section 6.1.1. On the other hand, the pyramidal environment of the ring-nitrogen atoms and the narrow approach ( $\sim 300$  pm) of the hydrogen atoms to the latter (dashed line) is very remarkable. Again this adduct proves the trihapto properties of the stannylene: while the tin atom is coordinated with the nitrogen

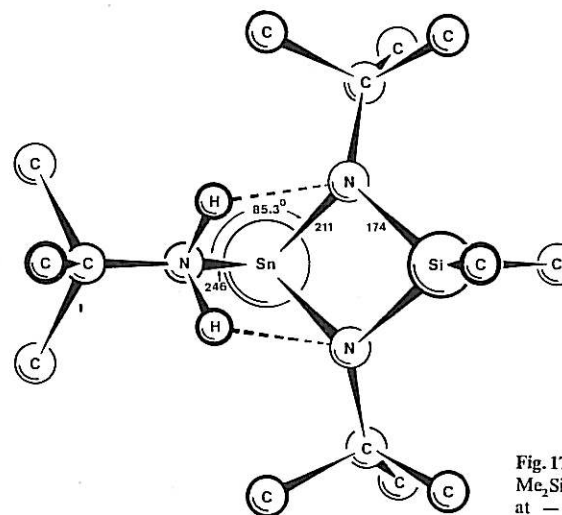
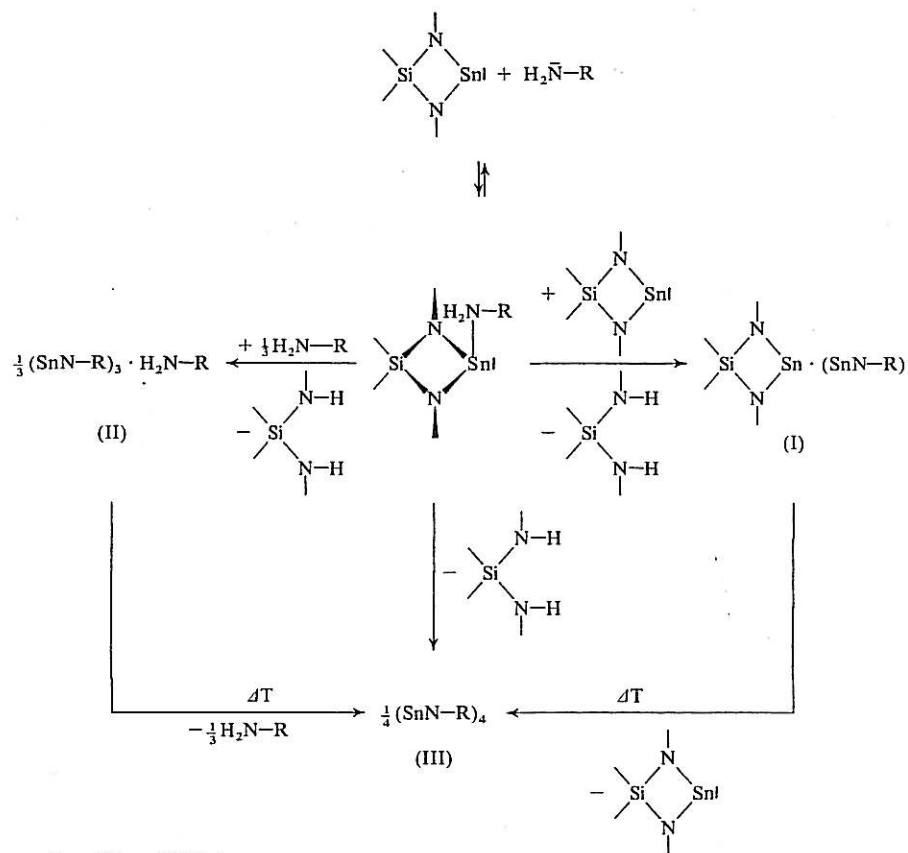

Fig. 17. Crystal structure of the adduct  $\text{Me}_2\text{Si}(\text{NCMe}_3)_2\text{Sn} \cdot \text{NH}_2\text{CMe}_3$  (83) at  $-100^\circ\text{C}$  <sup>177)</sup>

base, the electropositive hydrogen atoms slightly interact with the nitrogen atoms of the ring.

### 6.5.2 Synthesis of Iminostannylenes and Related Compounds

Adducts of the type  $\text{Me}_2\text{Si}(\text{NCMe}_3)_2\text{Sn} \cdot \text{H}_2\text{N}-\text{R}$  are unstable and cleaved to  $\text{Me}_2\text{Si}(\text{N}(\text{CMe}_3)\text{H})_2$  and the intermediate  $\{\text{SnN}-\text{R}\}$ <sup>176, 177</sup>. It is not yet clear whether this scission is a monomolecular process, as might be inferred from the structure



Scheme 3

(the dashed line in Fig. 17 representing the reaction coordinate of the hydrogen atoms), or a bimolecular process. Scheme 3 summarizes the different possibilities of stabilization for the fragment  $\{\text{SnN}-\text{R}\}$ ; in all reactions a second stable fragment  $\text{Me}_2\text{Si}(\text{N}(\text{CMe}_3)\text{H})_2$  is formed.

The molecules I, II and III of Scheme 3 can be obtained, depending on the molarities of the reactants<sup>176</sup> or the nature of the substituent R<sup>177</sup>. When R is tert-butyl, thermolysis of the adduct from tert-butylamine and stannylene leads to a mixture of I and II; these compounds can be isolated in the molarities indicated in Scheme 3. In the case  $\text{R} = \text{tert-butyl}$ , compound III is not formed directly. It can however be synthesized by thermolysis of I or II at elevated temperatures. On the other hand, if R is dimethylamino, the reaction leads directly to compound III without formation of I or II<sup>177</sup>.

The structures of I, II and III, derived from different spectra and X-ray diffraction data<sup>32, 40, 175-177</sup>, are illustrated in Fig. 18. I has already been described before; II and III represent a seconorcubane-like and a cubane-like molecule, respectively. In II four nitrogen atoms form a tetrahedron, which is centered on three faces by tin atoms<sup>40</sup>; in III two nitrogen and tin tetrahedra interpenetrate resulting in an  $\text{Sn}_4\text{N}_4$ -cube which is highly deformed (angles at tin  $\approx 80^\circ$ , at nitrogen  $\approx 100^\circ$ ).

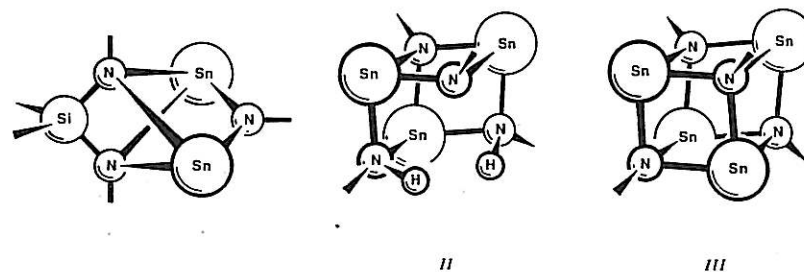
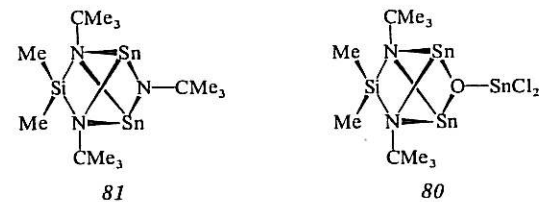
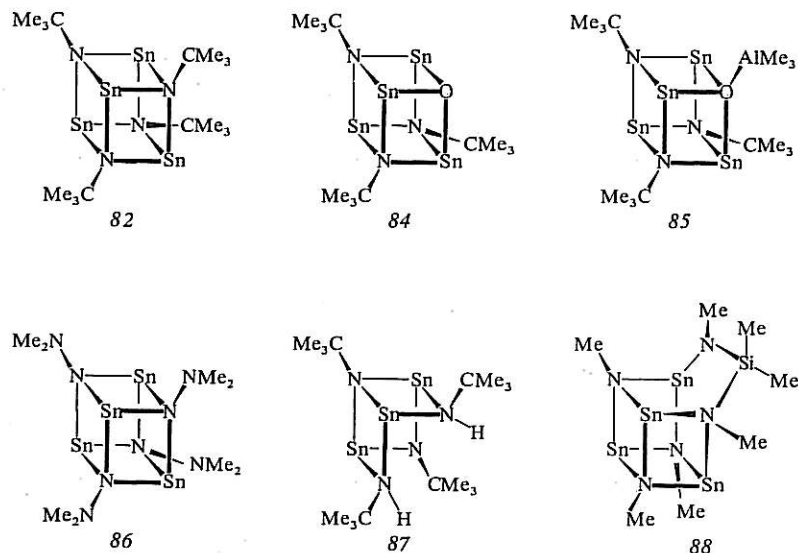

Fig. 18. Comparison between the different structures of  $\text{Me}_2\text{Si}(\text{NCMe}_3)_2\text{Sn}_2\text{NCMe}_3$  (81),  $(\text{Me}_3\text{CN})_4\text{Sn}_3\text{H}_2$  (87) and  $(\text{Me}_3\text{CN})_4\text{Sn}_4$  (82), resp. I, II and III of Scheme 3<sup>10</sup>

The following compilation of cage compounds, which can be derived from I, II or III, illustrates the various possibilities (formal charges have been omitted!):







To illustrate the high molecular symmetry of these compounds, the molecular structure of cage **85**<sup>178)</sup> is depicted in Fig. 19<sup>32)</sup>. The skeleton of **88** can be derived from an  $\text{Sn}_4\text{N}_4$  cube enlarged at one edge by the sequence  $\text{Si}-\text{N}$ ; the analog in hydrocarbon chemistry is the so-called "basketane". For further discussions of the synthesis and the structural and physical properties of these compounds the reader is referred to a review article published recently<sup>10)</sup>.

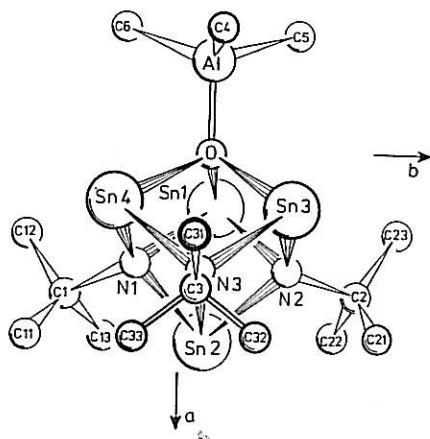
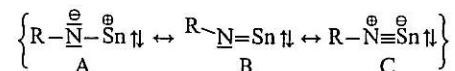

Fig. 19. Crystal structure of  $(\text{Me}_3\text{CN})_3\text{-}(\text{Me}_3\text{AlO})\text{Sn}_4$  (**85**). Reprinted with permission from *Z. Naturforsch.* 36b, 147 (1981). Copyright by Verlag Zeitschr. für Naturforsch.

We want to focus on two questions: what is the general principle for the formation of these cages and — closely related to this — how can the nature of the bonding be characterized? In contrast to isocyanides



which are stabilized by multiple bonds between the nitrogen and carbon atom, the corresponding tin compounds do not contain  $\pi$ -bonds (in accordance with the fact that tin is a very poor  $\pi$ -acceptor). As demonstrated by reaction (49),  $\text{RNSn}$  can be understood as an intermediate which may exist in several mesomeric forms:



There is however no evidence for the existence of monomeric  $\text{RNSn}$ ; it is either rapidly converted to a tetramer or coordinated with other functional groups (Scheme 3).

The bonding in the tetramer can be explained by two different approaches leading to the same result:

1) Taking the mesomeric form A we can combine 4 of these units in a way very similar to tetrameric thallium methoxide (omitting the formal charges)<sup>32)</sup>.

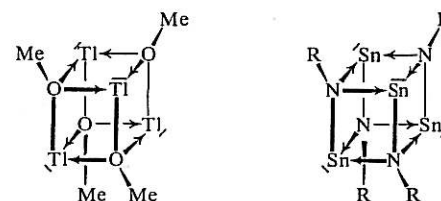

Each arrow represents a lone electron pair. These two compounds are isoelectronic with respect to their outer electron number;

2) Alternatively, in a similar way, two identical formally uncharged, four-membered rings result by combination of only two  $\text{RNSn}$  units (diazadistannylenes).

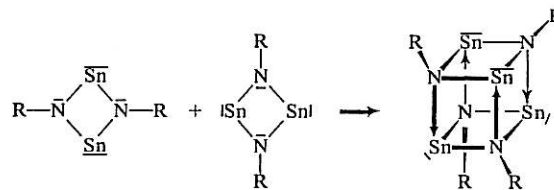

If these rings are superimposed in the correct alignment, a cube is formed due to four Lewis acid-base interactions.

The result of these approaches, which may be regarded as merely formal, is a very stable molecule, the tin atom disposing of eight electrons in the outer shell (rare-gas configuration). In contrast to the carbon atom in isocyanides, the tin atom only uses  $\sigma$ -bonds in these iminostannylenes (better: iminostannylines). The 12 Sn—N bonds within the cage are identical, as revealed by X-ray structural analysis<sup>32, 177</sup>: the Sn—N bonds thus equilibrate and no difference can be found between either a homeopolar single bond or a two electron donor bond. Following the second approach, we should expect for the Sn—N bond in the cubane-like cage 66% of a single N—Sn(II) bond and 33% of a dative bond character. Taking into account independent structures of tin(II) compounds, which are in accord with these characteristics (Chapter 3 and 4), we calculate a value of 220 pm as compared with 222 pm found. The bond angles at tin with 80.5° are also in good agreement with a threefold coordinated, pyramidal tin atom (Table 7).

To sum up, the geometry of the cages can well be understood on the basis of structural tin(II) chemistry and the nature of the bonding can be inferred from very simple approaches. The syntheses of the cages again demonstrate the various reaction possibilities of stannylenes.

## 6.6 Interaction of Stannylenes with Light

Stable stannylenes are usually colored, absorbing at the beginning of the visible region of the UV spectrum ( $\lambda \approx 400\text{--}490$  nm,  $\epsilon \approx 500\text{--}1000$ )<sup>108, 109</sup>. When cooled down, the color of the compound often disappears. In the case of the cyclic diazastannylene *1* this effect can be attributed to a change of the molecular structure: the monomeric molecule becomes dimeric, changing from coordination number 2 to 3 at the tin atom by intermolecular aggregation when the melt passes to the solid (Sect. 4.2). J. J. Zuckerman and P. J. Corvan have studied several SnX<sub>2</sub> compounds and found the following dependence: colored derivatives are always monomeric while colorless derivatives are associated<sup>114</sup>. It should be concluded that the color of the stannylenes depends on the coordination number at tin (in addition, it has not yet been clarified which electronic excitation is responsible for this absorption). However, this conclusion should be made with caution! This may be exemplified by (SnN<sub>2</sub>Me<sub>2</sub>)<sub>4</sub>. Since it has a cubane-type structure, as described in the preceding chapter, it exhibits a pyramidal threefold coordination around the tin atom (X-ray structure<sup>177</sup>), forming dark red crystals (tin-tin interactions in the crystal or electron pairs in  $\alpha$ -position to the tin atom might be responsible for the color).

Besides these electronic phenomena, chemical reactions can be induced when stannylenes interact with light. M. F. Lappert et al. have described that certain stable stannylenes form radicals when irradiated<sup>179, 180</sup>.

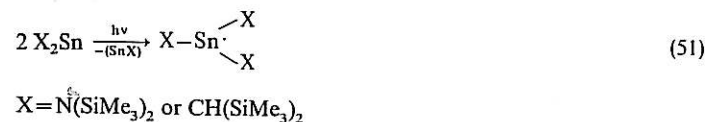

The stability of these radicals,  $\cdot\text{SnX}_3$ , at ambient temperatures is very astonishing:  $t^{1/2} = 3$  months for the aza-substituted and  $t^{1/2} = 1$  year for the carba-substituted compound have been reported<sup>179</sup>. This high half-life of the radicals has been attributed to the presence of bulky substituents. According to ESR spectral data the geometry of the radicals is believed to be pyramidal ( $\text{X} = \text{N}(\text{SiMe}_3)_2$ ) or nearly planar ( $\text{X} = \text{CH}(\text{SiMe}_3)_2$ )<sup>180</sup>. As a matter of fact these radicals represent stable compounds with tin in the oxidation state +3.

A variety of other Sn(III) radicals are known, bearing mostly organic substituents; however, they all have a very short half-life and decompose rapidly<sup>181, 182</sup>. Reaction (51) may be regarded as a disproportionation of tin(II) and tin(I) radicals should be expected to occur in the reaction mixture (Eq. (52)).



Evidence for these species has not yet been reported. In an experiment similar to reaction (51) dicyclopentadienyltin has been irradiated, and the reaction is believed to proceed according to Eq. (53)<sup>183</sup>.

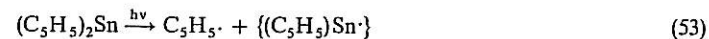

The cyclopentadienyl radical is well established by ESR spectroscopy while the fate of the Sn(I) radical is uncertain<sup>183</sup>. It should nevertheless be noted that no Sn(III) radical is formed, proving again the difference between cyclopentadienylstannylenes and other molecular tin(II) compounds.

## 7 References

1. Neumann, W. P.: Die Organische Chemie des Zinns, F. Enke, Stuttgart, 1967
2. Nefedov, O. M., Manakov, M. N.: Angew. Chem. 78, 1039 (1966); Int. Ed. 5, 1021 (1966)
3. Donaldson, J. D.: Progr. Inorgan. Chem., Vol. 8, p. 287, Interscience, J. Wiley, New York, 1967
4. Harrison, P. G.: Coord. Chem. Rev. 20, 1 (1976)
5. Zubieta, J. A., Zuckerman, J. J.: Progr. Inorgan. Chem., Vol. 24, p. 251, Interscience, J. Wiley, New York, 1978
6. Cusack, P. A. et al.: Int. Tin Res. Inst., Publication No. 588 (1981)
7. Neumann, W. P., in: The Organometallic and Coordination Chemistry of Ge, Sn and Pb (M. Gielen and P. G. Harrison, (ed.), p. 51 Freund, Teil Aviv, 1978
8. Connolly, J. W., Hoff, C.: Adv. Organomet. Chem. 19, 123 (1981)
9. Nefedov, O. M., Kolesnikov, S. P., Ioffe, A. I.: J. Organomet. Chem. Library 5, 181 (1977)
10. Veith, M.: J. Organomet. Chem. Library 12, 319 (1981)
11. Huheey, J. E.: Inorganic Chemistry: Principles of Structure and Reactivity, p. 620–22, Harper & Row, New York, 1972
12. Drago, R. S.: J. Phys. Chem. 62, 353 (1958)

13. Kirmse, W.: Carbene Chemistry, 2nd Edit., Academic Press, New York 1971
14. Gillespie, R. J.: Molecular Geometry, Van Nostrand Reinhold, New York, 1972
15. Orgel, L. E.: J. Chem. Soc. 1959, 3815
16. Tricker, M. J., Donaldson, J. D.: Inorg. Chim. Acta 31, L445 (1978)
17. Margrave, J. L., Sharp, K. G., Wilson, P. W.: Fortschr. Chem. Forsch., Top. Current Chem. Vol. 26, p. 1, Springer, Heidelberg, Berlin, 1972
18. Timms, P. L.: Acc. Chem. Res. 6, 118 (1973)
19. Wyckoff, R. W. G.: Crystal Structures, 2. Ed., Vol. 1, p. 90, J. Wiley, New York, 1963
20. Rundle, R. E., Olsen, D. H.: Inorg. Chem. 3, 596 (1964)
21. Goldberg, D. E. et al.: J. Chem. Soc., Chem. Commun. 1976, 261
22. Lister, M. W., Sutton, L. E.: Trans. Faraday Soc. 37, 406 (1941)
23. Akshin, P. A., Spiridonov, V. P., Khodshenko, A. N.: Zh. Fiz. Khim. 32, 1679 (1958)
24. Fujii, H., Kimura, M.: Bull. Chem. Soc. Japan 43, 1933 (1970)
25. Livingstone, R. L., Rao, C. N. R.: J. Chem. Phys. 30, 339 (1959)
26. Lister, M. W., Sutton, L. E.: Trans. Faraday Soc. 37, 393 (1941)
27. Veith, M.: Z. Naturforsch. 33b, 7 (1978)
28. Cetinkaya, B. et al.: J. Amer. Chem. Soc. 102, 2088 (1980)
29. Jutzi, P. et al.: Chem. Ber. 113, 757 (1980)
30. Cotton, J. D. et al.: J. Chem. Soc., Chem. Commun. 1974, 893
31. Bergerhoff, G., Goost, I.: Acta Cryst. B34, 699 (1978)
32. Veith, M., Recktenwald, O.: Z. Naturforsch. 36b, 144 (1981)
33. Brice, M. D., Cotton, F. A.: J. Amer. Chem. Soc. 95, 4529 (1973)
34. Olson, D. H., Rundle, R. E.: Inorg. Chem. 2, 1310 (1963)
35. Friedel, M. K. et al.: J. Chem. Soc., Chem. Commun. 1970, 400
36. Jeitschko, W., Sleight, A. W.: Acta Cryst. B30, 2088 (1974)
37. Ewings, P. F. R., Harrison, P. G., King, T. J.: J. Chem. Soc., Dalton Trans. 1975, 1455
38. Lappert, M. F. et al.: J. Chem. Soc., Chem. Commun. 1979, 369
39. Fußstetter, H., Nöth, H.: Chem. Ber. 112, 3672 (1979)
40. Veith, M.: Z. Naturforsch. 35b, 20 (1980)
41. Davies, C. G. et al.: J. Chem. Soc., Dalton Trans. 1975, 2241
42. Dewan, J. C. et al.: J. Chem. Soc., Dalton Trans. 1977, 2319
43. Jordan, T. H. et al.: Inorg. Chem. 15, 1810 (1976)
44. Mathew, M., Schroeder, L. W., Jordan, T. H.: Acta Cryst. B33, 1812 (1977)
45. Berndt, A. F.: Acta Cryst. B30, 529 (1974)
46. Goreaud, M., Labbé, P., Raveau, B.: Acta Cryst. B36, 15 (1980)
47. McDonald, R. C., Eriks, K.: Inorg. Chem. 19, 1237 (1980)
48. Clark, S. J. et al.: Acta Cryst. B35, 2550 (1979)
49. Uchida, T., Kozawa, K., Obara, H.: Acta Cryst. B33, 3227 (1977)
50. Harrison, P. G., Haylett, B. J., King, T. J.: J. Chem. Soc., Chem. Commun. 1978, 112
51. Christie, A. D., Howie, R. A., Moser, W.: Inorg. Chim. Acta 36, L447 (1979)
52. Harrison, P. G., Thornton, E. W.: J. Chem. Soc., Dalton Trans. 1978, 1274
53. Ewings, P. F. R. et al.: J. Chem. Soc., Dalton Trans. 1976, 1602
54. Jeitschko, W., Sleight, A. W.: Acta Cryst. B28, 3174 (1972)
55. van Remoortere, F. P. et al.: Inorg. Chem. 10, 1511 (1971)
56. Herak, R. et al.: J. Chem. Soc., Dalton Trans. 1978, 566
57. Berndt, A. F., Lamberg, R.: Acta Cryst. B27, 1092 (1971)
58. Donaldson, J. D., Puxley, D. C.: Acta Cryst. B28, 864 (1972)
59. Hauge, R. H., Hastie, J. W., Margrave, J. L.: J. Mol. Spectroscop. 45, 420 (1973)
60. McDonald, R. C., Ho-Kuen Hau, H., Eriks, K.: Inorg. Chem. 15, 762 (1976)
61. Donaldson, J. D., Laughlin, D. R., Puxley, D. C.: J. Chem. Soc., Dalton Trans. 1977, 865
62. Vilminot, S., Granier, W., Cot, L.: Acta Cryst. B34, 35 (1978)
63. Bergerhoff, G., Goost, L., Schultze-Rhonhof, E.: Acta Cryst. B24, 803 (1968)
64. Bergerhoff, G., Goost, L.: Acta Cryst. B26, 19 (1970)
65. Geneys, C., Vilminot, S.: Rev. Chim. Miner. 14, 395 (1977)
66. McDonald, R. R., Larson, A. C., Cromer, D. T.: Acta Cryst. 17, 1104 (1964)
67. Denes, G. et al.: J. Solid State Chem. 30, 335 (1979)
68. Iglesias, J. E., Steinfink, H.: Acta Cryst. B29, 1480 (1973)
69. Mootz, D., Puhl, H.: Acta Cryst. 23, 471 (1967)
70. Potenza, J., Mastropaola, D.: Acta Cryst. B29, 1830 (1973)
71. Hoskins, B. F., Martin, R. L., Rohde, N. M.: Austral. J. Chem. 29, 213 (1976)
72. Ewings, P. F. R., Harrison, P. G., King, T. J.: J. Chem. Soc., Dalton Trans. 1976, 1399
73. Lefferts, J. L. et al.: J. Am. Chem. Soc., in press
74. Lefferts, J. L. et al.: Angew. Chem. 92, 326 (1980); Int. Ed. Engl. 19, 309 (1980)
75. Dittman, G., Schäfer, H.: Z. Naturforsch. 29b, 312 (1974)
76. Jumas, J. C. et al.: Rev. Chim. Miner. 16, 48 (1979)
77. Rodesiler, P. F., Auel, T., Amma, E. L.: J. Amer. Chem. Soc. 97, 7405 (1975)
78. Weininger, M. S., Rodesiler, P. F., Amma, E. L.: Inorg. Chem. 18, 751 (1979)
79. Braun, R. M., Hoppe, R.: Angew. Chem. 90, 475 (1978); Int. Ed. Engl. 17, 449 (1978)
80. Grugel, C., Neumann, W. P., Seifert, P.: Tetrahedron Lett. 1977, 2205; Kozima, S., Kobayashi, K., Kawanisi, M.: Bull. Chem. Soc. Japan 49, 2837 (1976)
81. Grugel, C., Neumann, W. P., Schriewer, M.: Angew. Chem. 91, 577 (1979); Int. Ed. 18, 543 (1979)
82. Fischer, E. O., Gruber, H.: Z. Naturforsch. 11, 423 (1956)
83. Jutzi, P., Kohl, F.: J. Organomet. Chem. 164, 141 (1979)
84. Davidson, P. J., Lappert, M. F.: J. Chem. Soc., Chem. Commun. 1973, 317
85. Corvan, P. J., Zuckerman, J. J.: Gov. Rep. Announce. Index (U.S.) 19, 89 (1979)
86. Harris, D. H., Lappert, M. F.: J. Chem. Soc., Chem. Commun. 1974, 895
87. Schaeffer, Jr., C. D., Zuckerman, J. J.: J. Amer. Chem. Soc. 96, 7160 (1974)
88. Veith, M.: Angew. Chem. 87, 287 (1975); Int. Ed. Engl. 14, 263 (1975)
89. Lappert, M. F. et al.: J. Chem. Soc., Chem. Commun. 1980, 621
90. Du Mont, W. W., Kroth, H. J.: Angew. Chem. 89, 832 (1977); Int. Ed. Engl. 16, 792 (1977)
91. Ewings, P. F. R., Harrison, P. G.: J. Chem. Soc., Dalton Trans. 1975, 2015
92. Du Mont, W. W.: Inorg. Chim. Acta 29, L195 (1978)
93. Harrison, P. G., Zuckerman, J. J.: J. Amer. Chem. Soc. 91, 6885 (1969)
94. Bos, K. D., Bulten, E. J., Noltes, J. G.: J. Organomet. Chem. 39, C52 (1972)
95. Ewings, P. F. R., Harrison, P. G., Fenton, D. E.: J. Chem. Soc., Dalton Trans. 1975, 821
96. Cornwell, A. B., Harrison, P. G.: J. Chem. Soc., Dalton Trans. 1975, 1722
97. Bos, K. D. et al.: Inorg. Nucl. Chem. Letters 9, 961 (1973)
98. Ewings, P. F. R., Harrison, P. G.: J. Chem. Soc., Dalton Trans. 1975, 1717
99. Zeldin, M., Gsell, R.: Synth. React. Inorg. Metal-Org. Chem. 6, 11 (1976)
100. Honnick, W. D., Zuckerman, J. J.: Inorg. Chem. 17, 501 (1978)
101. Veith, M., Grosser, M., Recktenwald, O.: J. Organomet. Chem. 216, 27 (1981)
102. Honnick, W. D., Zuckerman, J. J.: Inorg. Chem. 18, 1437 (1979)
103. Petz, W., Jonas, A.: J. Organomet. Chem. 120, 423 (1976)
104. Dave, L. D., Evans, D. F., Wilkinson, G.: J. Chem. Soc. 1959, 3684
105. Harrison, P. G., Healy, M. A.: J. Organomet. Chem. 51, 153 (1973)
106. Almenningen, A., Haaland, A., Motzfeldt, T.: J. Organomet. Chem. 7, 97 (1967)
107. Bos, K. D. et al.: J. Organomet. Chem. 99, 71 (1975)
108. Davidson, P. J., Harris, D. H., Lappert, M. F.: J. Chem. Soc., Dalton Trans. 1976, 2268
109. Gynane, M. J. S. et al.: J. Chem. Soc., Dalton Trans. 1977, 2004
110. Foley, P., Zeldin, M.: Inorg. Chem. 14, 2264 (1975)
111. Du Mont, W. W., Neudert, B.: Z. anorg. allg. Chem. 436, 270 (1977)
112. Veith, M.: Z. Naturforsch. 33b, 1 (1978)
113. Hänssgen, D., Kuna, J., Ross, B.: Chem. Ber. 109, 1797 (1976)
114. Corvan, P. J., Zuckerman, J. J.: Inorg. Chim. Acta 34, L255 (1979)
115. Amberger, E., Kula, M. R.: Chem. Ber. 96, 2562 (1963)
116. Morrison, J. S., Haendler, H. M.: J. Inorg. Nucl. Chem. 29, 393 (1967)
117. Tzschach, A.: J. Organomet. Libr. 12, 293 (1981); 3. Int. Symp. Org.-Met. Coord. Chem. of Ge, Sn and Pb, Dortmund 1980
118. Cotton, J. D. et al.: J. Chem. Soc., Dalton Trans. 1976, 2286
119. Cocks, G. T., Zuckerman, J. J.: Inorg. Chem. 4, 592 (1965)
120. Hall, W. T., Zuckerman, J. J.: Inorg. Chem. 16, 1239 (1977)
121. Cornwell, A. B., Cornwell, C. A., Harrison, P. G.: J. Chem. Soc., Dalton Trans. 1976, 1612
122. Du Mont, W. W., Lefferts, J. L., Zuckerman, J. J.: J. Organomet. Chem. 166, 347 (1979)

123. Cusack, P. A., Smith, P. J., Donaldson, J. D.: *Inorg. Chim. Acta, Bioinorg. Chem.* **46**, L73 (1980)
124. Veith, M., Lange, H.: unpublished
125. Harris, D. H. et al.: *J. Chem. Soc., Dalton Trans.* **1976**, 945
126. Gmelin: *Handbuch der Anorganischen Chemie*, Zinn, Part C5, p. 3-62, Springer: Berlin, Heidelberg, 1977
127. Deans, R. A., Geanangel, R. A.: *Inorg. Chim. Acta* **43**, 159 (1980)
128. Jaura, K. L., Singh, B., Chadka, R. K.: *Indian J. Chem.* **12**, 1304 (1974)
129. Kauffman, J. W., Moor, D. H., Williams, R. J.: *J. Inorg. Nucl. Chem.* **39**, 1165 (1977)
130. Du Mont, W. W. et al.: *Angew. Chem.* **88**, 303 (1976); *Int. Ed.* **15**, 308 (1976)
131. Du Mont, W. W., Neudert, B.: *Z. anorg. allg. Chem.* **441**, 86 (1978)
132. Hsu, C. C., Geanangel, R. A.: *Inorg. Chem.* **16**, 2529 (1977)
133. Cotton, J. D., Davidson, P. J., Lappert, M. F.: *J. Chem. Soc., Dalton Trans.* **1976**, 2275
134. Veith, M.: unpublished
135. Du Mont, W. W.: *J. Organomet. Chem.* **153**, C11 (1978)
136. Harrison, P. G., Zuckerman, J. J.: *J. Amer. Chem. Soc.* **92**, 2577 (1970)
137. Doe, J., Borkett, S., Harrison, P. G.: *J. Organomet. Chem.* **52**, 343 (1973)
138. Harrison, P. G., Richards, J. A.: *J. Organomet. Chem.* **108**, 35 (1976)
139. Hsu, C. C., Geanangel, R. A.: *Inorg. Chim. Acta* **34**, 241 (1979)
140. Hsu, C. C., Geanangel, R. A.: *Inorg. Chem.* **19**, 110 (1980)
141. Fischer, E. O.: *Adv. Organomet. Chem.* **14**, 1 (1976)
142. Lappert, M. F., Power, P. P.: *Adv. Chem. Ser.* **157**, 70 (1976)
143. Cornwell, A. B., Harrison, P. G., Richards, J. A.: *J. Organomet. Chem.* **108**, 47 (1976)
144. Petz, W.: *J. Organomet. Chem.* **165**, 199 (1979)
145. Veith, M. et al.: *J. Organomet. Chem.* **216**, 377 (1981)
146. Marks, T. J.: *J. Amer. Chem. Soc.* **93**, 7090 (1971)
147. Marks, T. J., Newman, A. R.: *J. Amer. Chem. Soc.* **95**, 769 (1973)
148. Uhlig, D., Behrens, H., Lindner, E.: *Z. anorg. allg. Chem.* **401**, 233 (1973)
149. Cornwell, A. B., Harrison, P. G.: *J. Chem. Soc., Dalton Trans.* **1975**, 1486
150. Du Mont, W. W., Neudert, B.: *Chem. Ber.* **111**, 2267 (1978)
151. Wells, A. F.: *Structural Inorganic Chemistry*, 4. Ed., Clarendon Press, Oxford 1975
152. Schröder, U., Albert, H. J., Neumann, W. P.: *J. Organomet. Chem.* **102**, 291 (1975)
153. Messin, G., Janier-Dubry, J. L.: *Inorg. Nucl. Chem. Lett.* **15**, 409 (1979)
154. Bos, K. D., Bulten, E. J., Noltes, J. G.: *J. Organomet. Chem.* **67**, C13 (1974)
155. Veith, M., Recktenwald, O., Humpfer, E.: *Z. Naturforsch.* **33b**, 14 (1978)
156. Cornwell, A. B., Harrison, P. G.: *J. Chem. Soc., Dalton Trans.* **1976**, 1608
157. Cole, B. J., Cotton, J. D., McWilliam, D.: *J. Organomet. Chem.* **64**, 223 (1974)
158. Cornwell, A. B., Harrison, P. G.: *J. Chem. Soc., Dalton Trans.* **1975**, 2017
159. Albert, H. J., Schröder, U.: *J. Organomet. Chem.* **60**, C6 (1973)
160. Bos, K. D., Bulten, E. J., Noltes, J. G.: *J. Organomet. Chem.* **99**, 397 (1975)
161. Gynane, M. J. S. et al.: *J. Chem. Soc., Chem. Commun.* **1976**, 256
162. Gynane, M. J. S. et al.: *J. Chem. Soc., Dalton Trans.* **1977**, 2009
163. Gynane, M. J. S. et al.: *J. Chem. Soc., Chem. Commun.* **1978**, 192
164. Hoff, C. D., Connolly, J. W.: *J. Organomet. Chem.* **148**, 127 (1978)
165. Bos, K. D., Bulten, E. J., Noltes, J. G.: *J. Organomet. Chem.* **92**, 33 (1975)
166. Harrison, P. G., Zuckerman, J. J., Noltes, J. G.: *J. Organomet. Chem.* **31**, C23 (1971)
167. Harrison, P. G., King, T. J., Richards, J. A.: *J. Chem. Soc., Dalton Trans.* **1975**, 2097
168. von Werner, K., Blank, H., Yasufuku, K.: *J. Organomet. Chem.* **165**, 187 (1979)
169. Meier, P. F. et al.: *Inorg. Chem.* **18**, 2051 (1979)
170. Veith, M., Recktenwald, O.: *Z. anorg. allg. Chem.* **459**, 208 (1979)
171. Honnick, W. D., Zuckerman, J. J.: *Inorg. Chem.* **15**, 3034 (1976)
172. Du Mont, W. W., Neudert, B.: *Angew. Chem.* **92**, 561 (1980); *Int. Ed.* **19**, 553 (1980)
173. Jutzi, P., Kohl, P., Krüger, C.: *Angew. Chem.* **91**, 81 (1979); *Int. Ed.* **18**, 59 (1979)
174. Kohl, F. X., Jutzi, P.: *Chem. Ber.* **114**, 488 (1981)
175. Veith, M.: *Chem. Ber.* **111**, 2536 (1978)
176. Veith, M., Sommer, M.-L., Jäger, D.: *Chem. Ber.* **112**, 2581 (1979)
177. Veith, M., Schlemmer, G.: unpublished

178. Veith, M., Lange, H.: *Angew. Chem.* **92**, 408 (1980); *Int. Ed.* **19**, 401 (1980)
179. Cotton, J. D. et al.: *J. Chem. Soc., Chem. Commun.* **1974**, 651
180. Hudson, A., Lappert, M. F., Lednor, P. W.: *J. Chem. Soc., Dalton Trans.* **1976**, 2369
181. Buschhaus, H. U., Lehnig, M., Neumann, W. P.: *J. Chem. Soc., Chem. Commun.* **1977**, 129
182. Lehnig, M., Dören, K.: *J. Organomet. Chem.* **210**, 331 (1981)
183. Davies, A. G., Tse, M. W.: *J. Chem. Soc., Chem. Commun.* **1978**, 353